

Blue Easy Reader Thermostat

Single Stage, Multi-Stage, Heat Pump
Installation and Operating Instructions for Model:

Save these instructions for future use!

FAILURE TO READ AND FOLLOW ALL INSTRUCTIONS CAREFULLY BEFORE INSTALLING OR OPERATING THIS CONTROL COULD CAUSE PERSONAL INJURY AND/OR PROPERTY DAMAGE.

Model	Programming Choices	
1F95EZ-0671	Non-Programmable	7 Day

APPLICATIONS

THERMOSTAT APPLICATION GUIDE

Thermostat Configuration Options	Thermostat Applications	Maximum Stages Heat/Cool
Single Stage 1 No Heat Pump (SS1)	Gas, Oil, Electric, Heat Only, Cool Only or Heat/Cool Systems, 2 or 3 wire Hydronic Zone (Hot Water or Steam) Systems, 24 Volt or Millivolt	1/1
Multi Stage 2 No Heat Pump (MS2)		2/2
Heat Pump 1 Single Stage Compressor Heat Pump (HP1)	Single Stage Compressor Heat Pump Systems - up to 2 Stages Aux./Emergency Heat	3/1
Heat Pump 2 Two Stage or Two Compressor Heat Pump (HP2)	Two Stage or Two Compressor Heat Pump systems - up to 2 Stages Aux./Emergency Heat	4/2

1F95EZ-0671 Thermostat



SPECIFICATIONS

Electrical Rating:

- Battery Power mV to 30 VAC, NEC Class II, 50/60 Hz or DC
- Input-Hardwire 20 to 30 VAC
- Terminal Load 1.5A per terminal, 2.5A maximum all terminals combined
- Setpoint Range 45 to 99°F (7 to 32°C)
- Differential (Single Stage) Heat 0.6°F; Cool 1.2°F
- Differential (Multi-Stage) Heat 0.6°F; Cool 1.2°F
- Differential (Heat Pump) Heat 1.2°F; Cool 1.2°F
- Operating Ambient. 32°F to +105°F (0 to +41°C)
- Operating Humidity 90% non-condensing max.
- Shipping Temperature Range -40 to +150°F (-40 to +65°C)
- Dimensions Thermostat. 4.2"H x 6.4"W x 1.7"D

CAUTION

To prevent electrical shock and/or equipment damage, disconnect electric power to system at main fuse or circuit breaker box until installation is complete.

ATTENTION: MERCURY NOTICE

This product does not contain mercury. However, this product may replace a product that contains mercury.

Mercury and products containing mercury must not be discarded in household trash. Do not touch any spilled mercury. Wearing non-absorbent gloves, clean up any spilled mercury and place in a sealed container. For proper disposal of a product containing mercury or a sealed container of spilled mercury, place it in a suitable shipping container. Refer to www.white-rodgers.com for location to send product containing mercury.

Index	Page
Installation	2
Wiring Connections	2
Wiring Diagrams	3
Thermostat Quick Reference	4
Installer Configuration Menu	5
Operating Your Thermostat	7
Troubleshooting	8

INSTALLATION

⚠ WARNING

Thermostat installation and all components of the control system shall conform to Class II circuits per the NEC code.

Remove Old Thermostat

Before removing wires from old thermostat, mark wires for terminal identification so the proper connections will be made to the new thermostat.

Installing New Thermostat

1. Pull the thermostat body off the thermostat base. Forcing or prying on the thermostat will cause damage to the unit.
2. Place base over hole in wall and mark mounting hole locations on wall using base as a template.
3. Move base out of the way. Drill mounting holes. If you are using existing mounting holes and the holes drilled are too large and do not allow you to tighten base snugly, use plastic screw anchors to secure the base.
4. Fasten base snugly to wall using mounting holes shown in Figure 1 and two mounting screws. Leveling is for appearance only and will not affect thermostat operation.
5. Connect wires to terminal block on base using appropriate wiring schematic.
6. Push excess wire into wall and plug hole with a fire resistant material (such as fiberglass insulation) to prevent drafts from affecting thermostat operation.
7. Carefully line the thermostat up with the base and snap into place.

Battery Location

2 "AA" alkaline batteries are included in the thermostat at the factory with a battery tag to prevent power drainage. Remove the battery tag to engage the batteries.

To replace batteries, set system to **OFF**, remove thermostat from wall and install the batteries in the rear along the top of the thermostat (see Figure 1). For best results, use a premium brand "AA" alkaline battery such as Duracell® or Energizer®. If the home is going to be unoccupied for an extended period (over 3 months) and  is displayed, the batteries should be replaced before leaving.

Power Stealing Switch

The Power Stealing Switches (Fig. 1) should be left in the "On" position for most systems. The information in the following table details the thermostat power method and switch options.

Thermostat Power Method	Switch Position/Description
Battery Powered , no 24 Volt system power available.	Switches "On", thermostat runs on batteries.
Hardwired with Battery Back-up , for 24 Volt systems with common connection from transformer to "C" terminal on thermostat.	Switches "On", thermostat runs on power directly from transformer with battery back-up.
*Battery Powered with Power Stealing Assist , for 24 Volt systems with no common connection from transformer to "C" terminal on thermostat.	Switches "On", thermostat runs on batteries and supplemental power drawn through the heat or cool circuit.

*Power Stealing Assist is very reliable to increase battery life, but on a small number of heating or cooling systems with high impedance electronic modules you may observe one of the following conditions:

1. The furnace draft inducer motor may run with no call for heat.
2. The furnace fan may turn on with no call for heat or may not turn off.
3. The furnace may not turn off when the call for heat ends.
4. The air conditioner may not turn off when the call for cool ends.

If the Power Stealing Assist method is not compatible with your system, place the Power Stealing Switches to "Off". This cancels Power Stealing Assist, operates the thermostat on batteries and corrects the condition.

Figure 1 – Thermostat Base Multi-Stage 1F95EZ-0671

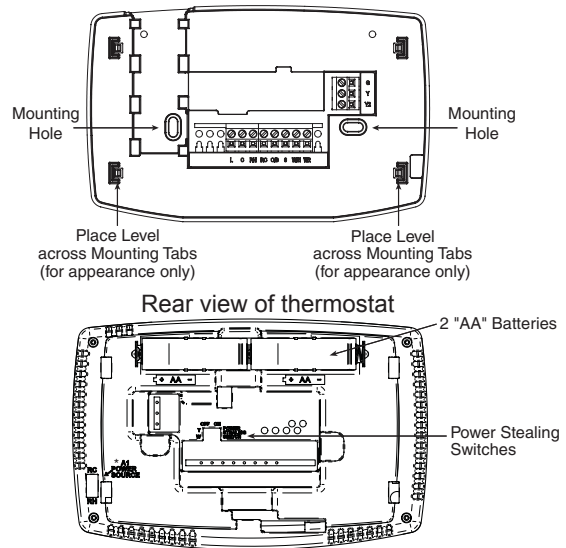

* A1 For Damper Control Not Applicable To This Model.

WIRING CONNECTIONS

Refer to equipment manufacturers' instructions for specific system wiring information. After wiring, see CONFIGURATION section for proper thermostat configuration.

Wiring diagrams shown are for typical systems and describe the thermostat terminal functions.

TERMINAL DESIGNATION DESCRIPTIONS

Terminal Designation	Description
O/B	Changeover valve for heat pump energized constantly in cooling and off/heating
Y2	2nd Stage Compressor
Y	Compressor Relay
G	Fan Relay
RC	Power for Cooling
RH	Power for Heating
C	Common wire from secondary side of cooling (Optional). Required for fault indication, continuous back-light operation or remote temperature sensor operation 6 Powered closed 3rd wire for 3-wire zone valve
W/E	Heat Relay/Auxiliary Heat Relay (Stage 1) (3rd Stage Heat in HP2)
W2	2nd Stage Heat (4th Stage Heat in HP2)
L	Compressor diagnostic indicator for systems with diagnostic connection typically found on Heat pump systems or with Copeland's Comfort Alert

WIRING DIAGRAMS

Figure 2 – Single Stage or Multi-Stage System (No Heat Pump) with Single Transformer

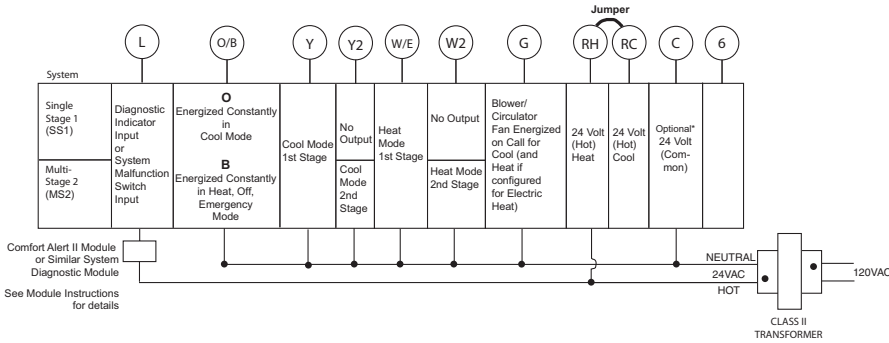

* Common connection required for diagnostic or malfunction indication.

Figure 3 – Single Stage or Multi-Stage System (No Heat Pump) with Two Transformers

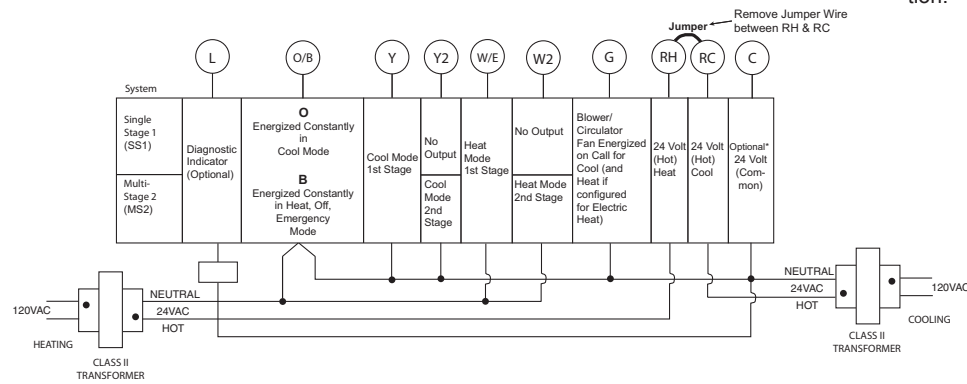

* Common connection required for diagnostic or malfunction indication.

Figure 4 – Heat Pump Systems

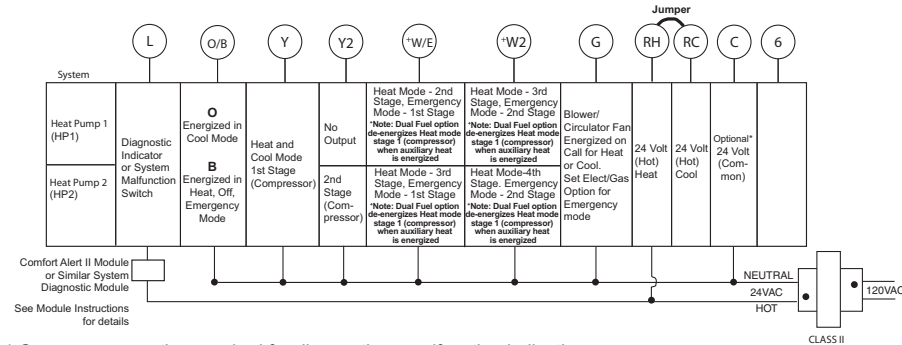

* Common connection required for diagnostic or malfunction indication.

* Dual Fuel option, if selected turns off compressor(s) when Auxiliary stages energize.

Figure 5 – 3-Wire (SPDT) Heat Only Zone Valve Wiring

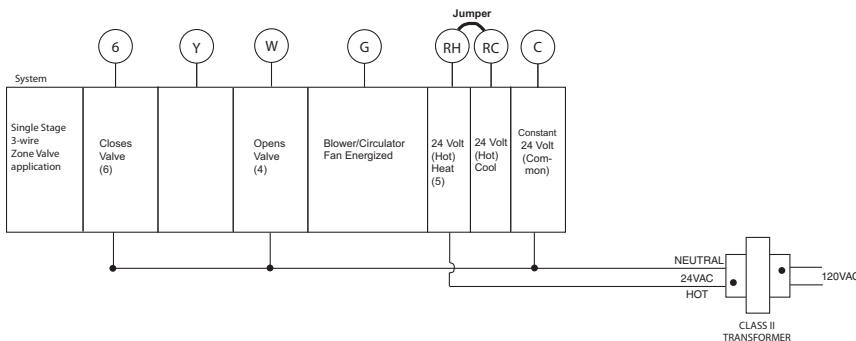

Single Stage, Multi-Stage and Heat Pump Connections

Refer to equipment manufacturers' instructions for specific system wiring information.

This thermostat is designed to operate a single-transformer or two-transformer system.

You can configure the thermostat for use with the following systems:

SINGLE STAGE (SS 1) gas, oil or electric.

MULTI-STAGE (MS 2) gas, oil or electric.

HEAT PUMP TYPE 1 (HP 1). Single stage compressor system; gas or electric backup.

HEAT PUMP TYPE 2 (HP 2). Multi-stage compressor or two compressor system with gas or electric backup.

After wiring, see **INSTALLER CONFIGURATION** section for proper thermostat configuration.

THERMOSTAT QUICK REFERENCE

Home Screen Description

Figure 6 – Home Screen Display

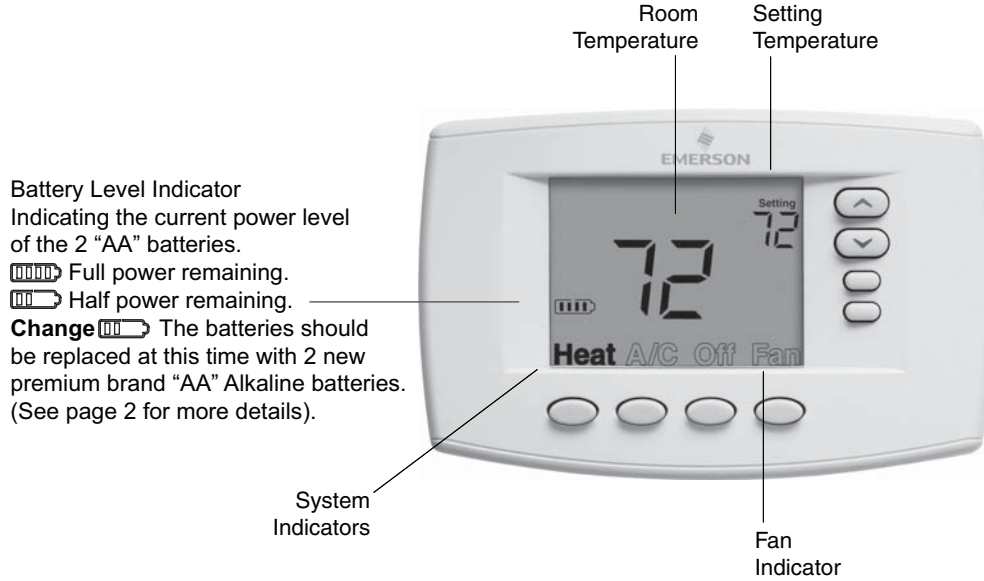
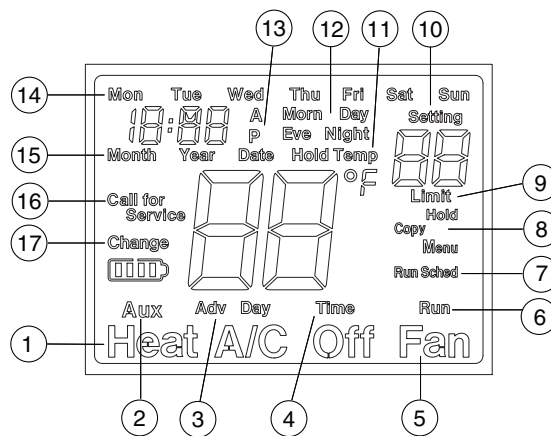

Figure 7 – Programming & Configuration Items





Programming and Configuration Items

- ① **"Heat" "A/C" "Off"** identifies button. When filled indicates system mode selected.
- ② **"Aux"** indicates thermostat configured for Heat Pump. When filled indicates Auxiliary stage is operating.
- ③ **"Adv Day"** identifies button when in schedule mode.
- ④ **"Time"** identifies button when in schedule mode.
- ⑤ **"Fan"** identifies button. When filled indicates Fan is on.
- ⑥ **"Run"** identifies button to begin normal operation.
- ⑦ **"Sched"** identifies button to be used during programming or **"Run Sched"** identifies button to return to normal operation.
- ⑧ **"Hold" "Copy" "Menu"** identifies button.
- ⑨ **"Limit"** indicates temperature is adjusted to the limit set in the configuration menu.
- ⑩ **"Setting"** indicates the setpoint temperature.
- ⑪ **"Hold Temp"** indicates temporary hold or **"Hold"** indicates hold mode.
- ⑫ **"Morn" "Day" "Eve" "Night"** indicates period being programmed or current program in Run mode.
- ⑬ **"A" "P"** indicates time as Morning (A) or Evening (P).
- ⑭ **"Mon - Sun"** indicates day of week.
- ⑮ **"Month" "Year" "Date"** indicates the Month Year or Date when setting time.
- ⑯ **"Call For Service"** indicates a diagnostic fault in the heating/cooling system. It does not indicate a fault in the thermostat.
- ⑰ **"Change"** indicates when batteries are low and should be replaced.

INSTALLER/CONFIGURATION MENU



With Heat or A/C selected, press and hold the Menu button for at least 5 seconds. The display will show item #1 in the table below. Press Menu to advance to the next menu item. Press  or  to change a menu item options.

INSTALLER/CONFIGURATION MENU						
Menu Ref.	HP	SS	Press Button	Displayed (Factory Default)	Press  or  to select from listed options	Comments
1	1	1	MENU	(MS 2)	HP 1, HP 2, SS 1	Selects Multi-Stage (MS 2 No Heat Pump), Heat Pump 1 (HP 1, 1 compressor), Heat Pump 2 (HP 2, 2 compressor or 2 speed compressor), or Single Stage (SS 1)
2	2	2	MENU	(GAS) for SS or MS	ELE	GAS setting: furnace controls the blower ELE setting: thermostat controls the blower
3	3	3	MENU	E (On)	OFF	Selects Energy Management Recovery (EMR) On or OFF. (Not available in -non-programmable mode)
4	-	4	MENU	CR Heat (ME)	SL, FA	Selects Adjustable Anticipation, cycle rate, Heat (This item only appears when MS 2 or SS 1 is selected above)
5	4	-	MENU	CR Heat A/C (ME)	SL, FA	Selects Adjustable Compressor Anticipation (Heat Pump) This item only appears when HP 1, HP 2 is selected above
6	5	5	MENU	CR A/C (ME) or CR Aux Heat (FA)	SL, FA SL	Selects Adjustable Anticipation, cycle rate, cool (when MS 2 or SS 1 is selected above.) or Selects the cycle rate for Auxiliary stage (when HP 1 or HP 2 is selected above)
7	6	6	MENU	CL (OFF)	CL On	Compressor Lockout Time
8	7	7	MENU	Heat A/C Off or Aux Heat A/C Off	Heat A/C Off, Heat Off with Fan icon, Heat Off without Fan icon A/C Off	System Mode Configuration with Automatic Changeover capability
9	8	8	MENU	CO (OFF)	CO On	Selects Compressor Optimization
10	9	9	MENU	dL (On)	dL OFF	Selects Display Light On or OFF
11	10	10	MENU	0 HI (current temperature)	1 HI, 2 HI, 3HI, 4 HI, 1 LO, 2 LO, 3 LO, 4 LO	Adjustable Ambient Temperature Display
12	11	11	MENU	°F	°C	Selects Fahrenheit/Celsius Temperature Display
13	12	12	MENU	P (0)	7	Defaults to P (0) non-programmable P (7) is 7-day programming
14	13	13	MENU	PS (2)	4	Selects Program periods per day: 4 = Morn, Day, Eve, Night 2 = Day, Night
15	14	-	MENU	Heat FA (On)	OFF	Fast Heat option may be disabled by selecting OFF. NA to SS or HP1 config.
16	15	14	MENU	A/C FA (On)	OFF	Fast Cool option may be disabled by selecting OFF. NA to SS or HP1 config.
17	16	15	MENU	dS (On)	Off	Selects Automatic Daylight Saving Time option
18	17	16	MENU	HL Heat (99)	62 to 98	Select's Limited HEAT Range
19	18	17	MENU	LL A/C (45)	46 to 82	Select's Limited A/C Range
20	19	-	MENU	dF (0)	1 to 9	Selects dF (dual Fuel) setting. 0 is Off (If dual Fuel option is required, a selection of 5 is recommended)
			MENU	Cd (60)	0 to 99	Selects compressor delay in seconds when dF is greater than 0
21	20	18	MENU	A/C On (o)	Heat On (b)	Selects operation of the reversing valve terminal (O/B) output as an O or B terminal

INSTALLER/CONFIGURATION MENU

- 1) This control can be configured for:
 - MS 2 – Multi-Stage System (no heat pump)
 - HP 1 – Heat Pump with one stage of compressor
 - HP 2 – Heat Pump with two stage compressor or two compressor system, Gas or Electric backup
 - SS 1 – Single Stage System
- 2) **GAS or Electric (ELE)** fan operation. If the heating system requires the thermostat to energize the fan, select ELE. Select GAS if the heating system energizes the fan on a call for heat.
- 3) **Energy Management Recovery:** (this step is skipped if configured to be non-programmable).

Energy Management Recovery (E) On enables the thermostat to start heating or cooling early to make the building temperature reach the program setpoint at the time you specify. Heating will start 5 minutes early for every 1° of temperature required to reach setpoint.









Example: E On is selected and your heating is programmed to 65° at night and 70° at 7 AM. If the building temperature is 65°, the difference between 65° and 70° is 5°. Allowing 5 minutes per degree, the thermostat setpoint will change to 70° at 6:35 AM. Cooling allows more time per degree, because it takes longer to reach set temperature.
- 4, 5 & 6) **Cycle Rate Selection** – The factory default setting for Heat and Cool modes, SS1, MS2, is medium cycle (ME). For Heat Pump, HP1, HP2, the default setting is medium (ME). For Aux the default setting is fast cycle (FA). To change cycle rate, press the  or  button.



Cycle rate differentials for different settings are:

MODE	Fast FA	Medium ME	Slow SL
Heat (SS1, MS2)	0.4°F	0.6°F	1.7°F
Cool (SS1, MS2)	0.9°F	1.2°F	1.7°F
Heat Pump (HP1, HP2)	0.9°F	1.2°F	1.7°F
AUX (HP1, HP2)	0.6°F	-	1.7°F

- 7) **Select Compressor Lockout CL OFF or ON** – Selecting CL ON will cause the thermostat to wait 5 minutes between cooling cycles. This is intended to help protect the compressor from short cycling. Some newer compressors already have a time delay built in and do not require this feature. Your compressor manufacturer can tell you if the lockout feature is already present in their system. When the thermostat compressor time delay occurs, it will flash the setpoint for up to five minutes.
- 8) **System Mode Configuration** – This thermostat is configured for Heat and Cool (SYSTEM switch with Cool Off Heat) default. It can also be configured for Heat and Cool (Heat, Cool, Off), Heat only with fan (Off Heat), Heat only without fan, and Cool only (Cool Off).
- 9) **Compressor Optimization** – CO provides a delay in circulator fan operation after the compressor turns on or off. With CO selected ON, when the compressor turns on (for a call for heat in heat pump or a call for cool) the fan will be delayed for five seconds before turning on to allow the air to be heated or cooled. After the compressor turns off for call for cool, the fan will continue to run for 20 seconds to circulate all of the cooled air. If CO is set to OFF, there will be no delay in fan operation.
- 10) **Select Backlight Display** – The display backlight improves display contrast in low lighting conditions. When the "C" terminal is powered, selecting backlight dL ON will keep the light on continuously. Select backlight OFF will turn the light on momentarily after any button is pressed. When the "C"

terminal is not powered, the light will be on momentarily after any button is pressed no matter whether the backlight is selected ON or OFF.

- 11) **Select Temperature Display Adjustment 4 LO to 4 HI** – Allows you to adjust the room temperature display up to 4° higher or lower. Your thermostat was accurately calibrated at the factory, but you have the option to change the display temperature to match your previous thermostat. The current or adjusted room temperature will be displayed.
- 12) **Select F° or C° Readout** – Changes the display readout to Celsius or Fahrenheit as required.
- 13) **Program Options:** Selects configuration for 7 day (7) or non-programming (0) mode. The default setting is 0, indicating non-programming. The programs per week can be changed by pressing the  or  buttons. A selection of 0 days for non-programmable will eliminate the need for EMR, and that step in the menu will be skipped.
- 14) **Program Steps per day** – This control can be configured for 4 or 2 program steps per day. Default is "PS" and can be toggled between 4 PS and 2 PS.
- 15 & 16) **Select Fast Second Stage ON or OFF** – Heat pump or Multi-stage only, in the run mode, with the fast Heat feature enabled (FA Heat On), if the Heat setpoint temperature is manually raised by 3°F (2°C) or more above the actual temperature using  the second stage will energize immediately. With FA OFF, second stage will not energize until the setpoint temperature is 1°F or more above actual temperature for more than ten minutes. The Fast Cool feature (FA Cool) provides the same controls when the setpoint temperature is lowered.
- 17) **Select Daylight Saving Time Calculation** – This feature will allow the thermostat to calculate the DST automatically and apply it to the Real Time Clock display. Default On. Use  or  touch keys to select the feature OFF.
- 18) **Limited Heat Range** – This feature provides a maximum setpoint temperature for heat. The default setting is 99°F. It can be changed between 62°F and 98°F by pressing the  or  button.
- 19) **Limited Cool Range** – This feature provide a minimum setpoint temperature for cool. The default setting is 45°F. It can be changed between 46°F and 82°F by pressing the  or  button.
- 20) **Select Dual Fuel (dF)** – Selects dual fuel setting 0 to 9 (0 is default OFF, for Elect AUX) if your system has a fossil fuel (gas or oil) Auxiliary heat. HP1 or HP2 only.

Select Compressor Delay (Cd) – After the auxiliary heat is turned on, the compressor(s) shut down is delayed for the time selected (in seconds). This delay is factory set to 60, but can be set in the range of 0 to 99 using  or  buttons. Available only if dF 1 to 9 is selected above.
- 21) **Select Reversing Valve Output** – The O/B option is factory set at "O" position. This will accommodate the majority of heat pump applications, which require the changeover relay to be energized in COOL. If the thermostat you are replacing or the heat pump being installed with this thermostat requires a "B" terminal, to energize the changeover relay in HEAT, the O/B option should be set at "B" position.

OPERATING YOUR THERMOSTAT

Check Thermostat Operation

NOTE

To prevent static discharge problems, touch side of thermostat to release static build-up before touching any keys.

If at any time during testing your system does not operate properly, contact a qualified service person.

Fan Operation



If your system does not have a G terminal connection, skip to **Heating System**.

1. Turn on power to system.
2. Press FAN button. The display will show "Fan" and the blower should begin to operate.
3. Press FAN button again. The display will show "Fan" outlined and the blower should stop immediately.

CAUTION



Do not allow the compressor to run unless the compressor oil heaters have been operational for 6 hours and the system has not been operational for at least 5 minutes.

Heating System

1. Press the HEAT button to select **HEAT**. If the auxiliary heating system has a standing pilot, be sure to light it.
2. Press  to adjust thermostat setting to 1° above room temperature. The heat pump system should begin to operate. The display should show "Heat". However, if the system configuration is set to HP1 or HP2 and setpoint temperature display is flashing, the 5 minute compressor lockout feature is operating (see Configuration menu, item 7).
3. Adjust temperature setting to 3° above room temperature. If your system configuration is set at MS2, HP2 or HP1, the auxiliary heat system should begin to operate and the display will show "Aux" and "Heat".
4. Press  to adjust the thermostat below room temperature. The heating system should stop operating.

Auxiliary (Emergency) System



AUX bypasses the Heat Pump to use the heat source wired to terminal **W/E** on the thermostat. **AUX** is typically used when compressor operation is not desired, or you prefer back-up heat only.

1. Press and hold **HEAT** button for at least 5 seconds to select "**AUX**".
2. Press  to adjust thermostat setting above room temperature. The Auxiliary heating system will begin to operate. The display will show "AUX" and "HEAT".
3. Press  to adjust the thermostat below room temperature. The Auxiliary heating system should stop operating.
4. To return to Heat Pump mode press "HEAT" button. "Aux" will display.

CAUTION

To prevent compressor and/or property damage, if the outdoor temperature is below 50°F, DO NOT operate the cooling system.



Cooling System

1. Press A/C button to select **A/C**.
2. Press  to adjust thermostat setting below room temperature. The blower should come on immediately on high speed, followed by cold air circulation. The display should show "A/C". If the setpoint temperature display is flashing, the compressor lockout feature is operating (see Configuration menu, item 7).
3. Adjust temperature setting to 3° below room temperature. The second stage cooling should begin to operate. A click from the thermostat will be heard to confirm second stage.
4. Press  to adjust the temperature setting above room temperature. The cooling system should stop operating.

Dual Fuel Temperature Setpoint and Compressor Delay

When the thermostat is configured for Heat Pump mode and the Dual Fuel feature is selected, the thermostat can use software logic to determine when to switch to gas heat and shut down the compressor. This eliminates the need for a fossil fuel kit.

The user selectable temperature is called the dual fuel temperature setpoint (**dF**) and is set in the Installer/Configuration menu, item 20. A software logic based dual fuel number from 1 to 9 can be selected. A selection of 5 is recommended. A higher number will provide a larger stage separation. A lower number will provide a smaller separation.



After the dual fuel temperature setting is selected, press Menu. A compressor delay (**Cd**) can be set for compressor shutdown after the auxiliary stage is energized. This delay will minimize the time the system may blow cooler air until the alternate source of heat comes on. Default setting for delay is 60 seconds. This delay can be set from 0 to 99 seconds using the  or  buttons.

Compressor Delay (Cd) will not be available if dF is selected 0 (off).

TROUBLESHOOTING

Reset Operation

Note: When thermostat is reset, installer configuration menu settings and programming will reset to factory settings. If a voltage spike or static discharge blanks out the display or causes erratic thermostat operation, you can reset the thermostat by removing the wires from terminals **RH** and **RC** (do not short them together) and removing batteries for 2 minutes. After resetting the thermostat, replace the wires and batteries. If the thermostat has been reset and still does not function correctly contact your heating/cooling service person or place of purchase.

Note: Be sure to review the installer configuration menu settings. To reset the programming, clock and configuration settings, press the   and FAN button simultaneously. The thermostat should go blank and then all segments will be displayed momentarily.

Symptom	Possible Cause	Corrective Action
No Heat/No Cool/No Fan (common problems)	<ol style="list-style-type: none"> Blown fuse or tripped circuit breaker. Furnace power switch to OFF. Furnace blower compartment door or panel loose or not properly installed. Loose connection to thermostat or system. 	Replace fuse or reset breaker. Turn switch to ON. Replace door panel in proper position to engage safety interlock or door switch. Tighten connections.
No Heat	<ol style="list-style-type: none"> Pilot light not lit. Furnace Lock-Out Condition. Heat may also be intermittent. Heating system requires service or thermostat requires replacement. 	Re-light pilot. Many furnaces have safety devices that shut down when a lock-out condition occurs. If the heat works intermittently contact the furnace manufacturer or local HVAC service person for assistance. Diagnostic: Set System to HEAT and raise the setpoint above room temperature. Within a few seconds the thermostat should make a soft click sound. This sound usually indicates the thermostat is operating properly. If the thermostat does not click, try the reset operation listed above. If the thermostat does not click after being reset contact your heating and cooling service person or place of purchase for a replacement. If the thermostat clicks, contact the furnace manufacturer or a HVAC service person to verify the heating is operating correctly.
No Cool	<ol style="list-style-type: none"> Cooling system requires service or thermostat requires replacement. 	Same as diagnostic for No Heat condition except set the thermostat to COOL and lower the setpoint below the room temperature. There may be up to a five minute delay before the thermostat clicks in Cooling.
Heat, Cool or Fan Runs Constantly	<ol style="list-style-type: none"> Possible short in wiring. Possible short in thermostat. Possible short in heat/cool/fan system. FAN Switch set to Fan ON. 	Check each wire connection to verify they are not shorted or touching together. No bare wire should stick out from under terminal block. Try resetting the thermostat as described above. If the condition persists the manufacturer of your system or service person can instruct you on how to test the Heat/Cool system for correct operation. If the system operates correctly, replace the thermostat.
Thermostat Setting & Thermostat Thermometer Disagree	<ol style="list-style-type: none"> Thermostat thermometer setting requires adjustment. 	The thermometer can be adjusted +/- 4 degrees. See Temperature Display Adjustment in the Configuration Menu section.
Furnace (Air Conditioner) Cycles Too Fast or Too Slow (narrow or wide temperature swing)	<ol style="list-style-type: none"> The location of the thermostat and/or the size of the Heating System may be influencing the cycle rate. 	Digital thermostats provide precise control and cycle faster than older mechanical models. The system turns on and off more frequently but runs for a shorter time so there is no increase in energy use. If you would like an increased cycle time, choose SL for slow cycle in the Configuration menu reference, steps 4 through 6. If an acceptable cycle rate is not achieved, contact a local HVAC service person for additional suggestions.
Forgot Keypad Lockout Code		Press the menu button (button will disappear) and hold in for 20 seconds. This unlocks the thermostat.

HOMEOWNER HELP LINE: 1-800-284-2925

White-Rodgers is a division of Emerson Electric Co.

The Emerson logo is a trademark and service mark of Emerson Electric Co.

White
Rodgers[™]
www.white-rodgers.com

