

# Transistor Dimmer (454)



## Product Description

The DIN rail mounted 454 is a four-channel transistor dimmer that can operate in one of two modes: leading edge or trailing edge. All four channels operate in the same selected mode, with each channel capable of controlling 2.2 A. It supports capacitive and resistive loads, and it can be connected directly to mains voltage lamps and low voltage lamps with electronic transformers. The unit is not for use with inductive loads. Each channel of the dimmer has both current and thermal protection. The dimmer features an LED seven-segment display. There is a push button user interface for monitoring, manual configuration and control purposes.

## Installation

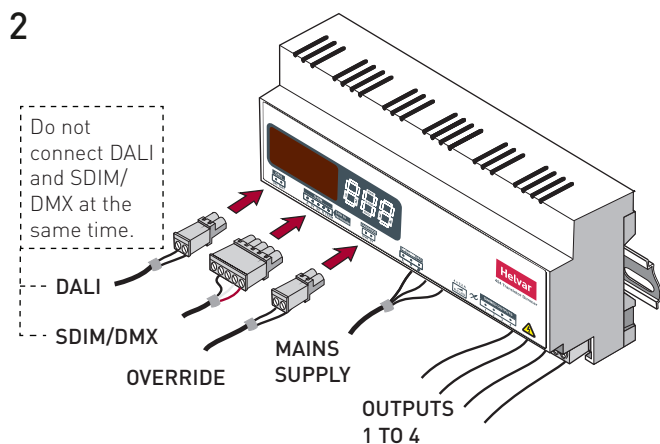
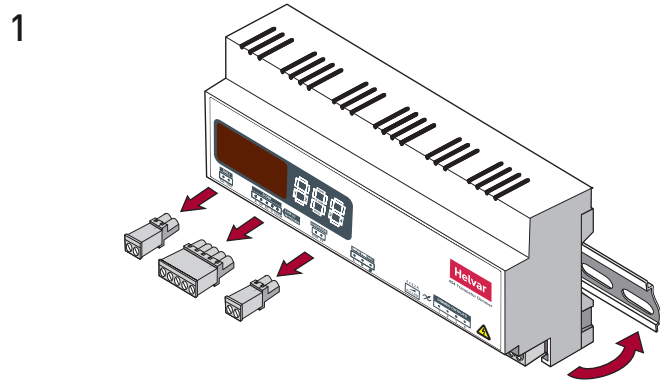

### Location

- For installation in a restricted access location only.

### Position & Ventilation

- Install the unit horizontally to allow for heat dissipation.
- Any enclosure must provide adequate cooling ventilation.

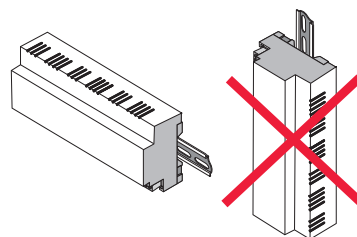

### Electrical

- Do not connect DALI and SDIM/DMX at the same time.
- Isolate the mains supply before installation.
- The external supply must be protected: 10 A Type C MCB max.
- All DALI and mains cabling must be 230 V mains rated.

### Loads

- The 454 is for use with non-inductive loads only.

## Cable Information

Cable	Cable Type
DALI	2-wire mains-rated, 0.5 mm <sup>2</sup> to 1.5 mm <sup>2</sup> Max. length: 300 m (with 1.5 mm <sup>2</sup> cable). Example: Belden 8471.
Mains cable / Dimmed outputs	Max. 2.5 mm <sup>2</sup> stranded (4 mm <sup>2</sup> solid).
SDIM / DMX	Low-loss RS485 Type (multistranded, twisted and shielded). <b>Note:</b> One twisted pair for A and B (85 Ω to 100 Ω impedance), one core or twisted pair for 0 V, and shield for screen. Size: 0.22 mm <sup>2</sup> to 1.5 mm <sup>2</sup> . Core: 3 or 4 + Screen. Max. length: 1000 m (low-loss cable). Example: Belden 8102 or Alpha 6222C.
Override	2-wire, 0.5 mm <sup>2</sup> to 1.5 mm <sup>2</sup> . Max. cable length: 50 m.

## **Contents**

Product Description	i
Installation	i
Cable Information	i
Connections	1
Power Up	2
'Status' Display	2
Navigating the Menu	3
Configuration	4
Output Information	6
Troubleshooting	7
Important Considerations	7
Quick Start Guide	8
Technical Data	9

Connections

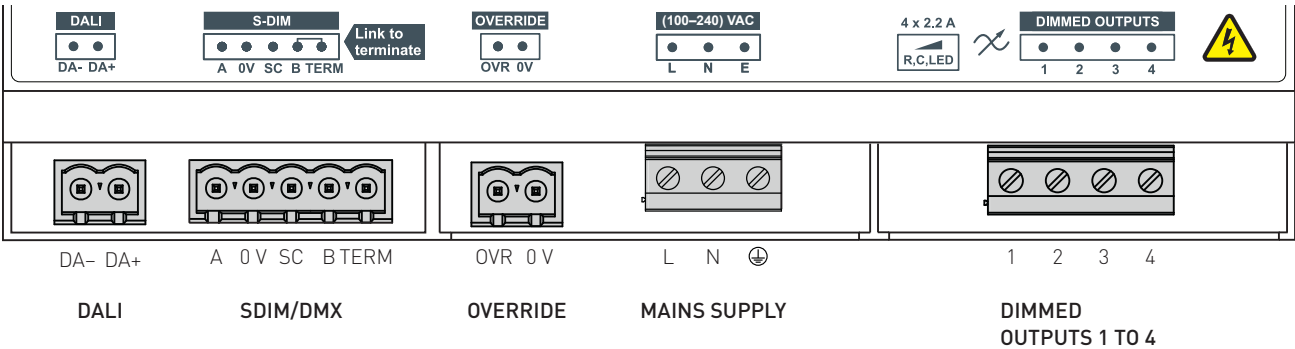

DALI

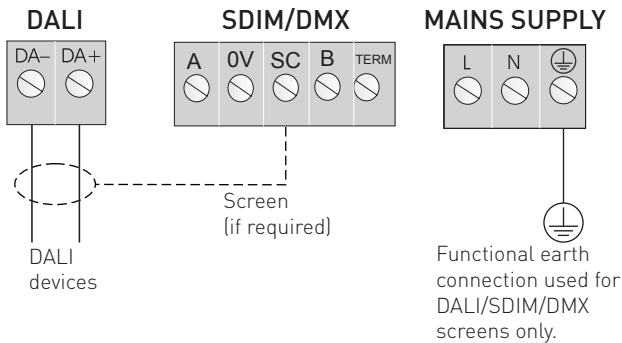

**Note:** Do NOT connect DALI and SDIM/DMX at the same time.

OVERRIDE

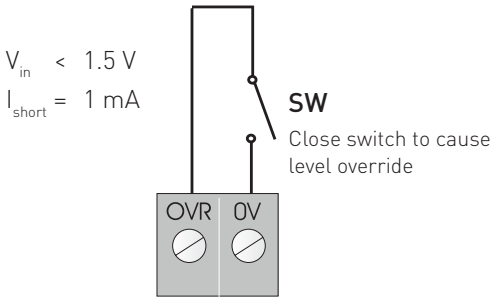

Input for override

**Note:** Maximum cable length = 50 m.

SDIM/DMX

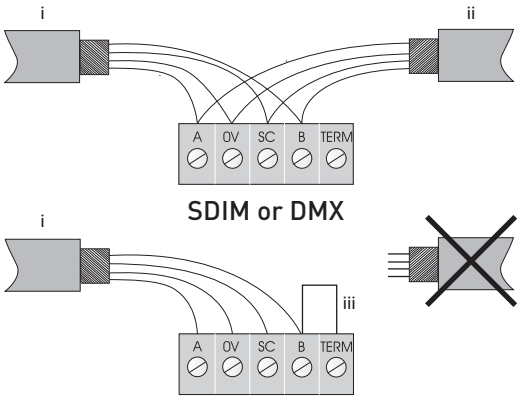

- i = SDIM or DMX data cable (from previous device)
- ii = SDIM or DMX Data Cable (to next device)
- iii = Link for Termination (if unit is at end of SDIM/DMX cable line)

**Note:** Keep unscreened wire lengths to a minimum.

DIMMED OUTPUTS 1 TO 4

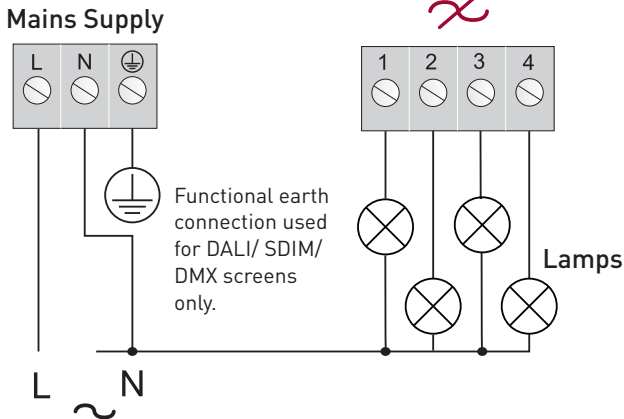

NON-INDUCTIVE LOADS ONLY

Not for wirewound transformers

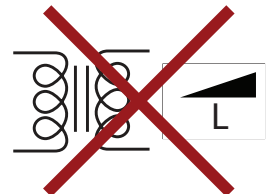

## Power Up

During power up, the following sequence is displayed on the LED control panel. Each display is held for one second. At the end of this sequence, the 'Status' display appears.

### Start-Up Sequence:

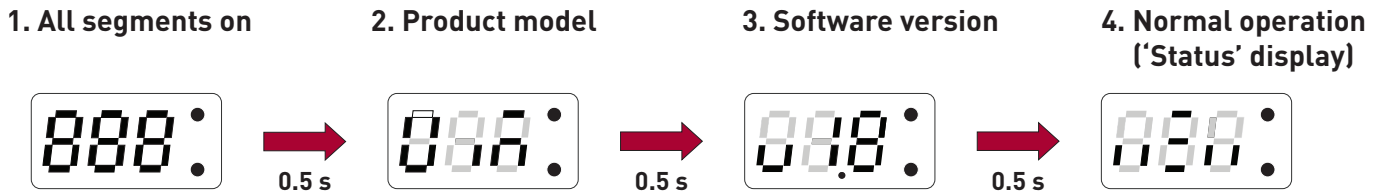

## 'Status' Display

The 'Status' display is the default view in operation. It is the starting point for navigating and configuring the 454.

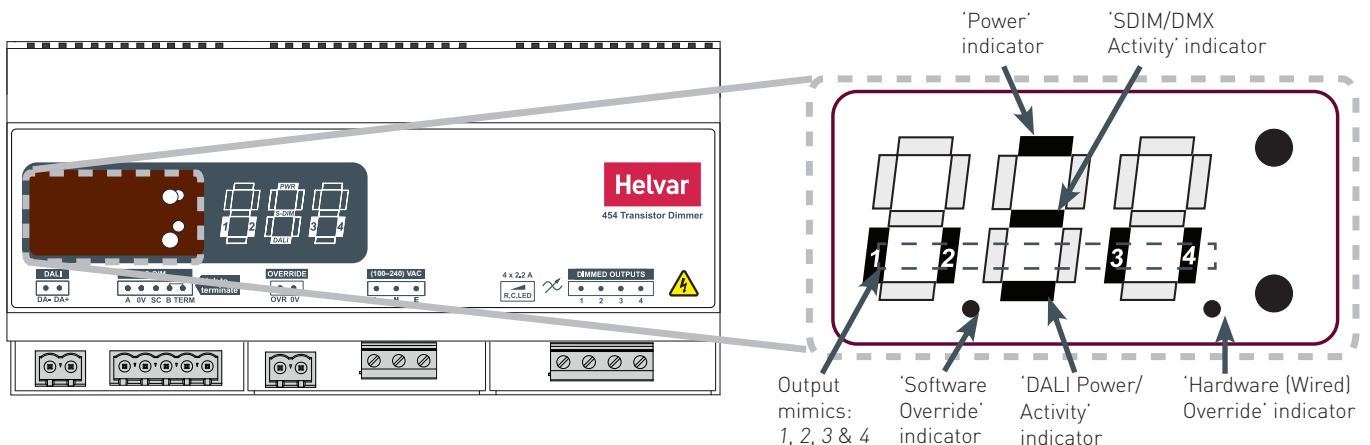

### Key and LED Descriptions:

#### 'Power' indicator

The 'Power' indicator (top segment of the middle digit) is always on when the 454 is powered up.

#### 'SDIM/DMX Activity' indicator

The 'SDIM/DMX Activity' indicator (centre segment of the middle digit) is normally off, and flashes on intermittently if any SDIM/DMX activity (communications) is directed to a channel within the dimmer.

#### Output mimics

The output mimics (1, 2, 3 and 4) are illuminated when the dimmed outputs are on, and not illuminated when the dimmed outputs are off.

#### 'Software Override' indicator

The decimal point on the left is illuminated to indicate software override from the override test menu.

#### 'DALI Power/Activity' indicator

The 'DALI Power/Activity' indicator (bottom segment of the middle digit) is off when there is no DALI power, and on when DALI power is present. When any DALI activity is directed to a channel within the device, the indicator blinks off.

#### 'Hardware (Wired) Override' indicator

The decimal point on the right is illuminated to indicate wired override.

## Navigating the Menu

The 'Status' display LEDs on the front of the unit are lit in the following way from power on:

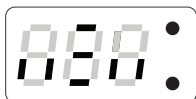

Navigate through the 454 menu using the up/down push buttons located on the front of the unit.

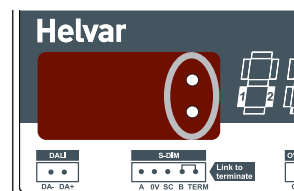

Navigate the 454 menu to configure the unit.

### **Cycle through the menu:**

1) Press both buttons simultaneously to cycle through the menus.

*Tip!* To cycle through the menus quickly, keep holding down both buttons.

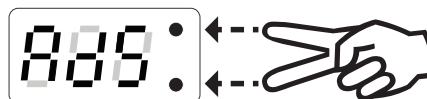

### **Select the desired channel to modify:**

2) At your chosen function, press the up or down button with short presses to scroll through the channel destinations. These are the channels that will be affected by the following settings.

*Note:* Select ALL to alter all channels simultaneously.

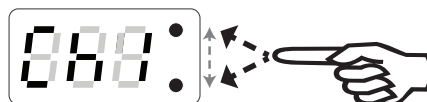

### **Modify function settings:**

3) Hold up or down buttons to alter the levels, settings, fade times, output modes and other settings. For more details, see the 'Configuration' section on page 4.

*Note:* The LEDs blink if a value has been changed and not yet stored.

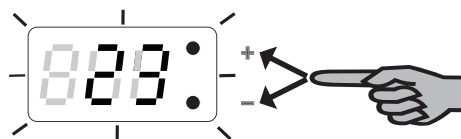

### **Save changes:**

4) Hold both buttons together to save the change.

The LEDs will show 888 for one second to confirm setting is stored.

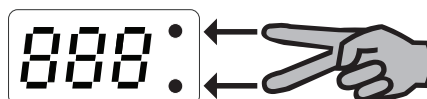

### **Return to previous screen**

To return to a previous screen, do not press the buttons for a short time.

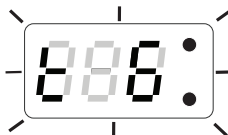

### **Back to 'Status' display**

Ten seconds of inactivity returns the 454 to the 'Status' display screen.



10 s



*Tip!* You can also return to the 'Status' display by cycling through all the menus.

## Configuration

Various settings can be configured via the control panel.



### 'Status' Display / Set Channel Level

Set Channel Levels (0 % –100 %) by using the push buttons in the 'Status' menu. Select the channel(s) to change, and then hold the up or down button to alter the levels.

For more information, see the 'Quick Start Guide' section on page 8.

**Note 1:** You can access 'Status Display / Set channel level' mode while the device is in override mode, but it is not possible to change the channel levels.

**Note 2:** DMX updates are disabled while using manual control.



### Set SDIM/DMX Address

Set the SDIM or DMX address for each channel.

Select **8A5** to set the SDIM or DMX base address.

SDIM: 252 addresses available.

DMX: 512 addresses available.



### Set DALI Address

Set the DALI address for each channel. Select **8A5** to set the DALI base address.

DALI: 64 addresses available.



### Enable/Disable DMX

Enable or disable DMX from this menu.

When DMX is enabled ('On'), it will use the SDIM address.

There is no channel select option; it is a global setting.

**Note:** DMX is disabled by default.



### Set Dimming mode: Leading or Trailing Edge

Select trailing or leading edge dimming from this menu.

**Note:** In either dimming mode, the 454 can dim only non-inductive loads.

All four channels operate in the same selected mode.

The default dimming mode is trailing edge.



### Dimmed Output Table Selection

The outputs can be configured to match common loads via the 'Output Table Selection' ('**8A6**') menu. See the table below for a brief summary of output types. For more details, see the 'Output Information' section on page 6.

Output	Output Type	Additional Information
<b>80</b>	Non-Dim	Switched on and off only
<b>81</b>	Linear	Optimised for incandescent
<b>82</b>	Square	Optimised for incandescent
<b>83</b>	S-law	Optimised for incandescent
<b>84</b>	DALI logarithmic	IEC 62386-205
<b>85*</b>	LED curve	Optimised for LED
<b>86</b>	DALI linear	IEC 62386-205

\* **85** is the default output type.



### Minimum Fade Time

Set the minimum fade time for the channels.

Select the minimum fade time for each channel individually or **ALL** channels simultaneously.

The minimum fade time can be set to: 1.00 second, 0.50 seconds, 0.15 seconds and 0.02 seconds.

**Override Level**

The override level can be configured for individual relay channels or **ALL** channels and ranges from 0 to 100. It can be manually tested via the override test function ('**O-E**')

**Note 1:** When SDIM/DMX is connected, the override settings in the router (configured using Helvar Designer software) will take precedence over the device's override settings unless you configure the software to use the device override settings.

**Note 2:** When the unit is running in override, the left decimal point is illuminated and the middle digit of the screen flashes in the status screen.

**Override Test**

Test that the override level (set in the previous mode) functions as required by choosing ON or OFF. The unit performs as if an override has been caused by the override input connection.

**Note 1:** By switching this setting to ON, it will not be possible to manually edit the channel levels in 'Status Display / Set Channel Level' menu.

**Note 2:** To change the channel levels, ensure that override is switched off.

**Switch-On Level (SDIM / DMX Only)**

Set the switch-on levels for the SDIM/DMX channels.

SDIM: 2 % – 64 % (Default 2 %);

DMX: 0.1 % – 64 % (Default 0.1 %)

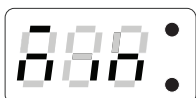
**Set Minimum Level (DALI Only)**

Set the minimum level for DALI channels.

DALI: 0.1 % – 100 % (Default 0.1 %)

**Note:** The minimum level value will be overridden if the 454 is connected to a 910 or 920 router system.

**Hysteresis (SDIM only)**

Select 'On' or 'Off' to activate/deactivate hysteresis. By default, hysteresis is off.

When hysteresis is on, the switch-off level is 80 % of the switch-on level. At or below the switch-off level, the channel will be off. For example, if the switch-on level is 50 % and the signal falls to 40 % or below, the channel will turn off.

**Restore to Factory Default**

Hold the up or down buttons for 10 seconds in this menu.

The decimal points will light up in sequence, and then all LEDs will be on for one second to confirm that factory settings have been restored.

**Note:** Restoring the unit to factory default will permanently delete all the existing manually configured settings.

## Output Information

Below you will find detailed information on choosing the correct output type (E0 to E6) for your lighting system. To configure the outputs, select EAb from the 'Status' display of the unit. For more details, see the 'Output Information' section on page 6. The default output type is E5.



### Non-Dim

Select Non-Dim for simple switch-on and switch-off of non-dimmable loads. DALI, SDIM and DMX protocols can be used with T0. All switching is at the zero-crossing point. Loads must be trailing edge compatible, i.e. inductive loads must not be used.



### Linear

Select Linear [E 1] if you intend to use SDIM or DMX with a linear dim from 0 % to 100 % with respect to control. 'Linear' is a general purpose law that gives control of power from 0 to full power.

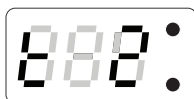

### Square

Select Square [E 2] if you intend to use SDIM or DMX with a curve that conforms to the IES Square Law. Control is from 0 to full power.



### S-Law

Select S-Law [E 3] if you intend to use SDIM or DMX with the output power being in an 'S' curve format.

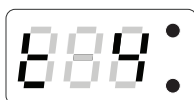

### DALI logarithmic

Select DALI Logarithmic [E 4] if you intend to use DALI with the output power following the standard DALI logarithmic curve with incandescent lamps as per IEC standard 62386-205.



### LED Curve

Select LED Curve [E 5] if you intend to use DALI with a curve that works best with LED lamps. This is similar to the Helvar 452 dimmer curve.

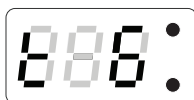

### DALI Linear

Select DALI Linear [E 6] if you intend to use DALI with a standard linear function from 0 % to 100 % with incandescent lamps as per IEC standard 62386-205.



## Troubleshooting

Before contacting Helvar Support, please check the following, as it may provide a solution to the problem that you have encountered, or help our support teams identify the problem.

**Note:** Some of the following error messages are preceded by the channel that caused the error.



### **Trip**

Indicates that one or more channels on the unit have tripped. **EPP** flashes are preceded by the channel that has been tripped. To resume normal operation on the channel, press either button on the user interface. If that does not restore the trip, recycle the power to the unit.



### **Hot**

Indicates that the unit is getting too hot. The unit will attempt to automatically reduce the output level to a safe temperature. To ensure that the unit does not get too hot, install the 454 in an area with sufficient ventilation and situate the unit at an ample distance between other units on the DIN rail. Make sure that the load per channel does not exceed 2.2 A.



### **Trip – Temperature**

Indicates that the 454 unit has tripped because the unit temperature became too high. **E°C** flashes are followed by the channel that has been tripped. This screen succeeds the Hot warning above if the 454 is unable to reduce the output level to a safe level.



### **Trip – Loads**

Indicates that a particular channel (s) has tripped because the temperature has risen too fast or because the wrong load type is connected. Check the loads connected to the 454 and make sure that they are trailing edge compatible. Do not use wire-wound transformers.



### **Communications Error (SDIM / DMX only)**

Indicates a problem with the SDIM or DMX communications. Check wiring and terminations. Then make sure that no two channels have the same addresses on the network and that the SDIM/DMX mode is selected correctly.

## Important Considerations

See below for other important considerations.

- Do not connect DALI and SDIM/DMX at the same time.
- Some lamps may flicker if they are dimmed below their rated minimum level. If this occurs, change the minimum level (DALI) or switch-on level (SDIM/DMX) appropriately. If a 910 or 920 router is being used to control the dimmer, these settings can be changed using Helvar Designer software.
- If DMX does not work, make sure that it has been switched on in the **d7H** menu, and then set the DMX addresses in the **Ad5** menu. For details, see the 'Output Information' section on page 6.

# Quick Start Guide

**Navigation**

- Press both buttons at the same time to cycle through the menu.
- Press up or down button to scroll through the channel destinations.
- Hold up or down button to alter the levels, settings, fade times, output modes (dependent on active mode).
- Hold both buttons together to store the setting.

**Back to 'Status' display**

10 seconds →

**Output table**

Output	Output type	Additional Information
£0	Non-Dim	Switched on and off only
£1	Linear	Optimised for incandescent
£2	Square	Optimised for incandescent
£3	S-law	Optimised for incandescent
£4	DALI logarithmic	IEC 62386-205
£5*	LED curve	Optimised for LED
£6	DALI linear	IEC 62386-205

\* £5 is the default output type.

**Notes**

- Select ALL channels**  
Where available, select, 'ALL' to set all available channels.
- Variable level notice**  
A VAR level notice occurs in certain modes if you are changing levels for ALL channels (via the RLL function), but the individual channel levels vary.
- Set DALI or SDIM/DMX base addresses**  
From the Rdd menu, select bF5 to set the DALI base address.  
From the Rds menu, select bF5 to set the SDIM or DMX base address.

**454 Power On**

When the desired level has been set, wait one second for the 'Status' display to reappear.

**Status / Set Channel Level**

**Set SDIM or DMX Address**

**Set DALI Address**

**Enable DMX**

**Set Dimming Mode**

**Output mode Selection**

**Fade Time**

**Override Level**

**Override Test**

**Switch-On Level SDIM/DMX only**

**Set Minimum Level**

**Hysteresis SDIM only**

**Restore to Factory Default**

**Return to Status Mode**

See 'Output table' (on this page)

Choose Trailing or Leading (affects all channels)

All LEDs flash. Reset complete.

10 seconds

## Technical Data

### Connections

<b>Mains:</b>	Solid core: up to 4 mm <sup>2</sup> Stranded: 2.5 mm <sup>2</sup> <i>Note: Functional earth connection used for DALI/SDIM/DMX screens only.</i>
<b>DALI:</b>	0.5 mm <sup>2</sup> – 1.5 mm <sup>2</sup> , max. 300 m @ 1.5 mm <sup>2</sup>
<b>SDIM/DMX:</b>	0.22 mm <sup>2</sup> – 1.5 mm <sup>2</sup> low-loss RS485 type (multistranded, twisted and shielded)

### Power

<b>Mains supply:</b>	100 VAC – 240 VAC (nominal) 85 VAC – 264 VAC (absolute) 45 Hz – 65 Hz
<b>Power consumption:</b>	2.3 W (excluding loads)
<b>Load current:</b>	2.2 A (2.2 A × 230 V = 500 W) 4 outputs (4 × 500 W = 2 kW)
<b>Heat dissipation:</b>	11 W with maximum load (resistive)
<b>DALI consumption:</b>	2 mA
<b>External protection:</b>	10 A Type C MCB maximum. The external supply must be protected.

### Inputs

<b>Communication:</b>	DALI, SDIM and DMX
<b>Override:</b>	Switched input
<b>User interface:</b>	2 push buttons for configuration

### Mechanical data

<b>Dimensions:</b>	160 mm × 91 mm × 62 mm
<b>Housing:</b>	DIN-rail case; 9 module width
<b>Material:</b>	Polycarbonate/ABS mix, UL94 V-0
<b>Mounting:</b>	DIN rail mounting
<b>Weight:</b>	250 g
<b>IP code:</b>	30 (IP 00 at terminals)

### Operating conditions

<b>Ambient temperature:</b>	0 °C to +40 °C
<b>Relative humidity:</b>	Max. 90 %, noncondensing
<b>Storage temperature:</b>	-10 °C to +70 °C

### Conformity and standards

<b>DALI:</b>	DALI standard IEC 62386, with Helvar additions
<b>SDIM:</b>	Helvar SDIM protocol
<b>DMX:</b>	DMX512-A protocol (max. refresh rate: 33 Hz)
<b>EMC emission:</b>	EN 55015
<b>EMC immunity:</b>	EN 61547
<b>Safety:</b>	EN 60950
<b>Environment:</b>	Complies with WEEE and RoHS directives.

Helvar Ltd  
Hawley Mill  
Hawley Road  
DARTFORD  
DA2 7SY  
UNITED KINGDOM  
[www.helvar.com](http://www.helvar.com)