

INSTALLATION GUIDE

DB3

2016 Dodge/Ram 1500 - 403.CHRYSLER6 2.04

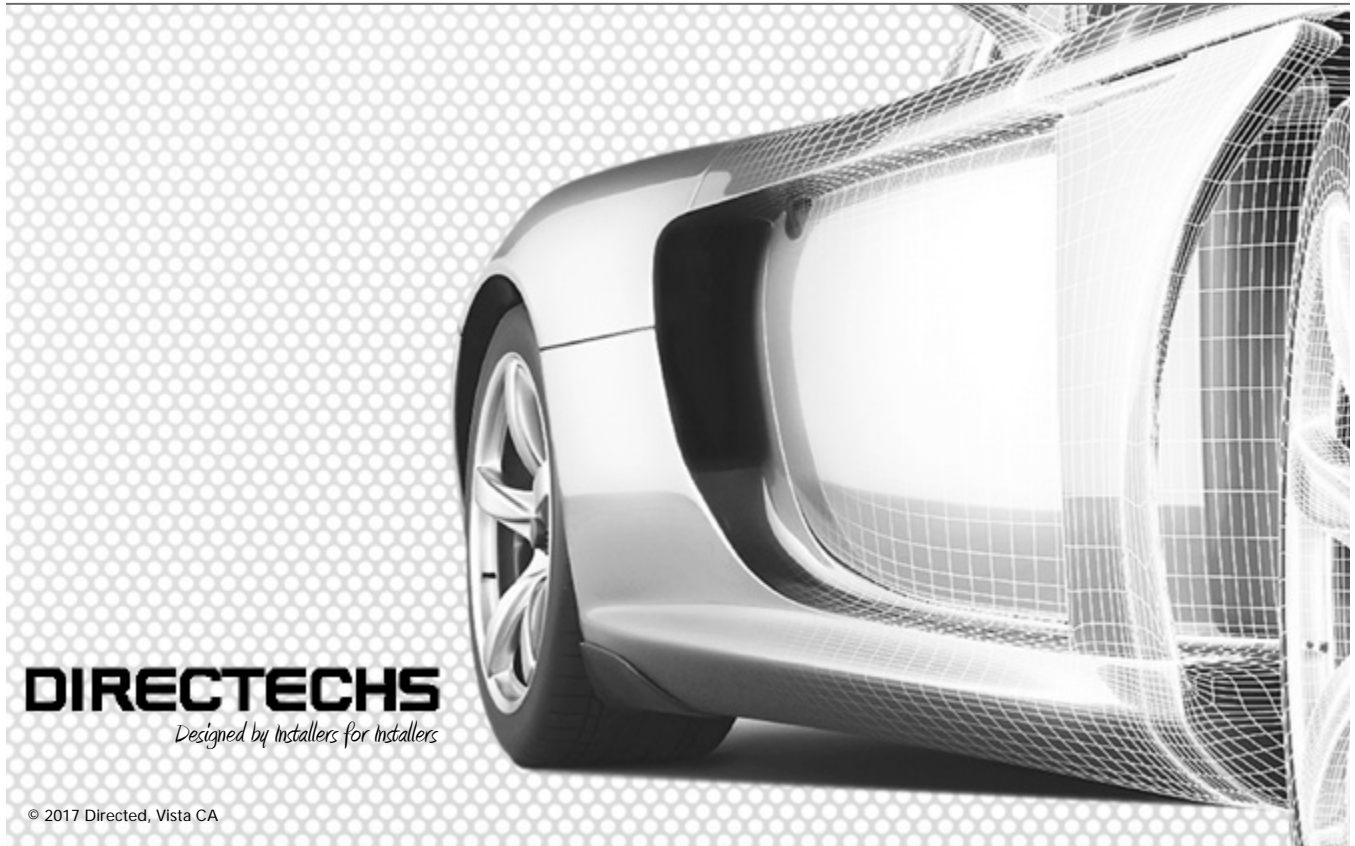

This product is intended for installation by a professional installer only! Attempts to install this product by a person other than a trained professional may result in severe damage to a vehicle's electrical system and components.

DIRECTED®

Contents

- Introduction 4
- Pre-installation and application warnings 5
- Installation 6
 - Wiring diagram 7
- Vehicle connections 8
- Key2GO 10
- Connecting the module 11
 - Module programming 12
 - LED diagnostics and troubleshooting 13
 - Soft reset 15
 - Hard reset 16
- Feature programming 17
- Feature and option list 18
- Limited one year consumer warranty 19
- Quick reference guide 20

Warning! Safety first

 The following safety warnings must be observed at all times:

- Due to the complexity of this system, installation of this product must only be performed by an authorized Directed dealer.
- When properly installed, this system can start the vehicle via a command signal from the remote control. Therefore, never operate the system in an area that does not have adequate ventilation.

The following precautions are the sole responsibility of the user; however, authorized Directed dealers should:

- Never use a test light or logic probe when installing this unit. Always use a multimeter.
- Never operate the system in an enclosed or partially enclosed area without ventilation (such as a garage).
- When parking in an enclosed or partially enclosed area or when having the vehicle serviced, the remote start system must be disabled using the installed toggle switch. It is the user's sole responsibility to properly handle and keep out of reach from children all remote controls to assure that the system does not unintentionally remote start the vehicle.
- **USER MUST INSTALL A CARBON MONOXIDE DETECTOR IN OR ABOUT THE LIVING AREA ADJACENT TO THE VEHICLE. ALL DOORS LEADING FROM ADJACENT LIVING AREAS TO THE ENCLOSED OR PARTIALLY ENCLOSED VEHICLE STORAGE AREA MUST REMAIN CLOSED AT ALL TIMES.**

Use of this product in a manner contrary to its intended mode of operation may result in property damage, personal injury, or death. Except when performing the Safety Check outlined in this installation guide, (1) Never remotely start the vehicle with the vehicle in gear, and (2) Never remotely start the vehicle with the keys in the ignition. The user is responsible for having the neutral safety feature of the vehicle periodically checked, wherein the vehicle must not remotely start while the car is in gear. This testing should be performed by an authorized Directed dealer in accordance with the Safety Check outlined in this product installation guide. If the vehicle starts in gear, cease remote start operation immediately and consult with the user to fix the problem immediately.

OPERATION OF THE REMOTE START MODULE IF THE VEHICLE STARTS IN GEAR IS CONTRARY TO ITS INTENDED MODE OF OPERATION. OPERATING THE REMOTE START SYSTEM UNDER THESE CONDITIONS MAY RESULT IN PROPERTY DAMAGE OR PERSONAL INJURY. IMMEDIATELY CEASE THE USE OF THE UNIT AND REPAIR OR DISCONNECT THE INSTALLED REMOTE START MODULE. DIRECTED WILL NOT BE HELD RESPONSIBLE OR PAY FOR INSTALLATION OR REINSTALLATION COSTS.

Remote starters for manual transmission pose significant risks if not properly installed and operated. When testing to ensure the installation is working properly, only remote start the vehicle in neutral gear, on a flat surface and with a functional, fully engaged parking brake. Do not allow anyone to stand in front of or behind the vehicle.

This product should not be installed in any convertible vehicles, soft or hard top with a manual transmission. Installation in such vehicles may pose certain risk.

Introduction

DB3 is an all-in-one door lock and override module.

Warning!

This module can only be flashed and configured using DirectLink at www.directechs.com or using the Directechs Mobile application for smartphones. Refer to "Connecting the module" for more information.



This solution is compatible with the 2016 Dodge/Ram 1500 and offers the following features:

- AV-Panic Mode Activation
- AV-Parking Lights Control
- DL-Arm Factory Security
- DL-Disarm Factory Security
- DL-Door Lock Control
- DL-Door Unlock
- DL-Driver Priority Unlock
- FOB-Control of aftermarket alarm with OEM remote
- Key2GO
- PK-Immobilizer Bypass-Data No Key Req'd
- RS-3x LOCK START (Start control using OEM Remote)
- RS-OEM Remote Start Activation using XL-202 or RF kit
- RS-RAP Shut Down (Retained ACC Power)
- RS-Remote Start Ready
- RS-SmartStart
- RS-Tach / RPM Output
- SS-Entry Monitoring ALL Door Pins
- SS-Entry Monitoring Hood Pin
- SS-Factory Alarm Trigger Monitoring
- ST-Brake Status (foot brake)
- ST-Door Locks Status
- ST-E-Brake Status
- ST-Ignition Status

Pre-installation and application warnings

Start here

Firmware notes: This section highlights important information for this specific firmware and will assist in pricing accordingly, as well as bringing awareness to any operational or vehicle limitations.

T-Harness compatible 	Yes <input checked="" type="checkbox"/> - THCHD3		Keys required for programming	1	Keys required for operation	0
---	---	--	--------------------------------------	----------	------------------------------------	----------

- ◆ The optional Plug & Play **THCHD3** T-Harness is sold separately.
- ◆ The OBDII Diagnostic Connector features will remain the same even when the T-Harness is installed.
- ◆ Key2GO is mandatory to control the immobilizer override in this firmware.
- ◆ The keyless entry control on the OEM Key FOB used during Key2Go programming will not work while the vehicle is remote started.
- ◆ Unless specified otherwise, all connectors are displayed from the wire side, with the exception of the OBDII diagnostic connector.
- ◆ Refer to "Vehicle connections" following the wiring diagram.

General notes: This section highlights important information for this specific firmware.

- [1] Tach wire is an optional connection required on some remote starters, which do not support a tach signal in D2D.
 [2] HS CAN 2 connections are required for heated seats.

Additional parts required (maximum required):

 <p>0 x 1A Diodes</p>	 <p>0 x Relay</p>	 <p>0 x Resistor</p>	 <p>0 x Fuse</p>
---	---	---	--

Wiring diagram with T-Harness (THCHD3)

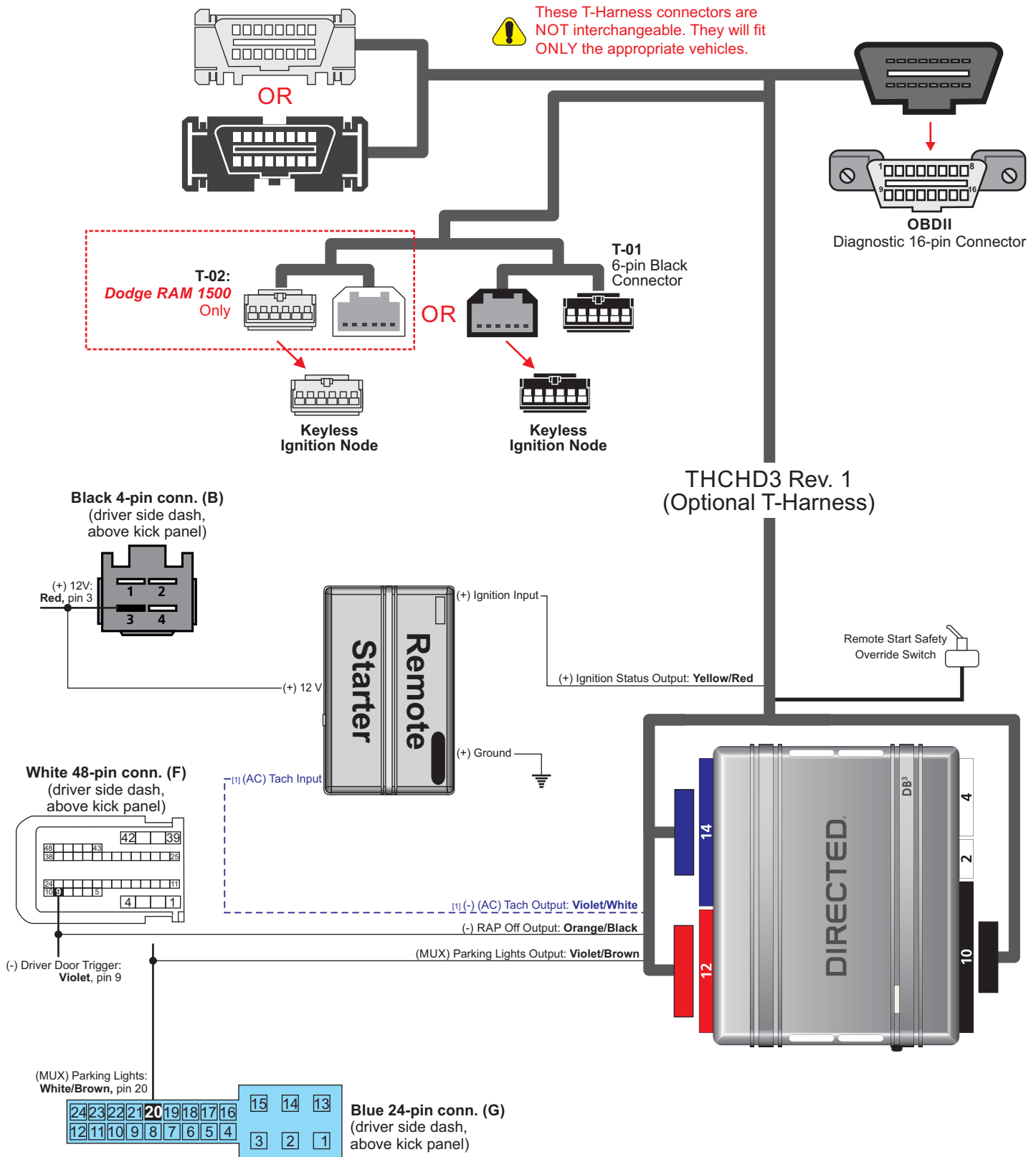

Wiring diagram

Note: The BCM is located in the driver side dash, above the kick panel.

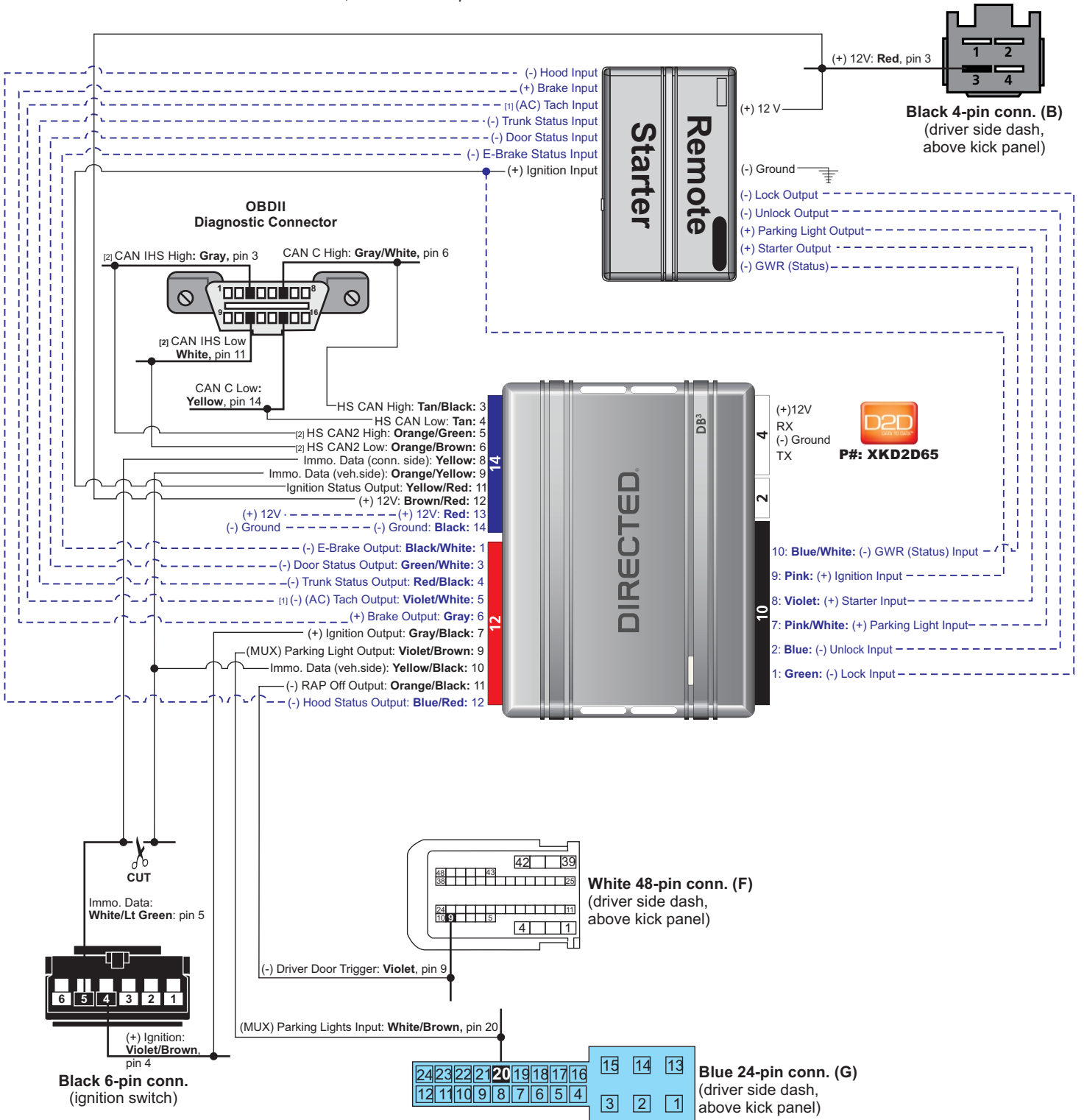

----- Not required in D2D mode.

Vehicle connections

The connection information listed below is specific to the 2016 Dodge/Ram 1500. Refer to "Pre-installation and application warnings" for a list of important notes.

Data 14-pin blue connector (H1)

Module			Connects To			
Conn./Pin	Color	Description	Wire Location	(+/-)	Wire Color	Ref.
H1/1	Light Green	No Connection	No Connection			
H1/2	Violet/Yellow	No Connection	No Connection			
H1/3	Tan/Black	HS CAN High	data link connector, black 16 pin plug, pin 6	data	gray/white (CAN C)	
H1/4	Tan	HS CAN Low	data link connector, black 16 pin plug, pin 14	data	yellow (CAN C)	
H1/5	Orange/Green	HS CAN2 High ^[2]	data link connector, black 16 pin plug, pin 3	data	gray (CAN IHS)	
H1/6	Orange/Brown	HS CAN2 Low ^[2]	data link connector, black 16 pin plug, pin 11	data	white (CAN IHS)	
H1/7	Brown	Relay 1 N.O. - No Connection	No Connection			
H1/8	Yellow	Relay 1 COM - Immo. Data (conn. side)	Ignition Node (ignition switch), black 6 pin plug, pin 5	data	white/lt. green (Security K Line)	
H1/9	Orange or Orange/Yellow	Relay 1 N.C. - Immo. Data (veh.side)	Ignition Node (ignition switch), black 6 pin plug, pin 5	data	white/lt. green (Security K Line)	
H1/10	Orange/Red	Relay 2 N.C. - No Connection	No Connection			
H1/11	Yellow/Red	Relay 2 COM - (+) Ignition Status Output				
H1/12	Brown/Red	Relay 2 N.O. - 12 V	BCM under driver dash, black 4 pin plug (B), pin 3	+	red (40A)	
H1/13	Red	W2W Only - (+) 12 Volt				
H1/14	Black	W2W Only - (-) Ground				

Output 12-pin red connector (H2)

Module			Connects To			
Conn./Pin	Color	Description	Wire Location	(+/-)	Wire Color	Ref.
H2/1	Black/White	W2W Only (-) E-Brake Output				
H2/2	Green/Black	No Connection	No Connection			
H2/3	Green/White	W2W Only - (-) Door Status Output				
H2/4	Red/Black	W2W Only - (-) Trunk Status Output				
H2/5	Violet/White	W2W Only - (AC) Tach Output ^[1]				
H2/6	Gray	W2W Only - (+) Brake Status Output				
H2/7	Gray/Black	(+) Ignition Output	Ignition Node (ignition switch), black 6 pin plug, pin 4	+	purple/brown	
H2/8	Violet/Green	No Connection	No Connection			
H2/9	Violet/Brown	(MUX) Parking Light Output	BCM under driver dash, blue 24 pin plug (G), pin 20	resist or	white/brown	
H2/10	Yellow/Black	Immo. Data (veh.side)	Ignition Node (ignition switch), black 6 pin plug, pin 5	data	white/lt. green (Security K Line)	
H2/11	Orange/Black	(-) RAP Off Output	BCM under driver dash, white 48 pin plug (F), pin 9	-	purple	
H2/12	Blue/Red	W2W Only - (-) Hood Status Output				

Input 10-pin black connector (H3)

Module			Connects To			
Conn./Pin	Color	Description	Wire Location	(+/-)	Wire Color	Ref.
H3/1	Green	W2W Only - (-) Lock Input				
H3/2	Blue	W2W Only - (-) Unlock Input				
H3/3	Red/White	No Connection	No Connection			
H3/4	White/Violet	No Connection	No Connection			
H3/5	Violet/Black	No Connection ^[3]	No Connection			
H3/6	White/Black	No Connection	No Connection			
H3/7	Pink/White	W2W Only - (+) Parking Light Input				
H3/8	Violet	W2W Only - (+) Starter Input				
H3/9	Pink	W2W Only - (+) Ignition Input				
H3/10	Blue/White	W2W Only - (-) Status (GWR) Input				

D2D 4-pin white connector (H4)

Module		
Conn./Pin	Color	Description
H4/1	Green	(Data) TX
H4/2	Black	(-) Ground
H4/3	Blue	(Data) RX
H4/4	Red	(+) 12 Volt

RF 2-pin white connector (H5)

Module		
Conn./Pin	Color	Description
H5/1	N/A	RF Loop
H5/2	N/A	RF Loop

Key2GO

 This feature is mandatory to control the immobilizer override in this firmware.

Key2GO has been designed and developed to bypass the advanced encryption layers found in modern vehicles. It uses an array of servers to generate a duplicate of the original key, allowing the installation of a remote starter without having to give up a key.

The advantage is that this feature allows you to use one original key and the server to configure the bypass in the vehicle.

All Key2GO-compatible firmware are clearly indicated in the function list of each vehicle search result page and will also appear on the flash page. Any first-time user must re-register to gain access to Key2GO, and some additional information will be required to complete the registration process, such as your Directed account number and store name.

Key2GO is compatible with XKLoader2 and the online web tool, as well as XKLoader3 and the Directechs Mobile application.

Refer to "Module programming" of this guide for instructions on how to program features using Key2GO.

Connecting the module

⚠ Important!

Make all the required connections to the vehicle, as described in this guide, and double check to ensure everything is correct prior to moving onto programming.

Warning! To take advantage of advanced features, you must use DirectLink 4.5 (and higher) or the Directechs Mobile application.

Flashing a module using your computer:

1. **Connect** the interface module to your computer using the **XKLoader2**.
2. **Go** to www.directechs.com using Internet Explorer, and **select** the Flash Module button.
3. **Follow** the instructions to **select** your vehicle, installation type, and configure your options.
4. Once you have configured the firmware options, **click** on the FLASH button.

Flashing a module using your smartphone or tablet:

1. **Connect** the interface module to your **XKLoader3**.
2. **Launch** the Directechs Mobile app on your smartphone or tablet.
3. **Select** FLASH YOUR MODULE and **follow** the on screen instructions.

When the flashing operation is successful, you can proceed with the instructions below.

D2D installation

Recommended: **Connect** the 10-pin, 12-pin and 14-pin harnesses to the module, then **connect** the 4-pin D2D harness.

OR

W2W installation

If required: **Connect** the 10-pin and 12-pin harnesses to the module, then **connect** the 14-pin harness to the module.

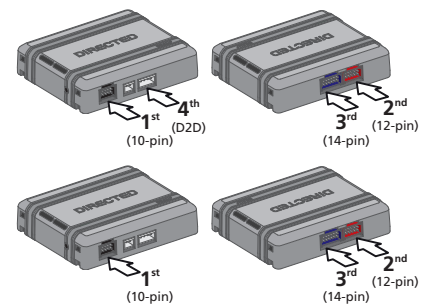

Module programming

 Refer to “LED diagnostics and troubleshooting” for more information and for troubleshooting purposes.

Wait until the LED turns ON solid red.

- 1** **Note:** To skip the transponder programming and use convenience features only, **press** the programming button 5 times. When the LED turns ON solid orange, proceed to step 2.



- 2** **Insert** and **turn** the key to ON, OFF, then **remove** the key.



- 3** **Insert** and **turn** the key to ON once more. When the LED starts flashing orange slowly, **turn** the ignition OFF, **remove** the module from the vehicle and **reconnect** it to your computer. The web site will automatically recognize that you are moving onto the second phase of the programming sequence.



- 4** **Click** on Submit Key2GO Request.

- 5** Once the configuration is completed, **reconnect** the module. The LED turns ON solid green for 3 seconds, then turns OFF.











You have successfully completed the module programming sequence.









LED diagnostics and troubleshooting

This section provides LED diagnostics and troubleshooting information to guide you through the various stages of your installation.

Module Programming

LED	Description	Troubleshooting
 Off	Module has no power.	Make sure the D2D harness is connected and that 12 Volt is present between the red and black wires. If 12 Volt is present, the module may be defective.
 Solid red	Waiting to begin the programming sequence.	Ensure the correct programming procedure is being followed.
 Flashes green & red	Initialization failed.	Reset the module and complete the programming again. If the issue persists, please contact Technical Support.
 Solid orange	Transponder functions were skipped.	(If compatible) when RXT mode is not desired or convenience features are needed, please reset the and reprogram the module.
 Flashes green	All required CAN networks has been detected.	Normal operation.
 Flashes orange	1 of 2 CAN networks has been detected.	Normal operation.
 Flashes orange slowly	Key2GO initiated.	Please follow the steps indicated in "Module programming" to complete the Key2GO programming.
 Solid green x 3 secs	Module was successfully programmed with all functions.	Normal operation.
 Solid orange x 3 secs	Module was successfully programmed without transponder functions.	Normal operation.





Module Programming - Error codes

LED	Description	Troubleshooting
 Flashes red x 1	CAN2 not detected.	Check the CAN2 Orange/Green and Orange/Brown wire connections. Wake up the data bus by turning the ignition on and try again. If your installation does not require this connection, skip this step by pressing the programming button 5 times.
 Flashes red x 1	J1850 not detected.	Check the J1850 wire connection. Wake up the data bus by turning the ignition on and try again.
 Flashes red x 2	CAN1 not detected.	Check the CAN1 Tan and Tan/Black wire connections. Wake up the data bus by turning the ignition on and try again. If your installation does not require this connection, skip this step by pressing the programming button 5 times.
 Flashes red x 3	Bypass data not detected.	Check the bypass line connection. If more than one wire is used, make sure they are not inverted. Ensure the vehicle still operates correctly using the factory key.
 Flashes red x 4	Bypass processing error.	The bypass calculation failed. Reset the module and try again. If the condition persists, please contact Technical Support.
 Flashes red x 5	ISO 1 not detected.	The Yellow/Black wire did not detect the expected signal. Refer to "Installation (wiring diagrams & vehicle wiring reference charts)" to check the connections.
 Flashes red x 6	ISO 2 not detected.	The Orange/Black wire did not detect the expected signal. Refer to "Installation (wiring diagrams & vehicle wiring reference charts)" to check the connections.
 Flashes red x 7	MUX not detected.	The Violet/Green or Violet/Brown wire did not detect the expected voltage value. Refer to "Installation (wiring diagrams & vehicle wiring reference charts)" to check the connections.







External Module Synchronization

LED	Description	Troubleshooting
 (Flashes red, red, then orange) x 10	OBDII feature not supported.	The diagnostic data bus was not detected, therefore the SmartStart features will be limited.





Active Ground When Running (Status)

LED	Description	Troubleshooting
 Flashes green	Ground When Running (Status) command received.	The module has initialized the remote start sequence.
 Flashes red & orange	Ignition ON command received.	The module has received the Ignition ON command and is processing the remote start sequence.
 Flashes green quickly	Start ON command received.	The module has received the Start ON command and is processing the remote start sequence.
 Flashes red x 10	PTS shutdown error.	The PTS output from the module was not activated due to safety protection.
 Flashes red x 21	CAN bus incorrectly detected.	Verify the CAN1 and CAN2 connections. Refer to "Installation (wiring diagrams & vehicle wiring reference charts)" to check the connections.

Commands

LED	Description	Troubleshooting
 Flashes orange x 1	LOCK command received.	If the bypass module fails to flash, it did not receive the signal. Commands can come from RF or D2D.
 Flashes orange x 2	UNLOCK command received.	If the bypass module fails to flash, it did not receive the signal. Commands can come from RF or D2D.
 Flashes orange x 3	TRUNK command received.	If the bypass module fails to flash, it did not receive the signal. Commands can come from RF or D2D.
 Flashes orange x 4	AUX1 command received.	If the bypass module fails to flash, it did not receive the signal. Commands can come from RF or D2D.
 Flashes orange x 5	AUX2 command received.	If the bypass module fails to flash, it did not receive the signal. Commands can come from RF or D2D.
 Flashes orange x 6	AUX3 command received.	If the bypass module fails to flash, it did not receive the signal. Commands can come from RF or D2D.

Shutdown Codes

LED	Description	Troubleshooting
 Flashes green x 1	Takeover successful.	Normal operation.
 Flashes red x 1	Runsafe was not disabled.	No UNLOCK command was received prior to opening the door, or the 45 second timer expired in takeover mode.
 Flashes red x 2	Brake was not detected.	The brakes were not detected, which prevents the system from shutting down the vehicle.
 Flashes red x 3	Smart key was not detected.	The smart key was not detected, which prevents the system from shutting down the vehicle.
 Flashes red x 4	Speed was detected.	The vehicle was detected as moving, which prevents the system from shutting it down.

Soft reset

A module reset will only erase the steps performed in "Module programming". The firmware and settings flashed to the module will not be affected.

D2D installation

Connect the 10-pin, 12-pin & 14-pin harnesses to the module. **Press and hold** the programming button, then **connect** the 4-pin D2D harness.

1

OR

W2W installation

Connect the 10-pin & 12-pin harnesses to the module. **Press and hold** the programming button, then **connect** the 14-pin harness to the module.

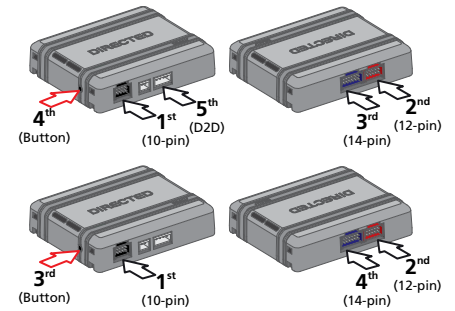

2

Wait 3 seconds until the LED turns ON solid orange then **release** the programming button. The LED turns ON solid red.



Hard reset

Warning Against Executing a Hard Reset!

A hard reset will revert the flashed firmware back to its default factory settings. Depending on the installation, some settings (such as RFTD and D2D options) may have to be reconfigured. Refer to "Feature and option list".

D2D installation

Connect the 10-pin, 12-pin & 14-pin harnesses to the module. **Press** and **hold** the programming button, then **connect** the 4-pin D2D harness.

1

OR

W2W installation

Connect the 10-pin & 12-pin harnesses to the module. **Press** and **hold** the programming button, then **connect** the 14-pin harness to the module.

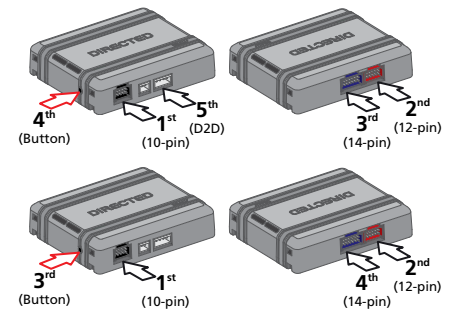

2

Wait 3 seconds until the LED turns ON solid orange, and **wait** 10 more seconds until the LED starts to flash orange and red.

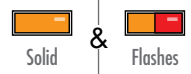

3

Release the programming button. The LED turns ON solid red.



Feature programming

To enter feature programming routine:

1. **Turn** the ignition ON, then OFF.
2. Within 5 seconds, **press** and **hold** the programming button until the LED turns ON orange (after 3 seconds).
3. **Release** the Programming button.
4. The LED will flash green once slowly to indicate the feature number is 1. After a short delay, the LED flashes red rapidly to indicate the current option of feature 1 (e.g. 1 x green followed by 1 x red indicates feature 1 is set to option 1). The flashing sequence will repeat until a new command is entered.

Changing feature options:

1. **Press** the lock/arm or unlock/disarm button on aftermarket transmitter to change the option of the selected feature.
2. The LED flashes red rapidly the number of times equal to the current option number. After a short delay, the LED flashes green slowly the number of times to indicate the current feature. The flashing sequence will repeat until a new command is entered.

Accessing another feature:

1. **Press** and **release** the programming button a number of times to advance from the current feature to the next desired feature.
2. The LED flashes green slowly the number of times equal to the feature number. After a short delay, the LED flashes red rapidly to indicate the current option of the current feature. The flashing sequence will repeat until a new command is entered.

When the maximum number of features or options is reached, the LED will start flashing again from the first feature or option.

Exiting feature programming:

To exit feature programming, **press** and **hold** the programming button for 3 seconds or ensure there is no activity on the interface for 30 seconds. The LED will turn ON orange for 2 seconds to confirm the end of the programming sequence.

Feature and option list

It is recommended to configure all the features and options listed below using the configuration tool found on the module flashing page at www.directechs.com. The web offers more options; however, manual configuration of the features is possible using the information on this page.

* Default option

Feat.	Operation	Flashes / Option	Description
1	RFTD Output Type	1. No RF Output*	Module is connected to a remote starter using a standard installation.
		2. RFTD Output	Module is connected to an XL202 using an RSR or RXT installation (when available).
		3. SmartStart	Module is connected to SmartStart using an RSR or RXT installation (when available).
2	Unlock Driver Priority	1. Driver priority*	Unlocks only the driver door when the button is first pressed, and unlocks all doors when it is pressed a second time within 5 seconds.
		2. All	Unlocks all doors when the button is first pressed.
3	Heated Seats	1. Disabled*	No operation.
		2. Enabled	When the feature is enabled, it will activate the Heated Seats and heated steering wheel.
4	Defroster	1. Disabled*	No operation.
		2. Enabled	When the feature is enabled, it will activate the rear defroster and heated mirrors.
5	Heated Seats/Defroster Temperature Control	1. 32 °F (0 °C)*	When Heated Seats or Defroster feature is enabled, it will activate the feature upon remote start when temperature is below 32 °F (0 °C).
		2. 23 °F (-5 °C)	When Heated Seats or Defroster feature is enabled, it will activate the feature upon remote start when temperature is below 23 °F (-5 °C).
		3. 41 °F (5 °C)	When Heated Seats or Defroster feature is enabled, it will activate the feature upon remote start when temperature is below 41 °F (5 °C).
		4. Always ON	When Heated Seats or Defroster feature is enabled, it will activate the feature at any temperature.
6	Heated Seats Temperature Level	1. High*	When Heated Seats are activated, they will be set to HIGH.
		2. Low	When Heated Seats are activated, they will be set to LOW.
7	Smart OEM Alarm Control	1. Disabled	The OEM alarm will not be controlled by the interface upon remote start. No disarm or arm command will be executed at the beginning or end of the sequence; it must be controlled by the Remote Starter.
		2. Safelock	Smart OEM Alarm Control will behave like a standard Safelock feature on a remote starter. It will unlock at the beginning of the sequence, and relock after start and shutdown.
		3. Enabled*	Smart OEM Alarm Control will synchronize with the OEM alarm so that it will disarm and rearm the vehicle in the remote start sequence, only when required. Smart OEM Alarm Control will monitor the alarm and door lock status to detect if the disarm or rearm is required. If the vehicle is unlocked or is not equipped with factory alarm, the disarm/rearm will not be executed.

Limited one year consumer warranty

For a period of ONE YEAR from the date of purchase of a Directed Electronics remote start or security product, Directed Electronics. ("DIRECTED") promises to the original purchaser, to repair or replace with a comparable reconditioned piece, the security or remote start accessory piece (hereinafter the "Part"), which proves to be defective in workmanship or material under normal use, provided the following conditions are met: the Part was purchased from an authorized DIRECTED dealer; and the Part is returned to DIRECTED, postage prepaid, along with a clear, legible copy of the receipt or bill of sale bearing the following information: consumer's name, address, telephone number, the authorized licensed dealer's name and complete product and Part description.

This warranty is nontransferable and is automatically void if the Part has been modified or used in a manner contrary to its intended purpose or the Part has been damaged by accident, unreasonable use, neglect, improper service, installation or other causes not arising out of defect in materials or construction.

TO THE MAXIMUM EXTENT ALLOWED BY LAW, EXCEPT AS STATED ABOVE, ALL WARRANTIES, INCLUDING BUT NOT LIMITED TO EXPRESS WARRANTY, IMPLIED WARRANTY, WARRANTY OF MERCHANTABILITY, FITNESS FOR PARTICULAR PURPOSE AND WARRANTY OF NONINFRINGEMENT OF INTELLECTUAL PROPERTY, ARE EXPRESSLY EXCLUDED; AND DIRECTED NEITHER ASSUMES NOR AUTHORIZES ANY PERSON OR ENTITY TO ASSUME FOR IT ANY DUTY, OBLIGATION OR LIABILITY IN CONNECTION WITH ITS PRODUCTS. DIRECTED HEREBY DISCLAIMS AND HAS ABSOLUTELY NO LIABILITY FOR ANY AND ALL ACTS OF THIRD PARTIES INCLUDING DEALERS OR INSTALLERS. DIRECTED IS NOT OFFERING A GUARANTEE OR INSURANCE AGAINST VANDALISM, DAMAGE, OR THEFT OF THE AUTOMOBILE, ITS PARTS OR CONTENTS, AND DIRECTED HEREBY DISCLAIMS ANY LIABILITY WHATSOEVER, INCLUDING WITHOUT LIMITATION, LIABILITY FOR THEFT, DAMAGE, OR VANDALISM. IN THE EVENT OF A CLAIM OR A DISPUTE INVOLVING DIRECTED OR ITS SUBSIDIARY, THE PROPER VENUE SHALL BE SAN DIEGO COUNTY IN THE STATE OF CALIFORNIA. CALIFORNIA STATE LAWS AND APPLICABLE FEDERAL LAWS SHALL APPLY AND GOVERN THE DISPUTE. THE MAXIMUM RECOVERY UNDER ANY CLAIM AGAINST DIRECTED SHALL BE STRICTLY LIMITED TO THE AUTHORIZED DIRECTED DEALER'S PURCHASE PRICE OF THE PART. DIRECTED SHALL NOT BE RESPONSIBLE FOR ANY DAMAGES WHATSOEVER, INCLUDING BUT NOT LIMITED TO, ANY CONSEQUENTIAL DAMAGES, INCIDENTAL DAMAGES, DAMAGES FOR THE LOSS OF TIME, LOSS OF EARNINGS, COMMERCIAL LOSS, LOSS OF ECONOMIC OPPORTUNITY AND THE LIKE. NOTWITHSTANDING THE ABOVE, THE MANUFACTURER DOES OFFER A LIMITED WARRANTY TO REPLACE OR REPAIR AT DIRECTED'S OPTION THE PART AS DESCRIBED ABOVE.

This warranty only covers Parts sold within the United States of America and Canada. Parts sold outside of the United States of America or Canada are sold "AS-IS" and shall have NO WARRANTY, express or implied. Some states do not allow limitations on how long an implied warranty will last or the exclusion or limitation of incidental or consequential damages. This warranty gives you specific legal rights and you may also have other rights that vary from State to State. DIRECTED does not and has not authorized any person or entity to create for it any other obligation, promise, duty or obligation in connection with this Part. For further details relating to warranty information of Directed products, please visit the support section of DIRECTED's website at: www.directed.com

920-10012-01 2013-07

This Interface kit / Data Bus Interface part has been tested on the listed vehicles. Other vehicles will be added to the select vehicle list upon completion of compatibility testing. Visit website for latest vehicle application guide. DISCLAIMER: Under no circumstances shall the manufacturer or the distributors of the bypass kit / data bus interface part(s) be held liable for any consequential damages sustained in connection with the part(s) installation. The manufacturer and it's distributors will not, nor will they authorize any representative or any other individual to assume obligation or liability in relation to the interface kit / data bus interface part(s) other than its replacement. N.B.: Under no circumstances shall the manufacturer and distributors of this product be liable for consequential damages sustained in connection with this product and neither assumes nor authorizes any representative or other person to assume for it any obligation or liability other than the replacement of this product only.

Protected by U.S. Patents: 5,719,551; 6,011,460 B1 *; 6,243,004 B1; 6,249,216 B1; 6,275,147 B1; 6,297,731 B1; 6,346,876 B1; 6,392,534 B1; 6,529,124 B2; 6,696,927 B2; 6,756,885 B1; 6,756,886 B2; 6,771,167 B1; 6,812,829 B1; 6,924,750 B1; 7,010,402 B1; 7,015,830 B1; 7,031,826 B1; 7,046,126 B1; 7,061,137 B1; 7,068,153 B1; 7,205,679 B1; Cdn. Patent: 2,320,248; 2,414,991; 2,415,011; 2,415,023; 2,415,027; 2,415,038; 2,415,041; 2,420,947; 2,426,670; 2,454,089; European Patent: 1,053,128; Pat. Pending: 2,291,306. Made in Canada.

Vehicle Takeover

- 1 Press** the remote start button on the transmitter to start the vehicle.*



- 2 Press** the Unlock button on the factory or aftermarket remote.*



- 3 Enter** the vehicle

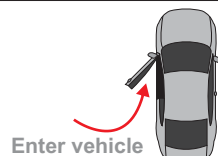

- 4 Insert** the key into the ignition barrel and turn it to the ON position.



- 5 Press** the brake pedal, put the car in gear and drive off.



* Your aftermarket remote may differ from the model shown in the illustrations.

Pit Stop Mode

The Pit Stop Mode feature is practical when you need to stop and run an errand, but wish to keep the engine running.

- 1 Stop** the vehicle in a safe parking spot and put the gear in Park (P).



- 2 Press** the button to remote start the vehicle.* The parking lights will flash once to indicate the vehicle is now in Pit Stop Mode.



- 3 Remove** the key from ignition. It is now safe to leave the engine running and exit the vehicle with the Smart Key in hand.

Note: We recommend that you always lock the doors of your vehicle when leaving it unattended.

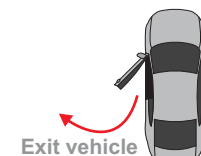











* Your aftermarket remote may differ from the model shown in the illustrations.

DBALL2-CHRYSLER6

List of Available Commands

Note that the information below is for Viper, Clifford and Python models. Icons and commands may differ depending on the remote brand and model purchased. Refer to your authorized installation center for more information.

Button(s)	Actions
	Press & hold for 1 second to lock.
	Press & hold for 1 second to unlock.
	Press & hold for 1 second to remote start.
	Press & hold for 5 seconds to activate the trunk release (optional).
<i>f</i> x1 + 	Press <i>f</i> once, then  to activate the rear hatch/tail glass release (optional).*
<i>f</i> x3 + 	Press <i>f</i> 3 times, then  to activate the panic mode.
<i>f</i> x1 + 	Press <i>f</i> once, then  to reset the remote starter runtime.

* This output is configurable. see your authorized installation center for more information.

Notes
