



Plastic Pipe and Fittings Association

PUBLICATIONS | CPVC

CPVC Piping Systems

Installation Handbook:

CPVC Hot & Cold Water Piping

Published by the
Plastic Pipe and Fittings Association
800 Roosevelt Road
Building C, Suite 312
Glen Ellyn, Illinois 60137
www.ppfahome.org

Introduction

Chlorinated polyvinyl chloride (CPVC) pipe, tube, and fittings have been successfully used in hot- and cold-water distribution systems since 1960. From 1960 to 2000, enough CPVC tubing was sold to plumb millions of typical single-family dwelling units and usage increases each year.

The products consist of ASTM D2846 SDR 11 CPVC tubing manufactured to Copper Tube Size (CTS) ODs (outside diameters) and CPVC socket-type fittings. The ASTM D2846 standard cover sizes ½-inch through 2-inch and both the tubing and fittings are tan in color. As hot and cold water piping, the system carries a continuous use rating of 100 psi at 180° F and 400 psi at 73° F. When sizes larger than 2-inch are needed, ASTM F441 Schedule 80 CPVC pipe made to iron pipe size (IPS) ODs and ASTM F437 and F439 Schedule 80 CPVC fittings are used. Plumbing codes may require proof testing of assemblies for 48 hours at 150 psi and 210° F. Most producers have had these tests performed to qualify their products for use under such codes. CPVC CTS tube and CPVC IPS Schedule 80 pipe is sold in straight lengths. Smaller diameter CTS tube is also sold in coils.

General Information

This handbook is intended to provide basic information for the installation of CPVC (Chlorinated PolyVinyl Chloride) piping¹ for hot- and cold-water distribution systems and is published for the benefit of installers, contractors, code officials, distributors, and home owners. The information has been presented as simply and concisely as possible, but the reader should be aware that more detailed information is available from the manufacturer of CPVC piping or from the supplier of the resin material used in the piping. Some subjects in this handbook are interrelated and may be discussed in more than one section. The authors strongly recommend reading this entire handbook, so the user will be familiar with all aspects of the interrelated items.

The statements and descriptions in this handbook are informational only and are not intended as an endorsement or warranty with respect to any product or system. The Plastic Pipe and Fittings Association (PPFA) and its members make no warranties or representations as to the fitness of any product or system for any particular purpose; the suitability of any product or system for any specific application; or the performance of any product or system in actual construction.

In all cases, the appropriate local authorities should be consulted concerning the requirements covering the use of any particular product or system in any specific application. The manufacturer's label and/or instructions should also be followed. General questions on piping system design or installation described herein may be directed to the Plastic Pipe and Fittings Association.

SDR vs. Schedule 80 and CTS vs. IPS

SDR and Schedules are indicators of the wall thickness associated with pipe and fittings.

SDR indicates Standard Dimension Ratio, meaning a constant ratio exists between the outside diameter of the pipe and the wall thickness. To maintain that ratio, the wall thickness varies based on the diameter of the piping. A higher SDR means a thinner wall. The constant ratio of SDR piping means that all diameters will have the same temperature/pressure rating.

Schedule piping uses a predefined ANSI schedule to set the wall thickness at each pipe size. Since the ratio of wall thickness and diameter varies in a schedule piping system, the temperature and pressure ratings change with the piping diameter.

¹ The term piping covers pipe, tube, and fittings, and the terms pipe and tube are used interchangeably.

CTS and IPS (Iron Pipe Size) dimensions indicate the difference between the nominal outside diameter of the piping and the actual outside diameter of the piping. Copper tube size piping manufactured to ASTM D2846 has an actual outside diameter 1/8 inch larger than the nominal diameter. Generally, IPS piping manufactured to ASTM F441 & F442 has an outside diameter of at least 1/4 inch larger than the nominal diameter, with the difference increasing with the pipe size. For instance, 1" nominal IPS pipe has an outside diameter of 1.315" while 8" nominal IPS pipe has an outside diameter of 8.625".

In a plumbing system, CTS SDR piping will commonly be used for smaller diameters (2" and smaller) while IPS Schedule 80 will be used for larger diameters. While this is the typical design, plumbing codes permit any combination of CTS, IPS, SDR and Schedule 80 systems that meet the temperature and pressure requirements of the applicable code. Due to the differences between outside diameter of CTS pipe and IPS pipe, special transition fittings are necessary to connect these systems.

Pressure Rating

With both CTS SDR 11 and IPS Schedule 80 piping, the pressure rating of the system is dependent on the working temperature of the system. The effect of increased temperatures on the pressure rating can be calculated by multiplying the pressure rating at 73°F by the pipe de-rating factor for the working temperature as shown in Table I. Note that there are two sets of de-rating factors that should be used based on the material designation. The material designation CPVC 4120, CPVC 4120-05 or CPVC 4120-06 will be stenciled on the pipe (see labeling requirements in "How to Identify the Product").

Table I: Derating Factors

Working Temperature (°F)	Pipe De-rating Factor	
	CPVC 4120 & CPVC 4120-05	CPVC 4120-06
73 – 80	1.00	1.00
90	0.91	0.91
100	0.82	0.83
120	0.65	0.70
140	0.50	0.57
160	0.40	0.44
180	0.25	0.31
200	0.20	*Consult Manufacturer

How to Identify the Product

In order to comply with standard ASTM D2846, CPVC tubing shall have the following information printed on it: (a) manufacturer's name, (b) certification or listing agency mark (e.g. NSF-PW or other acceptable agency's mark), (c) size, (d) ASTM D2846 CPVC 4120, (e) SDR 11, (f) 100 psi @ 180° F.

In order to comply with standards ASTM F441 or F442, CPVC pipe shall have the following information printed on it: (a) manufacturer's name, (b) certification or listing agency mark, (c) ASTM standard number F441 or F442, (d) size, (e) Schedule 80 or SDR, (f) pressure rating at 73°F and at 180°F, (g) material designation (CPVC 4120-05 for materials with an HDS of 500 psi at 180°F or CPVC 4120-06 for materials with an HDS of 625psi at 180°F).

In order to comply with the standards ASTM D2846 or F439, CPVC fittings shall have molded markings of (a) manufacturer's name, (b) certification or listing agency mark, (c) ASTM standard number (D2846 or F439), (d) material designation (CPVC 4120 or CPVC for CPVC 23447).

In order to comply with the standard ASTM F493, CPVC solvent cement shall have on the label (a) CPVC Solvent Cement, (b) ASTM F493, (c) certification or listing agency mark, (d) manufacturer's name and address.

In order to comply with the standard ASTM F656, primer shall have on the label (a) primer, (b) ASTM F656 (c) certification or listing agency mark, (d) manufacturer's name and address.

The following standards apply to CPVC and related products:

- ASTM D2846 — Standard Specification for Chlorinated Poly (Vinyl Chloride) (CPVC) Plastic Hot and Cold Water Distribution Systems;
- ASTM F439 — Standard Specification for Chlorinated Poly (Vinyl Chloride) (CPVC) Plastic Pipe

Fittings, Schedule 80;

- ASTM F441 — Standard Specification for Chlorinated Poly(Vinyl Chloride) (CPVC) Plastic Pipe, Schedules 40 and 80;
- ASTM F442 — Standard Specification for Chlorinated Poly(Vinyl Chloride) (CPVC) Plastic Pipe (SDR-PR);
- ASTM F493 — Standard Specification for Solvent Cements for CPVC Pipe and Fittings;
- ASTM F656 – Standard Specification for Primers for Use in Solvent Cement Joints of Poly (Vinyl Chloride)(PVC) Plastic Pipe and Fittings;
- NSF/ANSI Standard 14 — Plastic Piping Components and Related Materials;
- NSF/ANSI Standard 61 — Drinking Water System Components — Health Effects;
- NSF/ANSI 372¹ — Drinking Water System Components - Lead Content; and
- ASTM F402 — Standard Practice for Safe Handling of Solvent Cements, Primers and Cleaners² for Joining Thermoplastic Pipe and Fittings.

Product that does not have legible marking or has a marking that does not contain all pertinent information may not conform with the applicable standard.

Verify local code approval before installing CPVC piping

CPVC piping is included in the International Plumbing Code (IPC) and the Uniform Plumbing Code (UPC); plus the International Residential Code (IRC) for One- and Two-Family Dwellings, the National Standard Plumbing Code (NSPC) and FHA/HUD Use of Materials Bulletins. State and local government/agencies can adopt these model codes as published or modify them.

Therefore, among the questions to be asked are the following:

Is a model code being used in your projects jurisdiction?

If so, which one has been adopted, and have any modifications been made in regard to CPVC piping?

¹ NSF/ANSI 372 replaces NSF/ANSI Standard 61, Annex G

² Cleaner, chemical-an organic solvent used to remove foreign matter from the surface of plastic pipe or fittings

Basics

Since most of the system design parameters, e.g. minimum pressure, fixture unit or flow sizing of pipe, and limiting velocity, are prescribed in the applicable plumbing code, CPVC tube is usually used as a direct size-for-size replacement for copper tube. However, because CPVC is a thermoplastic rather than a metal, there are certain differences in handling, cutting, joining, and installation, and these are detailed here.

Storage & Handling

CPVC pipe and fittings should be stored indoors or covered with a non-transparent material to protect from direct sunlight exposure if stored outdoors.

CPVC solvent cements, primers, and cleaners should be stored indoors between 40°F and 110°F or as specified on the label. Do not store near heat, sparks, open flames or other sources of ignition.

Avoid contamination with solvents, oils or other chemical additives that can cause damage to CPVC (refer to chemical resistance section for more information)

Do not drop, drag, step on, or throw CPVC pipe and fittings.

Prior to installation, always inspect pipe and fittings for physical damage (splits, cuts and gouges) that can occur during shipping or from improper handling such as from being dropped or struck by another object.

See Appendix A for further details on avoiding physical damage to pipes and fittings.

Installation

With Primer or One-step Solvent Cementing Method

CPVC piping and fittings are joined with CPVC cements. The solvent cement process can be a one- or a two-step process. The one-step cement does not require the use of a primer and the cement will be yellow in color. The two-step process does require the use of a primer and the cement will be orange in color. Both types of cements are manufactured under ASTM F493 for use with CPVC hot- and cold-water piping. The label on the can will indicate the cement color and whether a primer is required. Before using one-step cement, check to determine if the local code permits its use or if a two-step cement with primer is required. Primer is manufactured under ASTM F656 and can be clear or purple in color (also verify local code requirements for required primer color).

Joining CTS CPVC Tube and Fittings

Step 1: Cutting

A variety of cutting tools are available and recommended for use with CPVC pipe. CTS CPVC can be easily cut with a wheel type plastic tubing cutter, ratchet cutter, or fine tooth saw, depending on the tool size available.

Ratchet cutters: The use of ratchet cutters¹ is permitted under certain condition, but blades must be regularly sharpened and should not be used when ambient temperature is below 50°F due to the increased risk of overstressing the pipe.



Image 1. Ratchet Type Cutter

Wheel cutters: Wheel-type plastic tubing cutters² with blades made for cutting plastic pipe may be used if blades are regularly sharpened. However, these type cutters will create raised ridges that are caused by material displacement from the downward force of the cutting wheel and the ridges must then be removed.



Image 2. Tubing Style Cutter with a Reaming Tool

Fine tooth saw: When saw cutting, a miter box should be used to ensure a square cut. Cutting tubing as squarely as possible provides optimal bonding area within a joint.

Note: Scissor-style cutters are not recommended because of the extreme forces that may be applied to the pipe.

Cutting previously installed CPVC: Piping that has been in service for long periods of time should be cut with a fine tooth saw or a wheel-type cutter. In such instances, ratchet cutters may cause end cracking on the aged pipe and are not recommended.

If any indication of damage or cracking is evident at the tubing end, cut off³ at least 2" beyond any visible damage.



Image 3. Cutting

Step 2: Deburring/Beveling

Burrs and filings finding their way into the joint can prevent proper contact between tube and fitting during assembly, and should be removed from the outside and inside of the tubing. A chamfering tool⁴ is preferred but a pocketknife or file are suitable for this purpose. A slight bevel on the end of the tubing will ease entry of the tubing into the fitting socket and minimize the chances of pushing solvent cement to the bottom of the joint.



Image 4. Deburring

Step 3: Fitting Preparation

Using a clean and dry rag, wipe dirt and moisture from the fitting sockets and tubing end. Check the dry fit of the tubing and fitting. The tubing should make contact with the socket wall 1/3 to 2/3 of the way into the fitting socket. At this stage there should be an interference fit, tubing should not bottom out in the socket⁵.



Image 5. Socket fit

Step 4: Solvent Cement Application

Use only CPVC cement conforming to ASTM F493 or joint failure may result.

One-step cement is the technically preferred method for joining CTS tubing. However, if required by local code, primer, when properly applied, will have no negative effect on joint integrity. Before using one-step cement, check to determine if the local code permits its use or if a two-step cement with primer is required. Primer is manufactured under ASTM F656 and can be clear or purple in color (also verify local code requirements for required primer color).

When making a joint, apply a heavy, even coat of cement to the pipe end⁶. Use the same applicator without additional cement to apply a thin coat inside the fitting socket⁷. Too much solvent cement may puddle in fittings and/or in the pipe and soften the material to the point of failure under pressure. Too little cement applied can result in gaps and leak paths. Too little cement can also dry too quickly, increasing the chance of a dry joint and making full insertion impossible.

Do not allow excess cement to puddle in the fitting and pipe assembly as this may lead to premature failure.



Image 6 and 7. Cement application

Step 5: Assembly

Immediately insert the tubing into the fitting socket, rotating the tube 1/4 to 1/2 turn while inserting. This motion ensures an even distribution of cement within the joint. Properly align the fitting. Hold the assembly for approximately 10 seconds, allowing the joint to set-up⁸. An even bead of cement should be visible

around the joint. If this bead is not continuous around the socket edge, it may indicate that insufficient cement was applied. In this case, remake the joint to avoid potential leaks. Wipe excess cement from the tubing and fittings surfaces for an attractive, professional appearance



Image 8. Assembly

Joining IPS CPVC Pipe and Fittings

Step 1: Cutting

IPS CPVC pipe can be easily cut with a mechanical saw⁹ or fine-toothed saw. To ensure a square cut, a miter box should be used. Cutting the pipe as squarely as possible provides maximum bonding area in the most effective part of the joint.



Image 9. Saw cutting

Step 2: Deburring/Beveling

Burrs and filings finding their way into the joint can prevent proper contact between the pipe and fitting during assembly, and should be removed from both the inside and outside of the pipe using a chamfering tool, file¹⁰ or reamer. A slight bevel should be placed at the end of the pipe to ease entry into the socket and

minimize chances of pushing solvent cement to the bottom of the joint.



Image 10. Deburring

Step 3: Fitting Preparation

Using a clean dry rag, wipe dirt and moisture from the fitting socket and pipe end¹¹. Moisture can slow the curing, and dirt can prevent adhesion. Check the dry fit of the pipe and fitting¹². For a proper interference fit, the pipe should enter the fitting socket 1/3 to 2/3 of the depth.

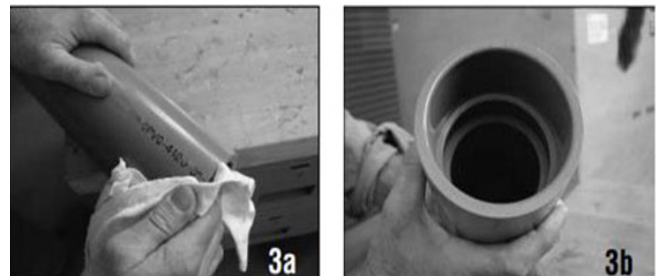

Image 11 and 12. Fitting preparation

Step 4: Initial Fitting Priming

USE PRIMER CONFORMING TO ASTM F656. Using an applicator one-half the size of the pipe diameter¹³, aggressively work the primer into the fitting socket. Re-dip the applicator in the primer as required. Keep the socket and applicator wet until the surface has been softened. Once primed, remove any puddles of primer from the socket.



Image 13. Applicator

Step 5: Pipe Priming

Once the fitting socket has been primed, aggressively work the primer¹⁴ around the end of the pipe to a depth of about 1/2" beyond the socket depth.



Image 14. Priming

Step 6: Fitting Re-priming

Apply a second coat of primer¹⁵ to the fitting socket. Immediately, while both surfaces are still tacky, begin the solvent cementing process that follows.



Image 15. Cement application

Step 7: Pipe Solvent Cement Application

USE ONLY CPVC SOLVENT CEMENT CONFORMING TO ASTM F493.

Acceptable CPVC solvent cements are available that are both orange and gray in color. Verify code requirements for acceptable color of solvent cement.

Using an applicator one-half the size of the pipe diameter, aggressively work a heavy, even layer of cement¹⁶ onto the pipe end equal to the depth of the fitting socket.



Image 16. Cement application

Step 8: Fitting Solvent Cement Application

Without re-dipping the applicator in the cement, aggressively work a medium layer of cement into the fitting socket¹⁷. Avoid puddling the cement in the fitting socket.



Image 17. Cement application

Step 9: Pipe Reapplication

Apply a second full, even layer of cement on the pipe¹⁸.



Image 18. Cement application

Step 10: Assembly

While the cement is still wet, immediately assemble the pipe and fitting, rotating the pipe $\frac{1}{4}$ to $\frac{1}{2}$ turn (if possible) until the fitting stop is reached. Hold the assembly together for approximately 30 seconds to avoid push out¹⁹. A continuous bead of cement should be evident around the pipe and fitting juncture. If the bead is not continuous, sufficient cement was not applied and the joint may be defective. In this case, the fitting should be discarded and the joint reassembled. Wipe excess cement from the pipe and fittings surfaces for an attractive, professional appearance²⁰.



Image 19 and 20. Joining and Cleaning

Safe Handling of Primer, Cleaner & Cement

Solvent cements, primers and cleaners must be handled properly. To do so, refer to ASTM F402, “Standard Practice for Safe Handling of Solvent Cements, Primers and Cleaners”, available here:

<http://www.astm.org/Standards/F402.htm>

Expansion & Contraction

CPVC, like all other materials, undergoes changes in length as a result of temperature variations above and below the installation temperature. Excessive stress and restriction of movement from thermal expansion can damage any piping material. When designing or installing a CPVC system, you must properly compensate for the expansion and/or contraction of the system due to the temperature fluctuations. See Appendix A to learn about what to avoid when compensating for expansion and contraction.

A 100-foot run of CPVC piping will expand about 4

inches with every 100°F degree temperature increase. Expansion does not vary with pipe diameter. Measured expansion of installed piping is typically well below the theoretical values. Although some expansion joints are available, they are rarely used in water distribution systems.

Generally, thermal expansion can be accommodated with changes in direction; however, a long straight run may require an offset or loop. Only one expansion loop, properly sized, is required in any single straight run, regardless of its total length. If more convenient, two or more smaller expansion loops, properly sized, can be utilized in a single run of pipe to accommodate the thermal movement. In addition, there are many ways to compensate for expansion and contraction in vertical piping, always consult the pipe manufacturer for specific recommendations.

Example: Pipe Size - $\frac{1}{2}$ "
 Length of Run - 60'
 L = 38" (From Table)

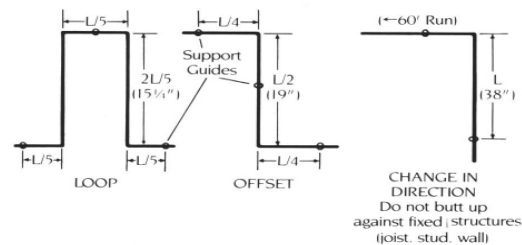

The size of the loop required to accommodate thermal expansion is derived by an equation that considers the length and diameter of the pipe, change in temperature, and other physical properties of CPVC including the coefficient of thermal expansion, modulus of elasticity and the working stress at maximum operating temperature. Tables 2 and 3 give examples. Consult pipe and fitting manufacturers for additional recommendations.

Table 2: Loop Length (inches) – SDR-11 CTS

Run length (ft)		40	60	80	100
Nom. Size	Avg. OD	Loop length "L" in inches			
$\frac{1}{2}$ "	0.625	31	38	44	50
$\frac{3}{4}$ "	0.875	37	46	52	58
1"	1.125	42	52	60	67
$1\frac{1}{4}$ "	1.375	47	57	66	74
$1\frac{1}{2}$ "	1.625	51	62	72	80
2"	2.125	58	71	82	91

Table 3: Loop Length (inches) – Schedule 80 IPS

Nominal Pipe Size (in.)	Length of Run in Feet (L)			
	40	60	80	100
1/2	37	45	52	58
3/4	41	50	58	65
1	46	56	65	72
1 1/4	51	63	73	81
1 1/2	55	67	78	87
2	61	75	87	97
2 1/2	68	83	96	107
3	75	91	105	118
3 1/2	80	98	113	126
4	85	103	120	134
5	94	115	133	149
6	103	126	145	162
8	117	143	165	185

Note: The values in Table 1 and Table 2 above were derived from the following equation and conditions:

$$l = \sqrt{\frac{3ED(\Delta L)}{2S}}$$

$$\Delta L = \alpha C \Delta T$$

$$C = 3.8 \times 10^{-5} \text{ in/in } ^\circ\text{F}$$

$$S = 500 \text{ psi (value for CPVC @ } 180^\circ\text{F)}$$

$$E = 290,000 \text{ psi (value for CPVC @ } 180^\circ\text{F)}$$

$$\Delta T = 100 \text{ } ^\circ\text{F}$$

$$l = \text{length of run, inches}$$

Supports

Point support must not be used for thermoplastic piping, and in general the wider the bearing surface of the support, the better. Supports should be smooth, with no rough or sharp edges should come in contact with the pipe. Supports should not be clamped in a way that restrains the axial movement of pipe that will normally occur due to thermal expansion and contraction. Concentrated loads, such as valves, must be separately supported.

Where pipes go through wood studs, provide oversize holes to allow pipe to move. When installed through metal studs, provide some form of plastic insulators, pipe insulation or similar devices to protect the pipe from abrasion and to prevent noise. Verify the insulating device is chemically compatible with CPVC. See Appendix A for further details.

Support Spacing

Piping systems should be uniformly supported. Failure to properly support pipe places stress on the piping system.

Vertical piping should be supported at each floor level or as required by expansion/contraction design. Provide mid-story guides.

Horizontal runs of CPVC pipe should be supported per the hanger support spacing found in Tables 4 and 5 or per code requirements. For horizontal spacing, these tables show the maximum spacing of supports based on various operating temperatures.

Table 4: Copper Tube Size (CTS) Support Spacing, Feet

Nominal Pipe Size (in)	Maximum Water Temperature			
	73°F	100°F	140°F	180°F
1/2	4	4	3 1/2	3
3/4	5	4 1/2	4	3
1	5 1/2	5	4 1/2	3
1 1/4	6	5 1/2	5	4
1 1/2	6 1/2	6	5 1/2	4
2	7 1/2	7	6 1/2	4

Table 5: Iron Pipe Size (IPS) Support Spacing, Feet

Nominal Pipe Size (in)	Maximum Water Temperature			
	73°F	100°F	140°F	180°F
2 1/2	8	7 1/2	6 1/2	4
3	8	8	7	4
4	9	9	7 1/2	4 1/2
6	10	9 1/2	8	5
8	11	10 1/2	9	5 1/2
10	11 1/2	11	9 1/2	6
12	12 1/2	12 1/2	10 1/2	6 1/2
14	15	13 1/2	11	8
16	16	15	12	8 1/2

Although such incremental variations are technically correct, most codes use the simplified version shown in Table 6.

Table 6: Support Spacing (per codes)

Nominal size	Support spacing
1" or smaller	3 ft
1¼ or larger	4 ft

Additional support should be added near concentrated loads, such as valves or transitions to or from metal piping.

Transition Joints & Fittings

Special transition fittings²¹ or joints are used whenever CPVC piping is connected to a metal valve, fitting, or other appurtenance such as a filter, or to parts made of another plastic. When preparing to make this type of transition, cutting oils should be removed from metallic pipe prior to connecting to CPVC pipe by fully cleaning the inside and outside of the pipe before it is assembled in the piping system.

These special transition fittings can have many forms. One common form is the true union with a metal end and a CPVC end held together with a plastic or metal gland nut and having an elastomeric seal between them. Other forms are the flanged joint, the grooved joint, insert molded metal in CPVC fittings, patented push-on type fittings, and finally the CPVC female threaded adapter with an elastomeric seal at the bottom of the thread. The latter fittings are designed so that they have no thread interference and rely entirely on the elastomeric seal for water tightness. They require only minimal torque to attain an adequate seal.

Standard compression fittings²² that utilize brass or plastic ferrules can be used to assemble CPVC. However, PTFE tape should be applied over the brass ferrule to compensate for the dissimilar thermal expansion rates of the brass and CPVC that could possibly otherwise result in a drip leak. Care should be taken not to over-torque the compression connection.

Metal fittings with CPVC socket inserts are also available. The tubing is cemented directly into the

socket in the same way as an all-CPVC fitting.

The standard practice is to thread a male thread adapter into the female threaded part, such as a valve or stop, and then solvent cement to the CPVC pipe. However, when using the male thread adapter, there are two limitations that the installer must consider when deciding where and how to use it. First, the male thread adapter may develop a drip leak if the joint is subjected to too broad a temperature range. Secondly, some thread paste sealants contain solvents, oils or other chemical additives that can cause damage to CPVC. Only compatible thread sealants and tapes should be used. If CPVC is damaged in an area where thread sealant has been applied, the type of thread seal used should be determined. (see Thread Sealants section). The preferred method of transitioning between metal and CPVC plumbing components is to use an insert molded metal-in-CPVC fitting or true union with a metal and a CPVC end.

Female threaded CPVC adapters without an elastomeric seal should never be used.

If a tapered pipe thread connection between the CPVC and metal components must be made, use a CPVC male thread adapter. Consult the fittings manufacturer for additional limitations.

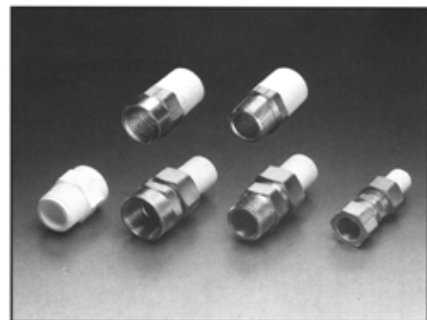

Image 21. Sample transition fittings

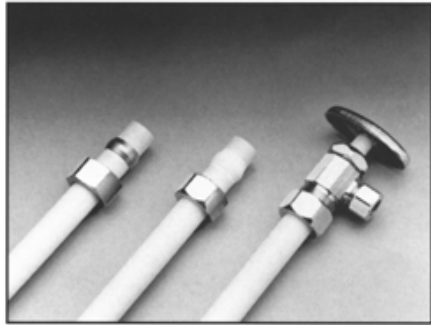

Image 22. Sample compression fittings

Thread Sealants

Threaded CPVC fittings with tapered pipe threads (e.g. male thread adapters) must be used with a suitable thread sealant to insure leak-proof joints. Over the years, PTFE tape has been the preferred thread sealant and it is still the most widely accepted and approved sealant.

Some paste sealants may negatively affect CPVC fittings; therefore only sealants recommended for use with CPVC by the thread sealant manufacturer should be used.

Chemical Resistance

CPVC piping products can be susceptible to stress cracking agents that may be found in certain ancillary products. The information in Appendix A, “Analysis of Improper Use or Installation Issues”, has been generated to create awareness that the potential for damage exists. **Contact the CPVC manufacturer for additional detailed information.**

When choosing ancillary products that are intended to be in direct contact with the piping system, such as thread sealants, fire stopping materials, pipe insulation, etc., the installer should choose products that have demonstrated little or no effect on the piping material. ALWAYS CHECK with the pipe and fittings manufacturer if you have questions regarding chemical compatibility. If chemical compatibility with the plastic remains in question, it is recommended to isolate the suspect product from direct contact with the CPVC pipe or fittings.

Water Heater Connections

Some plumbing codes contain detailed requirements for connections to gas or electric storage type water heaters. Determine whether your jurisdiction has such code requirements and satisfy them.

If no detailed requirements exist, use the following information. On electric water heaters CPVC can be piped directly to the heater with special metal-to-CPVC transition fittings. On high-efficiency, gas water heaters that use plastic vent piping, CPVC can be connected directly to the heater just like the electric water heater connections²³. On all other gas water heaters there should be at least 6 inches of clearance between the exhaust flue and any CPVC piping²⁴. Six-inch long metal nipples or appliance connectors should be connected directly to the heater so that the CPVC tubing cannot be damaged by the build-up of excessive radiant heat from the flue.

An approved temperature/pressure (T/P) relief valve should be installed so that the probe or sensing element is in the water at the top of the heater. CPVC is approved by all the model codes for use as relief valve drain line piping. Although CPVC is rated for 100 psi at 180 °F, it is suitable for the higher temperature of 210 °F, because the pressure is nearly zero psi for a discharge pipe that is open to the atmosphere. Water heater temperature relief valves are generally set to open at 210 °F.

Use a metal-to-CPVC transition fitting to connect to the relief valve and continue the pipe full size to the outlet. For horizontal runs, slope the pipe toward the outlet and support it at three-foot centers or closer. The pipe must discharge to the atmosphere at an approved location.

While CPVC piping systems are suitable for use with properly controlled residential tank less water heaters, do not use CPVC pipe and fittings with commercial-type, non-storage water heaters. Many residential tank less water heaters in North America are limited

to the temperature range of 122°F to 140°F. This temperature is within the specific range of CPVC materials used in plumbing applications.

Do not use CPVC pipe and fittings where operating temperatures can exceed 180°F. Exceeding the temperature/pressure ratings of the pipe is not recommended and may result in system failure.

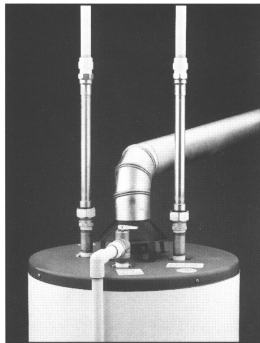

Image 23. Gas water heater connection

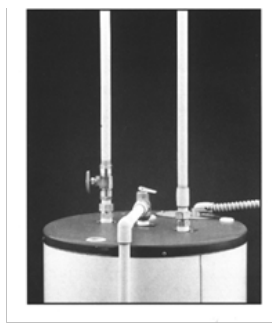

Image 24. CPVC electric water heater connection

Pressure Testing (Joint Cure Time)

When pressure testing CPVC piping, the focus is on time required for the solvent-cemented joints to gain sufficient strength to permit pressure testing without affecting the long-term strength and durability of the system. ASTM D2846 contains pipe OD and socket ID tolerance requirements that are more restrictive than those in most other pressure piping standards. Because of this, the solvent-cemented joints gain strength very quickly after assembly.

Furthermore, it is widely recognized that pipe size is

also a factor in the joint setting and curing process. Joint setting time refers to the time required for the solvent-cement joint to reach handling strength.

Joint set and cure times are a function of pipe size, temperature, humidity, degree of interference, and even length of the pipes being handled. Curing time is shorter for drier environments, smaller sizes, and higher temperatures. Follow the solvent cement manufacturer's recommended set and cure times.

The joint set time is the necessary time to allow before the joint can be carefully handled.

The joint cure time is the time required before a system containing newly cemented joints can be pressure tested and/or put into service. While minimum joint cure times are usually not a factor in new installations, where piping is installed long before the plumbing system is brought online, they may be a factor in repair jobs or minor revisions to piping. CPVC piping systems should be pressure tested per local code requirements after the solvent cement joints have cured for the recommended amount of time.

CPVC must not be used for piping systems intended to convey air or other compressed gases and should not be tested with air or other compressed gases.

Thermal Conductivity, Condensation, & Sweating

In general, plastic materials have low coefficients of thermal conductivity when compared with metallic materials (see table below). Because of this, some users ask whether insulation is necessary to prevent heat loss from hot water piping or sweating of cold-water piping. Generally, it is not necessary to insulate CPVC piping within heated buildings unless it is required by local codes. Following are some factors to support this:

2" Schedule 80 CPVC pipe (2.375" OD - 0.230"

wall) would lose about 140 BTU/h/LF while conveying 170° F water in a 70° F air environment.

2” Type M copper tube (2.125” OD - 0.060” wall) would lose about 5,000 BTU/h/LF under the same conditions.

However, both the CPVC and the copper pipe will cool to ambient temperature in a short time when there is no flow.

CPVC piping carrying 180° F water will have an outside surface temperature of about 150° F in an air-conditioned building.

Under most use conditions that cause copper tube to sweat and drip, CPVC will remain free of condensation.

Thermal conduction is defined as “transfer of heat from one part of a body to another part of the same body, or from one body to another in physical contact with it, without appreciable displacement of the particles of the body.” This definition leads us to the commonly used “K” factor Table 7, which refers to thermal conductivity.

Table 7: Typical “K” Factors

Material	BTU/h/SF/°F/ft	BTU/h/SF/°F/in
Copper	218.0	2616.0
Cast Iron	26.8 to 30.0	321.6 to 360.0
Steel	26.0	312.0
Concrete	0.54	6.5
Brick	0.4	4.8
Wood	0.06 to 0.12	0.7 to 1.4
PVC	0.11	1.3
CPVC	0.08	1.0

Insulation lubricants may cause severe stress cracking of CPVC fittings. Only compatible non-lubricated insulation products should be used with CPVC systems.

Freezing & Thawing

One of the most common conditions that can stop the function of the water distribution system is freezing. Model plumbing codes require that piping exposed to freezing temperatures be properly protected. While

this condition immediately stops the flow of water at the fixture, it may or may not have progressed to the point of rupturing the pipe. Therefore, immediate steps should be taken to eliminate the source of air causing the freeze condition, locate the frozen section and thaw the water line, if possible.

As soon as the frozen section is located, close any outside openings with insulation, circulate warm air into the area, or direct heated air onto the piping using a low wattage heater/blower. A second option is to apply electrical heat tapes to the problem area. Limit the heat source to 180° F or less. If the frozen section is substantially inaccessible, it may be possible to cut open the line at an accessible point and insert a small flexible tube and pump hot water directly to the ice plug. As the hot water is pumped in and the ice is melted, the excess flows back out around the flexible tube.

Once the ice plug has melted, check to see if any pipe or fitting is ruptured, make repairs if necessary, and insulate the area or pipe to prevent future freezing.

Do not use an open flame to heat the frozen pipe.

Hydraulic Shock (Water Hammer)

Although the peak surge pressure that results from interrupting flow in a CPVC pipe is smaller than the pressure in metal pipe, when the velocity is the same, both can produce “hydraulic shock.” While some codes prescribe the use of accessible water hammer arresters adjacent to each solenoid operated valve, other codes do not speak to the subject and leave the decision up to the designer or installer. Water hammer arresters or air chambers are recommended when line pressure is high or where there are high flow fixtures with solenoid valves.

Grounding

Because CPVC is electrically non-conductive, it cannot be used as an electrical ground, and care must be

taken to provide a suitable ground whenever CPVC piping is installed to replace metal piping that has been used as a ground. Because plastic water service lines are being used extensively, and because of galvanic corrosion to metal piping systems from ground faults, many codes prohibit grounding to any type of hot and cold water pipe. Check your local code.

Fire Rated Construction

CPVC water piping can be used within fire rated buildings provided all penetrations of fire barriers (e.g. walls or floor slabs) are made in such a way that the fire rating of the barrier will not be compromised. Most codes and code officials accept penetration sealing systems or devices that have qualified for UL Certification and Listing or have passed appropriate ASTM E119 or E814 tests. The PPFA manual *Plastic Pipe in Fire Resistive Construction* provides more detailed information on this subject and lists available test reports. (Or see the current issue of the Underwriters Laboratories, Inc. Directories of Fire Resistance - Vol. II or WHI Certification Listings.). Some fire stop sealants contain solvents or other chemical additives that can cause damage to CPVC. Only use compatible fire stop materials, systems or devices which are recommended for use with CPVC.

Underslab Installations

CPVC is approved for underslab installations, with joints, in all model plumbing codes. Some local codes contain restrictions on joints underslab and other installation practices; always verify local code requirements.

When performing underslab installations, it is important that the tube is evenly supported on a smooth bottom. The bedding and backfill should be sand or clean soil free of sharp rocks and other debris that could damage the tube. Systems with joints under

slab must be pressure-tested³ before pouring the slab. The tube should be sleeved where it penetrates the slab and at construction joints in the slab.

CPVC water piping, manufactured in accordance with ASTM D2846, is available in coils for underslab installations. When turning the end up through the slab, into walls, etc., be careful not to kink the pipe. Should a kink result, it must be cut out to avoid possible failure. Follow the pipe manufacturer's installation instructions for minimum bend radius permitted to be imposed on the coiled pipe.

CPVC in Plenums

CPVC plumbing pipe is safe for installation in return air plenums; however, the installation must be approved by the local jurisdiction. Even though CPVC is considered a combustible material, it will not burn without a significant external flame source. CPVC requires an environment with at least 60% oxygen to sustain a flame, Earth's atmosphere contains only 21% oxygen, meaning that once a flame source is removed, CPVC will not sustain combustion.

Testing indicates that water filled CPVC in diameters 6 inches or less will pass the 25/50 flame smoke developed requirements for non-metallic material in return air plenums. Refer to piping manufacturer for specific test reports and approvals.

CPVC fire sprinkler pipe tested and listed in accordance with UL 1887, "Fire Test of Plastic Sprinkler Pipe for Flame and Smoke Characteristics," meets model code requirements for installation in return air plenums.

Revision Policy

The PPFA CPVC Product Line Committee has initial responsibility for assuring that the data and other in-

³ The IAPMO IS 20 (Installation Standard for CPVC SOLVENT CEMENTED HOT AND COLD WATER DISTRIBUTION SYSTEMS) requires a pressure test for 2 hours. This requirement applies only to pipe installed under a slab.

formation in this handbook are current and accurate. All suggestions and recommendations for revisions to this handbook should be addressed to PPFA, 800 Roosevelt Road, Building C, Suite 312, Glen Ellyn, IL 60137, Attn.: CPVC Product Line Committee, and the Committee will respond to them as promptly as reasonably possible. The CPVC Committee will review and update the handbook as required based on comments or questions. A complete review will be made at least once every three years.



Plastic Pipe and Fittings Association

PUBLICATIONS |

Installation Handbook:

CPVC Hot & Cold Water Piping

Appendix A: Analysis of Improper
Use or Installation Issues

Section One

Chemical Compatibility Damage

Damage from incompatible plasticizers, chemicals, stress cracking agents in thread sealants, fire stops, and other products, and heat from spray foam insulation can lead to performance issues. These issues can be fairly easy to spot, if you know what to look for, and the damage is in proximity to the incompatible product.

CPVC piping products resist corrosion from aggressive environments and chemicals that are corrosive to metallic piping, and as such, have been used successfully for many years for applications such as chemical lab waste due to this inherent corrosion resistance. **However, CPVC pipe materials may be damaged by contact with certain chemicals found in some construction and ancillary products such as thread sealants, lubricants, anti-freeze solutions, firestop materials, etc. It is important to verify the compatibility of materials that come in contact with the plastic system prior to installation to ensure long-term performance.**

ALWAYS CHECK with the pipe and fittings manufacturer if you have questions regarding chemical compatibility. If chemical compatibility with the plastic remains in question, it is recommended to isolate the suspect product from direct contact with the CPVC pipe or fittings.

Compatibility Concerns:

In general, CPVC piping products can be susceptible to stress cracking agents that can be found in certain ancillary products. The following list has been generated to create awareness that the potential for damage exists. **Contact the CPVC manufacturer for additional detailed information.**

Thread Sealants: Some thread paste sealants contain solvents, oils or other chemical additives that can cause damage to CPVC. Only compatible thread sealants and tapes should be used. If CPVC

is damaged in an area where thread sealant has been applied, the type of thread seal used should be determined.

Fire Stop Material: Some fire stop sealants contain solvents or other chemical additives that can cause damage to CPVC. Only compatible fire stop materials should be used. If CPVC is damaged in an area where firestopping is present ¹, the type of fire-stop used should be determined.

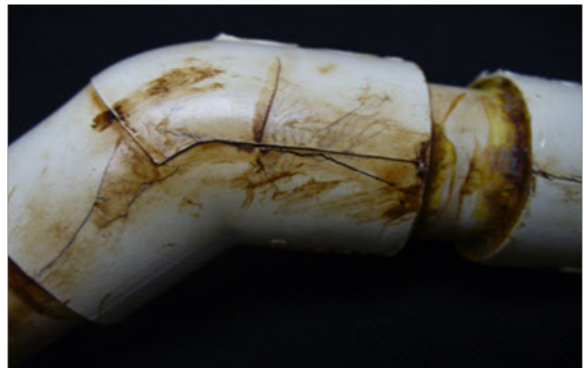

Image 1. Appearance of Incompatible Flame Retardant Damage

Anti-Freeze Solutions: DO NOT USE GLYCOL BASE ANTI-FREEZE SOLUTIONS. The use of improper anti-freeze solutions such as ethylene glycol, propylene glycol and/or contaminated glycerin solutions can cause stress cracking of CPVC resulting piping system failure.

Soldering/Hot Work/Flux: Soldering of metallic components in close proximity to CPVC piping may cause thermal damage to the plastic piping systems. Direct contact with heat (open flame), solder, and soldering flux is not recommended. These types of products should be isolated from direct contact. CPVC contact with solder flux can cause cracks, leaks and breaks in the piping system.

Flexible Wire or Grommets: Direct contact with flexible wire, cable, or grommets should be avoided as the insulation for the wire and cable can contain plasticizers that can cause CPVC piping systems to crack, leak or break. The finished installation should be inspected to verify that the plastic piping

system is not being used to support wire or cable, and that runs of wire and cable have not been pulled over the installed CPVC system.

Rubber and Flexible Materials: CPVC is not compatible with many rubber and flexible plastic materials as these materials may contain certain types of plasticizers, which when placed in contact with CPVC can cause the piping system to crack, leak or break². (Incompatible plasticizers include, but are not limited to, phthalates, adipates, trimellitates, dibenzoates, etc.) Incompatible rubber and flexible plastic materials can be found in plastic hangers or plastic coated hangers, hoses and tank linings and in the fluids that come in contact with them.



Image 2. Damage from plasticizer contact

Metallic Pipe Transitions / Cutting Oils:

Transitions from metallic pipe and CPVC pipe can be made through a variety of methods such as threaded, flanged, and grooved transition components. Cutting oils may be incompatible and should be removed from metallic pipe prior to connecting to CPVC pipe by fully cleaning the inside and outside of the pipe before it is assembled in the piping system. Incompatible cutting oils have been used to manufacture some HVAC evaporators/heat exchangers. Failures typically occur with new units when the A/C is used for the first time and the oil from the blades is washed into the drain lines.

Paint: Oil or solvent-based paints may be chemically incompatible with CPVC. Water-based acrylic or latex paint is the preferred paint to use on CPVC pipe and fittings. The installation contractor must take responsibility for obtaining approval from the Authority Having Jurisdiction to cover the markings on

the product (i.e. product identification, listing marks, etc.) and to change color of the pipe and fittings from its identifiable color prior to painting.

Cooking Oils and Grease: When CPVC pipe is installed in kitchen areas the pipe must be protected from contact with grease or cooking oils. Certain cooking oils can cause the CPVC piping to crack, leak, or break when applied to the piping system.

Spray On Coatings: Certain types of spray-on coatings that form a peelable film to protect fixtures during construction may be incompatible with CPVC. Care should be used to protect exposed piping from over-spray when this type of protective coating is applied.

Termiticides and Insecticides: When performing installations under slab or where the presence of insecticides or termiticides is likely, care should be taken to isolate CPVC pipe from direct contact with large quantities of these chemicals. CPVC can be damaged when termiticides or insecticides are injected into the annular space between the pipe wall and sleeving material trapping the termiticide against the pipe wall or in areas where puddling/pooling of these chemicals may occur.

Mold Abatement and Fungicides: Building restoration projects used to repair water damage often include the use of mold abating products such as fungicides. These products can damage PVC and CPVC piping systems and can cause cracks, leaks, or breaks in the system. When performing repairs or modifications care should be taken to isolate the plastic piping system from direct contact with fungicide products. When repairs are made to an existing system, and the possibility exists that fungicides will be applied to treat damp drywall and wood framing surrounding the repair site, exposed piping should be sleeved with a compatible plastic sleeving or pipe insulation material to prevent direct contact of the fungicide with the plastic piping system.

Improper use of two part spray foam

insulation: Improper installation of two-part expanding foam insulation can result in extremely high surface temperatures that can damage piping³ and other products.



Image 3. Excessive heat damage caused by improper installation of two-part spray foam

Section Two Thermal / Thermal Expansion Damage

Excessive stress and restriction of movement from thermal expansion can damage any piping material.

CPVC, like all other materials, undergoes changes in length as a result of temperature variations above and below the installation temperature. When designing or installing a CPVC system, you must compensate for the expansion and/or contraction of the system due to the temperature fluctuations.

There are three primary methods for controlling or compensating for expansion and contraction: offsets, loops and changes of direction. Below are examples⁴ of each.

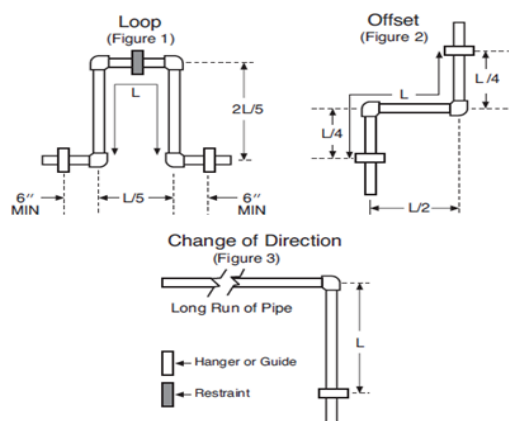

Image 4. Examples of proper layouts to control thermal expansion

Uncontrolled excessive stress: If compensation is not provided for the changes in length, excessive flexural stresses are introduced at concentrated areas. Excessive flexural stresses caused by the lack of compensation for expansion and contraction can result in system failure and/or property damage. In the photo sequence below^{5,6,7} a 90° elbow assembly experienced stress such that a crack resulted in the inside radius area of the fitting.

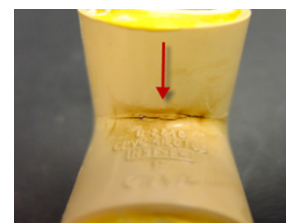

Image 5 & 6. Thermal expansion / contraction damage to fitting



Image 7. Pipe under excessive flexural stress

Improperly designed expansion loops: Properly designing expansion loops, offsets and changes in direction will ensure that excessive flexural stresses do not contribute to the system failure or property damage. In the image⁸ you can see that there was no area for movement in the loop. In the second photo⁹ you can see that room for expansion was incorporated and the system was allowed to move, relieving flexural stresses.

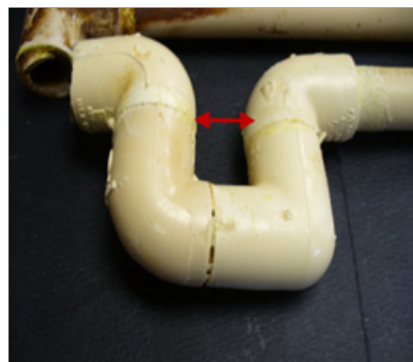

Image 8. Too tight expansion loop failure

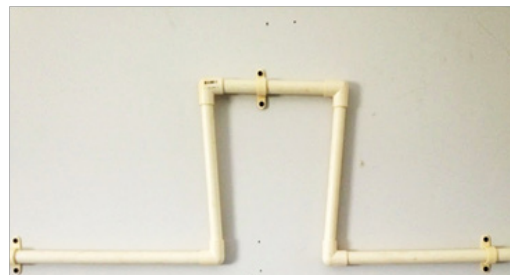

Image 9. Proper offset loop design allows movement

Hangers restricting movement: Proper sizing of offsets, loops and changes of direction are critical to the overall effectiveness of the compensation for expansion and contraction, as are the accurate placement of guides and anchors. If movement occurs and the system is constrained either by a stationary object or anchor, therefore restricting movement, stresses and forces may cause damage to the pipe system. In the example below ¹⁰ you can see that restraints are improperly placed on the vertical arms of the expansion loop, thereby obstructing expansion.

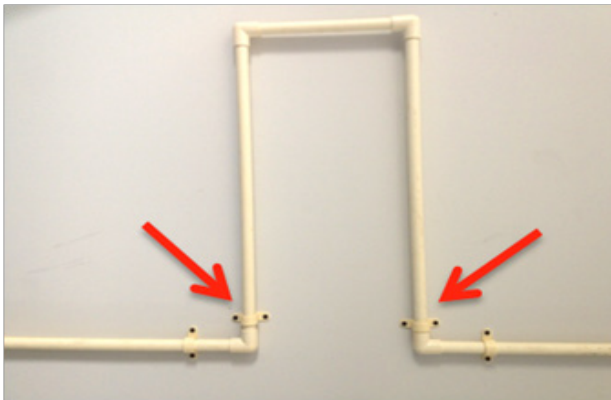

Image 10. Improperly positioned supports restrict expansion

Failure to properly align the system can also cause undue stress to the assembly that can result in failure. In the photo below ¹¹, the dashed lines represent a straight course and it is easy to see that the assembly was under stress, which resulted in permanent deformation and ultimately failure of this assembly.

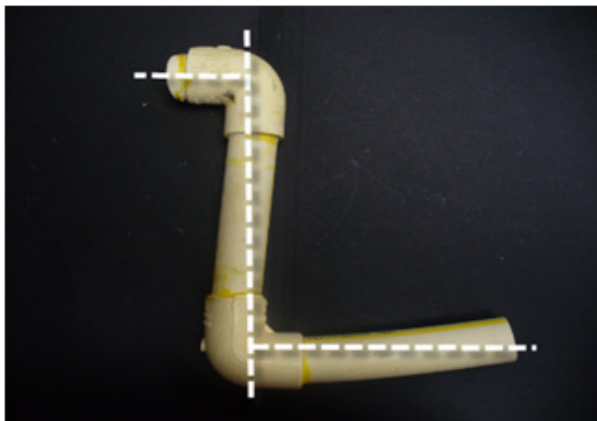

Image 11. Stress failure example

Non-uniform support: Piping systems should also be uniformly supported, and installed away from sources of high heat, such as a combustion flue. Failure to properly locate or support pipe can damage or place stress on the piping system, as seen in the photo examples ^{12, 13} below.



Image 12. Pipe installed near high heat

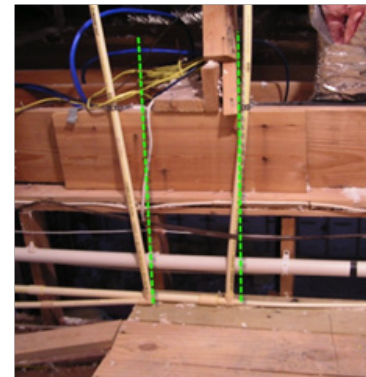

Image 13. Pipe support stress example

For more information regarding Expansion and contraction of CPVC or for designing and installing information, contact the manufacturer of the material pipe and fittings or consult a licensed engineer.

Section Three Physical Damage

CPVC pipe and fittings should be handled with reasonable care. CPVC which is stored outside for extended periods should be covered with opaque protection¹⁴ to reduce exposure to sunlight, which over time will reduce pipe ductility.



Image 14. CPVC in UV protective cover

Prior to installation, CPVC pipe and fittings should be inspected for physical damage that can occur during shipping or from improper handling such as from being dropped or struck by another object. Improper handling of CPVC pipe and fittings^{15, 16} can create minute cracks at or near the area of impact. These cracks often occur near the ends of the pipe. While these cracks may not be immediately visible, in service they can grow to eventually permeate the pipe wall and cause leaks. Longitudinal cracks may occur along an extrusion line on the inside wall of the pipe. These extrusion lines are not the cause of the crack or leak, but rather concentration points for the stresses that result from improper cutting or improper handling.

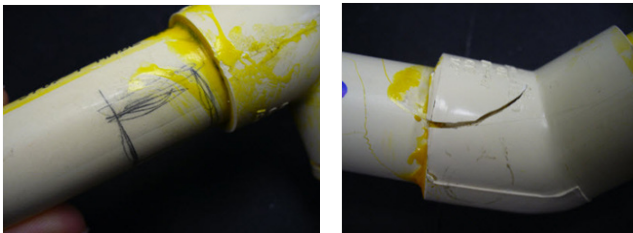

Image 15 and 16. Pipe or fitting damaged before installation

Installation of damaged pipe or fitting:

A longitudinal crack located near an area that contains a scuff or marred surface is typically caused by impact to the pipe from a foreign object, stepped on pipe, driven over, etc. If prior to joining, the ends of the pipe or fitting show any indication of damage or cracking¹⁷, remove at least two inches beyond any visible damage.



Image 17. Damaged Tubing End

Dull cutting blades: Tools used to cut pipe must be in good condition. Cutting blades should be sharpened regularly to prevent overly stressing the pipe that can create minute breaks in the pipe¹⁸ that can grow to create leaks. A longitudinal crack, which caused a leak located several inches back from the end of the joint, is an indication that the pipe was possibly overly stressed due to improper cutting such as from dull cutting blades.

Cold weather use of cutters: The use of ratchet cutters is permitted under certain condition, but should not be used when ambient temperature is below 50°F due to the increased risk of overstressing the pipe.



Image 18. End crack shown in cutaway

Scissor-style cutters: Scissor-style cutters¹⁹ are not recommended because of the extreme forces which may be applied to the pipe.



Image 19. Scissor Cutter: not recommended for CPVC

Section Four Improper solvent ce- menting

Improper application of solvent cement can cause issues with a system.

Too much solvent cement: Too much solvent cement may puddle in fittings and/or in the pipe and soften the material to the point of failure under pressure. The damage will usually be aligned to where gravity settles the excess cement ^{20, 21}.

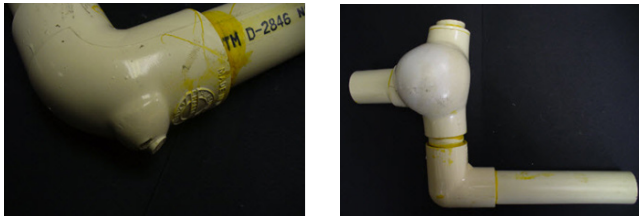

Image 20 and 21. Excess cement in fitting damage

Too little solvent cement/dry joints/small applicator: Too little cement applied can result in gaps & leak paths. Dry areas of the pipe and fitting may be observed, and gaps allowing leaks ^{22, 23}. Too little cement can also dry too quickly, increasing the chance of a dry joint and making full insertion impossible.



Image 22 and 23. Insufficient cement/dry joint

Failure to insert pipe to bottom of fitting socket: Most the strength in a solvent welded joint is at the bottom of the fitting. The damage will be caused by the reduction in joint strength, and will be obvious on examination.

Expired cement/ incorrect cement: Cement in poor condition, or of the wrong type, may cause multiple joint failures.

Debris in solvent cement and/or dirty pipe & fittings: Foreign materials finding their way into the joint and/or cement will interfere with the quality of the joint.

Pipe not cut square & ends not chamfered or beveled: Since the strength of the solvent welded joint is found at the bottom of the socket, an uneven cut will weaken the joint. Such improper installation will be easy to spot.

Section Five

Extreme Fluid Temperatures

Fluid temperature extremes, both hot and cold, can result in failure of piping systems. System design and installation must maintain fluid temperatures within the temperature/pressure limits established by the applicable standards and the pipe and fitting manufacturer recommendations.

Excessively High Temperature: In all thermoplastic piping systems, including CPVC, the pressure rating will decrease as the operating temperature increases. For example, an SDR 11 CTS pipe made to the requirements of ASTM D2846 will be rated at 400 psi @ 73°F. The same pipe will be rated at 100 psi @ 180°F.

Exceeding the temperature/pressure ratings of the pipe is not recommended and may result in system failure ²⁴.



Image 24. Excessive temperature and pressure damage

Freeze damage: CPVC is a ductile material, which expands and contracts more than metallic plumbing pipe. However, CPVC, like all other piping materials, needs to be protected from freezing or breakage may result ²⁵.

If water filled CPVC pipe becomes frozen, immediate action should be taken to eliminate the source of air causing the freeze condition. Then thaw the water line, if possible. When thawing a frozen CPVC water line, it is important to remember to limit the heat

source to 180°F or less. If the frozen section of pipe is accessible, heated air can be blown directly onto the freeze area by using a low wattage heater/blower. A second option is to apply electrical heat tapes to the problem area.



Image 25. Examples of damage resulting from freezing

Published on: April 15, 2015

This document can be viewed online at:

http://ppfahome.org/pdf/ppfa_CPVC_installation_handbook_2015.pdf

© 2015 PPFA. All Rights Reserved.