



 PANEL 2

DO IT YOURSELF INSTALLATION MANUAL



PANEL 2

The IQ Panel 2 keeps you connected to an entire ecosystem of smart devices giving you control over your entire home.

Exciting features like touchless disarming using Bluetooth and a built in glass break detector are enabled through powerful software that improves over time through regular software updates.

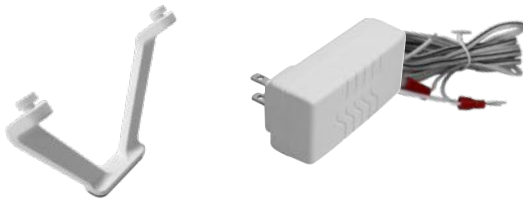

The IQ Panel also includes a snap on table stand and power supply with cable.



MOTION-S

The IQ Motion detects infrared body heat useful for both security and home automation. Create rules like “when someone enters the room, turn on light” or “Trigger siren when body detected”.



DW MINI-S

The IQ Mini door/window sensor is a powerfully small device that can be placed on anything that opens or closes. Create automation rules like “turn on light when door is opened” or “Adjust thermostat if window left open”.

Let's start by connecting your power.



Plug in the power connector



Route the wire behind the retainer clip

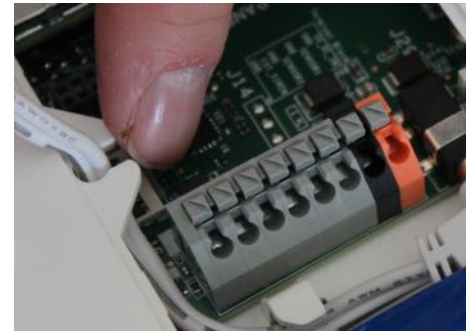

Insert the wire into the strain-relief

Now let's put on your cover and attach the table stand.



Place the top of the cover onto the panel's back plate



Push the cover down until it snaps in place



Insert the table stand into the mounting holes and push upward until it snaps into place

Plug in your panel, power it on



Plug in the power supply provided with your panel

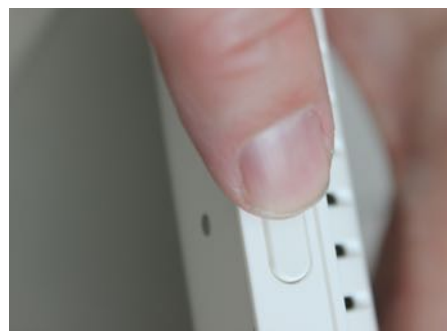

Push and hold the standby button on the side of the panel for 3 seconds



Once the panel powers up, the home screen will appear.



DOORS & WINDOWS

Your IQ Mini is an ultra compact encrypted sensor that can be placed on anything that opens or closes.

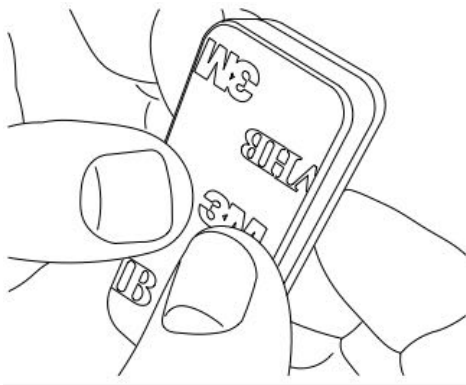

Apply the included adhesive.

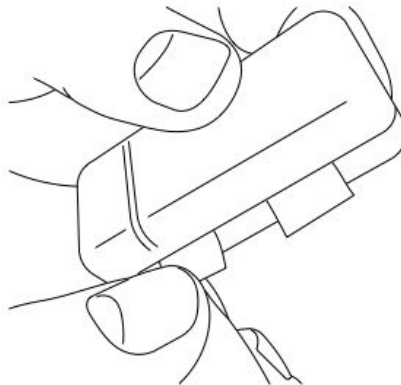

Remove the two battery tabs.



Remove the protective film.

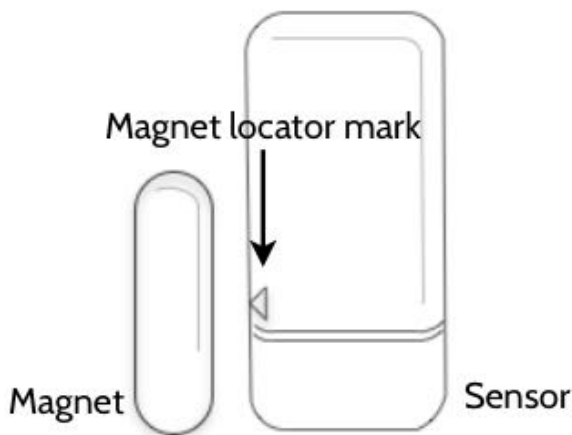

Line up the sensor with the magnet.

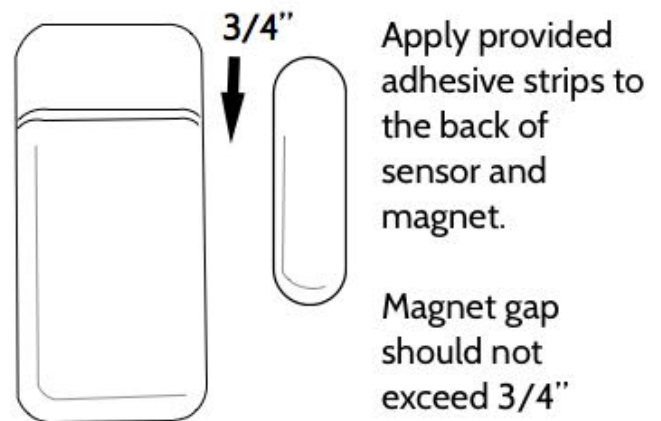

Secure the sensor and magnet to the surface.

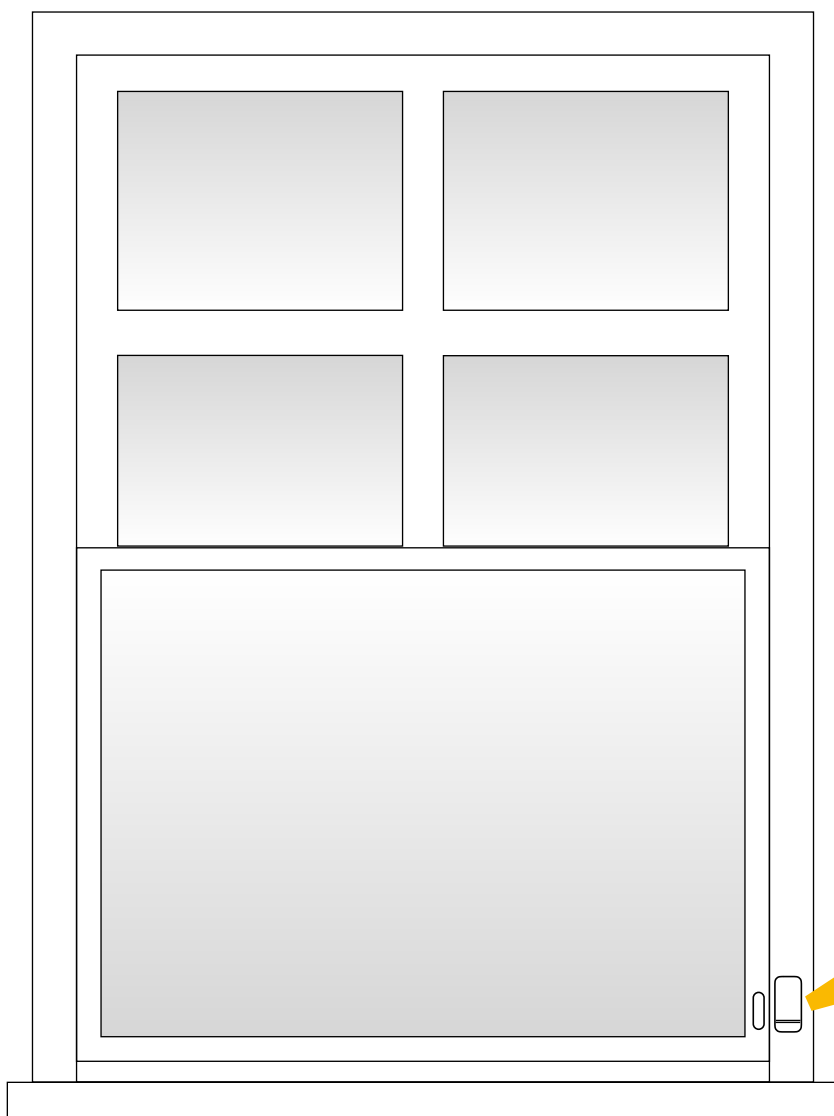

Typical installation of magnet/sensor with the magnet on the window and the sensor on the window frame.

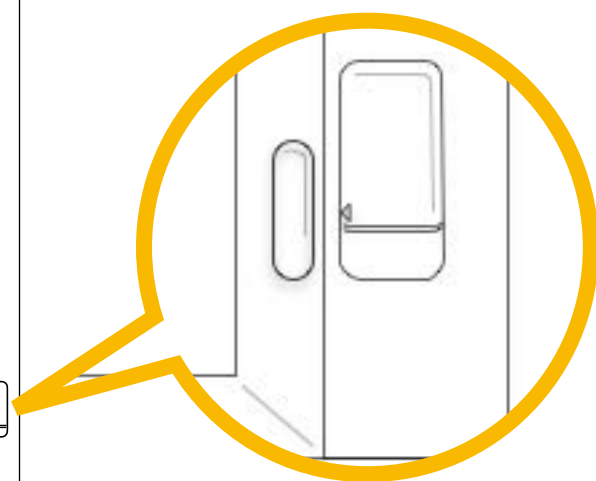

When installing the sensor on a window, place the “magnet” on the part of the window that moves, to reduce possibility of damage to the sensor as you open and close the window. If your window does not allow this kind of installation then you can reverse this configuration.

Standard install
magnet/sensor
orientation.

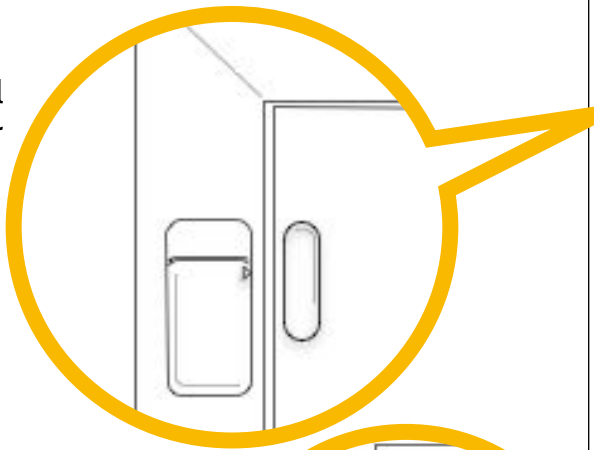

Alternate install
magnet/sensor
orientation.
(used when door trim does
not allow standard install)

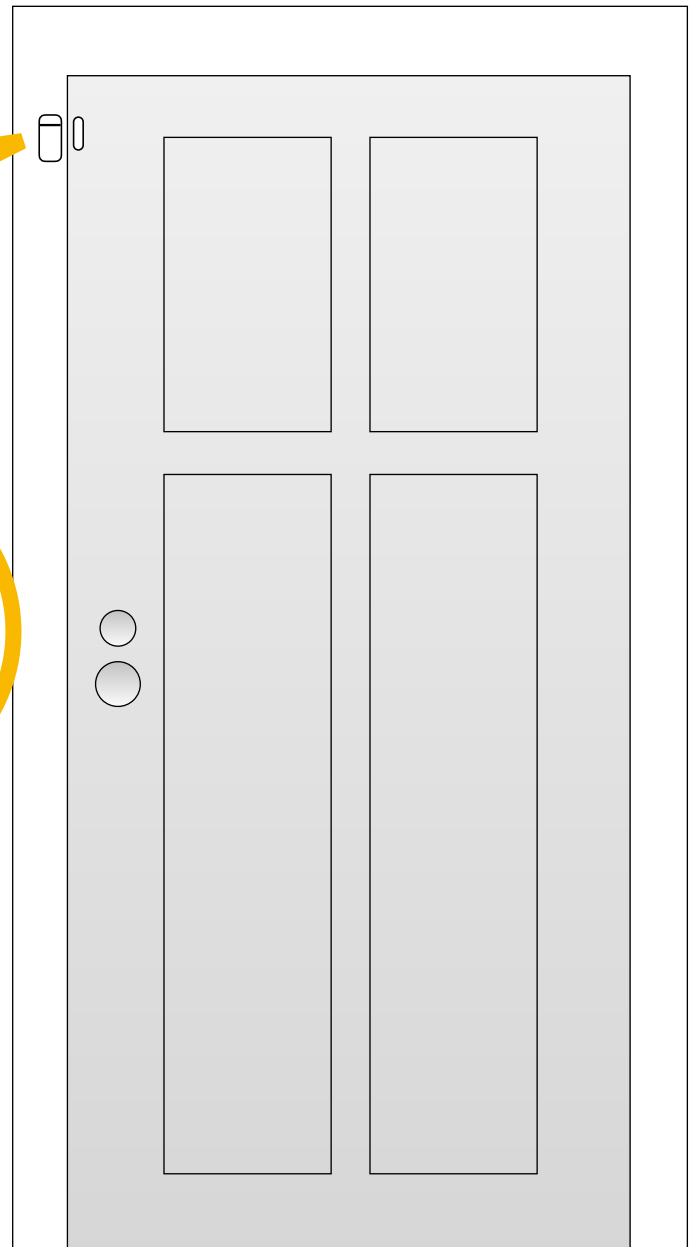
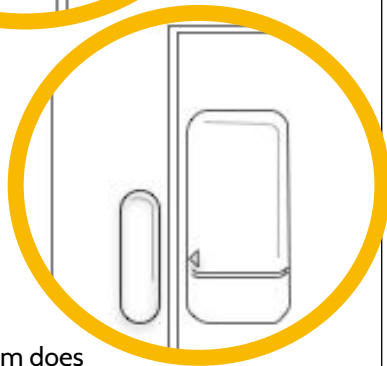

When installing the sensor on a door, place the “magnet” on the door and the sensor on the door frame. This helps to reduce the possibility of damage to the sensor as you open and close the door. If the trim around your door does not allow this kind of installation then you can reverse this configuration.



 **MOTION-S**

MOTION DETECTION

Your IQ Motion is an encrypted infrared sensor with a range of 25 feet. The motion detector is most effective when a person moves across its field of view, rather than towards the sensor. We recommend that all motions are installed at a height of 6.5 feet. Refer to the following pages for different installation options.

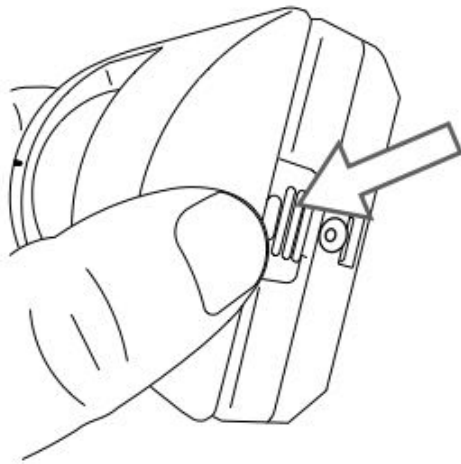

Open the device to remove the back plate.

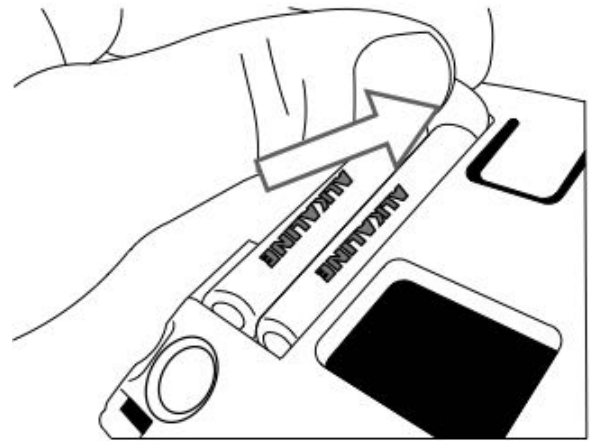

Remove the battery tab.

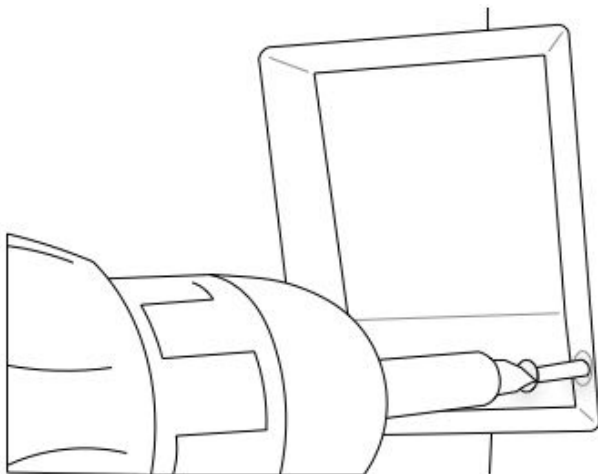

Secure the backplate to surface.*

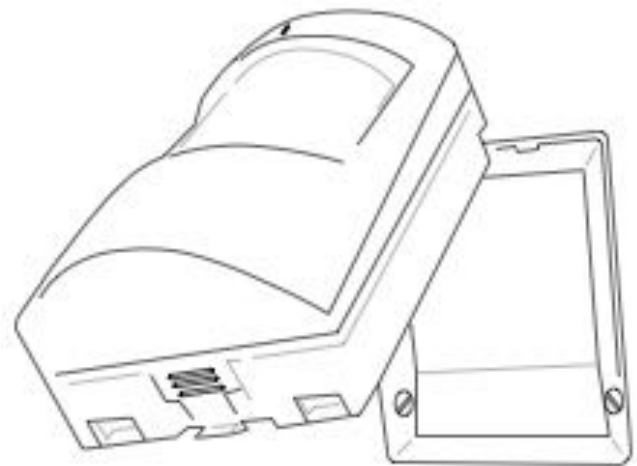

Re-install motion device to the backplate.

Have pets? By mounting the motion sensor flat against the wall you get more open air coverage within the room but less floor coverage, reducing the risk of false alarms.

Reduce False Alarms: When possible, avoid installing your motion sensor toward windows, as the heat or movement from outside may create false alarms.

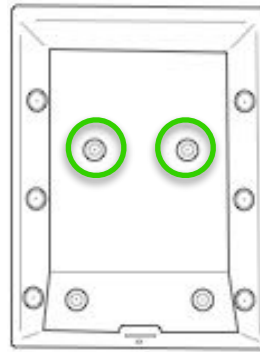

Install screws here

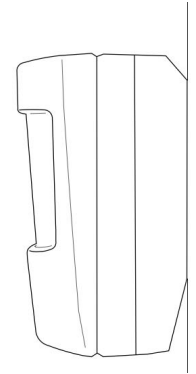

Finished install

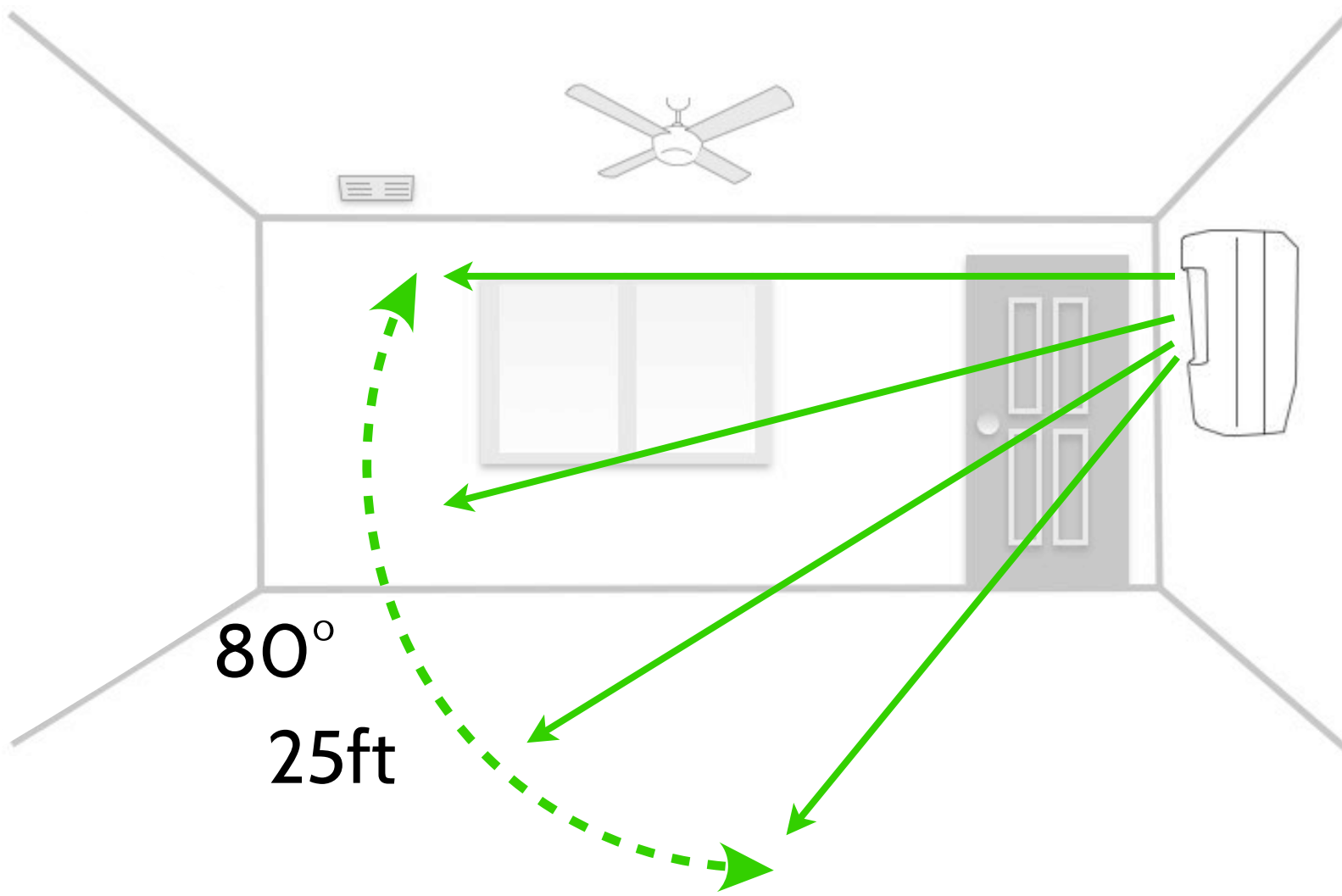

Corner mounting is the most common placement because it allows the sensor to provide wall to wall protection.

Have pets? By mounting the motion sensor flat against the wall you get more more open air coverage within the room but less floor coverage, reducing the risk of false alarms.

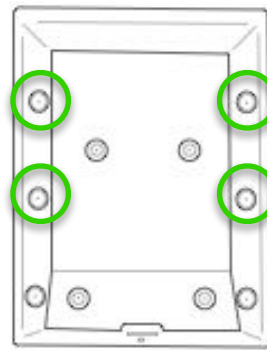

Install screws here

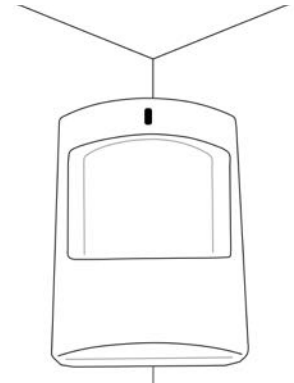

Finished install

Reduce False Alarms: When possible, avoid installing your motion sensor toward windows, as the heat or movement from outside may create false alarms.

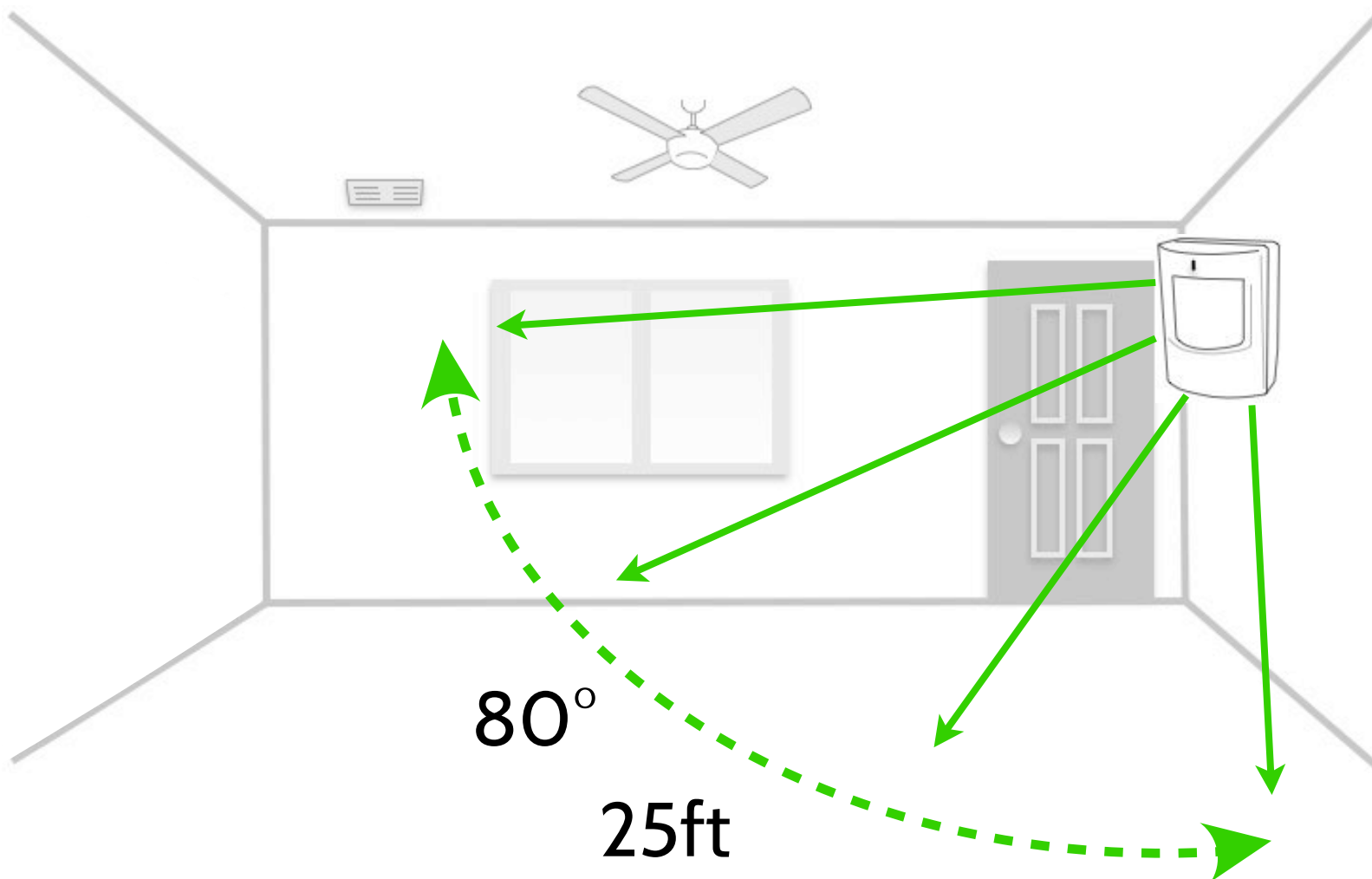

Angle Mount: pointing the motion downward gives you less open air coverage but more floor coverage. This is a great installation in homes without pets.

Reduce False Alarms: When possible, avoid installing your motion sensor toward windows, as the heat or movement from outside may create false alarms.

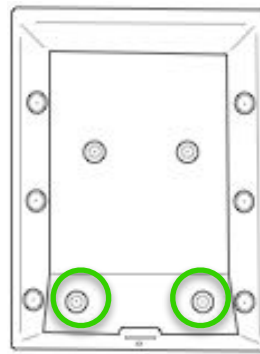

Install screws here

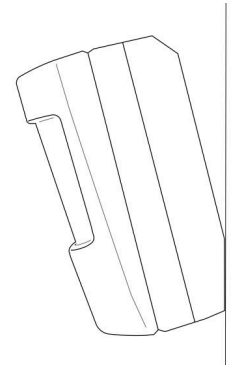

Finished install

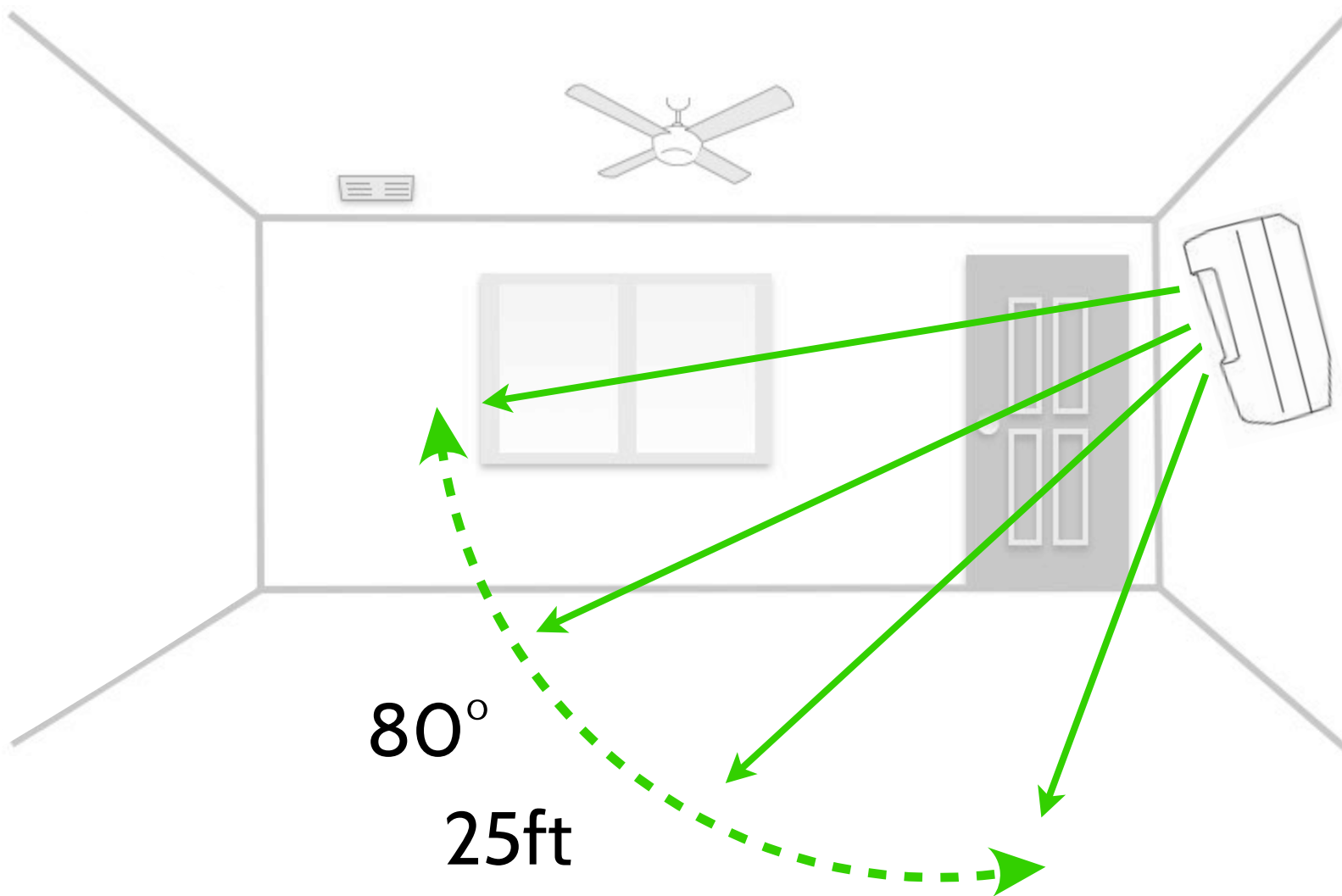

CORNER MOUNT: ANGLED DOWNWARD

Corner mounting is the most common placement because it allows the sensor to provide wall to wall protection. Angling downward is a great installation in homes without pets.

Reduce False Alarms: When possible, avoid installing your motion sensor toward windows, as the heat or movement from outside may create false alarms.

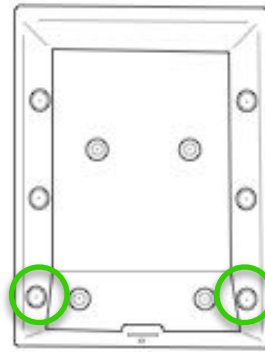

Install screws here

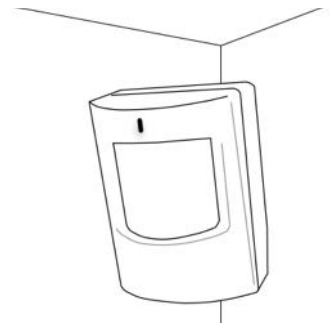

Finished install

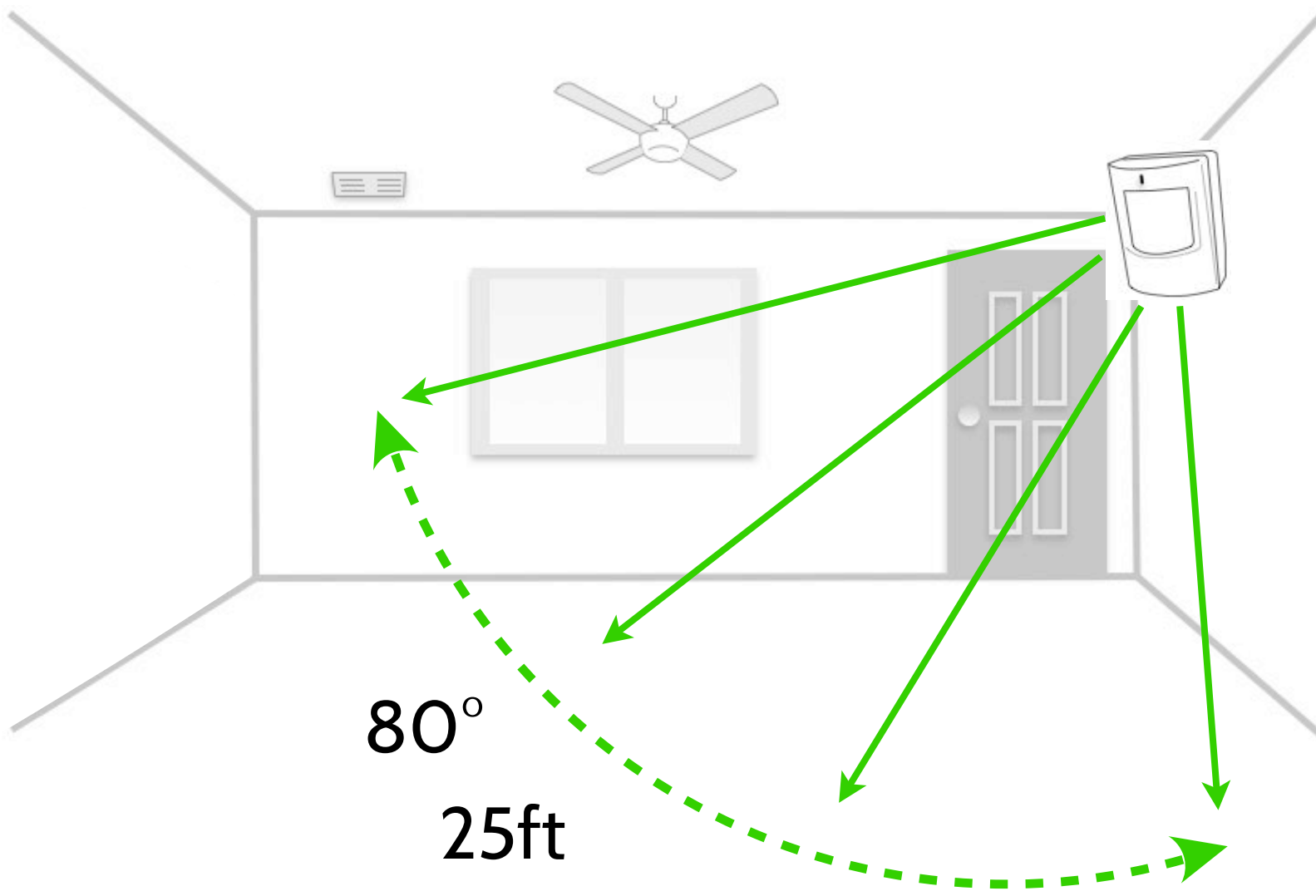



 **PANEL 2**

USING YOUR SYSTEM

Navigation

Move from page to page and access information on each page using finger touches, swipes, and scrolling.

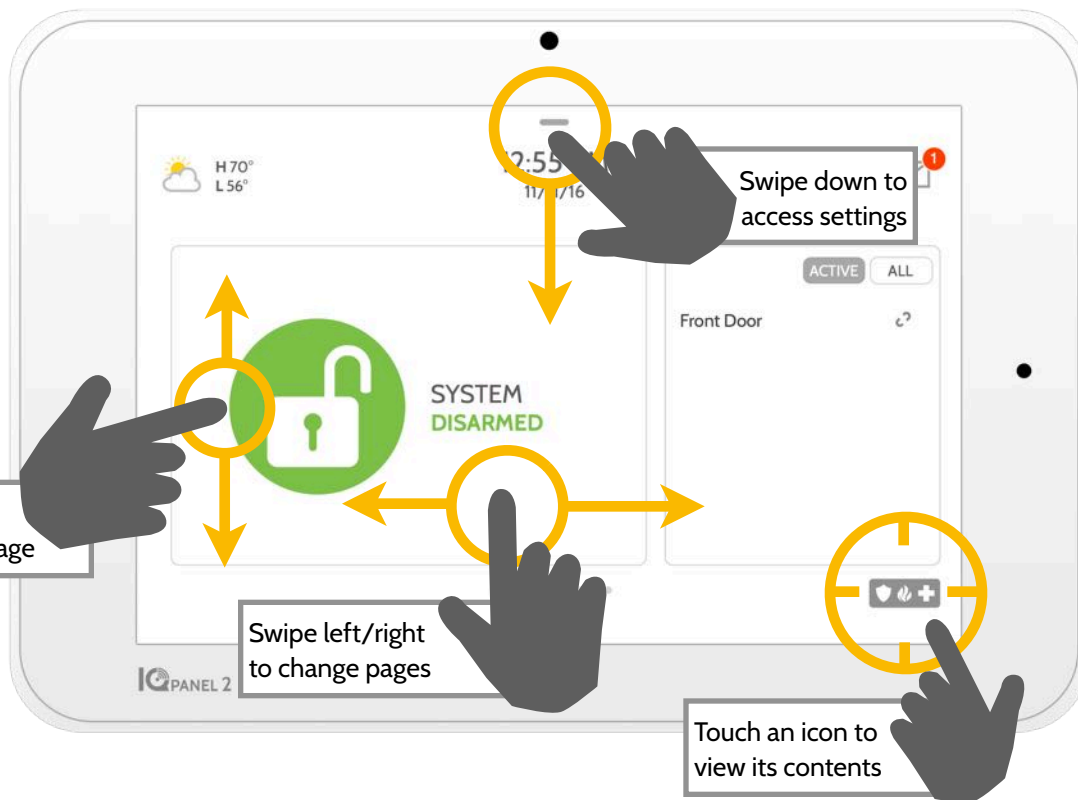

Dismiss

To dismiss a pop up when you are done, swipe left or right to dismiss.

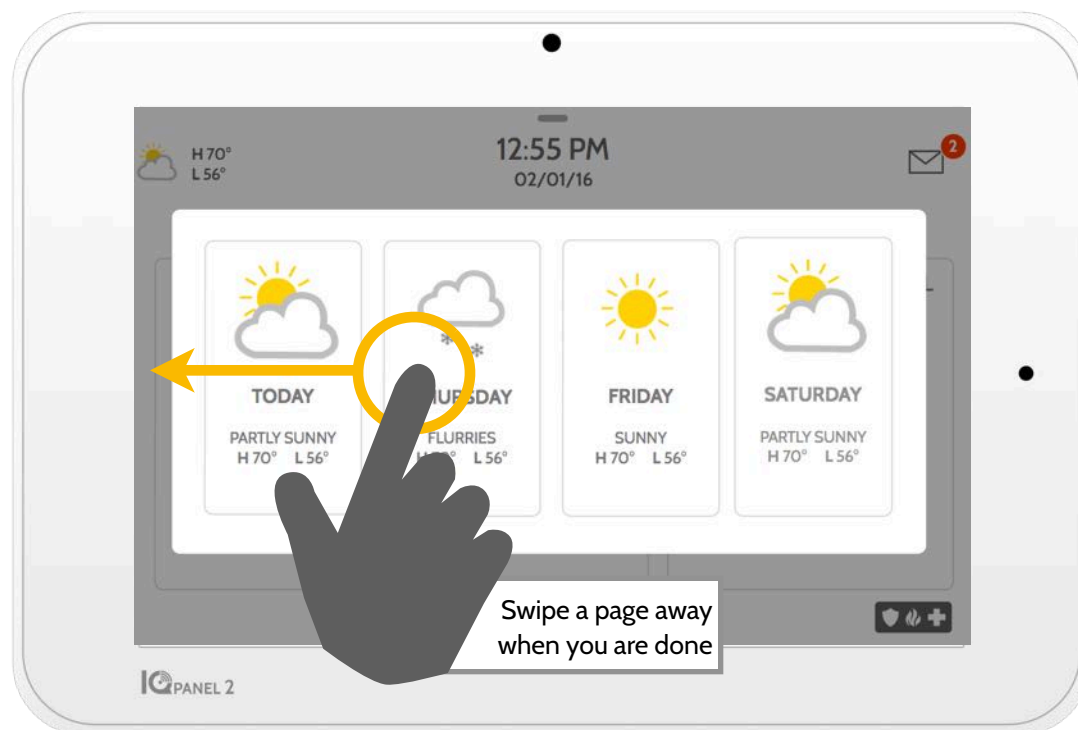

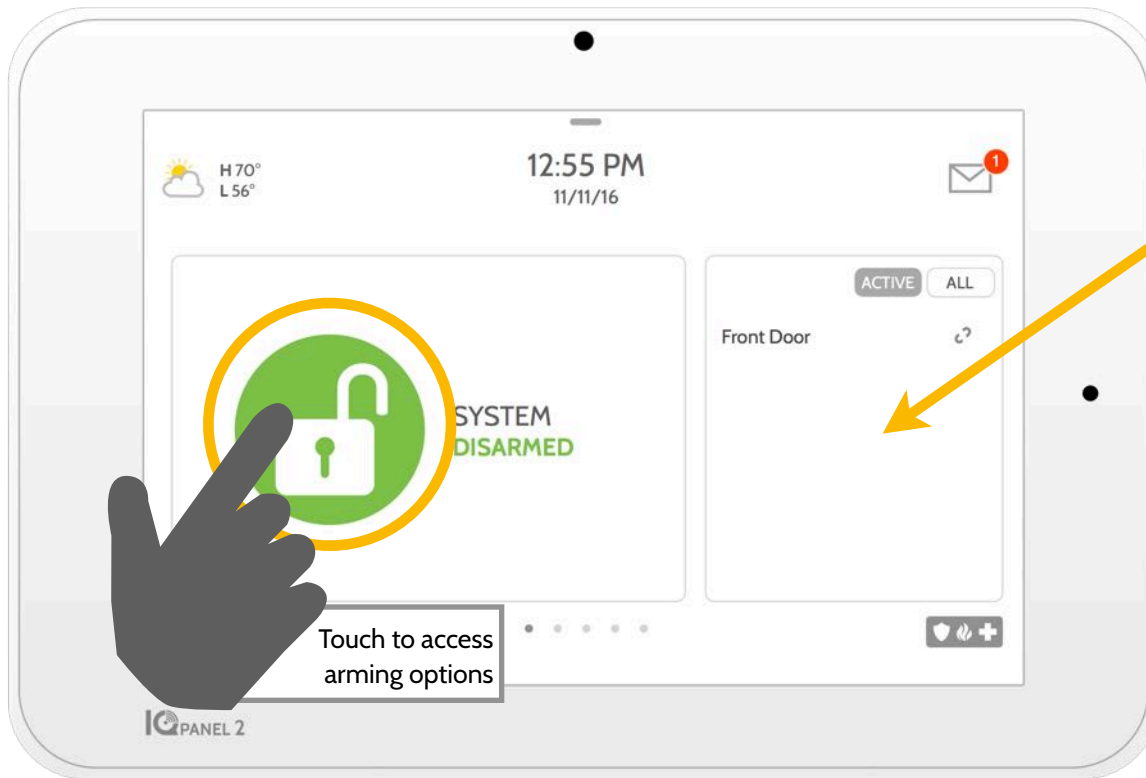

Touch to access arming options

Sensor List

Open or active sensors appear in a scrollable list on the right. Touch the icons in the upper right corner to switch your view to either "Active" or "All" sensors.

Sensor status:

- Open
- Closed
- Active
- Idle
- Unreachable
- Tampered

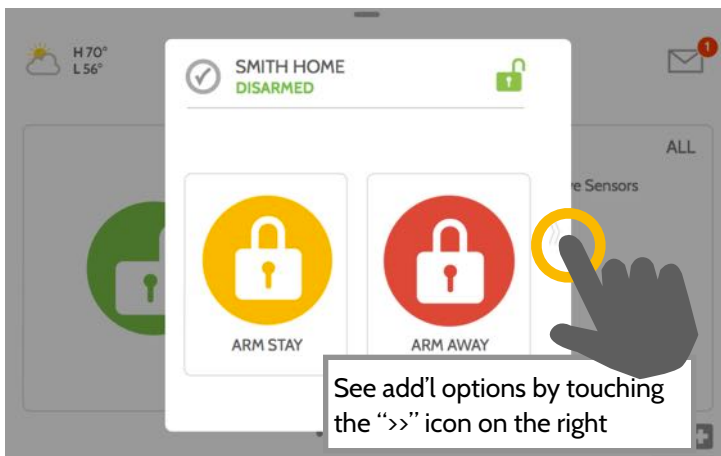

See add'l options by touching the ">>" icon on the right

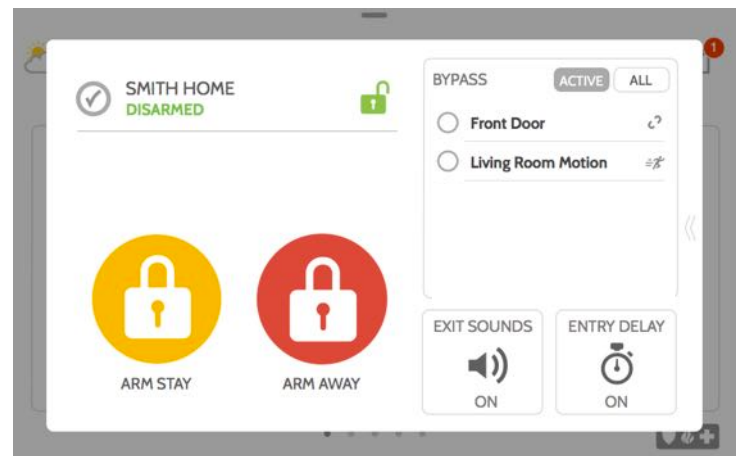

Arming Options

Quickly choose from "stay" or "away"



Arming Stay

Arms doors and windows only



Arming Away

Arms doors, windows and motions



Additional Options

View additional arming options by touching the ">>" icon on the right side

Additional Arming Options

Select these options before choosing your arming type



Bypass

Touch the circle next to a sensor to bypass it during the arming sequence



Exit Sounds

The panel beeps as the timer counts down. Silence these beeps before you choose the arming type.



Entry Delay

The panel will give you time to disarm once a "delay door" has been opened. Turn this off with a touch.

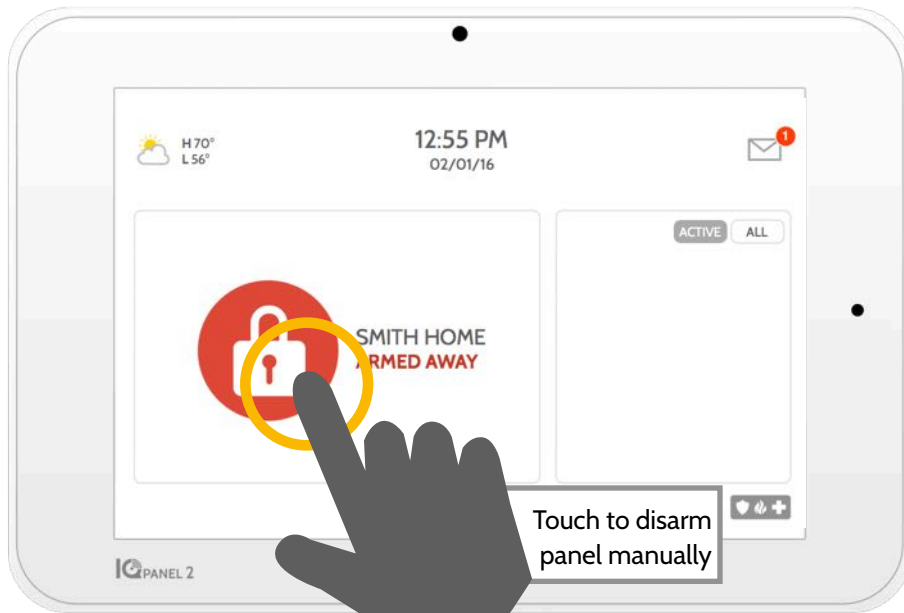

Disarming your System

When your system is armed, there are multiple ways to disarm:



Disarming Manually

To manually disarm your panel, touch the icon in the center of the screen. You will be prompted to enter a valid code. Failure to enter a valid code with the time required will trigger the alarm.



When someone manually disarms the panel the built in camera will take a photo and save it on the camera page along with the date, time, and name of the user.



Disarming Remotely

To remotely disarm your panel, login to your mobile app and touch the "disarm" icon.



Download the Alarm.com app in the App store or Google Play

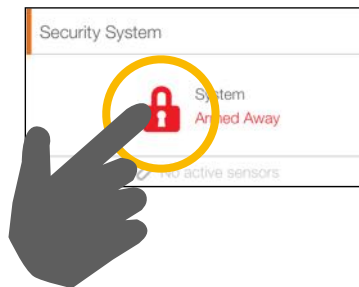

Disarming Automatically

You can connect your smartphone using Bluetooth and it will automatically disarm your IQ Panel from an "Armed Away" state when it comes within range. To connect a phone, follow the steps shown.



Bluetooth Touchless Disarming

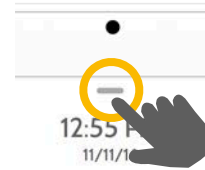

Step 1:
Swipe down to access settings tray



Step 2:
Touch "SETTINGS"



Step 3:
Touch "ADVANCED SETTINGS"



Step 4:
Enter your code



Step 5:
Touch "BLUETOOTH DEVICES"

Step 6:

Put your Bluetooth device in "pairing" mode.



Step 7:

Touch "ADD DEVICE" The panel will begin searching for new devices in range (It may take up to 60 seconds)

Step 8:

Select your device from the list



Step 9:
Touch "Pair"

Step 10:

When the messages appear on your phone and IQ Panel, ensure the numbers match and touch "Pair" on each.

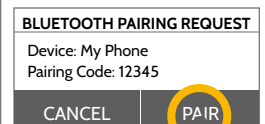
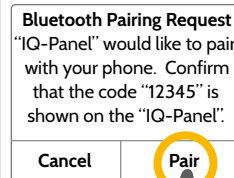

Cancel

Pair

CANCEL

PAIR

**You can connect up to five (5) smartphones for touchless disarming. You may need to enable this setting in your Bluetooth settings.*

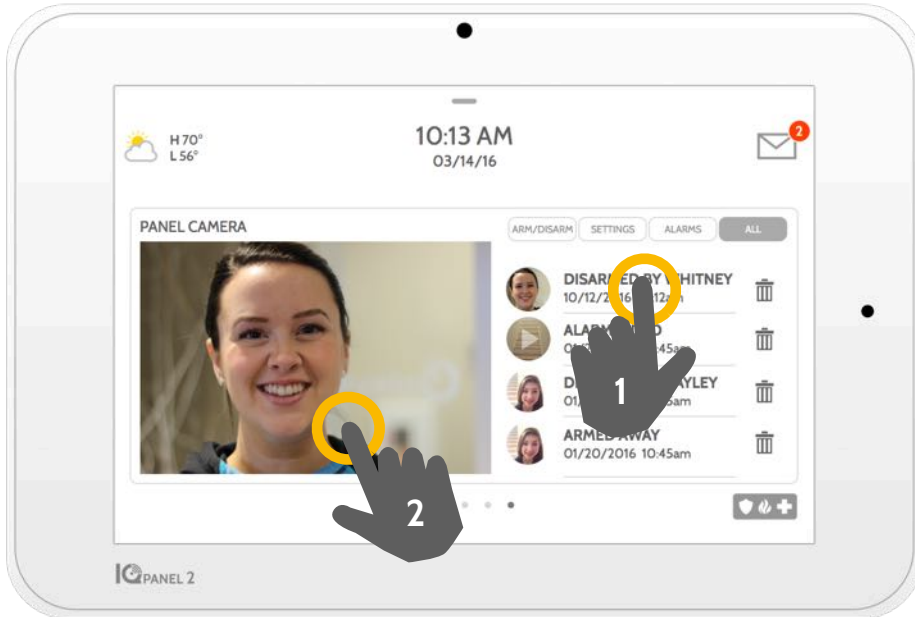

1- View Photo

Touch a photo thumbnail on the right to view it on the left.

2- Full Screen

Touch the photo on the left to view it full screen. Touch it again to return to the camera page.

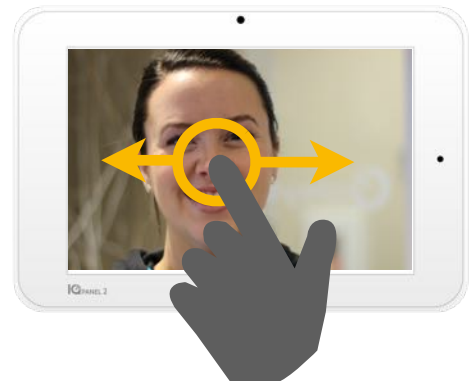

Note: While viewing photos full screen you can swipe left/right to view additional photos

Camera Page

Your IQ Panel's built in camera captures photos in a variety of situations:



Disarm Photos

When the panel is disarmed manually, the built in camera takes a photograph and saves it in the "ARM/DISARM" section. These photos are accompanied by the username of the individual who's code was used, the date, and the time.



Settings Photos

When someone attempts to access your panel settings with an invalid code, the built in camera takes a photograph and saves it in the "SETTINGS" section. These photos are accompanied by the date and time.



Alarm Photos

When the alarm is triggered, the built in camera takes a photograph and saves it in the "ALARMS" section.

Photos to your Phone

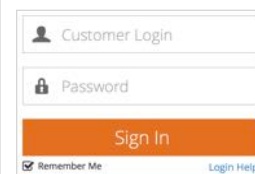

Alarm.com/Login
Get your username and password from your provider



Click the "Image Sensor" tab



Click "Rules & Alerts"

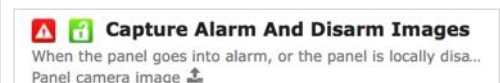

Click "Capture Alarm And Disarm Images" to customize

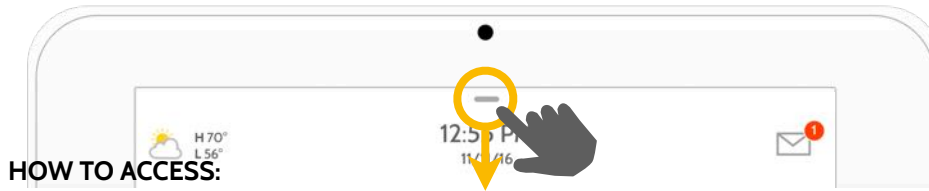

Settings Tray

Access common settings by swiping down from the top of the screen.

HOW TO ACCESS:

Security Status

See your panel's security status in the upper right. Touch it to go directly to the security page

Battery & Radios

Touch an icon to get more information
 -Battery level
 -Wi-Fi connection
 -Bluetooth status
 -LTE connection

Volume

Slide left/right to adjust the panel voice

Brightness

Slide left/right to adjust the screen brightness

Settings

Touch to access the full settings page. From there you can also access "Advanced Settings" (which will require a passcode)

Language

Touch to change panel language



Messages & Alerts

Touch to access the message center including your provider's contact information, video tutorials, and system messages

Photo Frame

Touch to access the photo frame where you can customize the panel's screensaver

Close Tray

Swipe up to close the tray

Clean Screen

Disables the screen for 30 seconds to allow you to clean it without accidentally touching anything. (Touch the "standby" button on the side of the panel to cancel)

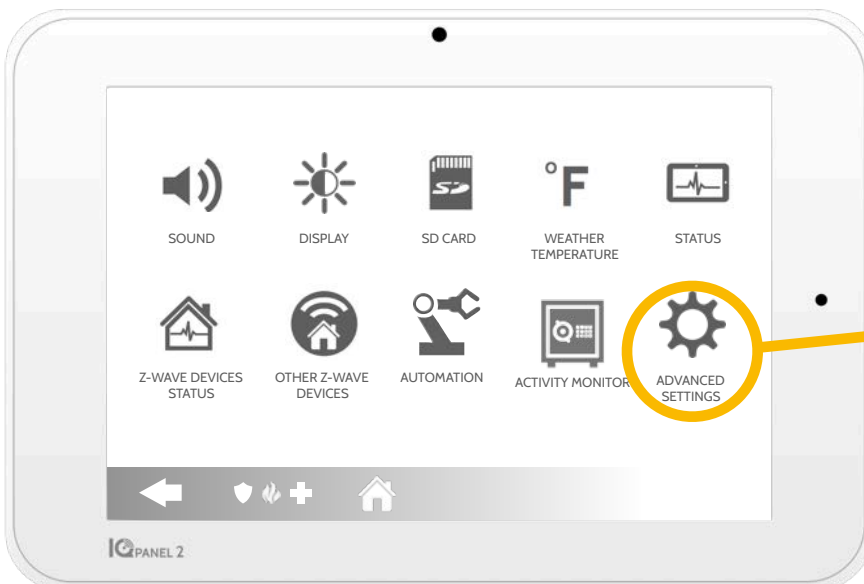

Settings Page

From here you can adjust individual sound settings, change your weather temperature from Fahrenheit to Celsius, see the status of your security and smarthome devices, and more.

Advanced Settings

Only the Master code can access this area. From here you can manage users, run system tests, reboot your system, connect Bluetooth and Wi-Fi and more.

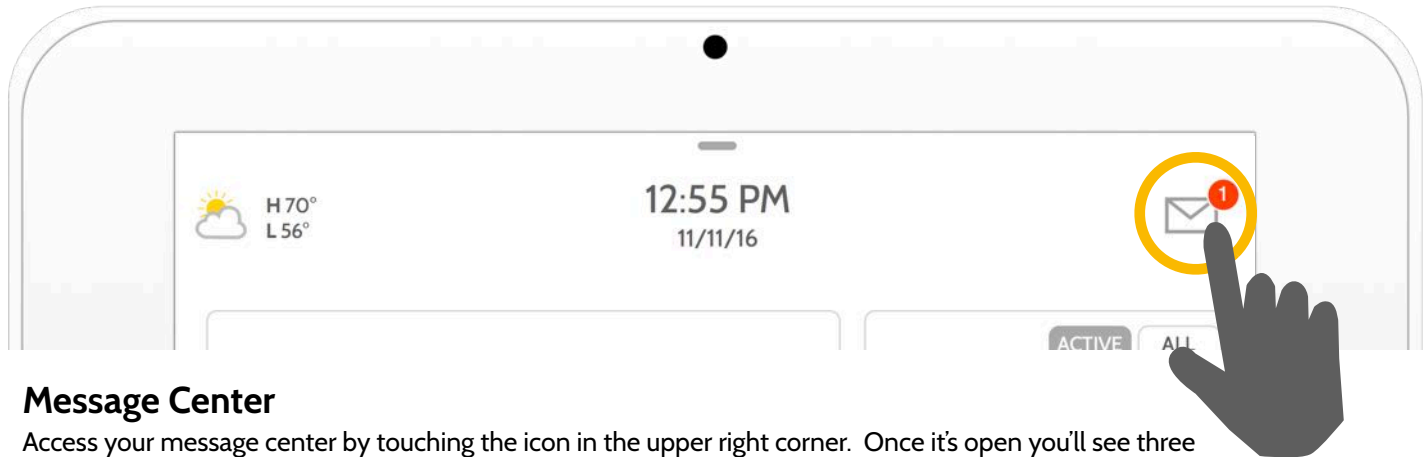

Message Center

Access your message center by touching the icon in the upper right corner. Once it's open you'll see three sections: Contact, Video Tutorials, and Messages/Alerts/Alarms

(Note: This icon may appear different than shown, depending on your provider's settings)



Contact

Easy access to your provider's contact information, including phone number, email, and website.



Video Tutorials

Watch videos to help you understand your system and service better.

To watch a video, touch a thumbnail. Video will begin playing automatically.

Video controls appear on screen. To exit, touch the "back" button.

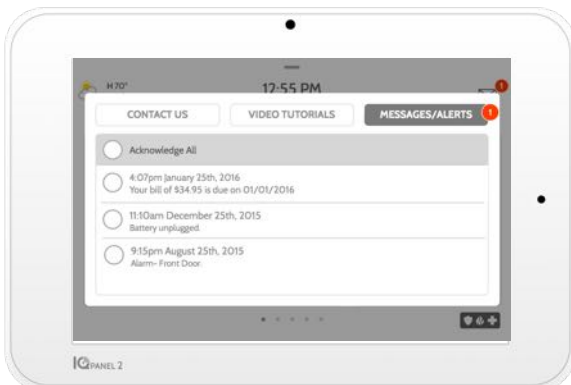

Messages/Alerts/Alarms

Get messages from your system like low battery alerts, alarms, and power failures. Messages from your provider will also appear here.

To dismiss, touch the circle to the left of the message and touch "OK" to remove it from your message center.

You can also remove all messages at once by touching "Acknowledge All"

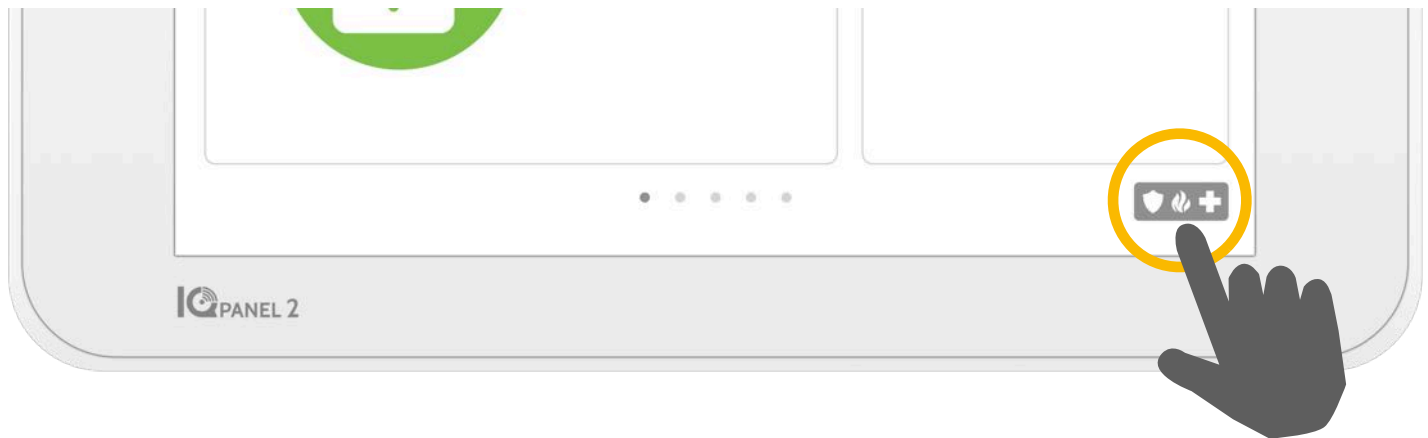

Emergency Panic

If you have a police, fire, or medical emergency and your system is not armed or a sensor has not been triggered, you can send a manual emergency panic by touching the icon in the bottom right corner and selecting the type of emergency you are experiencing. *(Note: based on your location, not all options may appear or be available to you.)*

There's a stranger in my backyard!

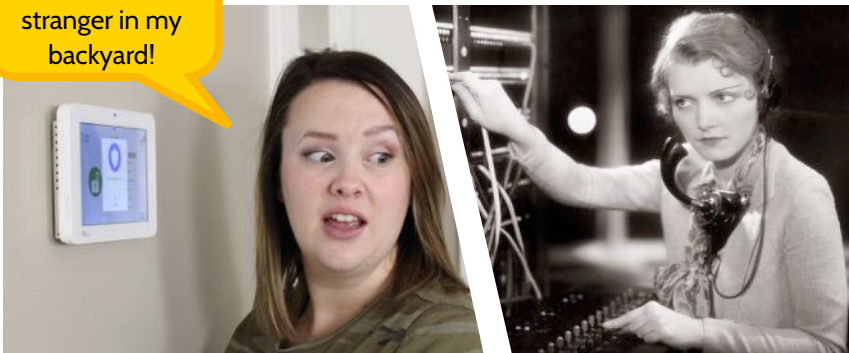

Two-Way Voice

If your provider offers Two-Way Voice service you'll be able to speak to the monitoring agent from the speakers and microphone built right into your panel.

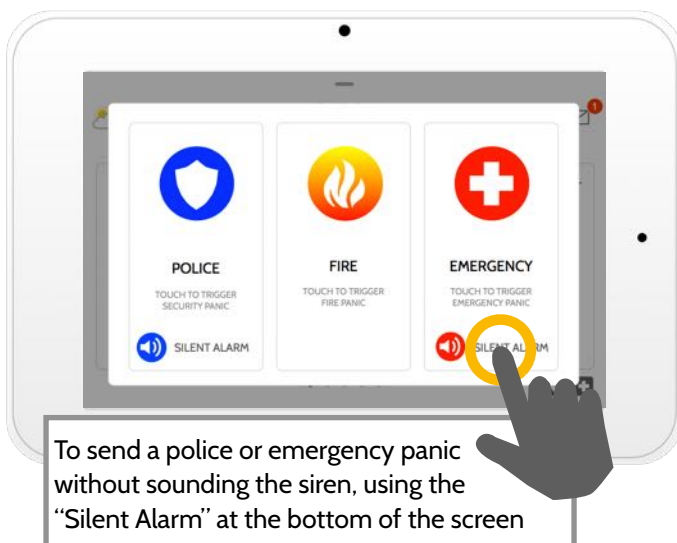

Alarm Types



Police: When touched it triggers the "Police" siren pattern and sends a police emergency signal to your provider's monitoring station.



Fire: When touched it triggers the "Fire" siren pattern and sends a fire emergency signal to your provider's monitoring station.



Emergency: When touched it triggers the "Emergency" siren pattern and sends an emergency signal to your provider's monitoring station.



Canceling an Emergency Panic
To cancel an emergency panic, touch the "cancel" button and enter a valid user code.

Photo Frame

When your panel is not in use, it turns into a customizable photo frame.

Settings

Inside settings you can choose whether you want photos or a weather clock, if you want the panel to turn itself off automatically in the evenings, and more.

Add Photos

To add your own photos:

- 1 Save your Photos onto a Micro SD card in a folder called "Photos"
- 2 Insert your SD card into the slot on the side of the panel

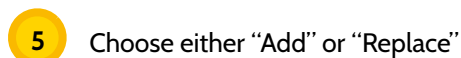
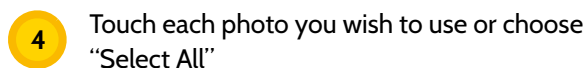
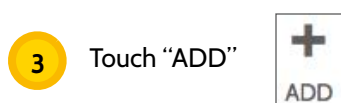

Add: Does not delete the photos already on the panel, only adds the photos you selected

Replace: Deletes the photos already on the panel and replaces them with the new photos you selected

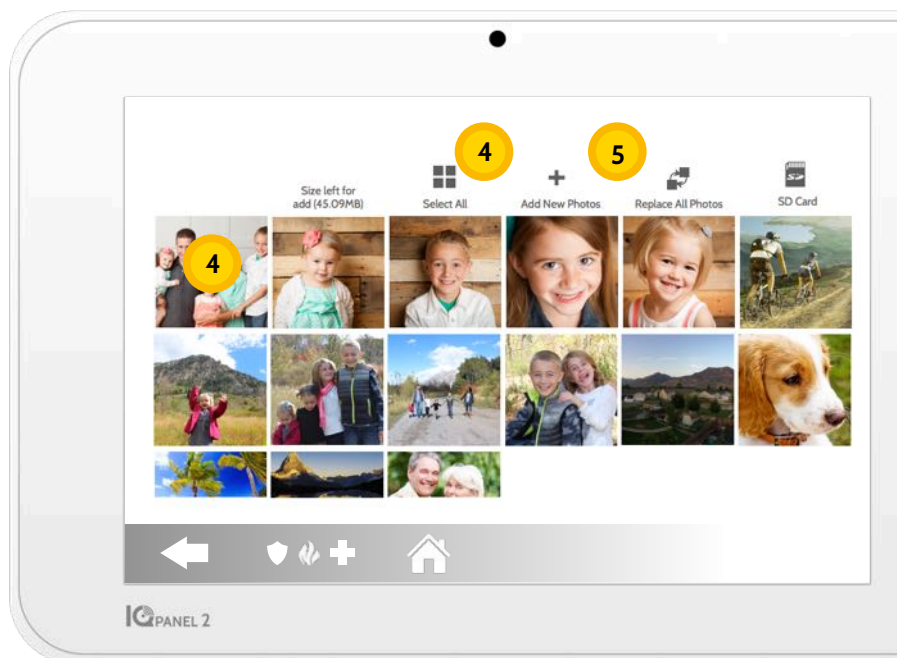
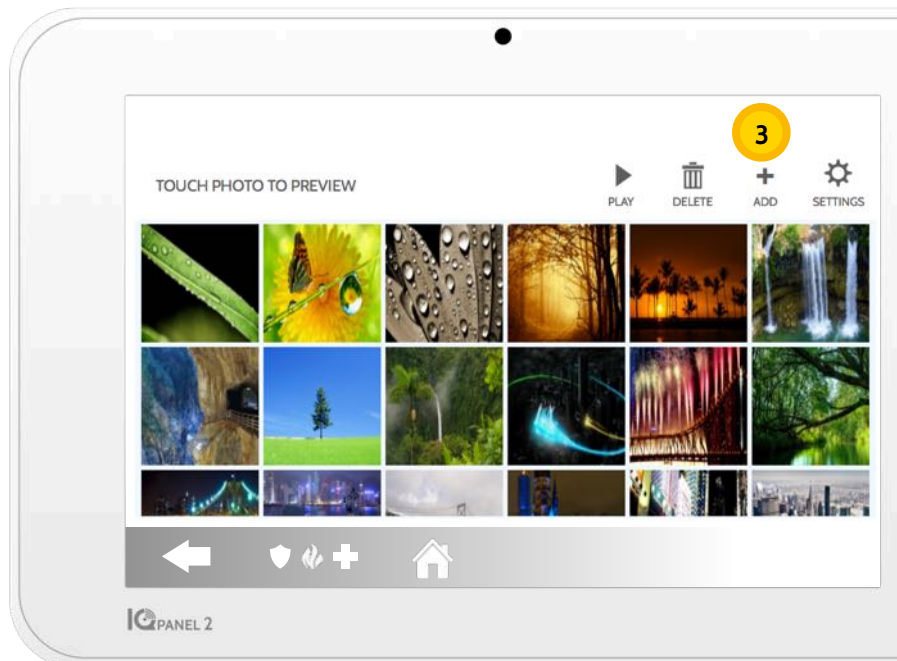
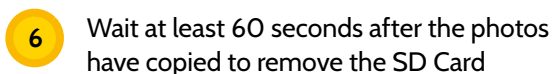



Delete

Touch a photo to select it. Touch "Delete" to delete it from your panel

User Types

You can add up to 242 users to your system, each with a custom name and access level you allow.

Master: Access panel functions, camera, and system settings.

User: Access panel functions, camera, but NOT system settings.

Guest: Used to give arm and disarm access to those users who will use the panel on a temporary basis



Notifications

By creating individual users, you can set up custom text notifications when they access or use your system, keeping you connected no matter where you are.

How to Add a New User

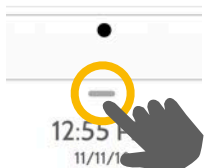

Step 1:
Swipe down to access settings tray



Step 2:
Touch "SETTINGS"



Step 3:
Touch "ADVANCED SETTINGS"



Step 4:
Enter your code*



Step 5:
Touch "User Management"



Step 6:
Touch "Add User"

Name	Enter Name
User Code	Please enter User Code
Confirm User Code	Please confirm User Code
Type	User
Expiration Date	Unlimited

Add User

Add User Screen

Once on the "Add User" screen you can create a custom name and user code and indicate whether you want this person to be a Master, User, or Guest.

*Default master code is 1234. For security purposes this code should be changed once the system has been installed in your home

How to Change Sensor Names

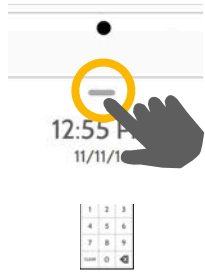

Step 1:
Swipe down to access settings tray



Step 2:
Touch "SETTINGS"



Step 3:
Touch "ADVANCED SETTINGS"



Step 4:
Enter master code

Step 5:
Select the sensor you want to customize



Step 6:
Touch "Edit Sensor"

Touch:
Touch the sensor name to bring up a pop-up box of preset names or select "custom description" to name the sensor yourself

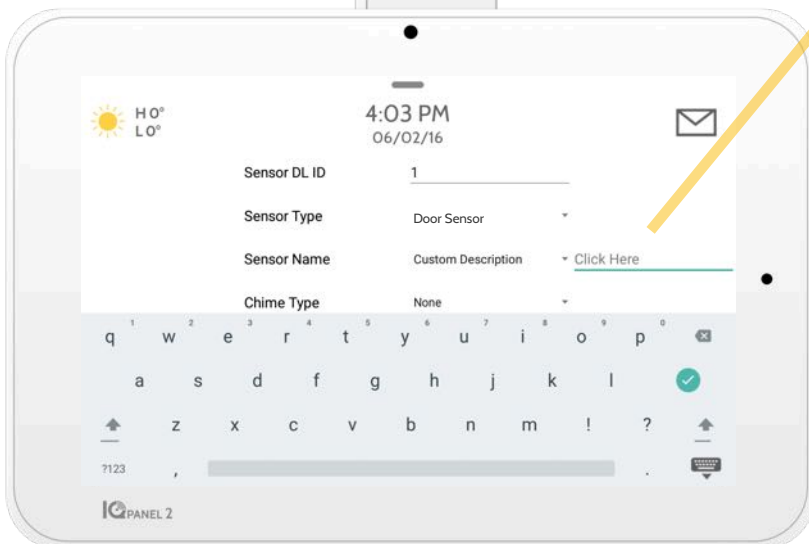

Custom Description:

Type in any name of up to 24 characters of letters and numbers for a more customized experience



Reminder:

Be sure to touch the save button to ensure your sensor changes are saved

Testing Regularly

You should test your system regularly to ensure it is operating at peak efficiency. The IQ Panel has a number of tests built in that are easy to perform:



Wi-Fi Test

Run this test every 30 days or if the IQ Panel's Wi-Fi connection seems to be failing.



Sensor Test

Run this test every 30 days. As you start the test, open and close your doors, windows, and move in front of your motion sensors to ensure they work as expected.



Cellular/LTE Test

Run this test if your panel seems to have lost it's ability to send and receive signals.



Image Sensor Config

Run this test if your image sensors stop working



Z-Wave Test

A series of Z-Wave tests to optimize your smarthome network. "Reconfigure network" is your most useful test, repairing your network for you.



Dual Path Test

Run this test if your panel seems to have lost it's ability to send and receive signals.



Panel Glass Break Test

Use this to test your panel's microphone



Panel Test

Use this every 30 days to test a variety of panel functions

How to Access System Tests

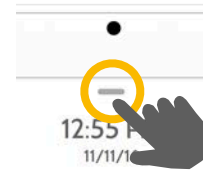

Step 1:

Swipe down to access settings tray



Step 2:

Touch "SETTINGS"



Step 3:

Touch "ADVANCED SETTINGS"



Step 4:

Enter your master code*



Step 5:

Touch "System Tests"

Encounter a Problem?

If you encounter a problem with your system, contact your provider right away.



Touch "Message Center" in the upper right corner of your panel to get your provider's contact information

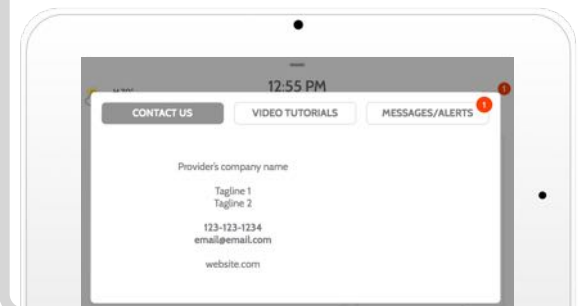

*Default master code is 1234. For security purposes this code should be changed once the system has been installed in your home