



E-II-YDDN-0907

ENGLISH

# INSTALLATION MANUAL

**DIGITAL SCROLL SERIES  
DUCT TYPE INDOOR UNIT**

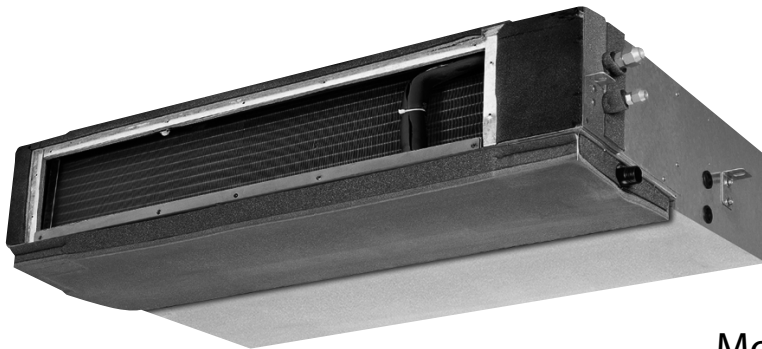

Models:

YDDN-22C(A/B)15A

YDDN-28C(A/B)15A

YDDN-36C(A/B)15A

YDDN-45C(A/B)15A

YDDN-56C(A/B)15A

YDDN-71C(A/B)15A

YDDN-80C(A/B)15A

YDDN-90C(A/B)15A

YDDN-112C(A/B)15A

YDDN-140C(A/B)15A

For correct installation, read this manual before starting installation.



Only trained and qualified service personnel should install, repair or service air conditioning equipment. Users should not install the air conditioner by themselves.

All pictures are only sketches. If there is any difference between pictures in this manual and the actual shape of the air conditioner you purchased, the actual shape shall prevail.

## INSTALLATION INFORMATION

- This installation manual is for the indoor unit.
- Please refer to the outdoor unit installation manual to install the outdoor unit.
- The indoor unit and the outdoor unit should not share one power supply.

## ACCESSORIES

Name of Accessories	Q'ty	Outline	Usage
Installation manual	1	(This manual)	_____
Electric throttle part	1	_____	_____
Pipe insulation material	2		Heat insulation
Accessory drain pipe	1		To connect drain pipe
Adhesive tape for seal	1		To connect drain pipe

## INSTALLATION PLACE

### Under the high humidity condition

According to the condensing dew condition to do the test, no abnormal phenomenons happen. But if the unit is running continuously under the following high humidity condition, the water drop may be caused. Especially in the season of plum rains( the dew temp. is above 23°C).

- 1) Install in the tile roof ceiling.
- 2) Install in the flagstone roof ceiling.
- 3) Install in the ventilated space between the ceiling and floor.
- 4) Cooking location.

Condensing dew test condition		
Indoor side	27°C	Dry bulb temp.
	24°C	Wet bulb temp.
Air volume	Weak air	
Running time	4 hours	

## INSTALLATION PLACE

### CAUTIONS

1. Please avoid installing in the following places
  - A place with flammable gas or material.
  - A saline place such as a seashore vicinity.
  - A place with sulphur gas.
  - A place with oil gas, such as kitchen.
  - A place with high humidity air.
  - An unbearable place.
  - A place where high-frequency waves are generated.
2. Please comply with the related national electric standard to make electric insulation for construction and metal parts of the air-conditioner.
3. Please choose the place where the ventilation is perfect.

## DRAIN PIPE

When connecting the pipe, please use the sealing material and pipe glove.

### CAUTION

- The drain pipe of indoor unit must be heat insulated, or it will condense dew, as well as the connections of the indoor unit.
- Hard PVC binder must be used for pipe connection, and make sure there is no leakage.
- With the connection part to the indoor unit, please note not to impose pressure on the side of indoor unit pipes.
- The declivity of the drain pipe downwards should not be over 1/100, and no winding and bending.
- The total length of the drain pipe when pulled out breadthwise shall not exceed 20m. When the pipe is overlong, a bracket must be installed to prevent winding.
- Refer to the following figures to install the pipes.

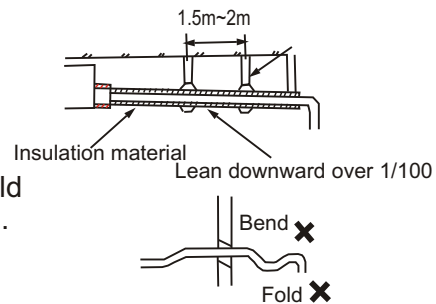

## Drainage test

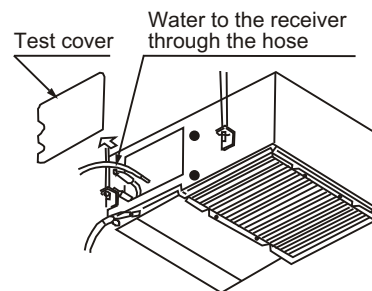

# INSTALL INDOOR UNIT

## Install the 10 hanging screw bolts.(4 pieces)

- Please refer to the following figure for the hanging screw bolts distance.
  - Please install with 10 hanging screw bolts.
  - The handling to the ceiling varies from the constructions, consult the construction person for the specific condition.
1. The size of the ceiling to be handled----- Do keep the ceiling flat. Consolidate the roof beam for possible vibration.
  2. Cut off the roof beam.
  3. Strengthen the place that has been cut off, and consolidate the roof beam.
- After the selection of installation location, position the refrigerant pipes, drain pipes, indoor & outdoor wires to the connection places before hanging up the machine.
  - The installation of hanging screw bolts.

### WOODEN CONSTRUCTION

Put the square timber over the roof beam, then install the hanging screw bolts.

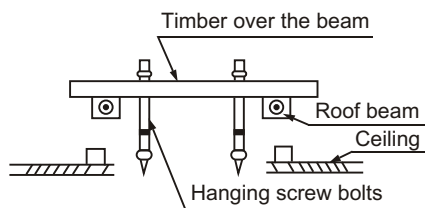

### FOR ORIGINAL CONCRETE BRICKS

Install the hanging hook with expansible bolt into the concrete deep to 45~50mm to prevent loose.

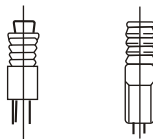

### NEW CONCRETE BRICKS

Inlaying or embedding the screw bolts.

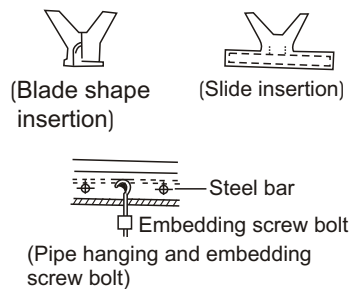

### STEEL ROOF BEAM STRUCTURE

Install and use directly the supporting angle steel.

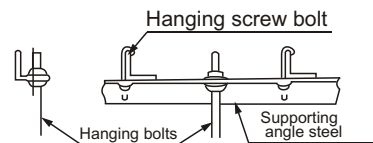



Model(YDS)	A	B	C	D	E	F	G	H	I	J	K	L	M	N	P
22~36C(A/B)15A	550	600	580	600	630	19.0	9.53	317	10	0	—	112.5	0	1	4
45~80C(A/B)15A	1000	1050	1030	1050	1080	19.0	9.53	252	24.4	580	290	293.8	2	3	3
90~140C(A/B)15A	1350	1400	1380	1400	1430	19.0	9.53	252	35	930	310	293.8	3	4	4

## Duct Connection

The length of the duct should according to the static pressure outside the unit 39.2Pa (max. 98Pa ).

### ◆ Panel installation

#### 1. Unload the inner frame.

- Slide the knob, release the buckle from the outside frame hole, then unload the inner frame.

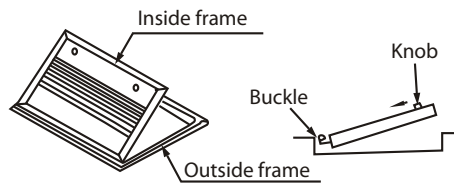

#### 2. Hang the outside frame on the main body with face down. (4 places at 4 corners).

- Hang the belt on the hook of the main body .

Note : The signal wire of the remote control receiver must be drawn out through the canvas duct.

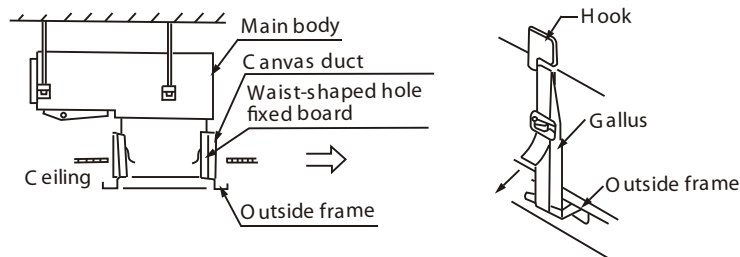

#### 3. Fix the outside frame and the canvas duct with screws.

- Screw must be fixed from the bottom to the top.

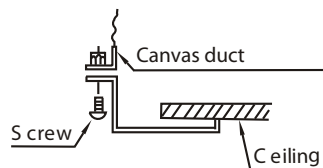

#### 4. Hang up the outside frame until it sticks to the ceiling tightly.

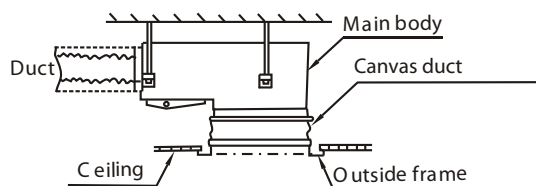

5. Fix the main body and the outside frame with the fix board of waist-shape hole (in two places).

- Hang one side of the fix board of the waist-shaped hole on the hook of the main body.
- Tighten the other side of the board with screw to the outside frame.
- Cut off the surplus part of the board with pliers.
- Bend the top of the broken end.

Note : when hanging up the outside frame with the fix board of waist-shaped hole and the belt, stick the outside frame tightly to the ceiling and fix it.

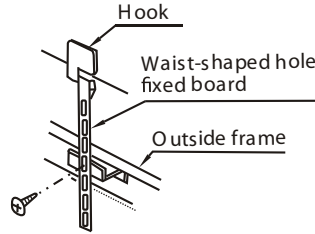

6. Install the inner frame on the outside frame (the inverse sequence of unloading the inner frame).

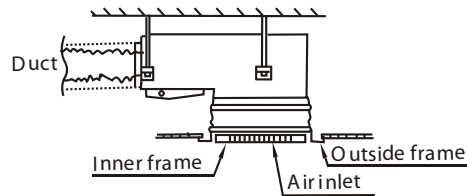

The figure is the standard system.(Air-in down)

## REFRIGERANT PIPE INSTALLATION

### Allowed Length and Drop of Pipes

Requirements are different when installing the outdoor unit, please refer to the outdoor unit installation manual for the detailed information.

### SIZES OF THE PIPES

	R22/R407C	R410A	R410A
Gas	19	12.7	15.9
Liquid	9.53	6.35	9.53
Models	All	22-36	45-140

**Airtight test****Air purge with vacuum pump****Refrigerant amount to be added**

Please refer to the outdoor unit installation manual to do the above tests.

**Leakage Test**

Please do the leakage test for the pipe connection and valve cover.(R407C)

**Heat Insulation**

Heat insulation for the gas and liquid pipe separately.

Heat insulation should be fully and carefully done, because the liquid side pipe and gas side pipe are easy to condense water due to low temperature when cooling.

- Heat proof above 120°C material should be used at the gas side pipe.
- The indoor unit connection parts should be no-gap heat-insulated with the attached heat insulation materials.

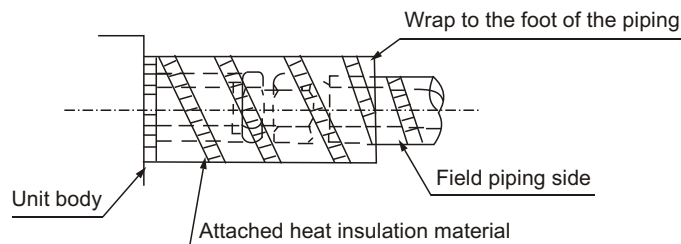
**ELECTRIC WIRING****CAUTION**

- The electric wiring should according to the national electric regulations.
- Please put the refrigerant pipe system and the indoor/outdoor unit connection wiring system in one system.
- The current leakage protection switch must be installed.
- Grounding must be properly done.
- Use wire clamp to fix the wires and the terminal block after connection.
- Connect the indoor unit to power only after the refrigerant has been vacuumed.



## Wiring Specifications

Model	Items	Indoor Unit Power				Controlling Wire		Ground Wire	
		Power	Manual Switch		Power Cord		Indoor/Outdoor Unit Signal Wire		
			Capacity	Fuse	Below 20m	Below 50m	Quantity		Diameter
YDDN-22~140C(A/B)15A	Single Phase 220-240V~ 50Hz	15A	15A	Twisted-pair 2mm <sup>2</sup>	Twisted-pair 4mm <sup>2</sup>	2	Not longer than 1500m 1.0mm <sup>2</sup>	Single-Wire 1.5mm	

### Indoor unit power supply

- The indoor unit power source should not be shared with the outdoor unit.
- The indoor units that connect to the same outdoor unit should use the same power source, creepage protector and main switch.

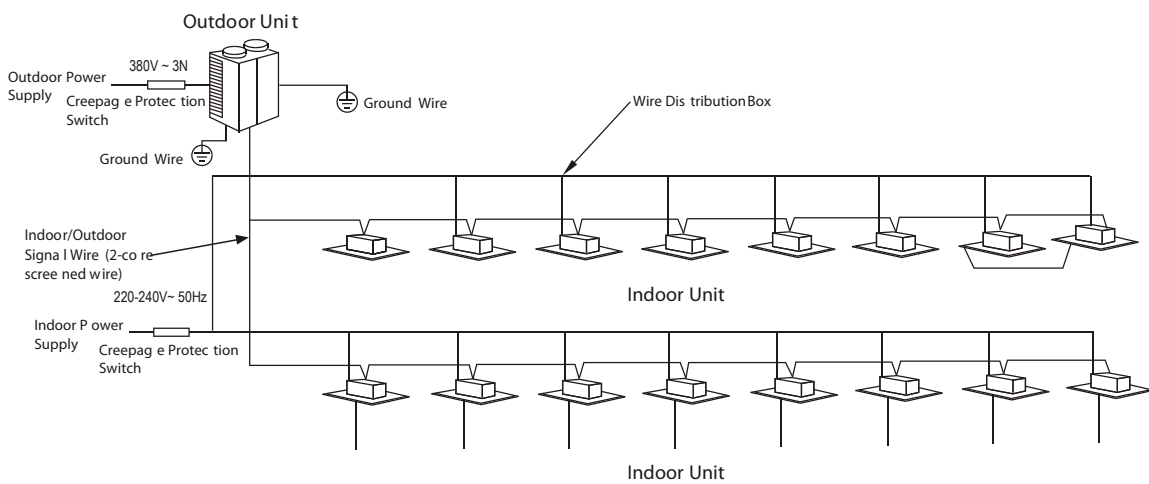

## CONTROL

- As per the different usages to set the moving switch on the PCB in the electric control box of indoor unit.
- After the setting, be sure to cut down the main power supply switch, then turn it on again
- Setting would be invalid without disconnecting the power.

Please number the indoor units during the installation. For example, for the first outdoor unit, the number of the first indoor unit is 1-1, the second indoor unit is 1-2, and the set address is 1 and 2 respectively, the others is analogical.

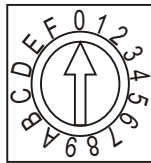

ENC1

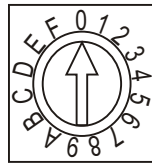

ENC2

ENC1	TOGGLE SWITCH	FOR SETTING ADDRESS
'0-F' show the address '0-F' respectively, that is, '0-15' indoor unit (together 16 units), and the others follow the analogy. If two addresses are the same in one system, the abnormal operation will occur.		

ENC2	Toggle switch	For set horsepower
Note: The horsepower has been set before leaving the factory, anyone can't modify it except the maintenance person.	Code	Capacity(Horsepower)
	0	2200W(0.8HP)
	1	2800W(1.0HP)
	2	3600W(1.2HP)
	3	4500W(1.5HP)
	4	5600W(2.0HP)
	5	7100W(2.5HP)
	6	8000W(3.0HP)
	7	9000W(3.2HP)
	8	11200W(4.0HP)
9	14000W(5.0HP)	

# TROUBLESHOOTING

No.	Type	Contents	LED Lamp flash	Remarks
1	Malfunction	The evaporator sensor check point is abnormal, or room temperature sensor is abnormal.	Run lamp flashes at 2.5Hz.	After the malfunctions disappear, it restores automatically.
2	Malfunction	Indoor/outdoor unit communication is abnormal.	The timer lamp flashes at 2.5Hz.	After the malfunctions disappear, it restores automatically.
3	Malfunction	Condenser sensor check point is abnormal or outdoor temperature sensor is abnormal.	All the indoor alarm lamps flash at 0.5Hz.	After the malfunctions disappear, it restores automatically.
4	Malfunction	Water level switch is abnormal	Alarm lamp flashes at 2.5Hz.	If the malfunctions can't be solved in three min. all the indoor alarm lamps flash at 0.5Hz. Turn off the power to restore.
5	Alarm	Mode conflict	Defrost lamp flashes at 2.5Hz.	When the indoor unit turns to heating mode or is turned off, the alarm will disappear.

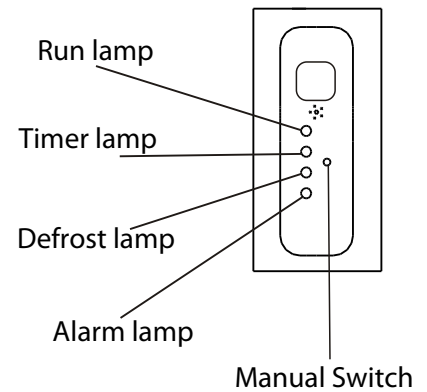

## DE - COMMISSIONING DISMANTLING & DISPOSAL

This product contains refrigerant under pressure, rotating parts, and electrical connections which may be a danger and cause injury!

All work must only be carried out by competent persons using suitable protective clothing and safety precautions.



Read the Manual



Risk of electric shock



Unit is remotely controlled  
and may start without warning

1. Isolate all sources of electrical supply to the unit including any control system supplies switched by the unit. Ensure that all points of electrical and gas isolation are secured in the OFF position. The supply cables and gas pipework may then be disconnected and removed. For points of connection refer to unit installation instructions.
2. Remove all refrigerant from each system of the unit into a suitable container using a refrigerant reclaim or recovery unit. This refrigerant may then be re-used, if appropriate, or returned to the manufacturer for disposal. **Under No circumstances should refrigerant be vented to atmosphere.** Where appropriate, drain the refrigerant oil from each system into a suitable container and dispose of according to local laws and regulations governing disposal of oily wastes.
3. Packaged unit can generally be removed in one piece after disconnection as above. Any fixing down bolts should be removed and then unit lifted from position using the points provided and equipment of adequate lifting capacity. Reference MUST be made to the unit installation instructions for unit weight and correct methods of lifting. Note that any residual or spilt refrigerant oil should be mopped up and disposed of as described above.
4. After removal from position the unit parts may be disposed of according to local laws and regulations.