

BUNN®

AXIOM® SERIES

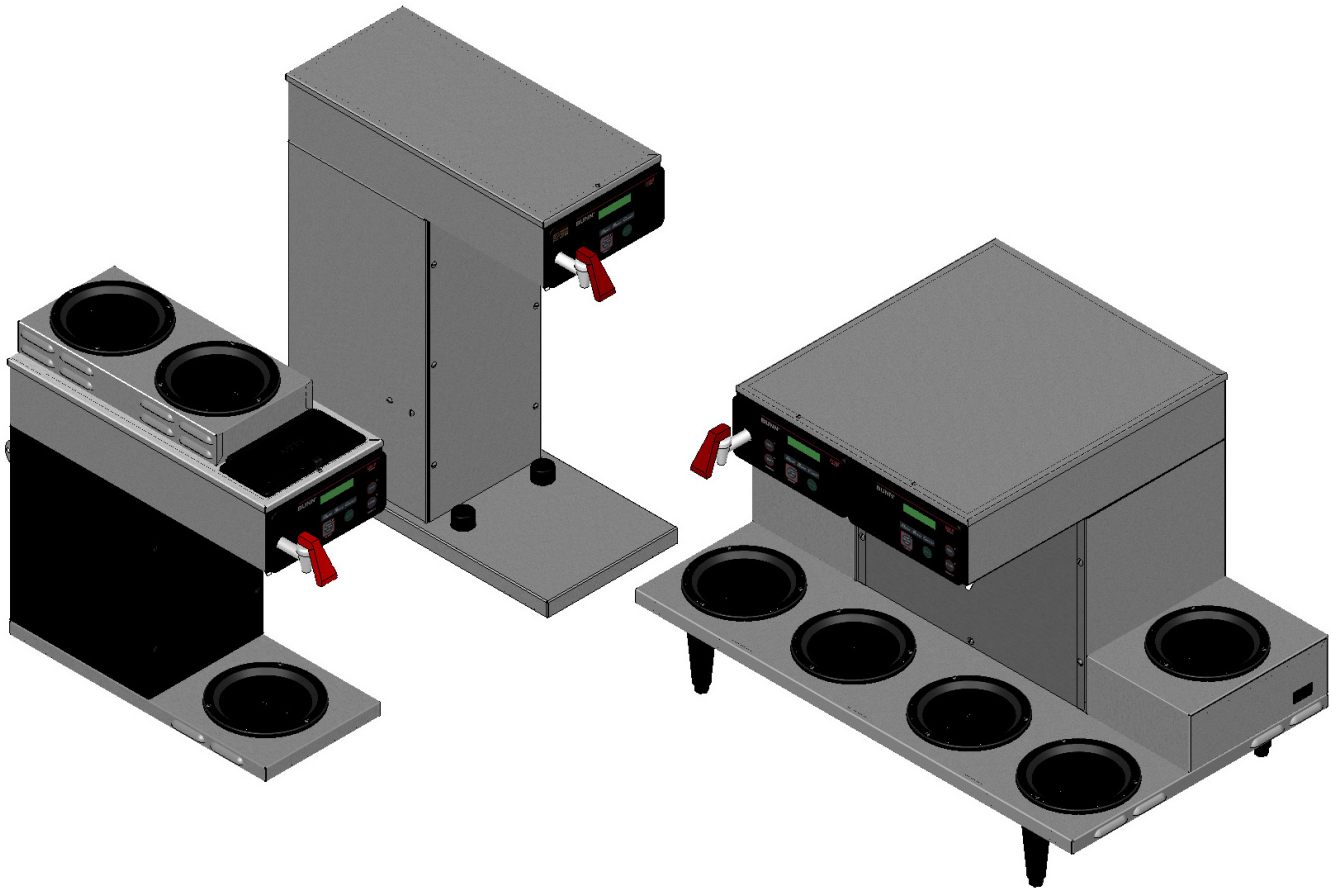

INSTALLATION & OPERATING GUIDE

BUNN-O-MATIC CORPORATION

POST OFFICE BOX 3227

SPRINGFIELD, ILLINOIS 62708-3227

PHONE: (217) 529-6601 FAX: (217) 529-6644

To ensure you have the latest revision of the Operating Manual, or to view the Illustrated Parts Catalog, Programming Manual, or Service Manual, please visit the Bunn-O-Matic website, at www.bunn.com. This is absolutely FREE, and the quickest way to obtain the latest catalog and manual updates. For Technical Service, contact Bunn-O-Matic Corporation at 1-800-286-6070.

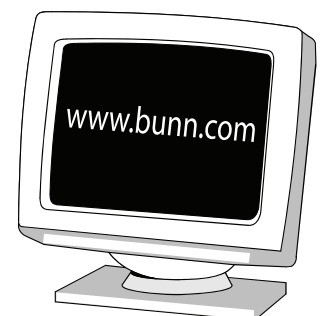

BUNN-O-MATIC COMMERCIAL PRODUCT WARRANTY

Bunn-O-Matic Corp. ("BUNN") warrants equipment manufactured by it as follows:

- 1) Airpots, thermal carafes, decanters, GPR servers, iced tea/coffee dispensers, MCP/MCA pod brewers thermal servers and Thermofresh servers (mechanical and digital)- 1 year parts and 1 year labor.
- 2) All other equipment - 2 years parts and 1 year labor plus added warranties as specified below:
 - a) Electronic circuit and/or control boards - parts and labor for 3 years.
 - b) Compressors on refrigeration equipment - 5 years parts and 1 year labor.
 - c) Grinding burrs on coffee grinding equipment to grind coffee to meet original factory screen sieve analysis - parts and labor for 4 years or 40,000 pounds of coffee, whichever comes first.

These warranty periods run from the date of installation BUNN warrants that the equipment manufactured by it will be commercially free of defects in material and workmanship existing at the time of manufacture and appearing within the applicable warranty period. This warranty does not apply to any equipment, component or part that was not manufactured by BUNN or that, in BUNN's judgment, has been affected by misuse, neglect, alteration, improper installation or operation, improper maintenance or repair, non periodic cleaning and descaling, equipment failures related to poor water quality, damage or casualty. In addition, the warranty does not apply to replacement of items subject to normal use including but not limited to user replaceable parts such as seals and gaskets. This warranty is conditioned on the Buyer 1) giving BUNN prompt notice of any claim to be made under this warranty by telephone at (217) 529-6601 or by writing to Post Office Box 3227, Springfield, Illinois 62708-3227; 2) if requested by BUNN, shipping the defective equipment prepaid to an authorized BUNN service location; and 3) receiving prior authorization from BUNN that the defective equipment is under warranty.

THE FOREGOING WARRANTY IS EXCLUSIVE AND IS IN LIEU OF ANY OTHER WARRANTY, WRITTEN OR ORAL, EXPRESS OR IMPLIED, INCLUDING, BUT NOT LIMITED TO, ANY IMPLIED WARRANTY OF EITHER MERCHANTABILITY OR FITNESS FOR A PARTICULAR PURPOSE. The agents, dealers or employees of BUNN are not authorized to make modifications to this warranty or to make additional warranties that are binding on BUNN. Accordingly, statements by such individuals, whether oral or written, do not constitute warranties and should not be relied upon.

If BUNN determines in its sole discretion that the equipment does not conform to the warranty, BUNN, at its exclusive option while the equipment is under warranty, shall either 1) provide at no charge replacement parts and/or labor (during the applicable parts and labor warranty periods specified above) to repair the defective components, provided that this repair is done by a BUNN Authorized Service Representative; or 2) shall replace the equipment or refund the purchase price for the equipment.

THE BUYER'S REMEDY AGAINST BUNN FOR THE BREACH OF ANY OBLIGATION ARISING OUT OF THE SALE OF THIS EQUIPMENT, WHETHER DERIVED FROM WARRANTY OR OTHERWISE, SHALL BE LIMITED, AT BUNN'S SOLE OPTION AS SPECIFIED HEREIN, TO REPAIR, REPLACEMENT OR REFUND.

In no event shall BUNN be liable for any other damage or loss, including, but not limited to, lost profits, lost sales, loss of use of equipment, claims of Buyer's customers, cost of capital, cost of down time, cost of substitute equipment, facilities or services, or any other special, incidental or consequential damages.

392, AutoPOD, AXIOM, BrewLOGIC, BrewMETER, Brew Better Not Bitter, BrewWISE, BrewWIZARD, BUNN Espresso, BUNN Family Gourmet, BUNN Gourmet, BUNN Pour-O-Matic, BUNN, BUNN with the stylized red line, BUNNlink, Bunn-OMatic, Bunn-O-Matic, BUNNserve, BUNNSERVE with the stylized wrench design, Cool Froth, DBC, Dr. Brew stylized Dr. design, Dual, Easy Pour, EasyClear, EasyGard, FlavorGard, Gourmet Ice, Gourmet Juice, High Intensity, iMIX, Infusion Series, Intellisteam, My Café, Phase Brew, PowerLogic, Quality Beverage Equipment Worldwide, Respect Earth, Respect Earth with the stylized leaf and coffee cherry design, Safety-Fresh, savemycoffee.com, Scale-Pro, Silver Series, Single, Smart Funnel, Smart Hopper, SmartWAVE, Soft Heat, SplashGard, The Mark of Quality in Beverage Equipment Worldwide, ThermoFresh, Titan, trifecta, Velocity Brew, A Partner You Can Count On, Air Brew, Air Infusion, Beverage Bar Creator, Beverage Profit Calculator, Brew better, not bitter., BUNNSource, Coffee At Its Best, Cyclonic Heating System, Daypart, Digital Brewer Control, Nothing Brews Like a BUNN, Pouring Profits, Signature Series, Tea At Its Best, The Horizontal Red Line, Ultra are either trademarks or registered trademarks of Bunn-O-Matic Corporation.

INTRODUCTION

This equipment will brew a ½ gallon batch of coffee into an awaiting server. The brewer may have a hot water faucet for allied beverage use. It is only for indoor use on a sturdy counter or shelf.

CONTENTS

Warranty.....	2
User Notices	3
Electrical Requirements.....	4
Plumbing Requirements & Initial Set-Up.....	6
Operating Controls & Coffee Brewing.....	7
Cleaning & Tank Drain	8
Adjustments & Optional Settings	9

USER NOTICES

Carefully read and follow all notices in this manual and on the equipment. All labels on the equipment should be kept in good condition. Replace any unreadable or damaged labels.

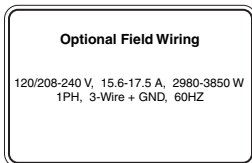

#29710.0007



#00658.0000



#12364.0000



#37881.0002



#00986.0000

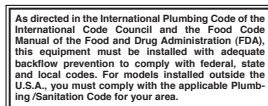

#00656.0001



#03408.0002



#03409.0002



#00824.0002

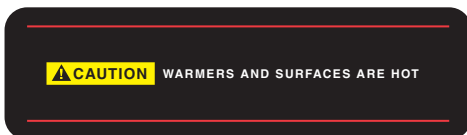

#02765.0000



#00824.0001

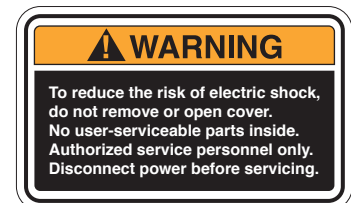

#37881.0000

ELECTRICAL REQUIREMENTS

WARNING -

The brewer must be disconnected from the power source until specified in Initial Set-Up. Refer to Data Plate on the Brewer, and local/national electrical codes to determine circuit requirements.

ELECTRICAL HOOK-UP (All Models)

CAUTION – Improper electrical installation will damage electronic components.

1. An electrician must provide electrical service.
2. Determine the available on-site electrical service.
3. Select the desired unit voltage based on the available on-site electrical service.
4. Using a voltmeter, check the voltage and color coding of each conductor at the electrical source.
5. Remove the front access panel beneath the sprayhead to gain access to the terminal block.
6. Feed the supply leads through the rear of the brewer.
7. Using the above diagrams, connect the desired electrical service to the field wiring terminal block.
8. If wiring the machine for operation on 120/208 or 120/240 volts with a Power Supply Cord, the Power Supply Cord must be UL Listed Flexible Cord Type SO, SJO, SJTO, HSJO or SJOW, No. 12 AWG, 4 Conductor, Rated 90° C. Attachment Plug Cap must be UL Listed, NEMA 14-20P or L14-20P Configuration, Rated 125/250V, 20 AMPS. The Power Supply Cord must be at least 3 feet long and maximum 6 feet long (measured from Strain Relief to end of the Attachment Plug Cap).
9. Before proceeding, verify the voltage at the field wiring terminal block.
10. Set voltage switch to the appropriate position and replace the access panel. (DV Models Only)
11. If plumbing is to be hooked up later be sure the brewer is disconnected from the power source. If plumbing has been hooked up, the brewer is ready for Initial Set-Up.

CE REQUIREMENTS

- This appliance must be installed in locations where it can be overseen by trained personnel.
- For proper operation, this appliance must be installed where the temperature is between 5°C to 35°C.
- Appliance shall not be tilted more than 10° for safe operation.
- An electrician must provide electrical service as specified in conformance with all local and national codes.
- This appliance must not be cleaned by water jet.
- This appliance is not intended for use by persons (including children) with reduced physical, sensory or mental capabilities, or lack of experience and knowledge, unless they have been given instructions concerning use of this appliance by a person responsible for its safety.
- Children should be supervised to ensure they do not play with the appliance.
- If the power cord is ever damaged, it must be replaced by the manufacturer or authorized service personnel with a special cord available from the manufacturer or its authorized service personnel in order to avoid a hazard.
- Machine must not be immersed for cleaning.

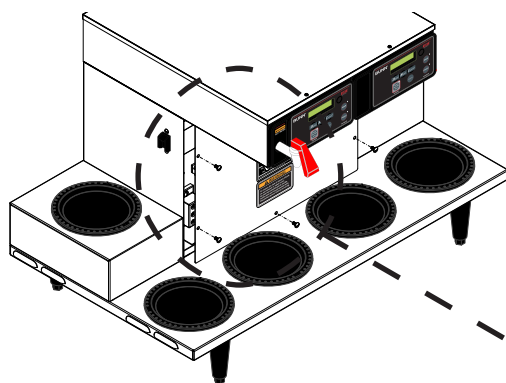

Note: This electrical service requires 3 current carrying conductors (Neutral, L1 and L2) and a separate conductor for earth ground.

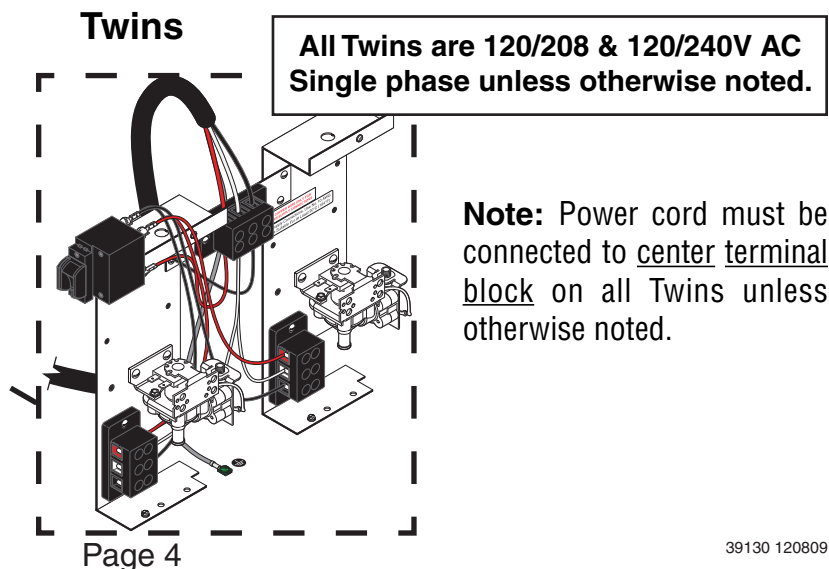

ELECTRICAL REQUIREMENTS

Single & Dual Volt Models

Requirements for brewers with an attached cord set are as follows:

Note: This electrical service requires 2 current carrying conductors (Neutral, and L1) and a separate conductor for earth ground.

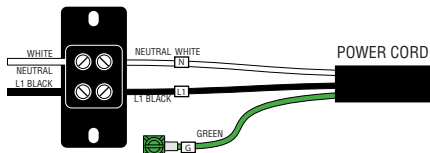

120V 2 WIRE + GROUND

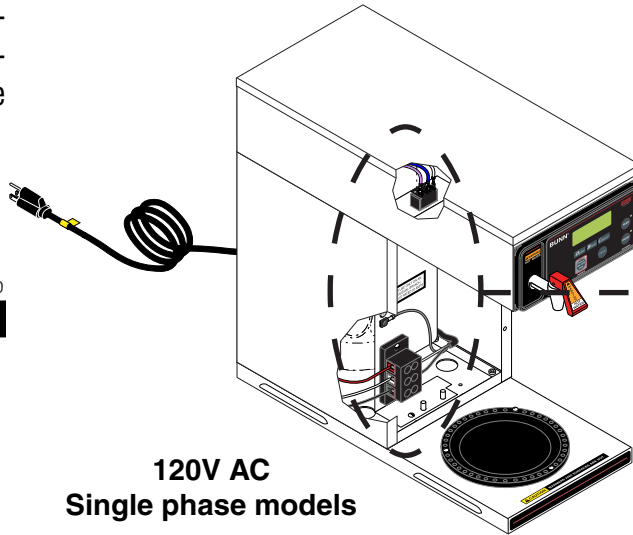

Dual Voltage Switch in 120V position

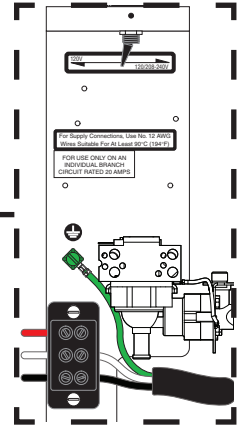

Requirements for brewers without an attached cord set are as follows:

Note: This electrical service requires 3 current carrying conductors (Neutral, L1 and L2) and a separate conductor for earth ground.

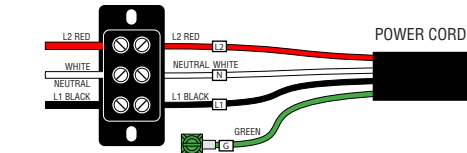

120/208-240V 3 WIRE + GROUND

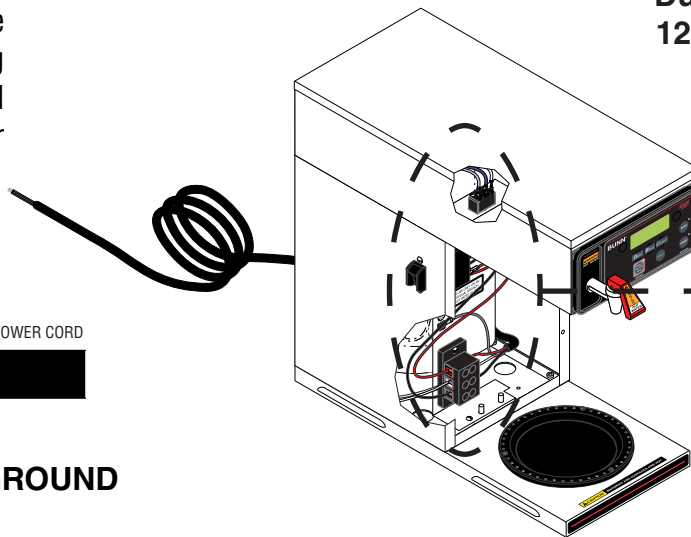

Dual Voltage Switch in 120/208-240V position

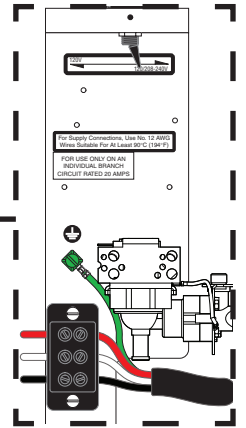

A & B Models

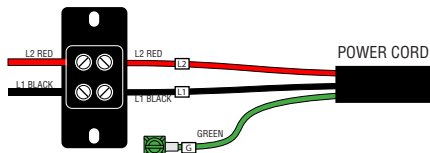

240V 2 WIRE + GROUND

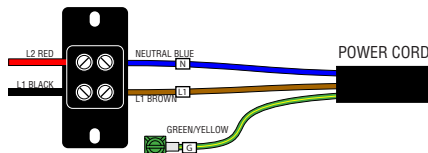

230V 2 WIRE + GROUND

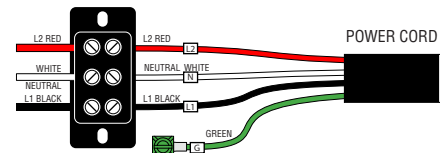

120/208-240V 3 WIRE + GROUND

PLUMBING REQUIREMENTS

These brewers must be connected to a cold water system with operating pressure between 20 and 90 psi (138 and 620 kPa) from a 1/2" or larger supply line. A shut-off valve should be installed in the line before the brewer. Install a regulator in the line when pressure is greater than 90 psi (620 kPa) to reduce it to 50 psi (345 kPa). The water inlet fitting is 1/4" flare.

NOTE - Bunn-O-Matic recommends 1/4" copper tubing for installations of less than 25 feet and 3/8" for more than 25 feet from the 1/2" water supply line. A tight coil of copper tubing in the water line will facilitate moving the brewer to clean the counter top. Bunn-O-Matic does not recommend the use of a saddle valve to install the brewer. The size and shape of the hole made in the supply line by this type of device may restrict water flow.

As directed in the International Plumbing Code of the International Code Council and the Food Code Manual of the Food and Drug Administration (FDA), this equipment must be installed with adequate backflow prevention to comply with federal, state and local codes. For models installed outside the U.S.A., you must comply with the applicable Plumbing /Sanitation Code for your area.

1. Flush the water line and securely attach it to the inlet fitting at the rear of the brewer.
2. Turn on the water supply.

INITIAL SET-UP

1. Insert an empty funnel into the funnel rails.
2. Place an empty server under the funnel.
3. Connect the brewer to the power source.
4. Turn on the main ON/OFF switch located on the left side of brewer (If equipped).
5. Water will flow into the tank and stop when the tank is filled to its capacity. Display will show **"PLEASE WAIT...TANK FILLING"** until tank is filled with water.
6. Wait approximately twenty minutes for the water in the tank to heat to the proper temperature. Display will show **"READY TO BREW...WATER TEMP: 200°"** when tank is at operating temperature. Some water will drip from the funnel during this time; this is due to expansion and should not occur thereafter.
7. Place a small container beneath the faucet and open the faucet handle. Release it when you hear the tank refilling.
8. Water volumes and flow settings have been preset at the factory. Refer to adjustments for the Set Brew Volumes section of this manual should the volume need to be increased or decreased.
9. The brewer is now ready for use in accordance with the instructions for Coffee Brewing.
10. Repeat steps 5-9 for remaining side on Twins.



If setting up new brewer in high mineral locations, refer to programming (Enable Brew Logic). Pertains to units with software version 1.06 & up.

Brew water temperature is factory set at 200° F (93.3° C) Areas of high altitude will require lowering this temperature to prevent boiling. This chart should be used as a guide when readjusting the brew water temperature.

Altitude (Feet)	Boiling point of water		Recommended water temperature	
	° F	° C	° F	° C
-1000	213.8	101.0	200	93.3
-500	212.9	100.5	200	93.3
0	212.0	100.0	200	93.3
500	211.1	99.5	200	93.3
1000	210.2	99.0	200	93.3
1500	209.3	98.5	200	93.3
2000	208.4	98.0	200	93.3
2500	207.4	97.4	200	93.3
3000	206.5	96.9	199	92.8
3500	205.6	96.4	198	92.2
4000	204.7	95.9	197	91.7
4500	203.8	95.4	196	91.1
5000	202.9	94.9	195	90.6
5500	201.9	94.4	195	90.6
6000	201.0	93.9	194	90.0
6500	200.1	93.4	193	89.4
7000	199.2	92.9	192	88.9
7500	198.3	92.4	191	88.3
8000	197.4	91.9	190	87.8
8500	196.5	91.4	189	87.2
9000	195.5	90.8	188	86.7
9500	194.6	90.3	187	86.1
10000	193.7	89.8	186	85.6

OPERATING CONTROLS



P3633

A

B

C

D

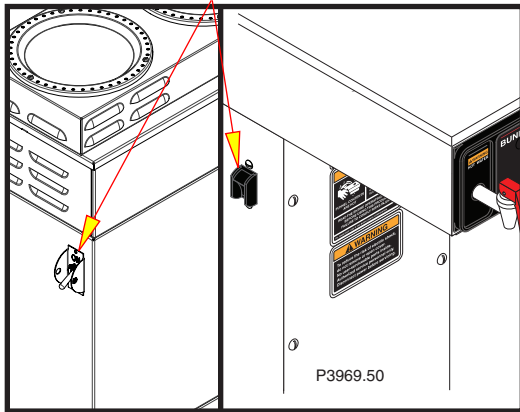

P3969.50

(A) ENABLE BREW ON/OFF SWITCH

Pressing the "ENABLE BREW ON/OFF" switch (indicator on) supplies power to the brew station warmer and enables the brew circuit. Pressing the switch again (indicator off) stops brewing and de-energizes the brew station warmer. Stopping a brew cycle after it has been started will not stop the flow of water into the server until the funnel is empty.

(B) BREW SWITCH

Momentarily pressing and releasing the switch starts a brew cycle when the "ENABLE BREW ON/OFF" indicator is on.

(C) ADDITIONAL WARMER or HALF/FULL BATCH SWITCHES

Pressing any additional warmer switch so that the indicator is on, supplies power to the associated warmer.

NOTE 1: APS & TC models have no warmers.

NOTE 2: These switches are Half/Full Batch on "Single Axiom" models.

(D) MAIN ON/OFF SWITCH

This switch, located on the left side of the brewer, turns power on and off to all components in the brewer.

COFFEE BREWING

1. Begin each brew cycle with a clean empty brew funnel.
2. Insert a BUNN filter into the funnel.
3. Pour (or grind) fresh coffee into the filter and level the bed of grounds by gently shaking.
4. Slide the funnel into the funnel rails until it stops.
5. Place an empty server under the funnel.
6. Verify that the "ENABLE BREW ON/OFF" indicator is on.
7. Momentarily press and release the "BREW" switch. The display will read "NOW BREWING", and show the time remaining in the brew cycle.
8. Following the brew, the display reads "DRIPPING" which shows the time remaining until the coffee no longer drips from the funnel tip.
9. After the coffee finishes dripping from the funnel tip, carefully remove the brew funnel and discard the grounds and filter.

NOTE: Some models are equipped with a backup pour in feature, in case the plumbed water supply is disrupted. In this event, disregard steps 7-8, and pour in 64 ounces of fresh water.



CLEANING

1. The use of a damp cloth rinsed in any mild, nonabrasive, liquid detergent is recommended for cleaning all surfaces on Bunn-O-Matic equipment.
2. Check and clean the sprayhead. The sprayhead holes must always remain open. Insert the short end of the sprayhead cleaning tool into each of the five water outlets of the plastic sprayhead to remove any mineral deposits (Refer to Fig 1)
3. Insert the long end of sprayhead cleaning tool into the sprayhead fitting, and rotate several times to remove any mineral deposits from the fitting (Refer to Fig 2).

NOTE: In hard water areas, this may need to be done daily. It will help prevent liming problems in the brewer and takes less than a minute.

NOTE: In the event that the "Brew Logic" circuit activates (compensating for high lime build up), it will temporarily disable the "Recovery Booster" and "Pulse Brewing" systems until the unit has been de-limed. Refer to the Troubleshooting section for more details.

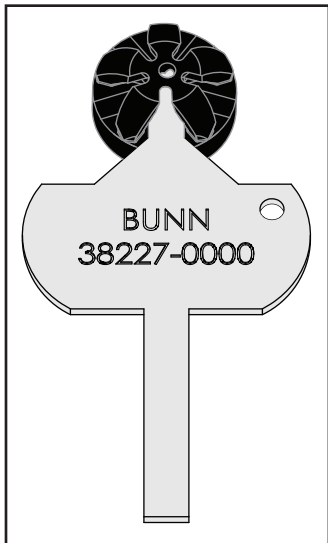

FIGURE 1

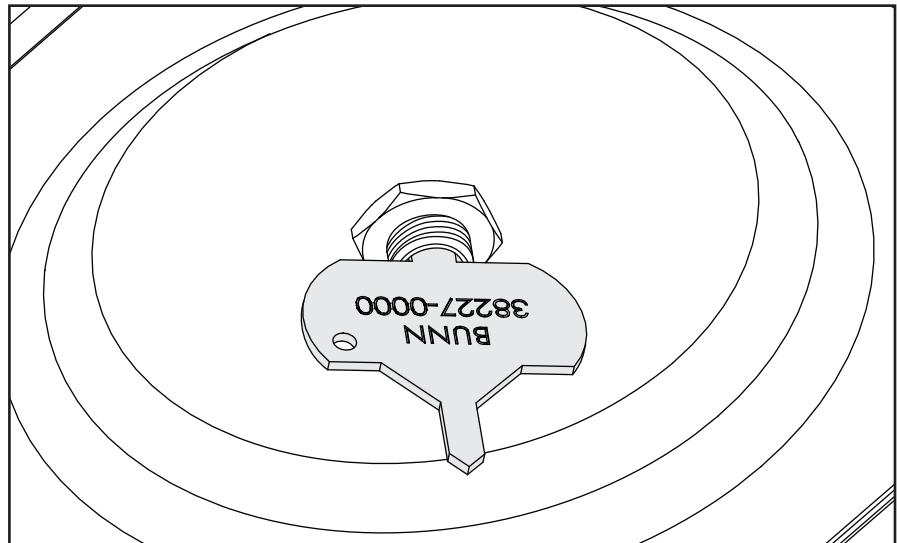
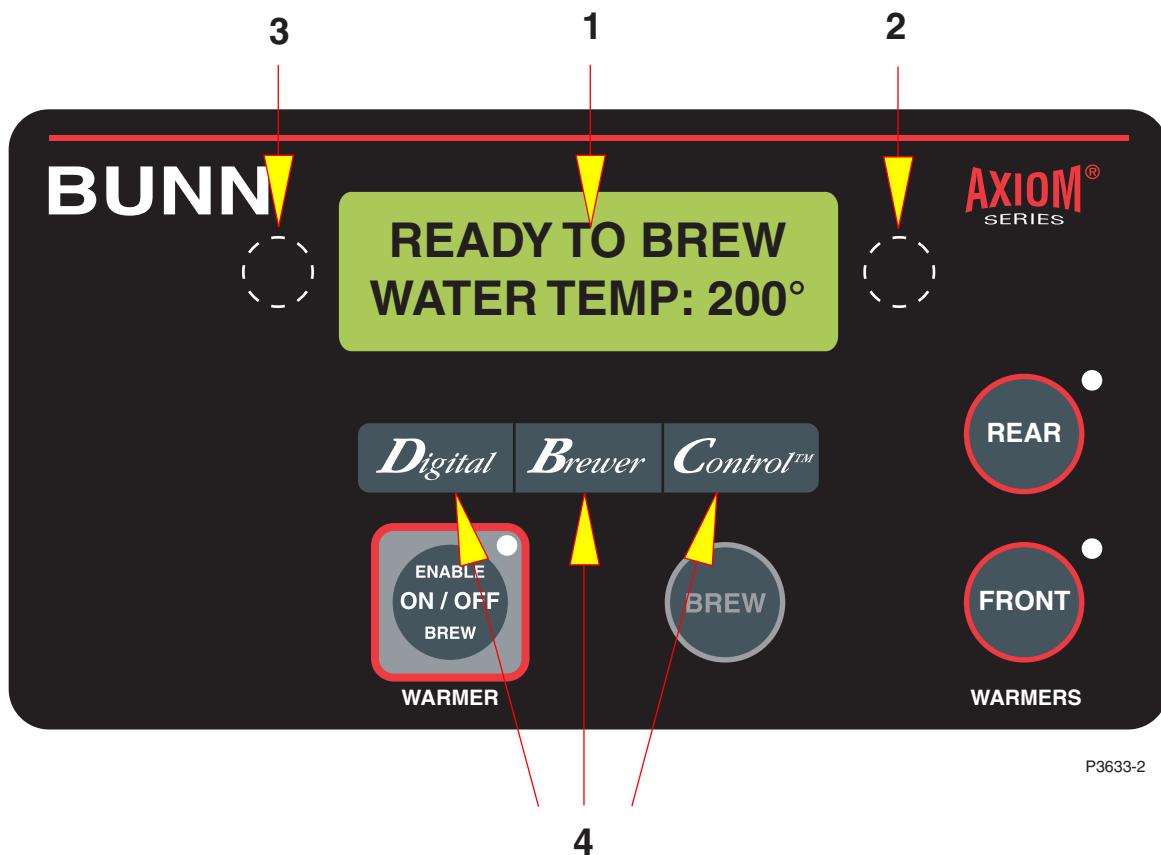

FIGURE 2

TANK DRAIN

1. Loosen screws that secure the front access panel. Remove the panel.
2. Unfasten the hose clamp at the end of the drain hose. Remove the plug.
3. Place the end of the drain hose in a container that has a minimum capacity of 200 oz (5.9 L).
4. Release the white clamp to drain water from the tank.
5. When tank is empty, close the white clamp, replace the plug, and tighten the clamp at the end of the drain hose. (Repeat steps 2-5 for remaining side on Twins)
6. Replace the front panel and tighten screws.

ADJUSTMENTS & OPTIONAL SETTINGS



Using the menu-driven display on the front of the brewer, the operator has the ability to alter or modify various brewing parameters such as brew lockout, brew volume, brew strength, etc. This allows for the precise brewing of various flavors of coffee.

Programming of the brewer is achieved by entering a certain function. Then, by the use of *hidden* programming switches, the operator can customize the brewing process to their specifications.

PROGRAMMING SWITCHES

1. FUNCTION SCREEN

This is the display which shows the various functions.

2. (Right of the display)

This is used to access the program mode and is also used to step forward through the menu.

3. (Left of the display)

This is used to step backwards through the function list.

4. "Digital" (lower left under the display)

This is used to select options that appear on the display during programming (NO/-)

"Brewer" (center under the display)

This is used to select options that appear on the display during programming (DONE)

"Control" (lower right under the display)

This is used to select options that appear on the display during programming (YES/+)

ADJUSTMENTS & OPTIONAL SETTINGS (CONT.)

PROGRAMMING FUNCTIONS - FLOW CHART

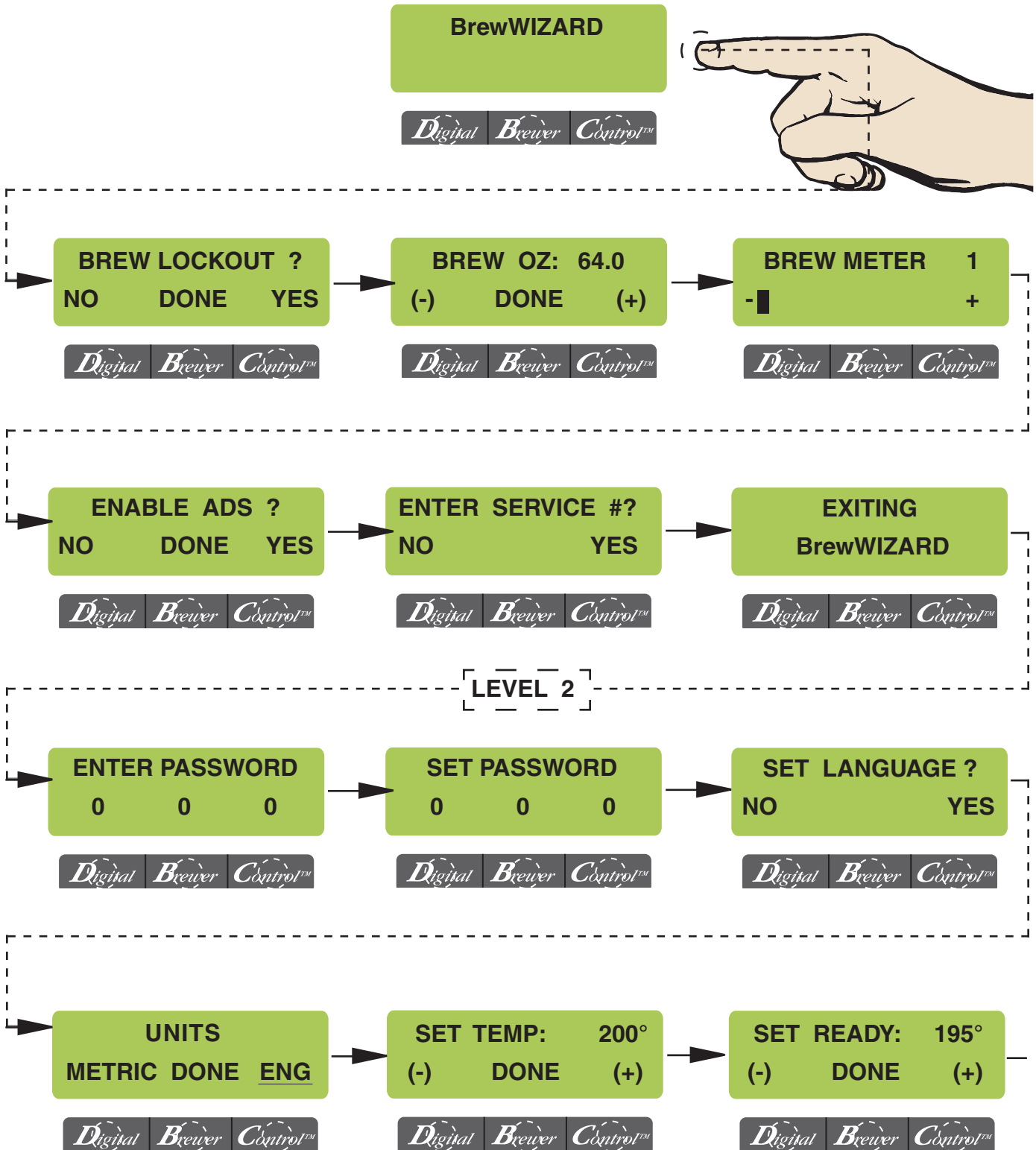

(CONT.)

ADJUSTMENTS & OPTIONAL SETTINGS (CONT.)

LEVEL 2 (CONT.)

