



Installation, Operation, and Maintenance

Modular Self-Contained

40 to 80 Tons



SCWM – 40 to 80 Tons

▲ SAFETY WARNING

Only qualified personnel should install and service the equipment. The installation, starting up, and servicing of heating, ventilating, and air-conditioning equipment can be hazardous and requires specific knowledge and training. Improperly installed, adjusted or altered equipment by an unqualified person could result in death or serious injury. When working on the equipment, observe all precautions in the literature and on the tags, stickers, and labels that are attached to the equipment.



Introduction

Read this manual thoroughly before operating or servicing this unit.

Warnings, Cautions, and Notices

Safety advisories appear throughout this manual as required. Your personal safety and the proper operation of this machine depend upon the strict observance of these precautions.

The three types of advisories are defined as follows:



Indicates a potentially hazardous situation which, if not avoided, could result in death or serious injury.



Indicates a potentially hazardous situation which, if not avoided, could result in minor or moderate injury. It could also be used to alert against unsafe practices.



Indicates a situation that could result in equipment or property-damage only accidents.

Important Environmental Concerns

Scientific research has shown that certain man-made chemicals can affect the earth's naturally occurring stratospheric ozone layer when released to the atmosphere. In particular, several of the identified chemicals that may affect the ozone layer are refrigerants that contain Chlorine, Fluorine and Carbon (CFCs) and those containing Hydrogen, Chlorine, Fluorine and Carbon (HCFCs). Not all refrigerants containing these compounds have the same potential impact to the environment. Trane advocates the responsible handling of all refrigerants-including industry replacements for CFCs and HCFCs such as saturated or unsaturated HFCs and HCFCs.

Important Responsible Refrigerant Practices

Trane believes that responsible refrigerant practices are important to the environment, our customers, and the air conditioning industry. All technicians who handle refrigerants must be certified according to local rules. For the USA, the Federal Clean Air Act (Section 608) sets forth the requirements for handling, reclaiming, recovering and recycling of certain refrigerants and the equipment that is used in these service procedures. In addition, some states or municipalities may have additional requirements that must also be adhered to for responsible management of refrigerants. Know the applicable laws and follow them.

⚠ WARNING

Proper Field Wiring and Grounding Required!

Failure to follow code could result in death or serious injury.

All field wiring **MUST** be performed by qualified personnel. Improperly installed and grounded field wiring poses **FIRE** and **ELECTROCUTION** hazards. To avoid these hazards, you **MUST** follow requirements for field wiring installation and grounding as described in **NEC** and your local/state/national electrical codes.

⚠ WARNING

Personal Protective Equipment (PPE) Required!

Failure to wear proper PPE for the job being undertaken could result in death or serious injury. Technicians, in order to protect themselves from potential electrical, mechanical, and chemical hazards, **MUST** follow precautions in this manual and on the tags, stickers, and labels, as well as the instructions below:

- Before installing/servicing this unit, technicians **MUST** put on all PPE required for the work being undertaken (Examples; cut resistant gloves/sleeves, butyl gloves, safety glasses, hard hat/bump cap, fall protection, electrical PPE and arc flash clothing). **ALWAYS** refer to appropriate Safety Data Sheets (SDS) and OSHA guidelines for proper PPE.
- When working with or around hazardous chemicals, **ALWAYS** refer to the appropriate SDS and OSHA/GHS (Global Harmonized System of Classification and Labelling of Chemicals) guidelines for information on allowable personal exposure levels, proper respiratory protection and handling instructions.
- If there is a risk of energized electrical contact, arc, or flash, technicians **MUST** put on all PPE in accordance with OSHA, NFPA 70E, or other country-specific requirements for arc flash protection, **PRIOR** to servicing the unit. **NEVER PERFORM ANY SWITCHING, DISCONNECTING, OR VOLTAGE TESTING WITHOUT PROPER ELECTRICAL PPE AND ARC FLASH CLOTHING. ENSURE ELECTRICAL METERS AND EQUIPMENT ARE PROPERLY RATED FOR INTENDED VOLTAGE.**

⚠ WARNING**Follow EHS Policies!**

Failure to follow instructions below could result in death or serious injury.

- All Trane personnel must follow the company's Environmental, Health and Safety (EHS) policies when performing work such as hot work, electrical, fall protection, lockout/tagout, refrigerant handling, etc. Where local regulations are more stringent than these policies, those regulations supersede these policies.
- Non-Trane personnel should always follow local regulations.

Copyright

This document and the information in it are the property of Trane, and may not be used or reproduced in whole or in part without written permission. Trane reserves the right to revise this publication at any time, and to make changes to its content without obligation to notify any person of such revision or change.

Trademarks

All trademarks referenced in this document are the trademarks of their respective owners.

Agency Listing

Unit is listed with ETL as a modular/cassette product and ships as such. Individual assemblies are tested and meet the requirements as such, but is not tested as a completed unit.

Important: *Installer is responsible for proper installation and for properly following assembly instructions found in this IOM.*

Revision History

- Updated 80 Ton Right Hand Unit and Sealing of Unit sections in Installation - Mechanical chapter.
- Updated SCWM water-cooled self-contained, 40 to 80 tons table in General Data chapter.
- Updated Final Refrigerant Charge section in Startup chapter.
- Updated Unit dimensions and Evaporator cassette dimensions tables in Dimensions Data chapter.
- Updated Typical layout of units (40 to 80 tons) left hand electrical and right hand water 40 TON figure in Typical Unit Layout section in Installation - Mechanical chapter.



Table of Contents

Overview	7	Water Temperature Requirements	32
R-410A Compressors	7	Water Piping Verification	32
Modular Self-Contained Unit Components	7	Refrigerant System	32
Standard Controls.....	7	Interconnecting Piping	33
TD-7 Touch Screen Display	7	Preliminary Refrigerant Charging	34
Tracer® UC600 Unit Controller	7	Charging and Wiring the Unit	34
Optional Controls	8	Fan Installation	36
Unit Nameplate	8	Duct Connections.....	38
Model Number Description.....	9	Final Installation	38
Modular Self-Contained	9	Electrical Installation	39
General Data	10	TD-7 Installation	39
Pre-Installation	13	Installation - Electrical	41
Receiving	13	Unit Wiring Diagrams.....	41
Receiving Checklist.....	13	Supply Power Wiring	41
Ship-Separate Accessories.....	13	Voltage Range	41
Contractor Installation Responsibilities	13	Voltage Imbalance	41
Unit Inspection	13	Phase Monitor	41
Exterior Inspection	13	Control Power	41
Inspection for Concealed Damage	13	Selection Procedures	42
Repair.....	14	Determination of Minimum Circuit Ampacity (MCA)	42
Unpacking.....	14	Static Pressure Sensor Installation (VAV units only)	45
Dimensional Data	15	Sensor Location	45
Service Clearances	20	Installing the Tubing Sensor	45
Weights	21	Zone Sensor option used for Discharge Air Reset by Space Temperature	46
Installation - Mechanical.....	23	Zone Temperature Sensor, BAYSENS077 (Optional Item)	46
.....	23	Zone Sensor Installation	46
Unit Handling.....	23	Mounting Location.....	46
Installation Preparation.....	23	Mounting the Subbase	46
Unit Vibration Isolator Option (Isopads).....	23	Wiring	47
Typical Unit Layout	24	Standard Remote Sensor (BAYSENS077)	47
Installation Summary	24	Operating Principles.....	48
.....	31	Control Sequences of Operation	48
Condensate Drain Connections.....	32	Occupied/Unoccupied Switching	48
General Waterside Recommendations for Cooling Towers.....	32	Compressor Lead/Lag	48
Waterside Piping Arrangements.....	32	Emergency Stop Input.....	48

External Auto/Stop Input	48	High Duct Temperature	
Local Auto Stop	48	Thermostat	53
Water Flow Control	48	Dirty Air Filter Sensor Option	53
Head Pressure Control	48	Supply Air Static Pressure High	
Water Purge	48	Limit	53
Supply Air Temperature Control Unit		Controls	54
Sequence of Operation	48	Unit Controller	54
Discharge Air High Temp Limit		Navigating the TD-7	57
Software Alarm (Software)	48	TD-7 Home Screen	57
Condenser Water Low Temperature		TD-7 Reports	58
Alarm (Software)	48	Unit Status Report	58
Leaving Air Low Temperature		All Points Report	58
Alarm	48	Starting the Unit	58
Occupied Fan Operation	49	Local Auto/Stop Value	58
Heat/Cool Mode	49	Setpoint Adjustments	58
Cooling/Waterside Economizer	49	Unit Setpoints	59
Thermostatic Expansion Valve	49	Unit Setup	60
Fan Operation	49	Reports	60
Supply Air Static Pressure High		Compressor Alarms	60
Limit	49	Fan Alarms	60
Compressors	49	General Alarms	60
Compressor Oil	49	Water Purge	61
High Pressure Cutout Switch		Pre-Startup	62
(HPC)	50	Pre-Startup Checklist	62
Compressor Input/Output		Supply Fan	62
Module	50	Ductwork	62
Compressor Pressure Sensors	50	Water-Cooled Unit Piping	62
Compressor Suction		Units with Hydronic Heat	62
Temperature	50	Electrical	62
Fixed Speed Compressor (FS)	50	Components	62
Compressor Safety Circuit	50	Startup	63
Variable Speed Compressor		Final Refrigerant Charge	63
(VS)	51	Startup Procedure	63
Compressor Limit Conditions	51	Operating and Programming	
Compressor Staging	52	Instructions	64
Compressor Control	52	Startup Log	64
Waterside Components	52	Maintenance	65
Water Purge	52	Service Access	65
Water Piping Options	52	Air Filters	65
Basic Water Piping	52		
Water Regulating Valve (WRV)			
optional	52		
Water Flow Switch Option	53		
Waterside Economizer Option	53		
Heat Mode	53		



Table of Contents

Inspecting and Cleaning the Drain Pan.....	66	Recognizing ScaleBreak®'s saturation point.....	72
Compressors.....	66	Circulation Pump Setup.....	72
Scroll Compressor Failure Diagnosis and Replacement.....	66	Cleaning Instruction.....	73
Refrigerant System.....	66	Chemical Cleaning Economizer Coil.....	74
Refrigerant Leak Test Procedure.....	66	Piping Components.....	74
Brazing Procedures.....	67	Maintenance Periodic Checklists.....	75
System Evacuation Procedures.....	68	Monthly Checklist.....	75
Compressors.....	69	Semi-Annual Maintenance.....	75
Scroll Compressor Failure Diagnosis and Replacement.....	69	Annual Maintenance.....	75
Components.....	70	Diagnostics.....	76
Cleaning Coil Fin.....	70	Troubleshooting.....	76
Sequence of Operations.....	72	System Checks.....	76



Overview

Note: One copy of this document ships inside the control panel of each unit and is customer property. It must be retained by the unit's maintenance personnel.

This manual describes proper installation, operation, and maintenance procedures for water cooled systems. By carefully reviewing the information within this manual and following the instructions, the risk of improper operation and/or component damage will be minimized. It is important that periodic maintenance be performed to help assure trouble free operation. A maintenance schedule is provided at the end of this manual. Should equipment failure occur, contact a qualified service organization with qualified, experienced HVAC technicians to properly diagnose and repair this equipment.

This manual covers installation, operation and maintenance of 40-80 tons Commercial Modular Self-Contained products with R-410A refrigerant.

R-410A Compressors

- Use crankcase heaters which must be energized 24 hours prior to compressor start.

Note: This unit is equipped with stator heating capabilities that eliminates the need for a crankcase heater on the variable speed compressor only. All fixed speeds must utilize a crankcase heater.

- Contains POE oil which readily absorbs potentially damaging moisture from air.
- Control box includes a phase monitor to detect phase loss, line voltage imbalance and reversal.

Modular Self-Contained Unit Components

Modular self-contained units are complete HVAC systems used in floor-by-floor applications.

- A cassette design for easily transporting components into the building even in the most demanding environments.
- Left or right hand power connections.
- Left or right hand water connections.
- Factory installed options.

The hermetically sealed scroll compressor motors utilize internal motor protection and time delays to prevent excessive cycling.

Units utilize 2-4 refrigerant circuits and ship as cassettes with a small nitrogen charge and full oil charge. Each circuit includes filter drier, pressure relief valve, moisture indicating sight glass, thermostatic expansion valve with sensing bulb and externally

equalized, and high pressure cutout. The water cooled condensers are brazed plate heat exchangers and are chemically cleanable with "Clean in Place" as option. Every unit comes with a 20 mesh cleanable screen that should be installed on the water inlet of the unit upstream of all condensers, and also come with differential pressure to indicate when screen should be cleaned.

Fan Array consists of 3-5 Direct Drive Plenum fans with each fan equipped with Internal Variable Frequency Drive and ECM motors.

Figure 1. Modular self-contained signature series unit components

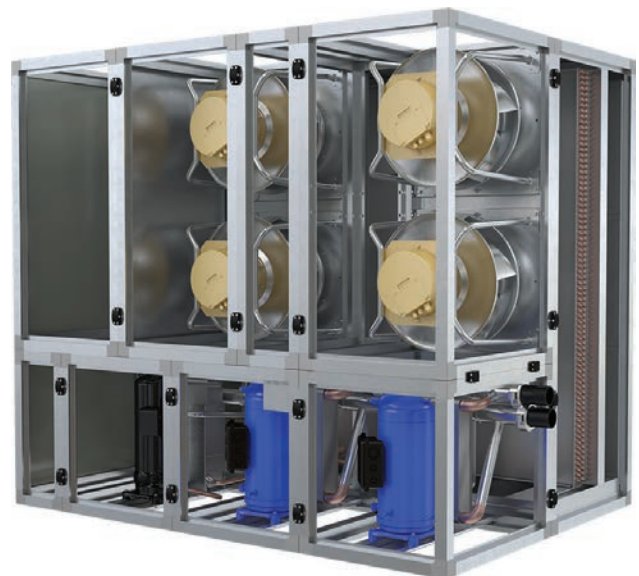

Standard Controls

Standard controls supplied with the unit include the Trane UC600 unit controls and the TD-7 touch screen display. All basic setup parameters are preset from the factory.

TD-7 Touch Screen Display

The TD-7 is unit mounted and accessible without opening the unit's front panel. It allows easy setpoint adjustment using the TD-7 touch screen. In addition, the TD-7 displays all unit operating parameters and conditions in a backlit color screen.

For more information on TD-7 display, see the Tracer® TD-7 Display IOM, BAS-SVX50*-EN.

Tracer® UC600 Unit Controller

The UC600 provides "smart" unit control with safety features and control relays for external devices. The UC600 utilizes BACnet MSTP to communicate to a front end Building Automation System (BAS). If a BAS



Overview

System does not talk BACnet, the Generic Building Automation System Module can be ordered with the unit to pick up some information.

The Modular Series self-contained unit is controlled by a microelectronic programmable control system that has been programmed from the factory specifically for the Modular Series self-contained application. If additional input or output points are needed, expansion modules can be used.

See the Owner's section of this manual for a detailed description of the controls points provided.

Optional Controls

Optional controls include a disconnect switch, dirty filter switch, water flow switch, supply air temperature

reset, or external setpoint inputs. Morning warm-up operation is available on all units.

Note: *A water flow switch is required for the installation, either supplied from the factory or field-provided.*

The static pressure probe, supply air temperature reset sensor options ship separate, but with the unit for field installation. For more detailed information on the unit control options, see the Owner's section of this manual.

Unit Nameplate

The unit nameplate identifies the unit model number. It is located on the door of the starter panel.



Model Number Description

Modular Self-Contained

Digit 1 — Unit Model

S = Self-Contained

Digit 2 — Unit Type

C = Commercial

Digit 3 — Condenser

W = Water-cooled

Digit 4 — Construction

M = Modular

Digit 5 — Refrigerant

N = Nitrogen

R = R410A

Digit 6, 7, 8 — Capacity

04L = 40 Tons Low MCA

040 = 40 Tons

05L = 50 Tons Low MCA

050 = 50 Tons

06L = 60 Tons Low MCA

060 = 60 Tons

07L = 70 Tons Low MCA

070 = 70 Tons

08L = 80 Tons Low MCA

080 = 80 Tons

Digit 9 — Unit Voltage

F = 208–230/60/3

4 = 460/60/3

Digit 10, 11 — Design Sequence

00 = Initial Release

Digit 12 — Number of Fans

3 = 3 Fans

4 = 4 Fans

5 = 5 Fans

6 = 6 Fans

Digit 13 — Compressor Configuration

A = 2 Compressors (1 Variable, 1 Fixed)

B = 3 Compressors (1 Variable, 2 Fixed)

C = 4 Compressors (2 Variable, 2 Fixed)

Digit 14 — Control Valves

0 = None

H = Head Pressure Control Valves

Digit 15 — Condenser Cleanable Options

0 = None

C = Clean in Place Fittings (Chemically Cleanable)

Digit 16 — Economizer

0 = No Economizer

W = With Water Side Economizer

Digit 17 — Water Connections

L = Left Hand Connections

R = Right Hand Connections

Digit 18 — Unit Water Connections

1 = Victaulic

2 = Pipe Connections

Digit 19 — Air Discharge

H = Horizontal Discharge

V = Vertical Discharge

Digit 20 — Electrical Connections

L = Left Hand Connections

R = Right Hand Connections

Digit 21 — Unit Electrical Connections

1 = Disconnect Switch

2 = Terminal Block

Digit 22 — Drain Pan

G = Galvanized Drain Pan

S = Stainless Steel Drain Pan

Digit 23 — Industrial Options

0 = None

A = Protective Coating Evaporator Coil

Digit 24 — Filter Type

A = 2 inch

B = 4 inch

C = 2 inch Pre, 4 inch Post

D = 6 inch

Digit 25 — Heater

0 = None

1 = Hydronic

Digit 26 — Shipping Method

C = Cassette

Digit 27 — Unit Isolators

0 = None

A = Isopads

Digit 28 — Control Interface Options

A = UC600 VAV Control Scheme (Fixed DA Temp)

B = UC600 VAV Control Scheme (Return Air Reset)

C = UC600 VAV Control Scheme (Space Temp Reset)

Digit 29 — Agency Listing

0 = None

E = ETL listing

Digit 30 — Options

0 = None

1 = Duct High Temperature Cutout

Digit 31 — Space Sensor Options

0 = None

1 = Space Sensor Only

Digit 32 — GBAS Options

0 = None

1 = GBAS Points Included

Digit 33, 34, 35, 36, 37, 38 — Future Use

0 = None

Digit 39 — Major Design Version

A = 1.0

Digit 40 — Design Special

0 = None

S = Design Special



General Data

Table 1. SCWM water-cooled self-contained, 40 to 80 tons

Tonnage	40L Ton	40 Ton	50L Ton	50 Ton	60L Ton	60 Ton	70L Ton ^(a)	70 Ton ^(a)	80L Ton ^(a)	80 Ton ^(a)	
Compressor Data											
Quantity	1VS- 1FS	1VS- 1FS	1VS- 2FS	1VS- 2FS	1VS- 2FS	1VS- 2FS	1VS- 3FS	1VS- 3FS	1VS- 3FS	1VS- 3FS	
Nominal Ton/Comp	10T- 15T	15T- 15T	10T- 13T	15T- 13T	10T- 15T	15T- 15T	10T- 13T	15T- 13T	10T- 15T	15T- 15T	
Circuits	2	2	3	3	3	3	4	4	4	4	
Evaporator Coil Data											
Rows	4	4	3	3	4	4	4	4	4	4	
Sq. Ft.	25.5	25.5	33	33	38	38	19.8	33.3	19.8	33.3	
Fins/in	13.5	13.5	13.5	13.5	13.5	13.5	13.5	13	13.5	13.5	
Number of Coils	1	1	1	1	1	1	1	1	1	1	
Condenser Data											
Minimum GPM w/o Econ ^(b)	N/A	N/A	N/A	N/A	N/A	N/A	N/A	N/A	N/A	N/A	
Minimum GPM w/ Econ	N/A	N/A	N/A	N/A	N/A	N/A	N/A	N/A	N/A	N/A	
Maximum GPM	140	140	210	210	210	210	280	280	280	280	
Evaporator Fan Data											
Quantity	3	3	3	3	4	4	5	5	5	5	
Diameter	500 mm	500 mm	500 mm	500 mm	500 mm	500 mm	500 mm	500 mm	500 mm	500 mm	
Power consumption kW	6.4	6.4	6.4	6.4	6.4	6.4	6.4	6.4	6.4	6.4	
Minimum Design cfm ^(c)	11000	11000	13750	13750	16500	16500	19250	19250	22000	22000	
Maximum Design cfm	16000	16000	20000	20000	24000	24000	28000	28000	32000	32000	
Refrigerant Charge, lbs. R-410A^(d)											
Circuit A	17	18	17	18	17	18	20	21	20	21	
Circuit B	19	19	18	18	19	19	18	18	19	19	
Circuit C	x	x	18	18	19	19	18	18	19	19	
Circuit D	x	x	x	x	x	x	17	17	18	18	
Filter Data, Water-Cooled Units											
Number - Size (in.)	9 - 24"x 20"		12 - 24"x 20"				15 - 24"x 24"				
Number of Compressors											
10 HP - Variable Speed	1	0	1	0	1	0	1	0	1	0	
15 HP - Variable Speed	0	1	0	1	0	1	0	1	0	1	
13 HP - Fixed Speed	0	0	2	2	0	0	3	3	0	0	
15 HP - Fixed Speed	1	1	0	0	2	2	0	0	3	3	
Number of fans/unit											
No. of fans	3				4			5			

Note: All performance data is provided in the Performance Selection Program. Contact Trane Sales at 770-988-8338 for more information.

^(a) Split coils

^(b) All performance data is provided in the Performance Selection Program. Contact MJC Sales at 770-988-8338 for more information.

^(c) Minimum air flow at part load is 35% of full load design CFM.

^(d) Refrigerant charge shown is a general guideline, charge to sub-cooling as described in IOM. Note that occasionally a TXV adjustment may need to be made but only after adequate sub-cooling has been reached.

Table 2. SCWM EER/IEER ratings

Tonnage	Model No.	EER	IEER (VAV)	AHRI Net Cooling Capacity (BTUH)
40	SCWMN04LF	15.8	20.6	408
	SCWMN040F	14.8	20.6	468
	SCWMN04L4	15.8	20.6	408
	SCWMN0404	14.8	20.6	468
50	SCWMN05LF	15.8	19.5	540
	SCWMN050F	14.9	19.5	600
	SCWMN05L4	15.8	19.5	540
	SCWMN0504	14.9	19.5	600
60	SCWMN06LF	15.7	18.5	636
	SCWMN060F	14.8	18.5	696
	SCWMN06L4	15.7	18.5	636
	SCWMN0604	14.8	18.5	696
70	SCWMN07LF	15.8	19.5	780
	SCWMN070F	14.9	19.5	840
	SCWMN07L4	15.8	19.5	780
	SCWMN0704	14.9	19.5	840
80	SCWMN08LF	15.7	20.8	876
	SCWMN080F	14.7	20.8	936
	SCWMN08L4	15.7	20.8	876
	SCWMN0804	14.7	20.8	936

Notes:

1. Cooling Only
2. Cooling performance is rated at 80F EDB/67F EWB with 85 EWT for water-cooled performance and 95F Ambient for air-cooled performance.
3. EER, IEER, and AHRI Net Cooling Capacity are tested in accordance with the AHRI 340/360 (I-P) and certified to 10 CFR Part 431 from the US Department of Energy.

Table 3. SCWM water volumes

Tonnage	Water Volume in U.S. Gallons/Liters			
	w/o Economizer		With Chem. Cleanable Econ, Add	
	Gallons	Liters	Gallons	Liters
40 Ton	8.2	31	12	45.4
50 Ton	9.7	36.7	14.4	54.5
60 Ton	9.7	36.7	19.1	72.3
70 Ton	12.9	48.9	24	90.8
80 Ton	12.9	48.9	24	90.8

Table 4. SCWM refrigerant circuits, number of compressors by circuit

Tonnage	Model No.	Circuit			
		1	2	3	4
40	SCWMN04L	1-10T VS	1-15T FS	N/A	N/A
	SCWMN040	1-15T VS	1-15T FS	N/A	N/A
50	SCWMN05L	1-10T VS	1-13T FS	1-13T FS	N/A
	SCWMN050	1-15T VS	1-13T FS	1-13T FS	N/A



General Data

Table 4. SCWM refrigerant circuits, number of compressors by circuit (continued)

Tonnage	Model No.	Circuit			
		1	2	3	4
60	SCWMN06L	1-10T VS	1-15T FS	1-15T FS	N/A
	SCWMN060	1-15T VS	1-15T FS	1-15T FS	N/A
70	SCWMN07L	1-10T VS	1-13T FS	1-13T FS	1-13T FS
	SCWMN070	1-15T VS	1-13T FS	1-13T FS	1-13T FS
80	SCWMN08L	1-10T VS	1-15T FS	1-15T FS	1-15T FS
	SCWMN080	1-15T VS	1-15T FS	1-15T FS	1-15T FS

Note: VS - Variable Speed Compressor, S - Fixed Speed Compressor

Table 5. Waterside economizer coil physical data

Model	Unit Size	Rows	FPF	Height	Length
MSC	40 Ton	4	150	75	49
MSC	50 Ton	4	150	75	65
MSC	60 Ton	4	150	75	73
MSC ^(a)	70 Ton	4	150	75	38
		4	150	75	64
MSC ^(a)	80 Ton	4	150	75	38
		4	150	75	64

^(a) Split coils

Table 6. Hot water coil physical data

Model	Unit Size	Rows	FPF	Height	Length
MSC	40 Ton	1	156	75	49
MSC	50 Ton	1	156	75	65
MSC	60 Ton	1	156	75	73
MSC ^(a)	70 Ton	1	156	75	45
		1	156	75	45
MSC ^(a)	80 Ton	1	156	75	45
		1	156	75	45

^(a) Split coils

Important: All performance data is provided in the Performance Selection Program. Contact your local Trane Sales office for more information.



Pre-Installation

Receiving

Receiving Checklist

Complete the following checklist immediately after receiving unit shipment to detect possible shipping damage:

- Inspect individual cartons before accepting. Check for rattles, bent carton corners, or other visible indications of shipping damage.
- If a unit appears damaged, inspect it immediately before accepting the shipment. Make specific notations concerning the damage on the freight bill. Do not refuse delivery.
- Inspect the unit for concealed damage before it is stored and as soon as possible after delivery. Report concealed damage to the freight line within the allotted time after delivery. Check with the carrier for their allotted time to submit a claim.
- Do not move damaged material from the receiving location. It is the receiver's responsibility to provide reasonable evidence that concealed damage did not occur after delivery.
- Do not continue unpacking the shipment if it appears damaged. Retain all internal packing, cartons, and crate. Take photos of damaged material if possible.
- Notify the carrier of the damage immediately by phone and mail. Request an immediate joint inspection of the damage by the carrier and consignee.

Note: Notify your Trane representative of the damage and arrange for repair. Have the carrier inspect the damage before making any repairs to the unit.

Ship-Separate Accessories

Field installed components ship separately inside cassette labeled "Ship-With Components" or on individual pallet.

Contractor Installation Responsibilities

Complete the following checklist before beginning final unit installation:

- Verify the unit size and tagging with the unit nameplate.
- Make certain the floor or foundation is level, solid, and sufficient to support the unit and accessory weights. Level or repair the floor before positioning the unit if necessary.
- Allow minimum recommended clearances for routine maintenance and service. Allow space at end of the unit for servicing. Refer to the unit submittals for dimensions. See also the "Service

Clearances," p. 20 section in the "Dimensional Data," p. 15 chapter.

- Electrical connection knockouts are on the top, of the starter panel.
- Allow adequate space for piping access and panel removal. Locate and properly identify condenser water piping, refrigerant piping, and condensate drain connections depending upon your application.

Note: Unit height and connection locations will change if using vibration isolators.

- Electrical supply power must meet specific balance and voltage requirements as described in chapter "Electrical Installation".
- The installer is responsible for providing a condenser main, standby water pump, cooling tower, pressure gauges, and all components for waterside piping.

Unit Inspection

To protect against loss due to damage incurred in transit, perform inspection immediately upon receipt of the unit.

Exterior Inspection

If the job site inspection reveals damage or material shortages, file a claim with the carrier immediately. Specify the type and extent of the damage on the bill of lading before signing. Notify the appropriate sales representative.

Important: Do not proceed with installation of a damaged unit without sales representative's approval.

- Visually inspect the complete exterior for signs of shipping damages to unit or packing material.
- Verify that the nameplate data matches the sales order and bill of lading.
- Verify that the unit is properly equipped and there are no material shortages.
- Verify that the power supply complies with the unit nameplate specifications.

Inspection for Concealed Damage

Visually inspect the components for concealed damage as soon as possible after delivery and before it is stored.

If concealed damage is discovered:

- Notify the carrier's terminal of the damage immediately by phone and by mail.
- Concealed damage must be reported within 15 days.



Pre-Installation

- Request an immediate, joint inspection of the damage with the carrier and consignee.
- Stop unpacking the unit.
- Do not remove damaged material from receiving location.
- Take photos of the damage, if possible.
- The owner must provide reasonable evidence that the damage did not occur after delivery.

Repair

Notify the appropriate sales representative before arranging unit installation or repair.

Important: Do not repair unit until the damage has been inspected by the carrier's representative.

Unpacking

Modular Self-Contained units ship dis-assembled. [Figure 2, p. 14](#) illustrates a typical shipping package.

Figure 2. Typical unit shipping package

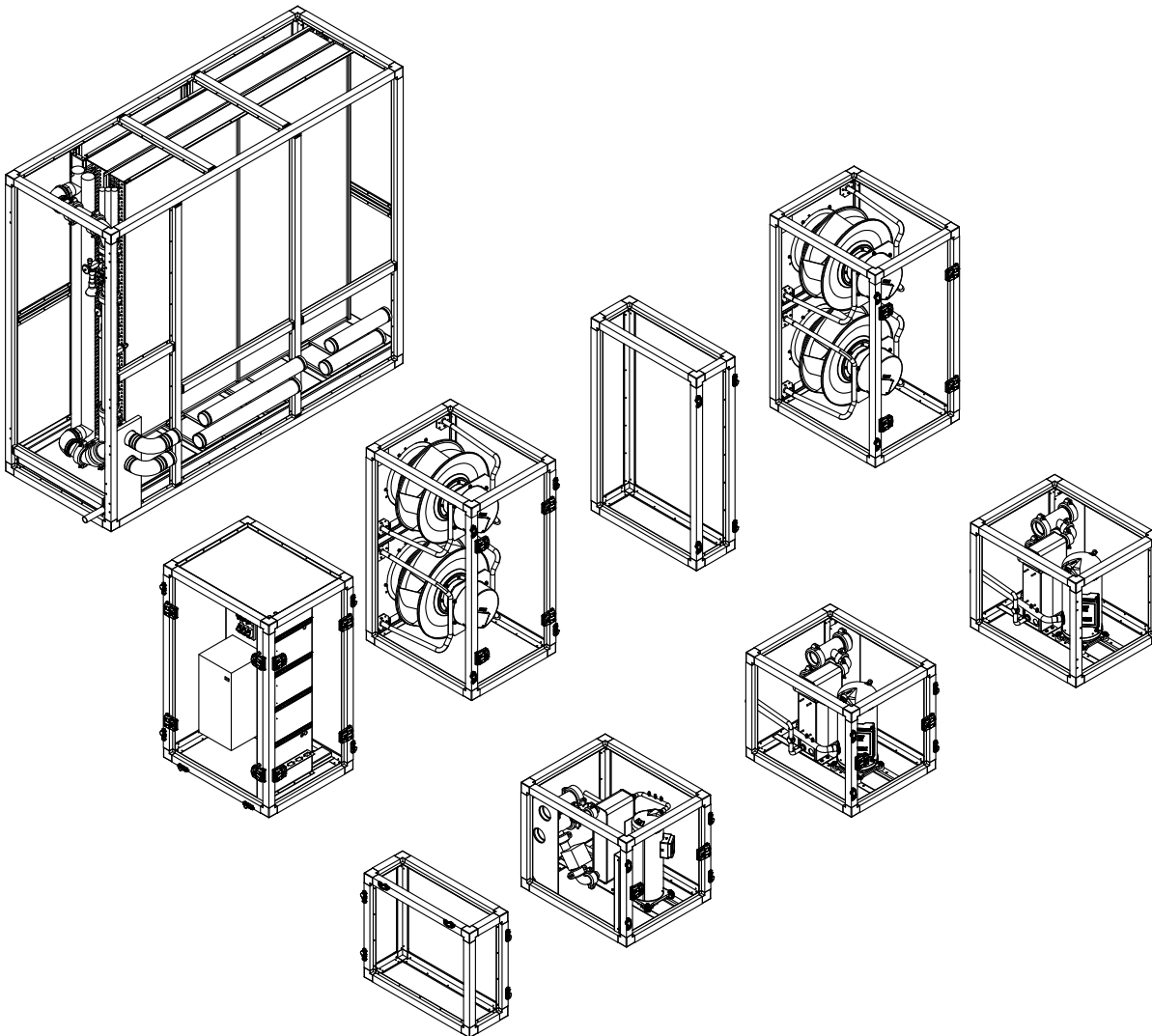



Dimensional Data

Figure 3. Unit dimensions (in inches)

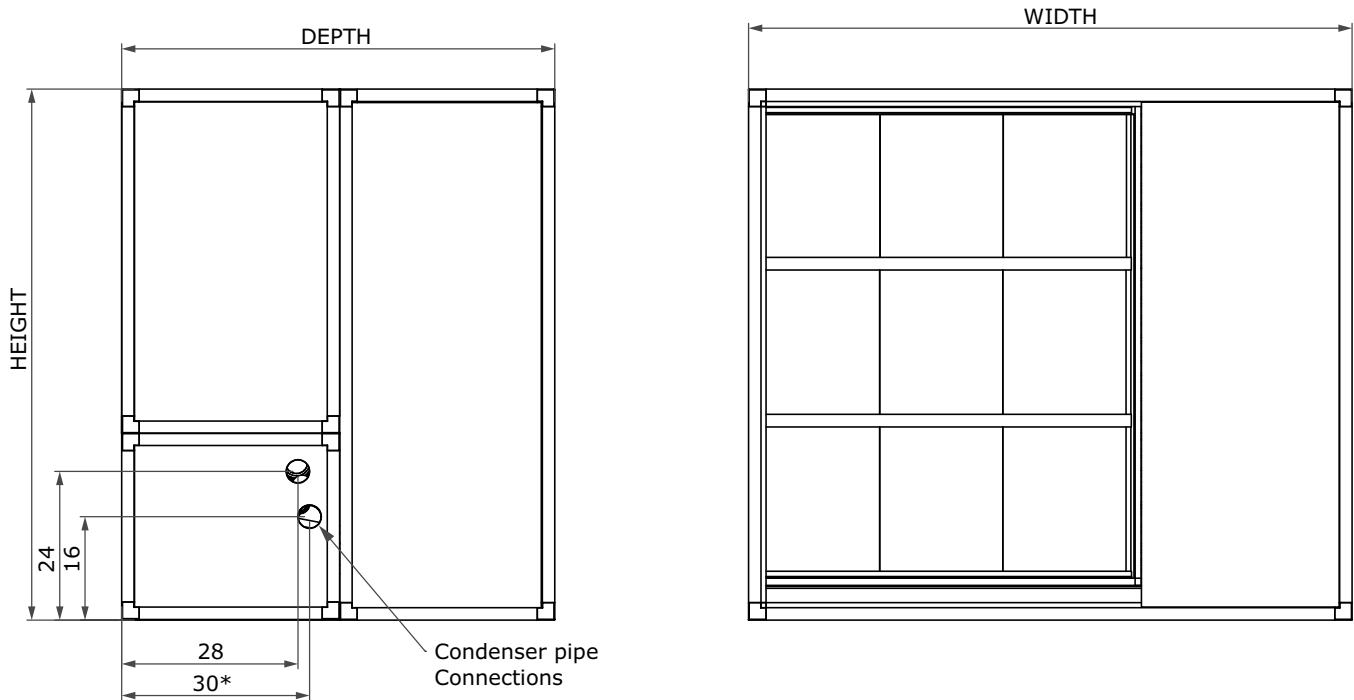

Table 7. Unit dimensions (in inches)

Model	Width	Height	Depth
40/40L	96 ^(a)	84	69
50/50L	96 ^(a)	84	69
60/60L	96 ^(a)	84	69
70/70L	127 ^(a)	84	69
80/80L	127 ^(a)	84	69

^(a) Does not include condensate drain connection. Add an additional 1.5 inch to width to account for drain connection.



Dimensional Data

Figure 4. Fan assembly footprint (in mm/inches)

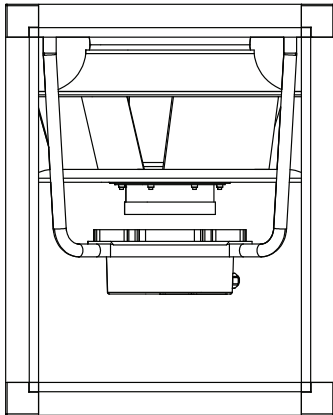

TOP VIEW

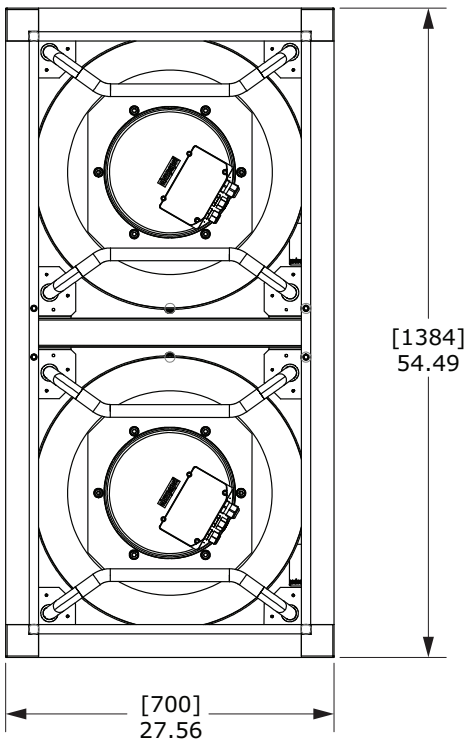

FRONT VIEW

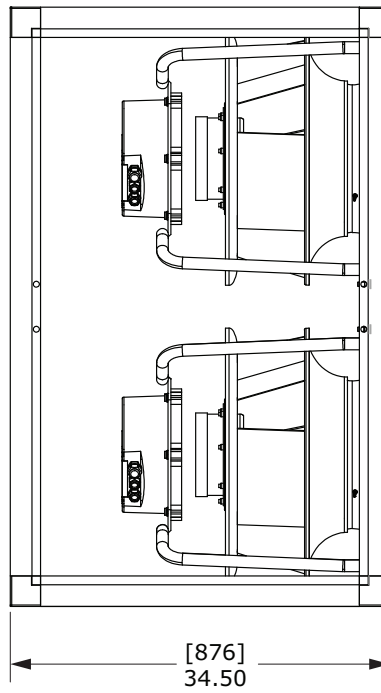

SIDE VIEW

Figure 5. Variable speed compressor assembly footprint (in mm/inches)

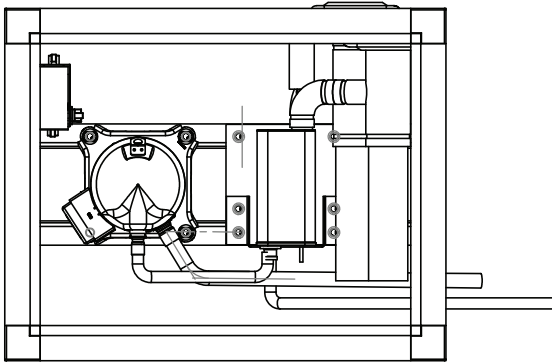

TOP VIEW

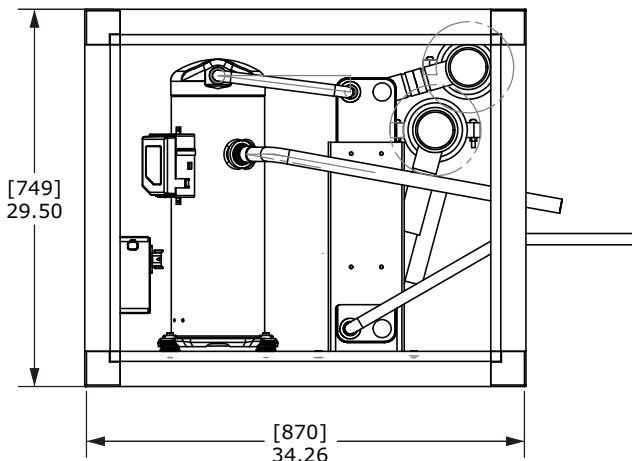

FRONT VIEW

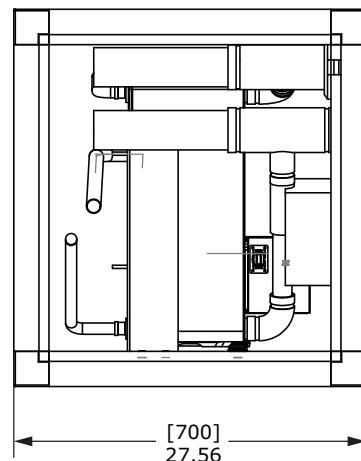

SIDE VIEW

Dimensional Data

Figure 6. Starter cassette assembly footprint (in inches)

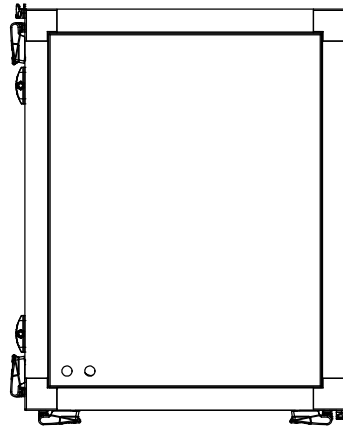

TOP VIEW

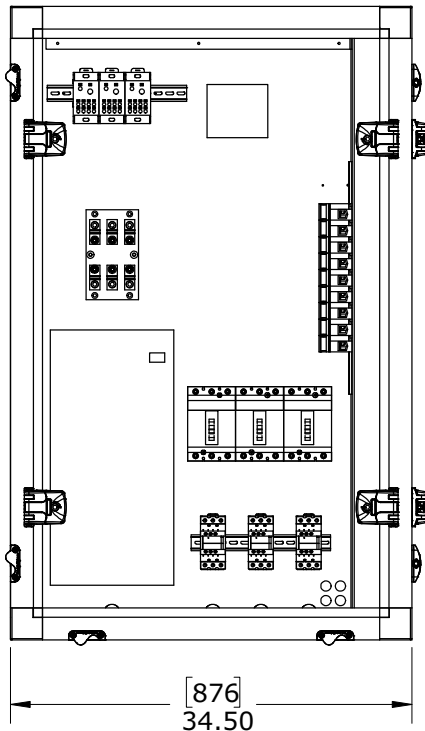

SIDE VIEW

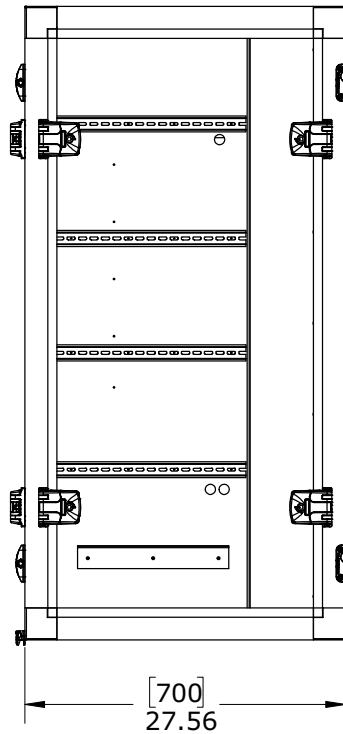

FRONT VIEW

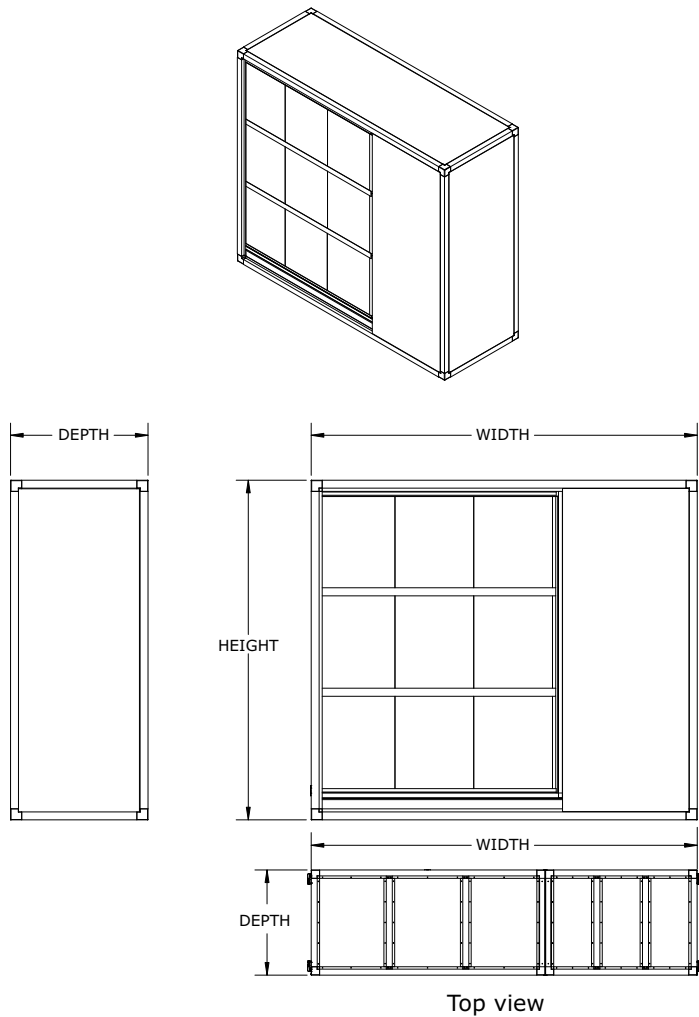
Figure 7. Evaporator cassette assembly footprint (in inches)

Table 8. Evaporator cassette dimensions (in inches)

Model	Width	Split Coil Width	Height	Depth
40/40L	96 ^(a)	N/A	84	34.5
50/50L	96 ^(a)	N/A	84	34.5
60/60L	96 ^(a)	N/A	84	34.5
70/70L ^(b)	127 ^(a)	77	84	34.5
		50	84	34.5
80/80L ^(b)	127 ^(a)	77	84	34.5
		50	84	34.5

^(a) Does not include condensate drain connection. Add an additional 1.5 inch to width to account for drain connection.

^(b) Split coils.

Figure 8. Discharge opening for 40-60 ton

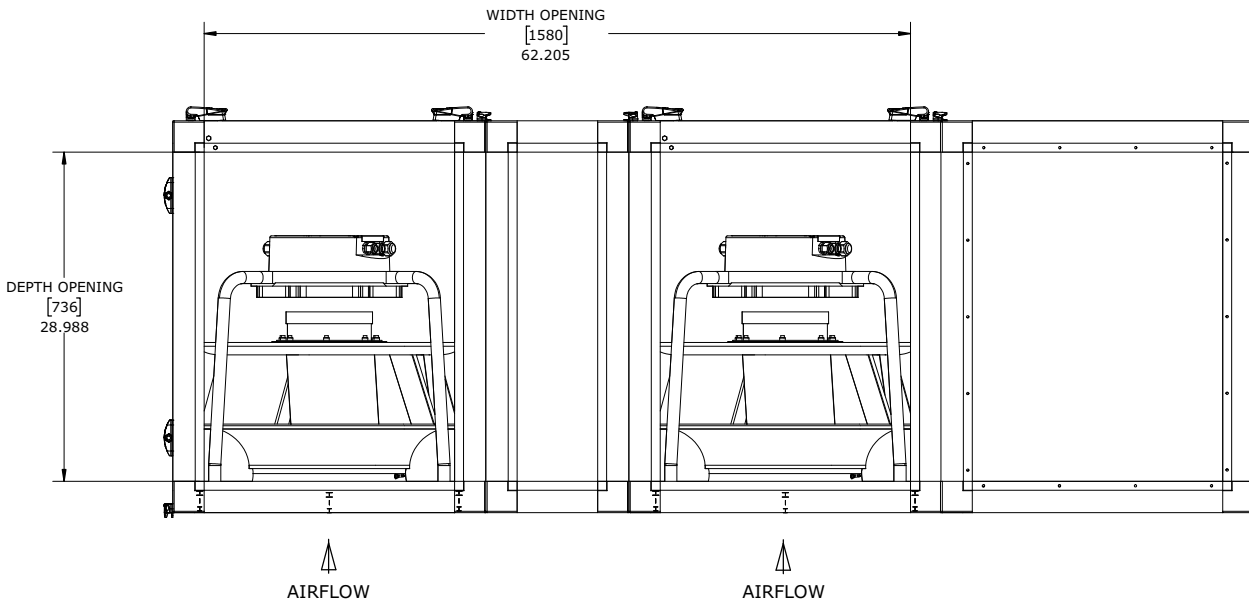
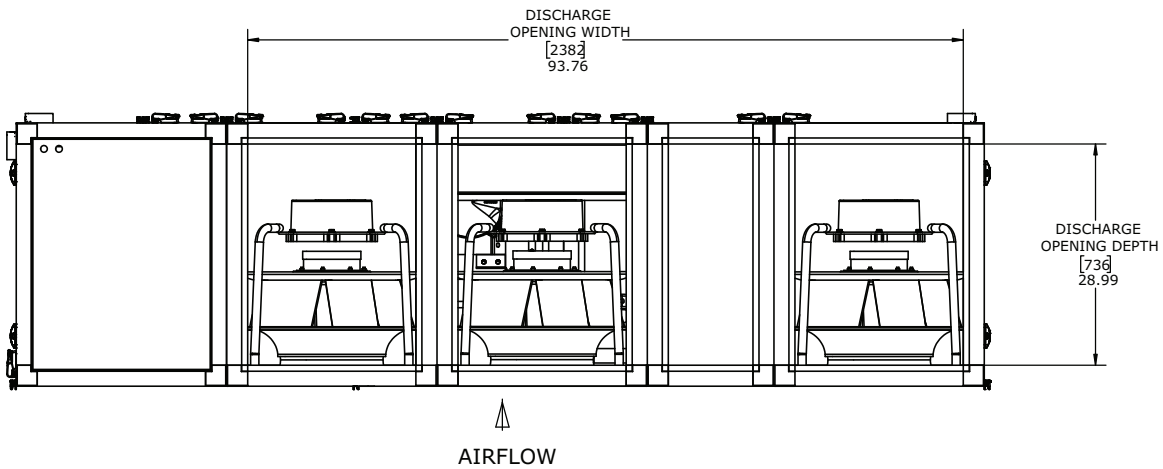

Figure 9. Discharge opening for 70-80 ton



Service Clearances

Table 9. Service/code clearance requirements

Side		Distance - in. (mm)	Purpose
Front		42 (1066)	Fans, Compressors, Condensers, Refrigeration access
Left	Left Hand Starter	42 (1066)	NEC Code Requirement (Starter Panel)
	Right Hand Starter	9 (229)	
Right	Left Hand Starter	9 (229)	NEC Code Requirement (Starter Panel)
	Right Hand Starter	42 (1066)	
Inlet		18 (457)	Provides uniform air flow



Weights

Table 10. Unit weights

Unit Size	Base Weight		Waterside Economizer	
	(lbs)	(kg)	(lbs)	(kg)
40 Ton	3041	1379	381	173
50 Ton	3506	1590	468	212
60 Ton	3641	1652	568	258
70 Ton	4733	2146	762	346
80 Ton	4733	2146	762	346

Note: All unit weights include refrigerant, water, and controllers.

Table 11. Unit shipping weights (fan cassette)

Unit Size	Overall Dimensions	Unit Weight (lbs)	Fan Cassette	Number of Dual	Fan Weight (Two Fans)	Number of Single	Fan Weight (Single Fan)	Total Fan Weight
40 Ton	70"x 84" x 95.5"	2933	34.5"x 54.5"x 27.6"	1	408	1	308	716
50 Ton	70"x 84" x 95.5"	3365	34.5"x 54.5"x 27.6"	1	408	1	308	716
60 Ton	70"x 84" x 95.5"	3500	34.5"x 54.5"x 27.6"	2	408	0	308	816
70 Ton	70"x 84" x 126"	4545	34.5"x 54.5"x 27.6"	2	408	1	308	1124
80 Ton	70"x 84" x 126"	4545	34.5"x 54.5"x 27.6"	2	408	1	308	1124

Table 12. Unit shipping weights (compressor cassette)

Unit Size	Overall Dimensions	Unit Weight (lbs)	Compressor Cassette	Number Fixed Spd	FS Condensing Unit Cassette	Number Var Spd	VS Condensing Unit Cassette	Total Condensing Unit Weight
40 Ton	70"x 84" x 95.5"	2933	34.5"x 29.5"x 27.6"	1	385	1	335	720
50 Ton	70"x 84" x 95.5"	3365	34.5"x 29.5"x 27.6"	2	385	1	335	1105
60 Ton	70"x 84" x 95.5"	3500	34.5"x 29.5"x 27.6"	2	385	1	335	1105
70 Ton	70"x 84" x 126"	4545	34.5"x 29.5"x 27.6"	3	385	1	335	1490
80 Ton	70"x 84" x 126"	4545	34.5"x 29.5"x 27.6"	3	385	1	335	1490

Table 13. Unit shipping weights (starter cassette)

Unit Size	Overall Dimensions	Unit Weight (lbs)	Starter Cassette	Starter Cassette Weight (230 Vac)
40 Ton	70"x 84" x 95.5"	2933	34.5"x 54.5"x 27.6"	323
50 Ton	70"x 84" x 95.5"	3365	34.5"x 54.5"x 27.6"	323
60 Ton	70"x 84" x 95.5"	3500	34.5"x 54.5"x 27.6"	323
70 Ton	70"x 84" x 126"	4545	34.5"x 54.5"x 27.6"	388
80 Ton	70"x 84" x 126"	4545	34.5"x 54.5"x 27.6"	388

Table 14. Unit shipping weights (evaporator cassette)

Tonnage	Overall dimensions	Unit Weight (lbs)	Evaporator Cassette	Total Weight of Cassette (excl. Economizer)
40 Ton	70"x 84" x 95.5"	2933	34.5" x 84" x 94"	1127
50 Ton	70"x 84" x 95.5"	3365	34.5" x 84" x 94"	1219
60 Ton	70"x 84" x 95.5"	3500	34.5" x 84" x 94"	1254



Weights

Table 14. Unit shipping weights (evaporator cassette) (continued)

Tonnage	Overall dimensions	Unit Weight (lbs)	Evaporator Cassette	Total Weight of Cassette (excl. Economizer)
70 Ton ^(a)	70"x 84" x 127"	4545	34.5" x 84" x 77"	1032
			34.5" x 84" x 50"	620
80 Ton ^(a)	70"x 84" x 127"	4545	34.5" x 84" x 77"	1032
			34.5" x 84" x 50"	620

^(a) Split coils



Installation - Mechanical

Unit Handling

⚠ WARNING

Improper Unit Lift!

Failure to properly lift unit in a LEVEL position could result in unit dropping and possibly crushing operator/technician which could result in death or serious injury, and equipment or property-only damage.

Test lift unit approximately 24 inches (61 cm) to verify proper center of gravity lift point. To avoid dropping of unit, reposition lifting point if unit is not level.

- Unit can be moved into space using 4-wheel Dollies, Hand Truck, or Pallet Jack.
- Be careful not to damage cassette bottom panel during movement.
- The unit was designed so that all components can be moved through a standard commercial width doorway and make a turn in a standard commercial width hallway. Certain circumstances may still require the Evaporator Cassette to be disassembled to move it into the mechanical room. For disassembly instructions, please contact MJC Sales at (770) 988 8338.

Installation Preparation

Before installing the unit, perform the following procedures to ensure proper unit operation, refer [Figure 2, p. 14](#).

1. Position the evaporator module and skid assembly in its final location.
2. Remove the skids from under the unit. See [Figure 2, p. 14](#). If you find internal damage, file a claim immediately to the delivering carrier.
3. Remove the protective shipping covers from the cassettes.
4. Set the evaporator into place before proceeding. Place the evaporator on the isolator pads (see next section) if the unit has the isolator option.

Unit Vibration Isolator Option (Isopads)

Important: *Vibration isolation is not necessary for the unit since the factory internally isolates the compressors, thus creating double isolation. Trane strongly recommends that you consult a vibration specialist when considering double isolation. In general, Trane does not recommend double-isolation.*

1. Cut appropriate sized "waffles" from the sheets

provided. In general, a 2x2 pattern works well under each cassette.

2. Place the pads at each intersection of the Condensing Unit Cassettes.
3. Align the remaining pads along the back side (filter side) of the Evaporator Cassette.

Figure 10. Isolator pads locations

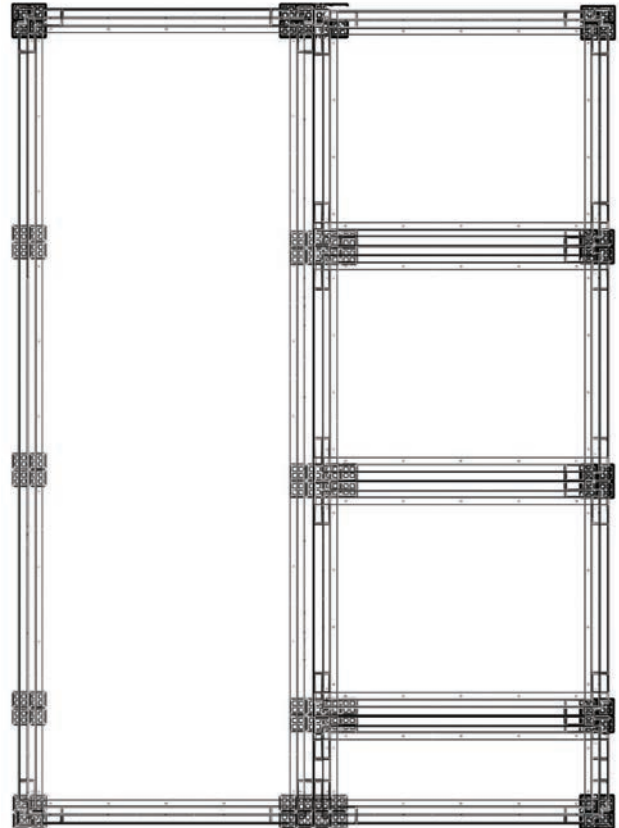

Notes:

- *The unit is equipped with a positively sloped drain pan to help indoor air quality (IAQ) and does not require one corner of the unit to be pitched.*
- *Unit is not internally trapped. Installer must externally trap the condensate line.*

Typical Unit Layout

Figure 11. Typical layout of units (40 to 80 tons) left hand electrical and right hand water

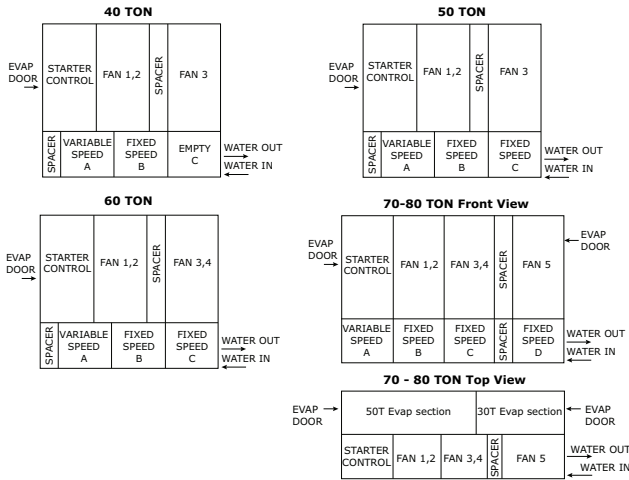
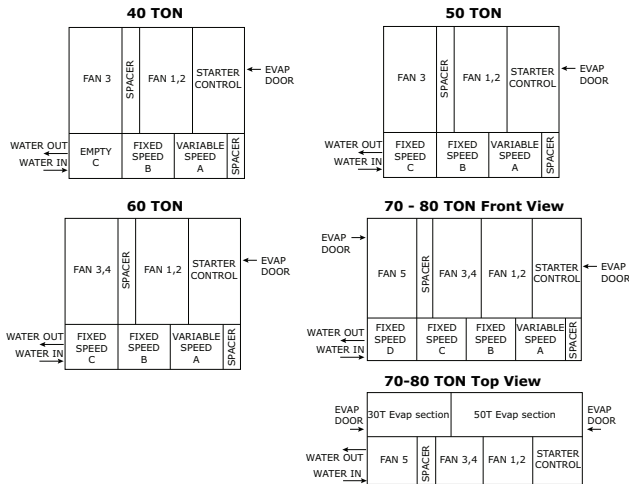

Figure 12. Typical layout of units (40 to 80 tons) right hand electrical and left hand water



Installation Summary

The steps below provide a summary of installation steps for installing the modular self-contained unit. Read all installation instructions before starting the installation as the below is not a complete summary of all steps required.

Recommended Tool List

Note: This is a general list only. Other standard tools will be required.

- 7/8-inch deep socket
- 11/16-inch deep socket

- Adapter for sockets to drill
- Cordless impact drill
- 5/16 Socket Bit - To be used in the impact drill
- 3/8 Socket Bit
- Phillips bit #2 for drill
- Extensions bit holder for drill - long and short
- Right angle driver for drill (Skew Driver)
- 5/32 hex key (TEE handle if possible)
- 5/16 or 8mm hex key (TEE handle if possible)
- 5mm Hex Key (TEE handle if possible)
- 6mm hex key socket (Intelliclamps)
- Minimum of 4 vice clamps (cassette joining)
- Rubber mallet
- Tube cutter for 1 3/8 copper pipe.
- Furniture Dollies: 6 to 8

Note: The installation images below depict a 60 ton, right hand electrical unit, left hand water unit. Water connections will always be opposite of the electrical cassette. For a left hand electrical unit, the installation will be reversed. The second set of pictures depict the installation for an 80 ton right hand electrical unit. There is additional detail provided in these pictures to show the interconnecting piping and the sealing of the unit.

60 Ton Right Hand Unit

1. Place evaporator into final location.



2. Add spacer cassette.



3. Add variable speed compressor A condensing unit.



5. Add fixed speed compressor C condensing unit.



4. Add fixed speed compressor B condensing unit.

6. Add starter/control panel cassette.



7. Add fans 1 and 2 fan cassette.



8. Add fan spacer cassette.



9. Add fans 3 and 4 fan cassette.



80 Ton Right Hand Unit

1. Place evaporators at their final location.



2. Start by attaching compressor spacer to evaporator first.

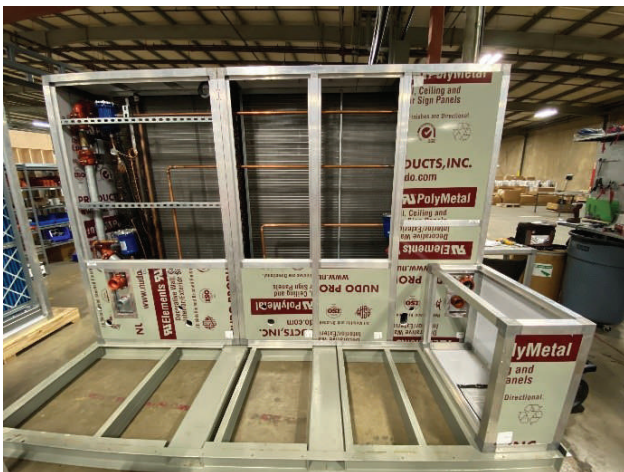

3. Secure with intellectamps.



4. Unbraid caps from both evaporator and compressor first. Line up compressor A piping to the corresponding evaporator holes.



5. Push compressor A into evaporator.



6. Secure compressor A to spacer with intellectamps.



7. Complete piping and braze everything for compressor A.



8. Unbraid caps and line up compressor B.



9. Push compressor B in and clamp down to compressor A using intellaclamps.

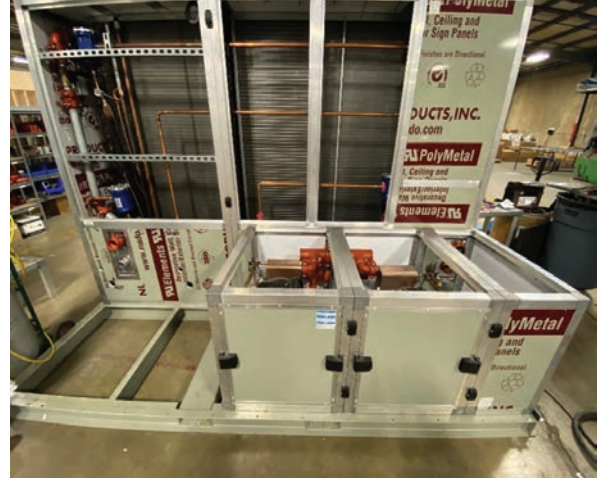

10. Build IC pipe and braze compressor B.

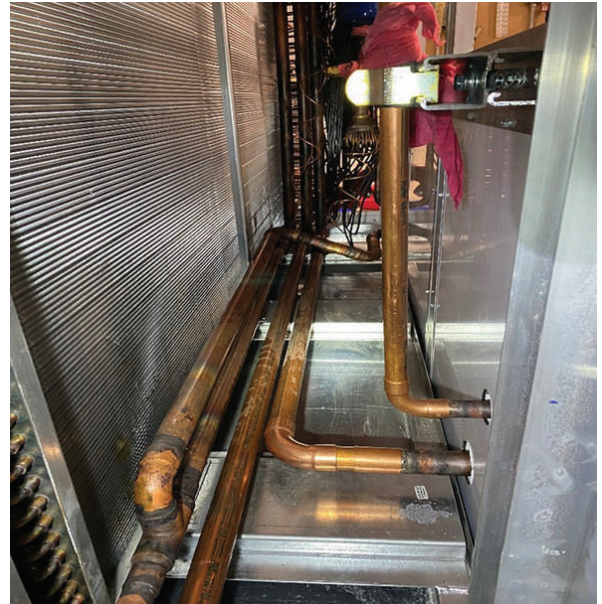

11. Unbraid caps and line up compressor C.



13. Build IC pipe and braze compressor C.

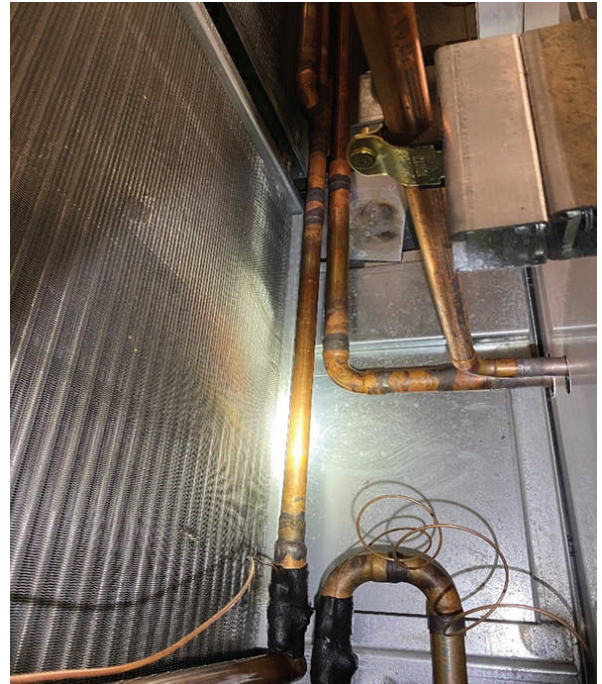

12. Push compressor C in and clamp down to compressor B using intellaclamps.



14. Unbraid caps and line up compressor D.

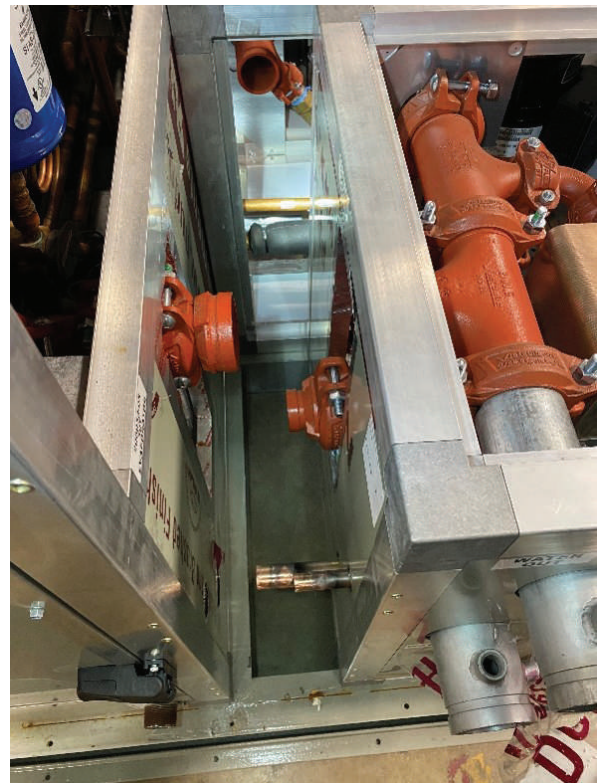

15. Push compressor D in and clamp down to compressor C using intellaclamps.



16. Clamp compressor D side to evaporator using intellaclamps.



Sealing of Unit (To Prevent Air Leaks)

1. Apply aluminum tape across the gap on top of the compressors.



2. Apply gasket around evaporator opening.



3. Apply caulk all around all fan cassette seem/gaps for good seal.



⚠ WARNING

High Pressure Water!

Failure to follow instructions below could result in death or serious injury, and equipment damage. Provide relief valve on system water piping to prevent instantaneous release of high pressure water.

NOTICE

Proper Water Treatment Required!

The use of untreated or improperly treated water could result in scaling, erosion, corrosion, algae or slime.

Use the services of a qualified water treatment specialist to determine what water treatment, if any, is required. Trane assumes no responsibility for equipment failures which result from untreated or improperly treated water, or saline or brackish water.

Condenser water piping connections are located on the right or left hand side of the unit (depending upon configuration required). All field-installed piping must conform to applicable local, state, and federal codes. To complete condenser water connections follow the procedure below.

1. Evaporator module should be in its final location and isopads installed if necessary, see [Figure 10, p. 23](#)
2. Set condensing unit and spacer cassettes in place just in front of evaporator module and line up refrigerant connections.
3. Install 3" water pipe between condensing unit cassettes ensuring that condenser water bracket is in place on each cassette to support the water pipes. Depending upon the tonnage and right hand/left hand configuration, there will be one or more sets of 3" pipe that will need to be installed between cassettes. Refer to the following figures for typical installation.

Figure 13. Condenser water bracket

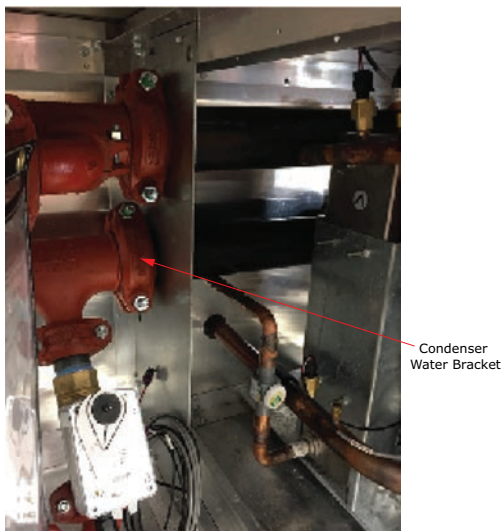

Figure 14. Condenser cassettes-1

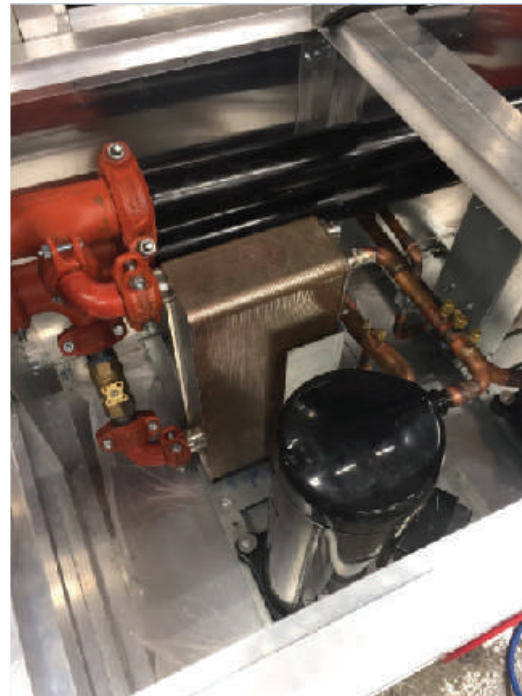

Figure 15. Condenser cassettes-2



4. Ensure that 3" tee strainer (ship with) is installed on inlet water connection.
5. Attach the water supply line to the inlet of the tee strainer, and the return line to the outlet connection. If the unit has a waterside economizer and/or control valves, these components will need

to be installed at this time.

6. If using a cooling tower, refer to [Figure 16, p. 32](#) for a typical piping circuit from the unit.
7. Ensure the water pressure to the unit does not exceed 400 psig.
8. It is recommended that water pressure is applied prior to fan cassette installation.
9. Install differential pressure switch on the water inlet and water outlet. Unit control scheme will trend water pressure drop and alert user when internal 20 mesh screen needs to be cleaned.
10. Fill and leak check water side connections.

Note: To prevent water pump damage, design system piping to provide relief when using energy saving waterside economizer valves.

Condensate Drain Connections

Note: Unit is not internally trapped. Installer will need to provide an external trap for unit to operate properly.

Locate condensate drain on the unit. Connect condensate drain piping to the 1-1/4" NPT female fitting, using at least 7/8" OD copper or 3/4" OD iron pipe. Pitch the condensate line downward a minimum of 1/2" for each 10' of horizontal run, away from the unit. Be sure to install the condensate drain "P" trap drain plug. Before starting the unit, fill the trap with water to prevent negative pressure in the fan section from impeding condensate flow. To facilitate drain pipe cleaning, install plugged tees in place of 90° elbows.

General Waterside Recommendations for Cooling Towers

Cooling tower control affects the unit cycle rates. Condenser water temperature swings from 10-15°F may cause excessive compressor, water valve, and unit cycling. Be sure to set the tower controls to minimize compressor/unit cycling.

Waterside Piping Arrangements

Install a condenser water pump between the cooling tower (either open or closed) and the self-contained unit. Lay out the remainder of the system condenser piping in reverse returns. This helps balance the system by equalizing the length of supply and return pipes. Multi-story buildings may use a direct return system with balancing valves at each floor.

Install the supply riser and its return in close proximity. Furnish both with permanent thermometers to check the waterside balance during startup and routine maintenance checks.

Also, include strainers at each pump inlet and unit. Install drain valves at the riser's base to allow drainage points for system flushing during startup and routine maintenance. For condenser draining and header

removal, include a shutoff/balancing valve on the entering and leaving waterside pipes, drain tees, and unions of each unit.

Note: Unit does not have floor drains.

Figure 16. Condenser water piping components for cooling tower system

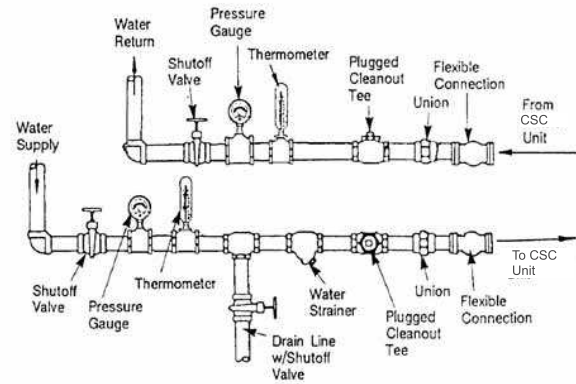

Water Temperature Requirements

Do not allow the entering water temperature to go below 54°F (12.2°C) on units with constant water flow (basic piping). This will cause the compressors to shut down and the mechanical cooling function will lockout. However, the economizer (if enabled) will continue to function. The compressors will reset when the entering water temperature reaches 58°F (15°C).

Units with variable water flow (intermediate piping) have a modulating condensing pressure control valve that allows compressor operation down to entering water temperatures of 35°F (2°C).

For more information on constant and variable water flow, see the Sequence of Operation section of this manual.

Note: Units with a waterside economizer can be set from the human interface panel for variable or constant water flow.

Water Piping Verification

- Make return and supply water connections to the unit and/or waterside economizer piping package with recommended valves and piping components.
- Install unions to allow waterside maintenance.
- Install cooling tower and standby pumps.
- Treat water to prevent algae, slime, and corrosion.
- Prevent refrigerant piping from rubbing against other objects.

Refrigerant System

Modular Self-Contained Units ship with a dry nitrogen holding charge.

Before installing refrigerant piping, verify holding charge is present. Momentarily depress the MSC suction or discharge line (and condenser liquid line) access port valves.

If charge is present, continue with piping installation.

If no nitrogen escapes the access valve, leak test the unit refrigerant system to determine the leak source, and repair. See Maintenance section, "[Refrigerant Leak Test Procedure](#)," p. 66. After finding leak, remove test pressure and repair leak using proper brazing procedures. See Maintenance section, "[Brazing Procedures](#)," p. 67. Retest unit(s) to ensure all leaks are repaired. Continue with piping installation.

Braze suction and liquid lines between evaporator module and condensing unit cassettes.

See Maintenance section, "[Refrigerant Leak Test Procedure](#)," p. 66 / "[Brazing Procedures](#)," p. 67.

Figure 17. Braze suction and liquid lines



Interconnecting Piping

Refrigerant piping must be properly sized and applied. These two factors have a significant effect on both system performance and reliability.

Install interconnecting piping using proper installation and brazing procedures.

Work on only one circuit at a time to minimize system exposure to potentially harmful moisture in the air.

Before installing piping verify compressor oil levels are near top of sight glass or above.

Note: *MSC units (and replacement compressors) ship fully charged with POE oil from the factory. Scroll compressors use POE 32 oil, DO NOT substitute.*

Capped discharge and liquid line connections are located near bottom, left side of the condensing unit cassette.

Remove caps with a tube cutter to minimize risk of getting chips inside piping.

Cleanliness is extremely important during system installation to minimize residual contaminants, such as oxidization and scale.

Tightly strap TXV bulbs to horizontal run of each suction line and insulate. Attach vacuum pump and begin evacuation as soon as piping installation is complete. This starts system dehydration and helps prevent POE compressor oil contamination. This will also indicate large leaks if vacuum does not hold (below 400 microns and hold for 2 hours). Complete Leak Test and Evacuation (for procedures, see "[Refrigerant Leak Test Procedure](#)," p. 66 and "[System Evacuation Procedures](#)," p. 68 in Maintenance section) before starting "[Preliminary Refrigerant Charging](#)," p. 34.

Note: *Use Type "L" refrigerant grade copper tubing only.*

Important: *Failure to tighten bulb to suction line, can result in erratic operation of unit.*

NOTICE

Compressor Damage!

POE oil is hygroscopic – it absorbs water directly from the air. This water is nearly impossible to remove from the compressor oil and can result in compressor failures.

To prevent POE oil from absorbing water, the system should not remain open for longer than necessary. When open, dry nitrogen should flow through the piping. Only new oil containers should be used for service and maintenance. Always use the smallest container size required for the job requirements. Always leave the oil container tightly sealed until time of use. Do not reuse oil that has been opened.

Preliminary Refrigerant Charging**⚠ WARNING****Confined Space Hazards!**

Failure to follow instructions below could result in death or serious injury.

Do not work in confined spaces where refrigerant or other hazardous, toxic, or flammable gas may be leaking. Refrigerant or other gases could displace available oxygen to breathe, causing possible asphyxiation or other serious health risks. Some gases may be flammable and/or explosive. If a leak in such spaces is detected, evacuate the area immediately and contact the proper rescue or response authority.

⚠ WARNING**Explosion Hazard!**

Failure to properly regulate pressure could result in a violent explosion, which could result in death, serious injury, or equipment or property-only-damage.

When using dry nitrogen cylinders for pressurizing units for leak testing, always provide a pressure regulator on the cylinder to prevent excessively high unit pressures. Never pressurize unit above the maximum recommended unit test pressure as specified in applicable unit literature.

⚠ WARNING**Hazardous Pressures!**

Failure to follow instructions below could result in a violent explosion, which could result in death or serious injury.

If a heat source is required to raise the tank pressure during removal of refrigerant from cylinders, use only warm water or heat blankets to raise the tank temperature. Do not exceed a temperature of 150°F. Do not under any circumstances apply direct flame to any portion of the cylinder.

⚠ CAUTION**Refrigerant at Freezing Temperature!**

Direct contact with liquid refrigerant could result in minor or moderate injury.

Avoid contact with skin. If working with refrigerant is necessary, you **MUST** wear all Personal Protective Equipment (PPE) including eye protection, safety gloves, long sleeves, and pants. In case of contact, treat the injury similar to frostbite. Slowly warm the affected area with lukewarm water and seek immediate medical attention.

NOTICE**Compressor Damage!**

Failure to follow instructions below could result in compressor failure.

If it becomes necessary to remove or recharge the system with refrigerant, it is important that the following actions are taken:

- To prevent cross contamination of refrigerants and oils, use only dedicated R-410A service equipment.
- Disconnect unit power before evacuation and do not apply voltage to compressor while under vacuum.
- Due to presence of POE oil, do not leave the system open for more than 1 hour.
- Allow the crankcase heater to operate a minimum of 24 hours before starting compressors.
- Do not allow liquid refrigerant to enter the suction line.
- Do not allow excessive liquid accumulation in the liquid lines.
- Do not operate the compressors without the proper level of refrigerant in each circuit.

Charging and Wiring the Unit**⚠ WARNING****Live Electrical Components!**

Failure to follow all electrical safety precautions when exposed to live electrical components could result in death or serious injury.

When it is necessary to work with live electrical components, have a qualified licensed electrician or other individual who has been properly trained in handling live electrical components perform these tasks.

Use the following steps to charge and wire the system:

1. Verify system leak check and evacuation are complete before adding refrigerant. See ["Refrigerant Leak Test Procedure,"](#) p. 66 and ["System Evacuation Procedures,"](#) p. 68.
2. While unit is evacuating, place starter/control module into position, but do not connect to main power until all work is complete.
3. Terminate compressor power connections, control harness, and chassis communication harness. Control harnesses are color coded for easy installation.

Figure 18. Fixed speed compressor power and communication wiring



Figure 20. Fixed speed compressor power and communication wire routing



Figure 19. Variable speed power and communication wiring



Figure 21. Compressor communication terminations



Note: Pluggable connectors are color coded and individually keyed for ease of installation.

Figure 22. Compressor power wire routing to starter panel



Figure 23. Compressor power terminations

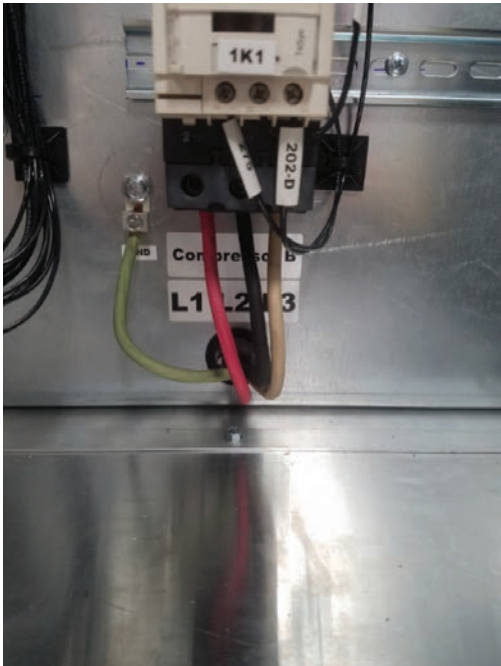

4. Verify oil is present in each compressor sight glass. (Adjust if necessary).
5. Turn field-supplied unit disconnect ON to energize crankcase heaters on fixed speed compressors. Verify crankcase heaters are operating.
6. Verify all service valves are open.
7. See MSC General Data for unit refrigerant charge.

8. Liquid charge 10 lbs of R410a initially. This will be adequate for compressor startup. More charge will be added after compressors are started. Use an accurate scale to measure and record preliminary amount of refrigerant added to each circuit.
9. Record charge amount added.
10. If total charge is not reached see Final Refrigerant Charge in Startup.
11. Verify wiring is complete.
12. Install 3D-Intelliclamp™ between all cassettes.

Figure 24. 3D-Intelliclamp™



Fan Installation

1. Place fan and fan spacer cassettes above the condensing unit cassettes.
2. Connect fan control harness and fan power connections. Control harnesses are color coded for easy installation.
3. Install 3D-Intelliclamp™ between remaining cassettes.

Figure 25. Fan power and communication wire routing



Figure 26. Fan power and communication wiring

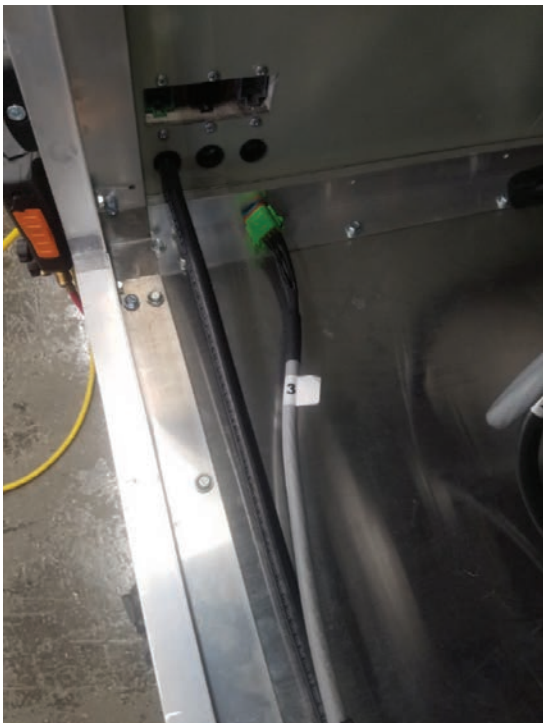

Figure 27. Fan communication terminations - pluggable connectors are color coded for ease of installation



Figure 28. Fan power terminations



Duct Connections

Return air enters the rear of the unit and conditioned supply air discharges through the top. Attach supply air ductwork directly to the unit's top panel, around the fan discharge opening. A duct collar is not provided.

Install all air ducts according to the National Fire Protection Association standards for the "Installation of Air Conditioning and Ventilation Systems other than Residence Type (NFPA 90A) and Residence Type Warm Air Heating and Air Conditioning Systems (NFPA 90B).

Make duct connections to the unit with a flexible material such as heavy canvas. If a fire hazard exists, Trane recommends using Flexweave 1000, type FW30 or equivalent canvas. Use three inches for return duct and three inches for discharge duct. Keep material loose to absorb fan vibration.

- If using return ductwork to the unit, secure it with three inches of flexible duct connector.
- Extend discharge duct upward without change in size or direction for at least three fan diameters.
- Use 3" flexible duct connection on discharge ductwork.

Run the ductwork straight from the opening. Extend remaining ductwork as far as possible without changing size or direction. Do not make abrupt turns or transitions near the unit due to increased noise and excessive static losses. Use elbows with splitters or turning vanes to minimize static losses.

Poorly constructed turning vanes may cause airflow generated noise. Align the fan outlet properly with the ductwork to decrease noise levels in the duct and to increase fan performance. To complete trunk ductwork to the VAV terminal units, refer to the VAV box manuals for specific requirements. Check total external static pressures against fan characteristics to be sure the required airflow is available throughout the ductwork.

To achieve maximum acoustical performance, minimize the duct static pressure setpoint.

Final Installation

1. Ensure all 3D-Intelliclamp™ have been installed.

Figure 29. 3D-Intelliclamp™



2. Connect static pressure tubing located to the right of the control panel:
 - a. Discharge static
 - b. Filter inlet
 - c. Filter outlet

Figure 30. Static pressure tube



3. Complete field wiring connections on field terminal strip:
 - a. E-Stop
 - b. Occupied
 - c. External auto/stop
 - d. Entering air temperature
 - e. Discharge air temperature

Electrical Installation

⚠ WARNING

Live Electrical Components!

Failure to follow all electrical safety precautions when exposed to live electrical components could result in death or serious injury.

When it is necessary to work with live electrical components, have a qualified licensed electrician or other individual who has been properly trained in handling live electrical components perform these tasks.

1. With main power still dis-connected.
 - a. Circuit breakers on.
 - b. Place fuses in fan fuse holder.
 - c. One fuse pulled on control power transformer primary.
 - d. Fan fuse holders connected, ie, closed.

- e. Variable speed compressor fuses installed.
2. At the terminal block or disconnect switch.
 - a. Verify:
 - No continuity between phases.
 - No continuity between each phase and ground.
 - b. Do not hi-pot with variable speed compressor drives or fan fuses installed or fixed speed compressor motor protection module connected.
3. Once all these items above have been verified:
 - a. Replace control power transformer primary fuse.
4. Connect main power and ground.
5. With fixed speed compressor circuit breakers, and fan fuse holders open, and variable speed compressor enable plug removed, apply power to unit using the unit or remote mounted disconnect switch.

***Important:** With a phase rotation meter, verify clockwise rotation at the terminal block using standard electrical safety procedures.*

6. After clockwise rotation is confirmed, remove main power unit and verify the unit is de-energized.
7. With fixed speed compressor circuit breakers still open, and variable speed compressor enable plug still removed, close fan fuse holders and re-apply power.

TD-7 Installation

1. Hold faceplate on front side of Low Voltage door and install TD-7 onto front of Low Voltage door.

Figure 31. TD-7 Face plate





Installation - Mechanical

Figure 32. TD-7 Installation on front



2. Attach brackets on back side of Low Voltage door to secure the TD-7 to the door.

Figure 33. TD-7 Installation on back with brackets





Installation - Electrical

Unit Wiring Diagrams

Specific unit wiring diagrams are provided on the inside of the control panel door. Use these diagrams for connections or trouble analysis.

Supply Power Wiring

It is the responsibility of the installer to provide power supply wiring to the unit terminal block or the non-fused disconnect switch option. Wiring should conform to NEC and all applicable code requirements.

Bring supply wiring through the knockout in the lower left side of the unit control panel. Connect the three phase wires to the power terminal block or the non-fused disconnect switch in the control box terminals. Refer to specific wiring diagrams and fuse information in the control panel.

⚠ WARNING

Hazardous Service Procedures!

Failure to follow all precautions in this manual and on the tags, stickers, and labels could result in death or serious injury.

Technicians, in order to protect themselves from potential electrical, mechanical, and chemical hazards, **MUST** follow precautions in this manual and on the tags, stickers, and labels, as well as the following instructions: Unless specified otherwise, disconnect all electrical power including remote disconnect and discharge all energy storing devices such as capacitors before servicing. Follow proper lockout/tagout procedures to ensure the power can not be inadvertently energized. When necessary to work with live electrical components, have a qualified licensed electrician or other individual who has been trained in handling live electrical components perform these tasks.

NOTICE

Use Copper Conductors Only!

Failure to use copper conductors could result in equipment damage as the equipment was not designed or qualified to accept other types of conductors.

NOTICE

Motor Damage!

Correct phase sequence is critical. If phase sequence of the incoming line voltage is not correct, it could result in motor damage.

Voltage Range

Voltages must be within $\pm 10\%$ the nameplate voltage. Ensure the unit voltage is balanced by measuring at the compressor terminals. Voltage imbalance on three phase systems can cause motor overheating and premature failure. Maximum allowable imbalance is 2.0%.

Voltage Imbalance

Read the voltage at the compressor terminals to determine if it is balanced. Voltage imbalance on three phase systems can cause motor overheating and premature failure. The maximum allowable imbalance is 2.0%. Voltage imbalance is defined as 100 times the sum of the deviation of the three voltages from the average (without regard to sign) divided by the average voltage. For example, if the three measured voltages are 221, 230, and 227, the average voltage would be:

$$(221 + 230 + 227) / 3 = 226 \text{ volts}$$

The percentage of voltage imbalance is then:
 $100 * (226 - 221) / 226 = 2.2\%$

Phase Monitor

Unit is equipped with phase monitor in control box. The phase monitor will protect against phase loss, imbalance and reversal of line voltage. If a fault occurs, the red LED will energize. While the fault condition is present, the phase monitor interrupts the 115V control circuit. If no faults are observed, a green LED will be energized.

Control Power

NOTICE

Component Damage!

Failure to follow instructions below could result in immediate or premature component failures. Unit transformers are sized to provide power to the unit only. Do not use these transformers to supply power to field equipment.

In this example, 2.2% imbalance is not acceptable. Whenever a voltage imbalance of more than 2.0% exists, check the voltage at the unit disconnect switch. If the imbalance at the unit disconnect switch does not exceed 2.0%, faulty unit wiring is causing the imbalance. Conduct a thorough inspection of the unit electrical wiring connections to locate the fault, and make any repairs necessary.

Access the connection terminal block through the control panel on the upper left side of the unit. All wiring should conform to NEC and applicable local code requirements.

Be sure all wiring connections are secure. Reference the unit specific diagrams inside the control panel.



Selection Procedures

- RLA = Rated Load Amps
- Compressor LRA = Locked Rotor Amps
- Compressor Input = VFD drive Input
- Compressor Output = VFD drive output
- Voltage utilization range is $\pm 10\%$

Determination of Max Fuse (MFS) and Max Circuit Breaker (MCB) Sizes

MFS and MCB = $2.25 \times$ Largest motor amps (RLA)/VFD input) + the sum of the remaining motor amps.

If the rating value calculation does not equal a standard over current protective device rating, use the next lower standard rating as the maximum.

Determination of Minimum Circuit Ampacity (MCA)

MCA = $1.25 \times$ Largest motor amps/VFD Input + the sum of the remaining motor amps.

Table 15. Number of compressors

MSC	SCWMN 04L	SCWMN 40	SCWMN 05L	SCWMN 50	SCWMN 06L	SCWMN 60	SCWMN 07L	SCWMN 70	SCWMN 08L	SCWMN 80
66cc - ZPV0662	1	0	1	0	1	0	1	0	1	0
96cc - ZPV0962	0	1	0	1	0	1	0	1	0	1
ZP154KCE-TE	0	0	2	2	0	0	3	3	0	0
ZP181KCE-TE	1	1	0	0	2	2	0	0	3	3

Table 16. Number of fans

	40 Tons	50 Tons	60 Tons	70 Tons	80 Tons
Drive (K3G500) - Motor (M3G150-IF)	3	3	4	5	5

Table 17. Compressor electrical data

Tons	MSC Compressor	200		460		200	460
		RLA	LRA	RLA	LRA	MAX INPUT	MAX INPUT
10	66CC - ZPV0662 (VFD)	-	-	-	-	56	30
15	ZP181KCE-TE	55.77	340	23.72	110	-	-
	96CC-ZPV0962 (VFD)	-	-	-	-	84	60
13	ZPV154KCE-TE	51.28	300	23.7	150	-	-

Table 18. Fan motor electrical data

	200	460
	INPUT	INPUT
Drive (K3G500) - Motor (M3G150-IF)	18.6	9

Table 19. Electrical service sizing data – motors – 40 to 80 tons

Tonnage	Model Number	Unit Wiring					Motor Data								
							Compressor (EA)						Fan (EA)		
		Nameplate Voltage	Voltage Range	MCA	MOP	Disc	Fixed Speed			Variable Speed		VSD			
							Qty	RLA	LRA	Qty	Max Input (A)	Qty	kW	FLA	
40	SCWMN04LF	208-230/60/3	187 - 253	186.6	250	200	1	55.77	340	1	56	3	6.15	18.6	
	SCWMN040F	208-230/60/3	187-253	221.6	300	225	1	55.77	340	1	84	3	6.15	18.6	
	SCWMN04L4	460/60/3	414 - 506	90.7	125	100	1	23.72	110	1	30	3	6.15	9	
	SCWMN0404	460/60/3	414-506	128.2	200	125	1	23.72	110	1	60	3	6.15	9	
50	SCWMN05LF	208-230/60/3	187 - 253	233.4	300	250	2	51.28	300	1	56	3	6.15	18.6	
	SCWMN050F	208-230/60/3	187-253	268.4	350	300	2	51.28	300	1	84	3	6.15	18.6	
	SCWMN05L4	460/60/3	414 - 506	113.2	150	125	2	23.1	150	1	30	3	6.15	9	
	SCWMN0504	460/60/3	414-506	150.7	200	150	2	23.1	150	1	60	3	6.15	9	
60	SCWMN06LF	208-230/60/3	187 - 253	260.9	300	300	2	55.77	340	1	56	4	6.15	18.6	
	SCWMN060F	208-230/60/3	187-253	295.9	375	300	2	55.77	340	1	84	4	6.15	18.6	
	SCWMN06L4	460/60/3	414 - 506	123.4	150	150	2	23.72	110	1	30	4	6.15	9	
	SCWMN0604	460/60/3	414-506	160.9	225	175	2	23.72	110	1	60	4	6.15	9	
70	SCWMN07LF	208-230/60/3	187-253	321.8	375	350	3	51.28	300	1	56	5	6.15	18.6	
	SCWMN070F	208-230/60/3	187-253	356.9	450	375	3	51.28	300	1	84	5	6.15	18.6	
	SCWMN07L4	460/60/3	414-506	154.2	175	175	3	23.1	150	1	30	5	6.15	9	
	SCWMN0704	460/60/3	414-506	191.7	250	200	3	23.1	150	1	60	5	6.15	9	
80	SCWMN08LF	208-230/60/3	187-253	335.3	400	375	3	55.77	340	1	56	5	6.15	18.6	
	SCWMN080F	208-230/60/3	187-253	370.3	450	400	3	55.77	340	1	84	5	6.15	18.6	
	SCWMN08L4	460/60/3	414-506	156.2	175	175	3	23.72	110	1	30	5	6.15	9	
	SCWMN0804	460/60/3	414-506	193.7	250	200	3	23.72	110	1	60	5	6.15	9	

Notes:

1. MCA: Minimum Circuit Ampacity is 125% of the largest compressor RLA or Drive input current, plus 100% of the other compressor (s) RLA, plus the sum of the condenser fan RLA, plus any other load rated at 1 AMP or more.
2. Maximum Breaker Overcurrent Protection (MOP): 225% of the largest compressor RLA or VSD drive Input, plus 100% of the other compressor (s) RLA, plus the sum of the condenser fan Motor/Drive FLA, plus any other load rated at 1 AMP or more.
3. Recommended disconnect switch: 110% to 115% of the sum of the RLA of the compressors, VSD drive input, fan motor/drive and controls FLA.
4. RLA: Rated in accordance with UL standard 1995
5. Local codes may take precedence.
6. Fix speed compressor are across the line starting, the VSD compressors are controlled by VSD drive. Compressors will never start simultaneously.
7. Voltage utilization range is ± 10 percent.

Table 20. Electrical data – 40 to 80 tons

Tonnage	Model Number	Nameplate Voltage	Compressor (EA)					Fan (EA)		
			Fixed Speed			Variable Speed		VSD		
			Qty	RLA	LRA	Qty	Max Input (A)	Qty	kW	FLA
40	SCWMN04LF	208-230/60/3	1	55.77	340	1	56	3	0.5	18.6
	SCWMN040F	208-230/60/3	1	55.77	340	1	84	3	6.15	18.6
	SCWMN04L4	460/60/3	1	23.72	110	1	30	3	0.5	9
	SCWMN0404	460/60/3	1	23.72	110	1	60	3	6.15	9
50	SCWMN05LF	208-230/60/3	2	51.28	300	1	56	3	0.5	18.6
	SCWMN050F	208-230/60/3	2	51.28	300	1	84	3	6.15	18.6
	SCWMN05L4	460/60/3	2	23.1	150	1	30	3	0.5	9
	SCWMN0504	460/60/3	2	23.1	150	1	60	3	6.15	9



Installation - Electrical

Table 20. Electrical data – 40 to 80 tons (continued)

Tonnage	Model Number	Nameplate Voltage	Compressor (EA)					Fan (EA)		
			Fixed Speed			Variable Speed		VSD		
			Qty	RLA	LRA	Qty	Max Input (A)	Qty	kW	FLA
60	SCWMN06LF	208-230/60/3	2	55.77	340	1	56	4	0.5	18.6
	SCWMN060F	208-230/60/3	2	55.77	340	1	84	4	6.15	18.6
	SCWMN06L4	460/60/3	2	23.72	110	1	30	4	0.5	9
	SCWMN0604	460/60/3	2	23.72	110	1	60	4	6.15	9
70	SCWMN07LF	208-230/60/3	3	51.28	300	1	56	5	6.15	18.6
	SCWMN070F	208-230/60/3	3	51.28	300	1	84	5	6.15	18.6
	SCWMN07L4	460/60/3	3	23.1	150	1	30	5	6.15	9
	SCWMN0704	460/60/3	3	23.1	150	1	60	5	6.15	9
80	SCWMN08LF	208-230/60/3	3	55.77	340	1	56	5	6.15	18.6
	SCWMN080F	208-230/60/3	3	55.77	340	1	84	5	6.15	18.6
	SCWMN08L4	460/60/3	3	23.72	110	1	30	5	6.15	9
	SCWMN0804	460/60/3	3	23.72	110	1	60	5	6.15	9

Table 21. Compressor electrical data – 40 to 80 tons

Tonnage	Model Number	Nameplate Voltage	Compressor (EA)				
			Fixed Speed			Variable Speed	
			Qty	RLA	LRA	Qty	Max Input (A)
40	SCWMN04LF	208-230/60/3	1	55.77	340	1	56
	SCWMN040F	208-230/60/3	1	55.77	340	1	84
	SCWMN04L4	460/60/3	1	23.72	110	1	30
	SCWMN0404	460/60/3	1	23.72	110	1	60
50	SCWMN05LF	208-230/60/3	2	51.28	300	1	56
	SCWMN050F	208-230/60/3	2	51.28	300	1	84
	SCWMN05L4	460/60/3	2	23.1	150	1	30
	SCWMN0504	460/60/3	2	23.1	150	1	60
60	SCWMN06LF	208-230/60/3	2	55.77	340	1	56
	SCWMN060F	208-230/60/3	2	55.77	340	1	84
	SCWMN06L4	460/60/3	2	23.72	110	1	30
	SCWMN0604	460/60/3	2	23.72	110	1	60
70	SCWMN07LF	208-230/60/3	3	51.28	300	1	56
	SCWMN070F	208-230/60/3	3	51.28	300	1	84
	SCWMN07L4	460/60/3	3	23.1	150	1	30
	SCWMN0704	460/60/3	3	23.1	150	1	60
80	SCWMN08LF	208-230/60/3	3	55.77	340	1	56
	SCWMN080F	208-230/60/3	3	55.77	340	1	84
	SCWMN08L4	460/60/3	3	23.72	110	1	30
	SCWMN0804	460/60/3	3	23.72	110	1	60

Table 22. Fan motor electrical data — 40 to 80 tons

Tonnage	Model Number	Nameplate Voltage	Fan (EA) - VSD		
			Qty	kW	FLA
40	SCWMN04LF	208-230/60/3	3	6.15	18.6
	SCWMN040F	208-230/60/3	3	6.15	18.6
	SCWMN04L4	460/60/3	3	6.15	9
	SCWMN0404	460/60/3	3	6.15	9
50	SCWMN05LF	208-230/60/3	3	6.15	18.6
	SCWMN050F	208-230/60/3	3	6.15	18.6
	SCWMN05L4	460/60/3	3	6.15	9
	SCWMN0504	460/60/3	3	6.15	9
60	SCWMN06LF	208-230/60/3	4	6.15	18.6
	SCWMN060F	208-230/60/3	4	6.15	18.6
	SCWMN06L4	460/60/3	4	6.15	9
	SCWMN0604	460/60/3	4	6.15	9
70	SCWMN07LF	208-230/60/3	5	6.15	18.6
	SCWMN070F	208-230/60/3	5	6.15	18.6
	SCWMN07L4	460/60/3	5	6.15	9
	SCWMN0704	460/60/3	5	6.15	9
80	SCWMN08LF	208-230/60/3	5	6.15	18.6
	SCWMN080F	208-230/60/3	5	6.15	18.6
	SCWMN08L4	460/60/3	5	6.15	9
	SCWMN0804	460/60/3	5	6.15	9

Static Pressure Sensor Installation (VAV units only)

Supply air static pressure controls the inverter option. A bulkhead fitting and a roll of vinyl tubing is provided for direct insertion into ductwork. If a specific head assembly or remote location is desired, then this material will be the responsibility of the installer. There are two pressure transducers mounted on the side of the control panel. The top is the static pressure transducer and the bottom is the filter differential transducer.

Sensor Location

1. Install static pressure sensor in specified location or section of ductwork most critical to the VAV operation.
2. If installation location is remote to transducer in control panel, do not exceed 250 feet for ¼-inch OD tubing or 500 feet for 3/8-inch OD tubing.

Installing the Tubing Sensor

1. Unscrew the ¼-inch bulkhead fitting provided.
2. Drill ½-inch hole in ductwork at desired location.
3. Insert male end of bulkhead fitting through the hole from inside the duct.

4. Insert ¼-inch tubing through both halves of union bulkhead fitting into ductwork.
5. Screw female end and tighten onto ductwork.
6. Run the opposite end of tubing through hole in the top of the control panel cabinet.
7. Connect to the push-on connection at the top pressure transducer in the control panel.

Figure 34. Static pressure tube

Note: If plastic tubing pulls away from a connection, trim it back before replacing it on the fitting. Stretched tubing may leak and cause faulty control.

Zone Sensor option used for Discharge Air Reset by Space Temperature

Zone Temperature Sensor, BAYSENS077 (Optional Item)



This zone sensor includes an internal thermistor and should be mounted in the zone, Model Number Digit 31=1. This sensor is available for use with all zone sensor options to provide remote sensing capabilities.

Zone Sensor Installation

⚠ WARNING

Hazardous Voltage w/Capacitors!

Failure to disconnect power and discharge capacitors before servicing could result in death or serious injury.

Disconnect all electric power, including remote disconnects and discharge all motor start/run capacitors before servicing. Follow proper lockout/tagout procedures to ensure the power cannot be inadvertently energized. For variable frequency drives or other energy storing components provided by Trane or others, refer to the appropriate manufacturer's literature for allowable waiting periods for discharge of capacitors. Verify with a CAT III or IV voltmeter rated per NFPA 70E that all capacitors have discharged.

NOTICE

Use Copper Conductors Only!

Failure to use copper conductors could result in equipment damage as the equipment was not designed or qualified to accept other types of conductors.

Note: For additional information regarding the safe discharge of capacitors, see PROD-SVB06*-EN

All sensor options ship in the main control panel and are field installed. Programmable option installation procedures.

Mounting Location

Mount the sensor on the wall in an area with good air circulation at an average temperature. Avoid mounting space temperature sensor in areas subject to the following conditions:

- Drafts or "dead" spots behind doors or in corners
- Hot or cold air from ducts
- Radiant heat from the sun or appliances
- Concealed pipes and chimneys
- Unheated or non-cooled surfaces behind the sensor, such as outside walls
- Airflows from adjacent zones or other units

To mount the sensors, remove the dust cover and mount the base on a flat surface or 2" x 4" junction box. Sensors ship with mounting screws.

Mounting the Subbase

Remove the zone sensor cover from subbase, and mount subbase on the wall or on a 2" x 4" junction box. Route wires through the wire access hole in the subbase. See [Figure 35, p. 47](#). Seal the hole in the wall behind the subbase.

Notes:

- Guidelines for wire sizes and lengths are shown in *Table 23, p. 47*. The total resistance of these low voltage wires must not exceed 2.5 ohms per conductor. Any resistance greater than 2.5 ohms may cause the control to malfunction due to excessive voltage drop.
- Do not run low-voltage control wiring in same conduit with high-voltage power wiring.

Wiring

1. Run wires between the unit control panel and the zone sensor subbase. To determine the number of wires required, refer to the unit wiring diagrams.
2. Connect the wiring to the appropriate terminals at the unit control panel and at the zone sensor subbase. In general, zone sensor connections to the unit use the convention of connecting zone sensor terminals to like numbered unit terminals (1 to 1, 2 to 2, etc.). The connection detail is shown on the unit wiring diagrams, which are located in the unit control panel.
3. Replace the zone sensor cover back on the subbase and snap securely into place.

Standard Remote Sensor (BAYSENS077)

When using the remote sensor, BAYSENS077, mount it in the space that is to be controlled. Wire according to the interconnecting wiring diagrams on the unit.

Table 23. Zone sensor maximum lengths and wire size

Distance from Unit to Controller	Recommended Wiring Size
0-150 feet	22 gauge
151-240 feet	20 gauge
241-385 feet	18 gauge
386-610 feet	16 gauge
611-970 feet	14 gauge

Figure 35. Typical zone sensor installation

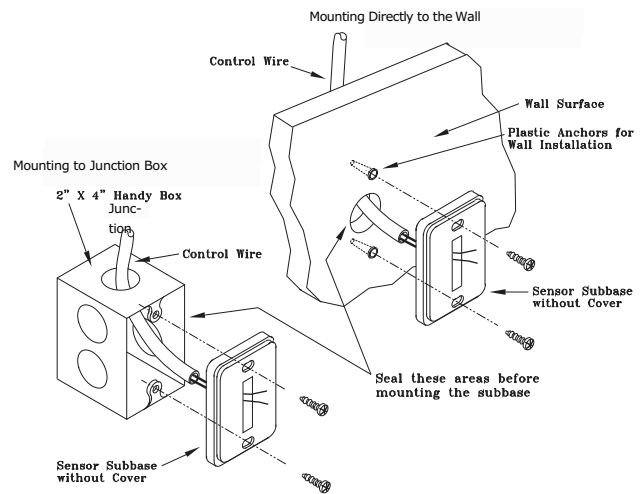



Operating Principles

Control Sequences of Operation

Occupied/Unoccupied Switching

There are three ways to switch occupied/unoccupied:

1. Field-supplied contact closure (hardwired binary input to field wiring terminal block (2TB3)) — This input accepts a field supplied switch or contacts closure such as a time clock. Open Contacts = Unoccupied and Closed Contacts = Occupied.
2. BACnet® MSTP control system can control the occupied/unoccupied request of the unit.
3. Through the TD7 Display via the on-board schedule.

Compressor Lead/Lag

Compressor lead/lag is present in the controls for all units with two or more fixed speed compressors. Only Compressors 2 and 3 rotate. Balanced run hours is achieved by changing the fixed speed compressors sequence number when commanded to rotate.

Variable speed compressor A is always the first stage on and last stage to turn off for mechanical cooling.

Emergency Stop Input

A binary input is provided on the unit's field wiring terminal block (2TB3) for installation of a field-provided switch or contacts to immediately shutdown all unit functions. An open contact will indicate an emergency shutdown condition exist and shut down the unit and generate a manual reset alarm. A closed set of contacts will indicate a normal condition. After the contacts are closed, the manual reset alarm must be cleared to resume unit operations.

External Auto/Stop Input

A binary input is provided on the unit's field wiring terminal block (2TB3) for installation of a field-provided switch or contacts to safely shutdown all unit functions. An Open contact will indicate a Stop condition exist and the unit will shutdown and generate an automatic reset alarm. A Closed contact will indicate an Auto condition and allow the unit to operate.

Local Auto Stop

A binary value is located on the TD7 which allows the user to start and stop the unit in a safe manner for maintenance. On the TD7 home screen in the upper right hand corner the unit can be put into Auto to perform normally or Stop to perform a controlled shutdown and keep the unit off.

Water Flow Control

With compatible piping configurations, the unit can be configured to provide variable water flow with the

water regulating valve option only, which maximizes energy saving by unloading the water pumping system.

Head Pressure Control

Water-cooled condensers: Units that are ordered with the optional flow control valves and configured for variable water flow will modulate a water valve to maintain a user-defined condensing pressure setpoint and compressor refrigerant pressure differential. Condensing pressure and pressure differential will be referenced utilizing factory installed suction and discharge pressure sensors located at each condenser.

Water Purge

This user-definable feature allows the user to select a purge schedule to automatically circulate water through the economizer and condensers periodically during non-operational times. This allows fresh chemicals to circulate in waterside heat exchangers.

Supply Air Temperature Control Unit Sequence of Operation

Discharge Air High Temp Limit Software Alarm (Software)

When the Discharge Air Temperature is above the Discharge Air High Temperature Cutout setpoint of 100 degrees for 5 minutes, the unit will perform a controlled shutdown. A Manual Reset alarm will be generated and need to be cleared before the unit can resume operating.

Condenser Water Low Temperature Alarm (Software)

When either the entering or leaving condenser water temperature is below the Condenser Water Low Temperature cutout setpoint of 35 degrees for 5 minutes, the unit will perform a controlled shutdown. All Condenser water valves will be commanded open if installed, and a manual reset diagnostic will be generated and need to be cleared before the unit can resume operation.

Leaving Air Low Temperature Alarm

When the Discharge Air Temperature is below the Discharge Air Temperature Cutout for 5 minutes, the unit will perform a controlled shutdown. A Manual Reset alarm will be generated and need to be cleared before the unit can resume operation.

Occupied Fan Operation

When all alarms are cleared, the unit is occupied, and the local auto stop is in auto, all fans that are available will start up and operate at 30% speed for 45 seconds. The fans will then release to control to the duct static pressure setpoint. The fans will modulate to maintain the Duct Static Pressure at the Duct Static Pressure Setpoint. The fans are commanded off during the unoccupied mode.

Heat/Cool Mode

The unit is in Cooling mode by default. The front end Building Automation System will switch the Heat/Cool Mode request multistate value between the Heating and Cooling modes to get the desired control.

Cooling/Waterside Economizer

During occupied cooling mode, the waterside economizer option and mechanical cooling are used to control the supply air temperature. The supply air temperature setpoint is user defined at the human interface panel.

After the fans run for 5 minutes, and a call for cooling is calculated, the Cooling Tower/Pump Command is turned on. After the Condenser Water flow switch closes proving flow, the Compressors and/or Economizer will be allowed to start.

Waterside economizing enables when the unit's entering water temperature is less than the entering mixed air temperature. This is set at Waterside Economizer Enable Offset setpoint. The factory default is 7°F, but can be adjusted by the user at the TD7 or via BACnet.

The economizer acts as the first stage of cooling. If the economizer is unable to maintain the supply air setpoint, the compressor module will bring on the compressors as required to meet the setpoint. If the unit does not include an economizer, only mechanical cooling will satisfy cooling requirements.

Thermostatic Expansion Valve

NOTICE

Compressor Damage!

Do not operate with water loops with less than five minutes circulation time as it could result in poor superheat control and compressor damage.

Refrigerant system reliability and performance is heavily dependent upon proper superheat. The importance of maintaining the proper superheat cannot be overemphasized. Accurate measurements of superheat will provide the following information:

- How well the expansion valve is controlling the refrigerant flow.
- The efficiency of the evaporator coil.

- The amount of protection the compressor is receiving against flooding.

The expected range for superheat is 11-15°F at full load conditions. At part load, expect a properly adjusted expansion valve to control to 8-12°F superheat.

Systems operating with lower superheat could cause serious compressor damage due to refrigerant floodback.

Fan Operation

Multiple, identical fans are arranged in the fan cabinet to meet the customer's airflow and static requirements. Each fan's speed, start/stop command, and fault status are controlled and monitored individually by the unit controller. However, all fans receive the same fan speed signal to meet airflow and static demand, and all fans are commanded On upon Unit Controller status transition to Occupied Mode.

Each fan assembly has its own motor with integrated variable speed drive (VSD). Each fan VSD varies the speed of the fan proportional to a 0-10 Vdc signal supplied by the XM70.1 module (and XM30.5 on 70-80 ton units).

The VSD starts and stops the fan according to the Enable/Disable Binary Output from the XM32.2 module (and XM32.4 on 70-80 ton units). If the VSD is faulted it annunciates this via a dry contact that is sensed by the Unit Controller on the XM70.1 module (XM30.5 on 70-80 ton units).

Supply Air Static Pressure High Limit

During normal operation, the Supply Air Static is monitored. If at any time the static pressure exceeds the software high static limit (defaulted at 2.0 inches from the factory) the unit will immediately shut down and generate a diagnostic.

In order for the unit to resume operation, the Alarm Reset must be toggled from the TD7. The software high static limit can be user adjusted at the TD7.

Compressors

The MSC uses a combination of one variable speed compressor (VS) and one, two or three fixed speed compressors (FS) for mechanical cooling.

The VS compressor is always the first compressor on and last compressor off, except in the event of a VS Compressor or Circuit lockout. A balanced starts routine is used by the Unit Controller when starting FS compressors.

Compressor Oil

All compressors have an Oil Sight Glass. Always ensure oil is visible in the sight glass when the compressor is off or running.



Operating Principles

High Pressure Cutout Switch (HPC)

Each VS and FS compressor has an HPC installed in its discharge line. The switch is set to open at 553 psi +/- 15 and re-close at 424 +/- 30.

Important: *The HPC is wired into each compressors Enable circuit, and the VS and FS compressor enable circuit are unique. The FS compressor enable circuit uses 24 Vac power sourced from the Control Power Transformer, where the VS compressor enable circuit uses 24 Vdc power sourced from the VS compressor drive. Inadvertently applying 24 Vac to the VS drive terminal block will permanently damage the drive.*

On the fixed speed compressors, if an HPC opens, the 24 Vac power that energizes the compressor start contactor is interrupted and the compressor will turn off. The Unit Controller will detect this and lock the circuit out on a High Pressure Cutout.

On the variable speed compressor, a 24 Vdc signal originates from terminal #22 on the 1U1 and is routed through the NC contact of the VS compressor HPC. That signals return must be sensed on terminal #31 of the 1U1. If that signal is lost due to an HPC or Emergency Stop input, the compressor will immediately shut down. The Unit Controller will detect HPC trip and lock the circuit out on a High Pressure Cutout.

Compressor Input/Output Module

Each compressor has a dedicated XM30 input/output module that communicates digitally with the Unit Controller (XM30.8, 9, 10, and 11 for compressors A, B, C, and D, respectively). The XM30 module is used to sense its respective suction and discharge pressure sensor, suction temperature sensor, and control the condenser water regulating valve via a 0-10 Vdc output.

Compressor Pressure Sensors

Each compressor has its own set of suction and discharge pressure sensors. The sensors are powered by the 5 Vdc power supply 2U1. Their range is 0-600 psig and their voltage output is linearly proportional to the sensed pressure.

The discharge pressure sensor is used by the Unit Controller to do the following:

- control the optional WRV (if equipped)
- compute compressor differential pressure
- warn the user if a high discharge pressure condition occurs
- activate the VS compressor Limit Condition control function

The suction pressure sensor is used by the Unit Controller to do the following:

- detect low suction pressures
- compute compressor suction superheat
- compute compressor differential pressure
- activate the VS compressor Limit Condition control function

Compressor Suction Temperature

Each compressor has its own suction temperature thermistor. It is used to compute compressor suction superheat. If superheat is less than 4 degrees for 5 minutes, or more than 25 degrees for 10 minutes, the circuit is locked out on a fault and a diagnostic is annunciated.

Fixed Speed Compressor (FS)

Each FS compressor has two 24 Vac, 30W crankcase heaters. The power for these heaters is routed through a NC auxiliary contact on it's respective start contactor. This way the heater is energized whenever the compressor is Off.

In each FS compressor motor junction box is a 24 Vac powered CoreSense™ compressor protection module (MCSP). This module displays compressor status and diagnostics and provides the following protections:

- motor temperature protection
- missing phase protection
- reverse phase protection
- low control circuit voltage protection
- short cycling detection and alert

If the CoreSense™ module detects a fault condition it opens a dry contact on the module interrupting power to that compressors run contactor coil. The power interruption is detected by the Unit Controller, which disables the compressor and annunciates a Compressor Safety Circuit diagnostic. After the cause of the fault is remedied, a latching fault can be cleared by cycling 24 Vac module power.

Compressor Safety Circuit

Each fixed speed compressor has a Compressor Safety Circuit intended to protect the circuit from a variety of fault conditions and to distinguish those failures from HPC trips.

For each FS compressor, 24 Vac power is routed in order from the control power transformer (CPT) through its respective:

1. HPC
2. MCSP dry contact
3. Circuit breaker auxiliary-1CB1, 1CB2, or 1CB3
4. Start/Stop NO contact on the XM32 binary output module
5. Compressor start contactor coil-1K1, 1K2 or 1K3

6. From the compressor start contactor coil the same 24 Vac signal is routed through the contactor NO auxiliary to an isolating relay-2K2, 2K4 or 2K8

If any of these devices contacts should open, 24 Vac is interrupted from the compressor start contactor and the compressor will shut off.

The Unit Controller can distinguish between an HPC switch opening and any of the other devices in the circuit opening. It will annunciate either High Pressure Cutout Compressor X or Compressor Safety Circuit X.

Variable Speed Compressor (VS)

The VS compressor does not have an external crankcase heater (like FS compressors). Instead, whenever the VS compressor is off, the VS drive applies a voltage to the compressor motor stator such that the compressor doesn't rotate but heats the oil.

The VS drive, 1U1, has its own software to control and protect the VS compressor. See [Figure 37, p. 52](#) for VSD Input/Output terminals.

The drive receives the following signals from the Unit Controller:

- Controlled Start/Stop
- Speed signal
- Drive Reset
- Stator Heat Enable
- Emergency stop

Note: The 24 Vdc voltage used in each of the circuits above -except the speed signal-originate from the VS drive.

The drive provides the following signals to the Unit Controller:

- Compressor On status
- Drive Fault status

Upon a call for mechanical cooling, the Unit Controller issues the command to start the compressor via a dry contact closure on XM32.3. When the 1U1 drive receives a Controlled Start signal it runs the compressor at 3600 rpm for 60 seconds. The compressor then runs at whatever speed commanded by the Unit Controller. Similarly, when the 1U1 drive receives a Controlled Stop signal it runs the compressor at 3600 rpm for 60 seconds then turns the compressor off.

The VS compressor HPC is wired in series with the 1U1 E-stop circuit. A VS compressor HPC event or upon a Unit Controller remote Emergency Stop input will immediately stop the VS compressor and lockout its operation on a manually resettable diagnostic.

Compressor Limit Conditions

Because the MSC uses suction and discharge pressure sensors rather than limit switches, the Unit Controller

can sense when a refrigerant circuit is approaching a high or low pressure limit condition.

Low Pressure Limit conditions can be caused by the following:

- low discharge air temperature
- low airflow
- dirty air filters
- TXV malfunction
- low refrigerant charge
- faulty suction pressure sensor

High Pressure Limit conditions can be caused by the following:

- low condenser water flow
- high entering condenser water temperature
- fouled entering condenser water strainer
- TXV malfunction
- refrigerant over charge
- water regulating valve (WRV) malfunction
- faulty discharge pressure sensor

The Unit Controller's TD7 will annunciate a Limit Condition if an FS compressor circuit enters one. If the unit is equipped with WRV, the Unit Controller can open the valve to allow more flow through the condenser to help mitigate HPC trip.

If the VS circuit enters either a High or Low Pressure limit condition the Unit Controller can reduce compressor speed to help mitigate either a Low or High pressure diagnostic trip.

Figure 36. Fixed speed compressor protection module (MCSP)

ALERT CODE (RED) / CÓDIGO DE ALERTA (ROJO)	TYPE / TIPO	EVENT / EVENTO
SOLID / SOLIDO	LOCKOUT / PERDIDA DE FUNCION	LOSS OF FUNCTION / PERDIDA DE FUNCION
1	TRIP / INTERRUCCION DE FUNCION	MOTOR HIGH TEMPERATURE / TEMPERATURA DE MOTOR ELEVADA
2	LOCKOUT/TRIP / PERDIDA DE FUNCION	OPEN SHORT MOTOR WINDINGS / ABERTO/CORTOCIRCUITO
3	LOCKOUT / PERDIDA DE FUNCION	SHORT CYCLING / CICLO FRECUENTE
4	N/A	N/A
5	N/A	FUTURE USE / USO FUTURO
6	LOCKOUT/TRIP / PERDIDA DE FUNCION	MISSING PHASE / FASE FALTANTE
7	LOCKOUT / PERDIDA DE FUNCION	REVERSE PHASE / FASE AL REVES
8	N/A	FUTURE USE / USO FUTURO
9	TRIP / INTERRUCCION DE FUNCION	MODULE LOW VOLTAGE / BAJO VOLTAJE AL MODULO

WARNING (GREEN) / PRECAUCION (VERDE)	TYPE / TIPO	EVENT / EVENTO
SOLID / SOLIDO	NORMAL / NORMAL	NORMAL OPERATION / OPERACION NORMAL
1	WARNING / PRECAUCION	LOSS OF COMMUNICATION / PERDIDA DE COMUNICACIONES
2	WARNING / PRECAUCION	FUTURE USE / USO FUTURO
3	WARNING / PRECAUCION	SHORT CYCLING / CICLO FRECUENTE
4	N/A	N/A
5	WARNING / PRECAUCION	FUTURE USE / USO FUTURO

DIP SWITCH	PURPOSE / PROPOSITO	ON = 1 / ENCENDIDO	OFF = 0 / APAGADO
1	UNIQUE ADDRESS RANGE 1 TO 32 (EXAMPLE = 12)	0	0
2	BAUD RATE / VELOCIDAD	9600	19200
3	COMMUNICATION / COMUNICACION	ENABLE / ACTIVADO	DISABLE / DESACTIVADO
4	TEMP CONNECTOR CONFIGURATION / CONFIGURACION DE CONECTOR DE TEMPERATURA	0	0
5	SHORT CYCLE PROTECTION / PROTECCION CONTRA CICLOS FRECUENTES	ENABLE / ACTIVADO	DISABLE / DESACTIVADO

SYMBOLS / SIMBOLOS

- 1) PROTECTION MODULE VOLTAGE (VOLTAGE DEL MODULO DE PROTECCION)
- 2) TO CONTROL CIRCUIT (PARA CONTROLAR EL CIRCUITO)
- 3) THERMAL SENSORS DO NOT SHORT (SENSORES DE TEMPERATURA-NO CONECTAR EN CORTO CIRCUITO)
- 4) PHASE SENSING / SENSOR DE FASES

USE COPPER CONDUCTIONS ONLY
 USE MINIMUM 18 AWG WIRE FOR AMPLACITY DETERMINATION.
 USE THIS EQUIPMENT ON A GROUNDED SYSTEM ONLY.
 PRIMARY SINGLE PHASE FAILURE PROTECTION IS PROVIDED.
 PROTECTION MODULE AND OPTIONAL CRANKCASE HEATER MUST BE CONNECTED ONLY TO THEIR RATED VOLTAGE.
 SUBSEQUENT PROTECTION DEVICES MUST BE INSTALLED TYPE MUST BE IN ACCORDANCE WITH REGULATORY AGENCY END PRODUCT APPROVALS.
 SEE SYSTEM NAMEPLATE.

PARA DETERMINAR LA AMPACIDAD DEL CABLE ESCOGA CABLE DE 18 AWG.
 PARA ESTE EQUIPAMIENTO EN SISTEMAS CONECTADOS A TIERRA.
 LA PROTECCION DE FALLA DE FASE PRIMARIA MONOFASICA SE PROVEE EN ESTE DISPOSITIVO.
 EL MODULO DE PROTECCION Y EL CALENTADOR DE CARTER OPCIONAL DEBEN SER CONECTADOS UNICAMENTE A SU VOLTAJE NOMINAL RESPECTIVO.
 EL TIPO Y LAS CARACTERISTICAS NOMINALES DE LA PROTECCION DE SOBRECORRIENTE DEBEN RESPONDER A LAS ESPECIFICACIONES DE LA AGENCIA DE CERTIFICACION DEL EQUIPO.

09-13 052-0841-00

Figure 37. Variable speed compressor drive I/O

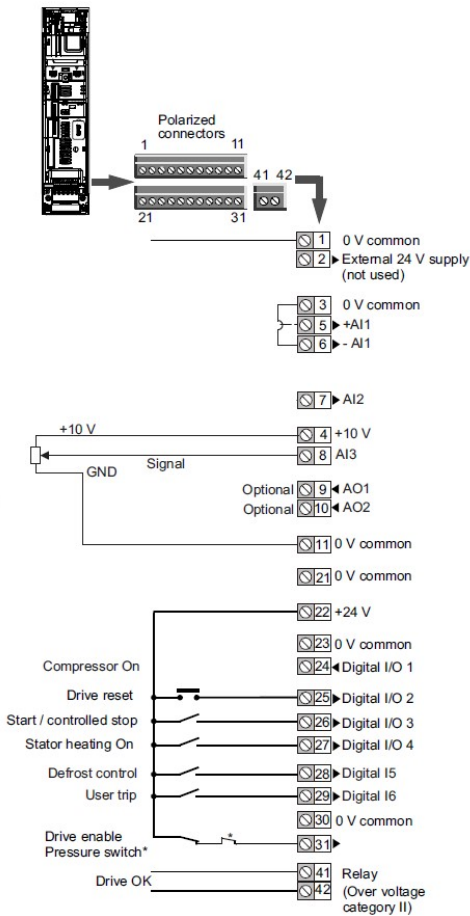

Compressor Staging

Fixed speed compressors cycle and the variable speed compressor loads/unloads to maintain the operating state required by the temperature controls. In the event of a compressor failure, the next available compressor turns on. During normal conditions, compressors will not turn on until they have been off for at least three minutes. Normal operating conditions are established on an individual compressor basis. When a compressor starts, its timer also starts.

Compressor Control

Steps of mechanical cooling are control based on supply air or zone temperature. Compressor staging is based upon a proportional, integrating (PI) control algorithm.

Waterside Components

Waterside components consist of water piping, water valves, water flow switch option, water cooled condensers, and the economizer option.

Water Purge

NOTICE

Proper Water Treatment Required!

The use of untreated or improperly treated water could result in scaling, erosion, corrosion, algae or slime.

Use the services of a qualified water treatment specialist to determine what water treatment, if any, is required. Trane assumes no responsibility for equipment failures which result from untreated or improperly treated water, or saline or brackish water.

Automatically circulate water through the economizer and condensers periodically during non-operational times. This allows fresh chemicals to circulate in waterside heat exchangers. This feature is on all units and is controlled at the HI.

Water Piping Options

Water piping is factory-installed with left-hand (standard) and right hand (optional) connections on units. Also, units with waterside economizers can be set for either variable or constant water flow at the HI. See for detailed piping configuration information.

With compatible piping configurations, the unit can be configured to provide:

- Constant water flow with basic or intermediate piping

or

- Variable water flow (head pressure control)

Constant water flow is for condenser pumping systems that are not capable of unloading the water-pumping system. Variable water flow maximizes energy saving by unloading the water pumping system.

Basic Water Piping

This option is available on units without a waterside economizer and with condenser water applications above 54°F (12.2°C) that do not require condensing pressure control. Left hand water connections and piping are extended to the unit exterior. Manifold piping is factory installed.

Water Regulating Valve (WRV) optional

If equipped, each compressor (Fixed or VS) uses a 24 Vac powered water regulating ball valve to control flow through the condenser. The UC600 controller modulates the condenser flow to limit discharge pressure, help prevent high pressure cutout trips, and maintain a compressor minimum differential pressure.

The valve can also be used for condenser system chemical purge and condenser cooling loop system balance.

Water Flow Switch Option

A water flow switch is required to be installed in the condenser water pipe within the unit; it can be supplied from the factory as an option or it can be field-provided. Whenever the flow switch detects a water flow loss prior to or during mechanical cooling, compressor operation locks out and a diagnostic code displays. If water flow is restored, the compressor operation automatically restores.

Waterside Economizer Option

The waterside economizer option takes advantage of cooling tower water to either pre-cool the entering air to aid the mechanical cooling process or, if the water temperature is low enough, provide total system cooling.

The waterside economizer includes a coil, modulating valves, controls, and piping. The coil construction is 1/2-inch (13 mm) OD seamless copper tubes expanded into aluminum fins. The evaporator and economizer coils share a common sloped (IAQ) drain pan. Drain pan options are either galvanized or stainless steel, and insulated.

The tubes are arranged in a staggered pattern to maximize heat transfer. The coil has round copper supply and return headers with removable clean-out and vent plugs.

Figure 38. Basic water piping, constant water flow

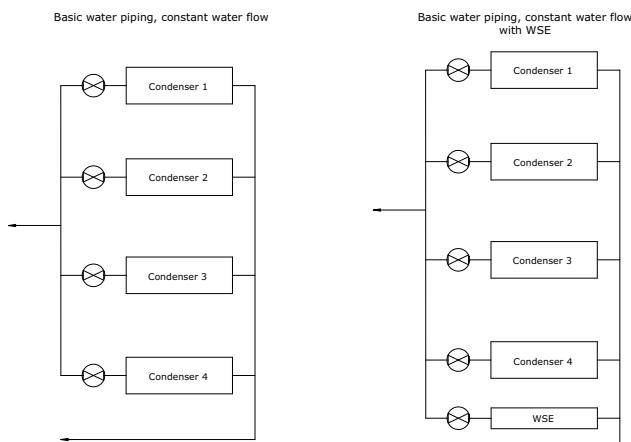

Heat Mode

The BAS Heat option consists of a fin and tube hot-water coil, an electrically actuated ball valve, and control software.

When the MSC Operating Mode is set to BAS HEAT, the UC600 controller ends any Cooling Mode operation (Mechanical and/or Water Side Economizer) and transitions to control Discharge Air Temperature to the BAS HEAT setpoint temperature. The UC600 does this by opening and closing the Heating ball valve. The Fan Array is controlled normally to maintain static pressure to the Static Pressure Setpoint.

If the Discharge Air Temperature exceeds 104°F a Manually Resettable High Discharge Air Temperature Diagnostic is annunciated.

High Duct Temperature Thermostat

An optional factory-supplied temperature limit switch with reset element detects the supply air duct temperature. This sensor should be field-installed downstream from the discharge in the supply air duct. If the supply air duct temperature exceeds 240°F (115.6°C), the unit shuts down and displays a diagnostic. A manual reset is required at the unit. High duct temperature can be adjusted at thermostat.

Dirty Air Filter Sensor Option

A factory installed differential pressure sensor senses the pressure differential across the filters. When the differential pressure exceeds a user selectable setting will display a diagnostic. The unit will continue to run until you replace the air filters.

Supply Air Static Pressure High Limit

During normal operation, the Supply Air Static is monitored. If at any time the static pressure exceeds the software high static limit (defaulted at 2.0 inches from the factory) the unit will immediately shut down and generate a diagnostic.

In order for the unit to resume operation, the Alarm Reset must be toggled from the TD7. The software high static limit can be user adjusted at the TD7.



Controls

Unit Controller

The MSC uses the UC600 control platform for monitoring and control. XM expansion modules are used to expand the UC600's I/O capabilities.

In the control panel, the following modules are used:

- UC600
- TD-7 touch screen display and user interface
- XM70.1
- XM32.2
- XM32.3
- XM32.12
- XM32.4 (70-80 ton units only)
- XM30.5 (70-80 ton units only)
- XM30.6 (70-80 ton units only)
- XM32.13-GBAS option
- XM30.14-GBAS option
- XM30.15-GBAS option

Note: The number after the dot in the name (example: XM30.#) is the IMC bus address, which is set using the rotary switches on the module.

Remotely mounted in the compressor cassettes, the following modules are used:

- XM30.7-Entering/Leaving Condenser water temperature sensors, condenser water strainer in/out water pressure sensors
- XM30.8-Compressor A: discharge/suction pressure sensors, suction temperature, and WRV position control
- XM30.9-Compressor B: discharge/suction pressure sensors, suction temperature, and WRV position control
- XM30.10-Compressor C: discharge/suction pressure sensors, suction temperature, and WRV position control
- XM30.11-Compressor D: discharge/suction pressure sensors, suction temperature, and WRV position control

Table 24. Points list

Hardware Connection		Point Name	Point Setup
UC600	PI	Supply Duct Static Pressure Sensor	Honeywell Pressure Sensor
	BO1	—	—
	BO2	—	—
	BO3	—	—
	BO4	—	—
	AO1/UI9	Water Side Economizer	2 Vdc = 0%, 10 Vdc = 100%
	AO2/UI10	High Duct Temp Cutout (Optional)	Open = Tripped, Closed = Normal
	AO3/UI11	Compressor 1 Speed Command	1.7 Vdc = Min Speed, 10 Vdc = Max Speed
	AO4/UI12	Compressor 1 High Pressure Cutout	Open = Alarm, Closed = Normal
	AO5/UI13	Compressor 2 High Pressure Cutout	Open = Alarm, Closed = Normal
	AO6/UI14	Compressor 2 Safety Circuit Stauts	Open = Circuit Open, Closed = Circuit Complete
	UI1	Compressor 3 High Pressure Cutout	Open = Alarm, Closed = Normal
	UI2	Compressor 3 Safety Circuit Status	Open = Circuit Open, Closed = Circuit Complete
	UI3	Discharge Air Temperature Local	10K Ohm Resistor Trane Type 2
	UI4	Entering Air Temperature Local	10K Ohm Resistor Trane Type 2
	UI5	ESTOP	Open = Normal, Closed = Emergency Stop
	UI6	Exterior Auto/Stop	Open = Auto, Closed = Exterior Stop
	UI7	Compressor 1 Status	Open = Off, Closed = Runing
UI8	Occupancy Input	Open = Unoccupied, Closed = Occupied	
XM70.1	PI	Air Filter Differential Pressure	Honeywell Pressure Sensor
	BO1	Heat Output 1	Open = Off, Closed = On
	BO2	Heat Output 2	Open = Off, Closed = On
	BO3	Heat Output 3	Open = Off, Closed = On
	BO4	—	—
	AO1/UI9	Supply Fan 1 Speed Command	0 Vdc = 0%, 10 Vdc = 100%
	AO2/UI10	Supply Fan 2 Speed Command	0 Vdc = 0%, 10 Vdc = 100%
	AO3/UI11	Supply Fan 3 Speed Command	0 Vdc = 0%, 10 Vdc = 100%
	AO4/UI12	Supply Fan 4 Speed Command	0 Vdc = 0%, 10 Vdc = 100%
	AO5/UI13	Morning Warmup Input	Open = Off, Closed = Morning Warmup
	AO6/UI14	Heating Output 1 Command	2 Vdc = 100% Open, 10 Vdc = 0% Open
	UI1	Supply Fan 1 VFD Fault	Open = Normal, Closed = Fault
	UI2	Supply Fan 2 VFD Fault	Open = Normal, Closed = Fault
	UI3	Supply Fan 3 VFD Fault	Open = Normal, Closed = Fault
	UI4	Supply Fan 4 VFD Fault	Open = Normal, Closed = Fault
	UI5	Space Temperature Local	10K Ohm Resistor Trane Type 2
	UI6	—	—
	UI7	Compressor 1 VFD Fault	Open = Normal, Closed = Alarm
UI8	Condenser Water Flow Switch	Open = No Flow, Closed = Flow	
XM32.2	BO1	Supply Fan 1 Start Stop Command	NO Open = Stop, NO Closed = Run; NC not used
	BO2	Supply Fan 2 Start Stop Command	NO Open = Stop, NO Closed = Run; NC not used
	BO3	Supply Fan 3 Start Stop Command	NO Open = Stop, NO Closed = Run; NC not used
	BO4	Supply Fan 4 Start Stop Command	NO Open = Stop, NO Closed = Run; NC not used



Controls

Table 24. Points list (continued)

Hardware Connection		Point Name	Point Setup
XM32.3	BO1	Compressor 1 Start Stop Command	NO Open = Stop, NO Closed = Run; NC not used
	BO2	Compressor 2 Start Stop Command	NO Open = Stop, NO Closed = Run; NC not used
	BO3	Compressor 3 Start Stop Command	NO Open = Stop, NO Closed = Run; NC not used
	BO4	Compressor 1 VFD Reset	NO Open = Normal, NO Closed = Reset; NC not used
XM32.4	BO1	Supply Fan 5 Start Stop Command	NO Open = Stop, NO Closed = Run; NC not used
	BO2	Supply Fan 6 Start Stop Command	NO Open = Stop, NO Closed = Run; NC not used
	BO3	Compressor 4 Start Stop Command	NO Open = Stop, NO Closed = Run; NC not used
	BO4	—	—
XM30.5	AO1/UI1	Supply Fan 5 Speed Signal	0 Vdc = 0%, 10 Vdc = 100%
	AO2/UI2	Supply Fan 6 Speed Signal	0 Vdc = 0%, 10 Vdc = 100%
	AO3/UI3	Supply Fan 5 VFD Fault	Open = Normal, Closed = Fault
	AO4/UI4	Supply Fan 6 VFD Fault	Open = Normal, Closed = Fault
XM30.6	AO1/UI1	Compressor 4 Safety Circuit Status	Open = Circuit Open, Closed = Circuit Complete
	AO2/UI2	Compressor 4 High Pressure Cutout	Open = Alarm, Closed = Normal
	AO3/UI3	—	—
	AO4/UI4	—	—
XM30.7	AO1/UI1	Condenser Water Entering Temperature	10K Ohm Resistor Trane Type 2
	AO2/UI2	Condenser Water Leaving Temperature	10K Ohm Resistor Trane Type 2
	AO3/UI3	Condenser Screen Pressure Drop High	0.5 Vdc = 0 PSI, 4.5 Vdc = 500 PSI
	AO4/UI4	Condenser Screen Pressure Drop Low	0.5 Vdc = 0 PSI, 4.5 Vdc = 500 PSI
XM30.8	AO1/UI1	Compressor 1 Discharge Pressure Sensor Local	0.5 Vdc = 0 PSI, 4.5 Vdc = 667 PSI
	AO2/UI2	Compressor 1 Suction Pressure	0.5 Vdc = 0 PSI, 4.5 Vdc = 667 PSI
	AO3/UI3	Compressor 1 Suction Temperature	10K Ohm Resistor Trane Type 2
	AO4/UI4	Compressor 1 Condenser Regulating Valve	2 Vdc = 0 % Open, 10 Vdc = 100% Open
XM30.9	AO1/UI1	Compressor 2 Discharge Pressure Sensor Local	0.5 Vdc = 0 PSI, 4.5 Vdc = 667 PSI
	AO2/UI2	Compressor 2 Suction Pressure	0.5 Vdc = 0 PSI, 4.5 Vdc = 667 PSI
	AO3/UI3	Compressor 2 Suction Temperature	10K Ohm Resistor Trane Type 2
	AO4/UI4	Compressor 2 Condenser Regulating Valve	2 Vdc = 0% Open, 10 Vdc = 100% Open
XM30.10	AO1/UI1	Compressor 3 Discharge Pressure Sensor Local	0.5 Vdc = 0 PSI, 4.5 Vdc = 667 PSI
	AO2/UI2	Compressor 3 Suction Pressure	0.5 Vdc = 0 PSI, 4.5 Vdc = 667 PSI
	AO3/UI3	Compressor 3 Suction Temperature	10K Ohm Resistor Trane Type 2
	AO4/UI4	Compressor 3 Condenser Regulating Valve	2 Vdc = 0% Open, 10 Vdc = 100% Open
XM30.11	AO1/UI1	Compressor 4 Discharge Pressure Sensor Local	0.5 Vdc = 0 PSI, 4.5 Vdc = 667 PSI
	AO2/UI2	Compressor 4 Suction Pressure	0.5 Vdc = 0 PSI, 4.5 Vdc = 667 PSI
	AO3/UI3	Compressor 4 Suction Temperature	10K Ohm Resistor Trane Type 2
	AO4/UI4	Compressor 4 Condenser Regulating Valve	2 Vdc = 0% Open, 10 Vdc = 100% Open
XM32.12	BO1	Cooling Tower/Pump Request	NO Open = Request for Off, NO Closed = Request for On; NC Not Used
	BO2	Unit Alarm Output Command	NO Open = No Alarm, NO Closed = Alarm; NC not used
	BO3	VAV Box Drive Open Command	NO Open = Normal Operation, NO Closed = Drive Max Valve Position; NC Not used
	BO4	Comp 1 VFD E-Stop Alarm Contact	NO Open = Normal, NO Closed = Emergency Stop, NC Not used

Table 24. Points list (continued)

Hardware Connection		Point Name	Point Setup
XM32.13	BO1	Dirty Filter Alarm	NO Open = Normal, NO Closed = Alarm; NC Not used
	BO2	Refrigeration Circuit Failure Alarm	Open = Normal, Closed = Alarm
	BO3	Supply Fan Failure Alarm	Open = Normal, Closed = Alarm
	BO4	Heat Failure Alarm	Open = Normal, Closed = Alarm
XM30.14	AO1/UI1	Occupied Zone Cool Setpoint	0.5 Vdc = 50 Deg F, 4.5 Vdc = 90 Deg F
	AO2/UI2	Occupied Zone Heat Setpoint	0.5 Vdc = 50 Deg F, 4.5 Vdc = 90 Deg F
	AO3/UI3	Unoccupied Zone Cool Setpoint	0.5 Vdc = 50 Deg F, 4.5 Vdc = 90 Deg F
	AO4/UI4	Unoccupied Zone Heat Setpoint	0.5 Vdc = 50 Deg F, 4.5 Vdc = 90 Deg F
XM30.15	AO1/UI1	Supply Air Cooling Setpoint	0.5 Vdc = 40 Deg F, 4.5 Vdc = 90 Deg F
	AO2/UI2	Supply Air Heating Setpoint	0.5 Vdc = 40 Deg F, 4.5 Vdc = 90 Deg F
	AO3/UI3	Supply Air Static Pressure Setpoint	0.5 Vdc = 0 In WC, 4.5 Vdc = 5 In WC
	AO4/UI4	Demand Limit Input	Open = Normal, Closed = 50% Reduction NO = Normally Open, NC = Normally Closed

Navigating the TD-7

TD-7 Home Screen

To access the TD-7 home screen, press the **Home** button in the upper left of the screen.

Figure 39. Home screen

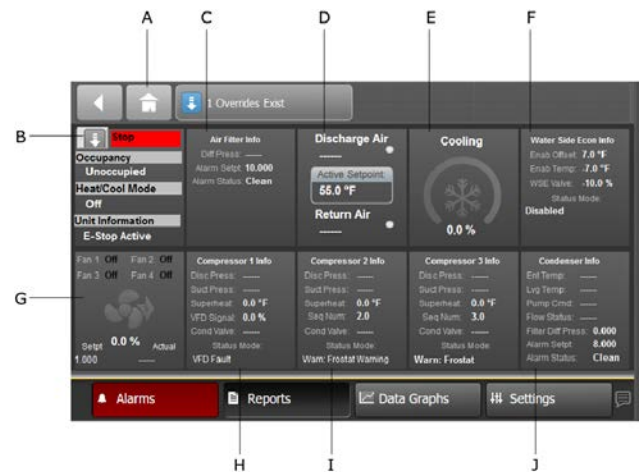

Screen Element	Description
A	Home button
B	Displays the local Auto Stop button and displays the occupancy, Heat/Cool Mode, and Unit Information.
C	Displays information about the Air Filter.
D	Displays the Discharge Air Temperature, Setpoint, and Return Air Temperature. A red light displays if the sensor fails.
E	Displays when cooling is active and indicates the % of cooling capacity currently utilized.
F	The Water Side Econ Info tile is included on units with an economizer installed. Displays a snapshot of economizer operations and the mode of the economizer.
G	Displays fan status (on, off), duct static pressure setpoint and actual, and fan percentage.
H	Compressor 1 is always the lead compressor. This tile displays the compressor pressures, superheat, VFD signal, condenser water values (if included), and operating mode.
I	Tiles for compressors 2-4 display, depending on the number of compressors installed. The VFD compressor is always the lead compressor. The fixed speed compressors rotate to even out run time. Compressor tiles displays the compressor pressures, superheat, VFD signal, condenser water values (if included), and operating mode.
J	Displays the entering and leaving temperatures, pump command, flow status, and the condenser alarm status.

TD-7 Reports

Unit Status Report

The Unit Status report provides an overview of how the unit is running and includes all available points that were pre-defined for the unit.

To access the Unit Status report:

1. Press the **Reports** button at the bottom of the screen.
2. Press **Unit Status** button.

Use the up and down arrows in the bottom right to scroll through the report.

Figure 40. Unit status report

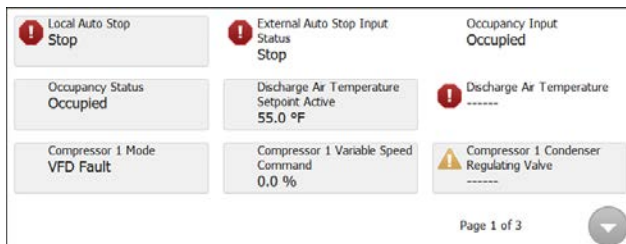

All Points Report

The All Points report provides details for all points for a unit. To access the All Points report:

1. Press the **Reports** button at the bottom of the screen.
2. Press the **All Points Report** button.

Use the up and down arrows in the bottom right to scroll through the report.

Figure 41. All points report

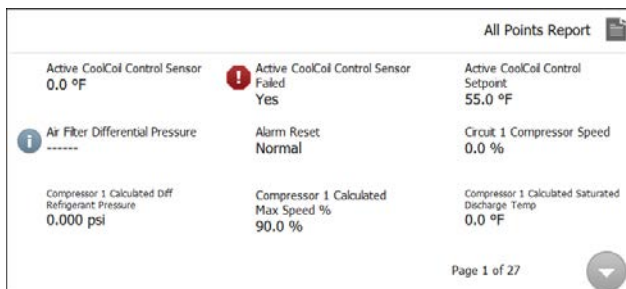

Starting the Unit

Before starting the unit, ensure that:

- All checks are complete

- Alarms are cleared
- Compressors that you want to run are made available or locked out.

Local Auto/Stop Value

The Local Auto/Stop Value is used to stop by unit in a safe manner either locally in Tracer TU or at the TD-7 display. The factory default is set to **Auto**.

1. Navigate to the Home screen.
2. In the upper left tile, press the arrow next to either **Stop** or **Auto**.
3. To stop the unit, press the **Stop** button, or to put the unit in Auto default mode, press **Release Override**.

Figure 42. Local Auto/Stop

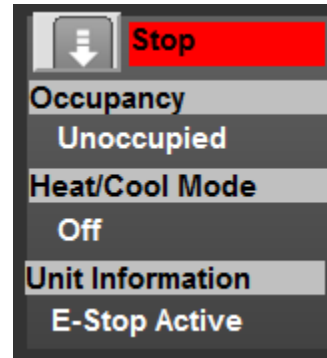
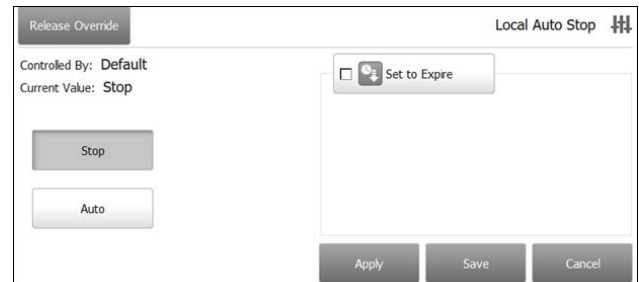

Figure 43. Stop or release override



Setpoint Adjustments

This section details control setpoints that can be modified from factory defaults and how to modify those setpoints.

Unit Setpoints

Table 25. Unit setpoints that can be modified in the TD-7

Setpoint Name	Description	Factory Default
Condenser Purge Time (on units with condenser valves only)	The amount of time (in minutes) that the compressor will open its condenser valve during purge mode when the unit is not operating.	20 minutes
Discharge Air Cooling Setpoint BAS	Used as the cooling setpoint on fixed setpoint units and on units that reset their discharge air temperature setpoint as the low value in the reset equation. This value should be set to the desired temperature needed for startup.	55° F
Discharge Air Cooling Setpoint Max BAS (reset DAT units only)	Sets the upper limit in the Reset Equation in Cooling Mode. This value can be adjusted to the desired maximum setpoint the discharge air should reach during cooling mode.	65° F
Discharge Air Heating Setpoint BAS (Units with Heat Only)	Used as the heating setpoint when the unit is in heating mode. This value should be set to the desired temperature needed for startup.	90° F
Discharge Air Low Temperature Cutout	Value that triggers a diagnostic when the discharge air temperature is below this value for 10 minutes. This value can be adjusted to the desired low air temperature, which triggers the diagnostic.	35° F
Duct Static Pressure Setpoint BAS	The duct static pressure setpoint is set by the analog value named duct static pressure setpoint BAS. This value should be set to the desired pressure needed for startup.	1 in(H2O)
Duct Static Pressure Safety Lockout	Shuts down the unit if the duct static exceeds this setpoint. It should be set to the desired pressure needed for startup.	2 in(H2O)
Dirty Air Filter DP	Generates a diagnostic for a dirty air filter when the differential pressure exceeds the setpoint.	10 in(H2O)
Occupied Offset (DAT Reset Units Only)	Determines the occupied cooling and heating setpoints when the unit resets the discharge air temperature off either return or space temperature.	2° F
Occupied Standby Offset (DAT Reset Units Only)	Determines the occupied cooling and heating setpoints when the unit resets the discharge air temperature off either return or space temperature and is the occupied standby mode.	4° F
Space Temperature Setpoint BAS (DAT Reset by Space Temp Air Units Only)	Sets the space setpoint when the unit is selected to do discharge air reset based off the space temperature. This value is used to determine the occupied heating and cooling temperatures which reset the discharge air temperature setpoint.	72° F
Return Temperature Setpoint BAS (DAT Reset by Return Temp Air Units Only)	Sets the return setpoint when the unit is selected to do discharge air reset based off the return temperature. This value is used to determine the occupied heating and cooling temperatures which reset the discharge air temperature setpoint.	72° F
Water Side Economizer Enable Offset (Units with Water Side Economizer Only)	The temperature that the condenser entering water must be below the return air temperature before it will enable the economizer.	7° F
Water Side Economizer Sample Time (Units with Water Side Economizer Only)	Time that the controller will sample the water temperature for and compare it against the return air temperature to determine if the economizer can be enabled.	2 minutes

To modify any of the setpoints in the table above:

1. Press **Reports** at the bottom of the screen.
2. Press the **Unit Setpoints** button.
3. On the **Setpoint** report, locate the point in the menu. Use the arrows to scroll through the report if needed.
4. Use the up and down arrows to change the value, or press inside the box and type in the desired setpoint.
5. Press **Save**.

Unit Setup

Table 26. Unit setup setpoints that can be modified in the TD-7

Setpoint Name	Description	Factory Default
Condenser Control % of Design	Percent of the condenser pressure design the unit will control to and is user adjustable between 50-100%.	90%
Condenser Tee Strainer Sensor Calibration	The condenser water tee high and low pressure sensor can be calibrated to match the gauge readings or recorded readings by the balancer.	0
Condenser Purge Status (On Units with Condenser Valves Only)	Each compressor has its own condenser purge status value which indicates when the condenser valve is open in the purge mode. It can also be used to manually initiate the purge mode for each compressor.	Off
Condenser Water Flow Type (On Units with Condenser Valves Only)	Indicates if the unit is a constant or variable volume flow type unit. Even with the condenser water regulating valves installed on each compressor, the flow type can be changed. When the flow is changed from variable flow to constant flow, the water regulating valve will open to its maximum position when the unit is occupied. This can be done for constant volume flow systems that do not include a VFD Pump.	Variable flow
Water Side Economizer Lockout BAS (Units with Water Side Economizer Only)	The water side economizer can be locked out by the controls system.	Available
Compressor Lockout BAS	Each compressor can be locked out individually by the controls system.	Available
Fan Lockout BAS	Each fan can be locked out individually by the controls system. Fans should be made available prior to startup.	Available

To modify any of the setpoints in the table above:

1. Press **Reports** at the bottom of the screen.
2. Press the **Unit Setup** button.
3. On the **Setup** report, locate the point in the menu. Use the arrows to scroll through the report if needed.
4. Use the up and down arrows to change the value, or press inside the box and type in the desired setpoint.
5. Press **Save**.

Reports

To access Alarms, press the Alarms button in the lower left corner of the screen. If the Alarm tab is not blinking red, there are no alarms present.

Figure 44. Alarms tab

Compressor Alarms

If there is a compressor alarm, it will need to be manually reset after it is resolved. Each compressor needs to be reset manually:

1. Press **Reports** at the bottom of the display.
2. Press **Unit Setup**.
3. In the **Setup** report, locate the appropriate point. Use the arrows to scroll through the report if needed.
4. Select the specific compressor.
5. Change the value from Normal to **Reset**.

6. Press **Save**. The point will automatically revert to its default setting (Off).

Fan Alarms

If there is a fan alarm, it will need to be manually reset after it is resolved. There is one fan reset for the entire wall fan.

1. Press **Reports** at the bottom of the display.
2. Press **Unit Setup**.
3. In the **Setup** report, press **Supply Fan Failure Reset**. Use the arrows to scroll through the report if needed.
4. Press **Reset**.
5. Press **Save**.
6. When you want the fan to be available, press the **Release Override** button in the top left.

General Alarms

General alarms are alarms that are not tied to fans or compressors. They require a manual reset, and there is one alarm reset for these alarms.

To reset a general alarm:

1. Press **Reports** at the bottom of the display.
2. Press **Unit Setup**.
3. In the **Setup** report, press **Alarm Reset**. Use the arrows to scroll through the report if needed.
4. Press **Reset**.
5. Press **Save**.

Water Purge

NOTICE

Proper Water Treatment Required!

The use of untreated or improperly treated water could result in scaling, erosion, corrosion, algae or slime.

Use the services of a qualified water treatment specialist to determine what water treatment, if any, is required. Trane assumes no responsibility for equipment failures which result from untreated or improperly treated water, or saline or brackish water.

During the unoccupied mode, water-cooled units will periodically circulate water through the condensers and waterside economizer if the user has enabled the purge function at the HI. The water purge function circulates water to introduce fresh water-treatment chemicals and help prevent water stagnation. The number of hours between each periodic purge, or purge duration, is user-defined at the HI between 1-999 hours. If the periodic purge timer expires while the unit is in occupied mode, it will wait for the next available unoccupied time before initiating water purge.

Contrary, if a request for cooling occurs during a purge sequence, purge will terminate and cooling will commence.



Pre-Startup

Before starting up units, perform the following procedure to ensure proper unit operation.

Pre-Startup Checklist

Complete this checklist after installing unit to verify all recommended installation procedures are complete before startup. This does not replace the detailed instructions in the appropriate sections of this manual. Always read the entire section carefully to become familiar with the procedures.

Supply Fan

Ensure the fan rotates freely.

Ductwork

- Ensure trunk ductwork to VAV boxes is complete and secure to prevent leaks.
- Verify that all ductwork conforms to NFPA 90A or 90B and all applicable local codes.

Water-Cooled Unit Piping

Verify condensate drain, water piping drain plugs, economizer header, strainer pressure transducers, and condenser vent plug are installed.

Units with Hydronic Heat

Verify the entering water temperature sensor is installed upstream of the hydronic coil.

Electrical

Verify electrical connections are tight.

Components

- Verify liquid line service valve, and suction and discharge service valves if present, are open at startup.

Note: Each compressor suction line contains a low pressure sensor that will shut the compressor down in low pressure situations. See [Table 16, p. 42](#).

- Ensure system components are properly set and installed.



Startup

⚠ WARNING

Live Electrical Components!

Failure to follow all electrical safety precautions when exposed to live electrical components could result in death or serious injury.

When it is necessary to work with live electrical components, have a qualified licensed electrician or other individual who has been properly trained in handling live electrical components perform these tasks.

NOTICE

Compressor Damage!

Failure to follow instructions below will cause the compressor to operate in a vacuum and result in compressor damage.

Never manually or automatically pump down system below 7 psig.

NOTICE

Compressor Damage!

Failure to follow instructions could result in compressor damage.

Keep crankcase heaters on whenever refrigerant is in the system.

If crankcase heaters have not been on with refrigerant in the system, turn the crankcase heaters on for a minimum of 24 hours before starting compressors.

To start the unit, complete the following steps in order.

Review “[Preliminary Refrigerant Charging](#),” p. 34, if applicable. Confirm all steps were completed.

Final Refrigerant Charge

If full charge was not used during installation, follow these steps:

1. Determine remaining charge required by subtracting charge added during “[Preliminary Refrigerant Charging](#),” p. 34 from the total.
2. With all circuit compressors running, SLOWLY meter remaining R-410A into the suction line from the LIQUID charging connection.

NOTICE

Compressor Damage!

Overcharging system could result in compressor failure and/or reduced compressor life.

Do not overcharge system. Excessive refrigerant charging can cause compressor liquid slugging at startup, and conditions where compressors and/or condenser fans short cycle.

NOTICE

Compressor Damage!

Failure to follow instructions below could result in compressor failure and/or reduced compressor life.

To prevent compressor liquid slugging, only add liquid in the suction line when the compressor is running. Use extreme caution to meter liquid refrigerant into the suction line slowly. If liquid is added too rapidly, compressor oil dilution and oil pumpout could occur.

3. Use an accurate scale to measure and record amount of R-410A added.
4. After unit has been operating for approximately 30 minutes at full load, measure and record operating pressures.
5. Repeat for other circuits.
6. Confirm, and adjust charge, if necessary, by checking subcooling at AHRI 340/360 full load operating conditions (80°/67°F db/wb entering evaporator, ~300 cfm/ton, 85°/95°F EWT/LWT for water-cooled). Some TXV superheat adjustment may be necessary, but only, after adequate subcooling has been reached.

Note: Water-cooled subcooling should be 10.5°F – 12.5°F.

Startup Procedure

Using the startup log on the following pages, establish nominal conditions for consistent measurements as follows:

- Leaving air greater than 60°F
- Entering air temperature = 70 to 90°F
- Entering water temperature > 60°F

With all compressors running at full load:

1. Compute superheat from the suction line pressure and temperature at the compressor on each circuit. Adjust the thermal expansion valve settings if necessary. Superheat should be between 14 and 20°F.
2. Inspect refrigerant flow in the liquid line sight glass.



Startup

Flow should be smooth and even, with no bubbles once the system has stabilized.

Note: *Sight glass moisture indicator may show caution or wet at startup. May need up to 12 hours of operation for system to reach equilibrium and correctly show moisture.*

Normal startup will occur provided that Tracer™ Summit is not controlling the module outputs or the generic BAS is not keeping the unit off. To prevent Tracer Summit from affecting unit operation, remove Tracer wiring and make required changes to setpoint

and sensor sources.

Operating and Programming Instructions

See Self-Contained Programming Guide, PKG-SVP01*-EN, for available unit operating setpoints and instructions. A copy ships with each unit. For units with VFD option, see installer guide that ships with each VFD.

Startup Log

Unit:	
Unit Location:	
Unit Voltage	

Evaporator		
Evaporator fan motor horsepower:		
Evaporator fan motor amps:		
Evaporator fan rpm (actual):		
Evaporator system static (from test and balance report or actual readings)	Supply duct static:	Return duct static:
Evaporator system cfm (test and balance sheet or actual tested):		

Evaporator Air Conditioners (with all compressor operating)			
Entering		Leaving	
Dry-bulb °F:		Dry-bulb °F:	
Wet-bulb °F:		Wet-bulb °F:	

Water-Cooled Units				
	Circuit A	Circuit B	Circuit C	Circuit D
Entering water temp °F				
Leaving water temp °F				
Entering water pressure psig				
Leaving water pressure psig				

Maintenance

Service Access

All service accessible areas are provided with hinged doors that allow doors to swing open or be removed completely.

To use as a hinge, simply open hinge handle, depress Y latch and swing door open.

To remove completely, open hinge handle and depress Y latch on back side of hinge. Work door off of unit being careful to not drop door.

Figure 45. Hinge

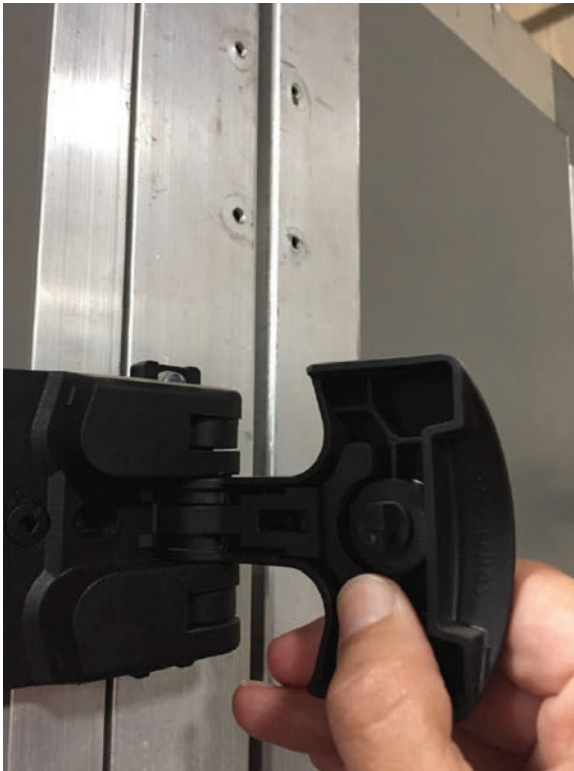

Note: Evaporator door is 75 lbs and requires two-man lift to remove safely.

Access unit controls through the front. The panel is secured with two quick release hinges. Hinged panels allow access to the fans and also the compressor and condensers. Hinges also allow for complete removal of panel. Left and right hinges allow for access to evaporator section and also allow for removable of the entire panel. Expansion valves and filter driers are easily accessible from here. Filters are accessible via a hinged panel.

Power is accessible through a hinged door on the unit (left hand is standard and right hand is optional). Hinge also allows for panel to be removed.

Air Filters

⚠ WARNING

Hazardous Voltage w/Capacitors!
 Failure to disconnect power and discharge capacitors before servicing could result in death or serious injury.
 Disconnect all electric power, including remote disconnects and discharge all motor start/run capacitors before servicing. Follow proper lockout/ tagout procedures to ensure the power cannot be inadvertently energized. Verify with a CAT III or IV voltmeter rated per NFPA 70E that all capacitors have discharged.

Filter access doors are shared with the evaporator cassette access door. To replace throwaway filters, remove the dirty elements and install new filters with the filter's directional arrows pointing toward the fan. Verify that no air bypasses the filters. See [Figure 46, p. 66](#) for proper filter placement.

Table 27. SCWM filter data, water-cooled units

Unit Size	40 Ton	50 Ton	60 Ton	70 Ton	80 Ton
Number - Size (in.)	9	12	12	15	15
	24"x 20"	24"x 20"	24"x 20"	24"x 24"	24"x 24"

Figure 46. Unit filter sizes

24 x 20	24 x 20	24 x 20	24 x 20
24 x 20	24 x 20	24 x 20	24 x 20
24 x 20	24 x 20	24 x 20	24 x 20

Inspecting and Cleaning the Drain Pan

Check the condensate drain pan and drain line to ensure that the condensate drains properly at least every six months or as dictated by operating experience.

If evidence of standing water or condensate overflow exists, take steps to identify and remedy the cause immediately. Refer to the troubleshooting section of this manual for possible causes and solutions.

⚠ WARNING

Hazardous Voltage w/Capacitors!

Failure to disconnect power and discharge capacitors before servicing could result in death or serious injury.

Disconnect all electric power, including remote disconnects and discharge all motor start/run capacitors before servicing. Follow proper lockout/tagout procedures to ensure the power cannot be inadvertently energized. For variable frequency drives or other energy storing components provided by Trane or others, refer to the appropriate manufacturer's literature for allowable waiting periods for discharge of capacitors. Verify with a CAT III or IV voltmeter rated per NFPA 70E that all capacitors have discharged.

Clean drain pans using the following procedure:

1. Disconnect all electrical power to the unit.
2. Don the appropriate personal protective equipment (PPE).
3. Remove all standing water.
4. Use a scraper or other tools to remove and solid matter. Remove solid matter with a vacuum device that utilizes high efficiency particulate arrestance (HEPA) filters with a minimum efficiency of 99.97% at 0.3 micron particle size.
5. Thoroughly clean the contaminated area(s) with a mild bleach and water solution or an EPA-approved sanitizer specifically designed for HVAC use. Carefully follow the sanitizer manufacturer's

instructions regarding product use.

6. Immediately rinse the drain pan thoroughly with fresh water to prevent potential corrosion from the cleaning solution.
7. Allow the unit to dry thoroughly before putting the system back into service.
8. Properly dispose of all contaminated materials and cleaning solution.

Compressors

Scroll Compressor Failure Diagnosis and Replacement

If compressor failure is suspected, refer to COM-SVN01 for detailed information regarding compressor failure diagnosis and replacement of scroll compressors.

Refrigerant System

If refrigerant system repair is required, Leak Test, Brazing and Evacuation Procedures are described.

Preliminary charging is described in the Installation–Mechanical section, “[Preliminary Refrigerant Charging](#),” p. 34 and final charging is described in the Startup section, “[Final Refrigerant Charge](#),” p. 63.

Refrigerant systems that have been opened must have filter driers replaced and complete leak test and evacuation before recharging. Unit is equipped with replaceable filter core option for easy maintenance.

Refrigerant Leak Test Procedure

⚠ WARNING

Confined Space Hazards!

Failure to follow instructions below could result in death or serious injury.

Do not work in confined spaces where refrigerant or other hazardous, toxic, or flammable gas may be leaking. Refrigerant or other gases could displace available oxygen to breathe, causing possible asphyxiation or other serious health risks. Some gases may be flammable and/or explosive. If a leak in such spaces is detected, evacuate the area immediately and contact the proper rescue or response authority.

⚠ WARNING

Explosion Hazard!

Failure to follow safe leak test procedures below could result in death or serious injury or equipment or property-only-damage. Never use an open flame to detect gas leaks. Use a leak test solution for leak testing.

⚠ WARNING**Explosion Hazard!**

Failure to follow these instructions could result in death or serious injury or equipment or property-only damage.

Use only dry nitrogen with a pressure regulator for pressurizing unit. Do not use acetylene, oxygen or compressed air or mixtures containing them for pressure testing. Do not use hydrogen mixtures containing refrigerant and air above atmospheric pressure for pressure testing as they may become flammable and could result in an explosion.

Refrigerant, when used as a trace gas should only be mixed with dry nitrogen for pressurizing units.

⚠ WARNING**Explosion Hazard!**

Failure to follow instruction below could result in death or serious injury.

Do not exceed unit nameplate design pressures when leak testing system.

⚠ WARNING**Refrigerant under High Pressure!**

Failure to follow instructions below could result in an explosion which could result in death or serious injury or equipment damage.

System contains refrigerant under high pressure. Recover refrigerant to relieve pressure before opening the system. See unit nameplate for refrigerant type. Do not use non-approved refrigerants, refrigerant substitutes, or refrigerant additives.

Note: These service procedures require working with refrigerant. Do not release refrigerant to the atmosphere! The service technician must comply with all federal, state, and local laws.

When leak-testing refrigerant systems, observe all safety precautions. Leak test only one circuit at a time to minimize system exposure to potentially harmful moisture in the air.

System Repair

1. Connect R-410A refrigerant cylinder to charging port, add refrigerant to reach pressure of 12 to 15 psig.
2. Disconnect refrigerant cylinder. Connect dry nitrogen cylinder to high side charging port and increase pressure to 150 psig. DO NOT exceed unit nameplate design pressures. If testing complete system, low side design pressure is maximum.
3. Check piping and/or components as appropriate for leaks.
4. Recommend using electronic detector capable of

measuring 0.1 oz/year leak rate.

5. If a leak is located, use proper procedures to remove the refrigerant/nitrogen mixture, break connections and make repairs. Retest for leaks.
6. Make sure all service valves are open.

Brazing Procedures**⚠ WARNING****Explosion Hazard and Deadly Gases!**

Failure to follow all proper safe refrigerant handling practices could result in death or serious injury.

Never solder, braze or weld on refrigerant lines or any unit components that are above atmospheric pressure or where refrigerant may be present. Always remove refrigerant by following the guidelines established by the EPA Federal Clean Air Act or other state or local codes as appropriate. After refrigerant removal, use dry nitrogen to bring system back to atmospheric pressure before opening system for repairs. Mixtures of refrigerants and air under pressure may become combustible in the presence of an ignition source leading to an explosion. Excessive heat from soldering, brazing or welding with refrigerant vapors present can form highly toxic gases and extremely corrosive acids.

Proper brazing techniques are essential when installing refrigerant piping. The following factors should be kept in mind when forming sweat connections:

1. When heating copper in the presence of air, copper oxide forms. To prevent copper oxide from forming inside the tubing during brazing, sweep an inert gas, such as dry nitrogen, through the tubing. A nitrogen flow of 1 to 3 cubic feet per minute is sufficient to displace the air in the tubing and prevent oxidation of the interior surfaces. Use a pressure regulating valve or flow meter to control the flow.
2. Ensure that the tubing surfaces requiring brazing are clean, and that the tube ends are carefully reamed to remove any burrs.
3. Make sure the inner and outer tubes of the joint are symmetrical and have a close clearance, providing an easy "slip" fit. If the joint is too loose, the connection's tensile strength is significantly reduced. Ensure the overlap distance is equal to the inner tube diameter.
4. Wrap each refrigerant line component with a wet cloth to keep it cool during brazing. Excessive heat can damage the internal components.

Note: Use 40-45% silver brazing alloy (BAg-7 or BAg-28) on dissimilar metals. Use BCup-6 brazing alloy on copper-to-copper joints.

5. If using flux, apply it sparingly to the joint. Excess

flux will contaminate the refrigerant system.

6. Apply heat evenly over the length and circumference of the joint.
7. Begin brazing when the joint is hot enough to melt the brazing rod. The hot copper tubing, not the flame, should melt the rod.
8. Continue to apply heat evenly around the joint circumference until the brazing material is drawn into the joint by capillary action, making a mechanically sound and gas-tight connection.
9. Visually inspect the connection after brazing to locate any pinholes or crevices in the joint. Use a mirror if joint locations are difficult to see.

System Evacuation Procedures

- Each refrigeration circuit must be evacuated before the unit can be charged and started.
- Use a rotary type vacuum pump capable of pulling a vacuum of 100 microns or less.
- Verify that the unit disconnect switch and the system control circuit switches are "OFF".
- Oil in the vacuum pump should be changed each time the pump is used with high quality vacuum pump oil. Before using any oil, check the oil container for discoloration, which usually indicates moisture in the oil and/or water droplets. Moisture in the oil adds to what the pump has to remove from the system, making the pump inefficient.
- When connecting vacuum pump to refrigeration system, it is important to manifold vacuum pump to both high and low side of system (liquid line access valve and suction line access valve). Follow pump manufacturer's directions for proper methods of using vacuum pump.
- Lines used to connect the pump to the system should be copper and of the largest diameter that can practically be used. Using larger line sizes with minimum flow resistance can significantly reduce evacuation time.
- Rubber or synthetic hoses are not recommended for system evacuation. They have moisture absorbing characteristics that result in excessive rates of evaporation, causing pressure rise during standing vacuum test. This makes it impossible to determine if system has a leak, excessive residual moisture, or continual or high rate of pressure increase due to hoses.
- Install an electronic micron vacuum gauge in the common line ahead of the vacuum pump shutoff valve, as shown in [Figure 47, p. 69](#). Close Valves B and C, and open Valve A.
- Start vacuum pump. After several minutes the gauge reading will indicate the maximum vacuum the pump is capable of pulling. Rotary pumps should produce vacuums of 100 microns or less.

NOTICE

Motor Winding Damage!

Failure to follow instructions below could result in compressor motor winding damage. Do not use a megohm meter or apply voltage greater than 50 VDC to a compressor motor winding while it is under a deep vacuum.

- Open Valves B and C. Evacuate system to a pressure of 300 microns or less. As vacuum is being pulled on system, it may appear that no further vacuum is being obtained, yet pressure is high. It is recommended during evacuation process to "break" vacuum to facilitate evacuation.
- To break the vacuum, shut valves A, B, & C and connect a refrigerant cylinder to charging port on manifold. Purge air from hose. Raise standing vacuum pressure in system to "zero" (0 psig) gauge pressure. Repeat process two or three times during evacuation.

Note: It is unlawful to release refrigerant into the atmosphere. When service procedures require working with refrigerants, the service technician must comply with all Federal, State, and local laws.

Standing Vacuum Test

Once 300 microns or less is obtained, close valve A and leave valves B and C open to allow the vacuum gauge to read the actual system pressure. Let system equalize for approximately 15 minutes. This is referred to as a "standing vacuum test" where time versus pressure rise. Maximum allowable rise over a 15 minute period is 200 microns. If pressure rise is greater than 200 microns but levels off to a constant value, excessive moisture is present. If pressure steadily continues to rise, a leak is indicated. [Figure 48, p. 69](#) illustrates three possible results of "standing vacuum test".

If a leak is encountered, repair the system and repeat the evacuation process until the recommended vacuum is obtained. Once the system has been evacuated, break the vacuum with refrigerant and complete the remaining Pre-Start procedures before starting the unit.

Figure 47. Typical vacuum pump hookup

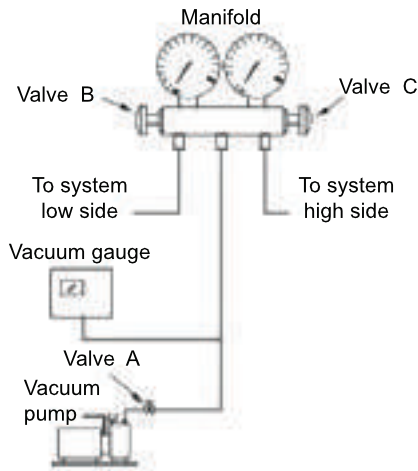
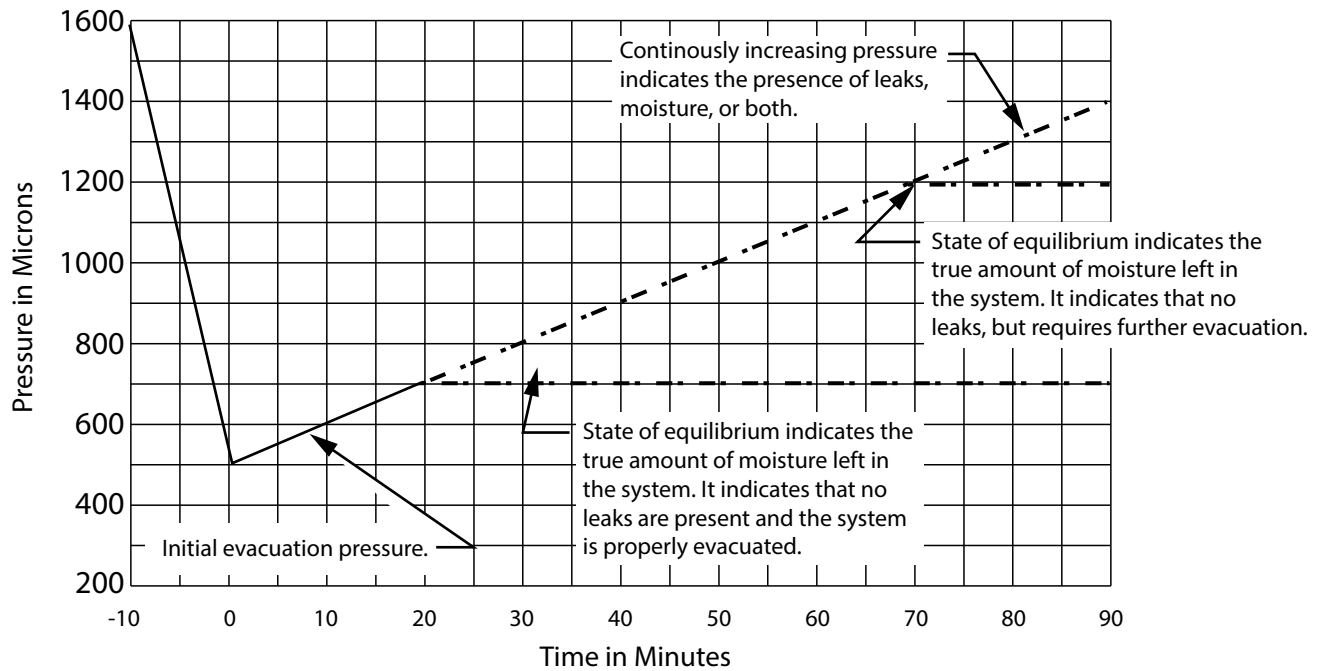

Figure 48. Evacuation time vs. pressure rise



Compressors

Scroll Compressor Failure Diagnosis and Replacement

If compressor failure is suspected, refer to COM-SVN01 for detailed information regarding compressor failure diagnosis and replacement of scroll compressors.

Components

Cleaning Coil Fin

⚠ WARNING

Hazardous Chemicals!

Failure to follow this safety precaution could result in death or serious injury. Coil cleaning agents can be either acidic or highly alkaline and can burn severely if contact with skin or eyes occurs.

Handle chemical carefully and avoid contact with skin. **ALWAYS** wear Personal Protective Equipment (PPE) including goggles or face shield, chemical resistant gloves, boots, apron or suit as required. For personal safety refer to the cleaning agent manufacturer's Materials Safety Data Sheet and follow all recommended safe handling practices.

⚠ WARNING

Hazardous Voltage w/Capacitors!

Failure to disconnect power and discharge capacitors before servicing could result in death or serious injury.

Disconnect all electric power, including remote disconnects and discharge all motor start/run capacitors before servicing. Follow proper lockout/ tagout procedures to ensure the power cannot be inadvertently energized. Verify with a CAT III or IV voltmeter rated per NFPA 70E that all capacitors have discharged.

NOTICE

Coil Damage!

Failure to follow instructions below could result in coil damage.

Do not clean the refrigerant coil with hot water or steam as it could cause high pressure inside the coil tubing.

Do not use acidic chemical coil cleaners. Also, do not use alkaline chemical coil cleaners with a pH value greater than 8.5 (after mixing) without using an aluminum corrosion inhibitor in the cleaning solution.

- Keep coils clean to maintain maximum performance. For operation at its highest efficiency, clean the refrigerant coil often during periods of high cooling demand or when dirty conditions prevail. Clean the coil a minimum of once per year to prevent dirt buildup in the coil fins, where it may not be visible.
- Remove large debris from the coils and straighten fins before cleaning. Remove filters before cleaning.

- Clean refrigerant coils with cold water and detergent, or with one of the commercially available chemical coil cleaners. Rinse coils thoroughly after cleaning.
- Economizer and evaporator coils are installed so the evaporator is directly behind the economizer. To clean between the coils, remove the sheet metal block off. Access the block off by removing the corner panels on the left or right rear side of the unit.
- If the refrigerant coil is installed back to back with the waterside economizer coil, use a cleaner that is acceptable for cleaning both types of coils.

Inspecting and Cleaning Coils

Coils become externally fouled as a result of normal operation. Coil surface dirt reduces heat transfer ability and can cause comfort problems, increased airflow resistance and thus increased operating energy costs.

Inspect coils at least every six months or more frequently as dictated by operating experience. Cleaning frequently is dependent upon system operating hours, filter maintenance, efficiency, and dirt load. Following is the suggested method for cleaning steam and hot water coils.

Hot Water Coils

⚠ WARNING

Hazardous Voltage w/Capacitors!

Failure to disconnect power and discharge capacitors before servicing could result in death or serious injury.

Disconnect all electric power, including remote disconnects and discharge all motor start/run capacitors before servicing. Follow proper lockout/ tagout procedures to ensure the power cannot be inadvertently energized. Verify with a CAT III or IV voltmeter rated per NFPA 70E that all capacitors have discharged.

1. Disconnect all electrical power to the unit.
2. Wear appropriate personal protective equipment (PPE).
3. Access both sides of the coil section.
4. Use a soft brush to remove loose debris from both sides of the coil.
5. Use a steam cleaning machine, starting from the top of the coil and working downward. Clean the leaving air side of the coil first, then the entering air side. Use a block-off to prevent steam from blowing through the coil and into a dry section of the unit.
6. Repeat step 5 as necessary. Confirm that the drain line is open following completion of the cleaning process.
7. Allow the unit to dry thoroughly before putting the

system back into service.

8. Straighten any coil fins that may be damaged with a fin rake.
9. Replace all panels and parts and restore electrical power to the unit.
10. Ensure that contaminated material does not contact other areas of the equipment or building. Properly dispose of all contaminated materials and cleaning solutions.

Refrigerant Coils

⚠ WARNING

Hazardous Voltage w/Capacitors!

Failure to disconnect power and discharge capacitors before servicing could result in death or serious injury.

Disconnect all electric power, including remote disconnects and discharge all motor start/run capacitors before servicing. Follow proper lockout/ tagout procedures to ensure the power cannot be inadvertently energized. Verify with a CAT III or IV voltmeter rated per NFPA 70E that all capacitors have discharged.

1. Disconnect all electrical power to the unit.
2. Wear the appropriate personal protective equipment (PPE).
3. Access to the coil section of the unit (both sides).
4. Use a soft brush to remove loose debris from both sides of the coil.
5. Mix a high quality coil cleaning detergent with water according to the manufacturer's instructions. If the detergent is strongly alkaline after mixing (pH 8.5 or higher), it must contain an inhibitor. Carefully follow the cleaning solution manufacturer's instructions regarding product use.
6. Place the mixed solution in a garden pump-up sprayer or high pressure sprayer. If using a high pressure sprayer note the following:
 - Maintain a minimum nozzle spray angle of 15°
 - Spray perpendicular to the coil face
 - Protect other areas of the equipment and internal controls from contact with moisture or the cleaning solution
 - Keep the nozzle at least six inches from the coil
 - Do not exceed 600 psig

Draining the Waterside Economizer Coil

NOTICE

Coil Freeze-Up!

Failure to follow instruction below could result in equipment damage.

Drain and vent coils when not in use. Trane recommends glycol protection in all possible freezing applications. Use a glycol approved for use with commercial cooling and heating systems and copper tube coils.

Drain plugs are in the piping below supply and return header for each coil. Use these plugs to drain the coil and piping. When draining the coil, open the vents at the top of the supply and return headers. Also, a drain plug is at the bottom of the inlet condenser manifold and in the outlet pipe near the left side of the unit. Remove these plugs to drain the condensers. Be sure to open the vent plugs at the top of the condenser inlet and outlet manifold. See .

When refilling the condenser/waterside economizer coil system with water, provide adequate water treatment to prevent the formation of scale or corrosion.

Chemically Cleaning the Condenser

NOTICE

Proper Water Treatment Required!

The use of untreated or improperly treated water could result in scaling, erosion, corrosion, algae or slime.

Use the services of a qualified water treatment specialist to determine what water treatment, if any, is required. Trane assumes no responsibility for equipment failures which result from untreated or improperly treated water, or saline or brackish water.

Condensing water contains minerals that collect in the condenser. Cooling towers also collect dust and foreign materials that deposit in the condenser. The formation of scale or sludge in the condenser is indicated by a decreased water flow, low temperature difference between inlet and outlet water, and abnormally high condensing temperatures. To maintain maximum condenser efficiency, the condenser must remain free of built-up scale and debris. Clean the condenser chemically. This unit is equipped with removable and cleanable 20 mesh strainer. The unit is also equipped with differential pressure sensors that will alert the user when the strainer needs to be replaced. Proper maintenance and cleaning of the condenser is necessary to ensure proper performance of the unit.

1. Disconnect all electrical power to the unit.
2. Wear appropriate personal protective equipment (PPE).

Sequence of Operations

Recognizing ScaleBreak®'s saturation point

Note: Goodway Technologies ScaleBreak-MP is the recommended de-scaling solution.

Understanding the cleaning effectiveness or scale dissolvability of ScaleBreak-MP during a cleaning is an important part of the procedural steps. This simple practice is designed to make sure the solutions activity level retains functionality. Performing these tests can be accommodated in two straightforward methods, by measuring the pH value of the circulating solution and mapping the readings or a simple calcium carbonate spot test of the circulating solution.

Testing the pH of the ScaleBreak-MP solution during a circulation is one method that will identify ScaleBreak-MP's activity level. The pH of ScaleBreak-MP starts out with a value of less than 3. As ScaleBreak-MP dissolves the deposits within the equipment, it absorbs the calcium into a liquid suspension, thus naturally neutralizing the solution. Frequent pH readings at intervals of every 10-15 minutes will allow you to map the solutions activity during a cleaning procedure.

Example: When testing the pH with a consistent pH reading below 3 and the solution abruptly rises, take additional readings to make sure this is a consistent pattern. If the pH has a consistent 5.5 reading or greater for multiple readings, the solution has become neutralized and it needs to add additional product to complete the cleaning. If its circulated for the recommended time duration, the pH did not go above 4 and its not visually seeing any additional bubbling and foaming, the cleaning is complete. You can now start flushing the piece of equipment with clean water.

A calcium carbonate spot test is performed by simply having a sample of your ScaleBreak-MP solution come in contact with a form of calcium carbonate. The calcium carbonate utilized can be a sample of the deposit you are cleaning, a calcium tablet or concrete. When you add the calcium to your ScaleBreak-MP solution, if the product is active, it will bubble and foam. If you add the calcium tablet and visualize little reaction, your solution is neutralized. You can perform this test with new ScaleBreak-MP so you understand how fresh product will react vs depleted. If your ScaleBreak-MP solution has lost its effectiveness, you will need to add fresh ScaleBreak-MP to complete the cleaning. If your ScaleBreak-MP remained active during the recommended cleaning duration, you can perform a clean water flush.

Note: Deposits comprised primarily of rust (Fe_2O_3) can give false pH readings. The pH value will remain low, yet the solution will be inactive. In situations where rust prevalent, the following calcium spot test is recommended.

Circulation Pump Setup

Circulation pump can be setup completely external to the Modular Self Contained unit eliminating the need to remove panels for access. The entire system can be cleaned with this external setup.

Figure 49. Circulation pump



Figure 50. Typical setup for clean in place

Condenser in and out piping is factory equipped with a 3/4-inch female NPT. Remove the plug that comes from the factory and install fittings as shown in this typical setup. It is recommended to install supply and return water valves.

Figure 51. Rear view of Circulation pump

Cleaning Instruction

Important: When descaling the water side of a SWEP brazed plate heat exchanger please visit <https://www.goodway.com/resources/calculators#/heat-exchanger> to determine the amount of Goodway ScaleBreak-MP needed and length of cleaning time. The information in the calculation tool allows you to adjust the amount of ScaleBreak-MP needed based on the thickness of scale in your SWEP BPHE. For more information visit www.goodway.com/swep.

1. Isolate the heat exchanger from the system by closing the supply and return water valves.
2. Position a ball valve on the low point of the heat exchanger. This valve will function as the entry point for your ScaleBreak-MP cleaning and can be closed to prevent backflow if needed.
3. Attach your circulation hoses so you are pumping into the bottom of the heat exchanger and returning the fluid out the top.
4. Your exit point on top needs to be at the highest point of the exchanger. If the exit point is lower than the top of the plate pack, position the hose at a higher point. This action will insure the entire plate pack is flooded and ScaleBreak-MP comes in contact with all the interior wetted surfaces. It will also insure upper interior areas do not become air bound with CO₂ or foaming resulting from the cleaning.
5. Fill your exchanger with water and perform a hydrostatic test by turning your pump on and circulating the water. This action assures the exchanger is isolated and none of the ScaleBreak-MP will be needlessly lost.
6. You will need to bleed off enough water equal to the volume of ScaleBreak-MP required for the cleaning. If you relieve too much water, you can add some back to complete your circulation loop.
7. Water formed deposits will occupy volume, as a result, additional water may need to be added during the cleaning process as deposits are dissolved.
8. Periodically check your isolation valves as they may have initially seated against scale. As ScaleBreak-MP dissolves the scale, this action will help you avoid losing product.
9. Circulate the ScaleBreak-MP solution for the recommended timeframe as indicated by our calculation tool.
10. During your ScaleBreak-MP cleaning you will want to make sure your solution remains active. For this step, please follow our "Testing ScaleBreak's Effectiveness" procedure.
11. Once you have reached the recommended circulation time and your ScaleBreak-MP solution

has completed the job, you can begin your flushing process.

12. Though ScaleBreak-MP is a biodegradable solution, most facilities need to conform to pH discharge limits. ScaleBreak-MP® Neutralizer can be utilized to safely elevate your pH to meet your discharge limit so it can be flushed to the drain. Please follow the instructions for this process in the ScaleBreak-MP Neutralizer information sheet.
13. To flush your heat exchanger, turn off your circulation pump, remove the return hose from your recirculation system and put it in a drain.
14. Add a fresh water hose to your recirculation bucket on your pump system and turn the pump back on.
15. Continue running clean water through the heat exchanger for 10-15 minutes or until the return water is running clear. This action will also flush out your pump system.
16. As an added safeguard you can reverse your hoses so you pump into the top and out the bottom. This action will flush away any debris that may have settled out the bottom of the exchanger.
17. Disconnect your hoses, close the valves you performed your circulation through and open the valves for the exchanger supply water.
18. Your heat exchanger can now be returned to service.

Notes:

- *Follow all local regulations for discharge.*
- *Follow all plant personal protective equipment guidelines as determined by your health & safety team.*
- *ScaleBreak-MP has very minimal corrosion rates, however, the application of ScaleBreak -Mp may reveal pre-existing under-deposit corrosion (UD) or microbiologically influenced corrosion (MIC). These types of corrosion can present themselves in the form of pitting, pin holes or similar types of damage.*
- *HCl based descaling solutions are one of the most common acid types used for descaling, however, it is NOT recommended for use brazed plate heat exchanger materials and may damage the equipment, and it therefore NOT recommended for use.*

Chemical Cleaning Economizer Coil

Chemical cleaning removes scale deposits built up by minerals in the water. For a suitable chemical solution, consult a water treatment specialist. The condenser water circuit is composed of copper, steel, and cast iron.

The chemical supply house should approve or provide all materials used in the external circulating system,

along with the quantity of cleaning material, duration of cleaning time, and safety precautions necessary for handling the cleaning agent.

Piping Components**Water Valves****⚠ WARNING****Hazardous Voltage w/Capacitors!**

Failure to disconnect power and discharge capacitors before servicing could result in death or serious injury.

Disconnect all electric power, including remote disconnects and discharge all motor start/run capacitors before servicing. Follow proper lockout/tagout procedures to ensure the power cannot be inadvertently energized. For variable frequency drives or other energy storing components provided by Trane or others, refer to the appropriate manufacturer's literature for allowable waiting periods for discharge of capacitors. Verify with a CAT III or IV voltmeter rated per NFPA 70E that all capacitors have discharged.

Water valves have a stern packing nut. If there is evidence of water leakage at the valve stem, proceed as follows:

1. Remove actuator motor from support plate.
2. Remove shaft coupling.
3. Torque the packing nut to 10-ft.-lbs. of torque.
4. Replace shaft coupling.
5. Replace actuator motor.

Flow Switch

Flow switches have a magnet on the vane assembly that attracts ferrous particulate. The particulate may build up on the magnet to the point that the vane will wedge and not operate properly. When the flow switch does not operate, remove and replace.

Maintenance Periodic Checklists

⚠ WARNING

Hazardous Service Procedures!

Failure to follow all precautions in this manual and on the tags, stickers, and labels could result in death or serious injury.

Technicians, in order to protect themselves from potential electrical, mechanical, and chemical hazards, **MUST** follow precautions in this manual and on the tags, stickers, and labels, as well as the following instructions: Unless specified otherwise, disconnect all electrical power including remote disconnect and discharge all energy storing devices such as capacitors before servicing. Follow proper lockout/tagout procedures to ensure the power can not be inadvertently energized. When necessary to work with live electrical components, have a qualified licensed electrician or other individual who has been trained in handling live electrical components perform these tasks.

Monthly Checklist

The following check list provides the recommended maintenance schedule to keep the commercial self-contained equipment running efficiently.

1. Inspect unit air filters. Clean or replace if airflow is blocked or if filters are dirty.
2. Inspect coils for excess moisture or icing. Icing on the coils may indicate low airflow supply, restricted airflow from dirty fins, evaporator frost protection sensor problems, or a shortage of refrigerant flowing through the coil.
3. Check that condensate from the evaporator and economizer coils flows freely through the condensate piping, traps, drain pan, and drainage holes. Remove algae and or any airflow obstructions.
4. Check the liquid line sight glasses during operation. Bubbles in the sight glasses indicate a possible shortage of refrigerant or an obstruction in the liquid lines, e.g. dirty liquid line filter driers.
5. Inspect filter driers for leaks, flow obstructions, or temperature drop across the filter drier. A noticeable temperature differential, e.g. 5°F, in the liquid line may indicate an obstruction. Replace the filter drier if it appears clogged.
6. Inspect the optional waterside economizer coil. Clean the coil to prevent airflow restrictions through the fins.
7. Check and record operating pressures.

Semi-Annual Maintenance

⚠ WARNING

Rotating Components!

Failure to disconnect power before servicing could result in rotating components cutting and slashing technician which could result in death or serious injury.

Disconnect all electric power, including remote disconnects before servicing. Follow proper lockout/tagout procedures to ensure the power can not be inadvertently energized.

1. With power disconnected, manually rotate the fan wheel to check for obstructions in the housing or interference with fan blades. Remove obstructions and debris. Inspect for any damage to fan blades and housing. Check impeller for wear/deposits/corrosion and damage.
2. Check water valves for leakage at valve stem packing nut.

Note: Perform this procedure monthly if the unit is in a coastal or corrosive environment.

Annual Maintenance

Check and tighten all set screws, bolts, locking collars and sheaves.

1. Inspect, clean, and tighten all electrical connections.
2. Visually inspect the entire unit casing for chips or corrosion. Remove rust or corrosion and repaint surfaces.
3. Visually check for leaks in refrigerant piping.
4. Inspect fan, motor, and control contacts. Replace badly worn or eroded contacts.
5. Inspect the thermal expansion valve sensing bulbs for cleanliness, good contact with the suction line, and adequate insulation from ambient air.
6. Verify the superheat setting is 12 -17°F at the compressor.

When checking operating pressures and conditions, establish the following nominal conditions for consistent measurements.

- Leaving air temperature greater than 60°F
- Entering air temperature is 80 - 90°F
- Entering water temperature greater than 65°F
- Compressors running at full load
- Drain the condensing water system and inspect it thoroughly for fouling; clean if necessary.



Diagnostics

Troubleshooting

System Checks

⚠ WARNING

Live Electrical Components!

Failure to follow all electrical safety precautions when exposed to live electrical components could result in death or serious injury.

When it is necessary to work with live electrical components, have a qualified licensed electrician or other individual who has been properly trained in handling live electrical components perform these tasks.

Before proceeding with technical trouble charts or controls checkout, complete the following system analysis:

1. Measure actual supply voltage at the compressor and an motor terminals with the unit running. Voltage must be within the range listed on the motor nameplate. Phase imbalance must be less than 2.0%.
2. Check all wiring and connections to be sure that they are intact, secure and properly routed. The as wired system diagrams are provided in the unit control panel.
3. Check that all fuses are installed and properly sized.
4. Inspect air filters and coils to be sure that airflow to the unit is not restricted.
5. Check the zone thermostat settings.
6. Ensure that the fan is rotating in the proper direction. If phasing is wrong at the main power terminal block, the fan and compressors will not run correctly.
7. Inspect ductwork and duct connections for tightness.

Operating Procedures

Install pressure gauges on the discharge and suction line access valves. When the unit has stabilized (after operating approximately 15 minutes at full load),

record suction and discharge pressures. System malfunctions such as low airflow, line restrictions, incorrect refrigerant charge, malfunctioning of expansion valves, damaged compressors, etc. will result in pressure variations which are outside the normal range.

Note: *If phasing at the main incoming power terminal is incorrect, switch two of the three incoming power leads. If a compressor has been replaced and the phase is changed at the compressor, it will run backwards and discharge pressure will be very low. To resolve incorrect compressor wire phasing, change phasing at the compressor.*

It is important that pressures be measured under stable and constant conditions in order for the readings to be useful.

Voltage Imbalance

Voltage imbalance on three-phase systems can cause motor overheating and premature failure. Maximum allowable imbalance is 2.0%, and the readings used to determine it must be measured at the compressor terminals.

Voltage imbalance is defined as 100 times the sum of the division of the three voltages from the average voltage. If, for example, the three measured voltages are 221, 230, 227, the average is:

$$\frac{221 + 230 + 227}{3} = 226 \text{ volts}$$

Therefore, the percentage of voltage imbalance is:

$$100 * (226 - 221) / 226 = 2.2\%$$

In this example, 2.2% imbalance of more than 2.0% exists, be sure to check the voltage at the unit disconnect and terminal block switch. If an imbalance at the unit disconnect switch does not exceed 2.0%, the imbalance is caused by faulty wiring within the unit. Be sure to conduct a thorough inspection of the unit electrical wiring connections to locate the fault, and make any repairs necessary.



Table 28. Potential unit issues and solutions

Problem	Possible Cause	Remedy
Drain pan is overflowing	Plugged drain line Unit not level	Clean drain line Level unit
Standing water in drain pan	Unit not level Plugged drain line	Level Unit Clean drain line
Wet interior insulation	Coil face velocity too high Improper trap design Drain pan leaks/overflowing Condensation on surfaces	Reduce fan speed Design trap per unit installation instructions Repair Leaks Insulate surfaces

Table 28. Potential unit issues and solutions (continued)

Problem	Possible Cause	Remedy
Excess dirt in unit	Missing filters Filter bypass	Replace filters Reduce filter bypass
Microbial growth (mold)	Standing water in drain pan	See "Standing water in drain pan" above

Table 29. Compressor alarming

Diagnostic: Compressor (1-4) Discharge Pressure Sensor Failure (In Alarm)				
				
Notification Class	Action	Reason	Typical Causes	Reset Required
HVAC Critical Alarm.	Compressor will be locked out and prevented from running until this diagnostic is cleared.	The Pressure sensor is calculated to be in fault and the unit has locked out the compressor from operation.	<ul style="list-style-type: none"> Sensor has lost its 5 Vdc Source Signal. Verify that the sensor has 5 Vdc. Sensor is not wired properly: Verify wiring to the XM Module. XM Module is not communicating. Ensure that the XM Module is up and talking to the UC600. System has no charge: Verify that the system has a refrigerant charge. Sensor has failed. 	Manual Reset required once the sensor is in a Normal State. User must toggle the Compressor (1-4) Failure Reset.
Diagnostic: Compressor (1-4) Discharge Pressure Sensor Failure (In Fault)				
				
Notification Class	Action	Reason	Typical Causes	Reset Required
HVAC Critical Alarm.	Compressor will be locked out and prevented from running until this sensor is in a normal state.	The Pressure sensor is reading either Above or Below its minimum value, resulting in a Fault Condition after 3 point updates.	<ul style="list-style-type: none"> Sensor has lost its 5 Vdc Source Signal. Verify that the sensor has 5 Vdc. Sensor is not wired properly: Verify wiring to the XM Module. XM Module is not communicating. Ensure that the XM Module is up and talking to the UC600. System has no charge: Verify that the system has a refrigerant charge. Sensor has failed. 	None, fault clears once sensor is in a normal state.

Diagnostics
Table 29. Compressor alarming (continued)



Diagnostic: Compressor (1-4) Suction Pressure Sensor Failure (In Alarm)				
 05022000 02:52 AM Diagnostic: Compressor 2 Suction Pressure In Alarm Sensor Failure				
Notification Class	Action	Reason	Typical Causes	Reset Required
HVAC Critical Alarm.	Compressor will be locked out and prevented from running until this diagnostic is cleared.	The Pressure sensor is calculated to be in fault and the unit has locked out the compressor from operation.	<ul style="list-style-type: none"> • Sensor has lost its 5 Vdc Source Signal. Verify that the sensor has 5 Vdc. • Sensor is not wired properly: Verify wiring to the XM Module. • XM Module is not communicating. Ensure that the XM Module is up and talking to the UC600. • System has no charge: Verify that the system has a refrigerant charge. • Sensor has failed. 	Manual Reset required once the sensor is in a Normal State. User must toggle the Compressor (1-4) Failure Reset.
Diagnostic: Compressor (1-4) Suction Pressure Sensor Failure (In Fault)				
 05022000 02:52 AM Diagnostic: Compressor 2 Suction Pressure In Alarm Sensor Failure				
Notification Class	Action	Reason	Typical Causes	Reset Required
HVAC Critical Alarm.	Compressor will be locked out and prevented from running until this sensor is in a normal state.	The Pressure sensor is reading either above is maximum value or below is minimum value, resulting in a Fault Condition after 3 point updates.	<ul style="list-style-type: none"> • Sensor has lost its 5 Vdc Source Signal. Verify that the sensor has 5 Vdc. • Sensor is not wired properly: Verify wiring to the XM Module. • XM Module is not communicating. Ensure that the XM Module is up and talking to the UC600. • System has no charge: Verify that the system has a refrigerant charge. • Sensor has failed. 	None, alarm clears once sensor is in a normal state.
Diagnostic: Compressor (1-4) Suction Temperature Sensor Failure (In Alarm)				
 05022000 02:52 AM Diagnostic: Compressor 2 Suction Temperature In Alarm Sensor Failure				
Notification Class	Action	Reason	Typical Causes	Reset Required

Table 29. Compressor alarming (continued)

HVAC Critical Alarm.	Compressor will be locked out and prevented from running until this diagnostic is cleared.	The Temperature sensor is calculated to be in fault and the unit has locked out the compressor from operation.	<ul style="list-style-type: none"> • Sensor is not wired properly: Verify wiring to the XM Module. • XM Module is not communicating. Ensure that the XM Module is up and talking to the UC600. • Sensor has failed. Verify if sensor has any resistance on it, should be 8-12k of resistance on the thermistor. 	Manual Reset required once the sensor is in a Normal State. User must toggle the Compressor (1-4) Failure Reset.
Diagnostic: Compressor (1-4) Suction Temperature Sensor Failure (In Fault)				
				
Notification Class	Action	Reason	Typical Causes	Reset Required
HVAC Critical Alarm.	Compressor will be locked out and prevented from running until this sensor is in a normal state.	The temperature sensor is reading either above is maximum value or below is minimum value, resulting in an Alarm Condition after 3 point updates.	<ul style="list-style-type: none"> • Sensor has lost its 5 Vdc Source Signal. Verify that the sensor has 5 Vdc. • Sensor is not wired properly: Verify wiring to the XM Module. • XM Module is not communicating. Ensure that the XM Module is up and talking to the UC600. System has no charge: Verify that the system has a refrigerant charge. • Sensor has failed. 	None, alarm clears once sensor is in a normal state.
Diagnostic: Compressor (1-4) High Pressure Shutdown (In Alarm)				
				
Notification Class	Action	Reason	Typical Causes	Reset Required

Table 29. Compressor alarming (continued)

HVAC Critical Alarm.	Compressor will be locked out and prevented from running until this diagnostic is cleared.	The temperature sensor is reading either above is maximum value or below is minimum value, resulting in an Alarm Condition after 3 point updates.	<ul style="list-style-type: none"> • Sensor is not wired properly: Verify wiring to the XM Module. • XM Module is not communicating. Ensure that the XM Module is up and talking to the UC600. • Discharge Pressure is too high and over the cutout threshold of the High Pressure Switch. Verify Condenser Pressure. • Cutout Switch has failed. 	Manual Reset required once the sensor is in a Normal State. User must toggle the Compressor (1-4) Failure Reset.
Compressor (1-4) High Pressure Cutout (In Alarm)				
				
Notification Class	Action	Reason	Typical Causes	Reset Required
HVAC Critical Alarm.	The High Pressure cutout switch is reading a closed condition which indicates.	The temperature sensor is reading either above is maximum value or below is minimum value, resulting in an Alarm Condition after 3 point updates.	<ul style="list-style-type: none"> • Sensor is not wired properly: Verify wiring to the XM Module. • XM Module is not communicating. Ensure that the XM Module is up and talking to the UC600. • Discharge Pressure is too high and over the cutout threshold of the High Pressure Switch. Verify Condenser Pressure. • Cutout Switch has failed. 	None, alarm clears once sensor is in a normal state.
Diagnostic: Compressor (1-4) Froststat (In Alarm)				
				
Notification Class	Action	Reason	Typical Causes	Reset Required
HVAC Critical Alarm.	Compressor will be locked out and prevented from running until this diagnostic is cleared.	The Calculated Saturated Suction Refrigerant Temperature is below 32 degrees for 5 minutes.	<ul style="list-style-type: none"> • Low Airflow across the Evaporator. • Partially blocked Evaporator. • Dirty Air Filter. • Dirty Evaporator Coil. 	Manual Reset required once the issue is resolved. User must toggle the Compressor (1-4) Failure Reset.
Diagnostic: Compressor (1-4) High Superheat (In Alarm)				
				

Table 29. Compressor alarming (continued)

Notification Class	Action	Reason	Typical Causes	Reset Required
HVAC Critical Alarm.	Compressor will be locked out and prevented from running until this diagnostic is cleared.	The Calculated superheat is above 25 degrees for 10 minutes.	<ul style="list-style-type: none"> • Low Charge on unit. • Malfunctioning TXV. • Too high of a heat load. • Too much air across the evaporator. 	Manual Reset required once the issue is resolved. User must toggle the Compressor (1-4) Failure Reset.
Diagnostic: Compressor (1-4) Low Superheat (In Alarm)				
				
Notification Class	Action	Reason	Typical Causes	Reset Required
HVAC Critical Alarm.	Compressor will be locked out and prevented from running until this diagnostic is cleared.	The Calculated superheat is below 4 degrees for 5 minutes.	<ul style="list-style-type: none"> • Over Charge on unit. • Malfunctioning TXV. • Dirty Condenser tubes. • TXV Bulb is not strapped tightly to suction line. • Too little air across the evaporator. 	Manual Reset required once the issue is resolved. User must toggle the Compressor (1-4) Failure Reset.
Diagnostic: Compressor 1 Safety Circuit Alarm (In Alarm)				
				
Notification Class	Action	Reason	Typical Causes	Reset Required
HVAC Critical Alarm.	Compressor will be locked out and prevented from running until this diagnostic is cleared.	The Compressor VFD has indicated that it's in fault or the Compressor is commanded on but does not indicate status.	<ul style="list-style-type: none"> • VFD has an issue. • Relay starting compressor is malfunctioning. • XM Module commanding compressor relay is failed or not communicating. 	Manual Reset required once the issue is resolved. User must toggle the Compressor 1 Failure Reset.
Diagnostic: Compressor (2-4) Safety Circuit Alarm (In Alarm)				
				
Notification Class	Action	Reason	Typical Causes	Reset Required

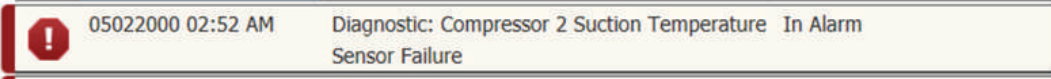
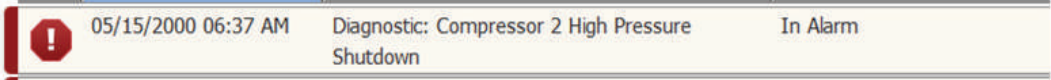
Table 29. Compressor alarming (continued)

HVAC Critical Alarm.	Compressor will be locked out and prevented from running until this diagnostic is cleared.	The Compressor Protection module has indicated an alarm or the Compressor is commanded on but does not indicate status.	<ul style="list-style-type: none"> VFD has an issue. Relay starting compressor is malfunctioning. XM Module commanding compressor relay is failed or not communicating. 	Manual Reset required once the issue is resolved. User must toggle the Compressor 1 Failure Reset.
----------------------	--------------------------------------------------------------------------------------------	-------------------------------------------------------------------------------------------------------------------------	----------------------------------------------------------------------------------------------------------------------------------------------------------------------------------------------------------	----------------------------------------------------------------------------------------------------

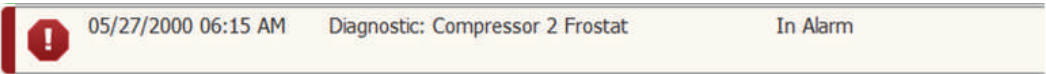
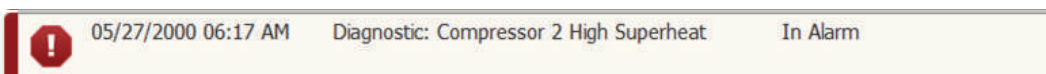
Note: These Alarms will affect the operation of the compressor.

Table 30. Compressor warning

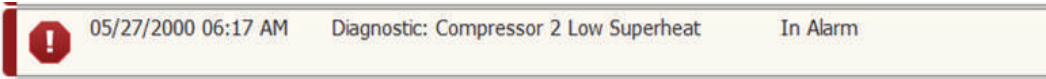
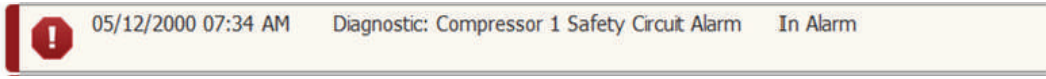
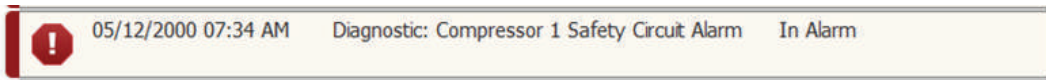
Warning: Compressor 1 Cond Limit Status (In Alarm)				
				
Notification Class	Action	Reason	Typical Causes	Reset Required
HVAC Warning.	Compressor speed will be limited to keep the compressor from exceeding the Condenser Control Pressure Setpoint.	Head Pressure has exceeded the condenser Control Pressure Setpoint.	<ul style="list-style-type: none"> High Condenser Water Temperature. Malfunctioning TXV. Non Condensable in the refrigerant. Low water flow in the condenser, or no water flow. Condenser Valve malfunctioning. 	No Reset required, Warning clears when conditions no longer exists.
Warning: Compressor 1 Frost Limit Status (In Alarm)				
				
Notification Class	Action	Reason	Typical Causes	Reset Required
HVAC Warning.	Compressor speed will be limited to keep the compressor from causing frost buildup on the evaporator coil.	The Saturated suction refrigerant temperature is calculated to be below 36 degrees.	<ul style="list-style-type: none"> Low Airflow across the coil. Malfunctioning TXV. Dirty Air Filters. Dirty Evaporator Coil. 	No Reset required, Warning clears when conditions no longer exists.
Warning: Compressor (2-4) High Discharge Press Warning (In Alarm)				
				
Notification Class	Action	Reason	Typical Causes	Reset Required

Table 30. Compressor warning (continued)

HVAC Warning.	No action is taken on the fixed speed compressor, this is an informational warning only.	Head Pressure has exceeded the condenser Control Pressure Setpoint.	<ul style="list-style-type: none"> High Condenser Water Temperature. Malfunctioning TXV. Non Condensable in the refrigerant. Low water flow in the condenser, or no water flow. Condenser Valve malfunctioning. 	No Reset required, Warning clears when conditions no longer exists.
Warning: Compressor (2-4) Frost Warning (In Alarm)				
				
Notification Class	Action	Reason	Typical Causes	Reset Required
HVAC Warning.	No action is taken on the fixed speed compressor, this is an informational warning only.	The Saturated suction refrigerant temperature is calculated to be below 36 degrees.	<ul style="list-style-type: none"> Low Airflow across the coil. Malfunctioning TXV. Dirty Air Filters. Dirty Evaporator Coil. 	No Reset required, Warning clears when conditions no longer exists.

Note: These warnings are generated to alert the end user to a potential condition.

Table 31. Supply fan alarms

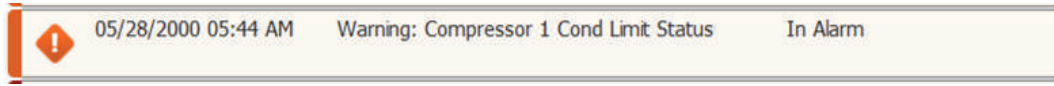
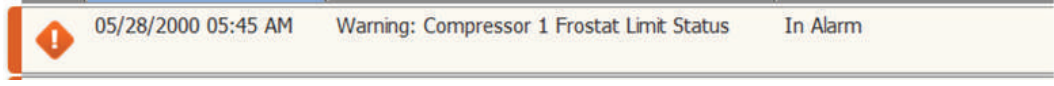
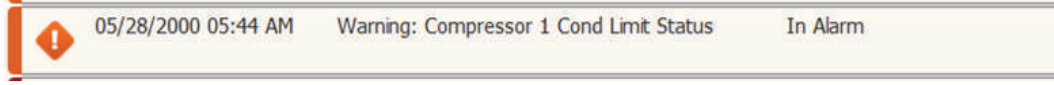
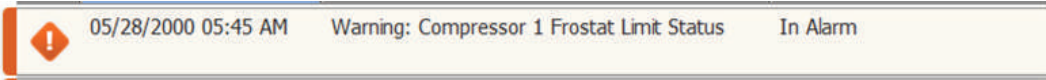
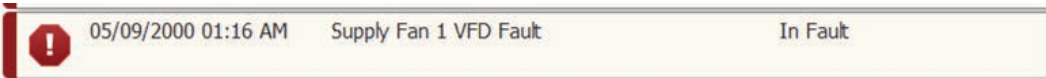
Supply Fan (1-6) Failure (In Fault)				
				
Notification Class	Action	Reason	Typical Causes	Reset Required
HVAC Critical Alarm.	Fan will be locked out and prevented from running until this diagnostic is cleared.	The supply fan was commanded on and a VFD Fault was detected.	<ul style="list-style-type: none"> VFD Fan circuit Breaker is open. VFD Fan has over amped. VFD Fan has lost a phase. 	Manual Reset required once the issue is resolved. User must toggle the Supply Failure Reset.

Note: These failures are generated by each fan and will lock out that fan when active.

Emergency Stop (In Alarm)				
				
Notification Class	Action	Reason	Typical Causes	Reset Required
HVAC Critical Alarm.	Unit will shut down and be prevented from operating until the sensor is in a normal state.	The emergency stop input has an open condition which indicates an emergency stop command.	Emergency Stop Binary Input is open.	Manual reset required once the issue is resolved. User must toggle the alarm reset value.

Table 32. General unit alarming



External Auto/Stop (In Alarm)				
				
Notification Class	Action	Reason	Typical Causes	Reset Required
HVAC Critical Alarm.	Unit will shut down and be prevented from operating until the sensor is in a normal state.	The external auto/stop input has an open condition which indicates an emergency stop command.	Emergency stop binary input is open.	None, alarm clears once sensor is in a normal state.
Local Auto/Stop (In Alarm)				
				
Notification Class	Action	Reason	Typical Causes	Reset Required
HVAC Critical Alarm.	Unit will shut down and be prevented from operating until the sensor is in a normal state.	The local auto/stop value has been commanded to the local stop command.	Emergency stop binary input is open.	None, alarm clears once sensor is in a normal state.
Discharge Air Temperature (In Fault)				
				
Notification Class	Action	Reason	Typical Causes	Reset Required
HVAC Critical Alarm.	Unit will shut down and be prevented from running until this sensor is in a normal state.	The temperature sensor is reading either above is maximum value or below is minimum value, resulting in a Fault Condition after 3 point updates.	<ul style="list-style-type: none"> • Sensor is not wired properly: Verify sensor wiring to the XM Module. • XM Module is not communicating. Ensure that the XM Module is up and talking to the UC600. • Sensor has Failed. Verify if sensor has any resistance on it, should be 8-12k of resistance on the thermistor. 	None, alarm clears once sensor is in a normal state.
Diagnostic: Discharge Air Temperature Source Failure (In Alarm)				
				
Notification Class	Action	Reason	Typical Causes	Reset Required

Table 32. General unit alarming (continued)

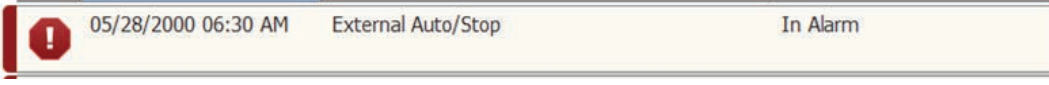

HVAC Critical Alarm.	Unit will shut down and be prevented from running until this sensor is in a normal state.	The temperature sensor is reading either above is maximum value or below is minimum value, resulting in a Fault Condition after 3 point updates.	<ul style="list-style-type: none"> • Sensor is not wired properly: Verify sensor wiring to the XM Module. • XM Module is not communicating. Ensure that the XM Module is up and talking to the UC600. • Sensor has Failed. Verify if sensor has any resistance on it, should be 8-12k of resistance on the thermistor. 	Manual Reset Required once the issue is resolved. User must toggle the Alarm Reset value.
Diagnostic: Discharge Air Low Temperature Source Failure (In Alarm)				
				
Notification Class	Action	Reason	Typical Causes	Reset Required
HVAC Critical Alarm.	Unit will shut down and be prevented from running until this sensor is in a normal state.	The discharge air temperature is less than or equal to the Discharge Air Low Temperature Cutout for 10 minutes.	Cold entering air to the unit.	Manual Reset Required once the issue is resolved. User must toggle the Alarm Reset value.
Diagnostic: Discharge Air High Temperature Source Failure (In Alarm)				
				
Notification Class	Action	Reason	Typical Causes	Reset Required
HVAC Critical Alarm.	Unit will shut down and be prevented from running until this sensor is in a normal state.	The discharge air temperature is more than or equal to the Discharge Air High Temperature Cutout for 10 minutes.	<ul style="list-style-type: none"> • Hot Entering Air to the unit. • Hot Water valve stuck open. 	Manual Reset Required once the issue is resolved. User must toggle the Alarm Reset value.
Duct Static Pressure Failure (In Fault)				
				
Notification Class	Action	Reason	Typical Causes	Reset Required

Table 32. General unit alarming (continued)

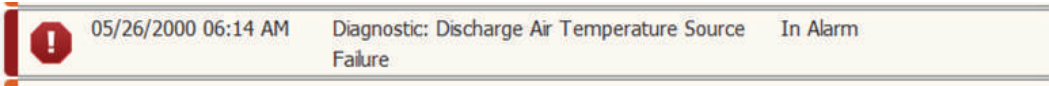
HVAC Critical Alarm.	Unit will shut down and be prevented from running until this sensor is in a normal state.	The Pressure sensor is reading either above its maximum value or below its minimum value, resulting in a Fault Condition after 3 point updates.	<ul style="list-style-type: none"> • Sensor is not wired properly: Verify sensor wiring to the XM Module. • XM Module is not communicating. Ensure that the XM Module is up and talking to the UC600. • Sensor has Failed. Use the Pressure Transducer Troubleshooting guide in the IOM to diagnose if the sensor is operating properly. 	None, alarm clears once sensor is in a normal state.
Diagnostic: Duct Static Pressure Failure (In Fault)				
				
Notification Class	Action	Reason	Typical Causes	Reset Required
HVAC Critical Alarm.	Unit will shut down and be prevented from running until this sensor is in a normal state.	The Pressure sensor is reading either above its maximum value or below its minimum value, resulting in a Fault Condition after 3 point updates.	<ul style="list-style-type: none"> • Sensor is not wired properly: Verify sensor wiring to the XM Module. • XM Module is not communicating. Ensure that the XM Module is up and talking to the UC600. • Sensor has Failed. Use the Pressure Transducer Troubleshooting guide in the IOM to diagnose if the sensor is operating properly. 	Manual Reset Required once the issue is resolved. User must toggle the Alarm Reset value.
Diagnostic: Software High Duct Static Alarm (In Alarm)				
				
Notification Class	Action	Reason	Typical Causes	Reset Required
HVAC Critical Alarm.	Unit will shut down and be prevented from running until this sensor is in a normal state.	The Duct Static Pressure sensor is reading above the Duct Static Pressure Safety Lockout Setpoint.	<ul style="list-style-type: none"> • VAV Boxes are closed down. • Restriction in ductwork. 	Manual Reset Required once the issue is resolved. User must toggle the Alarm Reset value.
Diagnostic: Condenser Water Flow Loss (In Alarm)				
				
Notification Class	Action	Reason	Typical Causes	Reset Required

Table 32. General unit alarming (continued)

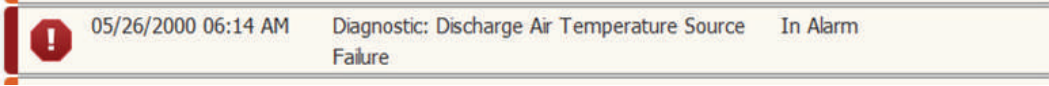
HVAC Critical Alarm.	The Compressors will be shut down and prevented from running until the condition is resolved.	The Condenser Water Flow Switch input is open indicating a no water flow condition.	<ul style="list-style-type: none"> • Pumps not running. • Valves are closed. • Strainer is plugged. 	Manual Reset Required once the issue is resolved. User must toggle the Alarm Reset value.
Diagnostic: Condenser Water Low Temperature Lockout (In Alarm)				
				
Notification Class	Action	Reason	Typical Causes	Reset Required
HVAC Critical Alarm.	Unit will shut down and be prevented from running until this sensor is in a normal state.	The Condenser Water entering or leaving temperature is below 35 degrees for 10 minutes.	<ul style="list-style-type: none"> • Cold Outdoor temperatures at cooling tower. • Cold incoming air into the unit. 	Manual Reset Required once the issue is resolved. User must toggle the Alarm Reset value.

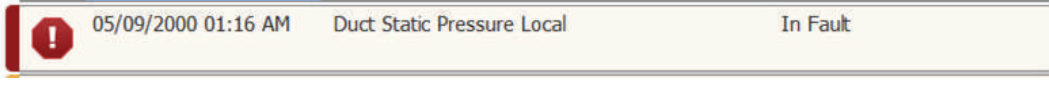
Note: These alarms are generated by sensors on the unit not related to the Fans or Compressors and will shut down the unit.

Table 33. General unit warning

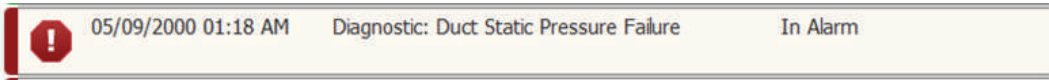
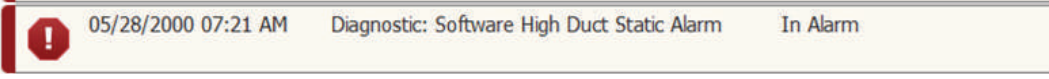
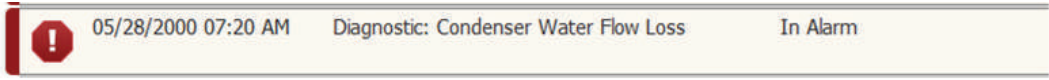
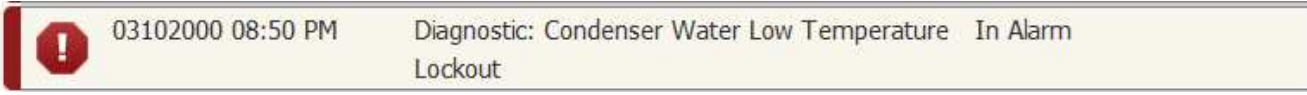

Diagnostic: Dirty Air Filter (In Alarm)				
				
Notification Class	Action	Reason	Typical Causes	Reset Required
HVAC Service Required.	No action taken other than to notify end user of condition.	The Filter differential pressure is greater than the Dirty Air Filter DP Setpoint.	<ul style="list-style-type: none"> • Filters are dirty. • Fan speed is too great. • Failed Pressure sensor. 	Manual Reset Required once the issue is resolved. User must toggle the Filter Alarm Reset value.
Diagnostic: Dirty Condenser Tee Filter (In Alarm)				
				
Notification Class	Action	Reason	Typical Causes	Reset Required
HVAC Service Required.	No action taken other than to notify end user of condition.	The Condenser Tee differential pressure is greater than the Condenser Tee Strainer Diff Pressure Alarm Setpoint for 1 minute.	<ul style="list-style-type: none"> • Failed Pressure sensor. • Strainer is dirty. 	Manual Reset required once the issue is resolved. User must toggle the Alarm Reset value.
Condenser Water Entering Temperature (In Fault)				
				
Notification Class	Action	Reason	Typical Causes	Reset Required

Table 33. General unit warning (continued)

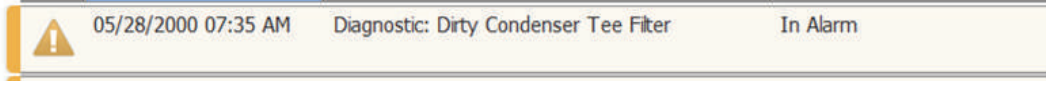
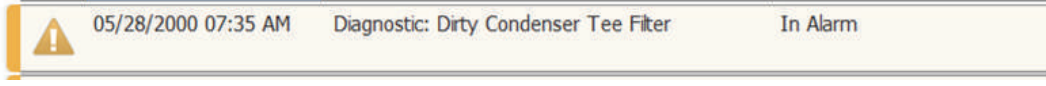

HVAC Service Required.	Only affects the Water Side Economizer, if installed, from operating until this sensor is in a Normal State.	The Pressure sensor is reading either above is maximum value or below is minimum value, resulting in a Fault Condition after 3 point updates.	<ul style="list-style-type: none"> • Sensor is not wired properly: Verify sensor wiring to the XM Module. • XM Module is not communicating. Ensure that the XM Module is up and talking to the UC600. • Sensor has failed. Verify if sensor has any resistance on it, should be 8-12k of resistance on the thermistor. 	None, alarm clears once sensor is in a normal state.
Condenser Water Leaving Temperature (In Fault)				
				
Notification Class	Action	Reason	Typical Causes	Reset Required
HVAC Service Required.	Only affects the Water Side Economizer, if installed, from operating until this sensor is in a Normal State.	The Pressure sensor is reading either above is maximum value or below is minimum value, resulting in a Fault Condition after 3 point updates.	<ul style="list-style-type: none"> • Sensor is not wired properly: Verify sensor wiring to the XM Module. • XM Module is not communicating. Ensure that the XM Module is up and talking to the UC600. • Sensor has failed. Verify if sensor has any resistance on it, should be 8-12k of resistance on the thermistor. 	None, alarm clears once sensor is in a normal state.
Condenser Tee Strainer High Pressure (In Fault)				
				
Notification Class	Action	Reason	Typical Causes	Reset Required
HVAC Service Required.	Affects the alarm for Dirty Strainer, preventing alarm from working properly.	The Pressure sensor is reading either above is maximum value or below is minimum value, resulting in a Fault Condition after 3 point updates.	<ul style="list-style-type: none"> • Sensor is not wired properly: Verify sensor wiring to the XM Module. • XM Module is not communicating. Ensure that the XM Module is up and talking to the UC600. • Sensor has failed. Verify if sensor has any resistance on it, should be 8-12k of resistance on the thermistor. 	None, alarm clears once sensor is in a normal state.
Tee Strainer Low Pressure (In Fault)				

Table 33. General unit warning (continued)



 05022000 01:54 AM Condenser Tee Strainer Low Pressure In Fault				
Notification Class	Action	Reason	Typical Causes	Reset Required
HVAC Service Required.	Affects the alarm for Dirty Strainer, preventing alarm from working properly.	The Pressure sensor is reading either above is maximum value or below is minimum value, resulting in a Fault Condition after 3 point updates.	<ul style="list-style-type: none"> • Sensor is not wired properly: Verify sensor wiring to the XM Module. • XM Module is not communicating. Ensure that the XM Module is up and talking to the UC600. • Sensor has failed. Verify if sensor has any resistance on it, should be 8-12k of resistance on the thermistor. 	None, alarm clears once sensor is in a normal state.
Condenser Tee Strainer Low Pressure (In Fault)				
 05022000 01:54 AM Condenser Tee Strainer Low Pressure In Fault				
Notification Class	Action	Reason	Typical Causes	Reset Required
HVAC Service Required.	Affects the alarm for Dirty Strainer, preventing alarm from working properly.	The Pressure sensor is reading either above is maximum value or below is minimum value, resulting in a Fault Condition after 3 point updates.	<ul style="list-style-type: none"> • Sensor is not wired properly: Verify sensor wiring to the XM Module. • XM Module is not communicating. Ensure that the XM Module is up and talking to the UC600. • Sensor has failed. Verify if sensor has any resistance on it, should be 8-12k of resistance on the thermistor. 	None, alarm clears once sensor is in a normal state.
Condenser Water Flow Switch (In Fault)				
 05/09/2000 01:16 AM Condenser Water Flow Switch In Fault				
Notification Class	Action	Reason	Typical Causes	Reset Required
HVAC Service Required.	Output may not function properly.	The UC600 Controller has lost communications with the Output.	<ul style="list-style-type: none"> • XM Module is not communicating. Ensure that the XM Module is up and talking to the UC600. • Output has gone bad on XM Module. 	None, alarm clears once sensor is in a normal state.
Unit Alarm Output Command (In Fault)				

Table 33. General unit warning (continued)









 05/09/2000 01:17 AM Unit Alarm Output Command In Fault				
Notification Class	Action	Reason	Typical Causes	Reset Required
HVAC Service Required.	Output may not function properly.	The UC600 Controller has lost communications with the Output.	<ul style="list-style-type: none"> • XM Module is not communicating. Ensure that the XM Module is up and talking to the UC600. • Output has gone bad on XM Module. 	None, alarm clears once sensor is in a normal state.
Unit Alarm Output Command (In Fault)				
 05/09/2000 01:17 AM Compressor 1 Command In Fault				
Notification Class	Action	Reason	Typical Causes	Reset Required
HVAC Service Required.	Output may not function properly.	The UC600 Controller has lost communications with the Output.	<ul style="list-style-type: none"> • XM Module is not communicating. Ensure that the XM Module is up and talking to the UC600. • Output has gone bad on XM Module. 	None, alarm clears once sensor is in a normal state.
Compressor 1 E-Stop Shutdown Command (In Fault)				
 05/09/2000 01:17 AM Compressor 1 E-Stop Shutdown Command In Fault				
Notification Class	Action	Reason	Typical Causes	Reset Required
HVAC Service Required.	Output may not function properly.	The UC600 Controller has lost communications with the Output.	<ul style="list-style-type: none"> • XM Module is not communicating. Ensure that the XM Module is up and talking to the UC600. • Output has gone bad on XM Module. 	None, alarm clears once sensor is in a normal state.
Compressor 1 VFD Alarm Reset (In Fault)				
 05/09/2000 01:16 AM Compressor 1 VFD Alarm Reset In Fault				
Notification Class	Action	Reason	Typical Causes	Reset Required
HVAC Service Required.	Output may not function properly.	The UC600 Controller has lost communications with the Output.	<ul style="list-style-type: none"> • XM Module is not communicating. Ensure that the XM Module is up and talking to the UC600. • Output has gone bad on XM Module. 	None, alarm clears once sensor is in a normal state.
Compressor (1-4) Condenser Regulating Valve (In Fault) *If Installed*				

Table 33. General unit warning (continued)

 05/09/2000 01:16 AM Compressor 1 Condenser Regulating Valve In Fault				
Notification Class	Action	Reason	Typical Causes	Reset Required
HVAC Service Required.	Output may not function properly.	The UC600 Controller has lost communications with the Output.	<ul style="list-style-type: none"> • XM Module is not communicating. Ensure that the XM Module is up and talking to the UC600. • Output has gone bad on XM Module. 	None, alarm clears once sensor is in a normal state.
Cooling Tower/Pump Request (In Fault)				
 05/09/2000 01:16 AM Cooling Tower/Pump Request In Fault				
Notification Class	Action	Reason	Typical Causes	Reset Required
HVAC Service Required.	Output may not function properly.	The UC600 Controller has lost communications with the Output.	<ul style="list-style-type: none"> • XM Module is not communicating. Ensure that the XM Module is up and talking to the UC600. • Output has gone bad on XM Module. 	None, alarm clears once sensor is in a normal state.
Supply Fan (1-6) Start Stop Command (In Fault)				
 05/09/2000 01:16 AM Supply Fan 1 Start Stop Command In Fault				
Notification Class	Action	Reason	Typical Causes	Reset Required
HVAC Service Required.	Output may not function properly.	The UC600 Controller has lost communications with the Output.	<ul style="list-style-type: none"> • XM Module is not communicating. Ensure that the XM Module is up and talking to the UC600. • Output has gone bad on XM Module. 	None, alarm clears once sensor is in a normal state.
Supply Fan (1-6) Speed Command (In Fault)				
 05/09/2000 01:16 AM Supply Fan 1 Speed Command In Fault				
Notification Class	Action	Reason	Typical Causes	Reset Required
HVAC Service Required.	Output may not function properly.	The UC600 Controller has lost communications with the Output.	<ul style="list-style-type: none"> • XM Module is not communicating. Ensure that the XM Module is up and talking to the UC600. • Output has gone bad on XM Module. 	None, alarm clears once sensor is in a normal state.

Note: These Warnings are for informational purposes only and do not shut down or lock out any equipment on the unit.

Trane - by Trane Technologies (NYSE: TT), a global innovator - creates comfortable, energy efficient indoor environments for commercial and residential applications. For more information, please visit trane.com or tranetechnologies.com.

Trane has a policy of continuous product and product data improvements and reserves the right to change design and specifications without notice. We are committed to using environmentally conscious print practices.

PKG-SVX027C-EN 31 Oct 2021
Supersedes PKG-SVX027B-EN (July 2020)

©2021 Trane