

INSTALLATION, OPERATION, AND SERVICE MANUAL RESIDENTIAL STORAGE TYPE GAS WATER HEATER

THESE INSTRUCTIONS ARE INTENDED AS AN AID TO QUALIFIED SERVICE PERSONNEL FOR PROPER INSTALLATION, ADJUSTMENT AND OPERATION OF THIS WATER HEATER. READ THESE INSTRUCTIONS THOROUGHLY BEFORE ATTEMPTING INSTALLATION OR OPERATION. FAILURE TO FOLLOW THESE INSTRUCTIONS MAY RESULT IN IMPROPER INSTALLATION, OPERATION, SERVICE OR MAINTENANCE, POSSIBLY RESULTING IN FIRE, ELECTRICAL SHOCK, SCALD INJURY, CARBON MONOXIDE POISONING, EXPLOSION, PROPERTY DAMAGE, PERSONAL INJURY OR DEATH.

INSTALLER:

- ATTACH THESE INSTRUCTIONS TO OR ADJACENT TO THE WATER HEATER.
- BEFORE LEAVING THE PREMISES REVIEW THIS OPERATION AND SERVICE MANUAL TO BE SURE THE HEATER HAS BEEN INSTALLED CORRECTLY. START AND OPERATE THE UNIT FOR ONE COMPLETE CYCLE AND MAKE SURE THE WATER TEMPERATURE IS ACCEPTABLE TO THE CONSUMER AT THE FIXTURES.

OWNER:

- RETAIN THESE INSTRUCTIONS AND WARRANTY FOR FUTURE REFERENCE. RETAIN THE ORIGINAL RECEIPT AS PROOF OF PURCHASE.

SE PUEDE OBTENER UNA VERSION ESPAÑOL DE ESTAS INSTRUCCIONES SI ESCRIBE A LA FÁBRICA QUE APARECE EN LA PLACA DE ESPECIFICACIONES

A SPANISH VERSION OF THESE INSTRUCTIONS MAY BE OBTAINED IF YOU WRITE TO THE MANUFACTURER SHOWN ON THE RATING PLATE.

THIS MANUAL IS NOT TO BE USED WITH GAS STORAGE TYPE WATER HEATERS CERTIFIED FOR INSTALLATION IN MANUFACTURED HOMES (MOBILE HOMES).

AN ODORANT IS ADDED BY THE GAS SUPPLIER TO THE GAS USED BY THIS WATER HEATER. SEE WARNING BELOW.

WARNING

AN ODORANT IS ADDED BY THE GAS SUPPLIER TO THE GAS USED BY THIS WATER HEATER. THIS ODORANT MAY FADE OVER AN EXTENDED PERIOD OF TIME. DO NOT DEPEND UPON THIS ODORANT AS AN INDICATION OF LEAKING GAS. IF A GAS LEAK IS SUSPECTED, CHECK FOR LEAKS BY USING A CHLORIDE-FREE SOAP AND WATER SOLUTION, OR OTHER APPROVED METHOD. IF A LEAK CANNOT BE FOUND BUT IS STILL SUSPECTED, FOLLOW THE STEPS UNDER "WHAT TO DO IF YOU SMELL GAS" AS OUTLINED ON THIS PAGE. FAILURE TO OBSERVE THIS WARNING COULD RESULT IN PROPERTY DAMAGE, PERSONAL INJURY, OR DEATH.

WARNING

THIS WATER HEATER MUST BE BRACED, ANCHORED, OR STRAPPED TO AVOID FALLING OR MOVING DURING AN EARTHQUAKE. CONTACT LOCAL UTILITIES FOR CODE REQUIREMENTS IN YOUR AREA OR CALL THE 800 NUMBER SHOWN ON FRONT OF THIS MANUAL AND REQUEST INSTRUCTIONS 6600933 FOR EXAMPLES.

 Recognize this symbol as an indication of Important Safety Information.

 **WARNING:** If the information in these instructions is not followed exactly, a fire or explosion may result causing property damage, personal injury or death.

Do not store or use gasoline or other flammable vapors and liquids in the vicinity of this or any other appliance.

WHAT TO DO IF YOU SMELL GAS

- Do not try to light any appliance.
- Do not touch any electrical switch; do not use any telephone in your building.
- Immediately call your gas supplier from a neighbor's telephone. Follow the gas supplier's instructions.
- If you cannot reach your gas supplier, call the fire department.

Installation and service must be performed by a qualified installer, service agency or the gas supplier.

TO OBTAIN TECHNICAL, WARRANTY OR SERVICE ASSISTANCE DURING OR AFTER THE INSTALLATION OF THIS WATER HEATER, CALL TOLL FREE:

1-800-999-9515.

WHEN CALLING FOR ASSISTANCE, PLEASE HAVE THE FOLLOWING INFORMATION READY:

1. MODEL NUMBER
2. 7 DIGIT PRODUCT NUMBER
3. SERIAL NUMBER
4. DATE OF INSTALLATION



6510185
March 2000
Supersedes 6510160

⚠ DANGER

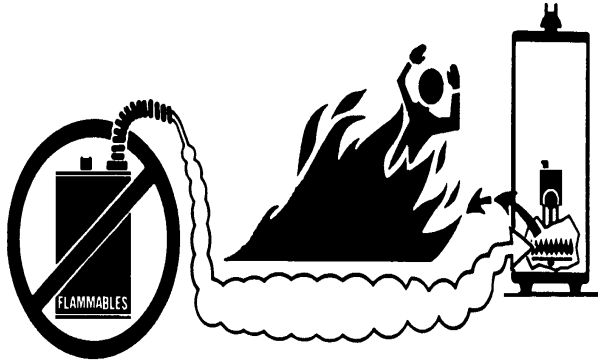

⚠ Vapors from flammable liquids will explode and catch fire causing death or severe burns.

Do not use or store flammable products such as gasoline, solvents or adhesives in the same room or area near the water heater.

Keep flammable products:

1. far away from the water heater.
2. in approved containers,
3. tightly closed and
4. out of children's reach.

Water heater has a main burner and pilot flame.
The pilot flame:

1. is on all the time and
2. will ignite flammable vapors.

Vapors:

1. cannot be seen,
2. are heavier than air
3. go a long way on the floor and
4. can be carried from other rooms to the pilot flame by air currents.

Do not install this heater where flammable products will be stored or used unless the main burner and pilot flames are at least 18 inches above the floor. This will reduce but not eliminate the risk of vapors being ignited by the main burner or pilot flame.

⚠ DANGER

DO NOT USE THIS WATER HEATER WITH ANY GAS OTHER THAN THE ONE LISTED ON THE DATA PLATE. This water heater is equipped for use with one type gas only. CHECK THE DATA PLATE NEAR THE GAS CONTROL VALVE FOR THE CORRECT GAS. FAILURE TO USE THE CORRECT GAS CAN CAUSE PROBLEMS WHICH CAN RESULT IN DEATH, SERIOUS BODILY INJURY OR PROPERTY DAMAGE. If you have any questions or doubts consult your gas supplier or gas utility company. Water heaters using bottled propane or liquefied petroleum gas (LPG) are different from natural gas models. A natural gas water heater will not function safely on bottled propane or liquefied petroleum gas (LPG) and a propane gas water heater will not function safely on natural gas. Do not attempt to convert a water heater from natural gas to LPG or from LPG to natural gas.

WHEN REMOVING PURGED GASES FROM A PIPING SYSTEM, DO NOT CREATE A HAZARDOUS CONDITION BY DISCHARGING THE GASES INTO A CONFINED AREA OR IN AN AREA THAT CONTAINS AN IGNITION SOURCE.

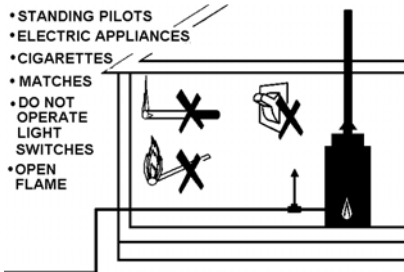

⚠ DANGER

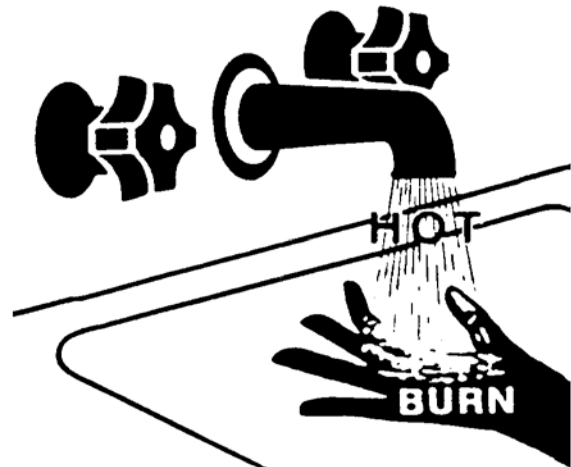

Water temperature over 125°F can cause severe burns instantly or death from scalds.

Children, disabled and elderly are at highest risk of being scalded.

See the instruction manual before setting the water temperature at the water heater.

Feel the water before bathing or showering.

Temperature limiting valves are available for use.

GENERAL SAFETY WARNINGS

BEFORE ATTEMPTING TO INSTALL OR OPERATE THIS WATER HEATER, MAKE SURE YOU READ AND UNDERSTAND THE ENTIRE INSTALLATION, OPERATION AND SERVICE MANUAL. SPECIAL ATTENTION MUST BE GIVEN TO ALL THE SAFETY WARNINGS PROVIDED THROUGHOUT THIS MANUAL. **FAILURE TO FOLLOW THESE WARNINGS COULD RESULT IN A FIRE OR EXPLOSION CAUSING PROPERTY DAMAGE, PERSONAL INJURY OR DEATH.** IF YOU HAVE DIFFICULTY UNDERSTANDING THE INSTRUCTIONS IN THIS MANUAL OR ARE NOT AN EXPERIENCED INSTALLER, DO NOT PROCEED, BUT GET HELP FROM A QUALIFIED INSTALLATION OR SERVICE TECHNICIAN.



- TAMPERING WITH THE THERMOSTAT, IGNITER CONTROL, GAS VALVE OR TEMPERATURE AND PRESSURE RELIEF VALVE IS DANGEROUS AND MAY RESULT IN SERIOUS INJURY OR DEATH. TAMPERING Voids ALL WARRANTIES. ONLY PROPERLY TRAINED, QUALIFIED SERVICE PERSONNEL SHOULD SERVICE THESE COMPONENTS. DO NOT ATTEMPT TO MODIFY OR CHANGE THIS WATER HEATER IN ANY WAY.
- DO NOT ATTEMPT TO CONVERT THIS WATER HEATER FROM NATURAL GAS TO L.P. OR FROM L.P. TO NATURAL GAS. THIS CAN RESULT IN PROPERTY DAMAGE, FIRE, EXPLOSION, BODILY HARM OR DEATH.
- DO NOT INSTALL THIS WATER HEATER IN A MOBILE HOME
- DO NOT INSTALL THIS WATER HEATER OUTDOORS.
- RESIDENTIAL AREAS WHERE FLAMMABLE LIQUIDS (GASOLINE, SOLVENTS, LIQUID PROPANE, BUTANE, ETC.) OR OTHER SUBSTANCES WHICH EMIT FLAMMABLE VAPORS ARE STORED MAY NOT BE SUITABLE FOR WATER HEATER INSTALLATION. NATURAL AIR MOVEMENTS CAN CARRY FLAMMABLE VAPORS SOME DISTANCE FROM WHERE THEY ARE STORED OR USED. NEAR GROUND LEVEL VENTS CAN DRAW THESE VAPORS INTO THE WATER HEATER WHERE THE PILOT FLAME OR MAIN BURNER CAN IGNITE THEM CAUSING PROPERTY DAMAGE, SERIOUS BURNS OR DEATH. NEVER STORE OR USE FLAMMABLE SUBSTANCES IN THE SAME ROOM OR AREA CONTAINING A GAS WATER HEATER. IF SUCH FLAMMABLES MUST BE USED, ALL GAS BURNING APPLIANCES IN THE VICINITY MUST BE SHUT OFF AND THEIR PILOT LIGHTS EXTINGUISHED. OPEN THE DOORS AND WINDOWS FOR VENTILATION WHILE FLAMMABLE SUBSTANCES ARE IN USE.
- FLAMMABLE VAPORS MAY BE DRAWN TO THIS WATER HEATER FROM OTHER AREAS OF THE STRUCTURE BY AIR CURRENTS.
- WATER HEATERS INSTALLED IN RESIDENTIAL GARAGES MUST BE INSTALLED SUCH THAT THE PILOT FLAME AND MAIN BURNER FLAME ARE NO LESS THAN 18 INCHES ABOVE THE FLOOR. THIS IS TO REDUCE BUT NOT ELIMINATE THE RISK OF LIGHTING FLAMMABLE VAPORS WHICH MAY BE PRESENT IN A GARAGE. THIS WATER HEATER MUST BE LOCATED OR PROTECTED TO AVOID PHYSICAL DAMAGE BY VEHICLES OR FLOODING.
- THE WATER HEATER IS CERTIFIED FOR INSTALLATION ON A COMBUSTIBLE FLOOR. HOWEVER WHEN THIS WATER HEATER IS INSTALLED OVER CARPETING, THE CARPETING MUST BE PROTECTED BY A METAL OR WOOD PANEL BENEATH THE WATER HEATER AND EXTENDING BEYOND THE FULL WIDTH AND DEPTH OF THE WATER HEATER BY AT LEAST THREE INCHES IN ANY DIRECTION. IF THE WATER HEATER IS INSTALLED IN A CARPETED ALCOVE OR CLOSET, THE ENTIRE FLOOR MUST BE COVERED BY THE PANEL. FAILURE TO FOLLOW THESE INSTRUCTIONS MAY RESULT IN A FIRE HAZARD.
- THIS WATER HEATER AND ANY OTHER GAS FUEL BURNING APPLIANCE MUST BE PROVIDED WITH ENOUGH FRESH AIR FOR PROPER VENTILATION OF THE FLUE GASES.
- REPAIR, REPLACEMENT, SERVICE AND CLEANING OF WATER HEATER PARTS MUST ONLY BE PERFORMED BY A QUALIFIED SERVICE TECHNICIAN.
- DO NOT USE AN OPEN FLAME OR ANY KIND OF SPARK TO CHECK GAS PIPING FOR LEAKS.
- DO NOT ATTEMPT TO LIGHT THIS WATER HEATER UNTIL IT IS PROPERLY INSTALLED AND YOU UNDERSTAND ALL OF THE SAFETY WARNINGS AND PRECAUTIONS.
- VENTILATION AND COMBUSTION AIR SUPPLIES CANNOT BE TAKEN FROM AREAS THAT CONTAIN NEGATIVE PRESSURE PRODUCING DEVICES SUCH AS FIREPLACES, EXHAUST FANS AND AIR CIRCULATION SYSTEMS. INLET AIR CANNOT BE TAKEN FROM AN ATTIC EQUIPPED WITH POWER VENTILATION.
- THE USE OF VENT DAMPERS IS NOT RECOMMENDED BY THE MANUFACTURERS OF THIS WATER HEATER.
- FAILURE TO PROPERLY VENT THIS WATER HEATER CAN CAUSE AN EXPLOSION, FIRE, OR CARBON MONOXIDE POISONING WHICH MAY RESULT IN PROPERTY DAMAGE, PERSONAL INJURY OR DEATH.
- DO NOT VENT THIS WATER HEATER AND A FORCED DRAFT OR POWER VENT APPLIANCE INTO THE SAME CHIMNEY OR GAS VENT.
- MOISTURE IN THE FLUE GASES MAY CONDENSE AND FORM ON THE EXTERIOR OF THE GAS VENT PIPE. IMPROPER LOCATION OR INSTALLATION CAN CAUSE STRUCTURAL DAMAGE TO THE RESIDENCE.
- VENT CONNECTORS MAY NOT TERMINATE WITHIN A CHIMNEY FLUE SERVING A FIREPLACE UNLESS THE FLUE OPENING IS PERMANENTLY SEALED.
- OBSTRUCTIONS OR HOLES IN THE VENT PIPE CAN CAUSE TOXIC FUMES TO ENTER THE HOME RESULTING IN CARBON MONOXIDE POISONING OR DEATH. THE VENT PIPE MUST BE REPLACED IF IT IS LEAKING.
- NEVER OPERATE AN EMPTY OR PARTIALLY FILLED WATER HEATER. THIS CAN RESULT IN SERIOUS DAMAGE TO THE TANK.
- DO NOT ATTEMPT TO OPERATE THIS WATER HEATER WITH THE COLD WATER SHUTOFF VALVE CLOSED.
- DO NOT ATTEMPT TO OPERATE THIS WATER HEATER WITHOUT A PROPERLY INSTALLED TEMPERATURE AND PRESSURE RELIEF VALVE. FAILURE TO INSTALL AND MAINTAIN A NEW AND PROPERLY LISTED TEMPERATURE AND PRESSURE RELIEF VALVE WILL RELEASE THE MANUFACTURER FROM ANY CLAIMS WHICH MIGHT RESULT FROM EXCESSIVE TEMPERATURE OR WATER PRESSURE.
- WATER SUPPLY TO THIS HEATER MUST NOT EXCEED 180° F. WATER TEMPERATURES IN EXCESS OF 180° F WILL CAUSE THE HIGH LIMIT CONTROL (ECO) TO OPEN AND SHUT OFF THE GAS SUPPLY TO THE UNIT. THE HIGH LIMIT CONTROL IS A SINGLE USE TYPE THAT WILL REQUIRE THE REPLACEMENT OF THE THERMOSTAT BEFORE THE BURNER CAN OPERATE.
- THIS WATER HEATER IS EQUIPPED FOR ONE TYPE OF GAS ONLY. DO NOT USE THIS WATER HEATER WITH ANY GAS OTHER THAN THE ONE LISTED ON THE DATA PLATE LOCATED NEAR THE GAS CONTROL. FAILURE TO USE THE CORRECT GAS CAN RESULT IN PROPERTY DAMAGE, BODILY INJURY OR DEATH.
- ADJUSTING THE THERMOSTAT PAST THE 120° F BAR ON THE TEMPERATURE DIAL WILL INCREASE THE RISK OF SCALD INJURY.

GENERAL SAFETY WARNINGS (CONT.)



- CONTAMINANTS IN THE GAS PIPING MAY FOUL THE THERMOSTAT CAUSING A MALFUNCTION, FIRE OR EXPLOSION. BE SURE ALL GAS PIPING IS CLEAN AND CLEAR ON THE INSIDE BEFORE ATTACHING THE GAS LINE.
- HYDROGEN GAS CAN BE PRODUCED IN A HOT WATER SYSTEM THAT HAS NOT BEEN USED FOR A LONG PERIOD OF TIME (GENERALLY TWO WEEKS OR MORE). HYDROGEN GAS IS EXTREMELY FLAMMABLE AND CAN IGNITE WHEN EXPOSED TO A SPARK OR FLAME. TO PREVENT THE POSSIBILITY OF INJURY UNDER THESE CONDITIONS, WE RECOMMEND THE HOT WATER FAUCET BE OPENED FOR SEVERAL MINUTES AT THE KITCHEN SINK BEFORE USING ANY ELECTRICAL APPLIANCE WHICH IS CONNECTED TO THE HOT WATER SYSTEM. IF HYDROGEN IS PRESENT, THERE WILL PROBABLY BE AN UNUSUAL SOUND SUCH AS AIR ESCAPING THROUGH THE FAUCET AS WATER BEGINS TO FLOW. DO NOT SMOKE OR HAVE ANY OPEN FLAME NEAR THE FAUCET AT THE TIME IT IS OPEN.
- HOT WATER CAN PRODUCE FIRST DEGREE BURNS WITHIN:
 - 3 SECONDS AT 140°F (60°C)
 - 20 SECONDS AT 130°F (54°C)
 - 8 MINUTES AT 120°F (49°C)
- DO NOT ATTEMPT TO BYPASS OR JUMPER THE ECO. THIS WILL VOID THE WARRANTY AND RELEASE THE MANUFACTURER FROM ANY LIABILITY FOR ANY ACCIDENT RESULTING FROM ELIMINATING THE ECO FROM THE WATER HEATER CIRCUIT.
- HOUSEHOLDS WITH SMALL CHILDREN, ELDERLY, IMPAIRED OR DISABLED MEMBERS AND ANYONE WITH TEMPERATURE SENSITIVE SKIN MAY REQUIRE A LOW TEMPERATURE SETTING TO REDUCE THE RISK OF SCALD INJURY.
- THE GAS LINE MUST BE OF ADEQUATE SIZE SO AS TO PREVENT UNDUE PRESSURE DROP AND NEVER SMALLER THAN THE PIPE SIZE TO THE GAS VALVE ON THE WATER HEATER. FAILURE TO PROPERLY SIZE THE GAS LINE CAN RESULT IN A FIRE OR EXPLOSION CAUSING PROPERTY DAMAGE, PERSONAL INJURY OR DEATH.

CONSUMER INFORMATION

This water heater is design-certified by CSA International as a Category I, non-direct vented water heater which takes its combustion air either from the installation area or from air ducted to the unit from the outside.

This water heater should be installed in accordance with the latest edition of the "National Fuel Gas Code", ANSI Z223.1, NFPA 54 and the requirements and codes of the local utilities or other authorities having jurisdiction. This is available from the following:

National Fire Protection Agency 1 Batterymarch Park Quincy, MA 02269	American Gas Association 1515 Wilson Boulevard Arlington, VA 22209
--	--

Local Authorities (Check your telephone listings)

CONSUMER RESPONSIBILITIES

This manual has been prepared to acquaint you with the installation, operation and maintenance of your gas water heater and to provide important safety information in these areas.

We urge you to read all of the instructions thoroughly before attempting the installation or operation of this water heater. This manual should be kept for future reference.

The manufacturer of this water heater will not be liable for any damages caused by failure to comply with the installation and operating instructions outlined in this manual.

If you lack the necessary skills required to properly install this water heater or you have difficulty following the directions, you should not proceed but have a qualified person perform the installation of this water heater.

A data plate identifying your water heater can be found next to the gas control valve/thermostat. When referring to your water heater always have the information listed on the data plate readily available.

Retain your original receipt as proof of purchase.

HIGH ALTITUDE INPUT RATING

The input rating on the data plate of this water heater is for installations up to 2000 feet of elevation. For installations at elevations above 2000 feet, the rating should be reduced by 4 percent for each 1000 feet above sea level.

WATER HEATER MODIFICATION/TAMPERING



TAMPERING WITH THE THERMOSTAT, IGNITER CONTROL, GAS VALVE, OR TEMPERATURE AND PRESSURE RELIEF VALVE IS DANGEROUS AND MAY RESULT IN SERIOUS INJURY OR DEATH. TAMPERING VOIDS ALL WARRANTIES. ONLY PROPERLY TRAINED, QUALIFIED SERVICE PERSONNEL SHOULD SERVICE THESE COMPONENTS. DO NOT ATTEMPT TO MODIFY OR CHANGE THIS WATER HEATER IN ANY WAY.

INSULATION BLANKET

Some governing bodies may require the use of external insulation blankets when water heaters are installed in newly constructed homes and additions. If an insulation blanket is applied to this water heater **CAUTION** must be exercised so as to not restrict its proper function and operation. Please note the following:

- The space between the base of the water heater and the floor must remain unobstructed to allow for proper airflow. As time passes, the blanket may sag and obstruct the air passage resulting in unsafe water heater operation.
- Do not apply an insulation blanket to the top of the water heater as this may obstruct the draft hood.
- Do not cover the temperature and pressure relief valve, any labels or instruction materials applied to the water heater. These labels must remain visible for reference by the user. Do not remove these labels, as they are a permanent part of the water heater as required by the certification agencies and/or the Federal Government.
- Do not cover any access panels leading to burner compartments. Do not cover the thermostat controls, or doors on the water heater.

GAS CONVERSION



DO NOT ATTEMPT TO CONVERT THIS WATER HEATER FROM NATURAL GAS TO L.P. OR FROM L.P. TO NATURAL GAS. THIS CAN RESULT IN PROPERTY DAMAGE, FIRE, EXPLOSION, BODILY HARM OR DEATH.

TABLE OF CONTENTS

	PAGE
SAFETY PRECAUTIONS	1,2
GENERAL SAFETY WARNINGS	3,4
CONSUMER INFORMATION/RESPONSIBILITIES	4
WATER HEATER MODIFICATION/TAMPERING	4
TABLE OF CONTENTS	5
LOCATION REQUIREMENTS AND CONSIDERATIONS	5,6
VENTILATION AND COMBUSTION AIR SUPPLY	7,8
VENT PIPE SYSTEM	9,10
WATER SYSTEM PIPING	11,12
SPECIAL APPLICATIONS	13
GAS SUPPLY AND PIPING	14,15
INSTALLATION CHECK LIST	15
START-UP/OPERATION	16-19
OPERATIONAL CONDITIONS	19
MAINTENANCE	20
BURNER ASSEMBLY REMOVAL, CLEANING, AND REPLACEMENT	20-21
THERMOCOUPLE AND PILOT ASSY. REPLACEMENT	21
GAS CONTROL VALVE/THERMOSTAT REPLACEMENT	22
TROUBLESHOOTING GUIDE	22-23
REPAIR PARTS LIST AND ILLUSTRATION	24

FIGURE 1
RESIDENTIAL STORAGE
TYPE GAS WATER HEATER

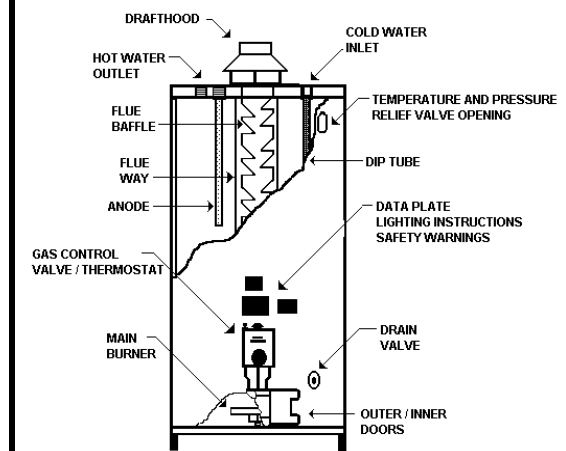

1. SOME MODELS MAY VARY SLIGHTLY IN APPEARANCE.
2. SOME MODELS MAY LOCATE THE TEMPERATURE AND PRESSURE RELIEF VALVE TAPPING ON THE TOP OF THE WATER HEATER.

IMPORTANT: TO INSURE PROPER INSTALLATION AND OPERATION OF THIS PRODUCT, COMPLETELY READ ALL INSTRUCTIONS PRIOR TO ATTEMPTING TO ASSEMBLE, INSTALL, OPERATE, MAINTAIN OR REPAIR THIS PRODUCT. UPON UNPACKING OF THE WATER HEATER INSPECT ALL PARTS FOR DAMAGE PRIOR TO INSTALLATION AND START-UP. THIS WATER HEATER MUST BE INSTALLED ONLY BY QUALIFIED INSTALLATION PERSONNEL..

LOCATION REQUIREMENTS AND CONSIDERATIONS

GENERAL INFORMATION

WARNING

DO NOT INSTALL THIS WATER HEATER IN A MOBILE HOME. This water heater is not approved for installation in a mobile home. **DO NOT INSTALL OUTDOORS.** This water heater is certified for indoor installation only. Failure to follow these instructions could result in **FIRE, PROPERTY DAMAGE, PERSONAL INJURY OR DEATH.**

DANGER

AREAS WHERE FLAMMABLE LIQUIDS (GASOLINE, SOLVENTS, LIQUID PROPANE, BUTANE, ETC.) OR OTHER SUBSTANCES WHICH EMIT FLAMMABLE VAPORS ARE STORED MAY NOT BE SUITABLE FOR WATER HEATER INSTALLATION. NATURAL AIR MOVEMENTS CAN CARRY FLAMMABLE VAPORS SOME DISTANCE FROM WHERE THEY ARE STORED OR USED. NEAR GROUND LEVEL VENTS CAN DRAW THESE VAPORS INTO THE WATER HEATER WHERE THE PILOT FLAME OR MAIN BURNER CAN IGNITE THEM CAUSING PROPERTY DAMAGE, SERIOUS BURNS OR DEATH. NEVER STORE OR USE FLAMMABLE SUBSTANCES IN THE SAME ROOM OR AREA CONTAINING A GAS WATER HEATER. IF SUCH FLAMMABLES MUST BE USED, ALL GAS BURNING APPLIANCES IN THE VICINITY MUST BE SHUT OFF AND THEIR PILOT LIGHTS EXTINGUISHED. OPEN THE DOORS AND WINDOWS FOR VENTILATION WHILE FLAMMABLE SUBSTANCES ARE IN USE.

WARNING

FLAMMABLE VAPORS MAY BE DRAWN TO THIS WATER HEATER FROM OTHER AREAS OF THE STRUCTURE BY AIR CURRENTS.

IMPORTANT: This water heater should not be installed near a corrosive or potentially corrosive air supply. Water heater corrosion and component failure can be caused by the heating and breaking down of airborne chemicals. These materials are corrosive at low concentration levels with little or no odor to reveal their presence. Examples of potentially corrosive locations and compounds are:

- Beauty shops, dry cleaning establishments, photo processing labs
- Liquid or powdered bleaches, swimming pool chemicals, spray can propellants, cleaning solvents
- Refrigerants
- Calcium and sodium chloride
- Waxes and process chemicals

Products of this sort should not be stored near the water heater or air inlet.

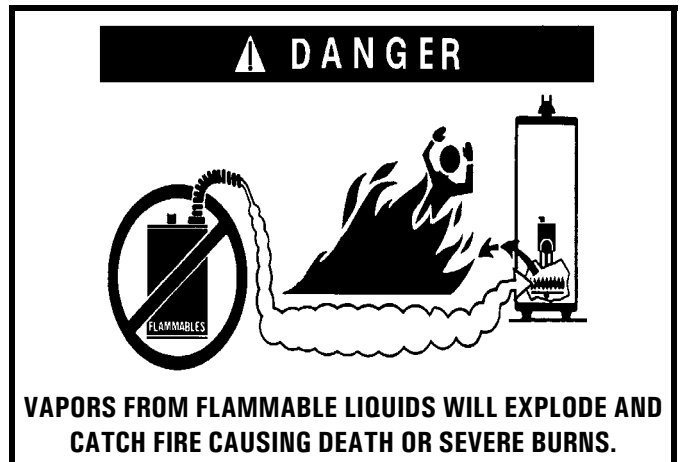

WARNING

IT IS NOT DESIRABLE TO INSTALL A GAS FIRED WATER HEATER IN A RESIDENTIAL GARAGE. IF INSTALLATION IN A RESIDENTIAL GARAGE IS YOUR ONLY OPTION, THIS WATER HEATER MUST BE INSTALLED SUCH THAT THE PILOT FLAME AND MAIN BURNER FLAME ARE NO LESS THAN 18 INCHES ABOVE THE FLOOR (SEE FIGURE 2, PAGE 6). THIS IS TO REDUCE BUT NOT ELIMINATE THE RISK OF IGNITING FLAMMABLE VAPORS WHICH MAY BE PRESENT IN A GARAGE. THE WATER HEATER MUST BE LOCATED OR PROTECTED TO AVOID PHYSICAL DAMAGE BY VEHICLES OR FLOODING. FAILURE TO FOLLOW THESE WARNINGS CAN CAUSE A FIRE OR EXPLOSION, RESULTING IN PROPERTY DAMAGE, PERSONAL INJURY OR DEATH.

LOCATION REQUIREMENTS AND CONSIDERATIONS (CONT.)

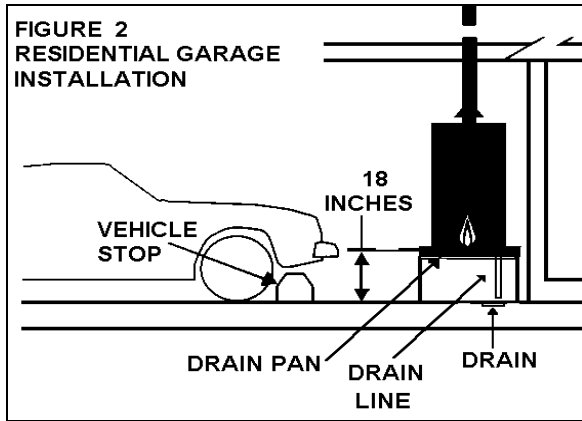

SITE LOCATION

1. Select a location near the center of the water piping system. It must be installed indoors and in a vertical position on a level surface. **DO NOT** install in bathrooms, bedrooms or any occupied room normally kept closed.
2. Locate the water heater as close to the chimney or gas vent as is practical. Consider the vent system piping and combustion air supply requirements when selecting the water heater location. The venting system must be able to run from the water heater to the termination with a minimal length and elbows. **THE VENT PIPE CANNOT EXCEED THE MAXIMUM ALLOWABLE LENGTH AS PERMITTED IN THE "NATIONAL FUEL GAS CODE".**
3. Locate the water heater near the existing gas piping. If installing a new gas line, locate the water heater to minimize the pipe length and elbows.

IMPORTANT

4. The water heater should be located in an area where leakage of the tank or connections will not result in damage to the area adjacent to the water heater or to lower floors of the structure. It is recommended that a suitable metal drain pan be installed under the water heater as shown below. This pan is to protect the property from damage which may occur from normal condensate formation on the tank jacket or leaks in the tank and pipe connections. The pan must limit the water level to a maximum depth of 1 3/4 inches and be two inches wider than the heater and piped to an adequate drain. Locate the water heater near a suitable inside drain. Outside drains are subject to freezing temperatures which can obstruct the drain line. The piping should be at least 3/4" ID and pitched for proper drainage. This pan must not restrict combustion air flow. **UNDER NO CIRCUMSTANCES IS THE MANUFACTURER TO BE HELD LIABLE FOR ANY WATER DAMAGE IN CONNECTION WITH THIS WATER HEATER.**

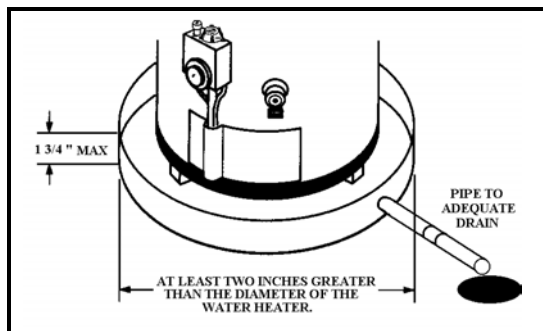

5. The water heater should be located in an area not subject to freezing temperatures. Water heaters located in unconditioned spaces (i.e. attics, basements, etc.) may require the insulation of the water piping and drain piping to protect against freezing. The drain and controls must be easily accessible for operation and service. Maintain proper clearances as specified.

6. Do not locate the water heater near an air-moving device. The operation of air-moving devices such as exhaust fans, ventilation systems, clothes dryers, fireplaces, etc., can affect the proper operation of the water heater. Special attention must be given to conditions these devices may create to avoid unsatisfactory operation of the equipment.

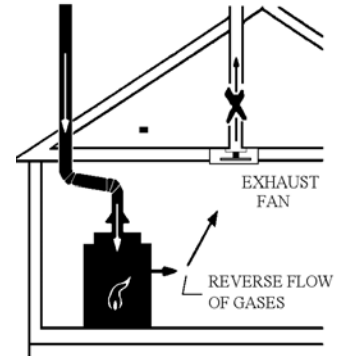

CLEARANCE/ACCESSIBILITY

Minimum clearances from combustible materials are stated on the data plate adjacent to the thermostat of the water heater. **REFER TO THE DATA PLATE OF THE WATER HEATER FOR THE CORRECT CLEARANCES FROM COMBUSTIBLE CONSTRUCTION MATERIALS.** Figure 3 may be used as a reference guide to locate the specific clearance locations. A minimum of 24 inches of front clearance should be provided for inspection and service.

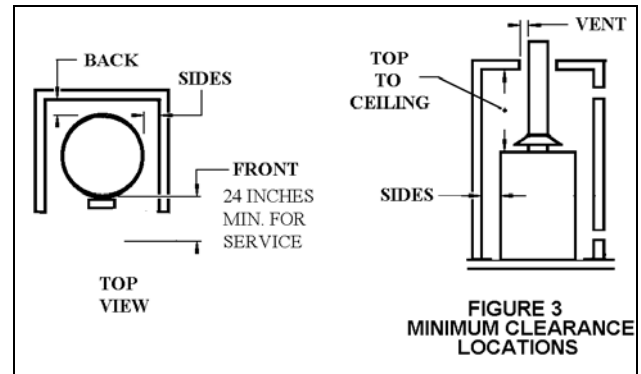

⚠ WARNING

THE WATER HEATER IS CERTIFIED FOR INSTALLATION ON A COMBUSTIBLE FLOOR. HOWEVER, WHEN THIS WATER HEATER IS INSTALLED OVER CARPETING, THE CARPETING MUST BE PROTECTED BY A METAL OR WOOD PANEL BENEATH THE WATER HEATER AND EXTENDING BEYOND THE FULL WIDTH AND DEPTH OF THE WATER HEATER BY AT LEAST THREE INCHES IN ANY DIRECTION. IF THE WATER HEATER IS INSTALLED IN A CARPETED ALCOVE OR CLOSET, THE ENTIRE FLOOR MUST BE COVERED BY THE PANEL. FAILURE TO FOLLOW THESE INSTRUCTIONS MAY RESULT IN A FIRE HAZARD.

VENTILATION AND COMBUSTION AIR SUPPLY

GENERAL INFORMATION

! WARNING

THIS WATER HEATER AND ANY OTHER FUEL BURNING APPLIANCE MUST BE PROVIDED WITH ENOUGH FRESH AIR FOR PROPER VENTILATION OF THE FLUE GASES. MOST HOMES WILL REQUIRE THAT OUTSIDE AIR BE SUPPLIED INTO THE WATER HEATER AREA. FAILURE TO DO SO CAN RESULT IN EXPLOSION, FIRE, PROPERTY DAMAGE, CARBON MONOXIDE POISONING, PERSONAL INJURY OR DEATH.

Adequate facilities for providing air for combustion and ventilation must be provided in accordance with the "National Fuel Gas Code", ANSI Z223.1-Latest Edition, NFPA 54 or the applicable provisions of the local building codes.

IMPORTANT: Air for combustion and ventilation must not come from a corrosive atmosphere. Any failure due to corrosive elements in the atmosphere is excluded from warranty coverage.

The following types of installation (but not limited to the following) will require outdoor air for combustion due to chemical exposure and may reduce but not eliminate the presence of corrosive chemicals in the air:

- Beauty shops
- Photo processing labs
- Buildings with indoor pools
- Water heaters installed in laundry, hobby or craft rooms.
- Water heaters installed near chemical storage areas

Combustion air must be free of acid-forming chemicals such as sulfur, fluorine, and chlorine. These elements are found in aerosol sprays, detergents, bleaches, cleaning solvents, air fresheners, paint and varnish removers, refrigerants, and many other commercial and household products. When burned, vapors from these products form highly corrosive acid compounds. These products should not be stored near the water heater or air inlet.

Combustion and ventilation air requirements are determined by the location of the water heater. The water heater may be located in either an open (unconfined) area or in a confined area or small enclosure such as a closet or small room. **Confined spaces are areas with less than 50 cubic feet for each 1,000 BTUH of the total input for all gas-using appliances.**

WATER HEATER LOCATION - UNCONFINED SPACE

A water heater in an unconfined space uses indoor air for combustion and requires at least **50 cubic feet for each 1,000 BTUH of the total input for all gas appliances.** The table below shows a few examples of the minimum square feet required for various BTUH inputs.

BTUH INPUT	MIN. SQ. FEET	TYPICAL ROOM SIZE
	WITH 8' CEILING	WITH 8' CEILING
30,000	188	9 X 21
45,000	281	14 X 20
60,000	375	15 X 25
75,000	469	15 X 31
90,000	563	20 X 28
105,000	657	20 X 33
120,000	750	25 X 30
135,000	844	28 X 30

Areas which are being used for storage or contain large space consuming items may not be suitable for water heater installation. The area must be open and be able to provide the proper air requirements to the water heater.

IMPORTANT: Water heaters installed in open spaces in buildings with unusually tight construction may still require outdoor air to function properly. In this situation, outside air openings should be sized the same as for a confined space.

MODERN HOME CONSTRUCTION USUALLY REQUIRES SUPPLYING OUTSIDE AIR INTO THE WATER HEATER AREA.

CONSULT THE LOCAL CODES OF YOUR AREA FOR SPECIFIC VENTILATION AND COMBUSTION AIR REQUIREMENTS.

CONFINED SPACES

For the correct and safe operation of this water heater, ample air must be supplied for the combustion, ventilation and dilution of flue gases. Small enclosures and confined areas must have **two permanent openings** so that sufficient fresh air can be drawn from outside of the enclosure. One opening shall be **within 12 inches of the top and one within 12 inches of the bottom of the enclosure** as shown in Figure 4 below.

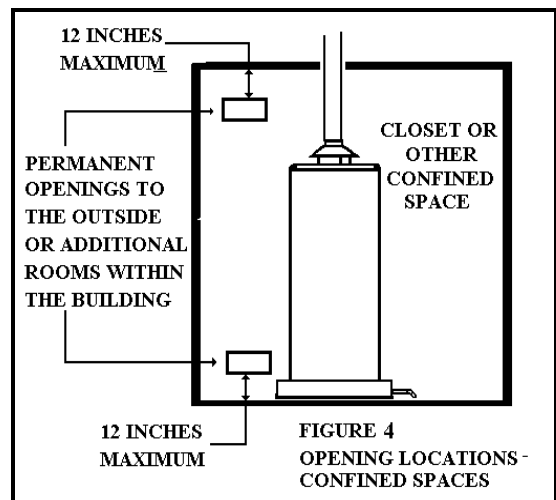

The size of each opening (free area) is determined by the total Btuh input of all gas utilization equipment (i.e. water heaters, furnaces, clothes dryers, etc.) and the method by which the air is provided. The Btuh input can be found on the water heater data plate. Additional air can be provided by two methods:

1. All air from inside the building.
2. All air from outdoors.

ALL AIR FROM INSIDE THE BUILDING

When additional air is to be provided to the confined area from additional room(s) within the building, the total volume of the room(s) must be of sufficient size to properly provide the necessary amount of fresh air to the water heater and other gas utilization equipment in the area. If you are unsure that the structure meets this requirement, contact your local gas utility company or other qualified agency for a safety inspection.

Each of the two openings shall have a minimum free area of 1 square inch per 1,000 Btuh of the total input rating of all gas utilization equipment in the confined area, but not less than 100 square inches (Figure 5, Page 8).

! CAUTION

AIR CANNOT BE TAKEN FROM AREAS THAT CONTAIN NEGATIVE PRESSURE PRODUCING DEVICES SUCH AS FIREPLACES, EXHAUST FANS, AND AIR CIRCULATION SYSTEMS.

VENTILATION AND COMBUSTION AIR SUPPLY (CONT.)

ALL AIR FROM OUTDOORS

Outdoor fresh air can be provided to a confined area either directly or by the use of vertical and horizontal ducts. The fresh air can be taken from the outdoors or from crawl or attic spaces that freely communicate with the outdoors. Attic or crawl spaces cannot be closed and must be properly ventilated to the outside.

Ductwork must be of the same cross-sectional area as the free area of the opening to which they connect. The minimum dimension of rectangular air ducts cannot be less than 3 inches.

The size of each of the two openings is determined by the method in which the air is to be provided. Refer to Table 1 to calculate the minimum free area for each opening. Figures 6, 7, and 8 are typical examples of each method.

CAUTION

INLET AIR CANNOT BE TAKEN FROM AN ATTIC EQUIPPED WITH POWER VENTILATION.

LOUVERS AND GRILLES

In calculating free area for ventilation and combustion air supply openings, consideration must be given to the blocking affect of protection louvers, grilles, and screens. These devices can reduce air flow which in turn may require larger openings to achieve the required minimum free area. Screens must not be smaller than 1/4 inch mesh. If the free area through a particular design of louver or grille is known, it should be used in calculating the specified free area of the opening. If the design and free area are not known, it can be assumed that most wood louvers will allow 20 - 25% of free area while metal louvers and grilles will allow 60 - 75% of free area. Louvers and grilles must be locked open or interconnected with the equipment so that they are opened automatically during equipment operation.

Keep louvers and grilles clean and free of debris or other obstructions.

**TABLE 1
MINIMUM FREE AREA OF PERMANENT OPENINGS FOR
VENTILATION AND COMBUSTION AIR SUPPLY - ALL AIR FROM
OUTSIDE ONLY.**

Based on the total Btuh input rating for all gas utilizing equipment within the confined space.

OPENING SOURCE	MINIMUM FREE AREA PER OPENING (SQ. IN.)	REFERENCE DRAWING
DIRECT TO OUTDOORS*	1 SQUARE INCH PER 4000 BTUH	FIGURE 6
VERTICAL DUCTS	1 SQUARE INCH PER 4000 BTUH	FIGURE 7
HORIZONTAL DUCTS	1 SQUARE INCH PER 2000 BTUH	FIGURE 8

Example: A water heater with an input rate of 50,000 Btuh using horizontal ducts would require each opening to have a minimum free area of 25 square inches.

Minimum Free Area = $50,000 \text{ Btuh} \times 1 \text{ sq. in.} / 2000 \text{ Btuh} = 25 \text{ Sq. Inches.}$

* These openings may communicate directly with the outdoors through a ventilated attic, a ventilated crawl space, or through an outside wall.

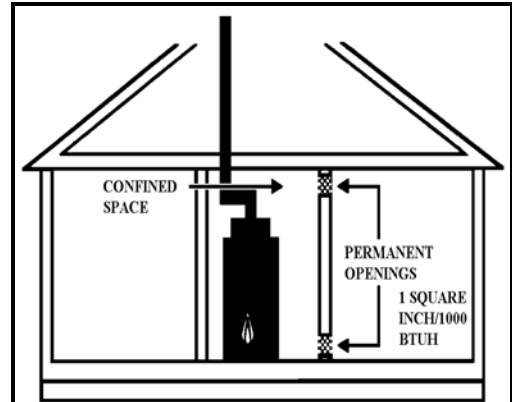

**FIGURE 5
ALL AIR FROM INSIDE BUILDING
CONFINED SPACE INSTALLATION**

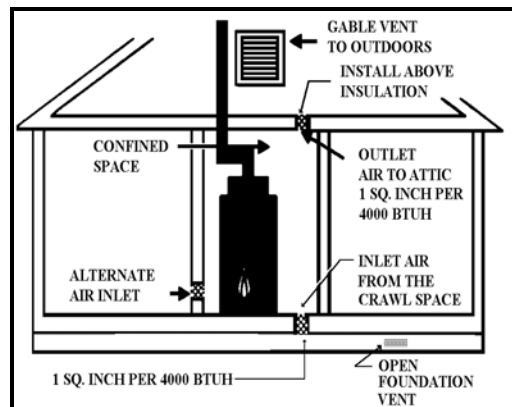

**FIGURE 6
ALL AIR FROM OUTDOORS: INLET AIR FROM VENTILATED CRAWL
SPACE/OUTLET AIR TO VENTILATED ATTIC**

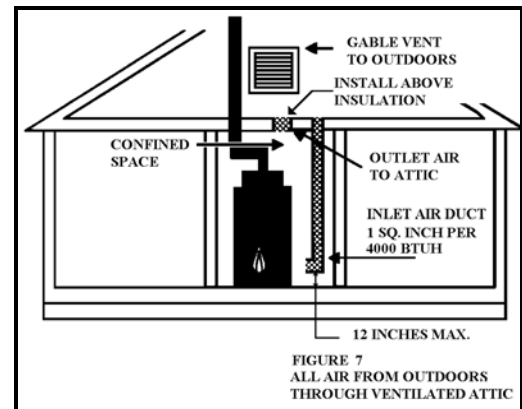

**FIGURE 7
ALL AIR FROM OUTDOORS
THROUGH VENTILATED ATTIC**

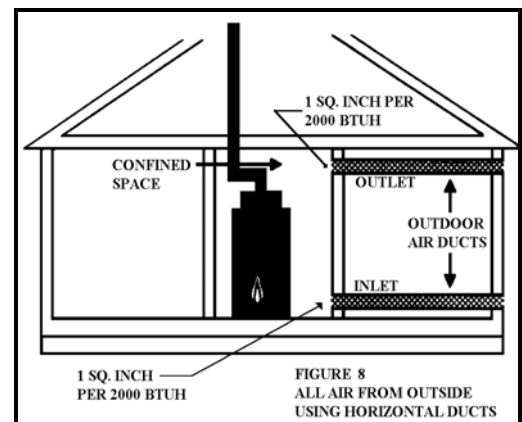

**FIGURE 8
ALL AIR FROM OUTSIDE
USING HORIZONTAL DUCTS**

VENT PIPE SYSTEM

GENERAL INFORMATION

⚠️ WARNING

THE USE OF VENT DAMPERS IS NOT RECOMMENDED BY THE MANUFACTURERS OF THIS WATER HEATER. ALTHOUGH SOME VENT DAMPERS ARE CERTIFIED BY THE AMERICAN GAS ASSOCIATION LABORATORIES, THIS CERTIFICATION APPLIES TO THE VENT DAMPER DEVICE ONLY AND DOES NOT MEAN THEY ARE CERTIFIED FOR USE ON THIS WATER HEATER.

⚠️ WARNING

FAILURE TO PROPERLY VENT THIS WATER HEATER CAN CAUSE AN EXPLOSION, FIRE, OR CARBON MONOXIDE POISONING WHICH MAY RESULT IN PROPERTY DAMAGE, PERSONAL INJURY OR DEATH.

This water heater uses a non-direct, single-pipe vent system to remove exhaust gases created by the burning of fossil fuels. Air for combustion is taken from the immediate water heater location or is ducted in from the outside (see "Ventilation and Combustion Air Supply").

This water heater must be properly vented for the removal of exhaust gases to the outside atmosphere. **Correct installation of the vent pipe system is mandatory for the safe and efficient operation of this water heater and is an important factor in the life of the unit.**

Vent pipe installation must be performed in accordance with the "National Fuel Gas Code", NFPA 54, ANSI Z223.1-Latest Edition, or applicable provisions of the local building codes, and not obstructed so as to prevent the removal of exhaust gases to the outside atmosphere.

A U.L. APPROVED FUEL GAS AND CO DETECTOR(S) ARE RECOMMENDED IN ALL APPLICATIONS AND THEIR INSTALLATION SHOULD BE IN ACCORDANCE WITH THE MANUFACTURER'S RECOMMENDATIONS AND/OR LOCAL LAWS, RULES, REGULATIONS, OR CUSTOMS.

IMPORTANT: If you lack the necessary skills required to properly install this venting system, you should not proceed but get help from a qualified installation technician.

⚠️ WARNING

WATER HEATER VENT CONNECTORS SHALL NOT BE CONNECTED TO ANY PORTION OF A MECHANICAL DRAFT SYSTEM OPERATING UNDER POSITIVE STATIC PRESSURE. FAILURE TO FOLLOW THIS WARNING COULD RESULT IN PROPERTY DAMAGE, PERSONAL INJURY, OR DEATH.

DRAFT HOOD INSTALLATION

Align the legs of the draft hood with the slots on the water heater's top cover. Insert the legs and secure the draft hood to the water heater's top with the four screws provided as shown in Figure 9. Do not alter the draft hood in any way. If you are replacing an existing water heater be sure to use the new draft hood supplied with this water heater.

Make sure the flue baffle is engaged in the slots provided in the flue tube.

⚠️ CAUTION

MOISTURE IN THE FLUE GASES MAY CONDENSE AND FORM ON THE EXTERIOR OF THE GAS VENT PIPE. IMPROPER LOCATION OR INSTALLATION CAN CAUSE STRUCTURAL DAMAGE TO THE RESIDENCE.

FIGURE 9
DRAFTHOOD INSTALLATION

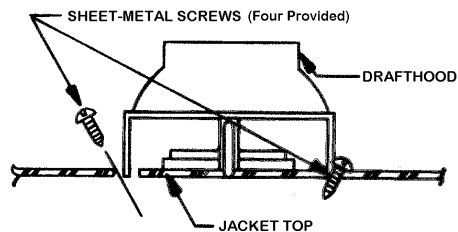

INSTALL THE DRAFTHOOD WITH THE FOUR SCREWS PROVIDED

VENT PIPE SIZING

The sizing of this vent system must be done in accordance with the "National Fuel Gas Code", NFPA 54, ANSI Z223.1-Latest Edition. It is important that you follow the guidelines in these instructions for sizing a vent pipe system.

If a transition to a larger vent size is required, the vent transition connection must be made at the draft hood outlet.

VENT CONNECTOR

A vent connector is used to connect the water heater to a certified chimney or vertical gas vent. Vent connectors for this water heater can be made of the following materials:

1. Type B, Double Wall, U.L. Listed Vent Pipe.
2. Single Wall Vent Pipe.

WHEN USING SINGLE WALL VENT PIPE, MAINTAIN A 6 INCH MINIMUM CLEARANCE FROM ALL COMBUSTIBLE MATERIALS. WHEN USING TYPE B DOUBLE WALL VENT PIPE, MAINTAIN THE MANUFACTURER'S SPECIFIED MINIMUM CLEARANCE FROM COMBUSTIBLE MATERIALS.

IMPORTANT: Single wall vent pipe cannot be used for water heaters located in attics and may not pass through attic spaces, crawl spaces or any confined or inaccessible location. A single wall metal vent connector cannot pass through any interior wall.

Vent connectors made of Type B, double wall vent pipe material may pass through walls or partitions constructed of combustible material if the minimum listed clearance is maintained.

When installing a vent connector please note the following:

- Maintain a minimum clearance of 6 inches from all combustible materials when using single wall vent pipe.
- Install the vent connector so as to avoid unnecessary bends which create resistance to the flow of vent gases.
- Install without dips or sags with an upward slope of at least **1/4 inch per foot (2 cm/m)**.
- Joints must be fastened by sheet metal screws or other approved means. It must be supported to maintain clearances and prevent separation of joints and damage.
- The length of the vent connector cannot exceed 75% of the vertical vent height.
- The vent connector must be accessible for cleaning, inspection and replacement.
- Vent connectors cannot pass through any ceiling, floor, fire wall, or fire partition.

VENT PIPE SYSTEM (CONT.)

IMPORTANT: Existing vent systems must be inspected for obstructions, corrosion and proper installation.

⚠ CAUTION

VENT CONNECTORS MAY NOT TERMINATE WITHIN A CHIMNEY FLUE SERVING A FIREPLACE UNLESS THE FLUE OPENING IS PERMANENTLY SEALED.

CHIMNEY CONNECTION

IMPORTANT: Before connecting a vent to a chimney, make sure the chimney passageway is clear and free of obstructions. The chimney must be cleaned if previously used for venting solid fuel appliances or fireplaces.

- The connector must be installed above the extreme bottom of the chimney to prevent potential stoppage of the flue gases.
- The connector must be firmly attached and sealed to prevent it from falling out.
- To aid in removing the connector, a thimble or slip joint may be used.
- The connector must not extend beyond the inner edge of the chimney as it may restrict the space between it and the opposite wall of the chimney (Figure 10).
- Do not terminate the vent connector in a chimney that has not been certified for this purpose. Some local codes may prohibit the termination of vent connectors in a masonry chimney.

VERTICAL GAS VENTS

Vertical gas vents must be installed with UL listed Type B vent pipe according to the vent manufacturer's instructions and the terms of its listing.

It may be connected to the water heater's draft hood by a certified vent connector or by directly originating at the draft hood opening.

Vertical gas vents must terminate with a listed cap or other roof assembly and be installed according to their manufacturer's instructions.

Gas vents must be supported to prevent damage, joint separation, and maintain clearances to combustible materials. See Figures 11 and 12.

IMPORTANT: This gas vent must be terminated in a vertical position.

An **unused** chimney flue or masonry enclosure may be used as a passageway for the installation of a gas vent. (Figure 12)

COMMON VENTING IS ALLOWABLE WITH VERTICAL TYPE B VENT SYSTEMS AND LINED MASONRY CHIMNEYS. FOLLOW THE "NATIONAL FUEL GAS CODE", NFPA 54, ANSI Z223.1-LATEST EDITION, FOR PROPER VENTING PROCEDURES.

FIGURES 10-12 ARE EXAMPLES OF VENT PIPE SYSTEM INSTALLATIONS AND MAY OR MAY NOT BE TYPICAL FOR YOUR SPECIFIC APPLICATION. CONSULT THE "NATIONAL FUEL AND GAS CODE", NFPA 54, ANSI Z223.1-LATEST EDITION AND THE GUIDELINES SET FORTH BY PREVAILING LOCAL CODES.

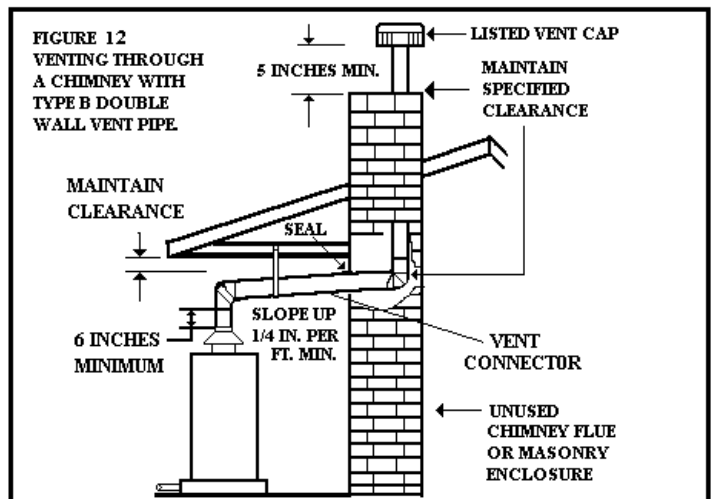
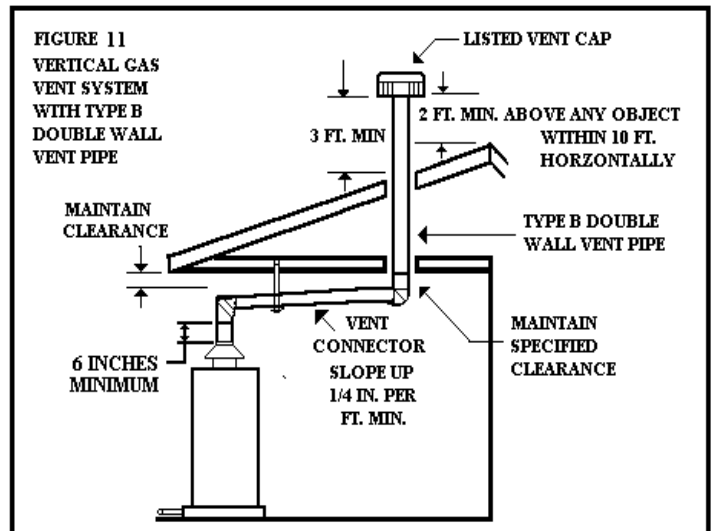
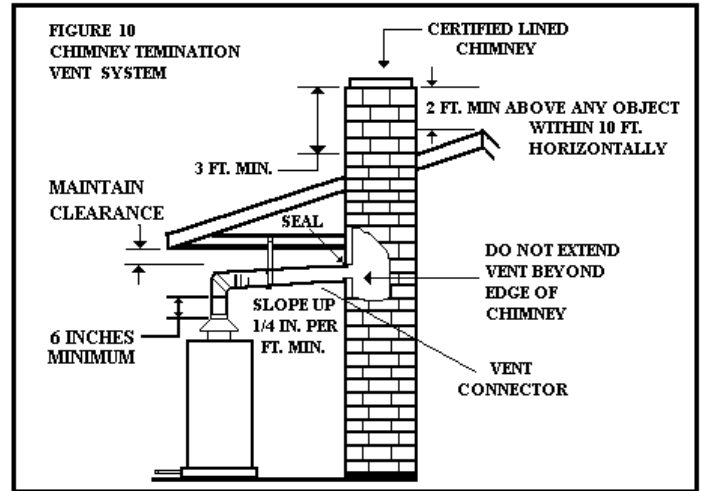

WATER SYSTEM PIPING

GENERAL INFORMATION

Water piping, fittings, and valves must be properly installed for the correct and safe operation of this water heater. Please note the following:

DO NOT install this water heater with iron piping. The system should be installed only with new piping that is suitable for potable (drinkable) water such as copper, CPVC, or polybutylene. **DO NOT** use PVC water piping.

DO NOT use any pumps, valves, or fittings that are not compatible with potable water.

DO NOT use valves that may cause excessive restriction to water flow. Use full flow ball or gate valves only.

DO NOT use 50/50 tin-lead solder (or any lead based solder) in potable water lines. Use 95/5 tin-antimony or other equivalent material.

DO NOT tamper with the thermostat, gas valve, ignitor control or temperature and pressure relief valve. Tampering with any of the components is **DANGEROUS** and can result in property damage, severe injury or death. Tampering voids all warranties. Only qualified technicians should service these components.

DO NOT use with piping that has been treated with chromate's, boiler seal, or other chemicals.

DO NOT add any chemicals to the system piping which will contaminate the potable water supply.

DO NOT install check valves in the cold water supply line to the water heater.

CAUTION

NEVER OPERATE AN EMPTY OR PARTIALLY FILLED WATER HEATER. THIS CAN RESULT IN SERIOUS DAMAGE TO THE TANK.

TEMPERATURE & PRESSURE RELIEF VALVE

WARNING

DO NOT ATTEMPT TO OPERATE THIS WATER HEATER WITHOUT A PROPERLY INSTALLED TEMPERATURE AND PRESSURE RELIEF VALVE. FAILURE TO FOLLOW THIS INSTRUCTION CAN RESULT IN PROPERTY DAMAGE, PERSONAL INJURY OR DEATH.

For protection against excessive pressures and temperatures, a temperature and pressure relief valve must be installed in the opening marked "T & P RELIEF VALVE" (see Figure 13). This valve must be design certified by a nationally recognized testing laboratory that maintains periodic inspection of the production of listed equipment or materials as meeting the requirements for Relief Valves and Automatic Shut-off Devices for Hot Water Supply Systems., ANSI Z21.22. The function of the temperature and pressure relief valve is to discharge water in large quantities in the event of excessive temperature or pressure developing in the water heater. The valve must not exceed the working pressure of the water heater as stated on the data plate.

TO PREVENT PROPERTY DAMAGE, PERSONAL INJURY OR DEATH, THE RELIEF VALVE MUST BE ALLOWED TO OPERATE PROPERLY.

Only a new temperature and pressure relief valve should be used with your water heater. Do not use an old or existing valve as it may be damaged or not adequate for the working pressure of the new water heater. Do not place any valve between the relief valve and the tank.

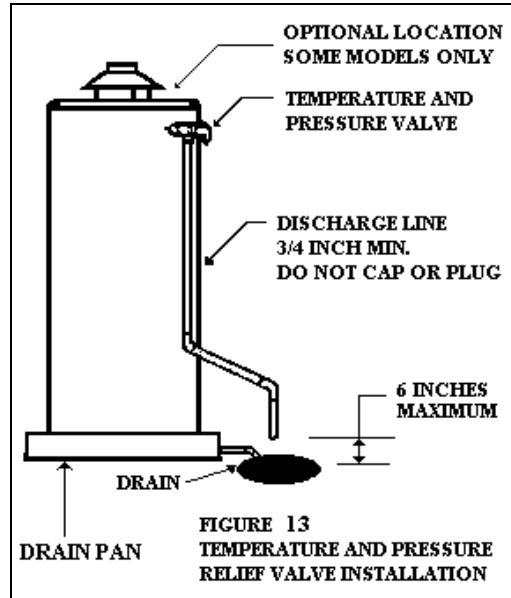

FIGURE 13
TEMPERATURE AND PRESSURE
RELIEF VALVE INSTALLATION

THE TEMPERATURE & PRESSURE RELIEF VALVE:

- Must not be in contact with any electrical part.
- Must be connected to an adequate discharge line.
- Must not exceed the working pressure shown on the data plate of the water heater.

THE DISCHARGE LINE:

- Must not be smaller than the pipe size of the relief valve.
- Must not be capped, blocked, plugged or contain any valve between the relief valve and the end of the discharge line.
- Must terminate a maximum of 6 inches above a floor drain or external to the building.
- Must be capable of withstanding 250°F (121°C) without distortion.
- Must be installed to allow complete drainage of both the temperature and pressure relief valve and discharge line.

WARNING

FAILURE TO INSTALL AND MAINTAIN A NEW PROPERLY LISTED TEMPERATURE AND PRESSURE RELIEF VALVE WILL RELEASE THE MANUFACTURER FROM ANY CLAIMS WHICH MIGHT RESULT FROM EXCESSIVE TEMPERATURE OR WATER PRESSURE.

Manually operate the temperature and pressure relief valve at least once a year to make sure it is working properly.

To prevent water damage, the valve must be properly connected to a discharge line which terminates at an adequate drain. Standing clear of the outlet (discharged water may be hot), slowly lift and release the lever handle on the

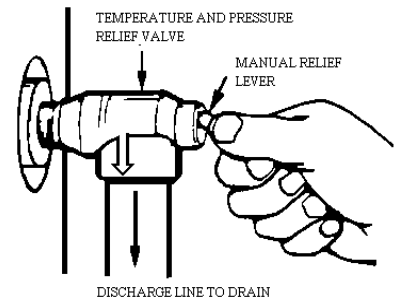

temperature and pressure relief valve to allow the valve to operate freely and return to its closed position. If the valve fails to completely reset and continues to release water, immediately shut off the manual gas valve and the cold water inlet valve and call a qualified service technician.

WATER SYSTEM PIPING (CONT.)

⚠ DANGER

DISCHARGING WATER MAY BE HOT AND CAN CAUSE SCALD INJURIES AND PROPERTY DAMAGE. DISCHARGE LINES MUST BE PROPERLY INSTALLED AND PIPED TO AN ADEQUATE DRAIN.

CLOSED SYSTEM/THERMAL EXPANSION

Periodic discharge of the temperature and pressure relief valve may be due to thermal expansion in a closed water supply system. The water utility supply meter may contain a check valve, backflow preventer or water pressure reducing valve. This will create a closed water system. During the heating cycle of the water heater, the water expands causing pressure inside the water heater to increase. The temperature and pressure relief valve may discharge hot water under these conditions which results in a loss of energy and a build-up of lime on the relief valve seat. To prevent this from happening, there are two recommendations:

1. Install a 125 PSI pressure relief valve in the cold water supply line. **Make sure the discharge of this valve is directed to an open drain and protected from freezing.**
2. Install a diaphragm-type expansion tank that is suitable for potable water on the cold water supply line. The expansion tank must have a minimum capacity of 1.5 U.S. gallons for every 50 gallons of stored water.

Contact the local water supplier or plumbing inspector for information on how to control this situation. Do not plug the temperature and pressure relief valve.

PIPING INSTALLATION

Piping, fittings, and valves should be installed according to the installation drawing (Figure 14). If the indoor installation area is subject to freezing temperatures, the water piping must be protected by insulation.

Water supply pressure should not exceed 80% of the working pressure of the water heater. The working pressure is stated on the water heater's data plate. If this occurs a pressure limiting valve with a by-pass may need to be installed in the cold water inlet line. This should be placed on the supply to the entire house in order to maintain equal hot and cold water pressures.

IMPORTANT: Heat cannot be applied to the water fittings on the heater as they may contain nonmetallic parts. If solder connections are used, solder the pipe to the adapter before attaching the adapter to the hot and cold water fittings.

IMPORTANT: Always use a good grade of joint compound and be certain that all fittings are drawn up tight.

1. Install the water piping and fittings as shown in the Figure 14. Connect the cold water supply (3/4 NPT) to the fitting marked "C". Connect the hot water supply (3/4 NPT) to the fitting marked "H". Make sure the dip tube is in the cold water fitting before connecting the hot and cold water lines. (Note: 75T75 has 1" NPT)

IMPORTANT: Some models may contain energy saving heat traps to prevent the circulation of hot water within the pipes. Do not remove the pink and blue inserts within the heat traps.

2. The installation of unions in both the hot and cold water supply lines is recommended for ease of removing the water heater for service or replacement.
3. The manufacturer of this water heater recommends installing a tempering valve or an anti-scald device in the domestic hot water line as shown in Figure 15. These valves reduce the point of use temperature of the water by mixing cold and hot water and are readily available for use. Contact a licensed plumber or the local plumbing authority.

4. If installing the water heater in a closed water system, install a relief valve or expansion tank in the cold water line as specified under "Closed System/Thermal Expansion".
5. Install a shutoff valve in the cold water inlet line. It should be located close to the water heater and be easily accessible. Know the location of this valve and how to shut off the water to the heater.
6. Install a temperature and pressure relief valve and discharge line in the opening marked "T & P RELIEF VALVE". Install as specified under "Temperature and Pressure Relief Valve, pg. 11".
7. After piping has been properly connected to the water heater, open the nearest hot water faucet and allow the tank to completely fill with water. To purge the lines of any excess air and sediment, keep the hot water faucet open for 3 minutes after a constant flow of water is obtained. Close the faucet and check all connections for leaks.

IMPORTANT: Do not fail to install a suitable drain pan under the water heater and pipe the drain line to an adequate drain. See Site Location, page 6, for details.

⚠ WARNING

DO NOT ATTEMPT TO OPERATE THIS WATER HEATER WITH THE COLD WATER SHUTOFF VALVE CLOSED. THIS CAN RESULT IN SERIOUS DAMAGE TO THE WATER HEATER TANK.

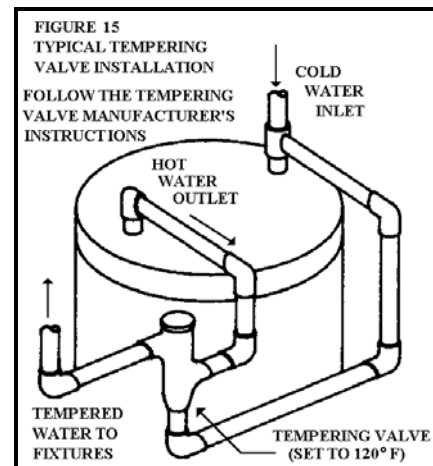
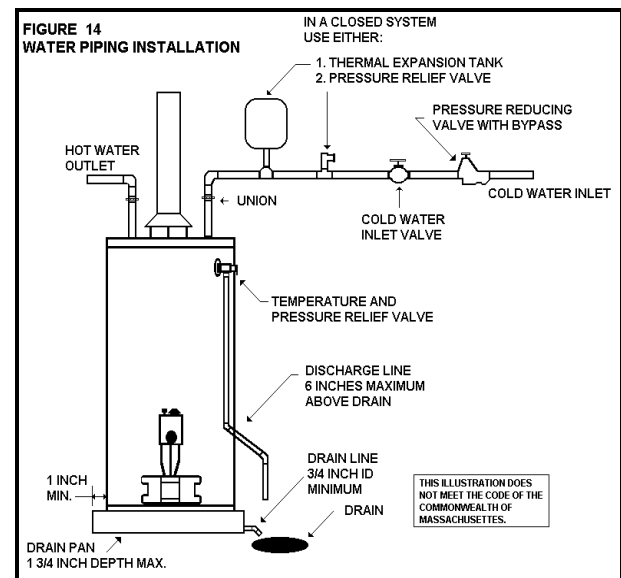

WATER SYSTEM PIPING (CONT.)

⚠ DANGER

DISCHARGING WATER MAY BE HOT AND CAN CAUSE SCALD INJURIES AND PROPERTY DAMAGE. DISCHARGE LINES MUST BE PROPERLY INSTALLED AND PIPED TO AN ADEQUATE DRAIN.

CLOSED SYSTEM/THERMAL EXPANSION

Periodic discharge of the temperature and pressure relief valve may be due to thermal expansion in a closed water supply system. The water utility supply meter may contain a check valve, backflow preventer or water pressure reducing valve. This will create a closed water system. During the heating cycle of the water heater, the water expands causing pressure inside the water heater to increase. The temperature and pressure relief valve may discharge hot water under these conditions which results in a loss of energy and a build-up of lime on the relief valve seat. To prevent this from happening, there are two recommendations:

1. Install a 125 PSI pressure relief valve in the cold water supply line. **Make sure the discharge of this valve is directed to an open drain and protected from freezing.**
2. Install a diaphragm-type expansion tank that is suitable for potable water on the cold water supply line. The expansion tank must have a minimum capacity of 1.5 U.S. gallons for every 50 gallons of stored water.

Contact the local water supplier or plumbing inspector for information on how to control this situation. Do not plug the temperature and pressure relief valve.

PIPING INSTALLATION

Piping, fittings, and valves should be installed according to the installation drawing (Figure 14). If the indoor installation area is subject to freezing temperatures, the water piping must be protected by insulation.

Water supply pressure should not exceed 80% of the working pressure of the water heater. The working pressure is stated on the water heater's data plate. If this occurs a pressure limiting valve with a by-pass may need to be installed in the cold water inlet line. This should be placed on the supply to the entire house in order to maintain equal hot and cold water pressures.

IMPORTANT: Heat cannot be applied to the water fittings on the heater as they may contain nonmetallic parts. If solder connections are used, solder the pipe to the adapter before attaching the adapter to the hot and cold water fittings.

IMPORTANT: Always use a good grade of joint compound and be certain that all fittings are drawn up tight.

1. Install the water piping and fittings as shown in the Figure 14. Connect the cold water supply (3/4 NPT) to the fitting marked "C". Connect the hot water supply (3/4 NPT) to the fitting marked "H". Make sure the dip tube is in the cold water fitting before connecting the hot and cold water lines. (Note: 75T75 has 1" NPT)

IMPORTANT: Some models may contain energy saving heat traps to prevent the circulation of hot water within the pipes. Do not remove the pink and blue inserts within the heat traps.

2. The installation of unions in both the hot and cold water supply lines is recommended for ease of removing the water heater for service or replacement.
3. The manufacturer of this water heater recommends installing a tempering valve or an anti-scald device in the domestic hot water line as shown in Figure 15. These valves reduce the point of use temperature of the water by mixing cold and hot water and are readily available for use. Contact a licensed plumber or the local plumbing authority.

4. If installing the water heater in a closed water system, install a relief valve or expansion tank in the cold water line as specified under "Closed System/Thermal Expansion".
5. Install a shutoff valve in the cold water inlet line. It should be located close to the water heater and be easily accessible. Know the location of this valve and how to shut off the water to the heater.
6. Install a temperature and pressure relief valve and discharge line in the opening marked "T & P RELIEF VALVE". Install as specified under "Temperature and Pressure Relief Valve, pg. 11".
7. After piping has been properly connected to the water heater, open the nearest hot water faucet and allow the tank to completely fill with water. To purge the lines of any excess air and sediment, keep the hot water faucet open for 3 minutes after a constant flow of water is obtained. Close the faucet and check all connections for leaks.

IMPORTANT: Do not fail to install a suitable drain pan under the water heater and pipe the drain line to an adequate drain. See Site Location, page 6, for details.

⚠ WARNING

DO NOT ATTEMPT TO OPERATE THIS WATER HEATER WITH THE COLD WATER SHUTOFF VALVE CLOSED. THIS CAN RESULT IN SERIOUS DAMAGE TO THE WATER HEATER TANK.

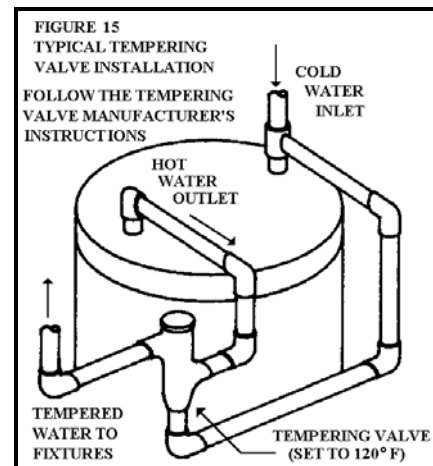
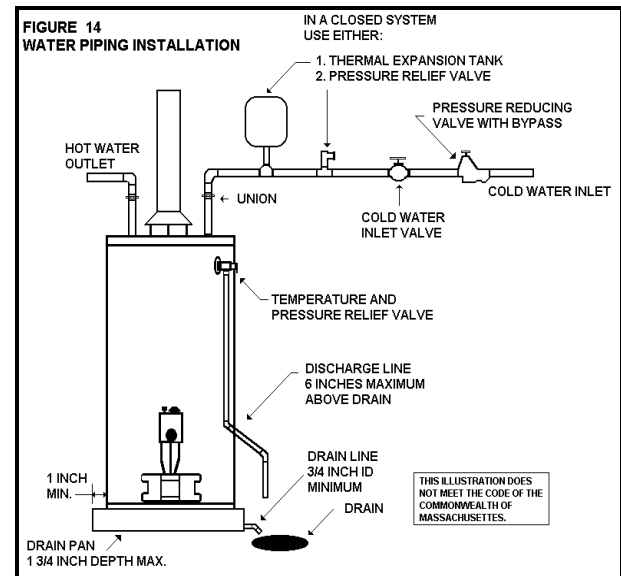

SPECIAL APPLICATIONS

COMBINATION SPACE HEATING/POTABLE WATER HEATING SYSTEM

Some water heater models are equipped with inlet/outlet tapplings for use with space heating applications. If this water heater is to be used to supply both space heating and domestic potable (drinking) water, the instructions listed below must be followed.

- Be sure to follow the manual(s) shipped with the air handler system.
- This water heater is not to be used as a replacement for an existing boiler installation.
- Do not use with piping that has been treated with chromates, boiler seal or other chemicals.
- This water piping contains potable (drinkable) water. Do not add boiler treatment or any chemicals to any water heater piping.
- If the space heating system requires water temperatures in excess of 120°F, a tempering valve or an anti-scald device should be installed per its manufacturer's instructions in the domestic (potable) hot water supply to limit the risk of scald injury.
- Pumps, valves, piping, and fittings must be compatible with potable water.

! WARNING

FAILURE OF THE FLOW CONTROL VALVE MAY RESULT IN EXCESSIVELY HIGH WATER TEMPERATURE FROM THERMOSIPHONING.

- A properly installed flow control valve is required for proper operation. (See Figure above)
- Thermosiphoning is the result of a continuous flow of water through the Air Handler circuit during the off cycle. Weeping (blow off) of the Temperature and Pressure Relief Valve (T & P) or higher than normal water temperatures are the first signs of thermosiphoning.

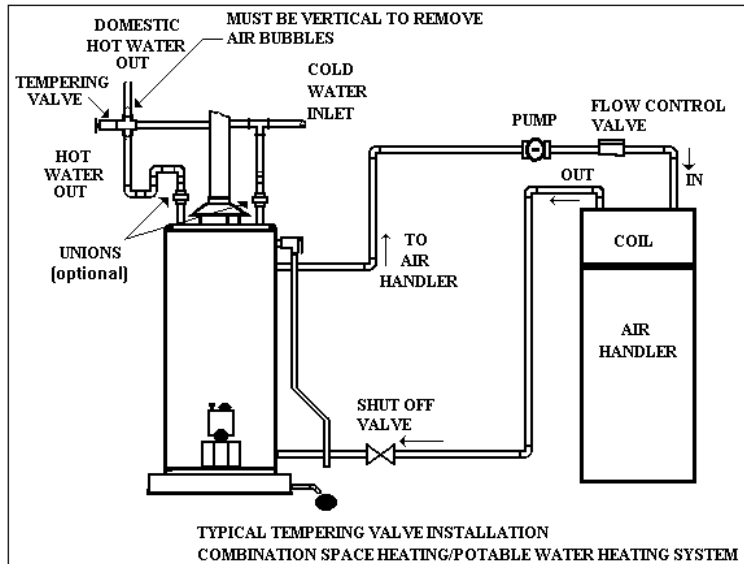

- Domestic hot water line from the water heater should be vertical past any tempering valve or supply line to the air handler to remove air bubbles from the system. These bubbles will be trapped in the Air Handler heat exchanger coil, reducing the efficiency.

Some jurisdictions may require a backflow preventer in the incoming cold water line. This may cause the temperature and pressure relief valve on the water heater to discharge or weep due to expansion of the heated water. A diaphragm-type expansion tank suitable for potable water will normally eliminate this weeping condition. Please read and follow the manufacturer's instructions for the installation of such tanks.

Also see "General Information, Water System Piping", pg. 11 for additional instructions on the safe and correct installation and operation of this water heater.

SOLAR INSTALLATION

If this water heater is used as a **SOLAR STORAGE HEATER OR AS A BACKUP FOR THE SOLAR SYSTEM**, the water supply temperatures to the water heater tank may be in excess of 120°F. A tempering valve or other temperature limiting valve must be installed in the water supply line to limit the supply temperature to 120°F. An anti-scald device must be installed in the domestic hot water supply line to limit the risk of scald injury.

Solar Water Heating Systems can often supply water with temperatures exceeding 180°F and may result in water heater malfunction. Please read the following warning.

! WARNING

WATER SUPPLY TO THIS HEATER MUST NOT EXCEED 180°F. WATER TEMPERATURE IN EXCESS OF 180°F WILL CAUSE THE HIGH LIMIT CONTROL TO OPEN AND SHUT OFF THE GAS SUPPLY TO THE UNIT. THE HIGH LIMIT CONTROL IS A SINGLE USE TYPE THAT WILL REQUIRE THE REPLACEMENT OF THE THERMOSTAT BEFORE THE BURNER CAN OPERATE.

GAS SUPPLY AND PIPING

GENERAL INFORMATION



DANGER

THIS WATER HEATER IS EQUIPPED FOR ONE TYPE OF GAS ONLY. DO NOT USE THIS WATER HEATER WITH ANY GAS OTHER THAN THE ONE LISTED ON THE DATA PLATE LOCATED NEAR THE GAS CONTROL. FAILURE TO USE THE CORRECT GAS CAN RESULT IN PROPERTY DAMAGE, BODILY INJURY, OR DEATH.

This water heater must only be connected to gas supplied by a commercial utility.

GAS PIPING

Install the gas piping according to all local and state codes or with the "National Fuel Gas Code", ANSI Z223.1 (NFPA 54)-Latest Edition.

Do not use copper and brass piping and fittings (except tin-lined copper tubing) if the gas contains more than 0.3 grains of hydrogen sulfide per 100 standard cubic feet of gas. Contact your local gas utility company if you are unsure about this.

Table 2 and Table 3 are provided as a sizing reference for commonly used gas pipe materials. Consult the "National Fuel and Gas Code" for the recommended gas pipe size of other materials.



DANGER

THE GAS LINE MUST BE OF ADEQUATE SIZE SO AS TO PREVENT UNDUE PRESSURE DROP AND NEVER SMALLER THAN THE PIPE SIZE TO THE GAS VALVE ON THE WATER HEATER. FAILURE TO PROPERLY SIZE THE GAS LINE CAN CAUSE A FIRE OR EXPLOSION RESULTING IN PROPERTY DAMAGE, BODILY INJURY OR DEATH.

When installing gas piping, use a pipe joint compound that is resistant to the action of propane (LPG) gases. Apply the compound to male threads only. Do not apply the compound to the first 2 threads. Do not use TEFLON tape.

Do not use pipe joint compound or TEFLON tape on the union connection.



CAUTION

CONTAMINANTS IN THE GAS PIPING MAY FOUL THE THERMOSTAT CAUSING A MALFUNCTION, FIRE, OR EXPLOSION. BE SURE ALL GAS PIPING IS CLEAN AND CLEAR ON THE INSIDE BEFORE ATTACHING THE GAS LINE.

When making pipe connections, use a back-up wrench to prevent any twisting of the control valve/ thermostat assembly. Do not use excessive force when tightening the pipe joint at the thermostat inlet.

Refer to Figure 16 page 15 and install as follows:

1. Install a readily accessible manual shutoff valve in the gas supply line as recommended by the local utility. Know the location of this valve and how to turn off the gas to this unit.
2. Install a drip leg (if not already incorporated as part of the water heater) as shown. The drip leg must be no less than 3 inches long for the accumulation of dirt, foreign material and water droplets.
3. Install a ground joint union between the gas valve/thermostat and the manual shutoff valve. This is to allow easy removal of the gas valve/ thermostat.

IMPORTANT: Refer to the "Gas Pressure Testing" section on the next page before pressure testing the gas lines.

TABLE 2

NATURAL GAS PIPE CAPACITY TABLE (CU. FT./HR)

Capacity of gas pipe of different diameters and lengths in cu. ft. per hr. with pressure drop of 0.3 in. and specific gravity of 0.60 (natural gas).

Nominal Iron Pipe Size, Inches	Length of Pipe, Feet													
	10	20	30	40	50	60	70	80	90	100	125	150	175	200
1/2	132	92	73	63	56	50	46	43	40	38	34	31	28	26
3/4	278	190	152	130	115	105	96	90	84	79	72	64	59	55
1	520	350	285	245	215	195	180	170	160	150	130	120	110	100
1-1/4	1050	730	590	500	440	400	370	350	320	305	275	250	225	210
1-1/2	1600	1100	890	760	670	610	560	530	490	460	410	380	350	320

After the length of pipe has been determined, select the pipe size which will provide the minimum cubic feet per hour required for the gas input rating of the water heater. By formula:

$$\text{Cu. Ft. Per Hr. Required} = \frac{\text{Gas Input of Water Heater (BTU/HR)}}{\text{Heating Value of Gas (BTU/FT}^3\text{)}}$$

The gas input of the water heater is marked on the water heater data plate. The heating value of the gas (BTU/FT³) may be determined by consulting the local natural gas utility.

TABLE 3

LP GAS PIPE CAPACITY TABLE

Maximum capacity of pipe in thousands of BTU per hour of undiluted liquefied petroleum gases (at 11 inches water column pressure). Based on a Pressure Drop of 0.5 Inch Water Column.

Nominal iron pipe size, in.	Length of Pipe, Feet													
	10	20	30	40	50	60	70	80	90	100	125	150		
1/2	275	189	152	129	114	103	96	89	83	78	69	63		
3/4	567	393	315	267	237	217	196	185	173	162	146	132		
1	1071	732	590	504	448	409	378	346	322	307	275	252		
1-1/4	2205	1496	1212	1039	913	834	771	724	677	630	567	511		

Example: Input BTU requirement of the water heater, 100,000 BTUH
Total pipe length, 80 feet = 3/4" IPS required.

GAS SUPPLY AND PIPING (CONT.)

- Turn the gas supply on and check for leaks. Use a chloride-free soap and water solution (bubbles forming indicate a leak) or other approved method. **Do not use an open flame. ALL LEAKS MUST BE FIXED IMMEDIATELY.**

! DANGER

DO NOT USE AN OPEN FLAME OR ANY KIND OF SPARK TO CHECK GAS PIPING FOR LEAKS. IF LEAKING GAS IS PRESENT, AN EXPLOSION OR FIRE MAY RESULT CAUSING PROPERTY DAMAGE, PERSONAL INJURY OR DEATH.

IMPORTANT: This water heater and its gas connection must be leak tested before placing the appliance in operation.

IMPORTANT: Air may be present in the gas lines and could prevent the pilot from lighting on initial start-up. The gas lines should be purged of air by a qualified service technician after installation of the gas piping system.

The gas supply pressure must not exceed the maximum supply pressure as stated on the water heater's data plate. The minimum supply pressure is for the purpose of input adjustment.

GAS PRESSURE TESTING

IMPORTANT: Subjecting the gas valve/thermostat to pressures exceeding 14" W.C. (1/2 psi, 3.7 kPa) may cause damage resulting in an extremely hazardous condition.

- If the code requires the gas lines to be tested at a pressure exceeding 14" W.C., the water heater and its manual shutoff valve must be **disconnected** from the gas supply piping system and the line capped.

FIGURE 16
GAS PIPING

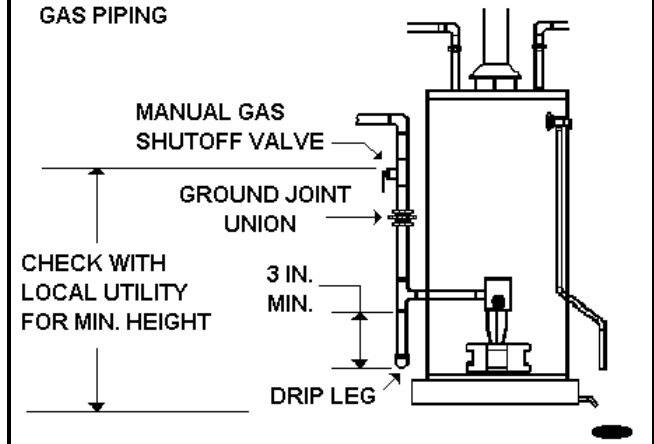

- If the gas lines are to be tested at a pressure less than 14" W.C. the water heater must be **isolated** from the gas supply piping system by closing its manual shutoff valve.

A U.L. RECOGNIZED FUEL GAS AND CO DETECTOR(S) ARE RECOMMENDED IN ALL APPLICATIONS AND THEIR INSTALLATION SHOULD BE IN ACCORDANCE WITH THE MANUFACTURER'S RECOMMENDATIONS AND/OR LOCAL LAWS, RULES, REGULATIONS, OR CUSTOMS.

INSTALLATION CHECKLIST

WATER HEATER LOCATION

- Centrally located with the water piping system. Located close to the gas piping and vent pipe system as possible.
- Located indoors and in a vertical position. Protected from freezing temperatures.
- Proper clearances from combustible surfaces maintained and not installed directly on a carpeted floor.
- Provisions made to protect the area from water damage. Drain pan installed and piped to an adequate drain
- Installation area free of corrosive elements and flammable materials.
- Sufficient room to service the water heater.
- Water heater not located near an air moving device.

VENTILATION AND COMBUSTION AIR SUPPLY

- Sufficient fresh air supply for proper water heater operation.
- Fresh air not taken from areas that contain negative pressure producing devices.
- Fresh air supply free of corrosive elements and flammable vapors.
- Fresh air openings sized correctly with consideration given to the blocking effect of louvers and grilles.
- Ductwork is the same cross-sectional area as the openings.

VENT PIPE SYSTEM

- Draft hood properly installed.

- Vent connectors securely fastened with screws and supported properly to maintain 6 inch clearance.
- Vent connector made of approved material and sized correctly.
- Vent pipe system in accordance with "National Fuel Gas Code", NFPA 54, ANSI Z223.1-Latest Edition or prevailing provisions of local codes.
- Flue baffle engaged in slots provided in the flue tube.
- Flue way, draft hood or vent pipe system not obstructed in any way.

WATER SYSTEM PIPING

- Temperature and pressure relief valve properly installed with a discharge line run to an open drain and protected from freezing.
- All piping properly installed and free of leaks.
- Heater completely filled with water.
- Closed system pressure build-up precautions installed.
- Tempering valve installed per manufacturer's instructions

GAS SUPPLY AND PIPING

- Gas supply is the same type as listed on the water heater data plate.
- Gas line equipped with shut-off valve, union and drip leg.
- Approved pipe joint compound used.
- Adequate pipe size and of approved material.
- Chloride-free soap and water solution or other approved means used to check all connections and fittings for possible gas leaks.

START-UP/OPERATION

WARNING

IF YOU DO NOT FOLLOW THESE INSTRUCTIONS EXACTLY, A FIRE OR EXPLOSION MAY RESULT CAUSING PROPERTY DAMAGE, PERSONAL INJURY OR LOSS OF LIFE.

Read these directions thoroughly before attempting to light or relight the pilot. **Make sure the tank is completely filled with water before lighting the pilot.** Check the data plate near the gas valve control/thermostat for the correct gas. Do not use this water heater with any gas other than the one listed on the data plate. If you have any questions or doubts consult your gas supplier or gas utility company.

DO NOT:

- Operate the water heater if it has been subjected to physical damage, flooding, or fire.
- Operate the water heater unless the tank is filled with water.
- Operate the water heater if the cold water supply inlet valve is closed.
- Allow flammable liquids such as gasoline or paint thinner to be stored or used near this water heater.
- Allow combustible materials such as newspapers, rags or mops to accumulate near this water heater.
- Light this water heater until all lighting instructions are understood and followed. Lighting instructions are clearly given in this manual and on the water heater label.
- Light this water heater if you smell gas around the appliance area.

IF YOU SMELL GAS:

1. Open the windows.
2. Get all people out of the building.
3. Do not light matches or any other appliance. Do not smoke.
4. Do not touch any electrical switches (on or off) or use any phones in your residence.
5. Extinguish any open flames immediately.
6. Shut off the gas at the manual shut-off valve. (If using liquid propane gas, shut off the gas at the L.P. tank outside of your residence.)
7. Use an outside phone and immediately call the gas company and the fire department. Give your name and address and ask for instructions.
8. Do not go back into the building. Wait for help to arrive outside of the building.

L.P.G. (BOTTLED PROPANE) MODELS

Liquefied Petroleum Gas is over 50% heavier than air and in the occurrence of a leak in the system the gas will settle at FLOOR LEVEL. Basements, crawl spaces, skirted areas under mobile homes (even when ventilated), closets and areas below ground level will serve as pockets for the accumulation of gas. **Before lighting an L.P. gas water heater, smell all around the appliance at floor level.** If you smell gas, follow the directions as given on this page.

When your L.P. tank runs out of fuel, turn off the gas at all gas appliances including pilot lights. After the tank is refilled, all appliances must be re-lit according to their manufacturer's instructions.

WATER EXPOSURE

Do not try to light this water heater if the gas controls, main burner, or pilot have been exposed to water in any way. Immediately call a qualified service technician to inspect the water heater and replace any part of the gas control system that has been exposed to water. **DO NOT** attempt to repair these parts. Water heaters subjected to flood conditions or any time the main burner, gas controls or pilot have been submerged in water require replacement of the entire water heater.

LIGHTING THE WATER HEATER

Check the Gas Control Valve/Thermostat and determine which model is being used for your water heater. Refer to either Figure 17A, 17B, 17C, or 17D and light the water heater according to its directions.

WARNING

DO NOT ATTEMPT TO LIGHT THIS WATER HEATER UNTIL IT IS PROPERLY INSTALLED AND YOU UNDERSTAND ALL OF THE SAFETY WARNINGS AND PRECAUTIONS.

CHECKING THE DRAFT

After successfully lighting the water heater, allow the unit to operate for 15 minutes and check the draft hood relief opening for proper draft. Pass a match flame around the relief opening of the draft hood. A steady flame drawn into the opening indicates proper draft. If the flame flutters or is blown out, combustion products are escaping from the relief opening. If this occurs, do not operate the water heater until proper adjustments or repairs are made to the vent pipe system.

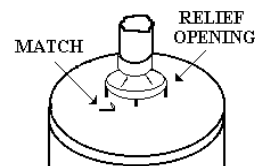

BURNER FLAMES

Inspect the burner flames and compare them to the drawings in Figure 18. A properly operating burner should produce a soft blue flame. Blue tips with yellow inner cones are satisfactory. The tips of the flame may have a slight yellow tint. The flame should not be all yellow or have a sharp blue-orange color. Contaminated air may cause an orange colored flame. A main burner adjustment is provided for L.P. gas water heaters only. This is a primary air controlling device and is located at the end of the burner venturi. (See Figure 19). Loosen the screw and open the device to sharpen the flame. Close the device to soften the flame. Retighten the screw after adjusting the flame. Natural gas models do not have a field adjustment. Contact a qualified service technician if the flame is not satisfactory.

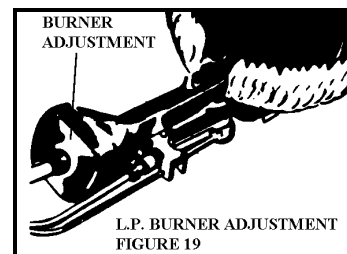
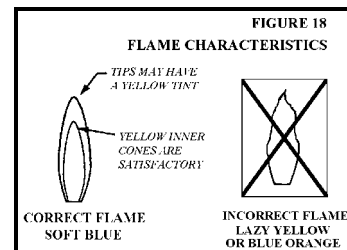

WATER TEMPERATURE REGULATION

The thermostat is adjusted to its lowest temperature when it is shipped from the factory. Water temperature can be regulated by moving the temperature dial to the preferred setting. **The preferred starting point is 120°F.** Align the index bar on the thermostat with the desired water temperature as shown in Figures 20 and 21, page 19. **There is a hot water scald potential if the thermostat is set too high.**

DANGER

ADJUSTING THE THERMOSTAT PAST THE 120°F BAR ON THE TEMPERATURE DIAL WILL INCREASE THE RISK OF SCALD INJURY.

During low demand periods when hot water is not being used, a lower thermostat setting will reduce energy losses and may satisfy your normal hot water needs. If hot water use is expected to be more than normal, a higher thermostat setting may be required to meet the increased demand.

When leaving your home for extended periods (vacations, etc.) turn the temperature dial to its lowest setting. This will maintain the water at low temperatures with minimum energy losses and prevent the tank from freezing during cold weather.

FIGURE 17A : LIGHTING INSTRUCTIONS (ROBERTSHAW THERMOSTAT)

FOR YOUR SAFETY READ BEFORE LIGHTING

⚠ WARNING

If you do not follow these directions exactly, a fire or explosion may result causing property damage, personal injury or loss of life.

- A. This appliance has a pilot which must be lighted by hand. When lighting the pilot, follow these instructions exactly.
- B. **BEFORE LIGHTING** smell all around the appliance area for gas. Be sure to smell next to the floor because some gas is heavier than air and will settle on the floor.
- WHAT TO DO IF YOU SMELL GAS:
 - Do not try to light any appliance.
 - Do not touch any electrical switch; do not use any phone in your building.
 - Immediately call your gas supplier from a neighbor's phone. Follow the gas supplier's instructions.
- If you cannot reach your gas supplier, call the fire department.
- C. Use only your hand to push in or turn the gas control knob. Never use tools. If the knob will not push in or move by hand, don't try to repair it, call a qualified service technician. Force or attempted repair may result in a fire or explosion.
- D. Do not use this appliance if any part has been under water. Immediately call a qualified service technician to inspect the appliance. Water heaters subjected to flood conditions or anytime the gas controls, main burner or pilot have been submerged in water require replacement of the entire water heater.

LIGHTING INSTRUCTIONS

1. **STOP!** It is imperative that you read all the safety warnings before lighting the pilot.
2. Remove outer and inner doors.
3. Turn the temperature dial counterclockwise ↶ to its lowest setting.

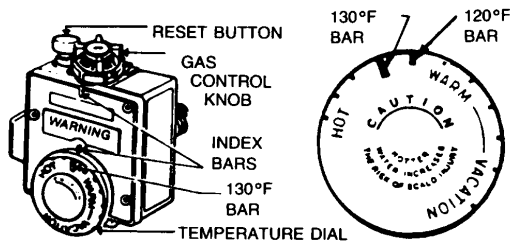

4. Turn gas control knob clockwise ↷ to the "OFF" position.
5. To clear any gas that may have accumulated wait ten (10) minutes. If you then smell gas, **STOP!** Follow "B" in the safety warning above. If you do not smell gas go to the next step.

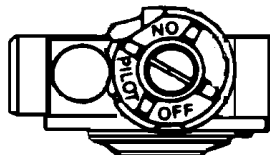

6. Find pilot - follow the smaller metal tube from the thermostat to the pilot.
7. Turn the gas control knob counterclockwise ↶ to "PILOT".

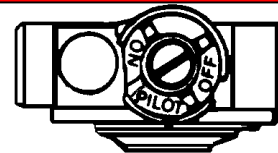

8. Light match and hold to pilot. Depress the reset button all the way in; hold until pilot lights. Repeat immediately if pilot does not light on the first try. Continue to hold the button for about (1) minute after the pilot is lit. Release the reset button and it will pop back up. Pilot should remain lit. If the pilot light goes out, repeat steps 3 - 8.

IMPORTANT: If the pilot will not stay lit after several tries, turn gas control knob to "OFF" and call your service technician or gas supplier.

IMPORTANT: If the reset button does not pop up when released, stop and immediately shut off the gas at the line valve or tank. Call your service technician or gas supplier.

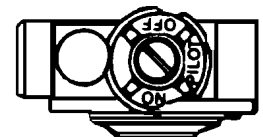

9. Replace the inner door.
10. Turn the gas control knob counterclockwise ↶ to "ON".
11. Set the temperature dial to the desired setting.
12. Replace the outer door.

TO TURN OFF GAS TO APPLIANCE

1. Turn the temperature dial counterclockwise ↶ to its lowest setting.
2. Turn the gas control knob clockwise ↷ to the "OFF" position.

FIGURE 17B : LIGHTING INSTRUCTIONS (WHITE-RODGERS THERMOSTAT)

FOR YOUR SAFETY READ BEFORE LIGHTING

WARNING

If you do not follow these directions exactly, a fire or explosion may result causing property damage, personal injury or loss of life.

- A. This appliance has a pilot which must be lighted by a hand. When lighting the pilot, follow these instructions exactly.
B. BEFORE LIGHTING smell all around the appliance area for gas. Be sure to smell next to the floor because some gas is heavier than air and will settle on the floor.
WHAT TO DO IF YOU SMELL GAS:
- Do not try to light any appliance.
- Do not touch any electrical switch; do not use any phone in your building.
- Immediately call your gas supplier from a neighbor's phone. Follow the gas supplier's instructions.
C. Use only your hand to push in or turn the gas control knob. Never use tools. If the knob will not push in or move by hand, don't try to repair it, call a qualified service technician. Force or attempted repair may result in a fire or explosion.
D. Do not use this appliance if any part has been under water. Immediately call a qualified service technician to inspect the appliance. Water heaters subjected to flood conditions or any time the gas controls, main burner or pilot have been submerged in water require replacement of the entire water heater.

LIGHTING INSTRUCTIONS

- 1. STOP! It is imperative that you read all the safety warnings before lighting the pilot.
2. Remove outer and inner doors.
3. Set the thermostat to its lowest setting. (Rotate clockwise).
4. Depress the gas control knob slightly and turn clockwise to "OFF". If the knob is "ON", turn it clockwise to "PILOT" then depress the knob slightly and turn

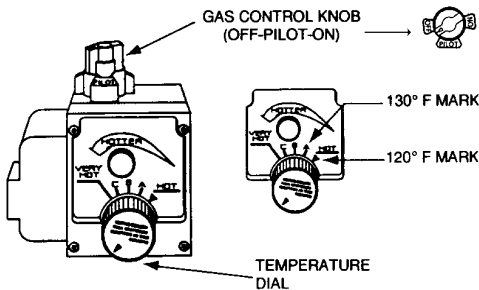

clockwise to "OFF".

NOTE: Knob cannot be turned from "PILOT" to "OFF" unless knob is depressed slightly. Do not use tools or excessive force.

- 5. To clear any gas that may have accumulated wait ten (10) minutes. If you then smell gas, STOP! Follow "B" in the safety warning above. If you do not smell gas go to the next step.

- 6. Find the pilot - Follow the smaller metal tube from thermostat to the pilot.

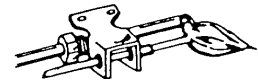

- 7. Turn the gas control knob counterclockwise to "PILOT".
8. Light the match and hold to the pilot. Depress the control knob all the way; hold until pilot lights. Continue to hold the control knob down for about (1) minute after the pilot is lit. Release knob and it will pop back up. Pilot should remain lit. If the pilot light goes out, repeat steps 3 -8.

IMPORTANT: If the pilot will not stay lit after several tries, turn gas control knob to "OFF" and call your service technician or gas supplier.

IMPORTANT: If the knob does not pop up when released, turn the knob to "OFF", stop and immediately call your service technician or gas supplier.

- 9. Replace the inner door.
10. Turn the gas control knob counterclockwise to "ON".
11. Set the temperature dial to the desired setting.
12. Replace the outer door.

TO TURN OFF THE GAS TO APPLIANCE

- 1. Set the thermostat to its lowest setting.
2. Turn gas control knob clockwise to "PILOT".
3. Depress the gas control knob slightly and turn clockwise to "OFF". Do not use tools or force.

FIGURE 17C : LIGHTING INSTRUCTIONS-PIEZOELECTRIC IGNITER (ROBERTSHAW THERMOSTAT)

FOR YOUR SAFETY READ BEFORE LIGHTING

⚠ WARNING

If you do not follow these instructions exactly, a fire or explosion may result causing property damage, personal injury or loss of life.

- A. This appliance has a pilot which is lighted by a piezoelectric igniter. When lighting the pilot, follow these instructions exactly.
- B. **BEFORE LIGHTING** smell all around the appliance area for gas. Be sure to smell next to the floor because some gas is heavier than air and will settle on the floor.
- WHAT TO DO IF YOU SMELL GAS:**
 - Do not try to light any appliance.
 - Do not touch any electrical switch; do not use any phone in your building.
 - Immediately call your gas supplier from a neighbor's phone. Follow the gas supplier's instructions.
 - If you cannot reach your gas supplier, call the fire department.
- C. Use only your hand to push in or turn the gas control knob. Never use tools. If the knob will not push in or move by hand, don't try to repair it, call a qualified service technician. Force or attempted repair may result in a fire or explosion.
- D. Do not use this appliance if any part has been under water. Immediately call a qualified service technician to inspect the appliance. Water heaters subjected to flood conditions or anytime the gas controls, main burner or pilot have been submerged in water require replacement of the entire water heater.

LIGHTING INSTRUCTIONS

1. **STOP!** It is imperative that you read all the safety warnings before lighting the pilot.
2. Remove outer and inner doors.

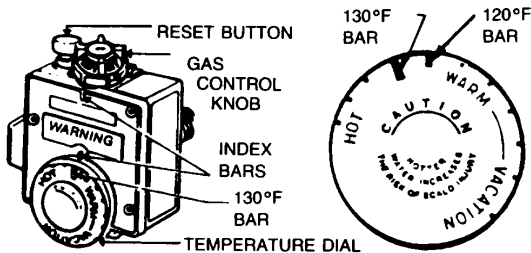

3. Turn the temperature dial counterclockwise ↶ to its lowest setting.

4. Turn gas control knob clockwise ↷ to the "OFF" position.

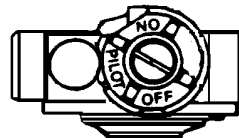

5. To clear any gas that may have accumulated wait ten (10) minutes. If you then smell gas, **STOP!** Follow "B" in the safety warning above. If you do not smell gas go to the next step.

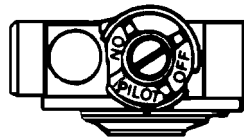

6. Turn the gas control knob counterclockwise ↶ to "PILOT".

7. Depress the reset button all the way in and **IMMEDIATELY** depress the igniter until you hear a loud click. Repeat immediately if pilot does not light on the first try. If the pilot does not light by the fourth attempt with the igniter, repeat steps 4 - 7. Continue to hold the button for about (1) minute after the pilot is lit. Release the reset button and it will pop back up. Pilot should remain lit. If the pilot light goes out, repeat steps 3 - 7.

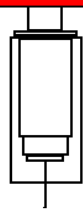

IMPORTANT: If the pilot will not stay lit after several tries, turn gas control knob to "OFF" and call your service technician or gas supplier.

IMPORTANT: If the reset button does not pop up when released, stop and immediately shut off the gas at the line valve or tank. Call your service technician or gas supplier.

8. Replace the inner door.
9. Turn the gas control knob counterclockwise ↶ to "ON".
10. Set the temperature dial to the desired setting.

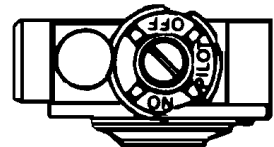

11. Replace the outer door.

TO TURN OFF GAS TO APPLIANCE

1. Turn the temperature dial counterclockwise ↶ to its lowest setting.
2. Turn the gas control knob clockwise ↷ to the "OFF" position.

FIGURE 17D : LIGHTING INSTRUCTIONS WITH PIEZOELECTRIC IGNITER (WHITE-RODGERS THERMOSTAT)

FOR YOUR SAFETY READ BEFORE LIGHTING

⚠ WARNING

If you do not follow these directions exactly, a fire or explosion may result causing property damage, personal injury or loss of life.

- A. This appliance has a pilot which is lighted by a piezoelectric igniter. When lighting the pilot, follow these instructions exactly.
- B. **BEFORE LIGHTING** smell all around the appliance area for gas. Be sure to smell next to the floor because some gas is heavier than air and will settle on the floor.
- WHAT TO DO IF YOU SMELL GAS:**
- Do not try to light any appliance.
 - Do not touch any electrical switch; do not use any phone in your building.
 - Immediately call your gas supplier from a neighbor's phone. Follow the gas supplier's instructions.
- C. If you cannot reach your gas supplier, call the fire department.
- C. Use only your hand to push in or turn the gas control knob. Never use tools. If the knob will not push in or move by hand, don't try to repair it, call a qualified service technician. Force or attempted repair may result in a fire or explosion.
- D. Do not use this appliance if any part has been under water. Immediately call a qualified service technician to inspect the appliance. Water heaters subjected to flood conditions or any time the gas controls, main burner or pilot have been submerged in water require replacement of the entire water heater.

LIGHTING INSTRUCTIONS

1. **STOP!** It is imperative that you read all the safety warnings before lighting the pilot.
2. Remove outer and inner doors.
3. Set the thermostat to its lowest setting. (Rotate clockwise ↻).
4. Depress the gas control knob slightly and turn clockwise ↻ to "OFF". If the knob is "ON", turn it clockwise ↻ to "PILOT" then depress the knob slightly and turn clockwise ↻ to "OFF".

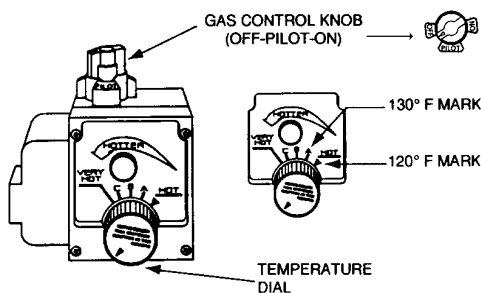

NOTE: Knob cannot be turned from "PILOT" to "OFF" unless knob is depressed slightly. Do not use tools or excessive force.

5. To clear any gas that may have accumulated wait ten (10) minutes. If you then smell gas, **STOP!** Follow "B" in the safety warning above. If you do not smell gas go to the next step.

6. Turn the gas control knob counterclockwise ↺ to "PILOT".
7. Depress the control knob all the way in and **IMMEDIATELY** depress the igniter until you hear a loud click. Repeat immediately if the pilot does not light on the first try. If the pilot does not light by the fourth attempt with the igniter repeat steps 4-7. Continue to hold the control knob down for about (1) minute after the pilot is lit. Release knob and it will pop back up. Pilot should remain lit. If the pilot light goes out, repeat steps 3-7.

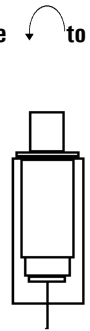

IMPORTANT: If the pilot will not stay lit after several tries, turn gas control knob to "OFF" and call your service technician or gas supplier.

IMPORTANT: If the knob does not pop up when released, turn the knob to "OFF", stop and immediately call your service technician or gas supplier.

8. Replace the inner door.
9. Turn the gas control knob counterclockwise ↺ to "ON".
10. Set the temperature dial to the desired setting.
11. Replace the outer door.

TO TURN OFF THE GAS TO APPLIANCE

1. Set the thermostat to its lowest setting.
2. Turn gas control knob clockwise ↻ to "PILOT".
3. Depress the gas control knob slightly and turn clockwise ↻ to "OFF". Do not use tools or force.

FOR YOUR SAFETY READ BEFORE LIGHTING

WARNING

If you do not follow these directions exactly, a fire or explosion may result causing property damage, personal injury or loss of life.

- A. This appliance has a pilot which must be lighted by hand. When lighting the pilot, follow these instructions exactly.
- B. **BEFORE LIGHTING** smell all around the appliance area for gas. Be sure to smell next to the floor because some gas is heavier than air and will settle on the floor.

WHAT TO DO IF YOU SMELL GAS:

- Do not try to light any appliance.
- Do not touch any electrical switch; do not use any phone in your building.
- Immediately call your gas supplier from a neighbor's phone. Follow the gas supplier's instructions.

- If you cannot reach your gas supplier, call the fire department.
- C. Use only your hand to push in or turn the gas control knob. Never use tools. If the knob will not push in or move by hand, don't try to repair it, call a qualified service technician. Force or attempted repair may result in a fire or explosion.
- D. Do not use this appliance if any part has been under water. Immediately call a qualified service technician to inspect the appliance. Water heaters subjected to flood conditions or anytime the gas controls, main burner or pilot have been submerged in water require replacement of the entire water heater.

LIGHTING INSTRUCTIONS

1. **STOP!** It is imperative that you read all the safety warnings before lighting the pilot.
2. Remove outer and inner doors.
3. Turn the temperature dial counterclockwise  to its lowest setting.

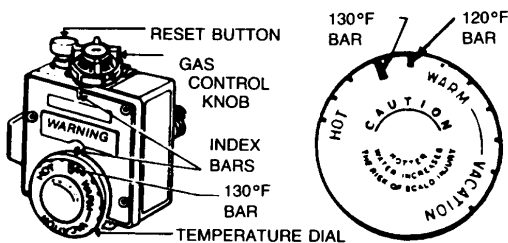

4. Turn gas control knob clockwise  to the "OFF" position.

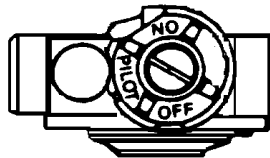

5. To clear any gas that may have accumulated wait ten (10) minutes. If you then smell gas, **STOP!** Follow "B" in the safety warning above. If you do not smell gas go to the next step.



6. Find pilot - follow the smaller metal tube from the thermostat to the pilot.

7. Turn the gas control knob counterclockwise  to "PILOT".

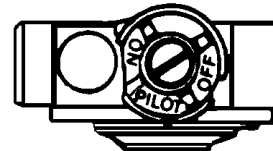

8. Light match and hold to pilot. Depress the reset button all the way in; hold until pilot lights. Repeat immediately if pilot does not light on the first try. Continue to hold the button for about (1) minute after the pilot is lit. Release the reset button and it will pop back up. Pilot should remain lit. If the pilot light goes out, repeat steps 3 - 8.

IMPORTANT: If the pilot will not stay lit after several tries, turn gas control knob to "OFF" and call your service technician or gas supplier.

IMPORTANT: If the reset button does not pop up when released, stop and immediately shut off the gas at the line valve or tank. Call your service technician or gas supplier.

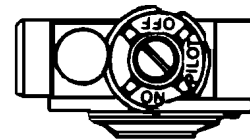

9. Replace the inner door.

10. Turn the gas control knob counterclockwise  to "ON".



11. Set the temperature dial to the desired setting.
12. Replace the outer door.

TO TURN OFF GAS TO APPLIANCE

1. Turn the temperature dial counterclockwise  to its lowest setting.
2. Turn the gas control knob clockwise  to the "OFF" position.

START-UP/OPERATION (CONT.)

! DANGER

HOT WATER CAN PRODUCE FIRST DEGREE BURNS WITHIN:

- 3 SECONDS AT 140°F (60°C)**
- 20 SECONDS AT 130°F (54°C)**
- 8 MINUTES AT 120°F (49°C)**

! WARNING

HOUSEHOLDS WITH SMALL CHILDREN, ELDERLY, IMPAIRED OR DISABLED MEMBERS AND ANYONE WITH TEMPERATURE SENSITIVE SKIN MAY REQUIRE A LOWER TEMPERATURE SETTING TO REDUCE THE RISK OF SCALD INJURY.

STACKING

Stacking occurs when consecutive short draws of hot water (3 gallons or less) are taken from the water heater tank. This causes increased cycling of the burner and can result in increased water temperatures at the hot water outlet. Always install an anti-scald device in the hot water supply line to reduce the risk of scald injury.

EMERGENCY SHUT DOWN

IMPORTANT: Should overheating occur or the gas supply fail to shut off, turn off the water heater's manual gas control valve and call a qualified service technician.

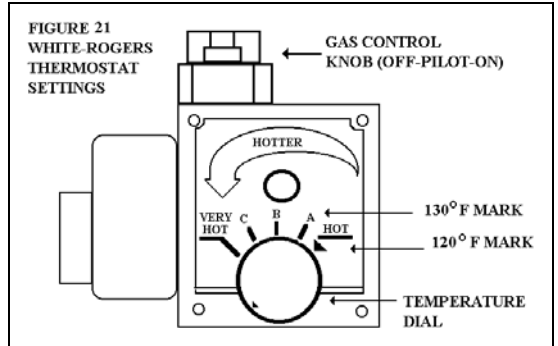
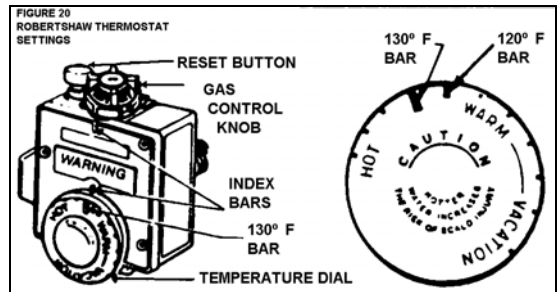

OPERATIONAL CONDITIONS

CONDENSATION

Moisture from the products of combustion condenses on the tank surface and the outside jacket of the water heater and forms drops of water which may fall onto the burner or other hot surfaces. This will produce a "sizzling" or "frying" noise. **This condensation is normal and should not be confused with a leaking tank.** Condensation may increase or decrease at different times of the year.

High efficient Energy Saver water heaters will produce larger amounts of condensation on initial light up or when a large amount of hot water is being used. **Do not confuse this with a "tank leak".** Once the water reaches a temperature of 120°F and the tank warms up (usually 1-2 hours), the condensation will stop.

Operating the water heater at the lowest thermostat setting may increase the amount of condensation. Adjusting the thermostat slightly higher may eliminate this problem.

IMPORTANT: It is always recommended that a suitable drain pan be installed under the water heater to protect the area from water damage resulting from normal condensation production or a leaking tank or piping connections (See page 6, "Location Requirements and Considerations"). Under no circumstances is the manufacturer to be held responsible for any water damage in connection with this water heater.

WATER HEATER SOUNDS

During the normal operation of the water heater, sounds or noises may be heard. These noises are common and may result from the following:

1. Normal expansion and contraction of metal parts during periods of heat-up and cool-down .
2. Condensation causes sizzling and popping within the burner area and should be considered normal.
3. Sediment build-up in the tank bottom will create varying amounts of noise and may cause premature tank failure. Drain and flush the tank as directed under "Draining and Flushing".

SMOKE/ODOR

The water heater may give off a small amount of smoke and odor during the initial start-up of the unit. This is due to the burning off of oil from the metal parts of a new unit and will disappear after a few minutes of operation.

SAFETY SHUT-OFF

This water heater is designed to automatically shut-off in the event of the following:

1. The pilot flame is extinguished for any reason.
2. The water temperature exceeds 180°F (83°C).

A flame-sensing thermocouple is used to determine if a pilot flame is present and will immediately shut off the gas supply to the main burner and the pilot burner if the flame is absent.

A high temperature limit switch or ECO (Energy Cut Off) is used to shut off the unit if the water temperature exceeds 180°F (83°C). The ECO is a single use switch and requires complete replacement of the entire thermostat. If the ECO should function, the water heater cannot be used until the thermostat is replaced by a qualified service agency. Contact your local dealer for service information.

! DANGER

DO NOT ATTEMPT TO BY-PASS OR JUMPER THE ECO AS THIS CAN RESULT IN PROPERTY DAMAGE, BODILY INJURY OR DEATH. THIS WILL VOID THE WARRANTY AND RELEASE THE MANUFACTURER FROM ANY LIABILITY FOR ANY INCIDENT RESULTING FROM ELIMINATING THE ECO FROM THE WATER HEATER CIRCUIT.

WATER ODOR

Each water heater contains at least one anode rod which will slowly dissipate while protecting the tank from corrosion. Certain water conditions will cause a reaction between this rod and the water. The most common complaint associated with the anode rod is one of a "rotten egg smell" produced from the presence of hydrogen sulfide gas dissolved in the water. **Do not remove this rod as it will void any warranties, stated or implied.** The parts list includes a special anode that can be ordered if water odor or discoloration occurs. This rod may reduce but not eliminate water odor problems. The water supply system may require special filtration equipment from a water conditioning company to successfully eliminate all water odor problems.

HYDROGEN GAS BUILD-UP

! DANGER

HYDROGEN GAS CAN BE PRODUCED IN A HOT WATER SYSTEM THAT HAS NOT BEEN USED FOR A LONG PERIOD OF TIME (GENERALLY TWO WEEKS OR MORE). HYDROGEN GAS IS EXTREMELY FLAMMABLE AND CAN IGNITE WHEN EXPOSED TO A SPARK OR FLAME. TO PREVENT THE POSSIBILITY OF INJURY UNDER THESE CONDITIONS, WE RECOMMEND THE HOT WATER FAUCET BE OPENED FOR SEVERAL MINUTES AT THE KITCHEN SINK BEFORE USING ANY ELECTRICAL APPLIANCE WHICH IS CONNECTED TO THE HOT WATER SYSTEM. IF HYDROGEN IS PRESENT, THERE WILL PROBABLY BE AN UNUSUAL SOUND SUCH AS AIR ESCAPING THROUGH

THE FAUCET AS WATER BEGINS TO FLOW. DO NOT SMOKE OR HAVE ANY

OPEN FLAME NEAR THE FAUCET AT THE TIME IT IS OPEN.

DRAINING AND FLUSHING

The water heater should be drained if being shut down during freezing temperatures. It is recommended that the tank be drained, flushed and cleaned every 6 months to remove sediment which may build-up during operation.

To drain the tank perform the following steps:

1. Turn off the gas to the water heater at the Manual Gas Shutoff Valve.
2. Close the cold water inlet valve.
3. Open a nearby hot water faucet.
4. Connect a hose to the drain valve and terminate it to an adequate drain. Open the water heater drain valve and allow all the water to drain from the tank.
5. Flush the tank with water as needed to remove sediment.
6. Close the drain valve, refill the tank, and restart the heater as directed under "Start-Up/Operation".

If the water heater is going to be shut down for an extended period, the drain valve should be left open.

IMPORTANT: Condensation may occur when refilling the tank and should not be confused with a tank leak.

DANGER

WATER DRAINING FROM THIS HEATER MAY BE HOT AND CAN RESULT IN A SCALD INJURY. DO NOT ALLOW ANYONE TO COME IN CONTACT WITH THE DRAINING WATER AND TERMINATE THE DRAIN HOSE TO AN ADEQUATE DRAIN.

3 MONTH INSPECTION

At least every 3 months a visual inspection should be made of the venting and air supply system, piping systems, main burner and pilot burner. Check the water heater for the following:

- Obstructions, damage, or deterioration in the venting system. Make sure the ventilation and combustion air supplies are not obstructed.
- Build-up of soot and carbon on the main burner and pilot burner. Check for a soft blue flame.
- Leaking or damaged water and gas piping.
- Presence of flammable or corrosive materials in the installation area.

WARNING

OBSTRUCTIONS OR HOLES IN THE VENT PIPE CAN CAUSE TOXIC FUMES TO ENTER THE HOME RESULTING IN CARBON MONOXIDE POISONING OR DEATH. THE VENT PIPE MUST BE REPLACED IF IT IS LEAKING.

A U.L. RECOGNIZED FUEL GAS AND CO DETECTOR(S) ARE RECOMMENDED IN ALL APPLICATIONS AND THEIR INSTALLATION SHOULD BE IN ACCORDANCE WITH THE MANUFACTURER'S RECOMMENDATIONS AND/OR LOCAL LAWS, RULES, REGULATIONS, OR CUSTOMS.

IMPORTANT: VERIFY PROPER OPERATION AFTER SERVICING THIS WATER HEATER.

REPLACEMENT PARTS

Replacement parts may be ordered through your plumber or the local distributor. Parts will be shipped at prevailing prices and billed accordingly. When ordering replacement parts, always have the following information ready:

1. Model, serial and product number.
2. Type of gas.
3. Item number.
4. Parts Description.

See page 24 for a list of available repair parts.

TROUBLESHOOTING

WATER HEATER SERVICE MUST ONLY BE PERFORMED BY A QUALIFIED SERVICE TECHNICIAN. Refer to the Troubleshooting Chart on pages 22 and 23 for determining the cause of water heater problems.

SELF-CLEANING (SOME MODELS)

Some water heaters may include a self-cleaning device that inhibits the build-up of lime and other sediment on the metal surfaces of the water heater. As cold water passes through the dip tube, lime-causing particles and minerals are suspended automatically. This controls sediment and lime build-up within the tank and results in higher efficiencies and lower operation costs.

REMOVING THE BURNER ASSEMBLY

WARNING

REMOVAL AND REPLACEMENT OF THE BURNER ASSEMBLY INVOLVES THE DISCONNECTION OF THE MANIFOLD TUBE, PILOT TUBE, AND THERMOCOUPLE FROM THE THERMOSTAT AND LEAK TESTING. THE FOLLOWING PROCEDURES MUST ONLY BE PERFORMED BY A QUALIFIED SERVICE TECHNICIAN.

1. Turn the gas control knob on the combination gas control valve/thermostat clockwise to the "OFF" position.
2. Remove the outer and inner doors.
3. Disconnect the thermocouple, pilot tube, and manifold tube at the thermostat (Figure 22). Note that L.P. gas systems use reverse (left-handed) threads on the manifold tube.
4. Grasp the manifold tube and push down slightly to free the manifold, pilot tube and thermocouple. Tilt the burner to one side and remove it from the burner compartment (Figure 23).
5. Check the burner to see if it is dirty or clogged. The burner may be cleaned with soap and hot water. If a sooty condition exists, refer to the Troubleshooting Chart, "Smoking and Carbon Formation".

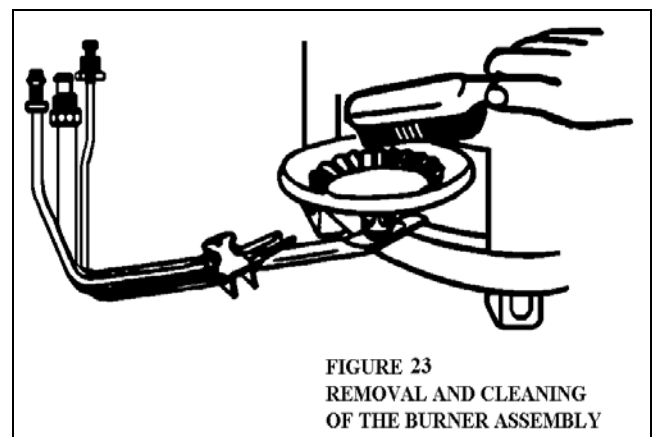
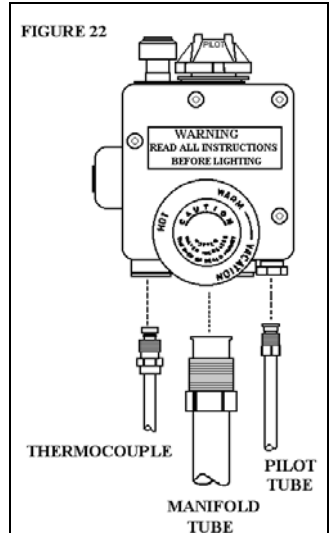

**FIGURE 23
REMOVAL AND CLEANING
OF THE BURNER ASSEMBLY**

BURNER ASSEMBLY REMOVAL, CLEANING, AND REPLACEMENT

REPLACING THE BURNER ASSEMBLY

1. Insert the burner into the burner compartment making sure that the manifold tab engages with the bracket inside the burner compartment (Figure 24). The tab is located at the bottom of the burner for L.P. models. The manifold tube will now line up with the thermostat connection.
2. Reconnect the manifold tube and pilot tube. Do not cross thread these fittings. L.P. gas systems use reverse (left-handed) threads on the manifold tube. Do not apply any thread sealant (pipe dope, Teflon tape, etc.) to these connections.
3. Reconnect the thermocouple. The thermocouple nut should be started and turned all the way in by hand. An additional quarter turn with a 3/8" open end wrench will then be sufficient to seat the lockwasher.

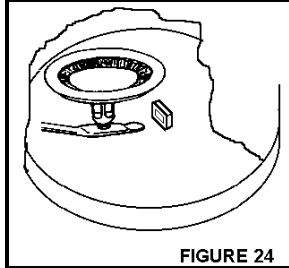

FIGURE 24

IMPORTANT: Overtightening may damage the thermocouple or the thermostat.

4. Relight the water heater according to the lighting instructions.
5. Check for gas leaks with a chloride-free soap and water solution or other approved method. **FIX ALL LEAKS IMMEDIATELY.**

⚠ DANGER

DO NOT USE AN OPEN FLAME OR ANY KIND OF SPARK TO CHECK GAS PIPING FOR LEAKS. IF LEAKING GAS IS PRESENT, AN EXPLOSION OR FIRE MAY RESULT CAUSING PROPERTY DAMAGE, PERSONAL INJURY OR DEATH.

NOTE: The burner assembly shown in Figures 23, 24, and 25 is typical for Natural Gas models. LPG models and models equipped with Low Nox burners will vary in appearance.

THERMOCOUPLE AND / OR PILOT ASSEMBLY REPLACEMENT

Reference Figures 25 and 26 for the following procedures.

1. Remove the burner assembly as directed in "Removing the Burner Assembly", page 20.

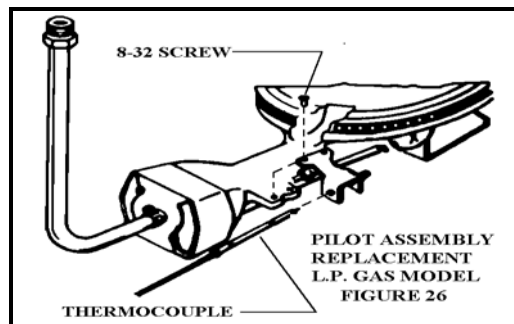
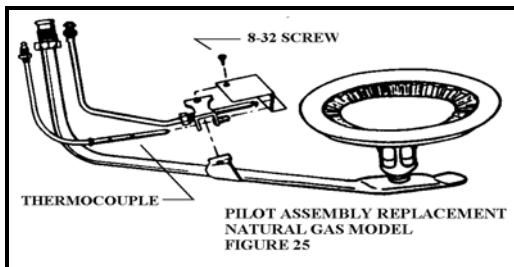

2. Grasp the thermocouple line and gently pull the thermocouple from the pilot assembly.
3. Push the replacement thermocouple through the hole in the pilot bracket until it snaps in place. The end of the thermocouple should extend approximately 1/4 inch past the tip of the pilot assembly.
4. Replace the burner assembly as directed above.

If the thermocouple will not disengage from the pilot assembly, the entire pilot assembly must be replaced:

1. Remove the No. 8-32 screw which holds the pilot assembly and pilot shield (if provided) to the main burner.
2. Install the replacement pilot assembly to the main burner making sure the pilot shield (if provided) is in the correct location.
3. Replace the burner assembly as directed above.

PIEZOELECTRIC IGNITER SYSTEM (SOME MODELS)

The piezoelectric igniter system consists of the igniter button, electrode and wire. Gas accumulating in the area surrounding the pilot is ignited by an electric spark generated when the igniter button is pressed. The spark gap of .125 inch is set at the factory. (See Figures below)

TESTING THE IGNITER SYSTEM

⚠ WARNING

IGNITER TESTING SHOULD ONLY BE PERFORMED BY A QUALIFIED SERVICE TECHNICIAN.

Turn off the gas to the water heater at the manual gas shut-off valve. Watch the electrode tip while activating the igniter. A visible spark should jump from the electrode. To avoid shock, do not touch the burner or any metal part on the pilot or pilot assembly. If no spark is visible, check the wire connections and make sure the electrode is not broken. Replace the igniter if defective.

Dirt and rust on the pilot or electrode tip can prevent the igniter spark. Wipe them with a damp cloth and dry completely. Rust can be removed from the electrode tip and metal surfaces by lightly sanding with an emery cloth or fine grain sandpaper.

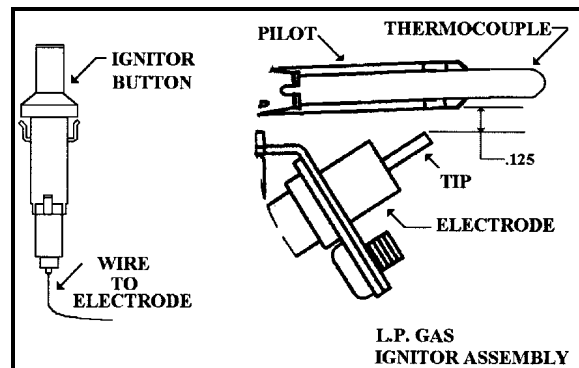
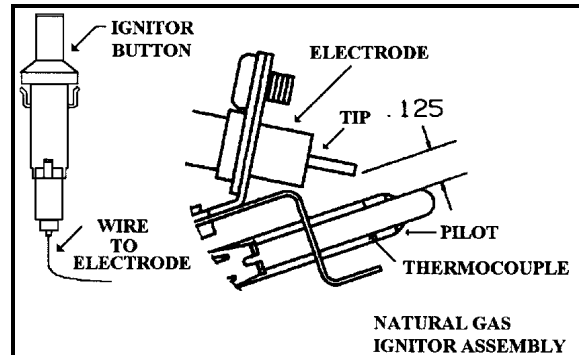

REMOVAL AND REPLACEMENT OF THE GAS CONTROL VALVE/ THERMOSTAT

⚠ WARNING

REMOVAL AND REPLACEMENT OF THE GAS CONTROL VALVE / THERMOSTAT INVOLVES THE DISCONNECTION OF GAS PIPING, MANIFOLD TUBE, PILOT TUBE, AND THERMOCOUPLE. IT IS RECOMMENDED THAT THIS PROCEDURE BE PERFORMED BY A QUALIFIED SERVICE TECHNICIAN.

1. On the gas control valve/thermostat turn the temperature dial counterclockwise to its lowest setting. Turn the gas control knob clockwise to the "OFF" position. See Figures 20 and 21 page 19.
2. Turn off the gas at the manual shutoff valve on the gas supply pipe. See Figure on page 15.
3. Drain the water heater. Refer to section "Draining and Flushing" on page 20 and follow procedure.
4. Disconnect the thermocouple, pilot tube, and manifold tube at the thermostat. See Figure 22 page 20. Note that L.P. gas systems use reverse (left-handed) threads on the manifold tube.
5. Refer to Gas Piping Figure 16 on page 15 and disconnect the ground joint union in the gas piping. Disconnect the remaining pipe from the gas valve/thermostat.
6. Turn the gas control valve/thermostat counterclockwise. Remove the gas control valve/thermostat.

⚠ CAUTION

WHEN REMOVING THE GAS CONTROL VALVE / THERMOSTAT DO NOT USE PIPE WRENCH OR VISE TO GRIP BODY OR ANY TYPE OF BLUNT INSTRUMENT INTO THE INLET OR OUTLET CONNECTIONS. USING THESE TYPE TOOLS MAY RESULT IN DAMAGE TO THE GAS CONTROL VALVE / THERMOSTAT.

To replace the gas control valve/ thermostat repeat the previous procedure in reverse order.

- Be sure to use Approved Teflon Tape or Pipe Joint Compound on the gas piping connections and fitting on the back of gas valve that screws into tank.
- Be sure to remove the pilot ferrule nut from the new gas control valve/ thermostat.
- Turn gas supply on and check for leaks. Use a chloride-free soap and water solution (bubbles forming indicate a leak) or other approved method. Do not use an open flame. **ALL LEAKS MUST BE FIXED IMMEDIATELY.**
- Be sure tank is completely filled with water before lighting and activating the water heater. Check the gas control valve/thermostat and determine which model is used for your water heater. Refer to corresponding Figure 17A - 17D and follow lighting procedure.
- If additional information is required, contact the Service Department at the 800 number shown on the front of this manual.

TROUBLESHOOTING CHART

PROBLEM	POSSIBLE CAUSE(S)	CORRECTIVE ACTION
BURNER WILL NOT IGNITE	<ol style="list-style-type: none"> 1. No gas 2. Dirt in the gas lines 3. Pilot line clogged 4. Main burner line clogged 5. Defective thermocouple 6. Defective thermostat 7. Thermostat set too low 8. Heater installed in a confined area 	<ol style="list-style-type: none"> 1. Check with gas utility company 2. Notify utility-install trap in gas line 3. Clean, locate source and correct 4. Clean, locate source and correct 5. Replace thermocouple 6. Replace thermostat 7. Turn temp. dial to desired temperature. 8. Provide fresh air ventilation
BURNER FLAME YELLOW-LAZY	<ol style="list-style-type: none"> 1. Insufficient secondary air 2. Low gas pressure 3. Flue clogged 4. Main burner line clogged 5. Heater installed in a confined area 6. Obstruction in main burner orifice 7. Main burner needs adjusting (L.P. only) 	<ol style="list-style-type: none"> 1. Provide ventilation to water heater 2. Check with gas utility company 3. Clean, locate source and correct 4. Clean, locate source and correct 5. Provide fresh air ventilation 6. Clean or replace orifice 7. See page 16, "Burner Flames" for flame adjustment.
PILOT WILL NOT LIGHT OR REMAIN LIT.	<ol style="list-style-type: none"> 1. Low gas pressure 2. Air in gas line 3. No gas 4. Dirt in gas lines 5. Pilot line or orifice clogged 6. Thermocouple connection loose 7. Defective thermocouple 8. Cold drafts 9. Thermostat ECO switch open 	<ol style="list-style-type: none"> 1. Check with gas utility company 2. Bleed the air from the gas line 3. Check with gas utility company 4. Notify utility-install dirt trap in gas line 5. Clean, locate source and correct 6. Finger tighten-then 1/4 turn with wrench 7. Replace thermocouple 8. Locate source and correct 9. Replace thermostat
HIGH OPERATION COSTS	<ol style="list-style-type: none"> 1. Improper Calibration 2. Thermostat set too high 3. Sediment or lime in tank 4. Heater too small for job 5. Wrong piping connections 6. Leaking faucets 7. Gas leaks 8. Wasted hot water 9. Long runs of exposed piping 10. Hot water piping in exposed wall 11. No flue baffle 	<ol style="list-style-type: none"> 1. Replace thermostat 2. Set temperature dial to lower setting. 3. Drain/Flush-Provide water treatment if needed 4. Install adequate heater 5. Correct piping-dip tube must be in cold inlet 6. Repair faucets 7. Check with utility-repair at once 8. Advise customer 9. Insulate piping 10. Insulate piping 11. Install flue baffle
PILOT FLAME TOO LARGE	<ol style="list-style-type: none"> 1. Wrong pilot burner 	<ol style="list-style-type: none"> 1. Replace with correct burner

TROUBLESHOOTING CHART

PROBLEM	POSSIBLE CAUSE(S)	CORRECTIVE ACTION
INSUFFICIENT HOT WATER	<ol style="list-style-type: none"> 1. Low gas pressure 2. Orifice too small 3. Improper calibration 4. Thermostat set too low 5. Sediment or lime in tank 6. Water heater too small 7. Wrong piping connections 8. Leaking faucets 9. Wasted hot water 10. Long runs of exposed piping 11. Hot water piping in outside wall 	<ol style="list-style-type: none"> 1. Check with gas utility company 2. Replace with correct orifice 3. Replace thermostat 4. Turn temperature dial to lower setting 5. Drain/flush-provide water treatment if needed 6. Install adequate heater 7. Correct piping-dip tube must be in cold inlet 8. Repair faucets 9. Advise customer 10. Insulate piping 11. Insulate piping
SLOW HOT WATER RECOVERY	<ol style="list-style-type: none"> 1. Insufficient secondary air 2. Flue clogged 3. Low gas pressure 4. Orifice too small 5. Improper calibration 6. Thermostat set too low 7. Heater too small 8. Wrong piping connections 9. Wasted hot water 	<ol style="list-style-type: none"> 1. Provide ventilation to water heater. Check flue way , flue baffle and burner. 2. Clean flue, locate source and correct 3. Check with gas utility company 4. Replace with correct orifice 5. Replace thermostat 6. Turn temperature dial to lower setting 7. Install adequate heater 8. Correct piping-dip tube must be in cold inlet 9. Advise customer
DRIP FROM RELIEF VALVE	<ol style="list-style-type: none"> 1. Excessive water pressure 2. Heater stacking 3. Closed water system 	<ol style="list-style-type: none"> 1. Use a pressure reducing valve and relief valve. 2. Lower the thermostat setting 3. See page 12, "Closed System/Thermal Expansion".
DISCOLORATION OF JACKET ABOVE COMBUSTION AREA	<ol style="list-style-type: none"> 1. Burner orifice too large 2. Flue clogged 3. High gas pressure 	<ol style="list-style-type: none"> 1. Replace with correct orifice 2. Clean, locate source and correct 3. Adjust pressure to proper setting by qualified service personnel only.
SMOKING AND CARBON FORMATION (SOOTING)	<ol style="list-style-type: none"> 1. Insufficient secondary air 2. Low gas pressure 3. Orifice too large 4. Flue clogged 5. Defective thermostat 6. Heater installed in a confined area 7. Burner flame yellow-lazy 	<ol style="list-style-type: none"> 1. Provide ventilation to water heater. Check flue way, flue baffle, and burner. 2. Check with gas utility company 3. Replace with correct orifice 4. Clean, locate source and correct 5. Replace thermostat 6. Provide fresh air ventilation. 7. See "Burner Flame Yellow-Lazy" above.
COMBUSTION ODORS	<ol style="list-style-type: none"> 1. Insufficient secondary air 2. Flue clogged 3. Heater installed in a confined area 	<ol style="list-style-type: none"> 1. Provide ventilation to the water heater 2. Clean, locate source and correct. 3. Provide fresh air ventilation.
CONDENSATION	<ol style="list-style-type: none"> 1. Temperature setting too low 	<ol style="list-style-type: none"> 1. Increase the temperature setting. See page 16.
SMELLY WATER	<ol style="list-style-type: none"> 1. Sulfides in the water 	<ol style="list-style-type: none"> 1. Replace the anode with a special anode.
THERMOSTAT FAILS TO SHUT OFF	<ol style="list-style-type: none"> 1. Defective thermostat 2. Improper calibration 	<ol style="list-style-type: none"> 1. Replace thermostat 2. Replace thermostat
BURNER FLAME TOO HIGH	<ol style="list-style-type: none"> 1. Insufficient secondary air 2. Orifice too large 	<ol style="list-style-type: none"> 1. Provide ventilation to water heater 2. Replace with correct orifice
FLAME BURNS AT ORIFICE	<ol style="list-style-type: none"> 1. Low gas pressure 2. Defective thermostat 	<ol style="list-style-type: none"> 1. Check with gas utility company 2. Replace thermostat
PILOT FLAME TOO SMALL	<ol style="list-style-type: none"> 1. Low gas pressure 2. Pilot line or orifice clogged 3. Wrong pilot burner 	<ol style="list-style-type: none"> 1. Check with utility 2. Clean, locate source and correct 3. Replace with correct burner
BURNER FLAME FLOATS AND LIFTS OFF PORTS	<ol style="list-style-type: none"> 1. High gas pressure 2. Orifice too large 3. Flue clogged 4. Heater installed in a confined area 5. Cold drafts 	<ol style="list-style-type: none"> 1. Check with utility 2. Replace with correct orifice 3. Clean flue and burner-locate source & correct 4. Provide fresh air ventilation 5. Locate source and correct

REPAIR PARTS ILLUSTRATION

REPAIR PARTS

When ordering repair parts always give the following information:

1. Model, serial, and product number
2. Type of gas
3. Item number
4. Parts description

REPAIR PARTS LIST

ITEM NO.	PARTS DESCRIPTION	
1	DRAFTHOOD	
2	REDUCER RING - SOME MODELS	
3	BAFFLE ASSEMBLY	
4	HEAT TRAP (COLD) - SOME MODELS	
5	HEAT TRAP (HOT) - SOME MODELS	
6	COLD WATER DIP TUBE	
7	ANODE ROD	▲
8	TEMPERATURE & PRESSURE RELIEF VALVE (LOCATED TOP OR SIDE)	■
9	DRAIN VALVE	
10	THERMOSTAT	★
11	MANIFOLD	★
12	ORIFICE	★
13	MAIN BURNER	★
13A	BURNER NATURAL LOW NO _x	
14	PILOT ASSEMBLY	★
15	PILOT TUBE	
16	THERMOCOUPLE	
17	SCREW 8-32 X .312 PH RD MACH	
18	SCREW 8-32 X .25 SELF TAPPING	
19	INNER DOOR	
20	OUTER DOOR	
21	ALTERNATE OUTER DOOR - SOME MODELS	
22	PILOT SHIELD - SOME MODELS	
23	AIR SHUTTER - L.P. MODEL ONLY	
24	PIEZOELECTRIC IGNITER ASSEMBLY - SOME MODELS	
25	IGNITER BUTTON AND BRACKET - SOME MODELS	

LEGEND

- ▲ Special anode rod (see page 19).
- Temperature and Pressure Relief Valve is required, but may not be factory installed.
- ★ It is imperative the replacement main burner, orifice, manifold, pilot burner, and the thermostat be ordered for the proper gas type. Natural gas thermostat will be marked "Natural Gas Only". Propane gas thermostats will be marked "For L.P. Gas Only".

