



# Installation/Owner Manual

SOLARHOT Pool Heating Installation

# Table of Contents

<b>GETTING STARTED</b>	<b>2</b>
<b>THINGS TO REMEMBER</b>	<b>3</b>
<b>INSTALLATION KITS AND COMPONENTS</b>	<b>4</b>
<b>PARTS BREAKDOWN</b>	<b>5</b>
<b>SOLAR COLLECTOR LAYOUT</b>	<b>6</b>
<b>CONNECTING THE SOLAR COLLECTORS TOGETHER</b>	<b>7</b>
<b>MOUNTING COLLECTORS TO ROOF OR RACK</b>	<b>8</b>
<b>MOUNTING SCHEMATIC</b>	<b>9</b>
<b>MOUNTING THE SOLAR COLLECTORS ON A FLAT ROOF</b>	<b>10</b>
<b>ASSEMBLY OF ROW SPACER KITS</b>	<b>11</b>
<b>CONNECTING THE COLLECTORS TO THE FEED AND RETURN LINES</b>	<b>12</b>
<b>RUNNING THE FEED AND RETURN LINES TO GROUND LEVEL</b>	<b>13</b>
<b>HOW TO CONNECT THE SOLAR COLLECTORS TO EXISTING POOL FILTRATION SYSTEM</b>	<b>15</b>
<b>CONNECTING THE FEED AND RETURN LINES TO THE FILTRATION SYSTEM</b>	<b>16</b>
<b>Pressure Testing the System</b>	<b>17</b>
<b>Troubleshooting</b>	<b>18</b>
<b>REPAIR PROCEDURES</b>	<b>21</b>
<b>OPERATING AND CHECK OUT PROCEDURES</b>	<b>23</b>
<b>THAT'S ALL THERE IS TO IT!</b>	<b>24</b>

SOLARHOT Collectors are manufactured utilizing cutting-edge technology and the most advanced production techniques. A SOLARHOT System will provide years of worry-free performance as it captures safe, reliable heat from the sun year after year.

This manual will give you a great deal of valuable information. Take time to read through it and view the Installation Video. Both will guide you through the most efficient way to correctly install a SOLARHOT system. By following this step-by-step guide, your system will meet the installation standards recommended by the factory.

While this manual explains how to install SOLARHOT Panels properly in typical situations, it cannot address all the unique or individual circumstances possible. If you have any installation questions, contact your SOLARHOT representative for assistance. As the installing contractor, you are responsible for exercising good judgment when using SOLARHOT to protect the long-term integrity of the collectors as well as the mounting surfaces.

# GETTING STARTED

Before you start your installation, here are a few important tips:

**CAUTION-SAFETY COMES FIRST!** There is no substitute for safety. Always exercise extreme caution, care and good judgment when working on or around a roof or pool area.

Please take care to avoid hazards such as overhead electrical wires or loose shingles.

Be sure to secure ladders so they will not slip or fall.

Do not allow extension cords to lie in the pool or in standing water.

Wear shoes with proper tread to prevent slipping on the ladder or sloped roof areas.

Disconnect all power to the pool when installing an automatic control system.

Check with your local building department to determine permitting and code requirements in your area.

While this manual explains how to install SOLARHOT Solar Collectors properly in typical situations, it cannot possibly address all the unique or individual circumstances possible. If you have any installation questions, contact your SOLARHOT representative for assistance.

Before starting any work, determine the location of your system and prepare a schematic drawing of the installation area. Include the location of the feed and return lines in this drawing. Roof areas often look bigger than they really are, so be sure to measure the available area before making your schematic. Be sure that the layout of the collectors will allow the collectors to drain when the pool pump shuts off.

Familiarize yourself with all of the SOLARHOT components and plumbing materials that you will need to complete the installation.

Don't take shortcuts. Whenever possible, panels should be installed so they are accessible without being walked on. Walking on the collectors should only take place when absolutely necessary.

Depending upon your specific job, you will need various plumbing items and materials. Be sure to use quality products that will withstand direct sunlight year after year. Here are some recommendations:

**PVC PIPE:** Use PVC SCHEDULE 40 pipe. Do not use ABS or a lower standard substitute.

**PVC FITTINGS:** Use PVC SCHEDULE 40 pressure-rated fittings to match your PVC pipe.

**DO NOT USE** "plumbers" fittings or DWV fittings (Drain, Waste and Vent).

**PVCV CLEANER AND CEMENT:** It is important to both CLEAN and CEMENT each PVC joint. When gluing CPVC fittings to PVC pipe, such as the {STR-PC} Pipe Connectors, it is necessary to use a good quality multi-purpose cement.

*NOTE: While this manual explains how to install your SOLARHOT Solar System properly in typical situations, it cannot address all the unique or individual circumstances possible. If you have any installation questions, contact your SOLARHOT representative for assistance. As the installer, you are responsible for exercising good judgment when installing SOLARHOT Systems to protect the long-term integrity of the collectors, as well as the mounting surfaces.*

# THINGS TO REMEMBER

No two installations are exactly alike, but there are some general bits of technical information that you will find helpful in the field.

**ROOF ORIENTATION:** Ideally, collectors should be located on a South-facing or flat roof, or on an elevated ground-mounted rack facing South. The next best orientation is West, and finally East. A collector should NEVER be installed on a North roof without a reverse rack.

**COLLECTOR CONFIGURATIONS:** There are many ways to configure a solar array. The most common or preferred is in one continuous row. The recommended limit to the number of collectors that can be installed this way to achieve even flow throughout the array is (10) STR-40's or (8) STR 50's.

The maximum guideline can be exceeded if there is high flow or substantial back pressure on the system which will force adequate flow through every collector. When you have more than the maximum, though, you should either use the Double Row layout or the Single Row Split Feed layout. The Double Row can also be used for smaller installations when space is a problem.

If you have to split up an array due to a skylight or change in roof level or direction, the layout will be similar to Single Split Row layout.

**PUMP HORSEPOWER:** The horsepower of your swimming pool filtration pump must be adequate to supply the solar system with enough water to provide the recommended flow rate necessary for the collectors being installed. The recommended rate for an STR-40 is 4 gallons per minutes and 5 gallons per minute on an STR-50.

Generally, a 1 horsepower pump is sufficient for a standard pool solar system unless there is an unusually long pipe run, a high roof or a large number of collectors. If you are not sure what your pump flow rate is, consult your SOLARHOT representative or pump manufacturer for the pump's flow characteristics.

**PLUMBING:** It is important that you use the proper size PVC pipe for the size of the solar array. Under sizing the pipe will produce too much restriction to the water flow and unnecessarily reduce the flow rate to the collectors. Use the following as a guide:

Flow Rate	Minimum Pipe Size
0 to 45 GPM	1-1/2"
46 to 80 GMP	2"

Plumbing runs should be as short as possible and the "Hot Return" pipe should have the shortest run to reduce the potential heat loss in this pipe. Pipes should be supported with G-clamps at least every 5 feet o prevent sagging. The G-clamp used on pipe runs across a roof should be 1/2" larger than the pipe diameter to allow for expansion and contraction. C-clamps should be used on vertical or horizontal runs on the side of a building, and should be the same size as the pipe diameter to prevent vibration.

**AUTOMATIC DRAIN DOWN:** The collectors and the PVC pipe should be installed so the water will drain out of them when the pool pump shuts off. This is especially important in areas of the country where freezing conditions occur. (The SOLARHOT Solar Pool Collectors are warranted against internal freezing when installed to allow for drain down.) If, as a result of a unique roof design or adverse pool equipment location, it is not possible to achieve complete automatic drain down, manual drain down valves should be installed in appropriate places in the plumbing or at the end of the bottom (feed) header. [Instead of installing an {STR-ED} End Cap at the end of the header, you would place a {STR-VC} Vac Cap along with a {BD-050} Boiler Drain. These valves should be opened when shutting down the system for the winter months or when freezing conditions are possible. Your SOLARHOT representative can assist you with the parts necessary for manual drain down installations.

# INSTALLATION KITS AND COMPONENTS

The following is a description of the installation kits that are required for a complete SOLARHOT installation. The {STR-SK} System Kit and {STR-CK} Collector Kits are always required while the {STR-RSK} Row Spacer Kit is only required for certain installations. The {STR-PTK} Pressure Testing Kit is used during installation to test the system while the {STR-RTK} Repair Tool Kit is used if you ever need to repair a collector.

## **STR-CK: COLLECTOR KIT**

One of these kits is required for each collector. It contains two {STR-PPC} Plastic Panel Clamps and two {STR-MP} Mounting Pads. Additional mounting pads will be necessary on roofs with a pitch of 10/12 or greater.

## **STR-SK: SYSTEM KIT**

One of these kits is required for each row or bank of collectors. It contains the parts necessary to connect the collectors to the feed and return lines.

## **STR-RSK: ROW SPACER KIT**

One of these kits is required if you need to bypass a vent pipe, or obstacle larger than 6". It is also used to connect collectors into one row that are on different roof levels or that are facing different directions. It contains the parts necessary to connect the collectors to the PVC pipe between them.

## **STR-PTK: PRESSURE TESTING KIT**

This kit gives you the components you need to pressure test the system once installation is complete.

## **STR-RTK: REPAIR TOOL KIT**

In the event a collector is damaged, this kit contains everything needed to make a repair to a rise tube.

(See Table 4.1 for parts breakdown)

# PARTS BREAKDOWN

## COMPONENTS

Part No.	Description	SR/CK	STR/SK	STR/RSK	STR/PTK	STR/RTK
STR-MP	Mounting Pad	2				
STR-PPC	Panel Clamp with Gasket	2	2	2		
STR-PC	Pipe Connector		2	4		
STR-EC	End Cap		2			
STR-JC	J-Clamp		1			
STR-BV05	1/2" Ball Valve				1	
STRP-PG	0-60 PSI Pressure Gauge				1	
STR-PTT	Pressure Test "T" Assembly				1	
STR-PIT	Pin Insert Tool					1
STR-C25	1/4" Chisel					1

## OTHER INSTALLATION COMPONENTS

STR-VB.....Vacuum Breaker

STR-FL.....Flange

STR-GC.....G-Clamp

STR-LB200....1/4" x 2" Stainless Steel Lag Bolt

STR-TPC.....100 Tapcons 1/4" x 1-3/4" with Drill Bit

STR-CV150.....PVC 1 1/2" Check Valve

STR-CV200.....PVC 2" Check Valve

STR-BV2.....Two-Way Ball Valve

STR-JV3.....Three-Way Jandy Valve

STR-GA.....Gasket for Panel Clamp



STR-MP



STR-PC



STR-EC



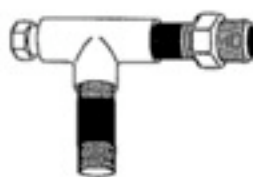
STR-PPC



STR-PG  
PRESSURE GAUGE



STR-BV05  
1/2" BALL VALVE



STR-PTT  
PRESSURE TEST "T" ASSEMBLY



STR-C25  
1/4" CHISEL



STR-PIT  
PIN INSERT TOOL

# SOLAR COLLECTOR LAYOUT

Shown below are the three most common Solar Collector installations.

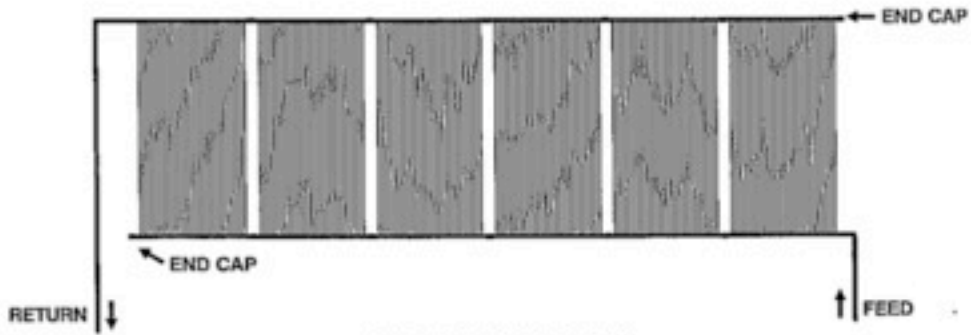


FIG 5.1 - SINGLE ROW

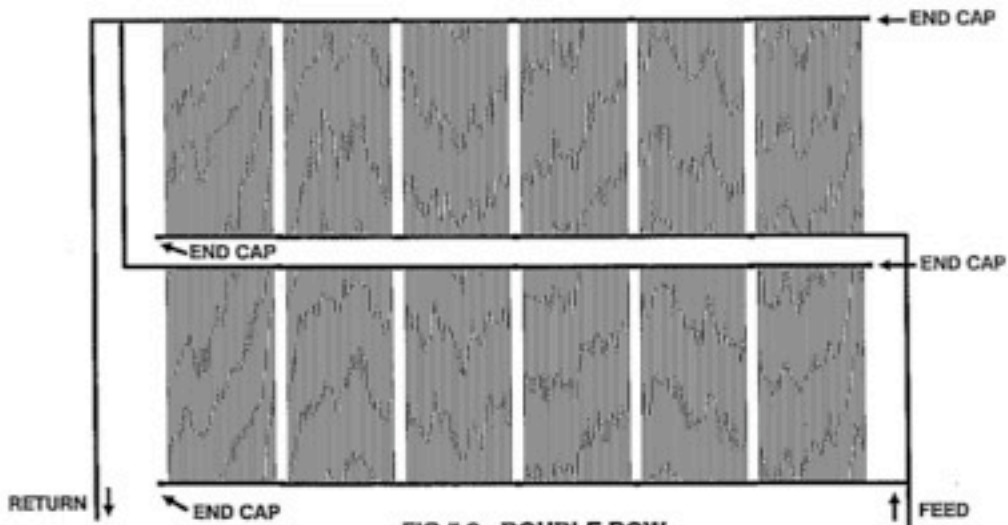


FIG 5.2 - DOUBLE ROW

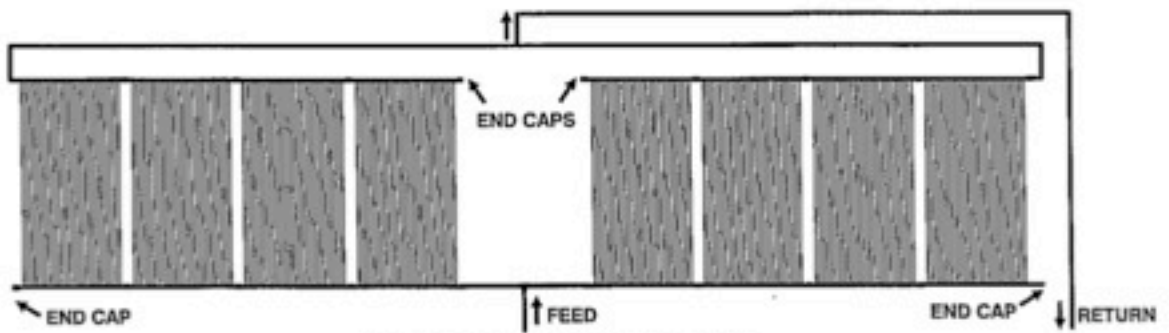


FIG 5.3 - SINGLE ROW SPLIT FEED

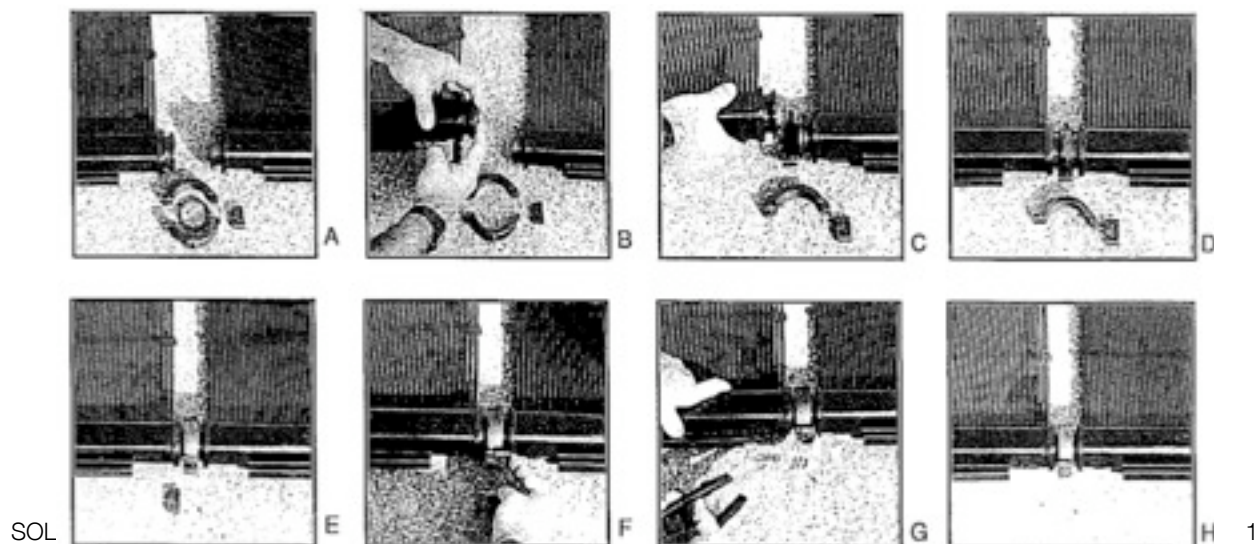
# CONNECTING THE SOLAR COLLECTORS TOGETHER

Later on in this installation manual you will be instructed to connect the collectors together using {STR-PPC} Plastic Panel Clamps. When connecting collectors together, follow the directions outlined below:

1. Place two collectors next to each other. The spacer bars that hold the individual riser tubes together should be facing down. Lay a {STR-PPC} Plastic Panel Clamp top, bottom, gasket and clip where the two headers meet. (Fig. 6.2 - A)
2. Clean the groove of both headers.
3. Spray the gasket with silicone and insert it into the groove of one of the headers. Make sure that the gasket is fully seated into the header groove by pushing firmly with your thumb all the way around the gasket. (Fig. 6.2 - B)
4. Place the bottom half (see Fig. 6.3) of the {STR-PC} Plastic Panel Clamp under the collector header with the hook portion of the panel clamp on the inside of the collectors. (Fig. 6.2 - C)
5. Seat both headers together by inserting the gasket into the opposite header groove and placing the ends of both headers into the open space in the panel clamp bottom. (Fig. 6.2 - D)
6. Interlock the top half of the panel clamp with the hook on the bottom half. Swing top half over top of collector headers. Squeeze the top and bottom portions of the panel clamp together using channel lock pliers and lock both halves of the clamp together using the locking clip. (NOTE: Slide large end of locking clip over small end of Plastic Panel Clamp assembly.) (Fig. 6.2 - E & F)
7. Use channel lock pliers to tighten the clip grip by squeezing it with reasonable force until it seats flush or even slightly fatter so it cannot slide out of its position. (Fig. 6.2 - G)
8. Use this same procedure to connect both top and bottom headers of the collectors.

NOTE: On soft roof surfaces or lesser quality asphalt shingle, an EPDM or an aluminum pad underneath the panel clamp may be necessary to eliminate possible wear.

FIG 6.2





# MOUNTING COLLECTORS TO ROOF OR RACK

The most important feature of the SOLARHOT installation method is its simplicity. The mounting pad's flexibility allows for the relatively simple installation of the SOLARHOT collectors on any roof or rack surface, regardless of pitch. To properly install collectors utilizing mounting pads, follow these steps:

1. Prepare each collector by sliding the {STR-MP} Mounting Pads onto the mounting rail molded to the TOP HEADER. Two Pads per collector are required for roofs with a slope or pitch less than 10/12 and should be located on the mounting sections of the collector. Mounting Pads should never be installed on the bottom member since the panels need to be free to expand and contract.

#### Number of Mounting Pads Required

Roof Pitch less than 10/12 (37.5\*) - 2 Pads Required

Roof Pitch 10/12 or greater (37.5\*) - 4 Pads Required

NOTE: Typically, each Mounting Pad should be centered on the mounting rail. However, the Pad can be slid from side to side so that it can be centered on a roof truss or on the top of a barrel tile. You may even want to move the Mounting Pad to a different mounting rail, but remember to always keep the Pads spaced out as evenly as possible.

2. Snap a chalk line across the roof where you want the top edge of the collector header to be. This chalk line should slope upward towards where the return line will be located, 1" every 20' to allow for proper drainage. The return line corner of the collectors should be the top corner closest to the pool pump so that once the water is heated, it will be returned to the pool as quickly as possible. Be sure to allow 2" of clearance above this chalk line for the Mounting Pads.

3. Lay the first two collectors so that the top edge of the top header is located as the chalk line.

4. Connect the top headers of the collectors together using the {STR-PPC} Plastic Panel Clamp by following the procedures described in the section of this manual on connecting solar collectors together.

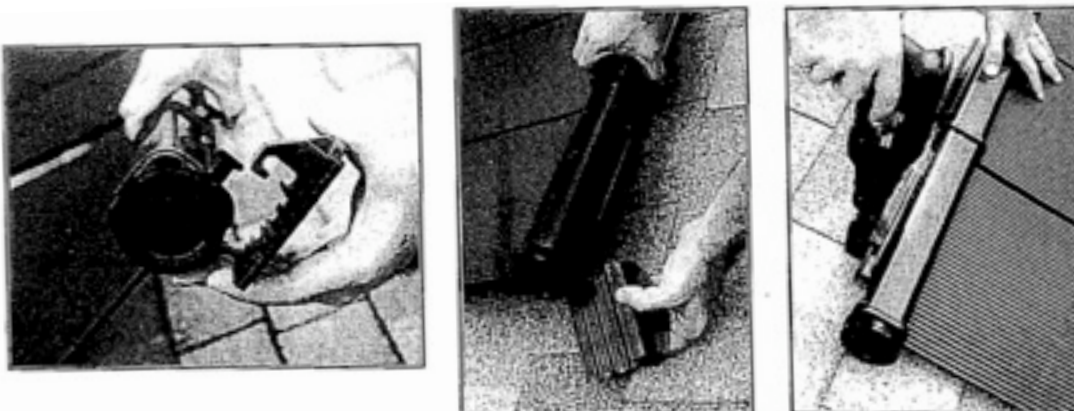
5. After positioning the Mounting Pads in the proper location, secure the first collector to the roof. Apply ample silicone to both lag bolts or appropriate roof fasteners and to the roof. Position Mounting Pad on the roof and lag to the roof. The {STR-200} 1/4" x 2" lag bolt should be securely fastened, but no over tightened. In the case of tile roofs, tapcons are commonly used to attach the Mounting Pads to the tile. Using tapcons avoids the need to penetrate the roof membrane or substrate in cases where the roof tiles are properly anchored to the roof. On all types of roofs, be sure to seal each penetration with the proper sealant.

6. Before securing the next collector to the roof, connect an additional collector to the row using the Plastic Panel Clamp. This allows you to lift up the header of the adjacent collector when connecting the two collectors together.

7. Follow the procedures listed above until all collectors are connected to each other and anchored to the roof.

8. After all collectors are anchored to the roof, connect the bottom headers together with additional Plastic Panel Clamps.

FIG. 7.1



# MOUNTING SCHEMATIC

NOTE: As the installing contractor, it is your job to evaluate any site-specific conditions that might create unwanted roof wear. As an example, if you are installing the system on an inexpensive or soft asphalt shingle roof, you'll want to put some 4" x 4" pads underneath each panel clamp along the bottom headers to prevent roof wear. Some installers make these pads from aluminum roof flashing or old mat systems, and attach them to the roof with silicone or an adhesive.

FIG. 7.2

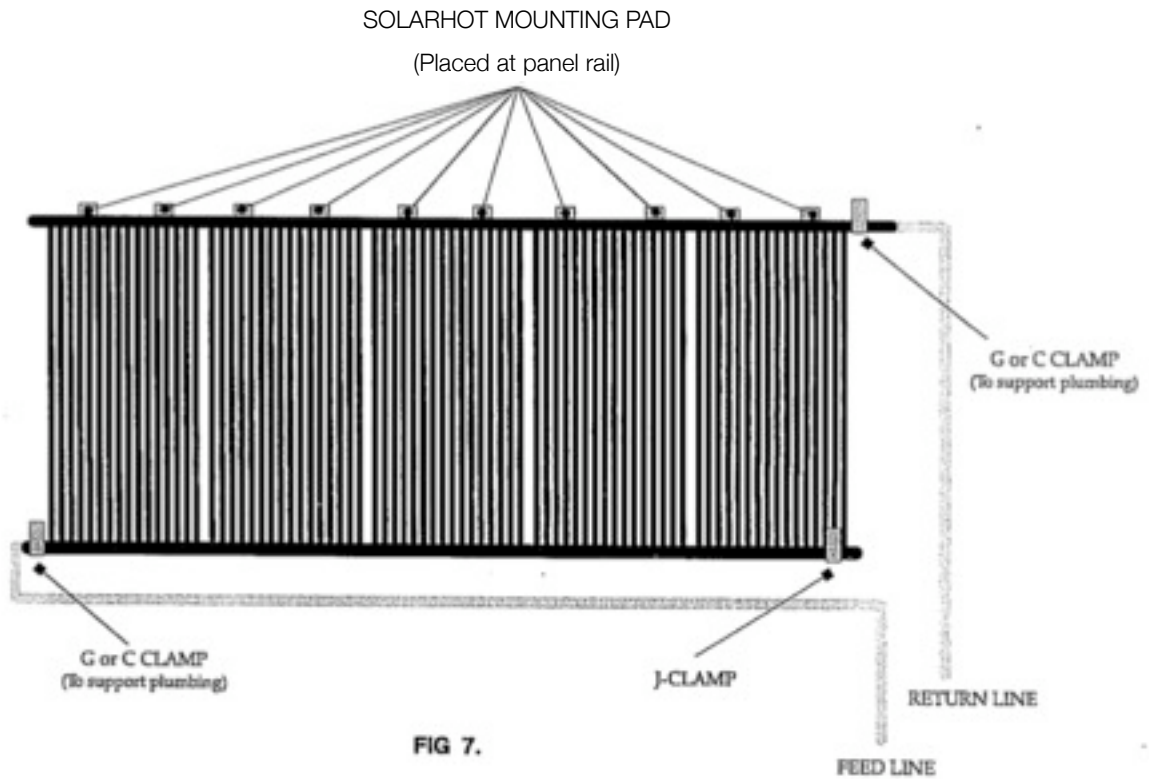


FIG 7.

NOTE: Install the J-Clamp 3" inside the panel clamp on the corner opposite the feed line. The J-Clamp should also be 1/2" below the header to allow for expansion and contraction. (See Figs. 7.2 and 7.3)

NOTE: SOLARHOT Mounting Pads are NOT used on the bottom headers. They are used on the top header only.

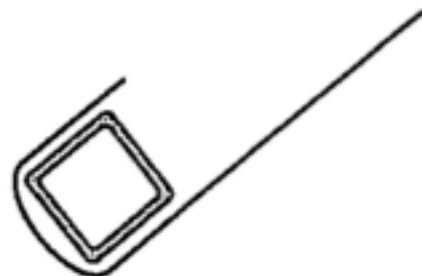


FIG. 7.3

# MOUNTING THE SOLAR COLLECTORS ON A FLAT ROOF

If you have chosen a flat roof area to mount the solar collectors, it is best not to penetrate the roof surface with a lag bolt.

## FIBERGLASS-COATED, METAL OR SHINGLED FLAT ROOFS

If you have one of these three types of roofs with at least 3" of slope down the panel length, you can use the Mounting Pad installation method previously described. Use liquid adhesive instead of lag bolts to secure the Pad to the roof.

## BUILT-UP TAR AND GRAVEL ROOF AND ROOFS WITH NO SLOPE

If you have this type roof, use the following installation method.

## FLAT ROOF METHOD USING PRESSURE TREATED 4X4's

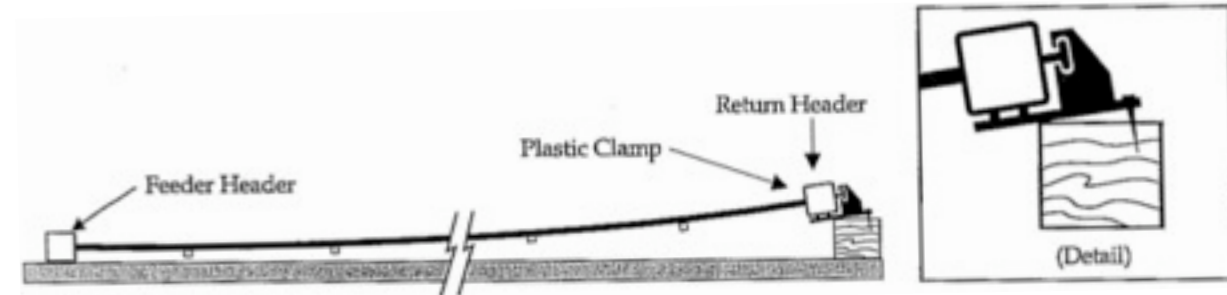


FIG. 8.1

1. Remove any loose gravel from the roof where the top headers will be located.
2. Place a 43" section of pressure treated 4x4 on the flat roof at the location of each return header (see Fig. 8.1). Leave a 4" gap between each 43" section to allow water to drain through. Secure the 4x4 to the roof with a good quality liquid adhesive.
3. Loosely attach {STR-MP} Mounting Pad to the 4x4 using the {STR-200} 1/4" x 2" stainless steel lag bolts.
- (Optional) If one of the plumbing lines runs next to the bottom header, you can loosely secure the bottom header to it using black nylon electrical ties.
4. If you use a Row Spacer Kit with this assembly method, continue the 4x4 under the pipe between collectors to prevent sagging. If it is a long run, clamp the pipe to the 4x4.

NOTE: The 4x4 can be cut at a bevel so as to allow the collector to rest at a 10 to 15 degree angle. (See Fig. 8.2)

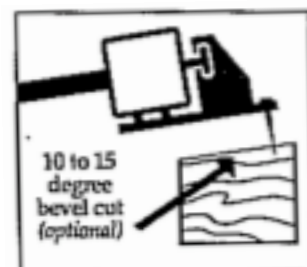


FIG. 8.2

# ASSEMBLY OF ROW SPACER KITS

One of the SOLARHOT advantages is that most roof vents can be circumvented without the use of a Row Spacer Kit. However, if the obstruction is wider than 6" or if it is within 24" of the header, you will need to circumvent it by using (STR-RSK) Row Spacer Kit.

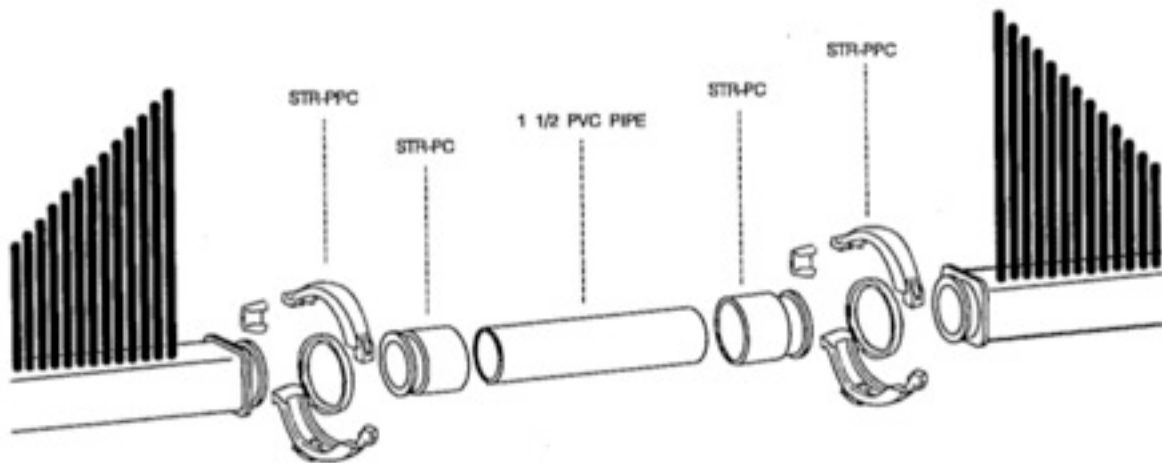
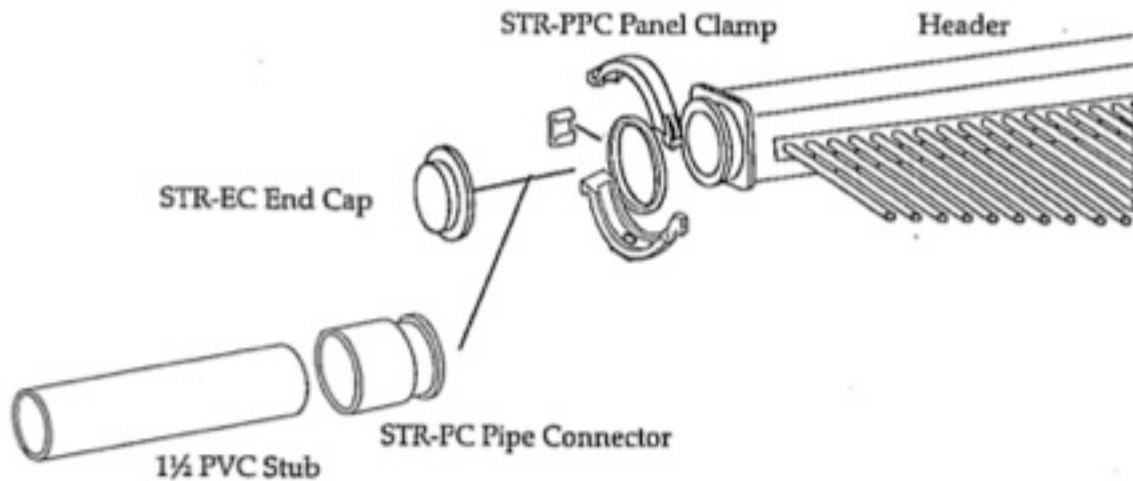


FIG. 9.1

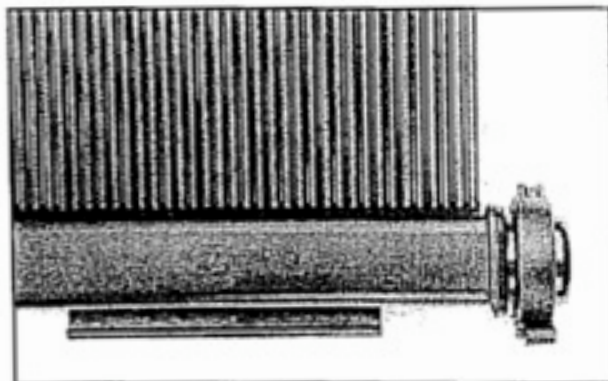
1. Connect the 4 {STR-PC} Pipe Connectors to the headers of the collectors to be connected with a {STR-PPC} Plastic Panel Clamp using the same procedures outlines in the section on connecting solar collectors together on page X.
2. Cut two lengths of 1-1/2" PVC pipe long enough to cement the {STR-PC} Pipe Connectors on each collector to each other. NOTE: When gluing CPVC fittings such as the Pipe Connector {STC-PC}, it is necessary to use a good quality multi-purpose cement.
3. Cement the PVC pipe to the Pipe Connectors as shown in Fig. 9.1
4. If the distance between the collectors is over 4 feet, a 2" G-Clamp should be used on both pipes to prevent sagging.

# CONNECTING THE COLLECTORS TO THE FEED AND RETURN LINES

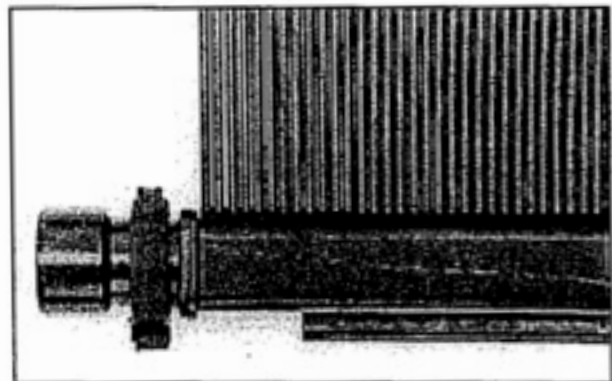


1. The feed line will be connected to the low end of the bottom header as previously determined when the chalk line was snapped. This should be the end farthest from the pool pump. The return line will be connected to the top header on the opposite end of the array. This should be the end closest to the pool pump. (See Figures on page X.)
2. Attach the {STR-PC} Pipe Connector to the corners of the array where the feed and return lines will be using the {STR-PPC} Panel Clamp as described in the section on connecting solar collectors together on page X.
3. The {STR-PC} Pipe Connector allows 1-1/2" PVC Pipe or a 1-1/2" St. 90 to be glued directly into the socket, or a 2" PVC 90 to be glued on the outside. CPVC or multi-purpose glue should be used when attaching PVC fittings or pipe to the Pipe Connectors to provide for a durable connection. A 90° PVC fitting and vertical pipe run of at least five feet should always be attached to the return line Pipe Connector to allow for lateral expansion and contraction of the return line pipe run.
4. Connect the feed and return pipes using good plumbing techniques.
5. Attache the {STR-EC} End Caps on the corners opposite the feed and return lines using the {STR-PPC} Panel Clamps as described on page X.

FIG. 10.2



A



B

# RUNNING THE FEED AND RETURN LINES TO GROUND LEVEL

Discussed here is the standard, most straightforward way of running the PVC pipe from the feed and return lines to the pool pump and filter or equipment pad. Some installations require a more creative approach due to unique roof designs or equipment locations on the opposite side of a house. Whenever possible, however, the return line should have the shortest run and all pipes should run slightly “downhill” to allow for automatic drain-down of the plumbing and solar array.

If the equipment pad is against the house, you may want to complete the necessary plumbing at the equipment pad before completing this portion of the installation. This allows you to know exactly where the pipes should come down from the roof. If you will be trenching from the equipment pad to the installation location this would not be necessary.

1. Cement the appropriate size PVC 90° elbow to the return line stub facing down toward the bottom header. (see Fig. 12.1 on page X).

NOTE: Whenever cementing, lay a rag on the roof or rack under the joint to avoid dripping cement on the mounting surface. Also, it is a good idea to tape the cans of PVC cleaner and PVC cement together. They are less apt to tip over and spill this way.

2. Determine where the feed and return pipes will go over the edge of the roof. If possible, this should be perpendicular to the exact points where they will fasten into the existing system or into pipes coming from another location (see Fig. 13.1 on page X).

3. Measure the distance from the return elbow down to the spot that you want to go across the roof to the point established above. Be sure to include the depth of the socket in the elbow in your measurement. Cut a piece of PVC pipe to this length. Repeat this process for the feed line.

4. If you are not experienced at cutting and fitting pipe, it is a good idea to assemble all pipe and fittings before cementing them, just in case you make an error. Clean the burrs off these cut pipe lengths and insert them into the elbows.

5. Measure across the roof from these pipes to the points established in step 3. Cut and de-burr pipes to these lengths and assemble corner with 90° elbows.

6. Continue this process around the edge of the roof and down to the existing plumbing, keeping pipes as short, straight and tight to the building as possible.

7. Once you are satisfied with the plumbing arrangement, go back and cement all joints together.

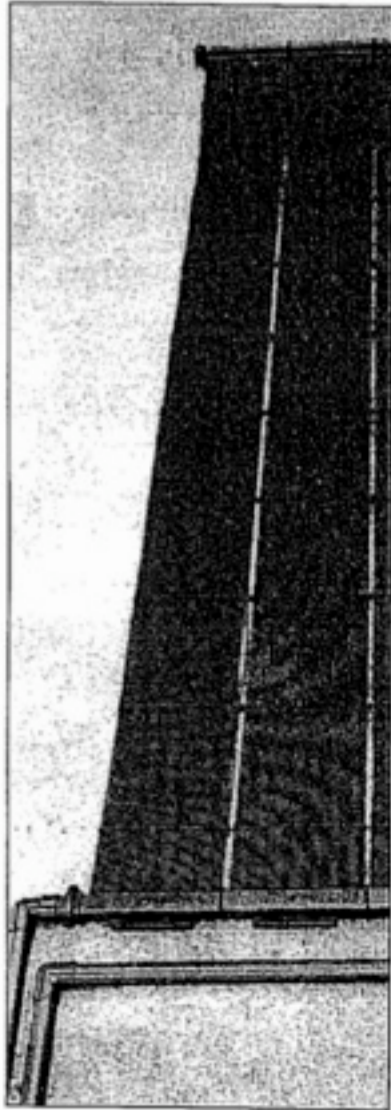
8. Secure long pipe runs every 4 to 5 feet with G-Clamps or pipe straps one size large than the pipe diameter, using Stainless Steel Lad Bolts and silicone caulk. Secure vertical pipe runs on the side of buildings with C-Clamps the same size as the pipe diameter using screws and anchors as needed.

NOTE: Be sure to support all of the weight of the plumbing with G-Clamps or pipe straps. The Mounting Pads are not designed to support the weight of the plumbing in addition to the weight of the collectors.

NOTE: All four corners of each row of collectors should be securely fastened to the roof. The feed and return corners should already be secured with the G-Clamps or pipe straps on the plumbing lines and the top corner opposite the return corner should already be secured with a Mounting Pad. Secure the bottom corner opposite the feed line with a J-Clamp by placing it halfway between the Panel Clamp and the mounting groove. The J-Clamp should also be 1/2” below the header to allow for expansion and contraction.

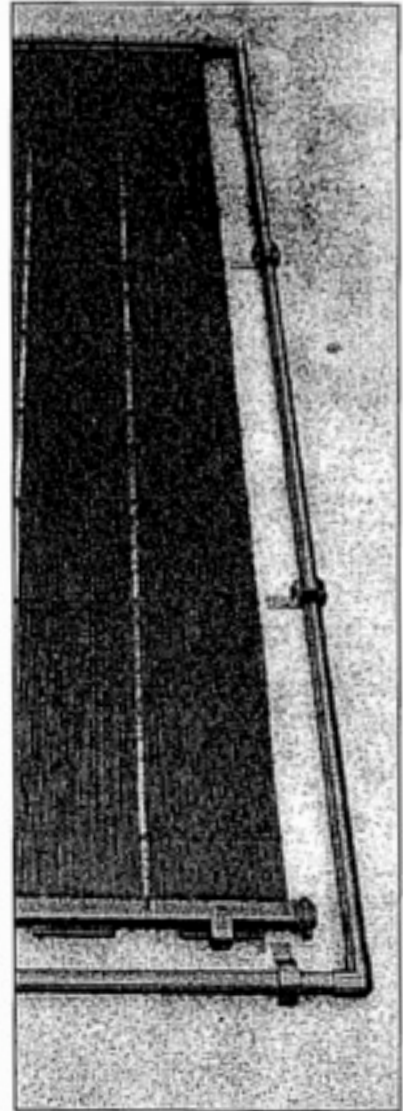


FIG. 12.1

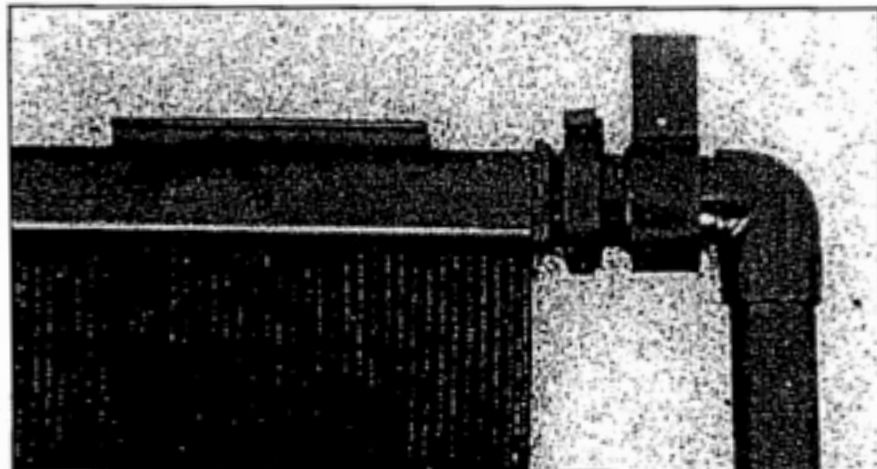


← A: Feed line is attached to the bottom header and an End Cap is attached to the top header.

B: In this completed assembly, the return line is attached to the top header and an End Cap on the bottom header. →

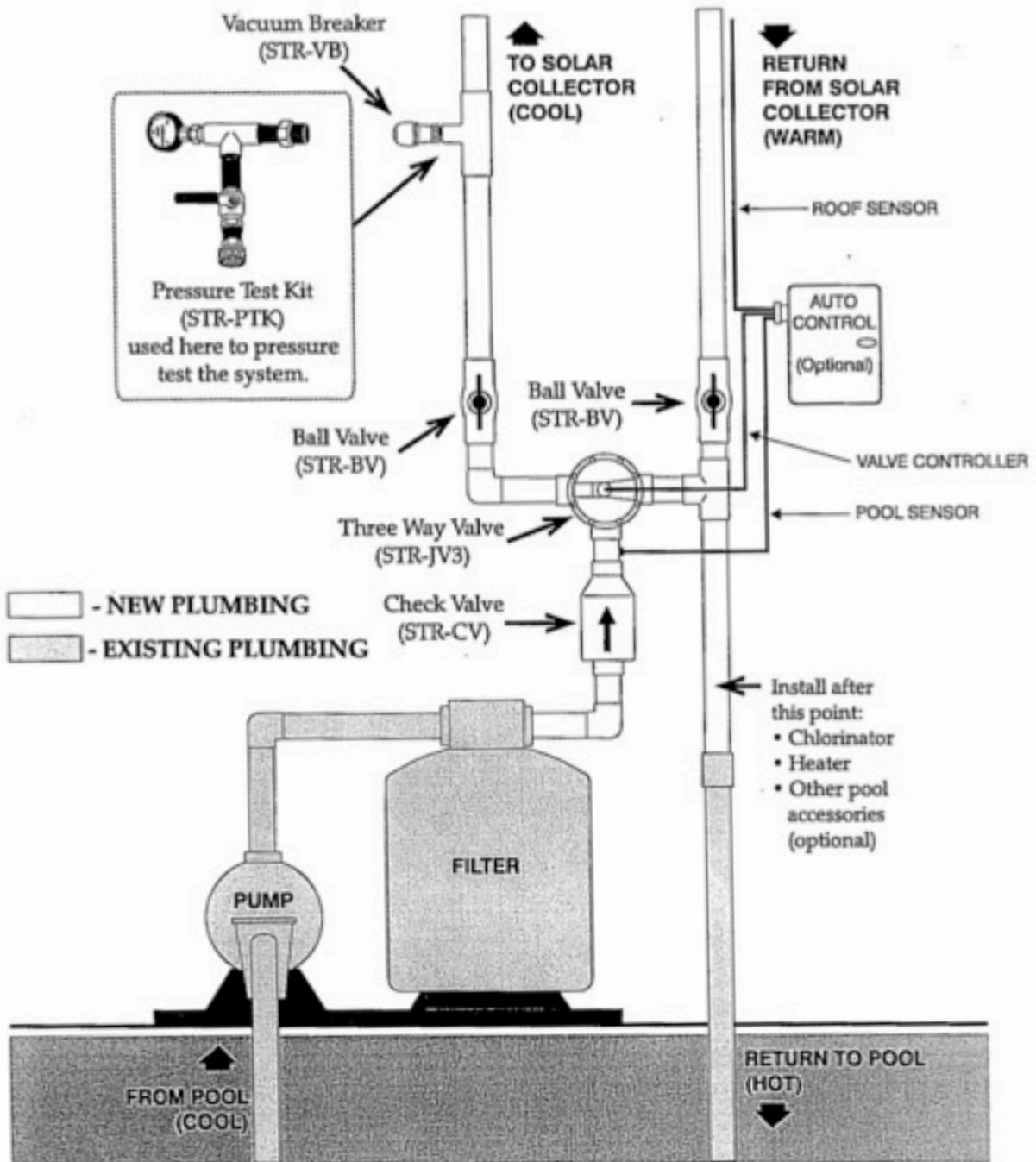


C: The assembled return line utilizes the STR-PC Pipe Connector, STR-PPC Panel Clamp and a G-Clamp.



# HOW TO CONNECT THE SOLAR COLLECTORS TO EXISTING POOL FILTRATION SYSTEM

FIG. 15.1





# CONNECTING THE FEED AND RETURN LINES TO THE FILTRATION SYSTEM

Fig. 15.1 on page X shows how a typical SOLARHOT Solar Pool Heating System is plumbed into existing pool plumbing. This drawing may not be just like every system you encounter. The feed and return plumbing on a solar system may be reversed, or it may have a different type of filter, or it may have additional equipment such as a chlorinator, pool cleaner, gas heater, etc. It may also have a long run of plumbing from the pool equipment to the solar collectors.

Whether the system is like this or not, Fig. 15.1 will help you understand the flow of water from the pool, through the pump, filter, solar system and back to the pool. Study the diagram and become familiar with the valves need to connect the solar collectors to existing plumbing.

Notice that the first Check Valve is plumbed in after the filter. This prevents the filter from being backwashed by the water draining down the panels when the pump shuts off. The Three-Way Valve either diverts the water to the solar system or directly back to the pool. This Three-Way Valve should be a non-positive valve. This enables the water in the solar system to drain back to the pool when the pump shuts off. The Two-Way Valves on the solar feed and return lines allow you to isolate (completely shut off) the solar system.

1. Study the plumbing after the filter and decide where you are going to install the Check Valve and the PVC tee fitting (see Fig. 15.1). If you have auxiliary equipment, you may need to re-plumb a portion of your existing plumbing so this equipment is located before or after the solar system as indicated in Fig. 15.1.
2. Cut the pipe after the filter where you have decided to locate the Check Valve and where your solar return pipe will be attached to your existing pool return line. If your pool plumbing is 1-1/2" and you are running 2" plumbing to your solar system, you should be using 2" valves and piping for all of your new plumbing, so you will need (2) 2" x 1-1/2" reducer bushings to adapt your new 2" fittings to the existing 1-1/2" pipe.
3. As discussed earlier in this manual, it is a good idea to assemble all pipe and fittings before cementing them, just in case you make an error. Install a Check Valve on the pipe coming out of the filter. Be sure that the arrow showing flow direction is pointed away from the filter.
4. The Three-Way Valve will be installed next. It may come right next to the Check Valve, or you may have to use some pipe and fittings to locate it off of the main line. As stated earlier, use as few 90° elbows as possible.
5. Install the Two-Way Valve to the solar feed line and then connect the other side of the Two-Way Valve to one of the ports on the Three-Way Valve.
6. Install the {STR-VB} Vacuum Breaker about 4 feet up the feed line using a PVC tee and reducer bushing. Face the tee to the outside as shown in Fig. 15.1. Wrap the threads of the Vacuum Breaker with teflon tape and screw it into the 3/4" threaded reducer bushing.
7. Install the second Two-Way Valve to the solar return line.
8. Determine now where to locate the PVC tee fitting. The tee may be located right next to the Three-Way Valve or elsewhere depending on your system. Connect the tee fitting first to the solar return line, then to the Three-Way valve, and then to the pool return line.
9. Once you are satisfied with the plumbing arrangement, go back and cement together all joints that you have not already cemented. Use good plumbing techniques and rags to protect the existing pool equipment.

NOTE: Use C-Clamps the same size as the outside diameter of your plumbing fittings to secure the pipe and fittings tightly to the wall.

# Pressure Testing the System

Pressure testing the entire solar system provides for a trouble-free installation and takes only about fifteen minutes. Any weak PVC glue joints, fittings or pipe, any improper Panel Clamp connections, will be evident while the system is put under 40 to 50 pounds of pressure.

1. Allow ample time for all glue joints to dry completely. Use this time to wrap up things and to clean up the job site.
2. Wrap the threads of the {STR-PTT} Pressure Test "T" Assembly, {STR-VB05} 1/2" Ball Valve and {STR-PG} Pressure Gauge with teflon tape. Replace temporarily the {STR-VB} Vacuum Breaker with the {STR-PTT} Pressure Test "T" Assembly. Thread the {STR-BV05} 1/2" Ball Valve and Pressure Gauge into the Pressure Test "T" Assembly.
3. Attach a garden hose to the 1/2" Ball Valve. **Make sure the 1/2" Ball Valve is in the off position.**
4. Turn the solar system on to allow the pool pump to completely fill the solar system. (If the pool pump is not operational, shut off the Ball Valve on the feed line and use the garden hose to fill the system.)
5. Once the solar system is completely full of water, turn off the pool pump or turn the Three-Way Valve to bypass the solar system. Quickly turn off the Ball Valves on both the feed and return lines.
6. Turn on the city water to the garden hose and open the 1/2" Ball Valve on the Pressure Test "T" Assembly until the Pressure Gauge reads 40 to 50 PSI and then turn off the 1/2" Ball Valve. Turn off city water.
7. With the system under pressure, check the whole system for any leaks. A drop in pressure on the Pressure Gauge indicates a leak in the system.
8. If there are leaks, open the Ball Valve on the return line to relieve the pressure. Repair any leaks. Repeat the pressure testing procedures as needed.
9. Return system to normal when through with pressure testing. Be sure to open both Ball Valves and replace the Pressure Test "T" Assembly with the Vacuum Breaker.

# Troubleshooting

PROBLEM	CAUSE	SOLUTION
<p>There are air bubbles in the pool only when the solar is operating.</p>	<p>If the pump is making more noise, there may be air coming into the pump through an air leak on the suction side of the pump due to the pump working harder to move the water through the solar system.</p> <p>If the Vacuum Breaker is installed on the roof, there is not enough pressure in the solar system to keep the vacuum relief valve closed and it is allowing air to be drawn into the water as it flows by the valve.</p>	<p>Be sure the pump trap lid is on tight.</p> <p>Check the “O” ring on the pump trap lid. Clean, lubricate or replace as needed.</p> <p>If you have a suction-type pool cleaner, remove it. If this improves the air bubbles, only use it when not operating the solar.</p> <p>If you have a clear lid on the pump and can see air bubbles in the trap, using a garden hose, run water over the lid and each joint individually to see if the air bubbles will clear up. If there is not a clear lid, listen to pump noise for a smoother operation. Repair any air leaks.</p> <p>Be sure filter is clean. Backwash to reduce pressure.</p> <p>If an older system, check for debris or scale in the mouth of the vacuum relief valve and clean if necessary.</p> <p>Use the STR-BV2 Ball Valve on the return line to throttle the flow back to produce more back pressure on the system.</p> <p>Locate Vacuum Breaker on feed line as shown in Fig. 15.1 and put an {STR-EC} End Cap at the end of the top header where the vacuum breaker was previously located.</p>

PROBLEM	CAUSE	SOLUTION
<p>Some of the solar panels are warm to the touch while others are cool to the touch.</p>	<p>There is not equal flow through all of the panels. Warm panels indicate low water flow.</p> <p>If the system is a single row array:</p> <p>If the system is a double row or a single row split feed array:</p>	<p>Be sure filter is clean. Backwash to reduce pressure.</p> <p>The pump may not be providing enough water to the solar system. Check water flow using a flow meter. Increase pump horsepower, if needed, to maintain recommended flow.</p> <p>If there is a suction-type cleaner in the pool, remove it. If this eliminates the problem, use it only when the solar system is off.</p> <p>If there is adequate flow, use the {STR-BV2} Ball Valve on the return line to throttle the flow back to produce more back pressure on the system. This will even out the flow through the panels.</p> <p>If the array contains more panels than the maximum recommended, change the array to a double row or single row split feed.</p> <p>If there is adequate flow, install a {STR-BV2} Ball Valve on the return side of the set of panels that re the coolest to throttle back the flow through these panels and force more through the warmer panels.</p> <p>If any section of the array contains more panels than the maximum recommended, make changes as needed to correct this.</p>

PROBLEM	CAUSE	SOLUTION
There are leaks between the headers at the Plastic Panel Clamps.	<p>PPC Latch is not tight enough to seal the joint.</p> <p>PPC Gasket is not seated squarely in grooves.</p>	<p>Slide Latch farther across connection between top and bottom half of clamp.</p> <p>Disassemble PPC and verify that Gasket is seated properly.</p>
There is a pin-hole leak in one of the riser tubes.	<p>If new installation, a manufacturing defect.</p> <p>Riser tubes rubbing on roof surface.</p> <p>Birds or squirrels have damaged tubes while after seeds or nuts.</p>	<p>Contact distributor for warranty repair information.</p> <p>Contact distributor for free repair kit and adjust spacer bars to prevent future damage.</p> <p>Contact distributor for free repair kit and keep panels free of debris to prevent future damage.</p>
The water coming from the solar system is not as warm as it should be.	<p>The water is flowing too fast through the panels.</p> <p>Seasonal normal operation.</p>	<p>Waterflow through a single panel should be less than 10 gallons per minute. Adjust the Three-Way Valve to bypass some of the water.</p> <p>In the cooler months of the year, the temperature rise through the panels may only be 2°-3°. Use back of your hand to feel the water temperature difference at the pool return inlet.</p>
The Three-Way or Ball Valve will not turn.	Internal parts need to be lubricated or replaced.	If Valve has a grease fitting, turn it clockwise to inject grease into Valve, then turn the diverter past the grease fitting to spread the grease. If the grease fitting is dry, fill it with silicone grease. If there is not a fitting, disassemble Valve and lubricate with silicone grease. Replace worn or broken parts.
The automatic control system is not working.	Various	Consult the manual for the automatic system you have.

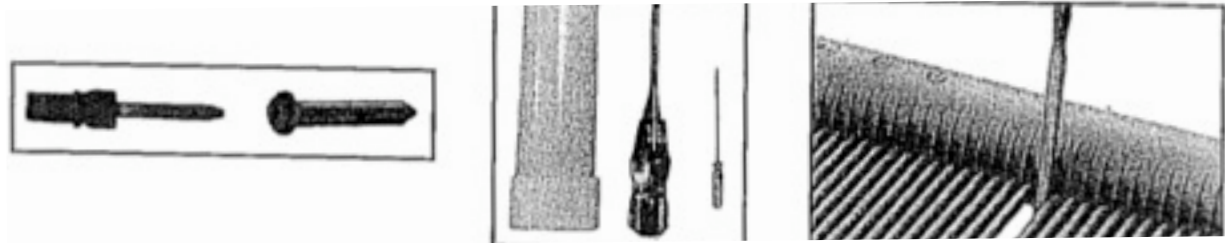
# REPAIR PROCEDURES

The SOLARHOT Solar Collector is a very durable product, but there are a few steps you should take to protect its longevity:

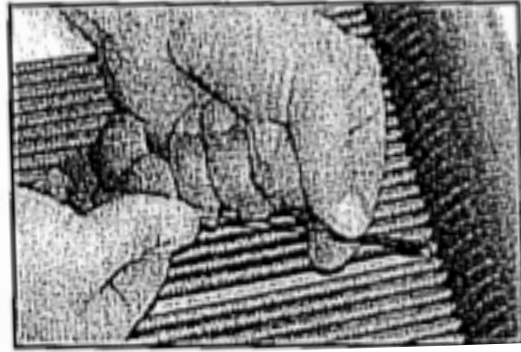
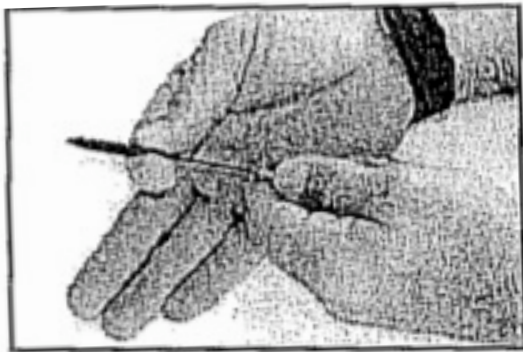
1. Try to avoid walking on the collectors. If you cannot avoid it, always wear soft-soled shoes.
2. Do not install SOLARHOT Collectors during temperatures lower than 35 degrees.

If any of the riser tubes in a SOLARHOT Collector should become damaged for any reason, it can be repaired using the {STR-RTK} Repair Tool Kit and {STR-RP} Repair Plugs. The Repair Tool Kit consists of a 1/4" Repair Chisel, an Insert Tool, and a PVC carrying case. Follow instructions for repair:

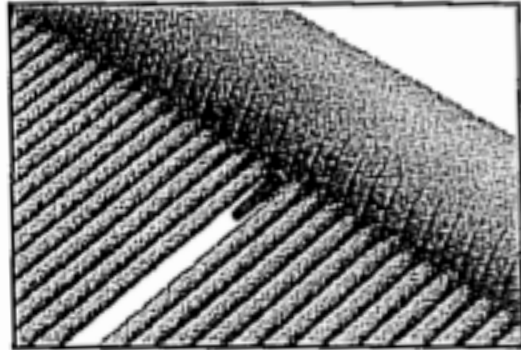
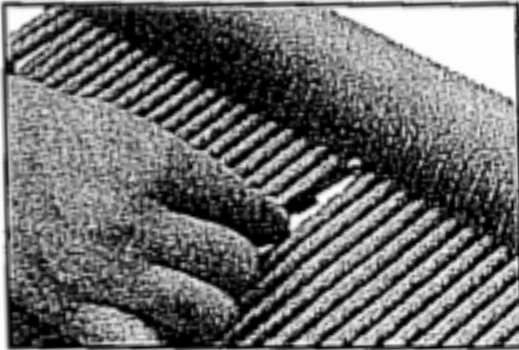
1. Utilizing the Repair Chisel, cut the damaged riser as close as possible to the header, carefully avoiding damaging adjacent risers. The sloped side of the Chisel should face away from the header.



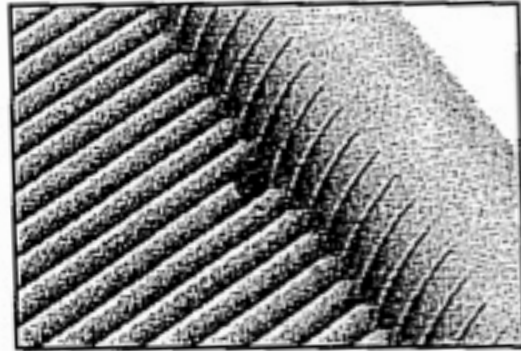
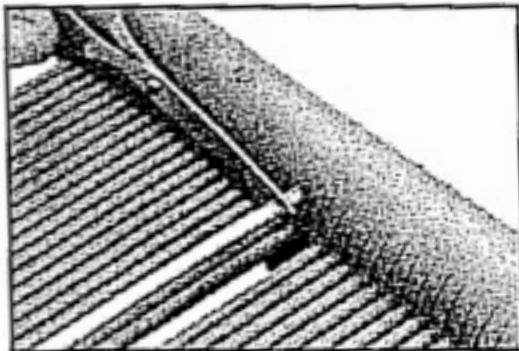
2. Spray the shaft of the Insert Tool and the rubber insert with silicone spray. Insert the Insert Tool into the rubber insert. By holding the rubber insert with one hand and the Insert Tool with the other, gently stretch the rubber insert. As you do, push the rubber insert all of the way into the header's opening. Stretching the rubber insert first allows for easier insertion into the header.



3. Pull out the rubber Insert Tool. Using your fingers or a channel-lock pliers, push a poly-insert into the rubber insert as far as you can.



4. Cut the riser tube to the desired length and slide it over the stub of the poly-insert for a straight, eye-pleasing fit.



5. REPEAT Steps 1-4 for the other end of the riser tube at the opposite header.

# OPERATING AND CHECK OUT PROCEDURES

## Before you run water through the system:

Allow the cemented fittings adequate time to dry per manufacturer's directions.

Verify that the Check Valves, Control Valves and Vacuum Breaker are installed properly.

Verify that all Plastic Panel Clamp Clips are tight.

Pressure test the system as described on page X.

Verify that all Lag Bolts are secure and that adequate silicone was used to prevent any roof leaks.

Be sure all collector riser tubes are snapped into the spacer bars (except where they go around obstructions).

Be sure that collector riser tubes are NOT rubbing on the roof surface between spacer bars. If they are, adjust spacer bars as needed to prevent this or a hole may develop in the riser tube.

Be certain that the system will automatically drain down when the pump is shut off or that enough manual drain valves have been included.

Verify that all pipe runs are properly supported with G-Clamps.

## TURNING THE SYSTEM ON

Turn the pool pump off.

Turn the Three-Way Valve so the "closed" indicator points toward the pool return side of the valve.

Be sure that the Two-Way Valve on the feed line is open.

Turn the pool pump on.

Set the pool pump timer, if used, so that the pump will run when sun is shining on the solar collectors. This is usually between 10:00 a.m. and 4:00 p.m., but this will vary with geographic location and time of year.

When the solar system is running, you should notice:

A slightly higher pressure reading on the Pressure Gauge.

At midday, if the sun is out, warmer water should be coming into the pool. This water should be 3\*-5\* warmer than the pool temperature. Use the back of your hand to better feel the difference in water temperature.

During the cooler months of the year it is essential that the pool surface be covered at night with a "pool blanket" to maintain a comfortable water temperature. Low nighttime temperatures can lower the water temperature more than the solar system can recover during the day.

## TURNING THE SYSTEM OFF

Turn the pool pump off.

Turn the Three-Way Valve so the "closed" indicator points toward the solar feed side of the Valve.

If isolating the collectors, close the Two-Way Valve on the feed line after you are sure all the water has drained out of the collectors and plumbing.

Turn the pool pump on to filter the pool as needed.



# THAT'S ALL THERE IS TO IT!

You have installed a SOLARHOT Solar Pool Heating System that has been tested and proven worldwide for quality and reliability. If you run into any problems with your installation or have any future problems, call your SOLARHOT representative.

BE SURE TO COMPLETE THE OWNER'S REGISTRATION FORM OF THE WARRANTY AND MAIL IT BACK TO SOLARHOT TO REGISTER YOUR INSTALLATION.

CONGRATULATIONS! If you have carefully followed the steps in this manual, you now have an efficient, professional-looking SOLARHOT Solar Pool Heating System.