

INSTALLING DCC DECODERS

By Jerry Hansz

1. BACHMANN SPECTRUM C40-8W:



I have been installing Digital Command Control (DCC) decoders in my HO scale locomotives. Some installations have been easy (plug-in), and some have been more difficult. I had exhausted the more logical choices for conversion.

I looked long and hard at the traditional Athearn locomotives. The motor installation and current draw make them less desirable. I did install a replacement motor in my GP60, which involved milling the chassis to fit the longer motor, and then installing the decoder. Works okay!

I have 3 Bachmann Spectrum C40-8W locomotives which run fine on DC, and I very much wanted to convert them to DCC. When I opened ATSF 802, I found the split chassis filled the superstructure very full. It didn't look promising. But I'm stubborn, so I opened the locomotive again, and separated the chassis halves. Just maybe!



The chassis halves pick up power from wipers on each side of the front and rear trucks, and transfer it to wipers on the motor. If I remove the motor wipers, I can solder the motor leads from an NCE D13SR decoder to the motor terminals. Okay!

What about space for the decoder and wires? I clipped the front headlight leads, and removed the lighting circuit board from the shell. A measurement of 1 1/8" from shell bottom to inside top should provide sufficient clearance for the D13SR.



How to attach the truck leads from the D13SR? I decided to drill and tap each chassis half for 2-56 brass machine screws. To the drill press!



That went pretty well, except for violating the measure twice, drill once practice!

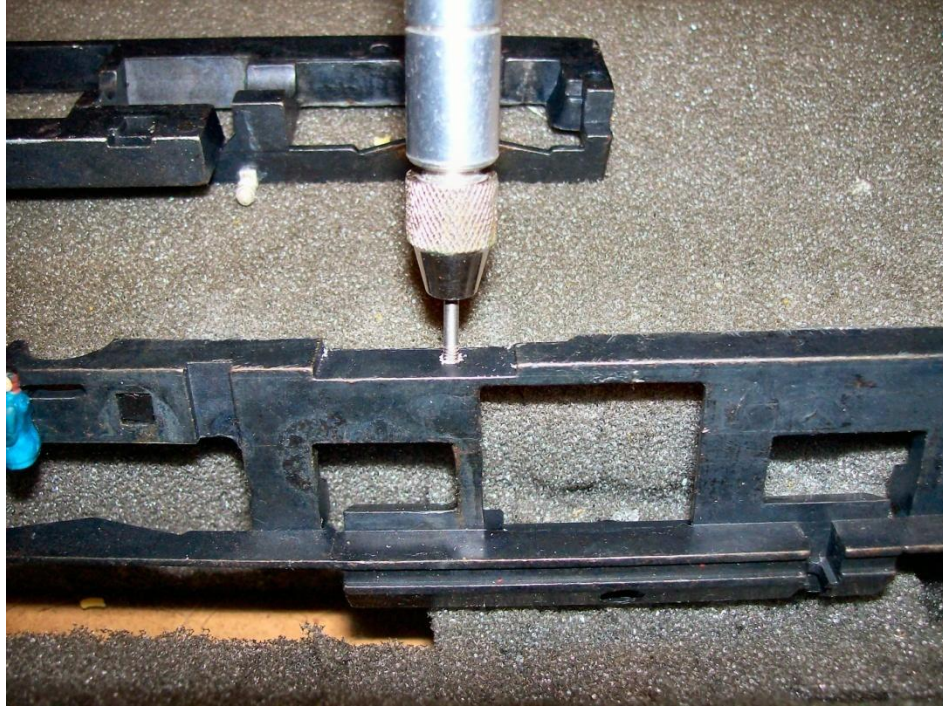

I tapped the two correct holes. As usual, I didn't lubricate, so the tap got stuck in one hole. Out came the vise grips! Didn't break (whew!).

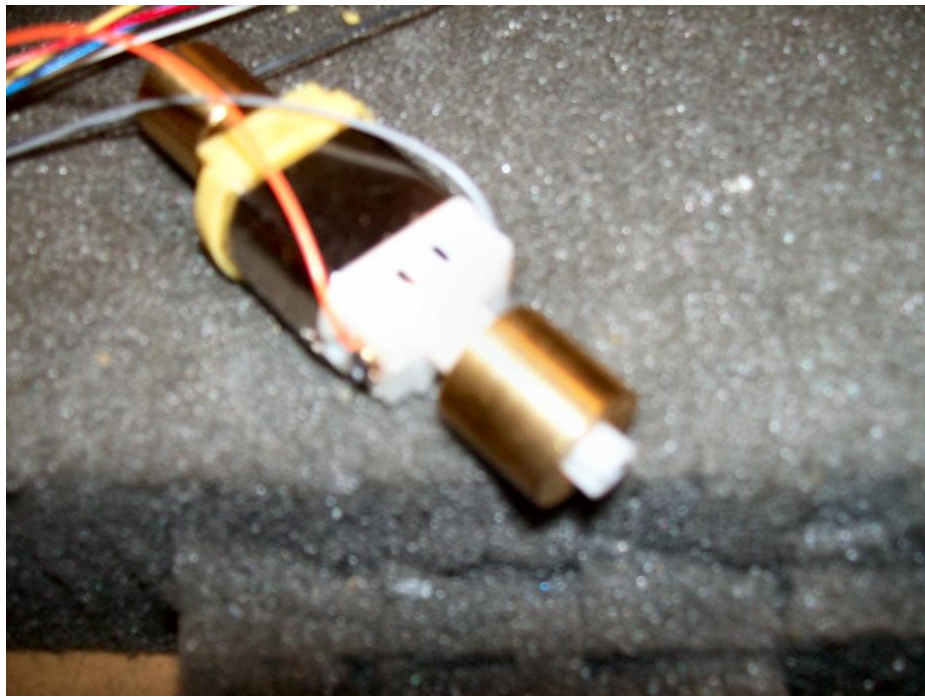

After cleaning up filings, I soldered the orange and gray motor leads to the motor.

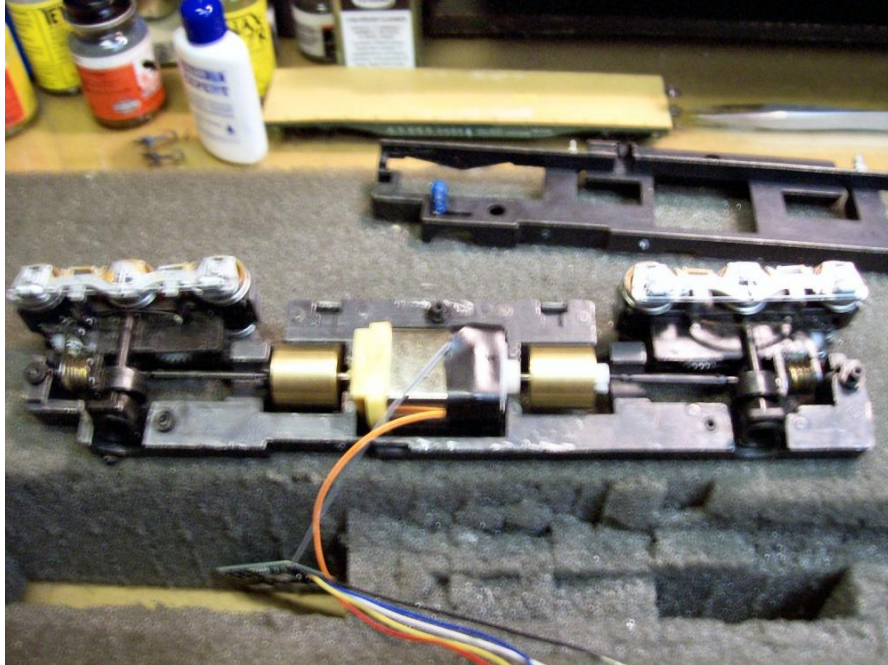

I laid it into one half-chassis, fed the leads out the top, and reassembled the chassis.

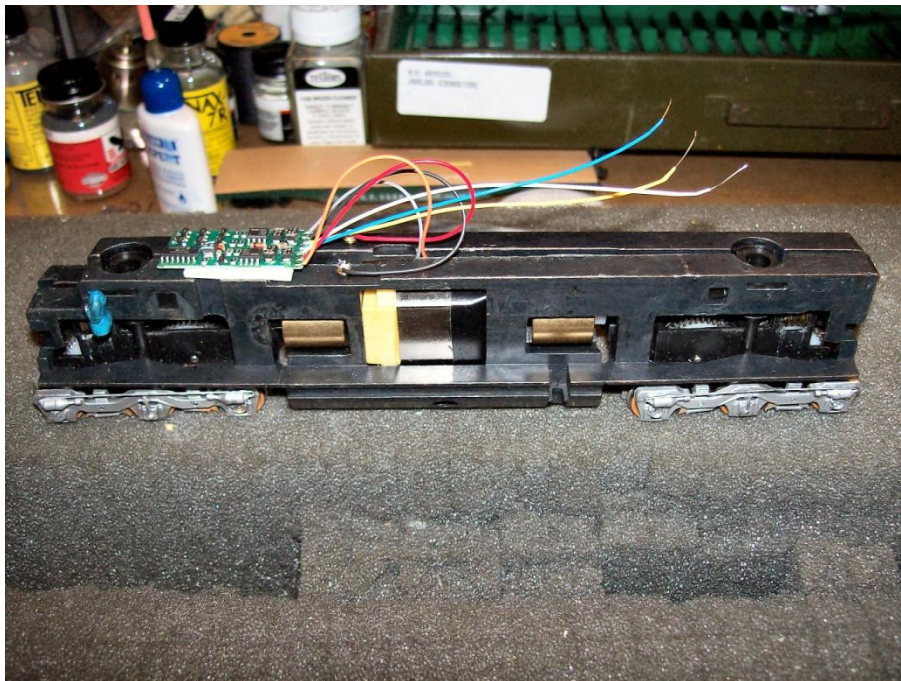

I inserted brass screws in the tapped holes, and soldered the red (right) and black (left) truck leads to the screws.

Double-sided tape secured the D13SR to the top of the chassis. At this point, I went to the programming track to see if the darned thing worked! It did, except I picked the wrong motor leads, so had to program it to run reversed. No sweat!

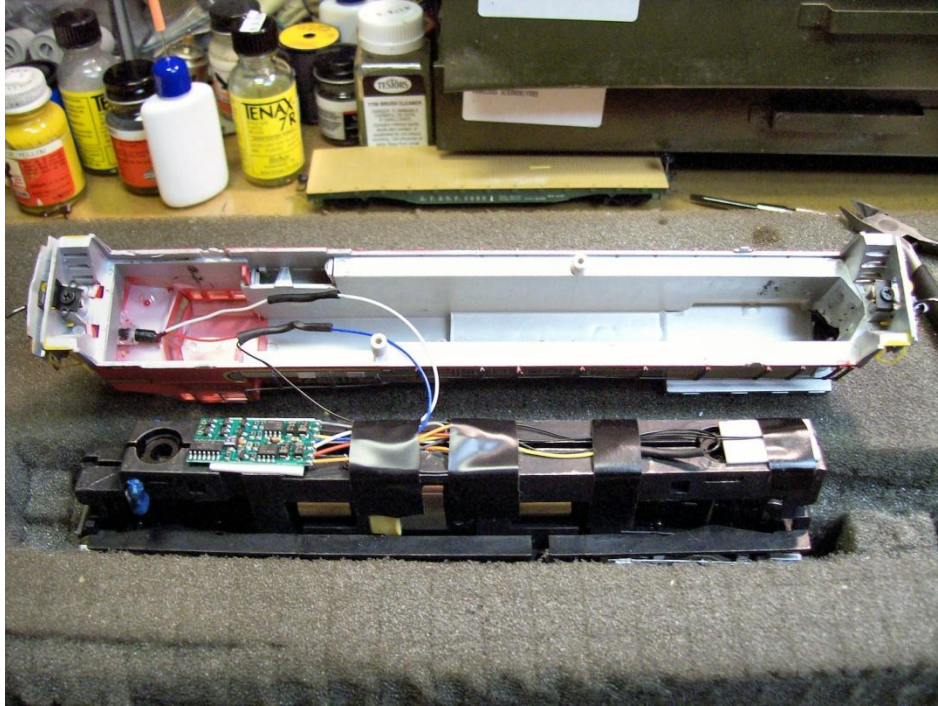

I then wired the lights, taped everything down, and reassembled the model. Onward and upward! It runs nice.

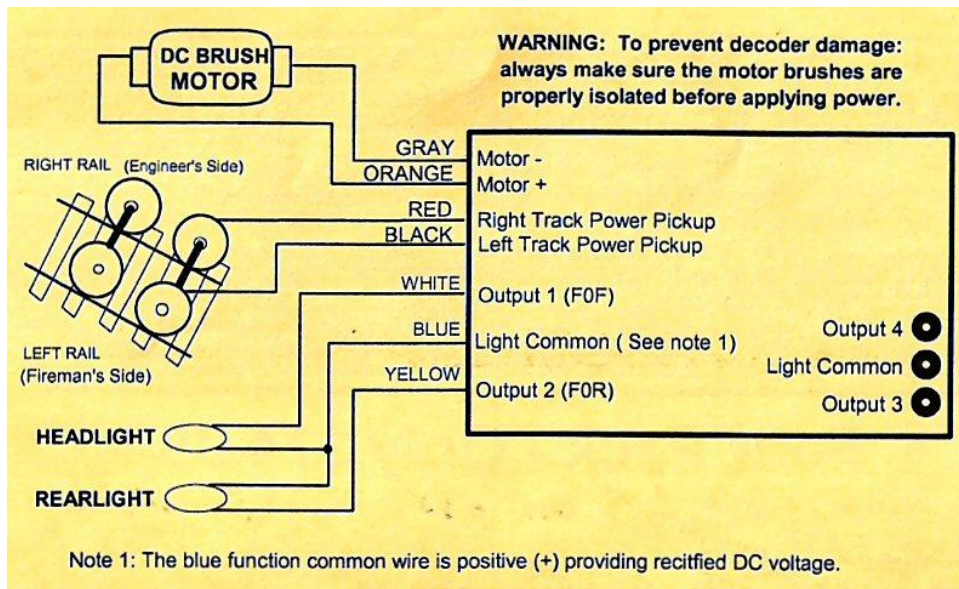

North Coast Engineering (NCE) D13SR Decoder Wiring Diagram.

Note: When I programmed the decoder to run reversed, the lights also reversed, so I swapped the white and yellow wires to correct the goof-up.

After success with #802, I decided to try my luck with the second C40-8W, #854.

I opened the unit. No headlights in this one, so installed two 12V 40MA bulbs. Separated the chassis halves and marked the holes for the brass screws. This time I paid attention to the motor contacts, and marked the right and left side terminals (right side goes down).

At the drill press, I drilled the holes at the CORRECT locations, went back to the workbench and tapped the holes. (no jammed tap this time!) The decoder leads were soldered to their correct locations, and the chassis was reassembled. The D13SR decoder was secured, wiring was taped down, and the lamps were installed into pieces of shrink tubing that had been cemented into the locomotive shell.

The locomotive was programmed with no problem. Here are #802 and #854 parked at Talheim:



The following day I did #834. All went well.

2.INSTALLING A DCC DECODER IN THE PROTO 2000 E8m:

When I decided to install a DCC decoder in my Life-Like Proto 2000 Santa Fe E8m passenger diesel, I wasn't sure how to handle the Mars Light hookup. Queries to Walthers produced little information. When I checked the Digitrax site, I found a detailed narrative on the conversion, using their DH163D decoder.

I opened the locomotive and checked the wiring layout. It matched the description in the narrative. I then drew a diagram showing the original wiring, and the changes. That diagram is attached.

My usual procedure when in doubt is to let it lay for awhile (coupla weeks, as a matter-of-fact). Finally I decided to take the plunge.

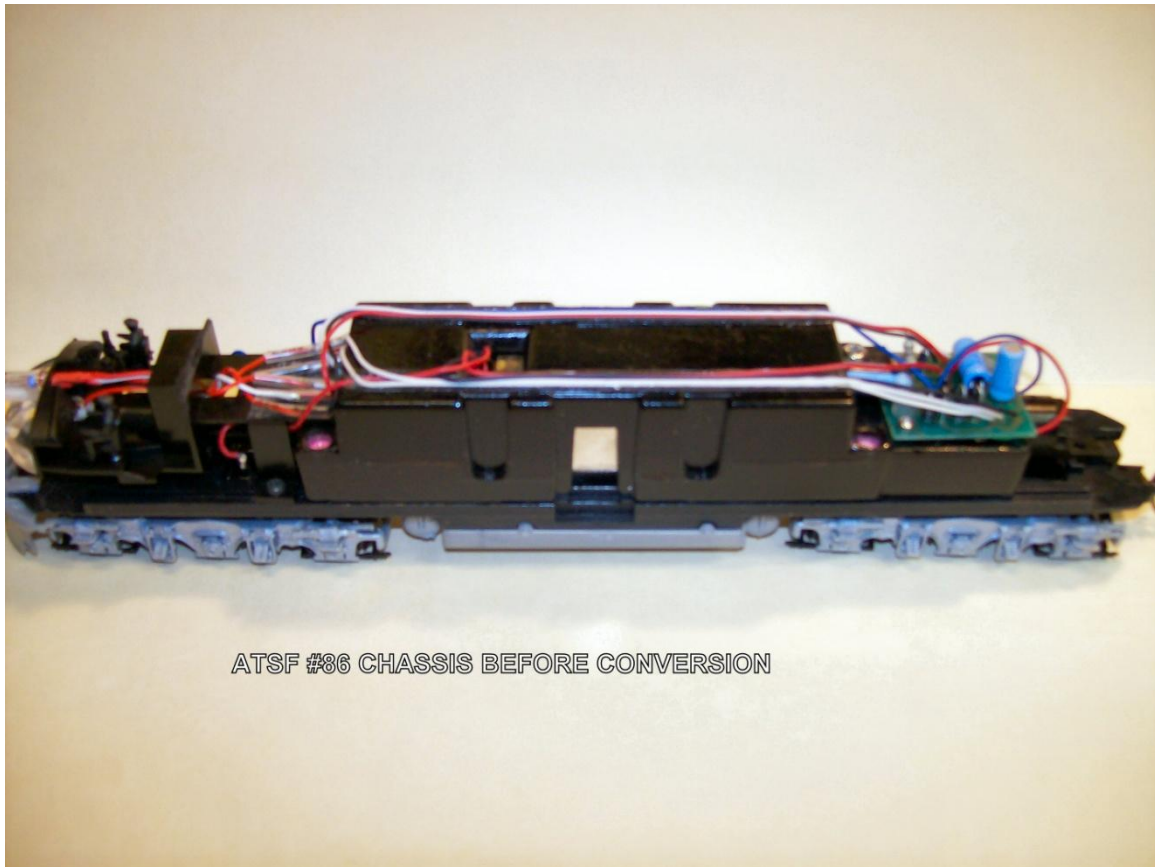

As the above photo shows, the weight fills the superstructure, making wiring an adventure. I cut and soldered, with the resulting mess below:

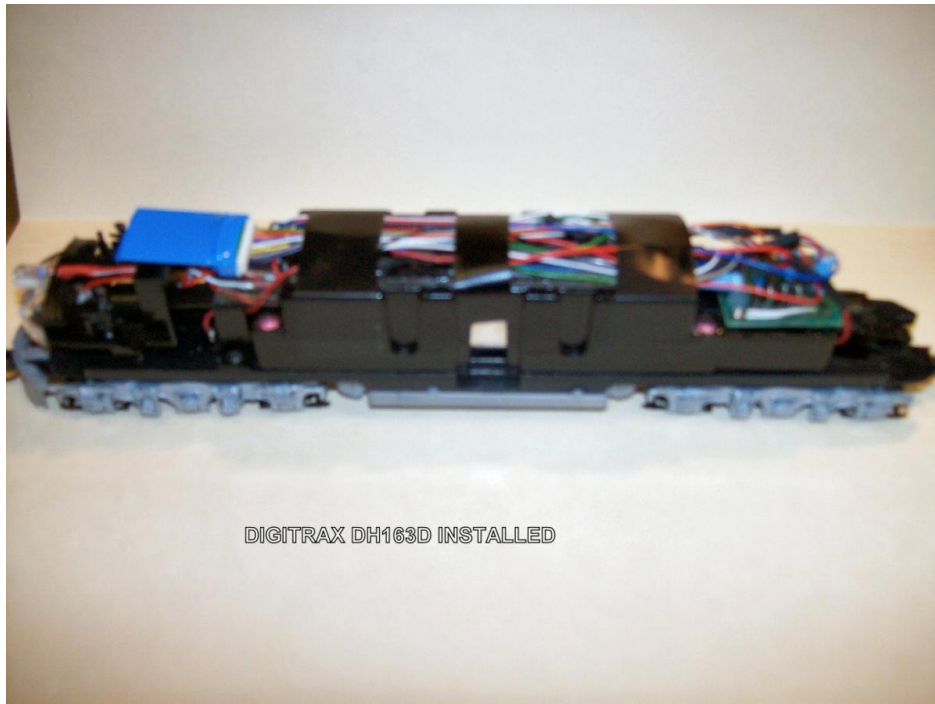

After wiring, I placed the locomotive chassis on the programming track, and programmed long address 086. It worked! F1 (or bell) turns the Mars light on. With my shoehorn, I persuaded the shell to fit. The next photo shows #86 in the Chestnut Hill Engine Terminal.



3. DCC FOR A BACHMANN FM H16-44:

I had a Bachmann Fairbanks-Morse H16-44 that 'needed' DCC. I also had a Digitrax DZ143PS decoder lying around. Well!

The H16-44 has a split frame; right side to right rail, left side to left rail. The motor picks up power from the frames with wipers. There is very little room on top of the frame. The DZ143PS decoder is small for use in Z-scale locomotives, but will handle 1.25 amperes. This should be possible.

I disassembled the locomotive:



To get power from the frames to the decoder, I drilled and tapped 2-56 holes in the top of each frame, and inserted 2-56 brass round-head screws. Where the screws protruded into the motor cavity, they were trimmed flush with a motor tool.

The wipers were cut off the motor, and short wires were soldered on. The wires will connect to the motor leads of the decoder.

The trucks and motor were replaced, and the frames were fastened back together. Some of the small plastic spacers were broken, so I replaced them with plastic screws, making sure the washers were correctly placed between the frames. DON'T NEED ANY SHORTS HERE!



The DZ143PS comes with the small NMRA 8-pin plug installed. I cut the leads close to the plug, and soldered them to the frame screws and motor leads, as shown in the wiring diagram:

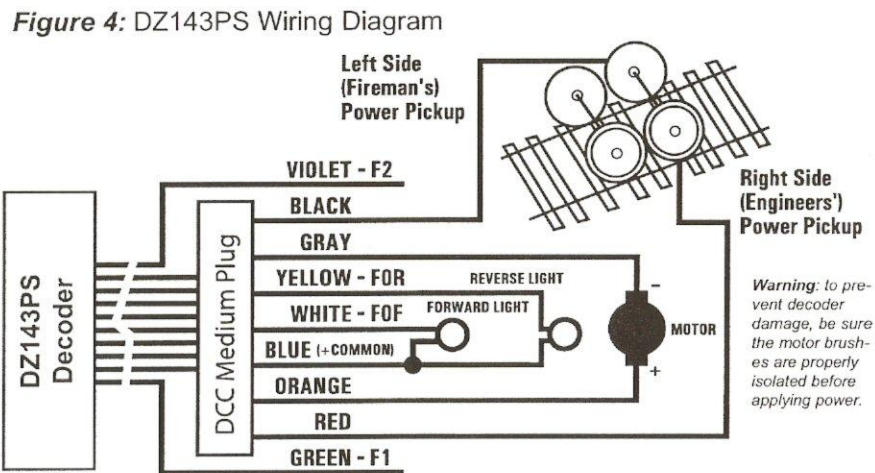

The violet and green leads are not used, so they were cut close to the decoder. The orange wire was soldered to the yellow motor lead, the gray wire to the green motor lead, the red wire to the right side frame screw, and the black wire to the left side frame screw. 12 V 30 mA lamps were connected to the blue common, white front, and yellow rear leads. All connections were protected with shrink tubing.

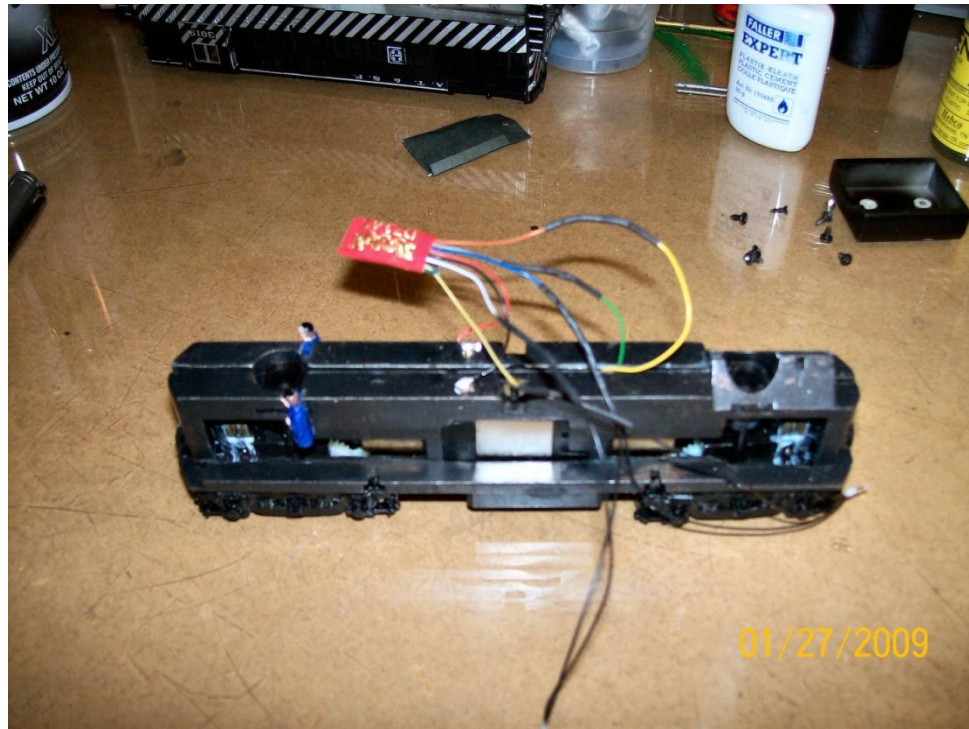

With all wiring completed, it was time to hit the programming track.

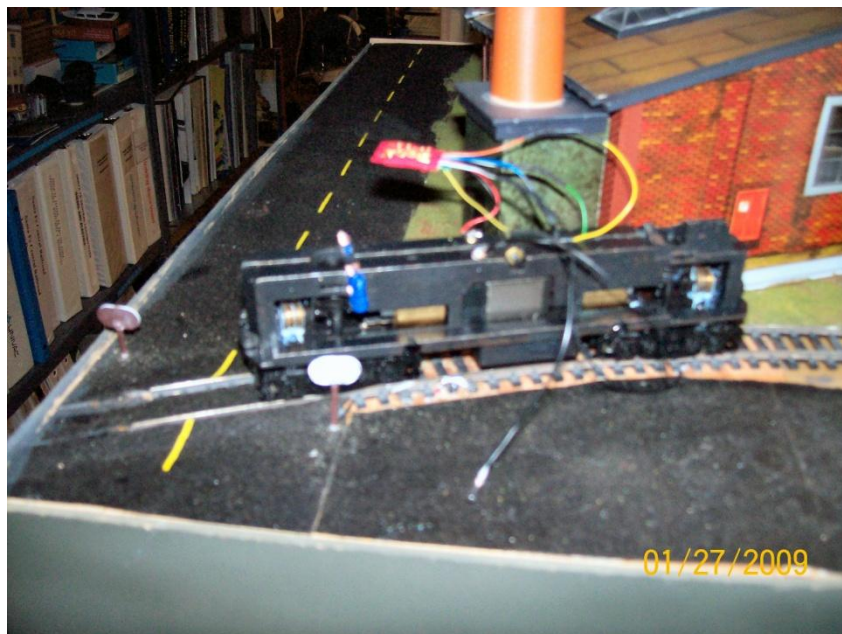

The decoder programmed easily. “This is too easy”, I thought. “But, let’s try it out on the main”. The lights worked, and the locomotive started easily, in reverse! Back on the programming track the direction CV was changed. (I, once again, had the motor leads reversed!) On the main, everything worked correctly, so the decoder and wires were secured with electrical tape, and the lights were inserted in their respective places.

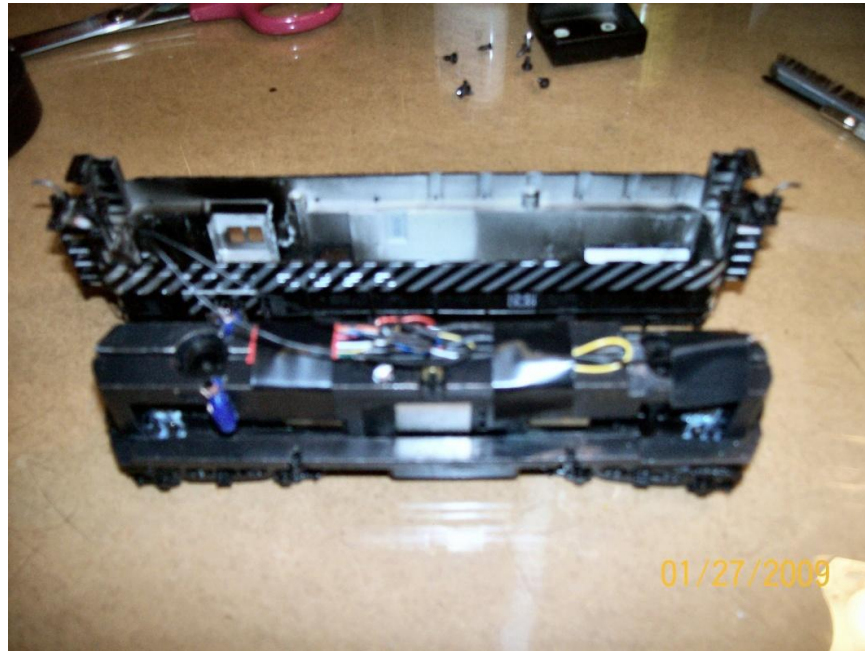

With the shell reinstalled, the locomotive performed flawlessly, and is now at the Engine Terminal, ready for service.



4. MORE ADVENTURES IN DCC :

My ongoing DCC odyssey continues with some old Athearn F7As I acquired from Bob Foltz at various swap meets. I like the detail and weathering. Each except #44 (which I already had) has a can motor, so I decided to put decoders in them.

The F7s had a large weight, which takes up much of the interior of the shell.



ATSF #44 still has the original Athearn motor. Note the weight.



ATSF #268 is a Bob Foltz modification with a Mashima can motor.

I started the installation with #202. I had to repair a loose flywheel and remount the motor with silicone caulk, which is taking forever to harden! So, I switched to #268.

In order to preserve the weight, I cut off the protrusion, secured a .060" strip to the top of the weight with super glue, fastened a NCE D13SRJ decoder to the bottom of the strip with double-sided tape, and wired the thing up.

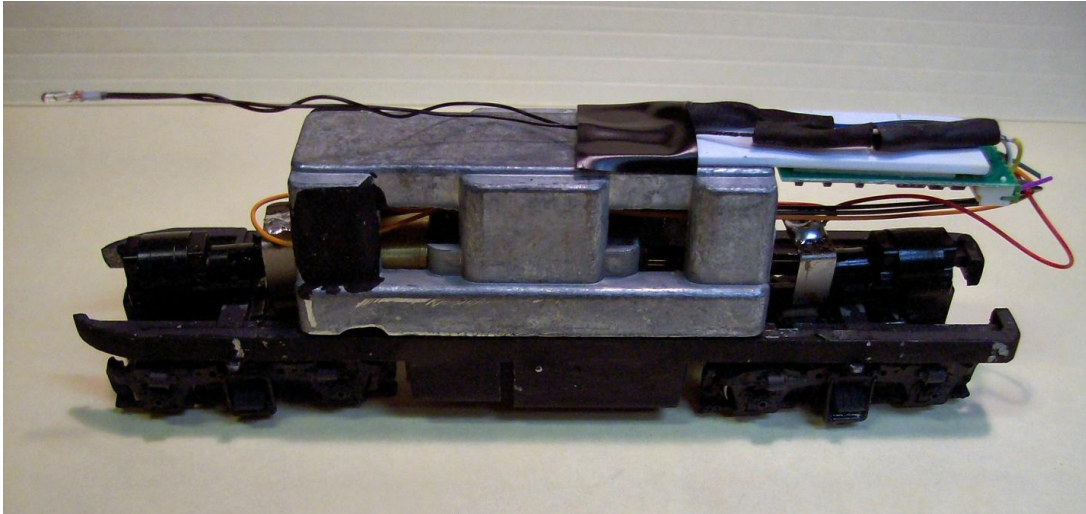

It worked fine, until I tried to put the shell on. NO CLEARANCE! So I removed the decoder, and tried to remove the strip from the weight. Really stuck! I finally discarded the weight, stuck the decoder to the inside top of the shell, and finally had a working model! Wonder how much it will pull?

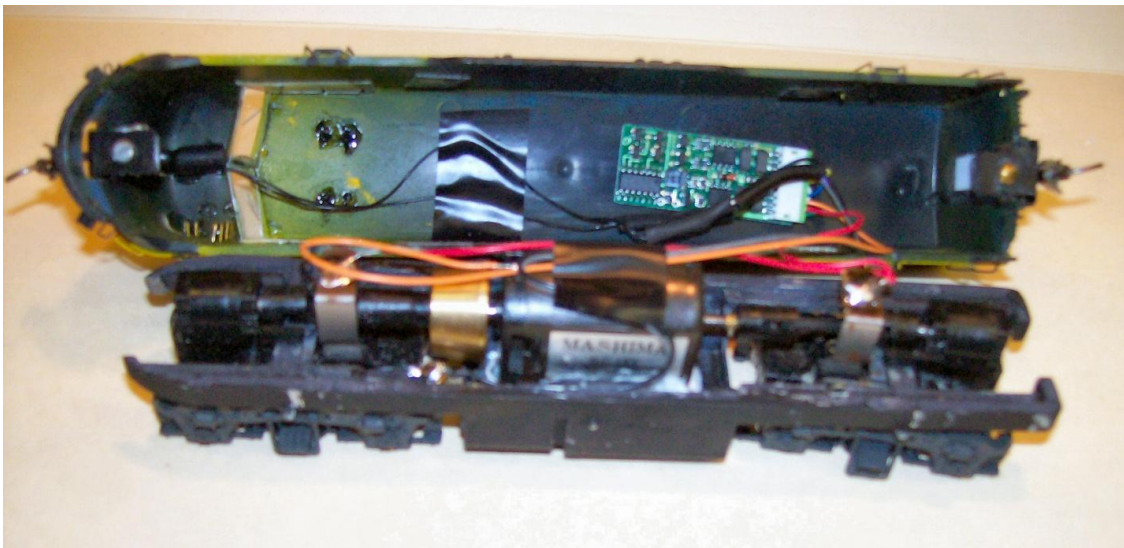

I'll do the same drill on ATSF 44, ATSF 44C, and ATSF 202. I have a spare can motor for ATSF 44, but may keep the Athearn motor. I've used them on other locomotives, with okay results.



ATSF 44C



ATSF 202

I haven't given up on using the weights. I'll have to remove the well glued styrene and remove some of the top for clearance, or route wiring under the weight. There appears to be room between the can motor and the inside of the weight. We'll see. The locomotive with the Athearn motor will be the biggest problem.

5. INSTALLING A DECODER IN A BACHMANN PLUS SD45:

I had a good running Bachmann Plus EMD SD45 locomotive I had purchased in June 1996. This seemed like a good time to install a DCC decoder. The locomotive has a split chassis which picks up power from the trucks and feeds it to the motor through wipers. The chassis takes up quite a bit of space in the shell, so fitting a decoder could be a problem. I pulled the shell, and took a look. Tight!



I've done this type of chassis before. Didn't want to mill the thing! The Digitrax DZ143 decoder can handle 1.25 amperes, is quite small, and should fit on top of the chassis behind the raised portion around the motor. So – time to 'unsplit' the chassis. I used caution so as not to damage the insulators. I'd had that problem before. The four screws came out fairly easily, with no damage.





I opened the chassis, keeping all parts oriented properly. I marked the motor contacts with a pencil. Bottom goes to the left, top to the right. Small parts such as the truck supports, screws, and insulators from the chassis bottom were carefully laid out.



To connect the decoder track wires to the chassis, I drilled and tapped 2-56 holes in the forward top of each chassis half. Brass 2-56 round-head screws were secured in the holes.

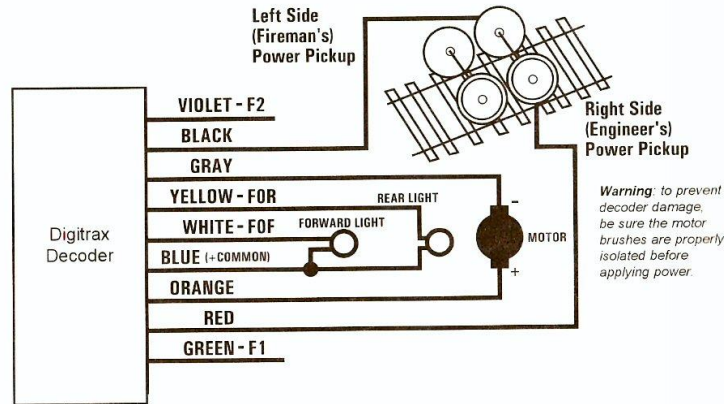

I prepared the DZ143 by cutting the green-F1 and violet-F2 wires close to the decoder (don't need the extra functions), and stripping and tinning the other wires.

After cutting off the motor wipers, I soldered the orange (right) and gray (left) wires to the motor brush caps. I then placed the motor in the chassis halves, making sure the wires didn't get pinched, and reassembled the chassis.



The DZ143 decoder was secured with double sided tape, the red (right) and black (left) wires were soldered to the 2-56 brass screws, and 14 volt lamps were soldered to the blue (common), white (front), and yellow (rear) decoder wires. Shrink tubing protects the joints.



After a trip to the programming track, and a test run on the main, the shell was reattached, and #5614 is ready for service!

6. INSTALLING SOUND DECODERS IN STEWART FT DIESELS:

I had two great running Stewart FTA and FTB diesels with DCC decoders installed in the A-units. Since space is very cramped in the powered A-units, I had installed Digitrax DZ123P decoders. I decided to try Soundtraxx DSD-100LC sound decoders in both sets.

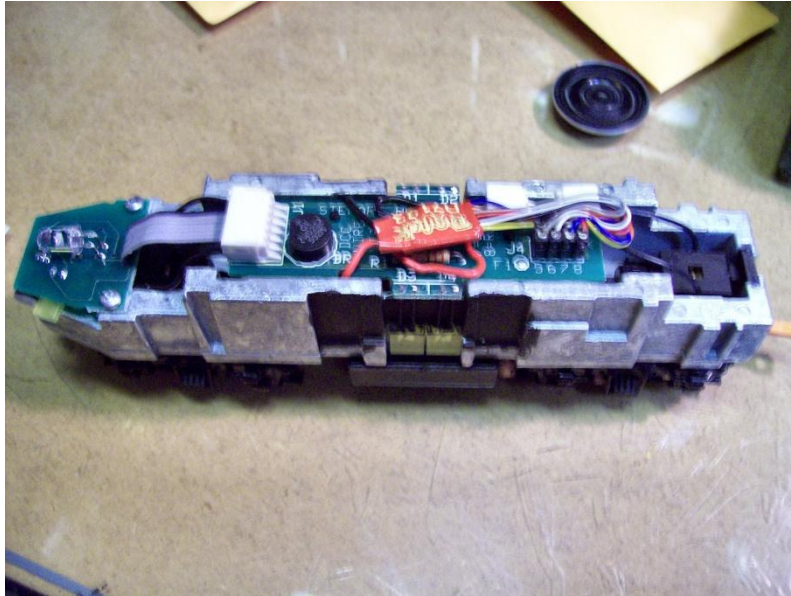

Since the A-units had insufficient space for the sound decoders, I left the DZ123Ps installed, and put the sound decoders in the unpowered B-units.

The B-units had plastic brackets in the center of the chassis, probably for mounting a motor. They would interfere with the decoder and speaker.



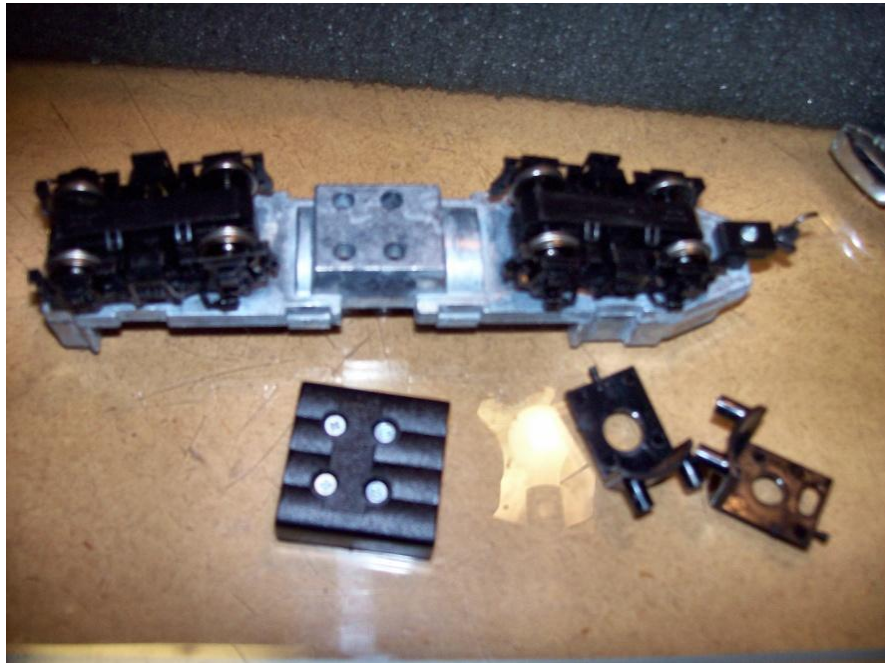

I removed the brackets, clipped off the upper portion, and reinstalled them (they're necessary to hold the fuel tank cover screws).



The fuel tank cover was re-installed

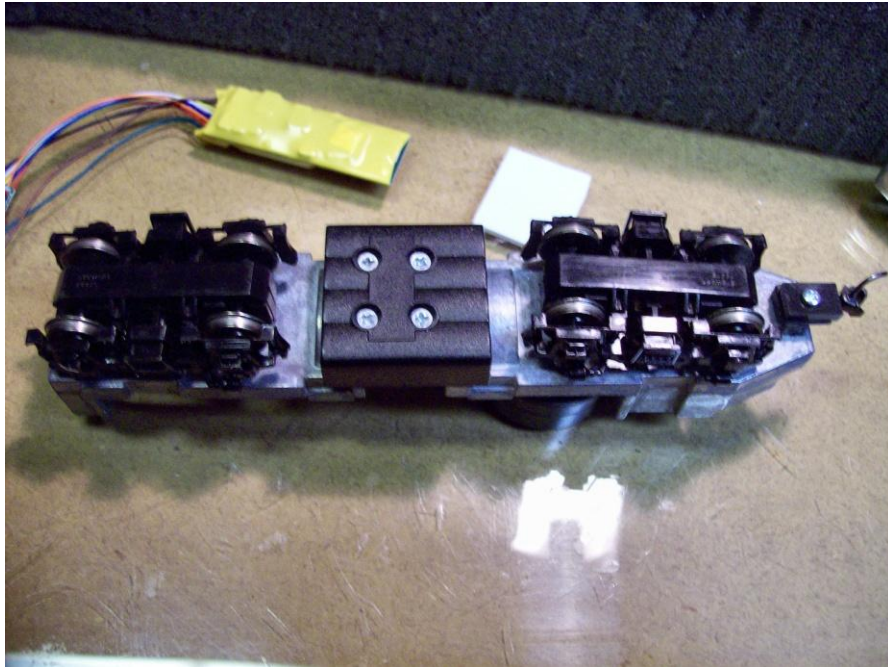

This left plenty of room for the speaker enclosure and the decoder.

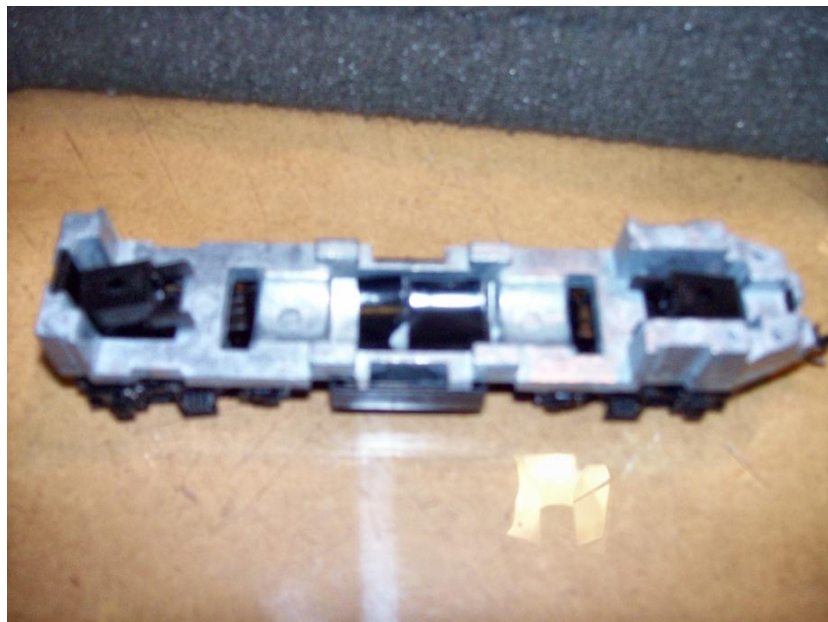

I filed a slot between the two speaker enclosure rings, to permit inserting the speaker wires. The enclosure was then secured to the chassis with double sided tape. It took four layers to clear bosses on the chassis.

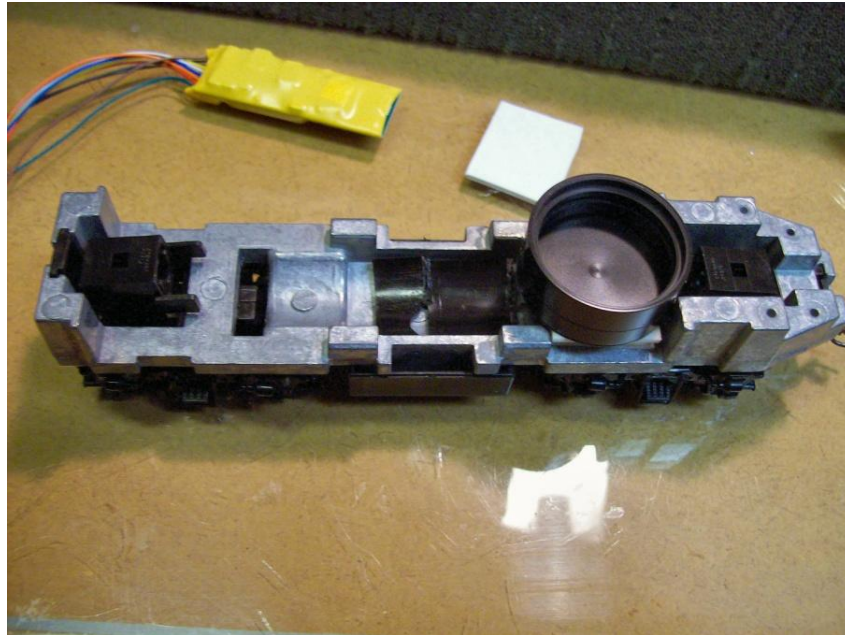

A piece of .060 inch styrene was super glued to the chassis to provide mounting for the decoder.

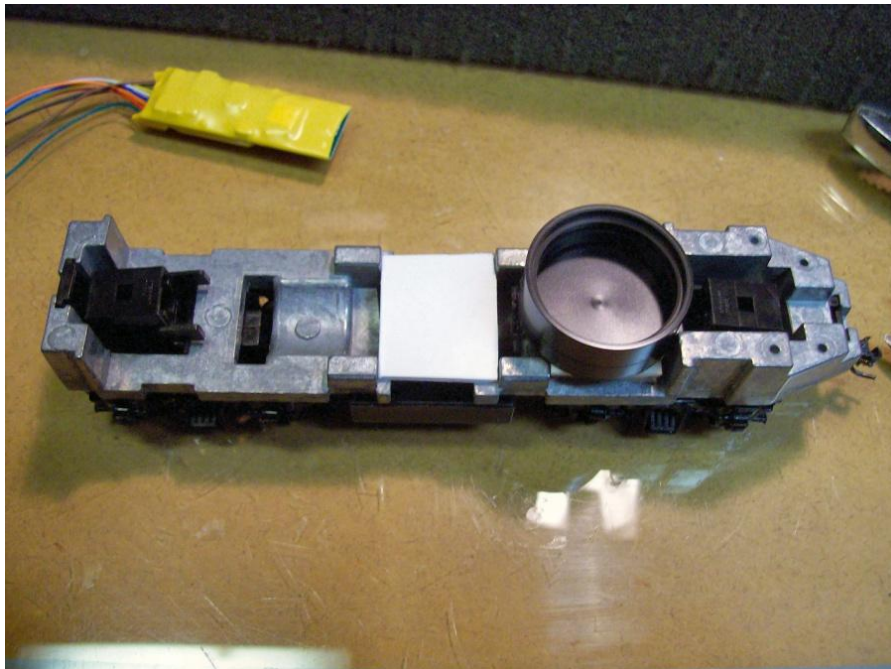

The DSD-100LC decoder came with the NMRA medium eight-pin plug, which I didn't need for this installation. I cut it off, stripped and tinned the red, black, green, and brown wires.

Before installing the decoder, I programmed it on the programming track, since the A-unit decoder was already programmed. It is often difficult to read CVs of sound decoders on the programming track, and this prevented messing up the A-unit decoder.

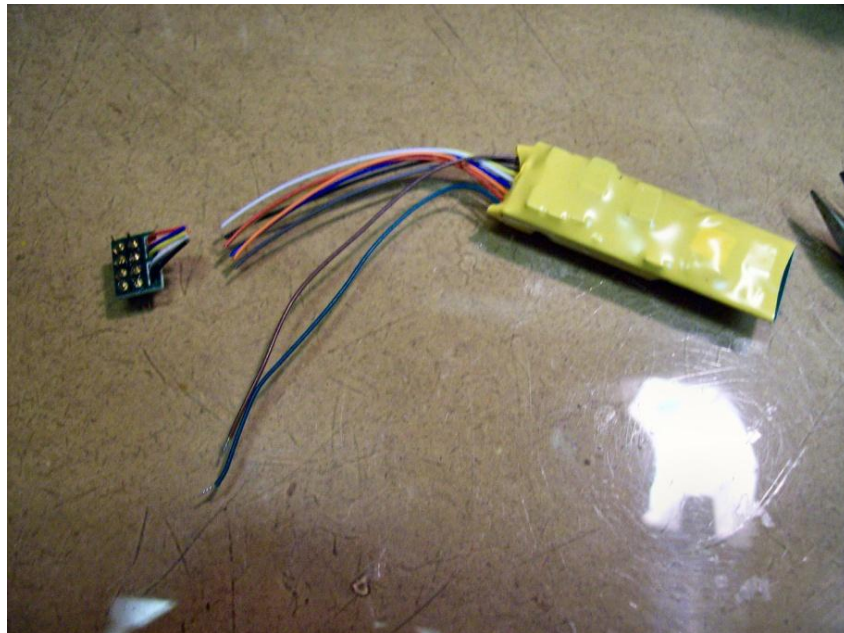

The speaker and capacitor were wired to the decoder. All joints were protected by shrink tubing.

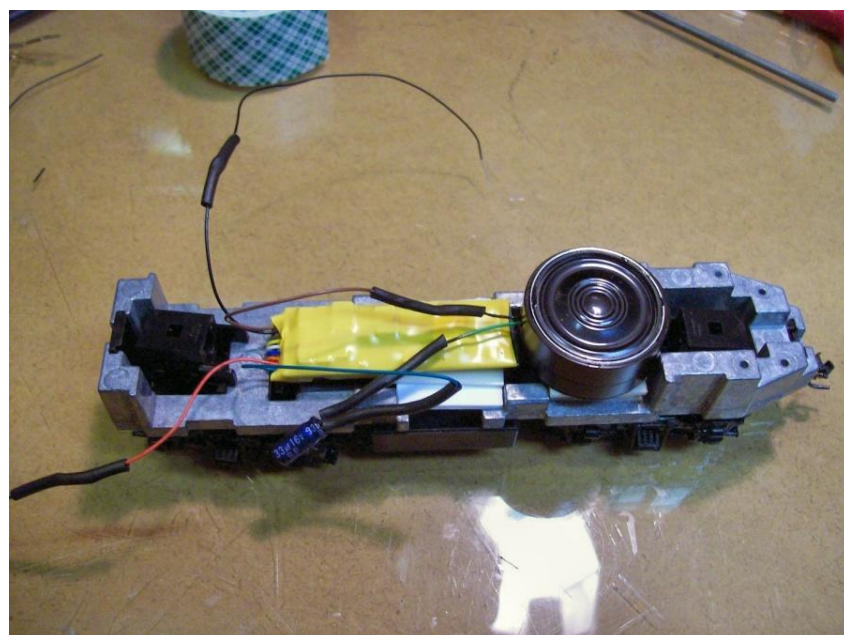

A piece of electrical tape kept the wires and capacitor in place. The red (right track) and black (left track) decoder leads were lengthened to reach the A-unit. All other decoder leads were tucked into a piece of shrink tubing and placed under the decoder, so as to clear the trucks during operation.

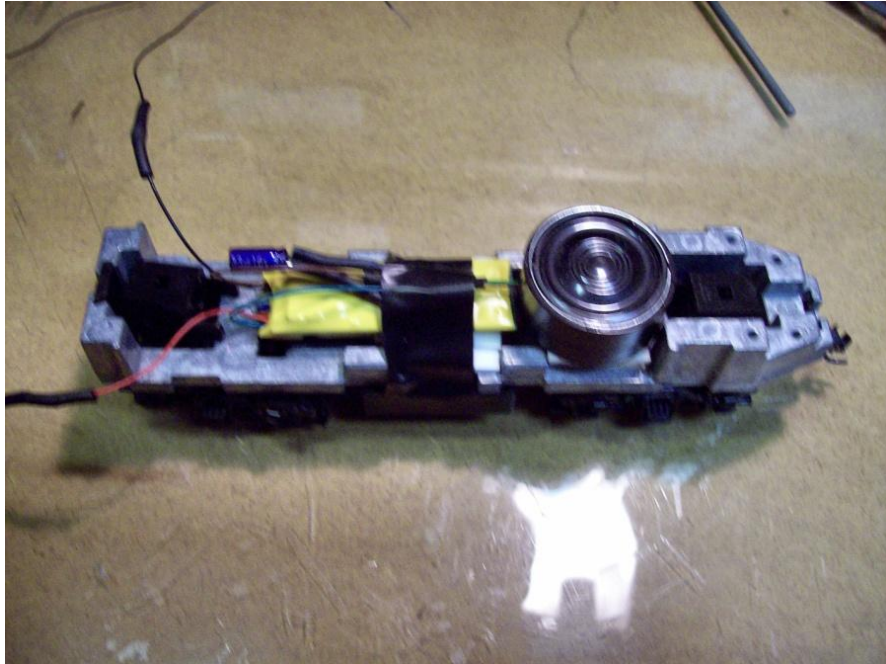

It was now time to provide wires from the A-unit right- and left-side trucks to a socket for the B-unit decoder wires. The insulation was opened on the truck leads, and wires were soldered to them.

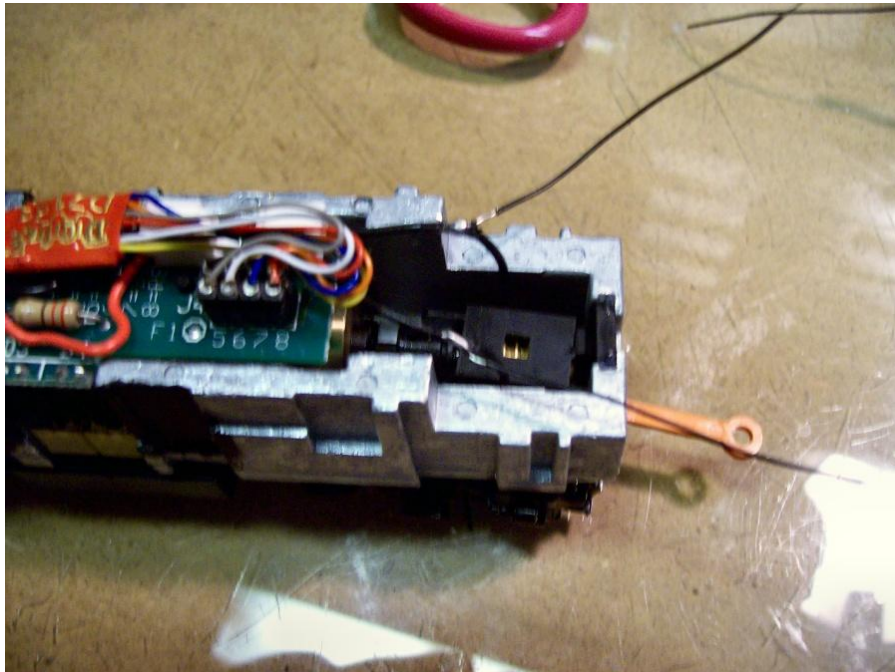

A socket was cut from a piece of a computer socket I had laying around, and soldered to the truck lead extensions. Again - shrink tubing.

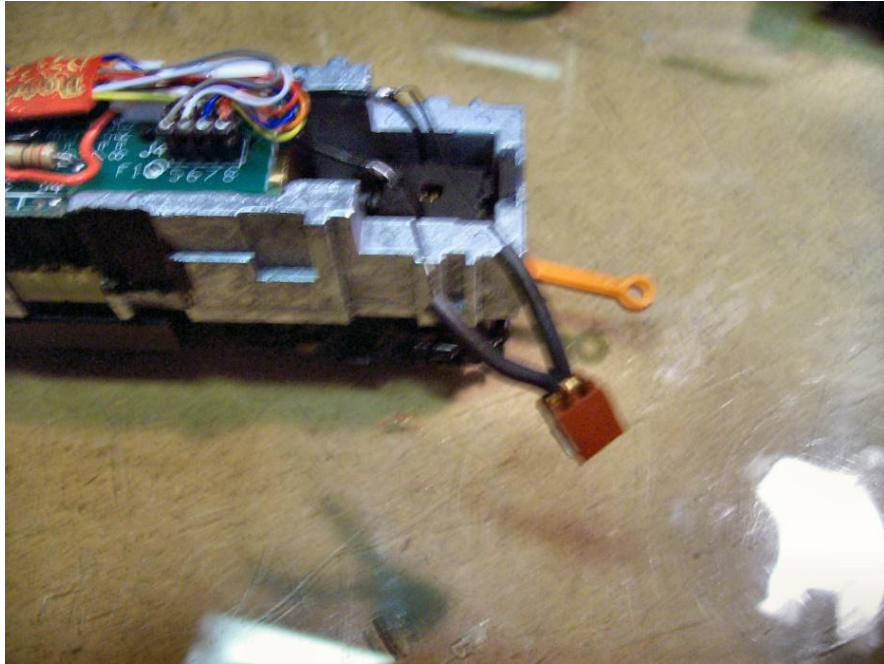

Two surplus pins were soldered to the leads from the B-unit decoder.

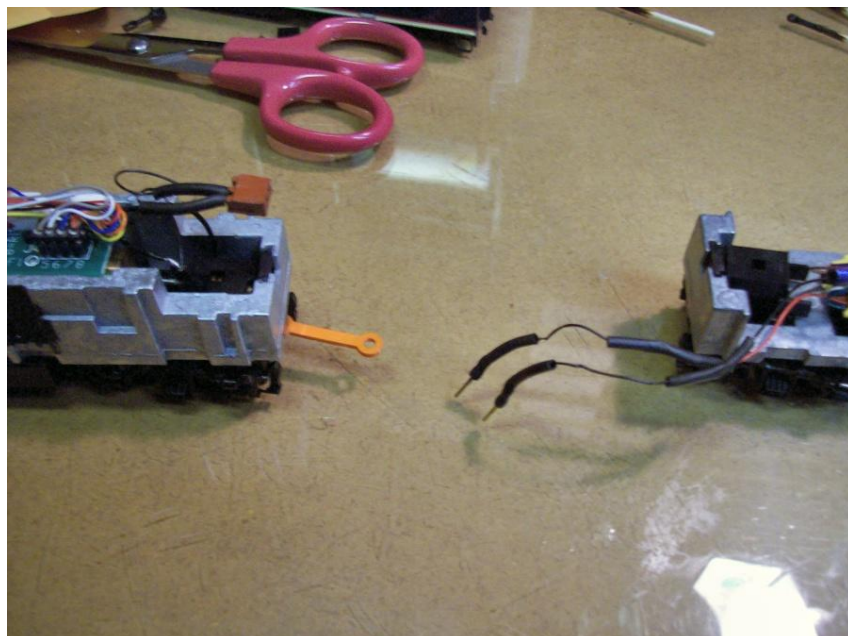

I fed the leads through enlarged windows in both shell ends and connected them to the A-unit socket, red to right track, black to left track. I installed the shells.

Both locomotives were test run successfully. Here they are posed in front of the Talheim Passenger Station.



FT #108 idling with headlamps lit.



FT #172 rests with headlamps lit.

Parts used for the installation:

- Soundtraxx DSD100LC sound decoder for first generation EMD diesels.
- American Hobby Distributors 8 ohm 0.1 watt 1.10 inch diameter speaker.
- American Hobby Distributors 1.10 inch enclosure for 1.10 inch speaker.
- Shrink tubing to protect solder joints
- Scrap small wire to extend leads
- Homemade 2-wire socket and matching pins
- Scrap styrene for mounting the decoder
- Double sided tape to mount speaker enclosure
- Black electrical tape to secure wires
- Super glue to secure styrene piece to chassis
- Plastic cement to secure speaker to enclosure

SOUNDTRAXX™ DCC

Digital Sound Decoder

- * HIGH QUALITY DIGITAL SOUND
- * NMRA 8-PIN PLUG FOR EASY INSTALLATION
- * THREE SELECTABLE HORNS BUILT IN



203 00
\$65 00

MODEL DSD-101LC 1AMP SOUND DECODER

- 820120 EMD 1st Generation
- 820121 ALCO
- 820122 EMD 2nd Generation
- 820124 EMD 1st Gen Canadian Airhorns

DSD-101LC Installation Notes

For complete installation instructions and technical information, please refer to the DSD-LC Owner's Manual for Software Release 2.0 (with Yellow cover), available from your dealer at no charge or downloadable from our website at www.soundtraxx.com.

DECODER FEATURES

- Compatible with NMRA DCC Standards and RPs
- Supports short and long addresses
- Supports Advanced Consisting
- 14, 28 and 128 Speed Steps
- Standard and User Loadable Speed Tables
- Directional and Rule 17 Lighting
- Hyperlight Lighting Effects
- Three Selectable Airhorns
- Bell
- Diesel Sounds include Exhaust, including startup and shutdown, and Dynamic Brakes

FUNCTION ASSIGNMENTS

- | | |
|----------------|-----------------------|
| F0 = Headlight | F4 = Dynamic Brakes |
| F1 = Bell | F7 = Headlight Dimmer |
| F2 = Airhorn | F8 = Audio Mute |

DECODER RATINGS

The DSD-101LC is rated for the following loads:

- | | |
|----------------------|---------------------|
| Motor Stall Current: | 1 AMP Maximum |
| Function Current: | 100mA (each output) |
| Audio Amplifier: | 1 Watt, 8 ohm load |
| Track Voltage: | 16 Volts Maximum |



CAUTION: The DSD-LC Series of decoders are designed to work at track voltages between 7.5 and 16 volts maximum. On most command stations, this corresponds to a track setting of N or HO. Do NOT use the O or G scale settings!

Operating your DSD-LC at voltages greater than 16 volts will void your warranty, produce excessive heat and possible permanent damage to the DSD.

FCC Statement

This equipment has been tested and found to comply with the limits for a Class B digital device pursuant to Part 15 of the FCC Rules. See the DSD-LC Owner's Manual for more information.

SERVICE & WARRANTY POLICY

The complete warranty statement may be found in the back of the DSD-LC Owner's Manual.

WARNING: This product contains a chemical known to the State of California to cause cancer, birth defects or other reproductive harm.

210 Rock Point Drive, Durango, CO 81301 (970) 259-0690

120071 1M 102106

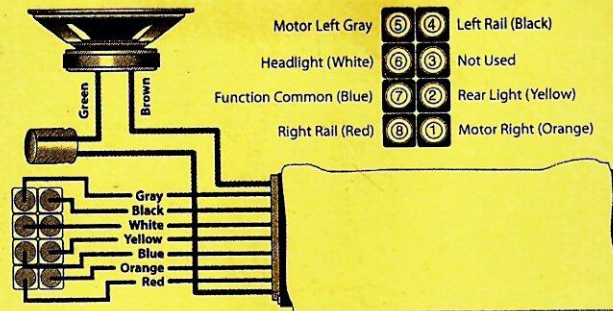

DECODER INSTALLATION

1. Remove the 'dummy' plug from the NMRA socket. Before plugging in the decoder, we highly recommend you perform a simple test on the socket itself to ensure it is properly wired. Never assume this socket has been wired correctly at the locomotive factory! An incorrectly wired socket can damage your decoder.
2. Using an Ohmmeter, test the motor connections by touching one probe to Pin 1 and the other to Pin 8. You should see no response from the meter. Now touch one probe to Pin 1 and the other to Pin 4. Again, you should see no response. Repeat this procedure with Pin 5 and Pin 8, then Pin 5 and 4. Now test the headlight connections by repeating the above procedure with Pins 8 and 2, Pins 8 and 6 and Pins 8 and 7. Continue the test with Pins 4 and 2, Pins 4 and 6, and Pins 4 and 7. Remember, you should see no response from the Ohmmeter!
3. If all checks out, plug the connector into the socket with the orange wire at pin 1 on the manufacturers circuit board. Most manufacturers have labeled the sockets with pin 1 or pin 8 (at a minimum).

Note: The DSD101LC is designed to be used 12-16V lamps. See the DSD-LC Owner's Manual for details on wiring 1.5V lamps. LEDs are not recommended for use with this decoder and may glow faintly when the function is turned off.

4. Connect the free end of the GREEN wire to one lead of the enclosed bipolar capacitor as shown above. Connect the second capacitor lead to one terminal of an 8 ohm speaker. Connect the free end of the BROWN wire to the other speaker terminal.

CV HIGHLIGHTS

The following table is a partial list of the DSD-101LC's most commonly used CVs. Please refer to the Owner's Manual for complete information.

CV	Name	Range
CV1	Primary Address	1-127
CV 2	Start Voltage	0-255
CV 3	Acceleration Rate	0-255
CV 4	Braking Rate	0-255
CV 17,18	Extended Address	0-9999
CV 19	Consist Address	0-127
CV 29	Decoder Configuration	See Manual
CV 115	Horn Select	0 = Single Chime 1 = Three Chime 2 = Five Chime
CV 116	Auto/Manual Notching	0-255
CV 120	Horn Volume	0-255
CV 121	Bell Volume	0-255
CV 122	Exhaust Volume	0-255
CV 123	Dynamic Brake Volume	0-255

7. NOTES ON BROADWAY LIMITED BLUELINE SD40-2 DCC:

My original attempt to install DCC on SD40-2 ATSF 5042 was successful. However, after consisting with a non-sound SD40-2, the sound would not operate. Repeated attempts to correct the problem failed. Sound on DC was okay.

A second SD40-2 (#5032) never would operate sound on DCC. Sound on DC was okay. Jerry Bonds had an operational SD40-2 with sound on DCC. He took my two locomotives and attempted to make them work. 5042 worked, 5032 did not. When I installed my decoders, neither locomotive would operate sound on DCC. I relegated them to the DC locomotive pile!

After an appropriate “cooling-off period”, I tried again:

I reset 5042 CV8 to 8, with no decoder or jumper installed.

I set the short address to 003 with no decoder or jumper installed.

I programmed a Digitrax DN163PS to address 003.

When the decoder was installed, the locomotive operated with sound on DCC. The head and rear lights worked, but the horn and bell did not.

I then set the long address to 5042. Again everything but horn and bell worked. Puzzlement!

A flash of inspiration! I reset CV8 to 8, set short address to 003. (The instructions say to always set address to 003 before changing addresses.)

I then set the short address to 42 (last two digits of 5042). All worked (lights, bell, and whistle). SUCCESS!

With the glow of success, I opened ATSF 5032, and repeated step 4, using a Digitrax DZ125PS. (SEVERAL TIMES!) NO LUCK! The locomotive operates fine on DCC, short address 32, with correct lights, but no sound! Sound is okay on DC.

After an appropriate ‘cooling off’ period, I tried again. This time the thing worked! The trick seems to be programming the locomotive to address 32 with the DCC decoder removed, then programming the DCC decoder separately, using the DCC test fixture. When the DCC decoder was reinstalled, all worked.

In conclusion, after reflection, DCC is in the same category as other computers - “It’s Magic”. I don’t plan to run these two in a consist again!

8. BUILDING A DCC DECODER TESTER:

My DCC decoder tester is based on an article in the September 2001 Railroad Model Craftsman magazine. Most of the parts were on hand, including the 6" x 8" project box. I did purchase some LEDs, lamps, and resistors from Radio Shack. The wiring diagram is shown below. The motor lamps are red instead of green:

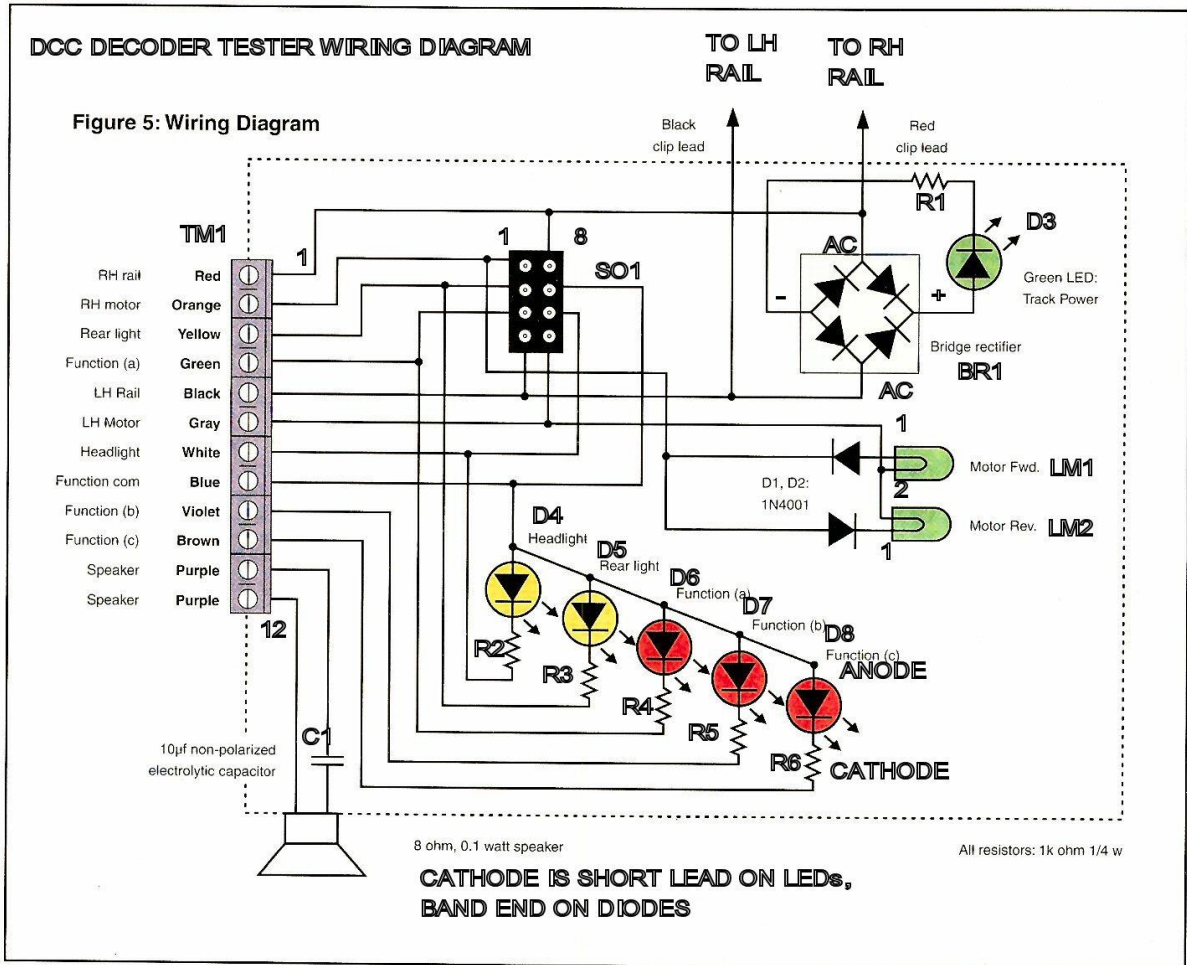

The panel layout is shown below:

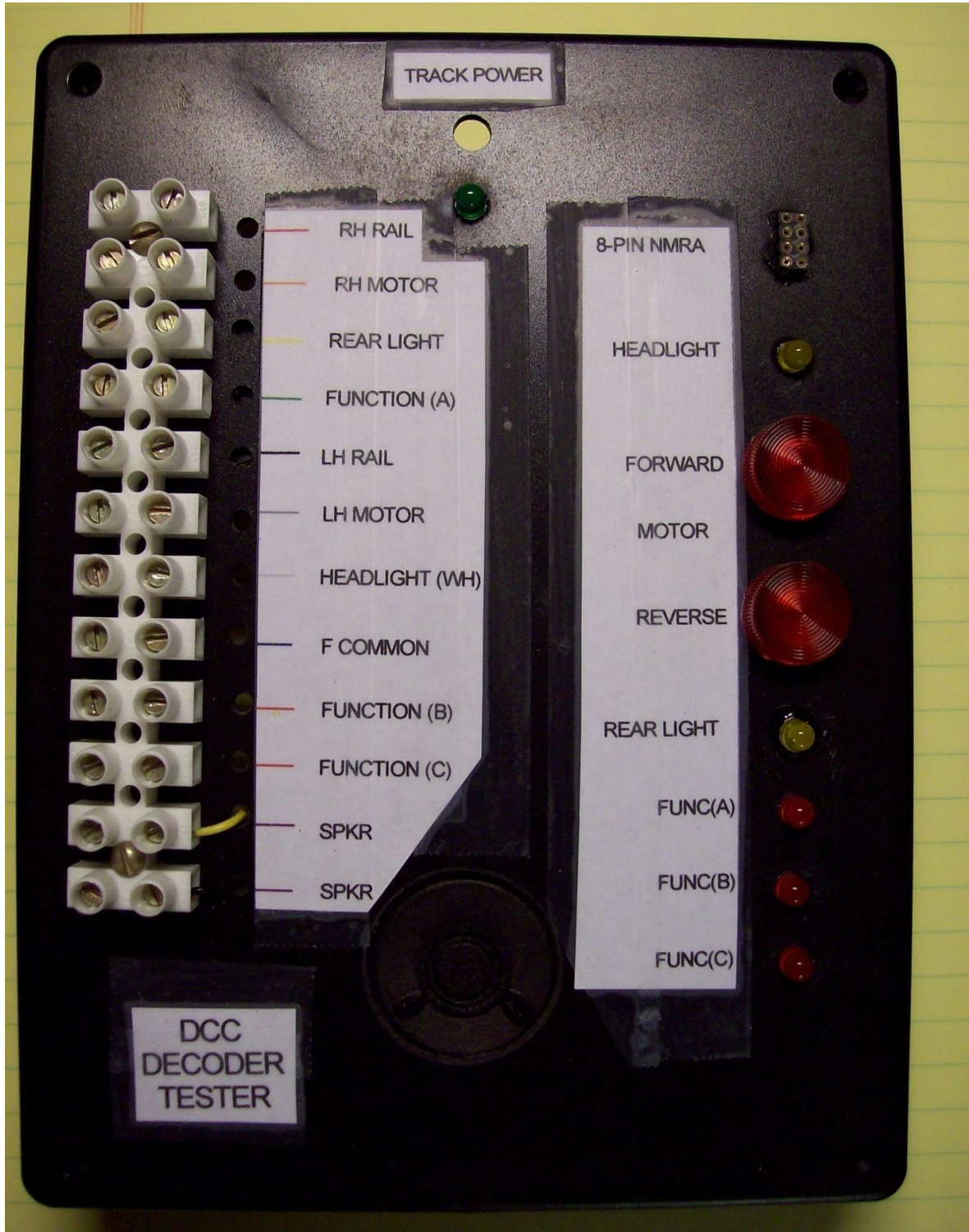

Panel overlays were produced using Autosketch, cut out and taped to the panel. This overlay identifies the connections to the large terminal strip on the left of the panel. The colors correspond to the colors of the DCC decoders.



This overlay identifies the LEDs and lamps on the right of the panel.

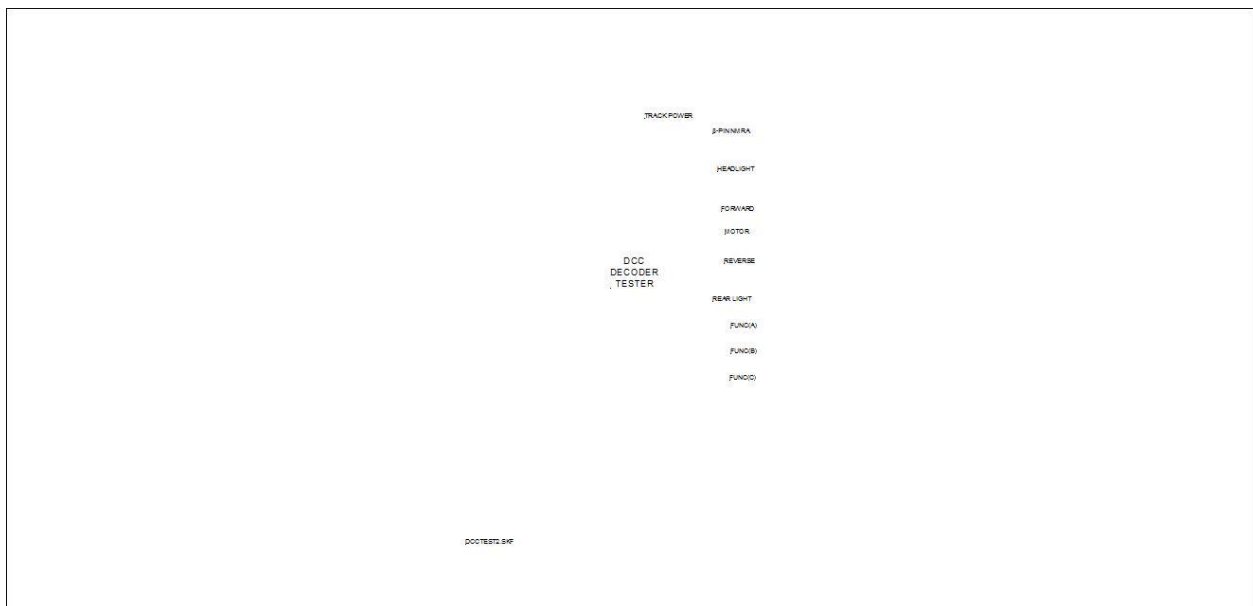

The printing was cut to fit, and taped to the panel.

The panel reverse is shown below:

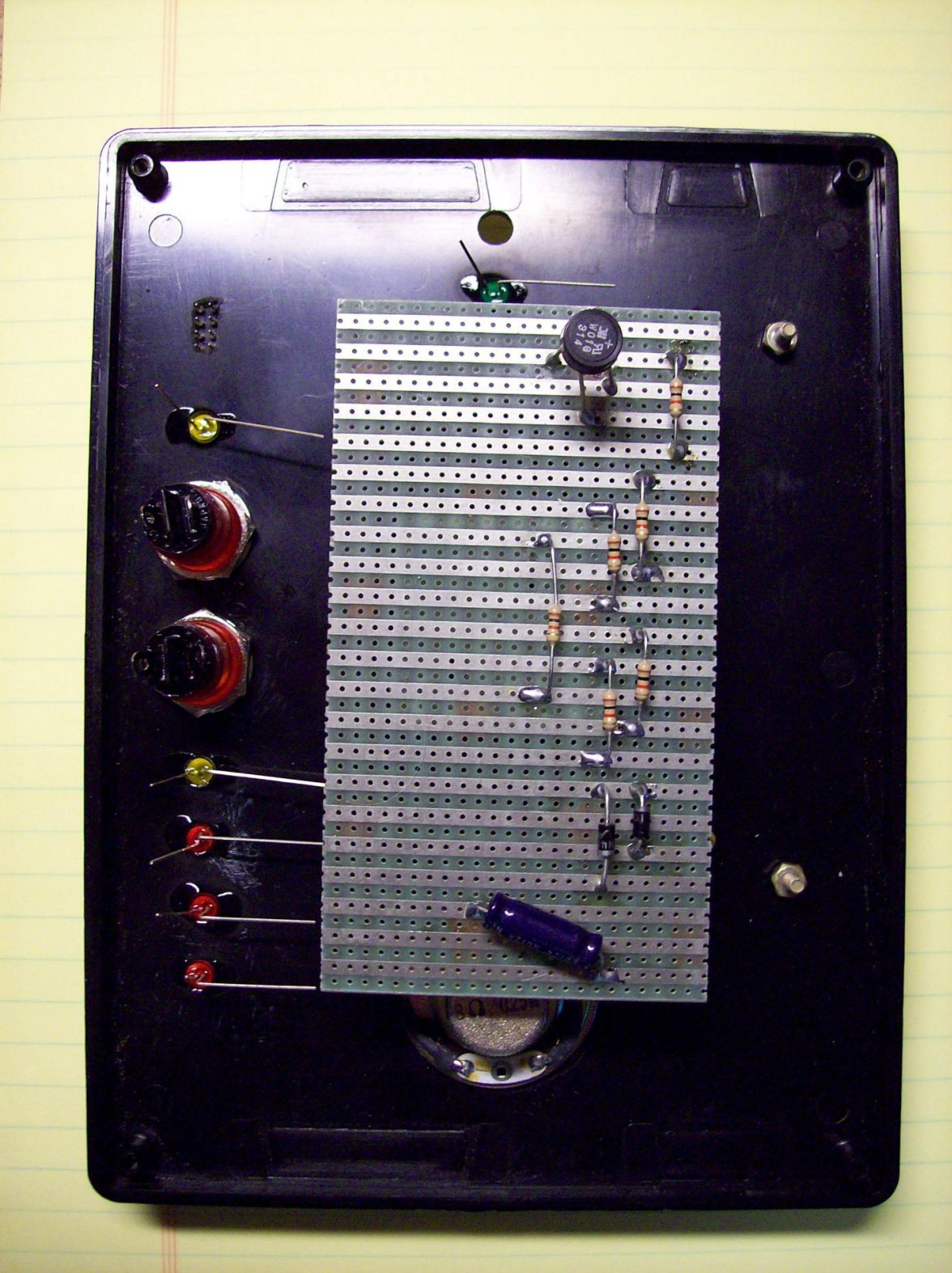

Small parts are located on a circuit board attached to the back of the panel:

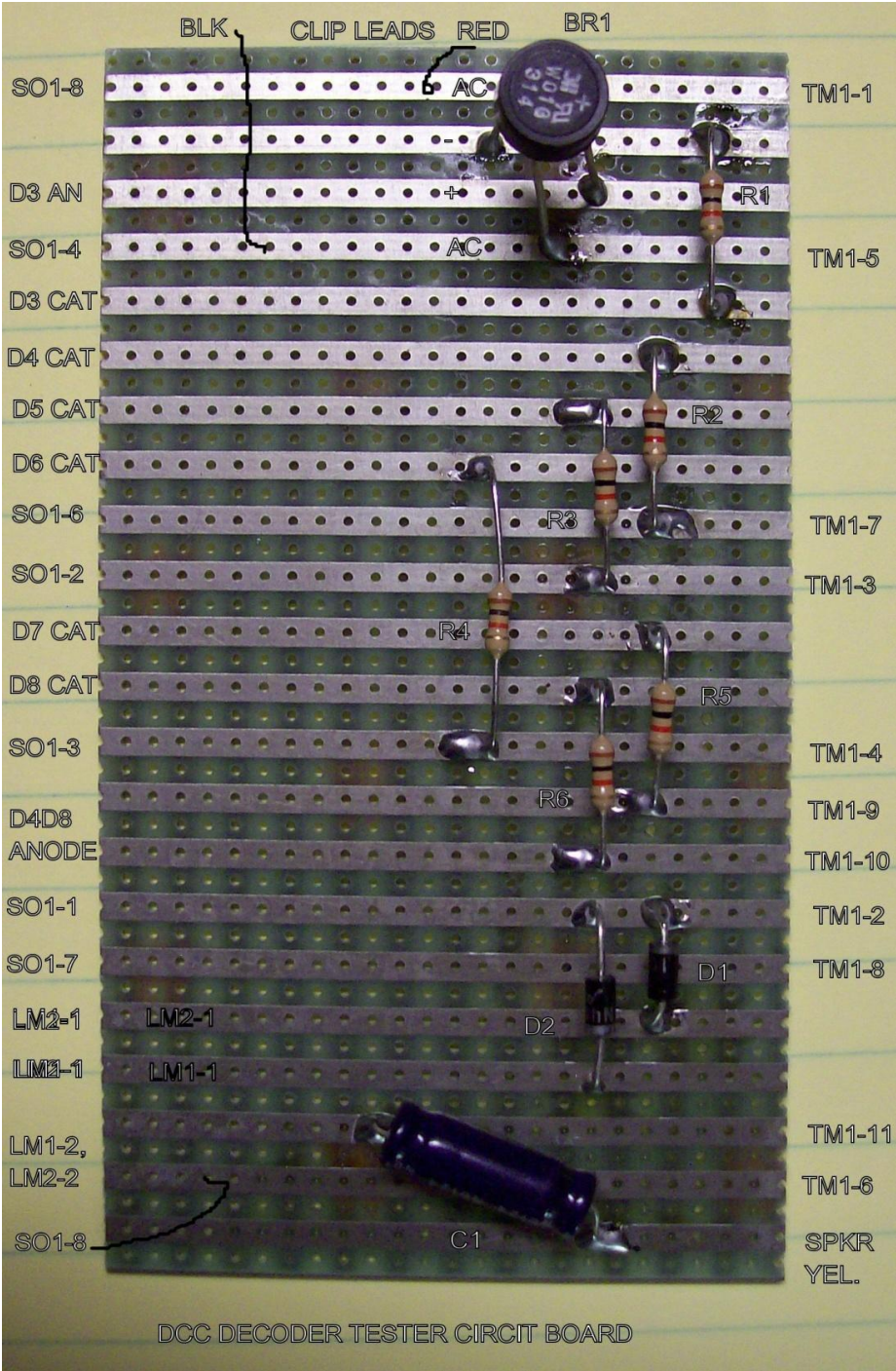

Side notations show where the individual circuit lines will connect to components on the front panel.

To accommodate Digitrax 9-pin decoders, a 9-pin Digitrax to 8-pin NMRA cable is provided. The Digitrax connection diagram is shown here:

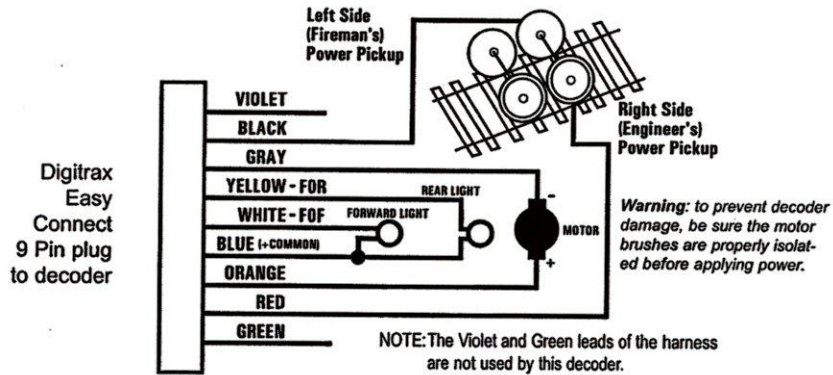

DIGITRAX 9-PIN CONNECTOR

NMRA 8-PIN PLUG

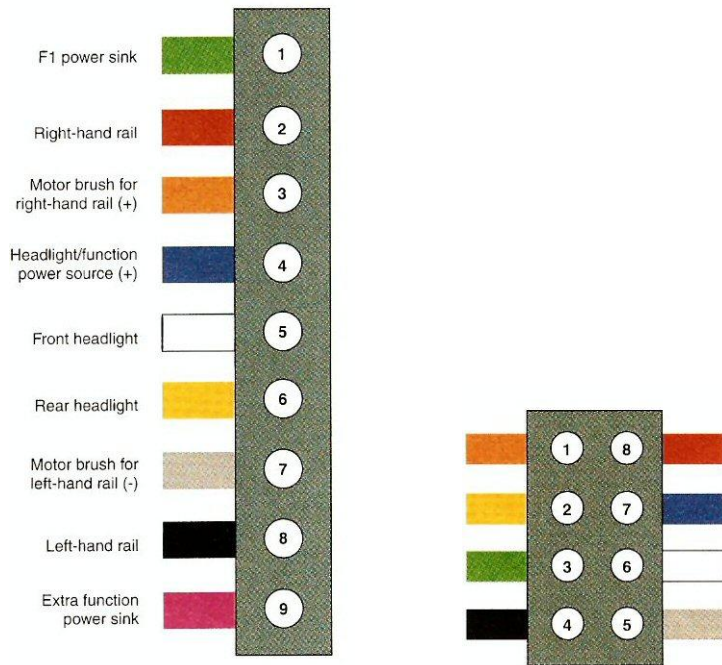

The F1 power sink (Green) and Extra function power sink (violet) are not connected to the 8-pin plug.

DCC DECODER TESTER PARTS

QTY	PART NUMBER	DESCRIPTION	REFERENCE	SIZE	HOLE
		12 TERMINAL STRIP	TM1	4 5/8 x 3/4"	1/8" (all)
6	RS 271-1321	RESISTOR, 1K 1/4W 5%	R1-R6		
1	RS 276-1152	BRIDGE RECTIFIER 100VDC 1500MA absolute maximum Ratings at TA=77 deg F (25 deg C): Working peak reverse voltage: 100V RMS reverse voltage: 70V Peak surge current,(8.3 ms), non-rep. and T=140 deg F (60 deg C): 50A DC forward current at T=140 deg F (60 deg C): 1500mA Operating temperature: -40 to +302 deg F -40 to +150 deg C	BR1		

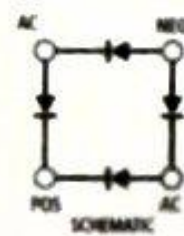
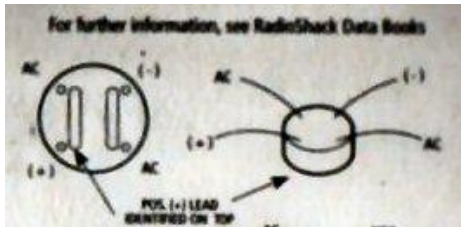

2	RS 272-336	LAMP ASSEMBLY, 12V	LM1, LM2		1/2" (+)
1	RS 272-999	CAPACITOR, ELECTROLYTIC non-polarized, Axial leads, 10 MF 50V maximum \pm 20 PCT 2 kHz at 8 ohms Operating temperature: -40C to +85c	C1		
2	RS 278-001	CLIP LEADS (1 RED, 1 BLACK)			1/4"
2	RS 276-1101	DIODE, 1N4001, 50V 1A Absolute maximum ratings (25 deg C): Peak inverse voltage (PIV): 50V Forward voltage drop (VF) at if: 1.6V Forward current (if): 1A Max. surge current (16ms): 30A Reverse current at PIV: 10 microAmps	D1, D2		

Note 1: if=alternating component of forward current (RMS)

Note 2: VF=alternating component of forward voltage (RMS)

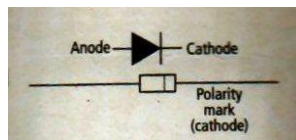

<u>QTY</u>	<u>PART NUMBER</u>	<u>DESCRIPTION</u>	<u>REFERENCE</u>	<u>SIZE</u>	<u>HOLE</u>
1		8-PIN NMRA SOCKET	SO1		3/16 X 3/8"
1		8-PIN NMRA TO 9-PIN HARNESS (DIGITRAX)			
3	RS 276-0041	LED, RED, 5MM 2.6V, 20 mA 28Ma max, 60Mw 25 deg C, 10 mcd luminous Intensity Peak wave length 650 nm, short lead is cathode	D7, D8		13/64"
2	RS 276-021	LED, YELLOW, 5MM 3V 20 mA	D4, D5		13/64"
1	RS 276-022	LED, GREEN, 5MM 2.1V 25 mA	D3		13/64"
1		SPEAKER, 8 OHMS .25W			1 1/4"
1		PROJECT BOX WITH LID		6 x 8 x 3 1/8" (outside)	