

Instruction manual

Inline Flow Sensor

VA 520

with Display, 4 ... 20 mA and pulse output (galv. isolated)

Stationary

Flow and consumption measurement for compressed air and gases



I. Foreword

Dear customer,
thank you very much for deciding in favour of the VA 520. Please read this installation and operation manual carefully before mounting and initiating the device and follow our advice. A riskless operation and a correct functioning of the VA 520 are only guaranteed in case of careful observation of the described instructions and notes



Sales Office South / Geschäftsstelle Süd

Zindelsteiner Str. 15
D-78052 VS-Tannheim
Tel.: +49 (0) 7705 978 99 0
Fax: +49 (0) 7705 978 99 20
Mail: info@cs-instruments.com
Web: <http://www.cs-instruments.com>

Sales Office North / Geschäftsstelle Nord

Gewerbehof 14
D-24955 Harrislee
Tel.: +49 (0) 461 807 150 0
Fax: +49 (0) 461 807 150 15
Mail: info@cs-instruments.com
Web: <http://www.cs-instruments.com>

II. Table of Contents

I. Foreword 2

1 Intended use..... 5

2 Safety instructions..... 5

3 Instruments description 6

4 Technical data..... 7

5 Scope of delivery 7

6 Scaling Analogue output Compressed Air..... 8

7 Installation Description 9

 7.1 Pipe/tube requirements 9

 7.2 Inlet / outlet runs 9

 7.3 Installation of VA 520..... 10

 7.4 Display head Position..... 10

8 Flow measuring ranges11

 8.1 Flow for different gases..... 11

9 Dimensions12

 9.1 With measurement section and screw-in thread 12

 9.2 With measurement section and flange (Material stainless steel 1.4404): 13

10 Electrical wiring14

 10.1 Modbus RTU, 4...20mA, Pulse or MBus 14

 10.2 Ethernet (optional PoE) 15

11	Operation.....	16
11.1	Initialization	17
11.2	Main menu	17
11.3	Settings	18
11.3.1	Sensor Setup	18
11.3.1.1	Input / change tube diameter.....	18
11.3.1.2	Input / change consumption counter	19
11.3.1.3	Definition of the units for flow, velocity, temperature and pressure	19
11.3.1.4	Definition of the reference conditions	20
11.3.1.5	Setting of Zero point and Low-flow cut off	22
11.3.2	Modbus settings.....	23
11.3.2.1	Modbus RTU Setup	23
11.3.2.2	Modbus TCP (Optional).....	24
11.3.2.2.1	Network Setup DHCP	24
11.3.2.2.2	Network Settings static IP.....	25
11.3.2.3	Modbus TCP Settings.....	26
11.3.2.4	Modbus Settings (2001...2005).....	27
11.3.2.5	Values Register (1001 ...1500)	27
11.3.3	Pulse /Alarm.....	29
11.3.3.1	Pulse output.....	29
11.3.4	User Setup	30
11.3.4.1	Password	30
11.3.4.2	Language.....	30
11.3.4.3	Display / Touch.....	31
11.3.5	Advanced.....	31
11.3.6	4 -20mA	32
11.3.7	VA 520 Info	34
11.4	MBus.....	35
11.4.1	Default Settings communication	35
11.4.2	Default values transmitted	35
12	Status / Error messages	36
12.1	Status messages	36
12.2	Error messages	37
13	Maintenance.....	38
14	Cleaning of the sensor head.....	38
15	Re-Calibration	38
16	Spare parts and repair.....	38
17	Calibration.....	38
18	Warranty.....	38

1 Intended use

The VA 520 consumption sensor is used for continuous flow measurements.

The VA 520 consumption sensor is designed and constructed exclusively for the intended purpose described here and may only be used accordingly.

The user must check whether the instrument is suitable for the selected application. It must be ensured that the medium is compatible with the wetted parts. The technical data listed in the data sheet are binding.

Improper handling or operation outside the technical specifications is not permitted. Claims of any kind based on improper use are excluded.

2 Safety instructions



Please read carefully before starting the device!

Warning: Do not exceed the pressure range of 16 bar!

Observe the measuring range of the sensor!

Always observe the direction of flow when positioning the sensor!

The screwed fixture must be pressure tight.

It is absolutely necessary to avoid condensation on the sensor element or water drops in the measuring air as they may cause faulty measuring results.

The manufacturer cannot be held liable for any damage which occurs as a result of non-observance or non-compliance with these instructions. Should the device be tampered with in any manner other than a procedure which is described and specified in the manual, the warranty is cancelled and the manufacturer is exempt from liability.

The device is destined exclusively for the described application.

We offer no guarantee for the suitability for any other purpose and are not liable for errors which may have slipped into this operation manual. We are also not liable for consequential damage resulting from the delivery, capability or use of this device.

We offer you to take back the instruments of the instruments family VA 520 which you would like to dispose of.

Qualified employees from the measurement and control technology branch should only carry out adjustments and calibrations.



The consumption sensor VA 520 works according to the calorimetric measuring procedure.

Flammable gases

If this consumption sensor is used for measurement of flammable gases (e. g. natural gas and so on) we expressly would like to point out that the sensor has no DVGW admission, however, it can be used for measurements in natural gas. A DVGW admission is not mandatory.

The consumption sensor corresponds with the current state of technology and basically it can be used in any flammable and non-flammable gases.

If the sensor is used e.g. in the medium natural gas, the sensor will be adjusted for natural gas. The calibration protocol (inspection certificate) will be included in the scope of delivery.

The area outside the pipeline (ambient area of the sensor) must not be an explosive area.

The installation has to be carried out by authorized professionals.

3 Instruments description

The VA 520 is a compact consumption counter for compressed air and gases.

Special features:

- Optimum accuracy due to compact design
- Integrated Display showing Flow, consumption, velocity and temperature
- Input inner tube diameter via display keys
- Units free selectable. m³/h, m³/min, l/min, l/s, kg/h, kg/min, kg/s, cfm
- Modbus RTU (RS485) Interface
- Analogue output 4..20mA
- Pulse output galv. isolated.

CS Instruments Service Software

- Analogue output 4...20 mA scalable
- Selection of gas type (Air, Nitrogen, Argon, Nitrous oxide, CO₂, Oxygen, Natural gas)
- Read out Service data
- Sensor diagnoses

4 Technical data

Measurement:	Flow and consumption
Reference Standard:	Standard settings ex works: DIN 1945, ISO 1217 at 20°C and 1000 mbar
Selectable Units	m³/h (Standard settings ex works) m ³ /min, l/min, l/s, ft ³ /min, cfm, m/s, kg/h, kg/min, kg/s
Measuring principle:	calorimetric measurement
Sensor:	Pt45, Pt1000
Measuring medium:	Air, gases
Operating temperature:	-30 ... 80°C probe tube -20 ... 70°C housing
Rel. humidity of the measuring medium:	< 95 % r.H. (no condensation allowed on the sensor element)
Operating pressure:	up to 16 bar, special version PN 40 (40 bar)
Power supply:	18 to 36 VDC
Power consumption:	max. 5W
Digital output:	RS 485 (Modbus RTU)
Analog output:	4...20 mA (see chapter 4), max. burden < 500 Ohm
Pulse output:	pulse output potential free (dry contact) passive: max. 48Vdc, 150mA 1 pulse pro m ³ resp. pro l, Valency adjustable with the display keys
Accuracy:	± 1,5 % m.v., ± 0,3 % f. s.*
Display:	TFT 1.8 Resolution 220 x 176
Mounting thread:	R 1/4", R1/2", R3/4", R1", R 1 1/4" R1 1/2", R 2" DIN EN 10226 (ISO 7-1)
Material:	Stainless steel 1.4301 / 1.4404 Version with flange DIN EN 1092-1: Stainless steel 1.4404
Protection class:	IP65

* m.v. = measured values
f.s. = full scale

5 Scope of delivery

- 1x Flow sensor VA 520 with measuring section
- 1x Calibration certificate
- 1x Instruction manual

6 Scaling Analogue output Compressed Air

Reference DIN1945/ ISO 1217: 20°C, 1000 mbar (Reference during calibration)

Description	Version	Analogue output	
VA 520 with integrated 1/4" meas. section	Low Speed	4... 20 mA =	0...25 l/min
	Standard		0...50 l/min
	Max		0...105 l/min
	High Speed		0...130 l/min
VA 520 with integrated 1/2" meas. section	Low Speed	4... 20 mA =	0...20 m³/h
	Standard		0...45 m³/h
	Max		0...90 m³/h
	High Speed		0...110 m³/h
VA 520 with integrated 3/4" meas. section	Low Speed	4... 20 mA =	0...45 m³/h
	Standard		0...85 m³/h
	Max		0...175 m³/h
	High Speed		0...215 m³/h
VA 520 with integrated 1" meas. section	Low Speed	4... 20 mA =	0...75 m³/h
	Standard		0...145 m³/h
	Max		0...290 m³/h
	High Speed		0...355 m³/h
VA 520 with integrated 1 1/4" meas. section	Low Speed	4... 20 mA =	0...140 m³/h
	Standard		0...265 m³/h
	Max		0...530 m³/h
	High Speed		0...640 m³/h
VA 520 with integrated 1 1/2" meas. section	Low Speed	4... 20 mA =	0...195 m³/h
	Standard		0...365 m³/h
	Max		0...730 m³/h
	High Speed		0...885 m³/h
VA 520 with integrated 2" meas. section	Low Speed	4... 20 mA =	0...320 m³/h
	Standard		0...600 m³/h
	Max		0...1195m³/h
	High Speed		0...1450 m³/h
VA 520 with integrated 2 1/2" meas. section	Low Speed	4... 20 mA =	0...550 m³/h
	Standard		0...1025 m³/h
	Max		0...2050m³/h
	High Speed		0...2480 m³/h
VA 520 with integrated 3" meas. section	Low Speed	4... 20 mA =	0...765 m³/h
	Standard		0...1420 m³/h
	Max		0...2840m³/h
	High Speed		0...3440 m³/h

7 Installation Description

7.1 Pipe/tube requirements

- Correctly sized gaskets
- Correct aligned flanges and gaskets
- Diameter mismatch at the pipe junctions should be avoided but must be less than 1mm. For further information see ISO 14511
- Ensure clean pipes after installation

7.2 Inlet / outlet runs

The principle of thermal Mass flow measurement is very sensitive against disturbances. Therefore, it is necessary to ensure the recommended inlet and outlet runs.

Table of additionally required inlet sections

Flow obstruction in front of the measuring section	Minimum length inlet section (L1)	Minimum length outlet section (L2)
Slight curve (bend < 90°)	12 x D	5 x D
Reduction (pipe narrows towards the meas. section)	15 x D	5 x D
Expansion (pipe expands towards the meas. section)	15 x D	5 x D
90° bend or T-piece	15 x D	5 x D
2 bends á 90° on one level	20 x D	5 x D
2 bends á 90° 3-dimensional change of direction	35 x D	5 x D
Shut-off valve	45 x D	5 x D

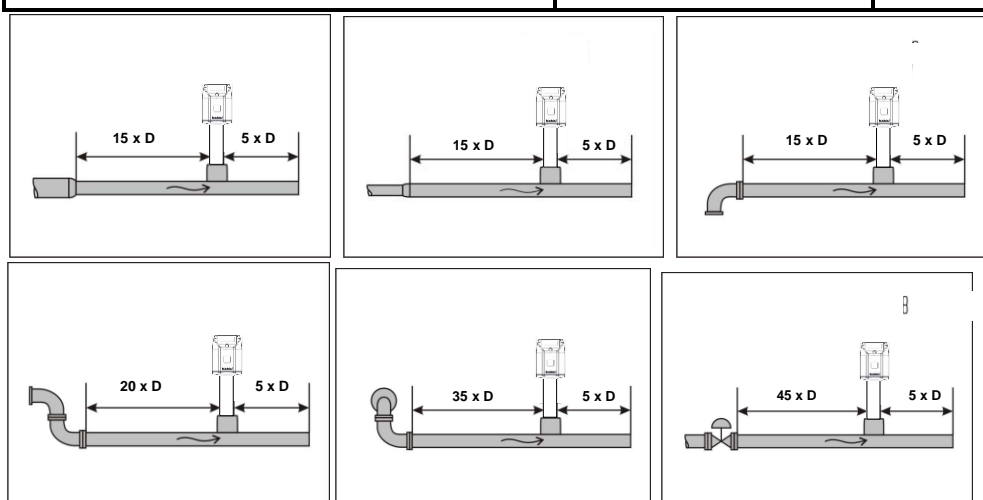

The respective minimum values required are indicated here. If it is not possible to observe the stipulated equalising sections, considerable deviations in the measuring results must be expected.

Attention:

The dimensions of the VA 520 consumption counter measuring sections do not fulfill the required minimum lengths of the input and outlet runs.

Please ensure recommended in - and outlet distances, dimensions for measuring sections see page

12 and 13.

7.3 Installation of VA 520

The sensor VA 520 is pre-supplied with the measuring section.



- An installation at customer site is only allowed in the unpressurized state of the system
- It has to be checked whether the VA520 is correctly installed in the measuring section, the flow direction arrows must point in the same direction.

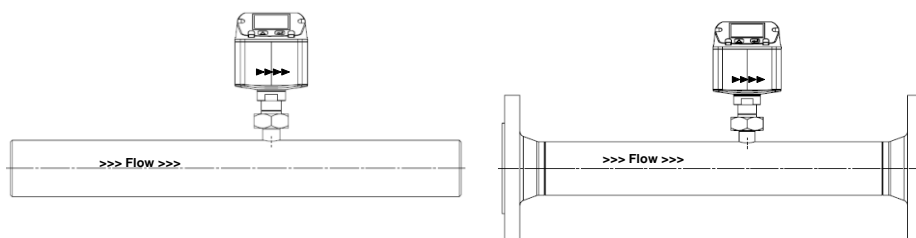

- The connecting nut is tightened to a torque of 25 -30 Nm.
- Tightness of the connection must be checked and ensured

7.4 Display head Position

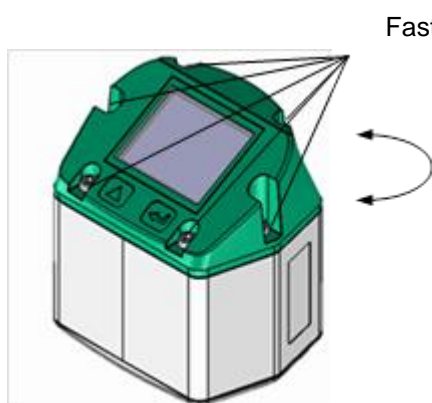

Fastening screws

The Position of the Display head is twistable by 180 e.g. in case of reverse flow direction. For this purpose the 6 fastening screws are to be released and the display head rotated 180°.

Caution:

It must be ensured that the connection plugs are still plugged and the gasket is installed correctly.

8 Flow measuring ranges

8.1 Flow for different gases

	1/4"	3/8"	1/2"	3/4"	1"	1 1/4"	1 1/2"	2"	2 1/2"	3"
	Analog output 20mA	Analog output 20mA	Analog output 20mA	Analog output 20mA	Analog output 20mA	Analog output 20mA	Analog output 20mA	Analog output 20mA	Analog output 20mA	Analog output 20mA
	l/min	[m ³ /h] **l/min	[m ³ /h]	[m ³ /h]	[m ³ /h]	[m ³ /h]	[m ³ /h]	[m ³ /h]	[m ³ /h]	[m ³ /h]

Reference DIN1945/ ISO 1217: 20°C, 1000 mbar (Reference during calibration)

Air	Low Speed	25	225**	20	45	75	140	195	320	550	765
	Standard	50	25	45	85	145	265	365	600	1025	1420
	Max	105	50	90	175	290	530	730	1195	2050	2840
	High Speed	130	60	110	215	355	640	885	1450	2480	3440

Adjustment to DIN 1343: 0°C, 1013,25 mbar

Air	Low Speed	25	200**	20	40	70	130	180	295	505	705
	Standard	50	380**	40	80	135	240	335	550	945	1305
	Max	100	45	80	160	270	485	670	1100	1885	2610
	High Speed	120	55	100	195	325	590	815	1330	2280	3165
Argon (Ar)	Low Speed	45	20	35	75	120	220	305	505	865	1200
	Standard	85	35	70	135	230	415	570	935	1605	2225
	Max	170	75	140	275	460	830	1140	1870	3205	4440
	High Speed	205	95	170	335	555	1005	1385	2265	3880	5380
Carbon dioxide (CO ₂)	Low Speed	25	225**	20	45	75	140	195	320	545	760
	Standard	50	25	45	85	145	260	360	590	1015	1405
	Max	105	50	90	175	290	525	720	1185	2030	2810
	High Speed	130	60	105	210	350	635	875	1430	2455	3405
Nitrogen (N ₂)	Low Speed	25	205**	20	40	70	130	180	295	505	705
	Standard	50	20	40	80	135	240	335	550	945	1305
	Max	100	45	80	160	270	485	670	1100	1885	2610
	High Speed	120	55	100	195	325	590	815	1330	2280	3165
Oxygen f (O ₂)	Low Speed	25	215**	20	45	75	135	185	305	525	730
	Standard	50	20	40	80	140	250	345	570	980	1355
	Max	100	45	85	165	280	505	695	1140	1955	2710
	High Speed	125	55	105	205	340	610	845	1380	2365	3280
Nitrous oxide (N ₂ O)	Low Speed	25	220**	20	45	75	140	190	315	540	750
	Standard	50	20	40	85	140	260	355	585	1005	1395
	Max	105	45	85	170	285	520	715	1170	2010	2785
	High Speed	125	60	105	210	345	630	865	1420	2435	3375
Natural gas (NG)	Low Speed	15	130**	15	25	45	85	115	190	325	450
	Standard	30	245**	25	50	85	155	215	355	605	840
	Max	60	25	50	105	170	310	430	705	1210	1680
	High Speed	75	35	65	125	210	380	520	855	1465	2035

Other gases on request

Please note:

The consumption sensor corresponds with the current state of technology and basically it can be used in any flammable and non-flammable gases.

If this consumption sensor is used for measurement of flammable gases (e.g. natural gas and so on) we expressly would like to point out that the sensor has no DVGW admission, however, it can be used for measurements in natural gas. A DVGW admission is not mandatory.

The area outside the pipeline (ambient area of the sensor) must not be an explosive area.

9 Dimensions

9.1 With measurement section and screw-in thread

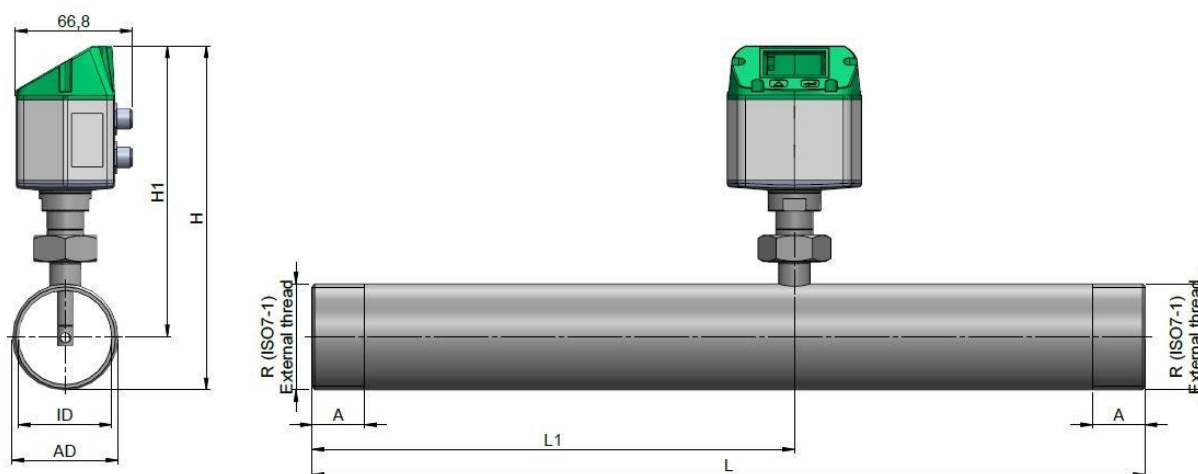

	Pipe size	AD / ID (mm)	L (mm)	L1 (mm)	H (mm)	H1 (mm)	R	A (mm)
VA 520 1/4"	DN 8	13,7 / 8,5	194	137	176,6	166,3	R 1/4"	15
VA 520 3/8"	DN 10	17,2 / 12,5	300	200	174,9	166,3	R 3/8"	15
VA 520 1/2"	DN 15	21,3 / 16,1	300	210	177,0	166,3	R 1/2"	20
VA 520 3/4"	DN 20	26,9 / 21,7	475	275	179,8	166,3	R 3/4"	20
VA 520 1"	DN 25	33,7 / 27,3	475	275	183,2	166,3	R 1"	25
VA 520 1 1/4"	DN 32	42,4 / 36,0	475	275	187,5	166,3	R 1 1/4"	25
VA 520 1 1/2"	DN 40	48,3 / 41,9	475	275	190,5	166,3	R 1 1/2"	25
VA 520 2"	DN 50	60,3 / 53,1	475	275	196,5	166,3	R 2"	30

9.2 With measurement section and flange (Material stainless steel 1.4404):

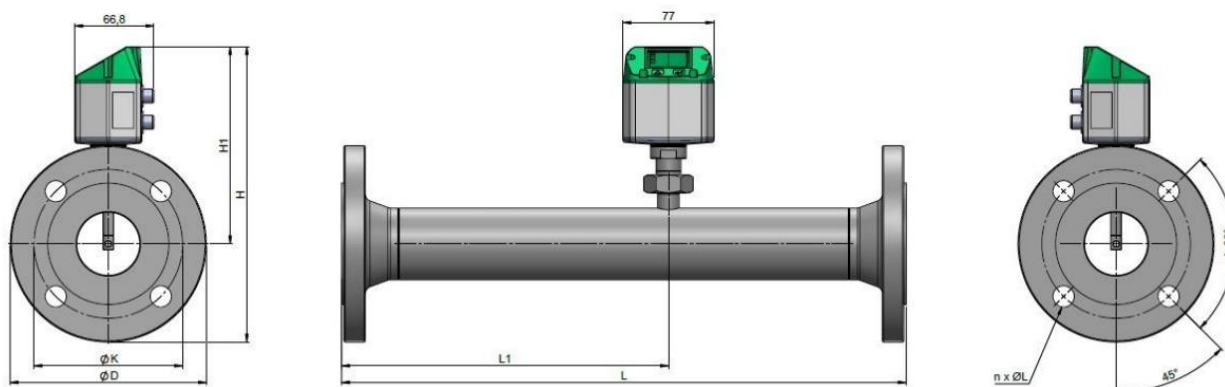

							Flange DIN EN 1092-1		
	Pipe size	AD/ID (mm)	L (mm)	L1 (mm)	H (mm)	H1 (mm)	Ø D in mm	Ø K in mm	nxØL in mm
VA 520 1/2"	DN 15	21,3 / 16,1	300	210	213,8	166,3	95	65	4 x 14
VA 520 3/4"	DN 20	26,9 / 21,7	475	275	218,8	166,3	105	75	4 x 14
VA 520 1"	DN 25	33,7 / 27,3	475	275	223,8	166,3	115	85	4 x 14
VA 520 1 1/4"	DN 32	42,4 / 36,0	475	275	263,3	166,3	140	100	4 x 18
VA 520 1 1/2"	DN 40	48,3 / 41,9	475	275	240,7	166,3	150	110	4 x 18
VA 520 2"	DN 50	60,3 / 53,1	475	275	248,2	166,3	165	125	4 x 18
VA 520 2 1/2"	DN 65	76,1 / 68,9	475	275	268,2	175,7	185	145	8 x 18
VA 520 3"	DN 80	88,9 / 80,9	475	275	275,7	175,7	200	160	8 x 18

10 Electrical wiring

10.1 Modbus RTU, 4...20mA, Pulse or MBus

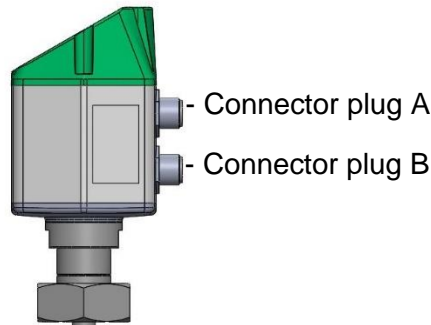

Attention: Not required connections NC must not be connected to a voltage and/or to protection earth. Cut and insulate cables.

	Pin 1	Pin 2	Pin 3	Pin 4	Pin 5
Connector plug A	+VB	RS 485 (A) RS 485 (+)	-VB	RS 485 (B) RS 485 (-)	I+ 4..20 mA
Connector plug B Pulse output (standard)	NC	GND	DIR	Pulse galv. isolated	Pulse galv. isolated
Connector plug B Option MBus	NC	GND	DIR	MBus	MBus
Colours pulse cables 0553.0106 (5 m) 0553.0107 (10 m)	brown	white	blue	black	grey

Legend:

-VB	Negative supply voltage 0 V	Pulse	Pulse for consumption
+VB	Positive supply voltage 18...36 VDC smoothed	NC	Must not be connected to a voltage and/or to protection earth. Please cut and isolate cables.
I +	Current signal 4...20 mA – selected measured signal	MBus	MBus (reverse polarity protected)
RS 485 (A) RS 485 (B)	Modbus RTU A / Modbus RTU (+) Modbus RTU B / Modbus RTU (-)		

If no connection cable/ pulse cable is ordered the sensor will be supplied with a M12 connector plug. The user can connect the supply and signal cables as indicated in the connection diagram.

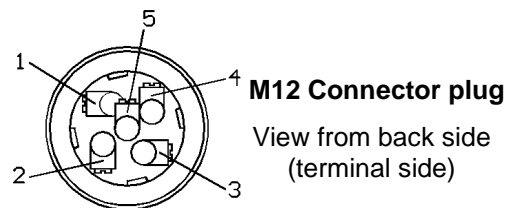

Connector plug A (M12 - A-coding)

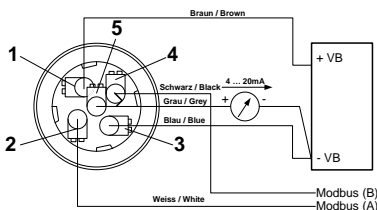

Connector plug B (M12 - A-coding)

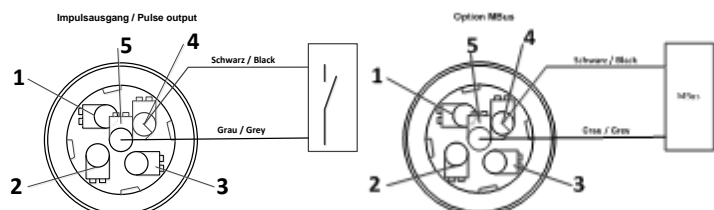

Remark: If the sensor is placed at the end of the Modbus system a termination is required. The sensors have an internal switchable termination, therefore the 6 fastening screws from the lid are to be released and set the internal DIP Switch to “On”. It must be ensured that the connection plugs are still plugged and the gasket is installed correctly, see also chapter 4.1.

Alternatively, a 120R resistor can be installed in the plug between pin 2 and pin 4.

10.2 Ethernet (optional PoE)

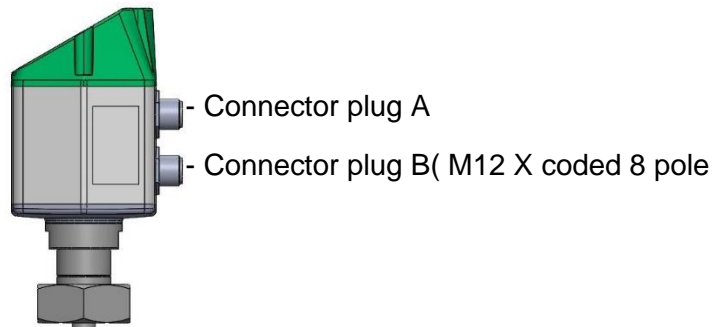

Connector plug B

M12 x-coded 8 pole

Data LINES: 1,2 und 3,4

PoE LINES: 5,6 und 7,8

Connection cable

M12 x-coded to RJ45

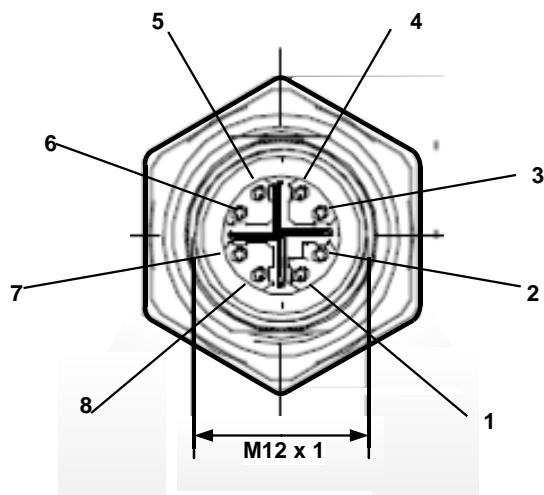

M12 jack



RJ45 plug

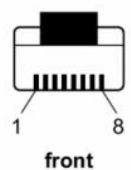
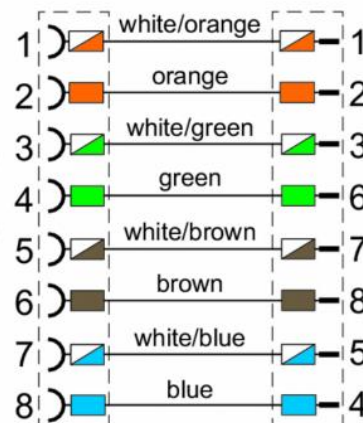

Connection cable: Cat 6.

Remark:

VA520 Power Classification acc. IEEE 802.3af: Class 2 (3,84W – 6,49W)

*PoE: Power over Ethernet

11 Operation

Remark: Only for version with display

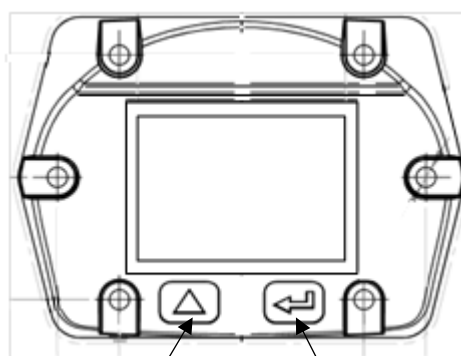

“Up“ (\triangle)

“OK“ (\leftarrow)

The operation of the VA 520 is done by the two capacitive key buttons Up (\triangle) and Enter (\leftarrow)

11.1 Initialization

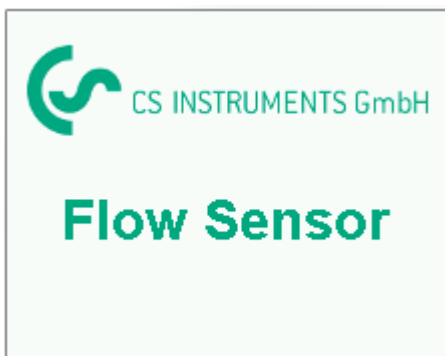

After switching on the VA 520, the initialized screen is displayed followed by the main menu.

11.2 Main menu

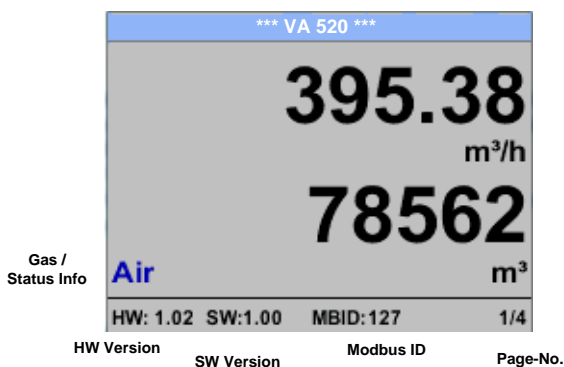

Switching to pages 2-5 or back by pressing key „△“

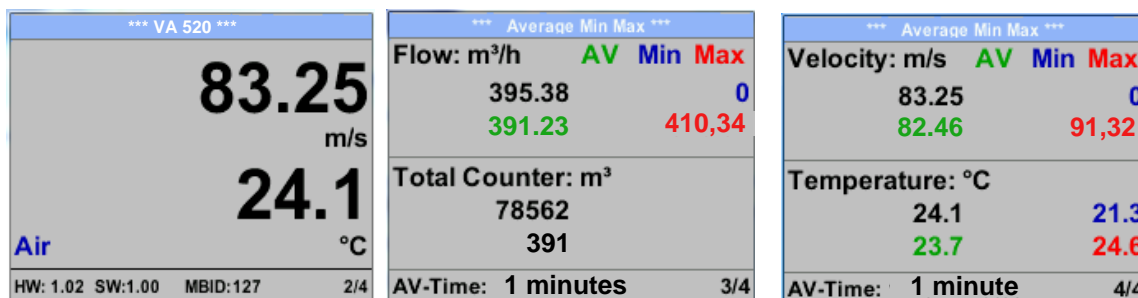

AV-Time (Period for average value calculation) could be changed under *Sensor Setup.-Advanced- AV-Time*

11.3 Settings

The settings menu could accessed by pressing the key „OK“.

But the access to the *settings menu* is password protected.



Factory settings for password at the time of delivery: 0000 (4 times zero).

If required the password could be changed at *Setup–User setup–Password*.

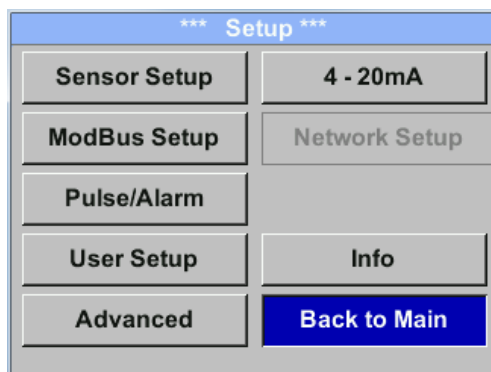

Selection of a menu item or to change a value is done with the key „ Δ “, a final move to the chosen menu item or takeover of the value change needs the confirmation by pressing the key „OK“.

11.3.1 Sensor Setup

Setup → Sensor Setup

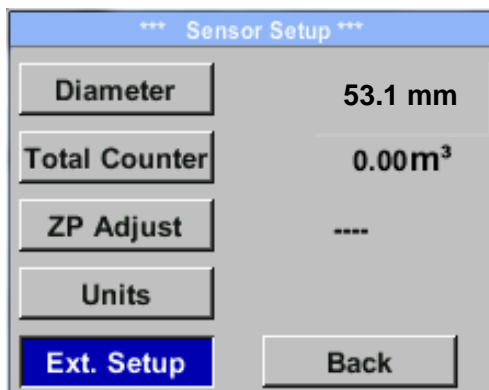

For changes, first select the menu item with key „ Δ “ and then confirm it with „OK“.

11.3.1.1 Input / change tube diameter

For VA 520 not adjustable (suspended) as voted on included measuring section with corresponding pipe diameter.

11.3.1.2 Input / change consumption counter

Setup → Sensor Setup → Total Counter → Unit button

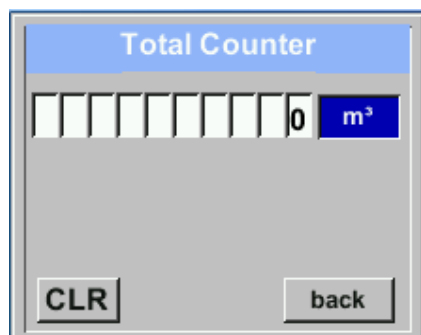
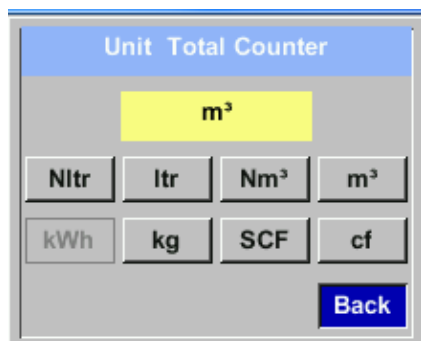

In order to change, e.g. the unit, first select by pressing key „Δ“ the button **“Unit”** and then key **“OK”**.

Select with the key „Δ“ the correct unit and then confirm selection by pressing 2x **„OK”**.

Entering / changing the consumption counter via button „Δ“, select the respective position and activate the position with the **“OK”** button.

By pressing „Δ“ the position value is incremented by 1. Complete with **“OK”** and activate next number position.

Confirm entry by pressing **„OK”**.

Important!

When the counter reach 100000000 m³ the counter will be reset to zero.

11.3.1.3 Definition of the units for flow, velocity, temperature and pressure

Setup → Sensor Setup → Units

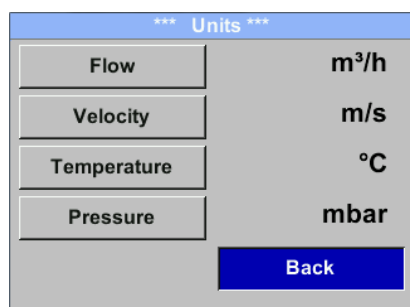

To make changes to the unit for the respective measurement value, first select by pressing „Δ“ the field of the „measurement value“ and activate „it with **„OK”** .

Selection of the new unit with **„Δ”**

In case the quantity of units selectable are not presentable on one page, pleas move to next page by pressing **„<<”** .

Confirm selection by pressing 2x **„OK”**.

Procedure for all 4 measurement variables is analogous.

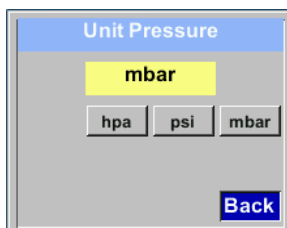
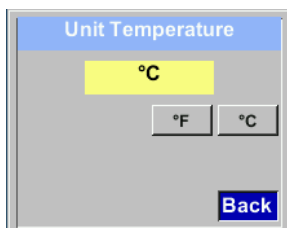
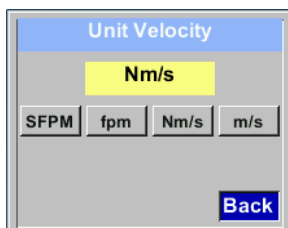
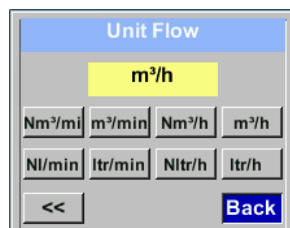

11.3.1.4 Definition of the reference conditions

Here can be defined the desired measured media reference conditions for pressure and temperature and times for the filter and averaging.

- Factory pre-setting for reference temperature and reference pressure are 20 °C, 1000 hPa
- All volume flow values (m³/h) and consumption values indicated in the display are related to 20 °C and 1000 hPa (according to ISO 1217 intake condition)
- Alternatively 0 °C and 1013 hPa (=standard cubic meter) can also be entered as a reference.
- **Do not enter the operation pressure or the operation temperature under reference conditions!**

Setup → Sensor Setup → Advanced

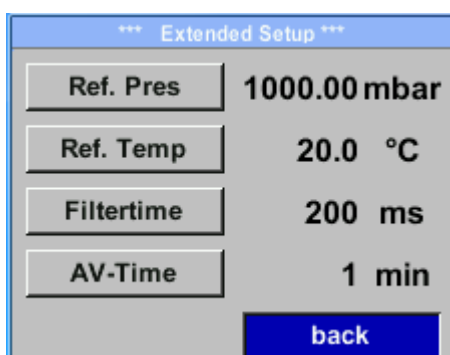

To make changes, first select a menu with button „Δ“ and confirm selection by pressing „OK“.

Setup → Sensor Setup → Advanced → Ref.Pref



In order to change, e.g. the unit, first select by pressing key „Δ“ the field „Units“ and then key „OK“.

Select with the key „Δ“ the correct unit and then confirm selection by pressing 2x „OK“.

Input / change of the value by selecting the respective position with button „Δ“ and entering by pressing button „OK“.

Setup → Sensor Setup → Advanced → Ref.Temp

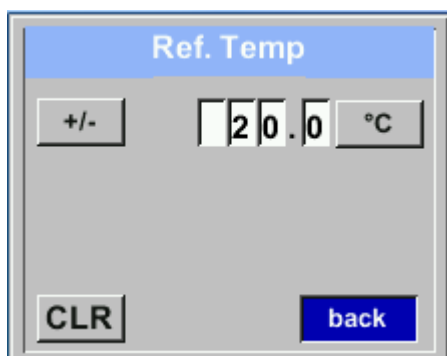

By pressing „Δ“ the position value is incremented by 1. Complete with „OK“ and activate next number position.

Procedure for changing the reference temperature is the same.

Setup → Sensor Setup → Advanced → Filtertime

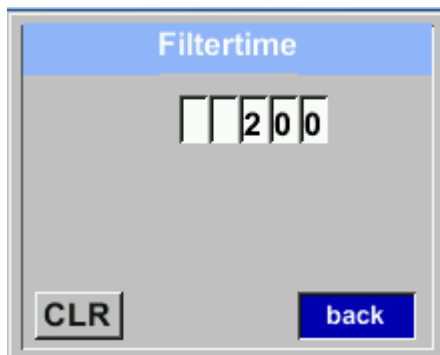

Under item **"Filtertime"** an attenuation can be defined.
Input values of 0 -10000 in [ms] are possible

Setup → Sensor Setup → Advanced → AV-Time

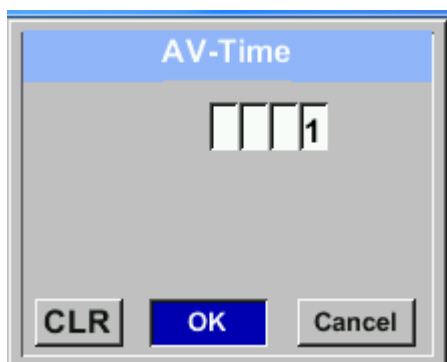

The time period for averaging can be entered here.
Input values of -1440 1 [minutes] are possible.
For average values see display window 3 + 4

11.3.1.5 Setting of Zero point and Low-flow cut off

Setup → Sensor Setup → ZP Adjust

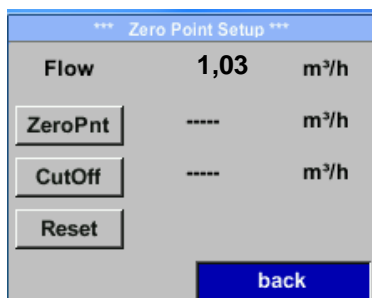

To make changes, first select a menu with button „ Δ “ and confirm selection by pressing „OK“.

Setup → Sensor Setup → ZP Adjust → ZeroPnt

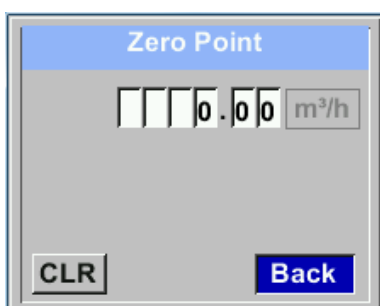

When, without flow, the installed sensor shows already a flow value of > 0 m³/h herewith the zero point of the characteristic could be reset.

For an input / change of the value select with the button „ Δ “ the respective number position and activate it with „OK“.

By pressing „ Δ “ the position value is incremented by 1. Confirm the input with „OK“ and activate next number position.

Leave menu with button „Back“

Setup → Sensor Setup → ZP Adjust → CutOff

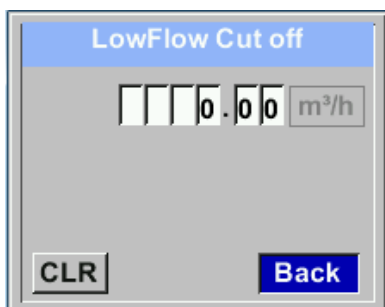

With the low-flow cut off activated, the flow below the defined "LowFlow Cut off" value will be displayed as 0 m³/h and not added to the consumption counter.

For an input / change of the value select with the button „ Δ “ the respective number position and activate it with „OK“.

By pressing „ Δ “ the position value is incremented by 1. Confirm the input with „OK“ and activate next number position.

Leave menu with button „Back“

Setup → Sensor Setup → ZP Adjust t → Reset

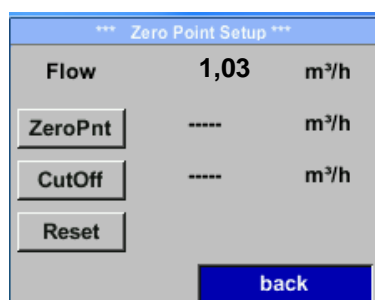

By selection of „Reset“ all settings for „ZeroPnt“ and „CutOff“ are reset.

Menu item to be select with button „ Δ “ and confirm the reset with „OK“.

Leave menu with button „Back“

11.3.2 Modbus settings

11.3.2.1 Modbus RTU Setup

The Flow sensors VA 520 comes with a Modbus RTU Interface. Before commissioning the sensor the communication parameters

- Modbus ID, Baudrate, Parity und Stop bit

must be set in order to ensure the communication with the Modbus master.

Settings → Modbus Setup

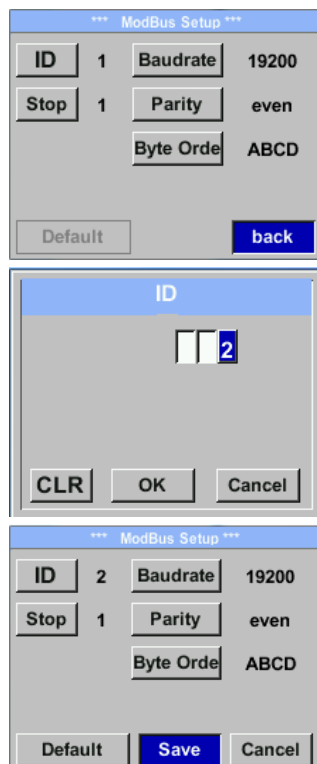

For changes, e.g. the sensor ID, first select by pressing key „△“ the field “ID” and then key “OK”.

Select the desired position by pressing the “>” and select with “OK” button.

Change values by pressing the „△“ values takeover by pressing “OK”.

Inputs for baud rate, stop bit and parity is done analogue.

By means of the button "Byte Order" it is possible to change the data format (Word Order). Possible formats are "ABCD" (Little Endian) and "CDAB" (Middle Endian)

Saving the changes by pressing “Save”, therefore select it with key „△“ and then confirm it with “OK”.

Default values out of factory: Modbus ID: 1
 Baud rate: 19200
 Stop bit: 1
 Parity: even
 Byte Order: ABCD

Remark: If the sensor is placed at the end of the Modbus system a termination is required. The sensors have an internal switchable termination, therefore the 6 fastening screws from the lid are to be released and set the internal DIP Switch to “On”.

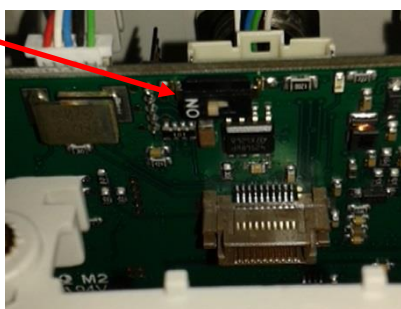
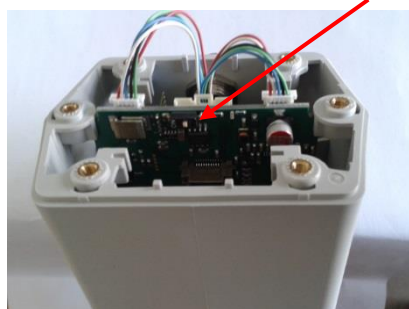

Alternatively, a 120R resistor can be installed in the plug between pin 2 and pin 4.

It must be ensured that the connection plugs are still plugged and the gasket is installed correctly, see also chapter 4.5.

11.3.2.2 Modbus TCP (Optional)

The Flow sensors VA 520 comes optional with a Modbus TCP Interface (HW Interface: M12 x 1 X-coded connector).

Device supports with this option the Modbus TCP protocol for communication with SCADA systems. TCP port is set to 502 by default. Port can be changed at the sensor or using PC Service Software

Modbus device address (Unit Identifier) can be set in the range of 1- 255.

Specification and description of the Modbus protocol is free to download on: www.modbus.org.

Supported Modbus commands (functions):

Command	Code	Description
Function Code	3	(Read holding register)
Function code	16	(Write multiple registers)

For more details, please see **VA 5xx Modbus RTU_TCP Installation V1.04**

Settings → Network Setup

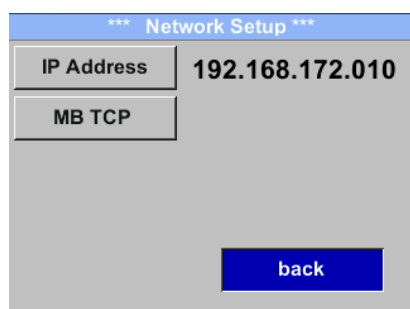

11.3.2.2.1 Network Setup DHCP

Settings → Network Setup Settings → IP Address

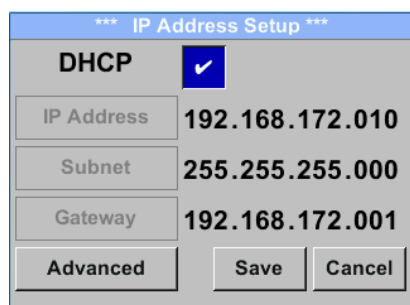

Here you can set up and made a connection, with or without *DHCP*, to a computer.

Remark:
With activated *DHCP* the automatic integration of the sensor in an existing network is possible, without a manual configuration.

Storing of settings by pressing “*Save*”

11.3.2.2.2 Network Settings static IP

Settings → Network Setup Settings → IP Address → IP Address

Settings → Network Setup Settings → IP Address → Sub Net

Settings → Network Setup Settings → IP Address → Gateway

*** IP Address Setup ***

DHCP

IP Address 192.168.172.010

Subnet 255.255.255.000

Gateway 192.168.172.001

Advanced back

*** IP Address Setup ***

DHCP

IP Address 192.168.172.010

Subnet 255.255.255.000

Gateway 192.168.172.001

Advanced back

IP Setup

1 9 2

CLR back

For manual (static) IP, the "IP Address", "Subnet" and "Gateway" selection keys must be selected and activated with "OK".

The first data field of the selection, in this case the IP address, is then marked (red).

Confirm with "OK" the corresponding input menu is opened.

By means of ">", the next data field is changed.

Select the desired position with the ">" key and activate it with the "OK" key.

Change the values with the ">" key, and accept the values with the "OK" key.

Procedure for "Subnet" and "Gateway" is analogous.

Subnet Setup

2 5 5

CLR back

Gateway Setup

1 9 2

CLR back

*** IP Address Setup ***

DHCP

IP Address 192.168.172.011

Subnet 255.255.255.000

Gateway 192.168.172.001

Advanced Save Cancel

Store the settings by „Save“

11.3.2.2.3 Modbus TCP Settings

Settings → Network Setup Settings → IP Address → MB TCP

Settings → Network Setup Settings → IP Address → ID

Settings → Network Setup Settings → IP Address → Port

For changes, e.g. the sensor ID, first select by pressing key „>“ the field “ID” and then key “OK”.

Select the desired position by pressing the ">" and select with "OK" button.

Change values by pressing the „>“ values takeover by pressing "OK".

Input for the port is done analogue.

By means of the button "Byte Format" it is possible to change the data format (Word Order). Possible formats are "ABCD" (Little Endian) and "CDAB" (Middle Endian)

Saving the changes by pressing "Save", therefore select it with key „>“ and then confirm it with "OK".

Reset to the default settings by activating "Set to Default"-

11.3.2.3 Modbus Settings (2001...2005)

Modbus Register	Register Address	No. of Byte	Data Type	Description	Default Setting	Read Write	Unit /Comment
2001	2000	2	UInt16	Modbus ID	1	R/W	Modbus ID 1...247
2002	2001	2	UInt16	Baud rate	4	R/W	0 = 1200 1 = 2400 2 = 4800 3 = 9600 4 = 19200 5 = 38400
2003	2002	2	UInt16	Parity	1	R/W	0 = none 1 = even 2 = odd
2004	2003	2	UInt16	Number of Stop bits		R/W	0 = 1 Stop Bit 1 = 2 Stop Bit
2005	2004	2	UInt16	Word Order	0xABCD	R/W	0xABCD = Big Endian 0xCDAB = Middle Endian

11.3.2.4 Values Register (1001 ...1500)

Modbus Register	Register Address	No. of Byte	Data Type	Description	Default	Read Write	Unit /Comment
1101	1100	4	Float	Flow in m ³ /h		R	
1109	1108	4	Float	Flow in Nm ³ /h		R	
1117	1116	4	Float	Flow in m ³ /min		R	
1125	1124	4	Float	Flow in Nm ³ /min		R	
1133	1132	4	Float	Flow in ltr/h		R	
1141	1140	4	Float	Flow in Nltr/h		R	
1149	1148	4	Float	Flow in ltr/min		R	
1157	1156	4	Float	Flow in Nltr/min		R	
1165	1164	4	Float	Flow in ltr/s		R	
1173	1172	4	Float	Flow in Nltr/s		R	
1181	1180	4	Float	Flow in cfm		R	
1189	1188	4	Float	Flow in Ncfm		R	
1197	1196	4	Float	Flow in kg/h		R	
1205	1204	4	Float	Flow in kg/min		R	
1213	1212	4	Float	Flow in kg/s		R	
1221	1220	4	Float	Flow in kW		R	

Modbus Register	Register Address	No.of Byte	Data Type	Description	Default	Read Write	Unit /Comment
1269	1268	4	UInt32	Consumption m ³ before comma	x	R	
1275	1274	4	UInt32	Consumption Nm ³ before comma	x	R	
1281	1280	4	UInt32	Consumption ltr before comma	x	R	
1287	1286	4	UInt32	Consumption Nltr before comma	x	R	
1293	1292	4	UInt32	Consumption cf before comma	x	R	
1299	1298	4	UInt32	Consumption Ncf before comma	x	R	
1305	1304	4	UInt32	Consumption kg before comma	x	R	
1311	1310	4	UInt32	Consumption kWh before comma	x	R	
1347	1346	4	Float	Velocity m/s			
1355	1354	4	Float	Velocity Nm/s			
1363	1362	4	Float	Velocity Ft/min			
1371	1370	4	Float	Velocity NFt/min			
1419	1418	4	Float	GasTemp °C			
1427	1426	4	Float	GasTemp °F			

Remark:

- **For DS400 / DS 500 / Handheld devices - Modbus Sensor Datatype**
„Data Type R4-32“ match with „Data Type Float“
- For more additional Modbus values please refer to
VA5xx_Modbus_RTU_Slave_Installation_1.09_EN.doc

11.3.3 Pulse /Alarm

Setup → Sensor Setup → Pulse/ Alarm

Relay Mode:	Alarm
Unit	°C
Value	20.0
Hyst.	5.0
Hi-Lim.	OK Cancel

*** Pulse / Alarm ***	
Relay Mode:	Alarm
Unit:	°C
Value	20.0
Hyst.	5.0
Hi-Lim.	OK Cancel

*** Pulse / Alarm ***	
Relay Mode:	Pulse
Unit:	m ³
Value	0.1
Polarity	pos.
Pls per second at max Speed: 0 Back	

The galvanically isolated output can be defined as pulse- or alarm output. Selection of field „Relay Mode” with key „△” and change modus by pressing key „OK”.

For alarm output following units could be chosen: kg/min, cfm, ltr/s, m³/h, m/s, °F, °C and kg/s.

„Value” defines the Alarm value, „Hyst.” defines the desired hysteresis and with „Hi-Lim” or „Lo-Lim” the alarm settings when the alarm is activated
 Hi-Lim: Value over limit
 Lo-Lim: Value under limit

For the pulse output following units could be chosen: kg, cf, ltr and m³. The pulse value definition to be done in menu „Value”. Lowest value is depending on max. flow of sensor and the max frequency of pulse output of 50Hz.

With „Polarity” the switching state could be defined. Pos. = 0 → 1 neg. 1 → 0



11.3.3.1 Pulse output

The maximum frequency for pulse output is 50 pulses per second (50Hz). The Pulse output is delayed by 1 second.

Pulse value	[m ³ /h]	[m ³ /min]	[l/min]
0.1 ltr / Pulse	18	0,3	300
1ltr / Pulse	180	3	3000
0.1m ³ / Pulse	18000	300	300000
1 m ³ / Pulse	180000	3000	3000000

Table 1 Maximum flow for pulse output

Entering pulse values that are not allow a presentation to the full scale value, are not allowed. Entries are discarded and error message displayed.

11.3.4 User Setup

11.3.4.1 Password

Settings → UserSetup → Password

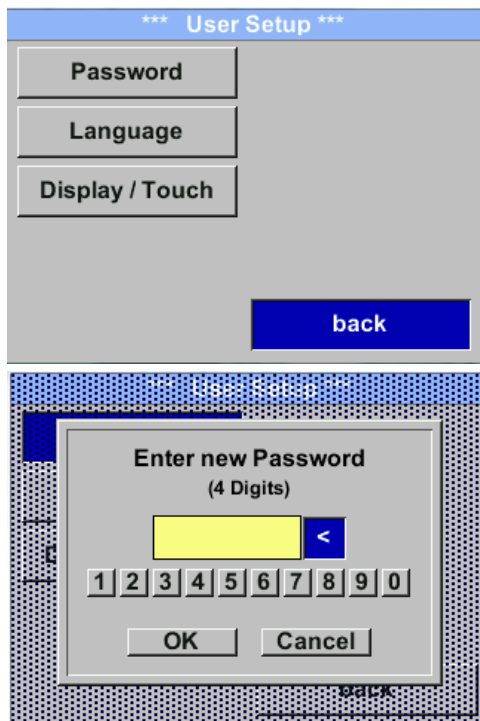

To make changes, first select a menu with button „ Δ “ and confirm selection by pressing „OK“.

It is possible to define a password. The required password length is 4 digits. Please select with button „ Δ “ a figure and confirm it with „OK“. Repeat this 4 times.

With „ Δ “ the last figure could be deleted. Password input have to be inserted twice.

Confirmation of input/password by pressing „OK“.

Factory settings for password at the time of delivery: 0000 (4 times zero).

11.3.4.2 Language

Settings → UserSetup → Language

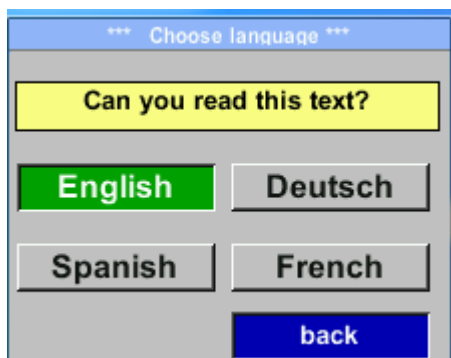

Currently 4 languages have been implemented and could be selected with button „ Δ “

Change of language by confirming with “OK”. Leaving the menu with button “back”.

11.3.4.3 Display / Touch

Settings → UserSetup → Display / Touch

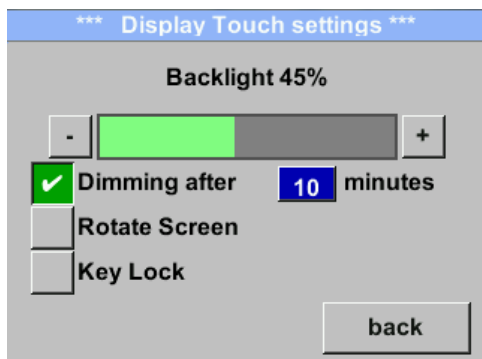

With the button „-“ and with button „+“ it is possible to adjust the backlight / display brightness. The actual / adjusted backlight brightness is showed in the graph „**Backlight.**“

By activation “**Dimming after**” and entering a time a display dimming could be set.

With „**Rotate Screen**“ the display information could be rotated by 180°.

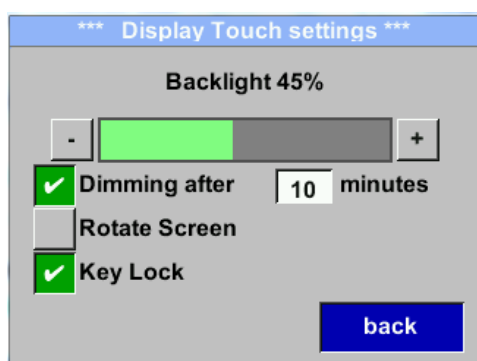

By activation of „**Key Lock**“ the operation of the sensor locked.

Unlocking the keyboard is only possible by restarting the sensor and calling the operating menu within the first 10s. To do this, use the “**OK**” button to enter the operating menu during this period

11.3.5 Advanced

Settings → Advanced

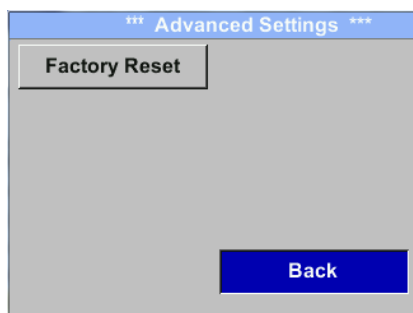

By pressing „**Factory Reset**“ the sensor is set back to the factory settings.

11.3.6 4 -20mA

Settings → 4-20mA

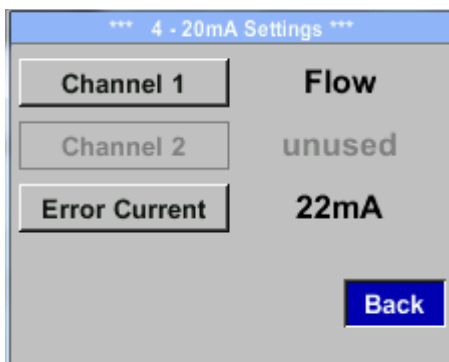

To make changes, first select a menu with button „ Δ “ and confirm selection by pressing „OK“.

Settings → 4-20mA → Channel 1

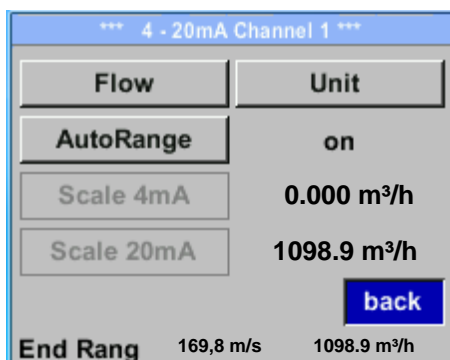

The 4-20 mA Analogue output of the Sensor VA 520 can be individually adjusted.

It is possible to assign following values „Temperature“, „Velocity“ und „Flow“ to the channel CH 1.

To make changes, first select the value item with button „ Δ “ .and confirm
Moving between the different measurements values or to deactivate the 4-20mA with setting to „unused“ by pressing „OK“.

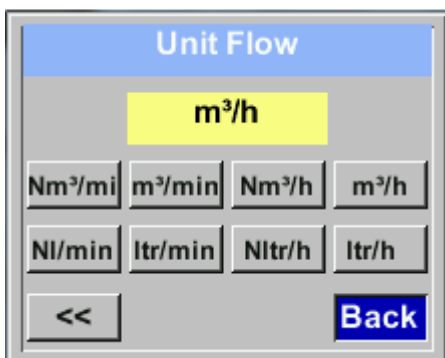

To the selected measurement value a corresponding / appropriate unit needs to be defined. Select „Unit“ with „ Δ “ and open menu with „OK“. Select required unit with „ Δ “ and take over by pressing „OK“.

Here e.g. for the measurement value Flow, procedure for the other measurements values is analog.

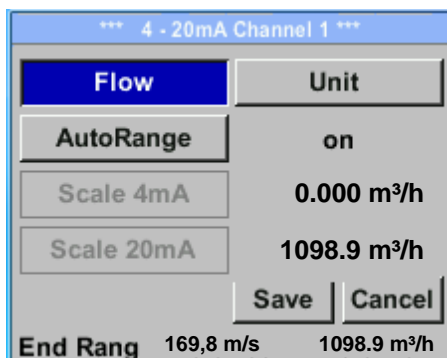

For saving the changes done press button „Save“ to discard the changes press button „Cancel“.

Leaving the menu with „Back“.

Settings → 4-20mA → Channel 1 → AutoRange

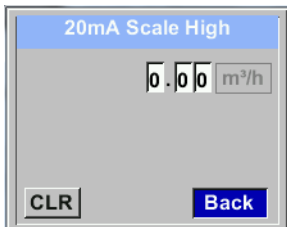
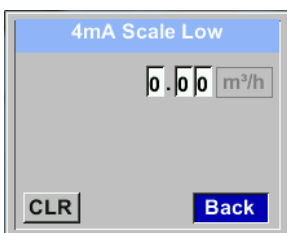
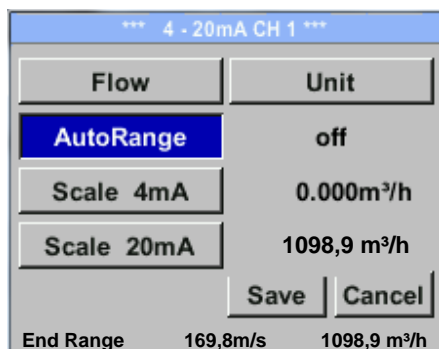

The scaling of the 4-20mA channel can be done automatically "Auto Range = on" or manual "AutoRange = off" .

With button „ Δ “ select the menu item „AutoRange“ select with „OK“ the desired scaling method. (Automatically or manually)

In case of **AutoRange = off** with „Scale 4mA“ und „Scale 20mA“ the scale ranges needs to be defined.

Select with button „ Δ “ the item „Scale 4mA“ or „Scale 20mA“ and confirm with „OK“ .

Input of the scaling values will be analogous as described before for value settings.

Using „CLR“ clears up the complete settings at once.

For „Auto on“ , the max. scaling is calculated based on the inner tube diameter, max. measurement range and the reference conditions settings.

Takeover of the inputs with „Save“ and leaving the menu with „Back“.

Settings → 4-20mA → Error Current

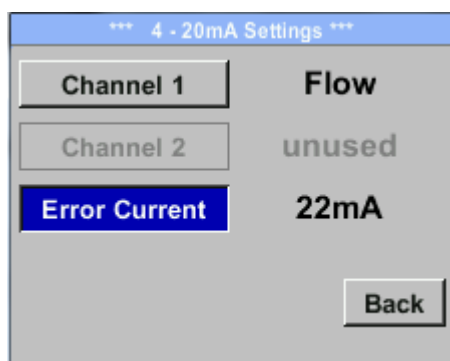

This determines the output in case of an error at the analog output.

- 2 mA Sensor error / System error
- 22 mA Sensor error / System error
- None Output according Namur (3.8mA – 20.5 mA)
< 4mA to 3.8 mA Measuring range under range
>20mA to 20.5 mA Measuring range exceeding

To make changes first select a menu item "Current Error" with button „ Δ “ and then select by pressing the „OK“ the desired mode

For saving the changes done press button „Save“ to discard the changes press button „Cancel“.

Leaving the menu with „Back“.

11.3.7 VA 520 Info

Settings → Info

*** Info ***	
Production Datas	
Serial No.:1234567890	Details
Cal. Date: 10.01.2013	
Sensor Datas	
Sensor Type: IST 1.8	
Max Speed: 92,7 m/s	600m³/h
Max Temp: 100.0 °C	
Live Datas	
Run Time: 2d 21h 23m 12s	
Vin: 23,8V	Temp: 35,8
Options	Back

*** Calibration Details ***	
Calibration Conditions	
Ref. Pressure:	1000.00mbar
Ref. Temperature:	20 °C
Cal. Diameter:	53,1 mm
Cal. Pressure:	6000.00mbar
Cal. Temperature:	23 °C
Cal. Points:	10
Back	

Here you get a brief description of the sensor data incl. the calibration data.

Under *Details*, you are able to see in addition the calibration conditions.

11.4 M-Bus

The screenshot shows a configuration window titled 'M-Bus'. It contains the following fields and controls:

- Adr**: 1
- Baudrate**: 2400
- ID**: 123456
- Units as String**:
- back**: A blue button at the bottom right.

The screenshot shows the same configuration window as above, but with the 'Units as String' checkbox checked. Additionally, there are **Save** and **Cancel** buttons at the bottom.

The Sensor offers two possibilities for coding the Value Information Field (VIF).

- Primary VIF (The units and multiplier correspond to M-Bus specification 4.8 chapter 8.4.3)
- Plain text VIF ((units are transmitted as ASCII characters. So units that are not included in M-Bus specification chapter 8.4.3 are possible)

Download:

<https://m-bus.com/assets/downloads/MBDOC48.PDF>

Switch to Plain Text VIF by activation of „Units as String“.

11.4.1 Default Settings communication

Primary Address*:	1
ID:	Serial number of Sensor
Baud rate*:	2400
Medium*:	depending on medium (Gas or Compressed Air)
Manufacturer ID:	CSI
VIF coding:	Primary VIF

Both addresses, Primary address and ID, could be automatic searched in the M-Bus system.

11.4.2 Default values transmitted

Value 1 with [Unit]*:	Consumption [m ³]
Value 2 with [Unit]*:	Flow [m ³ /h] Consumption [m ³]
Value 3 with [Unit]*:	Gas temperature [°C]

*All Values could be changed / preset in production or with CS Service software (Order-No. 0554 2007)

12 Status / Error messages

12.1 Status messages

- **CAL**

On the part of CS Instruments GmbH & Co.KG a regular re-calibration is recommended, see chapter 13. At delivery, the date at which the next recalibration is recommended is internally entered. When this date is reached, a message appears in the display with the status message „CAL“.

Note: The measurement will continue without interruption or restriction.

- **Direction**

When used in conjunction with a direction switch VA409, the status message "Direction" is displayed in case of opposite flow direction and no measurement may take place.

Status messages:

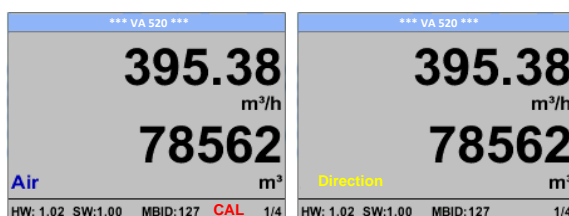

12.2 Error messages

- **Low Voltage**

If the supply voltage is less than 11V, the warning message „**Low Voltage**“ is displayed. This means that the sensor can no longer work / measure correctly and thus there are none measured values for flow, consumption and speed are available.

- **Heater Error**

The error message „**Heater Error**“ occurs in case of failure of the heating sensor.

- **Internal Error**

In the case of this message „**Internal Error**“, the sensor has an internal read error on e.g. EEPROM, AD converter etc. detected.

- **Temp out of Range**

At media temperatures outside the specified temperature range, the status message „**Temp out of Range**“ occurs.

This temperature overshoot leads to incorrect measurement values (outside the sensor specification).

- **Low Voltage 4-20mA**

For sensors with a galvanically isolated 4-20mA output, a min. Supply voltage of 17.5V is required. If this value is undershot, the error message „**Low Voltage 4-20mA**“ is displayed.

Error messages:

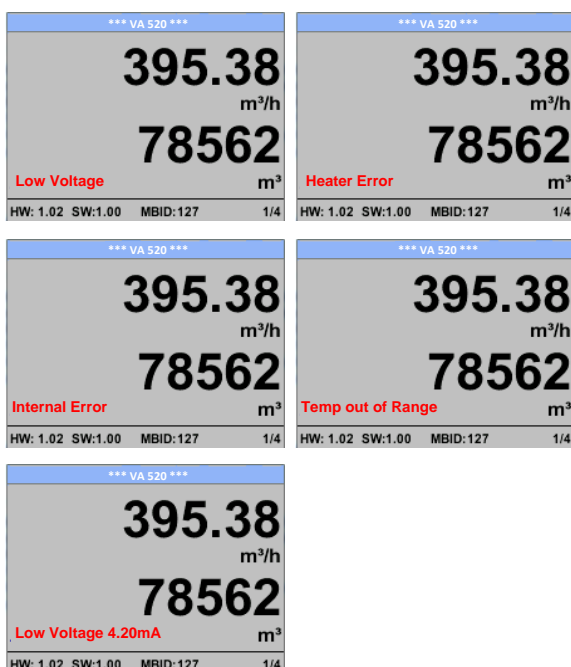

13 Maintenance

The sensor head should be checked regularly for dirt and cleaned if necessary. Should dirt, dust or oil accumulate on the sensor element, a deviation will occur in the measuring value. An annual check is recommended. Should the compressed air be heavily soiled this interval must be shortened.

14 Cleaning of the sensor head

The sensor head can be cleaned by carefully moving it in warm water with a small amount of washing-up liquid. Avoid physical intervention on the sensor (e.g. using a sponge or brush). If soiling cannot be removed, service and maintenance must be carried out by the manufacturer.

15 Re-Calibration

If no customer specifications are given then we recommend to carry out calibration every 12 months. For this purpose the sensor must be sent to the manufacturer.

16 Spare parts and repair

For reasons of measuring accuracy spare parts are not available. If parts are faulty, they must be sent to the supplier for repair.

If the measuring device is used in important company installations, we recommend keeping a spare measuring system ready.

17 Calibration

According to DIN ISO certification of the measuring instruments we recommend to calibrate and if applicable to adjust the instruments regularly from the manufacturer. The calibration intervals should comply with your internal specification. According to DIN ISO we recommend a calibration interval of one year for the instrument VA 520.

On request and additional payment, calibration-certificates could be issued. The precision is given due to use DKD-certified flow meters and verifiable

18 Warranty

If you have reason for complaint we will of course repair any faults free of charge if it can be proven that they are manufacturing faults. The fault should be reported immediately after it has been found and within the warranty time guaranteed by us. Excluded from this warranty is damage caused by improper use and non-adherence to the instruction manual.

The warranty is also cancelled once the instrument has been opened - as far as this has not been mentioned in the instruction manual for maintenance purposes - or if the serial number in the instrument has been changed, damaged or removed.

The warranty time for the VA 520 is 12 months. If no other definitions are given the accessory parts have a warranty time of 6 months. Warranty services do not extend the warranty time.

If in addition to the warranty service necessary repairs, adjustments or similar are carried out the warranty services are free of charge but there is a charge for other services such as transport and packaging costs. Other claims, especially those for damage occurring outside the instrument, are not included unless responsibility is legally binding.

After sales service after the warranty time has elapsed

We are of course there for you even after the warranty time has elapsed. In case of malfunctions, please send us the instrument with a short-form description of the fault. Please do not forget to indicate your telephone number so that we can call you in case of any questions.

KONFORMITÄTSERKLÄRUNG

DECLARATION OF CONFORMITY

Wir
We CS Instruments GmbH & Co. KG
Gewerbehof 14, 24955 Harsislee

Erklären in alleiniger Verantwortung, dass das Produkt
Declare under our sole responsibility that the product

Verbrauchs-/ Durchflusssensor VA 520
Flow Sensor VA520

den Anforderungen folgender Richtlinien entsprechen:
We hereby declare that above mentioned components comply with requirements of the following EU directives:

Elektromagnetische Verträglichkeit Electromagnetic compatibility	2014/30/EU 2014/30/EC
RoHS (Restriction of certain Hazardous Substances)	2011/65/EC

Angewandte harmonisierte Normen:

Harmonised standards applied:

EMV-Anforderungen EMC requirements	EN 55011: 2011-04 EN 61326-1: 2013-07
---------------------------------------	--

Anbringungsjahr der CE Kennzeichnung: 15

Year of first marking with CE Label: 15

Das Produkt ist mit dem abgebildeten Zeichen gekennzeichnet.
The product is labelled with the indicated mark.



Harsislee, den 14.01.2021

Wolfgang Blessing Geschäftsführer