

Application, Export, and Reconstruction

1. This product may be used for model airplane or surface use if on the correct frequency. The product described in this manual is subject to regulations of the Ministry of Radio/Telecommunications and is restricted under Japanese law to such purposes.
2. Exportation precautions
 - (a) When this product is exported from Japan, its use is to be approved by the Radio Law of the country of destination.
 - (b) Use of this product with other than models may be restricted by Export and Trade Control Regulations. An application for export approval must be submitted.
3. Modification, adjustment, and replacement of parts
Futaba is not responsible for unauthorized modification, adjustment, and replacement of parts of this product.

The Following Statement Applies to the Receiver (for U.S.A.)

This device complies with part 15 of the FCC rules. Operation is subject to the following two conditions:

- (1) This device may not cause harmful interference, and
- (2) This device must accept any interference received, including interference that may cause undesired operation.

The RBRC™ Seal (for U.S.A.)

The RBRC™ SEAL on the (easily removable) nickel-cadmium battery contained in Futaba products indicates that Futaba Corporation of America is voluntarily participating in an industry program to collect and recycle these batteries at the end of their useful lives, when taken out of service within the United States. The RBRC™ program provides a convenient alternative to placing used nickel-cadmium batteries into the trash or municipal waste which is illegal in some areas.

Futaba Corporation of America's payments to RBRC™ makes it easy for you to return the spent battery to Futaba for recycling purposes. You may also contact your local recycling center for information on where to return the spent battery. Please call 1-800-8-BATTERY for information on Ni-Cd battery recycling in your area. Futaba Corporation of America's involvement in this program is part of its commitment to protecting our environment and conserving natural resources.



NOTE: Our instruction manuals need to encourage our customers to return spent batteries to Futaba or a local recycling center in order to keep a healthy environment.

RBRC™ is a trademark of the Rechargeable Battery Recycling Corporation.

Meaning of Special Markings

Pay special attention to the safety at the parts of this manual that are indicated by the following marks.

⚠ DANGER :Procedures which may lead to a dangerous condition and cause death or serious injury to the user if not carried out properly.

⚠ WARNING :Procedures which may lead to a dangerous condition or cause death or serious injury to the user if not carried out properly, or procedures where the probability of superficial injury or physical damage is high.

⚠ CAUTION :Procedures where the possibility of serious injury to the user is small, but there is a danger of injury, or physical damage, if not carried out properly.

Symbol:  ; Prohibited  ; Mandatory

INSTRUCTION MANUAL

6XAs / 6XHs
FOR AIRCRAFT / HELICOPTERS
FM/PCM SYSTEM, 6 CHANNELS

Futaba Corporation

INTRODUCTION

Thank you for purchasing a Futaba® 6XAs/6XHs series digital proportional R/C system. This system is extremely versatile and may be used by both beginners and experts. In order for you to make the best use of your system and to fly safely, please read this manual carefully. If you have any difficulties while using your system, please consult the manual, your hobby dealer, or Futaba. This product is to be used for sport and recreational flying of radio-control models only. Futaba is not responsible for the results of use of this product by the customer or for any alteration of this product, including modification or incorporation into other devices by third parties. Modification will void any warranty and is done at owner's risk..

Your T6XAs or T6XHs system includes the following components:

- T6XAs/T6XHs Transmitter. May be programmed for planes or helicopters, both with special mixing function, 6 model memories. (Transmitting frequency: 29, 35, 36, 40, 41, 50, 60 or 72 Mhz band)
- R127DF or R116FB Receiver (FM system). R138DP or R148DP Receiver (PCM system). (Receiving frequency: 29, 35, 36, 40, 41, 50, 60 or 72 Mhz band)
- Servos, S3003 with mounting hardware and servo arm assortment (or S148 Servo)
- Receiver battery (or Battery Box)
- Switch harness with charging jack
- Aileron extension cord (use to easily connect to an aileron servo in a detachable wing)
- AC battery charger
- Owner's Manual

Owner's Manual

This manual is not just a translation — it has been carefully written from scratch to be as helpful to you, the new owner, as possible. There are many pages of setup procedures, examples, explanations, and trimming instructions. If you feel that any corrections or clarifications should be made, please jot them down on a piece of paper and send them to the factory. The information contained in this manual is subject to change without notice due to possible changes in manufacturing procedures or updates.

“Futaba” is a registered trademark of the Futaba Corporation of America.

Manual text copyright ©1996 by Don Edberg, Dynamic Modelling Co. All rights reserved

TABLE OF CONTENTS

Introduction to the T6XAs/T6XHs System	1
ACRO Transmitter Controls and Switch Identification	2
ACRO & HELI Transmitter Switch Functions	2
Charging the Ni-Cd Battery	3
Operating With The Trainer Cord	3
Adjusting Stick Length & Tension	4
Changing Transmitter Mode	5
Reversing The Throttle Stick	5
ACRO Receiver and Servo Connections	6
Radio Installation Precautions	7
Airplane Frequencies (U.S.A.)	9
Transmitter Displays and Programming Keys	10
Warning Displays	11
Safety Precautions (DO NOT operate without reading)	12

AIRCRAFT FUNCTIONS INDEX (ACRO Menu) 13

Aircraft (ACRO) Functions Diagram	14	
Aircraft Setup Example (Pattern model)	15	
Pattern Aircraft Trimming Chart	22	
ATV	Adjustable Travel Volume	24
D/R	Dual Rates	25
EXP	Exponential Settings	26
REV	Servo Reverse	27
STRM	Subtrim	27
FLPR	Flaperon (combined flaps & ailerons)	28
FLTR	Flap trim	29
ABRK	Airbrake settings	30
VTAL	V-tail mixing	31
ELVN	Elevon mixing (tailless models)	32
1->4	Rudder Coupling	33
6->2	Flap -> Elevator mixing	34
2->6	Elevator -> Flap mixing	35
PMX1, 2	Programmable Mixer #1, #2	35
F/S	Failsafe function (only in PCM mode)	37
PARA	Parameter menu	38
REST	Data Reset	38

DRSW..... Dual Rate Switch Select.....	39
ACRO Acrobatic model mode	39
HELI..... Helicopter model mode	39
MOD Modulation (FM/PPM or PCM).....	40
COPY Data Copy	40
TMEM..... Trim Memory	41
MODL Model select	42

HELICOPTER SECTION INDEX	43
--------------------------	----

Helicopter (HELI) Functions Index	43
Helicopter Function Menu Diagram	43
Helicopter Transmitter Controls and Switch Identification.....	44
Helicopter Setup Instructions.....	45
Helicopter Trimming Chart.....	48
PI-N, I, H Pitch Rate (Normal, Idle-Up, Hovering).....	49
HV-T Hovering Throttle.....	49
IDLE..... Idle-Up function	50
HOLD..... Throttle Hold.....	51
REVO Revolution mixing.....	51
R-OF Rudder Offset	52
HV-P Hovering Pitch	53
SWSH..... Swashplate Type & AFR	53
Glossary.....	55
Data Recording Sheets: ACRO, HELI.....	56
Factory Repair Service	57

Introduction to the 6XAs/6XHs Systems

TRANSMITTER

The versatile T6XAs/T6XHs PCM1024 multi-function 6-channel transmitter may be used with any Futaba FM/PPM receiver! In addition, your system will work with Futaba PCM1024 receivers when you select the built-in PCM transmission option. The liquid-crystal display panel allows rapid data input into its easy-to-read LCD display.

The T6XAs/T6XHs system comes complete with programming for ACRO (aircraft) and HELI (helicopter) mixing and can accommodate virtually any model configuration. The compact, ergonomically-designed transmitter holds completely independent memories for six different models.

The T6XAs/T6XHs features a new stick design which provides an improved feel. The sticks' length and tension may be adjusted. Switches are provided for dual rate (D/R), programmable mixers (PMX), and other functions. For those learning to fly, the transmitter has "buddy-box" capability where a second transmitter may be used by an experienced pilot as an instructor. [The trainer cord is sold separately.]

Standard programming features include servo reversing for all channels, ATV on all channels, dual rates, exponential, and fail safe on all channels (PCM transmission only). In addition, the T6XAs/T6XHs features a number of handy mixing features applicable to all types of flying models. For aircraft, the extensive

preprogrammed mixing features include: flaperon, V-tail, elevon, airbrake, elevator -> flap, and flap -> elevator. Helicopter features include hovering pitch and throttle, revolution mixing, swashplate type selection, and rudder offset. [Note: the T6XAs/T6XHs may be used for sailplanes. For these we recommend Futaba's System 8, which contains extensive sailplane programming.]

Transmitter Specifications:

Operating system: 2-stick, 6 channels, PCM1024 system
Modulation: FM/PPM or PCM, switchable
Power supply: 9.6V Ni-Cd battery
Current drain: 250mA

RECEIVER

The R127DF seven-channel receiver included with your system is a compact high-sensitivity narrow-band unit, providing superior range and performance.

Receiver Specifications (FP-R127DF)

Type: FM, Dual conversion
Intermediate frequencies: 455kHz, 10.7MHz
Power requirement: 4.8V or 6V Ni-Cd battery
Current drain: 14mA @ 4.8V
Size: 1.39x2.52x0.82" (35.3x64.0x20.8mm)
Weight: 1.5oz (42.5g)

Receiver Battery

4-cell NR-4J (NR-4RB for heli version)
Capacity: 500mAH (1,000mAH for NR-4RB)
Weight: 3.3oz/94g (3.9oz/111g for NR-4RB)

SERVO SPECIFICATIONS

Servo type: S3003 (Standard)
Control system: Pulse width control, 1.52ms neutral
Power requirement: 4.8V (from receiver)
Output torque: 44.4oz-in (3.2kg-cm)
Operating speed: 0.23sec/60°
Size: 1.59x0.78x1.41" (40.4x19.8x36mm)
Weight: 1.3oz (37.2g)

*Specifications and ratings are subject to change without notice.

TRANSMITTER CONTROLS – AIRCRAFT (T6XAs System)

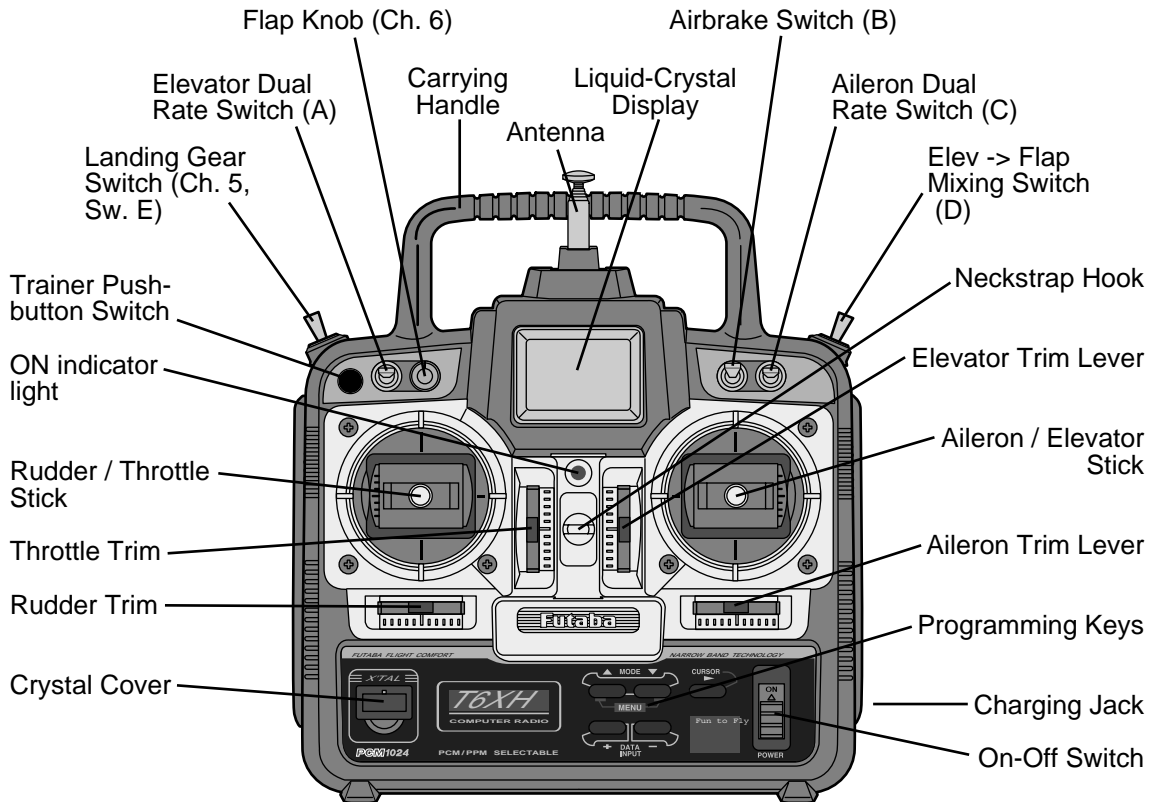

This figure shows the default assignments for a Mode 2 aircraft system as supplied by the factory.

SWITCH ASSIGNMENT TABLE

The functions activated by the switches and knobs for a Mode 2 transmitter are shown in the table below. Note that some of the functions will not operate until activated in the mixing menus. For a Mode 1 transmitter, elevator and throttle are reversed, as are switches D and E.

Switch / Knob	ACRO	HELI
Switch A	Up = Elevator Dual Rate 1; Down = PMX1 & PMX2 on; Elev D/R 2	Up = Elevator Dual Rate 1; Down = Elev D/R 2
Switch B	Down = Airbrake on	Gyro sensitivity (if desired)
Switch C	Up = Aileron Dual Rate 1 Down = Aileron Dual Rate 2	Up = Aileron Dual Rate 1 Down = Aileron Dual Rate 2
Switch D	Forward = 2 -> 6 (Elev -> Flap) on	Forward = Throttle Hold on, and REVO off
Switch E	Landing Gear	Forward = Idle-up on, Rudder offset on, and REVO off
Switch F (Push-button)	Trainer	Trainer
CH6 knob	Flap or Flap trim if flaperon function (FLPR) on	Hovering Pitch

CHARGING THE Ni-Cd BATTERIES

1. Connect the transmitter charging cord into the charging socket (on the right of the case, when facing the front) and airborne Ni-Cd batteries to the receiver connector on the charger.
2. Plug the charger into a wall socket.
3. The charger's LEDs should light, indicating charging current is flowing. The batteries should be left on charge for about 15 hours.

⚠ CAUTION

❗ Only charge the batteries with the charger supplied with your system. The use of a fast charger may damage the batteries by overheating and dramatically reduce their lifetime.

❗ You should fully discharge your system's batteries periodically to prevent a condition called "memory." For example, if you only make two flights each session, or you regularly use only a small amount of the batteries' capacity, the memory effect can reduce the actual capacity even if the battery is fully charged. You can cycle your batteries with a commercial cycling unit, or by leaving the system on and exercising the servos by moving the transmitter sticks. Cycling should be done every one to two months, even during the winter or periods of long storage. Keep track of the batteries' capacity during cycling; if there is a noticeable change, you may need to replace the batteries.

NOTE: If you need to remove or replace the transmitter battery, do not pull on its wires to remove it. Instead, gently pull on the connector's plastic housing where it plugs in to the transmitter.

Operating With The Trainer Cord

An optional training cord is available from your dealer. The cord may be used to help a beginning pilot learn to fly easily by allowing a second transmitter, operated by an experienced instructor, to be connected to this system. The instructor may override the beginning pilot at any time to bring the model back under safe control. For training, the T6XAs/ T6XHs transmitter may be connected to another T6XAs/XHs system, as well as to any 4VF, 6VA Skysport, 6XA, Super 7, System 8, or 9Z series transmitter.

To use the trainer cord:

1. Set up both the student's and instructor's transmitters to have identical trim and control motions. If the instructor's transmitter is on a different frequency than the student's, use the student's as the master transmitter and the other as the student's.

2. Set the student transmitter modulation mode to PPM. Collapse the student's antenna, and fully extend the instructor's antenna. Remove the RF module from the transmitter held by the student (if it is a module-type transmitter).
3. Plug one end of the trainer cord into each transmitter, with power switched off. The trainer jack is in the center of the rear face of the transmitter. Do not force, the connector is keyed.
4. Turn on the instructor's transmitter. DO NOT turn on the student transmitter power. Move the controls on the instructor's transmitter, and verify each control moves the proper direction. Now verify that the student's trims and control travels match the instructor's by using the trainer button and switching back and forth while leaving the control sticks and trims alone, then moving the control sticks.
5. The instructor's transmitter has normal control over the model unless the trainer button is pushed, when the student's has control. If control is lost, the instructor should release the trainer button and resume controlling the model.

OTHER T6XAS/XHS ADJUSTMENTS

Adjustable length non-slip control sticks

You may change the length of the control sticks to make your transmitter more comfortable to hold and operate. To lengthen or shorten your transmitter's sticks, first unlock the stick tip by holding locking piece B and turning stick tip A counterclockwise. Next, move the locking piece B up or down (to lengthen or shorten). When the length feels comfortable, lock the position by turning locking piece B counterclockwise.

Stick lever tension adjustment

You may adjust the stick tension of your sticks to provide the "feel" that you like for flying. To adjust your springs, you'll have to remove the rear case of the transmitter. Using a screwdriver, remove the four screws that hold the transmitter's rear cover into position, and put them in a safe place. Gently ease off the transmitter's rear cover. You may wish to unplug the battery wire. Carefully rotate the rear of the case you have access to the rear of the sticks. Now you'll see the view shown.

Using a small screwdriver, rotate the adjusting screw for each stick for the desired spring tension. The tension increases when the adjusting screw is turned clockwise, and

decreases for counterclockwise motion. When you are satisfied with the spring tensions, you may close the transmitter. Very carefully reinstall the rear cover. When the cover is properly in place, tighten the four screws.

Changing the T6XAs/Hs transmitter's mode

If you wish to change the mode of the transmitter, say from mode 1 to mode 2, turn on the transmitter holding the two MODE buttons down. You'll see a display "STCK X," where X is a number representing the current transmitter mode. Press the plus (+) or minus (-) DATA INPUT key to change the mode number as desired. You'll see the effect of you changes when you next turn on your transmitter. In some cases, you'll have to swap the throttle detent mechanism with the elevator centering mechanism. This can be done by Futaba.

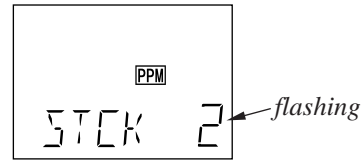

Reversing the throttle stick's action

If for some reason you wish to reverse the action of the throttle stick (for example, to get throttle trim at the top of the stick's travel), you may reverse it by turning on the transmitter holding the two MODE buttons down, then pressing either of the MODE buttons to get to the TREV menu. You may then use the (+) or (-) keys to switch between normal and reversed functioning.

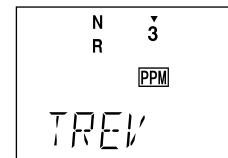

RECEIVER AND SERVO CONNECTIONS

Receiver output channel	Aircraft (ACRO)	Helicopter (HELI)
1	Right aileron or combined right flap + aileron* or right elevon [†] (tailless)	Aileron
2	Elevator or V-tail [‡] right side or left elevon [†] (tailless)	Elevator
3	Throttle	Throttle
4	Rudder or V-tail [‡] left side	Rudder
5	Landing Gear	Gyro sensitivity
6	Flap or combined Left flap + aileron*	Pitch

Multiple entries indicate that the servo function varies with the selected programming (*=FLPR mode, †=ELVN mode, ‡=VTAL mode). Outputs with no mixing functions are shown first.

The diagram below shows the default servo connections for a model using the ACRO mode (only three or four servos are included in the T6XAs system). Two possible model formats are shown on the ACRO contents page. Suggested helicopter connections are given within the helicopter setup example.

RADIO INSTALLATION

While you are installing the battery, receiver, and servos into your model's fuselage, please pay attention to the following guidelines:

⚠ CAUTION

Servo Notes

Mounting

❗ Use the supplied rubber grommets when you mount each servo. Be sure not to overtighten the screws. If any portion of the servo case directly contacts the fuselage or the servo rails, the rubber grommets will not attenuate vibration, which can cause mechanical wear and servo failure.

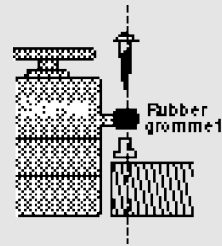

Servo Throw

❗ Once you have installed the servos, operate each one over its full travel and check that the pushrod and output arms do not bind or collide with each other, even at extreme trim settings. Check to see that each control linkage does not require undue force to move (if you hear a servo buzzing when there is no transmitter control motion, most likely there is too much friction in the control or pushrod). Even though the servo will tolerate loads like this, they will drain the battery pack much more rapidly.

Switch Harness Installation

When you are ready to install the switch harness, remove the switch cover and use it as a template to cut screw holes and a rectangular hole slightly larger than the full stroke of the switch. Choose a switch location on the opposite side of the fuselage from the engine exhaust, and choose a location where it can't be inadvertently turned on or off during handling or storage. Install the switch so that it moves without restriction and "snaps" from ON to OFF and vice versa.

Receiver Notes

Antenna

⊘ DO NOT cut or coil the receiver antenna wire. It is normal for the receiver antenna to be longer than the fuselage.

⊘ DO NOT cut it or fold it back on itself - cutting or folding changes the electrical length of the antenna and may reduce range. Secure the antenna to the top of

the vertical fin or the tailboom, and let the excess length trail behind the aircraft (be sure it cannot tangle with the tail rotor on a helicopter).

You may run the antenna inside of a *non-metallic* housing within the fuselage, but range may suffer if the antenna is located near metal pushrods or cables. Be sure to perform a range check before flying. With the antenna collapsed, you should be able to walk 20 - 30 paces from the model without losing control or seeing “jitter” in the servos.

Connectors

❶ When you insert servo or battery connectors into the receiver, note that each plastic housing has an alignment tab. Be sure the alignment tab is oriented properly before inserting the connector. To remove a connector from the receiver, pull on the connector housing rather than the wires.

Using The Aileron Extension

❶ If your aileron servo (or others) are located too far away to plug into the receiver, use an aileron extension cord to extend the length of the servo lead. Additional extension cords of varying lengths are available from your hobby dealer or Futaba.

Vibration and Waterproofing

The receiver contains precision electronic parts. Be sure to avoid vibration, shock, and temperature extremes.

❶ For protection, wrap the receiver in foam rubber or other vibration-absorbing materials. It’s also a good idea to waterproof the receiver by placing it in a plastic bag and securing the open end of the bag with a rubber band before wrapping it with foam. If you accidentally get moisture inside the receiver, you may experience intermittent operation or a crash.

Airplane Frequencies

The following frequencies and channel numbers may be used for flying aircraft in the U.S.:

72 MHz band

Ch. No.	MHz	36	72.510
12	72.030	37	72.530
13	72.050	38	72.550
14	72.070	39	72.570
15	72.090	40	72.590
16	72.110	41	72.610
17	72.130	42	72.630
18	72.150	43	72.650
19	72.170	44	72.670
20	72.190	45	72.690
21	72.210	46	72.710
22	72.230	47	72.730
23	72.250	48	72.750
24	72.270	49	72.770
25	72.290	50	72.790
26	72.310	51	72.810
27	72.330	52	72.830
28	72.350	53	72.850
29	72.370	54	72.870
30	72.390	55	72.890
31	72.410	56	72.910
32	72.430	57	72.930
33	72.450	58	72.950
34	72.470	59	72.970
35	72.490	60	72.990

Installing your frequency number indicator:

It's very important that you display your transmitting channel number at all times. To install your indicator, peel off the channel number's backing sheet, and carefully stick the numbers to both sides of the number holder. Now you can snap the number holder onto the lower portion of the antenna as shown in the figure – use the clip that fits more snugly on your antenna. You may wish to cut off the other, unused clip on the indicator.

TRANSMITTER DISPLAYS & BUTTONS

When you first turn on your transmitter, the screen shown below appears on the LCD display. Before flying, or even starting the engine, **BE SURE** that the model number appearing in the lower right of the display matches the model that you are about to fly! If you don't, servos may be reversed, and travels and trims will be wrong, leading to an immediate crash. (If you have trouble remembering which model memory to use, write them on a small piece of tape affixed to the front of the transmitter.)

Startup Screen (appears when system is first turned on)

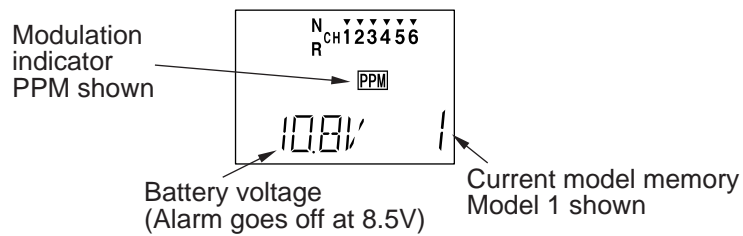

Edit keys

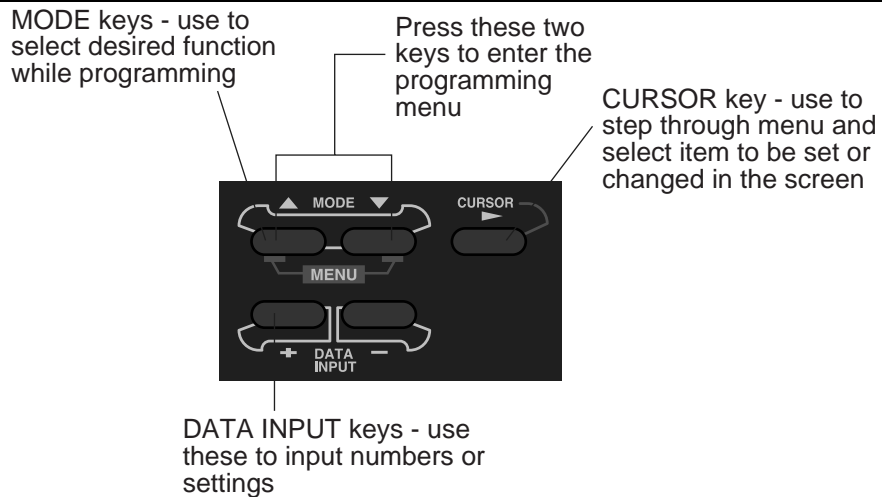

WARNING DISPLAYS

Your transmitter is designed to warn you about several potential problems that may occur, including low battery voltage and switching on with mixing functions active. Each display has a unique sound associated with it, as described below.

Low battery

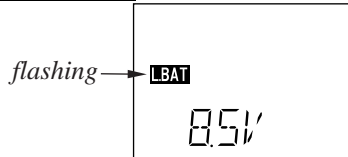

The LOW BATTERY warning is displayed when the transmitter battery voltage drops below 8.5V.

Warning sound: Beep beep beep —
(beeping does not stop until transmitter is turned off)

LAND YOUR MODEL AS SOON AS POSSIBLE BEFORE LOSS OF CONTROL DUE TO A DEAD BATTERY.

Backup error



Warning sound: Beep beep beep beep
(repeated)

The BACKUP ERROR warning occurs when the transmitter memory is lost for any reason. If this occurs, all of the data will be reset when the power is turned on again.

DO NOT FLY when this message is displayed – all programming has been erased and is not available. Return your transmitter to Futaba for service.

Mixer warning

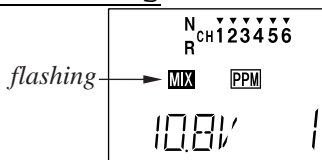

Warning sound: beep beep beep pause
(repeated)

The MIXER warning is displayed to alert you whenever you turn on the transmitter with any of the mixing switches active. This warning will disappear when the offending switch or control is deactivated. At power-up, warnings will be issued for the following switches:

ACRO: Airbrake

HELI: Throttle hold, idle-up

Flying Safety

To ensure the safety of yourself and others, please observe the following precautions:

⚠ WARNING

❗ Ni-cd Battery

Charge the Batteries! Don't forget to recharge the batteries before each flying session. A battery low in charge will soon die, causing loss of control and a crash. Plug in the charger that comes in this system and hook up the transmitter and airborne batteries the day before a planned flying session. When you begin your flying session, keep track of how long the system's been used, and monitor the transmitter's voltage display. Quit flying long before your batteries become low.

On-field charging of your batteries with a field charger is not recommended. A fast-charger may overcharge the Ni-Cd batteries, causing overheating and a premature failure.

❗ Flying field

We recommend that you fly at a recognized model airplane flying field. You can find model clubs and fields by asking your nearest hobby dealer, or contacting the Academy of Model Aeronautics. Always pay particular attention to the flying field's rules, as well as the presence and location of spectators, the wind direction, and any obstacles on the field. Be very careful flying in areas near power lines, tall buildings, or communication facilities as there may be radio interference in their vicinity. If you must fly at a site that is not a club field, be sure there are no other modelers flying within a two-mile range, or you may lose control of your aircraft.

❗ Once you arrive at the flying field ...

Before flying, be sure that the frequency you intend to fly with is not in use, and secure any frequency control device (pin, tag, etc.) for that frequency before turning on your transmitter. Never believe that it's possible to fly two or more models on the same frequency at the same time. Even though there are different types of modulation (AM, FM, PCM), only one model may be flown on a single frequency.

When you are ready to fly your model, position the throttle stick to its low speed position, or do whatever is necessary to command your motor NOT to run. Then, you may turn on the transmitter power followed by the receiver power. When you have finished flying, begin by turning off the receiver power, then turn off the transmitter power. If you do not follow these procedures, you may damage your servos or control surfaces, flood your motor, or in the case of electric-powered models, the motor may unexpectedly turn on and cause a severe injury.

Before starting the engine, fully retract the transmitter antenna, power up the transmitter and receiver, and check to be sure that the servos follow the movement of the sticks. If a servo operates abnormally, don't attempt to fly until you determine the cause of the problem. We recommend that you range-check your system before each flying session. Have an observer verify that the system works with the transmitter about 30 paces away with the transmitter antenna collapsed. Finally, before starting the engine, be sure to check that the transmitter model memory is correct for the chosen model, and (for PCM receivers only) that the fail safe system functions properly when the transmitter is shut off.

While you're getting ready to fly, if you place your transmitter on the ground, be sure that the wind won't tip it over. If it is knocked over, the throttle stick may accidentally move causing the engine to race unexpectedly.

Before taxiing, be sure to extend the transmitter antenna to its full length. A collapsed antenna will reduce your flying range and may cause a loss of control. It is a good idea to avoid pointing the transmitter antenna directly at the model at all times, since the signal is weakest in that direction.

⊘ Don't fly in the rain!

Water or moisture may enter the transmitter through the antenna or stick openings and cause erratic operation or loss of control. If you must fly in wet weather during a contest, be sure to cover your transmitter with a plastic bag or waterproof barrier.

AIRCRAFT (ACRO) MENU FUNCTIONS

*Pages 14 to 42 describe the Basic Menu functions for fixed-wing aircraft, provide a detailed setup example, and then describe the functions individually. Helicopter functions may be found in the following section, pages 43 to 54.

	Map of ACRO Menu Functions	14	
	Aircraft Setup Example	15	
	Pattern Aircraft Trimming Chart	22	
	ATV	Adjustable Travel Volume	24
	D/R.....	Dual Rates	25
EXP	Exponential Settings	26	
	REV	Servo Reverse	27
	STRM	Subtrim.....	27
	FLPR.....	Flaperon (combined flaps & ailerons)	28
	FLTR.....	Flap trim.....	29
	ABRK	Airbrake settings	30
	VTAL.....	V-tail mixing	31
	ELVN.....	Elevon mixing (tailless models).....	32
	1 -> 4.....	Rudder Coupling	33
	6 -> 2.....	Flap -> Elevator mixing	34
	2 -> 6.....	Elevator -> Flap mixing.....	35
	PMX1, 2.....	Programmable Mixer #1 & #2	35
	F/S.....	Failsafe function (only in PCM mode)	37
	PARA.....	Parameter menu.....	38
	RSET.....	Trim Reset.....	38
	DRSW	Dual Rate Switch Select.....	39
	ACRO	Acrobatic model mode	39
	HELI	Helicopter model mode	39
	MOD	Modulation (FM/PPM or PCM).....	40
	COPY.....	Data Copy	40
	TMEM	Trim Memory	41
	MODL.....	Model select	42

MAP OF ACRO AIRCRAFT FUNCTIONS

T6XAs/Hs Acro Mode Menu [ACRO]

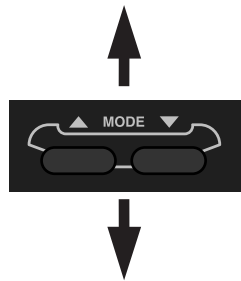
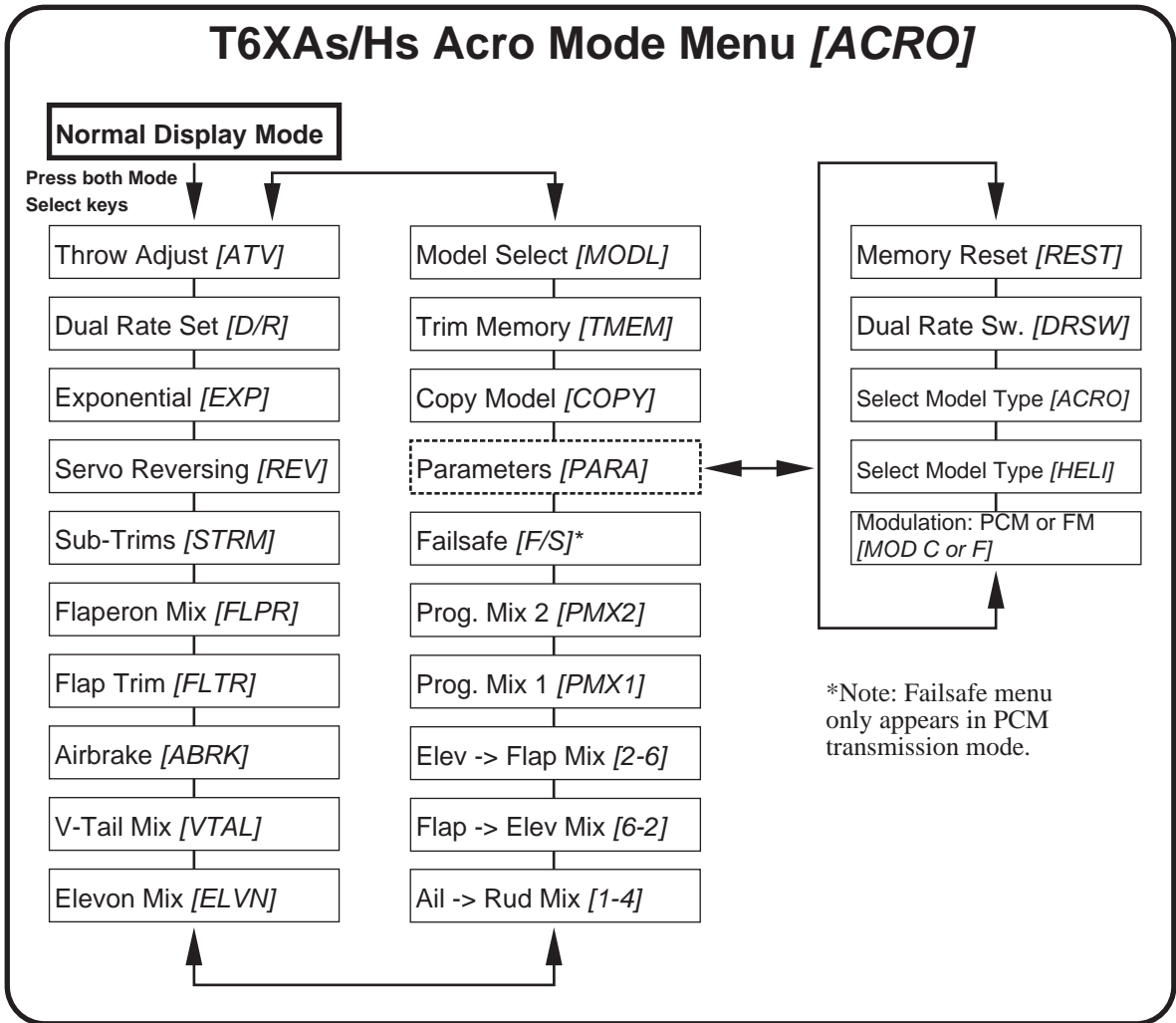

To enter or leave Menu, press both MODE keys simultaneously

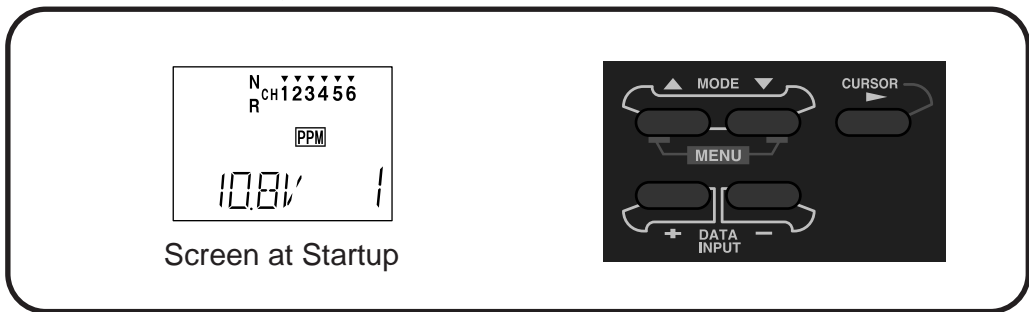

AIRCRAFT SETUP INSTRUCTIONS (GENERAL 120 CLASS STUNT PLANE)

The aircraft setup procedure presented below uses a F3A-class model as an example and assumes that there are two aileron servos, one in each wing. You may use a similar procedure to set up your own model, but your setting's numbers and percentages will probably be different.

1. Be sure that all of your servos are plugged into the proper receiver channels:

CH1 — Aileron (Right aileron*)

CH2 — Elevator

CH3 — Throttle

CH4 — Rudder

CH5 — Gear

CH6 — Flap (Left aileron*)

* = if FLPR activated

We recommend that you begin your programming exercise with the servos installed in the model and connected to the respective control surfaces. This will enable you to immediately see the effect of each programming action we're about to take.

2. Turn on your transmitter and receiver, and select the desired model memory. To do this, enter the programming mode by pressing the two MODE keys, then press the down MODE key until "MODL" appears. Press the CURSOR key and choose a vacant model memory with the plus (+) and minus (-) DATA INPUT keys. Select it by pressing the CURSOR key until "SET" is flashing, then press both the DATA INPUT keys at once. The figure shows memory #1 being utilized.

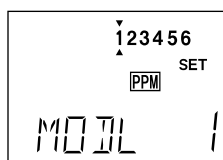

There are a number of ways to keep track of which model is in each memory. You may attach a small piece of white tape to the transmitter front and write the model's name along with the model setup number, or you may use a notebook, or label the model with

its memory number prominently near its on-off switch inside the fuselage.

3. Enter the Parameter (PARA, p. 38) menu by pressing the down MODE key three times. Press the key three times to select the ACRO model type (four presses gets the HELI function). Select ACRO by pressing both DATA INPUT keys. When the flashing "SET" appears, again press both DATA INPUT keys to lock it in.

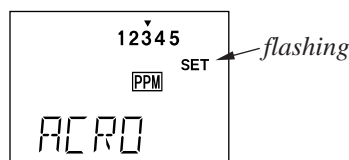

The reason for the separate functions within the PARA setup is that these are seldom used, and the parameter menu provides a convenient way of bypassing them for most programming operations.

WARNING: selecting a different model type will erase the settings in the model memory. BE SURE you're in the correct model memory before selecting a new model type.

4. If your receiver happens to be different than the transmission mode (as shown it's PPM), continue to the modulation (MOD, p. 40) menu to select the proper mode of transmission (F is for FM/PPM transmission, and C is for PCM). This should be set to match your receiver. If you make a change, it won't take effect until you cycle the power off and on again. So if you have changed modulation, cycle power now.

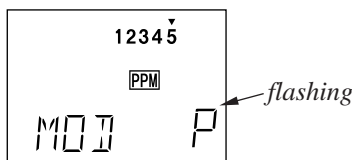

5. If your model has flaperons, turn on the Flaperon function (FLPR, p. 28) in the menu.

To do this, press one of the MODE buttons until "FLPR" appears in the display. Press the CURSOR key to get the "INH" flashing, then activate by pressing the plus (+) DATA INPUT

key (“ON” should appear flashing in the display).

Connect the right aileron servo to receiver CH1 and the left aileron servo to receiver CH6.

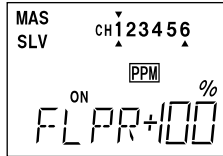

Note that you can get differential by adjusting the up and down motion of the two servos in the FLPR menu. Now we’ll set the servo throw directions.

6. Now we’ll check that each servo moves the proper direction, and we’ll use the Reversing function (REV, p. 27) if they don’t.

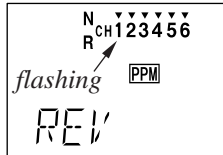

We’ll start by setting the right aileron servo direction. This is channel 1, and the ‘1’ should be flashing for this command. When you move the right-hand stick to the right, the aileron on the right wing should move upwards, and the aileron on the left should move downward. Check that the right aileron moves the correct way!

If it does not, activate the opposite direction for the aileron servo by pressing the DATA INPUT keys: the PLUS (+) key switches from Reversed to Normal, and the MINUS (–) key switches from Normal to Reversed. In the display, ‘N’ for Normal is chosen when the little triangle is *above* the channel number, and ‘R’ for Reversed is chosen when the little triangle is *below* the channel number. Move the right-hand stick again and verify the right

aileron moves the right directions. The display shows Channel 1 reversed.

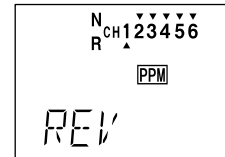

7. Next we’ll set the direction of the elevator servo, channel 2. When you move the right-hand stick towards the **BOTTOM** of the transmitter, the elevator should move up. Check to make sure it moves the proper direction! (More planes are crashed due to reversed controls than for any other reason.)

If the elevator control moves the wrong direction, move over to Channel 2 by pressing the CURSOR key. Now the ‘2’ should be flashing in the display. Activate the opposite direction for the elevator servo by pressing the Minus (–) DATA INPUT key. Move the right-hand stick up-and-down again and verify the elevator moves the right direction.

Now we’ll set the direction of the throttle servo. When you move the left-hand stick towards the **BOTTOM** of the transmitter, the throttle should close, meaning that the hole in the carburetor should close. Check to make sure that the throttle lever on the engine moves the proper direction!

If the throttle servo moves the wrong direction, activate the opposite direction for the throttle servo by pressing the CURSOR key. Now the ‘3’ should be flashing in the display. Activate the opposite direction for

the throttle servo by pressing the Minus (-) DATA INPUT key. Verify the throttle stick makes the servo move the carburetor opening in the correct direction.

8. Now we'll set the direction of the rudder servo. When you move the left-hand stick towards the CENTER of the transmitter (to the right), the trailing edge or rear rudder should move to the right. Check to make sure!

If the rudder moves the wrong direction, activate the opposite direction by pressing the Minus (-) DATA INPUT key. Move the left-hand stick left-and-right again and verify the rudder moves the right direction.

9. If your model has retracts, set the correct response direction when commanded by the retract switch, using the same approach.

10. If you're using a second aileron servo, you'll now set the left aileron servo direction (otherwise skip this and the next step). This is channel 6, and the '6' should be flashing for this command. When you move the right-hand stick to the right, the aileron on the left wing should move downwards. Check that the left aileron moves the correct way! If it does not, activate the opposite direction for the aileron servo by pressing the DATA INPUT keys. Move the right-hand stick again and verify the left aileron moves the proper directions.

11. Go to the Flap Trim function (FLTR), and input a percentage of zero (0). Then press the CURSOR key and activate the function. This temporarily disables the flap knob so that you can set aileron neutrals without regard to the flap knob position. Later we'll turn it back on.

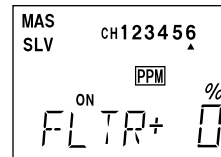

12. Now we will set the servo neutrals. Center all the trims – you can tell when each is centered because you'll feel a small indentation at the center. Once you have centered all the trims, unscrew the screws holding the servo arms onto the elevator, aileron, and rudder (we'll set the throttle travel later). You will want to place the servo arms on the output shaft so they are near neutral — that is, about 90° to the servo case sides or, if the servo is mounted sideways, 90° to the pushrod (sideways mounting is not recommended). This way you won't run out of subtrim authority. Remove all the arms that are in the way or interfere with your pushrods.

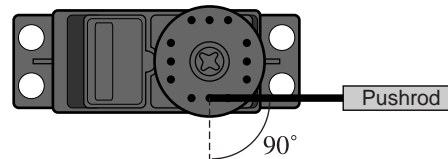

Adjust the clevises on each servo pushrod to get the position of each control to be as close as you can to neutral (lined up with the adjacent portion of wing or tail).

13. Now we'll set all the subtrims to electronically set the desired neutral locations. To do so, get to the STRM menu by pressing either MODE SELECT button repeatedly until it appears.

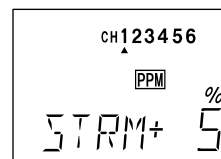

Set the right aileron subtrim first. If the little arrow is not pointing at channel 1, press the one of the CURSOR buttons until it is (see figure). Then, adjust the subtrim amount by adding or subtracting with the DATA INPUT keys. When you have reached a place where both ailerons match up with the fixed portion of the wing, you are done. If you can't get

both to match up, then set the subtrim back to zero and mechanically adjust the clevis to get as close as you can, then readjust the subtrim if necessary.

Note 1: you should NOT use subtrims instead of mechanically adjusting the pushrods to be close. This is because you can reduce the travel of the radio, especially if you have to set the subtrim near 100%. As we stated before, get the pushrods close mechanically first, then use the subtrim adjustment to get it just right.

Note 2: if you mess up the number you've entered or find the percentage the wrong direction, you can get back to zero quickly by pressing BOTH the DATA INPUT keys simultaneously.

14. Repeat the subtrim adjustment with the elevator servo (Ch 2). First set the pushrod length mechanically to get as close to neutral as possible, then set the subtrim to get the elevator lined up to be parallel with the stabilizer portion. For full-flying surfaces, use an incidence meter or another method to get the incidence angle recommended by the kit manufacturer or model designer.

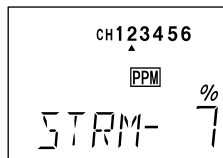

15. For the throttle, we recommend not setting a subtrim at this time. You will use the trim tab on the transmitter for idle and shutting off the motor, after the throw adjustments are done. You can then set the throttle subtrim with the STRM command.

The T6XAs/T6XHs automatically provides a special function called Adjustable Travel Limit. This function makes the trim work at low throttle levels, but disables it at high throttle. Most people set up their engines to idle with the throttle trim near center, and have the engine quit when they move the trim to the bottom position. You'll set this up later in the Travel volume settings.

16. Repeat the subtrim adjustment with the rudder, gear, and 2nd aileron channels. As before, first set them mechanically, then adjust the electronic settings. Be sure you have selected CH4, CH5, or CH6 respectively.

17. Now we'll go through and set the servo travels for each channel. This is both helpful and important, because you can set the throw of each servo, in each direction, so that there is no *binding*. Binding is important because it causes very high current drain, and can lead to a battery dying prematurely.

To set travels, get to the ATV menu by pressing the MODE SELECT button repeatedly until it appears. In sequence, we'll set Right aileron right travel, right aileron left travel, up and down elevator travels, right and left rudder travels, open and closed throttle positions, and left aileron travels.

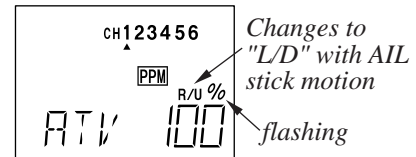

When you reach the ATV menu, you'll see the screen as shown. The channel indicator is below numeral 1 for right aileron, the percent symbol will be flashing, and you'll notice that you can change the L/D indicator to R/U (or vice versa) by moving the aileron (right) stick. You are about to see that this is how you set the travel directions independently for each stick motion.

18. To set the RIGHT aileron motion, move the aileron stick all the way to the right and hold it. The letters "R/U" should appear next to the flashing percent sign, meaning you are setting either Right or Up travel (with ailerons it's right or left only, but the display is set up to use the same indicators for elevator and throttle, thus the dual meanings for the letters). Now if your servo is stalled or binding, you'll hear a buzzing sound. Hit the minus DATA INPUT key until the buzzing stops. If the servo is not buzzing, leave the setting at 100%. Choose a location on the

servo arm so that the throw is adjusted in the 90-100% range.

19. To set the right aileron's LEFT motion, move the aileron stick all the way to the left and hold it. The letters "L/D" should appear next to the flashing percent sign (as shown in the figure above). Again listen and hit the minus DATA INPUT key until the buzzing stops. If the servo is not buzzing, leave the setting at 100%. You may wish to increase or decrease this number depending on how rapidly the model rolls to the left. One possible setting is roughly 9/16" (14-15 mm) travel in both directions. (Remember, you're only setting the right aileron if you have the flaperon function turned on. You set the other aileron's travel in channel 6's ATV.)

20. To set the UP elevator motion, press on the CURSOR key until the indicator moves underneath channel 2, as shown. Now move the right stick all the way to the transmitter bottom and hold it. The letters "R/U" should appear next to the flashing percent sign (as shown in the figure above). Again listen for a buzzing sound to indicate the servo is stalling, and hit the minus DATA INPUT key until the buzzing stops. If the servo is not buzzing, leave the setting at 100%. You may wish to increase or decrease this number depending on how tightly the model does an inside loop (or whether it snap rolls when it shouldn't).

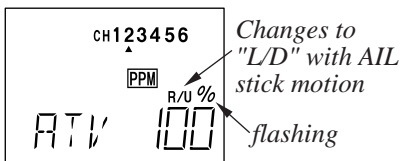

21. Repeat the previous step for DOWN elevator by moving the stick all the way to the top of the transmitter, full "down" elevator. Check for binding and adjust the percentage as before. The elevator settings should be adjusted so that the elevator travel is roughly 9/16" (15 mm).

22. To set the throttle position at IDLE, press on the CURSOR key until the indicator moves underneath channel 3. Now move the throttle

stick all the way to the transmitter bottom and hold it. The letters "R/U" should appear next to the flashing percent sign. Listen for a buzzing sound to indicate the servo is stalling, and hit the minus DATA INPUT key until the buzzing stops. If the servo is not buzzing, leave the setting at 100% or increase it as necessary to fully close the throttle. You may wish to increase or decrease this number depending on whether you can shut off the engine using throttle at idle and the trim tab.

23. To set the FULL throttle position, move the throttle stick all the way to the transmitter top and hold it. The letters "L/D" should appear next to the flashing percent sign. [Notice that the T6XAs/XHs transmitter thinks of throttle stick positions to the reverse of the way it seems, in that with the throttle stick fully forwards — "up" towards the transmitter top, is the Down position.] Listen for a buzzing sound to indicate the servo is stalling, and hit the minus DATA INPUT key until the buzzing stops. If the servo is not buzzing, leave the setting at 100% or change it as necessary to fully open the throttle.

24. To set the RIGHT rudder motion, press on the CURSOR key until the indicator moves underneath channel 4. Now move the left stick all the way to the transmitter right and hold it. The letters "R/U" should appear next to the flashing percent sign. Listen for a buzzing sound to indicate the rudder servo is stalling, and hit the minus DATA INPUT key until the buzzing stops. If the servo is not buzzing, leave the setting at 100%. You may wish to increase or decrease this number depending on how strongly the model reacts when the rudder is deflected. Now move the stick to the left side, and repeat the setting procedure for left rudder. The rudder travel should be set to roughly 45 degrees on both sides.

23. In the same manner as described above, be sure to set ATV values for channels 5 (landing gear) and 6 (second aileron), if you have either.

If you wish to have the flaps operate with the CH6 knob, go back to the FLTR menu and input a number greater than zero. Adjust the number to get the desired amount of flap travel as you turn the knob.

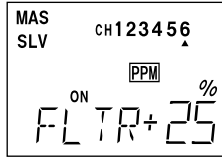

If you wish to have differential in your flaperons, go to the flaperon menu and reduce the number to something less than 100%. If you choose 0%, you'll get only up aileron motion.

24. One more basic function that you will find extremely useful is the trim memory function. This is used after the model is trimmed out and flying the way you like. Unless you build perfectly, after test flying and trimming one or more of the trim tabs will be off-center. This is not a problem if you are only flying one model with the T6XAs/XHs transmitter and you never accidentally move one or more of the trim tabs, but if you have several models in memory or do accidentally move on or more of the tabs, all the trims could be different. The trim memory function solves this problem by memorizing the offsets for each model in memory.

To use the Trim Memory function, press on the MODE SELECT button until TMEM appears on the menu. You will see the display shown. Trim memory is quite easy to use: with the trim tabs in the desired position, simply press both DATA INPUT keys at the same time, and the trim positions are stored. Now, however, you must move the trims back to their neutral position, or else the offsets will be *doubled*, and you don't want that. Simply move the tabs until you feel the detent at each one's center. If you do this with each of the models stored in memory, you will know the model is trimmed when the trims are centered. [Note that the throttle trim position is not memorized if you are in the ATL mode. This is so you can always use the trim to shut the motor off.

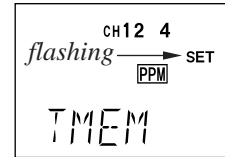

Resetting Trim Memory: if you want to zero out the trim memory, you have to go to the TMEM setting menu, and observe the marks over or under the channel numbers 1 2 4. If the trim memory has a non-zero value (meaning you memorized a trim setting), a little triangle will appear over the corresponding channel. Now move the trim tab for that channel until the triangle disappears — this is the nominal neutral trim. Repeat for the other channel numbers. When you've done all three, hit the DATA INPUT keys simultaneously, then center the trim tabs. You've initialized the trims.

25. Aileron Dual Rate setting (D/R, p. 25). You can use the dual rate function to reduce the aileron and elevator travel *in flight* by flipping one or two switches. Press a MODE SELECT key repeatedly until the D/R menu appears, as shown.

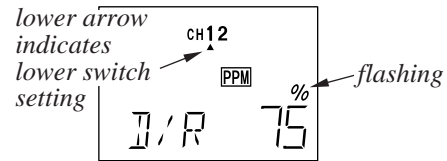

Dual rates are typically used to reduce a model's sensitivity, but they can also be used to increase it.

To set the aileron dual rate (although this is set for CH1, it affects both ailerons if the flaperon function is active), move the arrow by pressing the CURSOR key until the little arrow is under or over the numeral 1. Now move the aileron D/R switch up or down, noticing the position of the arrow. You can set two dual rates, one for each switch position. By pressing the DATA INPUT keys, you can add or subtract from the numerical value displayed. Note that you may pick a value anywhere from 0% to 120% (120% is larger than the normal amount, so if you do this be careful not to exceed servo travel limits and cause stalling or excess current drain). If

you quickly want to get back to the default 100%, press both DATA INPUT keys simultaneously. We suggest using an initial value of 75%, which will limit the aileron travel to roughly 7/16" (11 mm).

NOTE: if you set the dual rate to 0%, you will have ZERO CONTROL AUTHORITY when the switch is in that position. DON'T DO IT!

26. Elevator dual rate setting: press the CURSOR key one time to get the little arrows above or below the numeral 2. Now set the elevator dual rates in the same way you set the ailerons. Adjust the up elevator travel to be about 15/32" (12 mm) and the down elevator travel to 17/32" (13 mm).

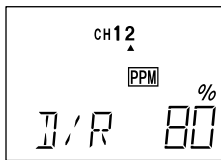

27. There is an option on the T6XAs/XHs which allows you to put both dual rate switches on the aileron D/R switch, or to keep them on separate switches. This option is the second item located in the PARA menu.

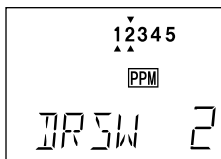

If you choose the '2' option as shown, both dual rates will be operated by the aileron dual rate switch. If you choose the '1' option, the two D/Rs will operate off their individual switches. We suggest the '2' option as it's one less switch to keep track of.

28. Airbrake (ABRK, p. 30): an airbrake effect is obtained by raising both ailerons (or dropping the flaps) and adding elevator to trim. This high-drag configuration makes the landing approach steeper to help make safe landings in small fields. With this function, it is possible to lose some aileron effectiveness so test the airbrake effect at altitude before trying it on a landing approach. You should spend some time fine adjusting the elevator

travel so that there is minimal trim change when the airbrake switch is operated.

Press the MODE SELECT button until the ABRK window appears, as shown. The default is for the airbrake mode to be inhibited, as shown. To activate, press the CURSOR key until the "INH" is flashing, then press the (+) key.

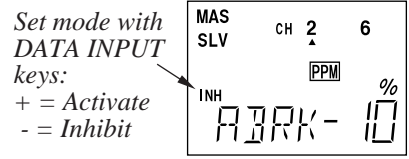

Now press the CURSOR key one time, and the percent symbol will flash. You may input the amount of offset for the elevator (the arrow should be under the numeral 2) at this time. This should be set from -7% to -10% (-10% is the default setting).

Press the CURSOR key one more time, and you may now input the CH6 setting. The rates may vary considerably for different models, but for initial settings choose the flap rate to be (+)50-55%.

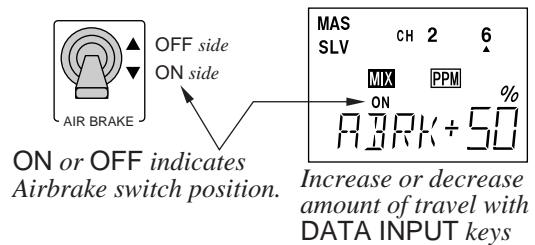

29. Failsafe settings: we recommend that you set the Fail Safe function (F/S, p. 37) to move the throttle to idle if interference is experienced. Note that the failsafe function only operates in the PCM transmission mode.

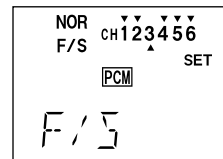

30. 2->6 Mixing: you may couple elevator to flaps for tighter corners in the elevator-to-flap mixer (2 -> 6, p. 35). Get to the 2->6 menu, then activate it by pressing the CURSOR key, then the (+). Pull up elevator and verify that the flaps go down. If they go the wrong direction, reverse them by pressing the (+) or

(-) keys until they do go the right direction. Then press the CURSOR key again, and the percent indicator will flash. Now you may input the percentage of mixing. Start out with 10-20% and increase it until the corners in your loops are square enough.

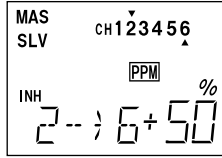

31. Programmable mixers: now take advantage of your system's custom programming capabilities. You may use programmable mixers (PMX1 or PMX2, p. 35) to get rid of unwanted tendencies (for example, pitching up during knife-edge flight.

For pitching during knife-edge, you want to apply up or down elevator when you are using full rudder to sustain knife-edge. Thus, the master channel is rudder, and the slave is elevator.

To program this mixing, first get to the PMX1 window. Press the CURSOR key once, then press the (+) to activate it (a flashing ON or OFF will appear, depending on the position of the Elev D/R switch, which turns mixer #1 on and off).

Next, press the CURSOR key once, then press the DATA INPUT key until the little arrow is over the numeral 4, indicating CH4 (rudder) is the master channel. Press the CURSOR key once, then press the DATA INPUT key until the

little arrow is under the numeral 2, indicating CH2 (elevator) is the slave channel.

Now, you'll define the mixing direction. If your model pitches up with knife edge, you'll want to input down elevator for rudder going both directions. Move the rudder stick to one side and see which way the elevator moves; if incorrect, press the CURSOR key once, then press the DATA INPUT keys until it moves down. Repeat this by moving the rudder stick to the other side. You'll end up with a plus sign for one rudder direction, and minus for the other direction.

Finally you may input the amount of elevator mixing on both sides by pressing the CURSOR key, then the (+) or (-) keys until a small amount of mixing has been assigned. Repeat this by moving the rudder stick to the other side and verifying that the numbers match for both directions.

Be sure you understand how to use the Elev D/R to switch to turn the mixer on and off, since you won't want this mixing on during normal flight, only during knife-edge. Later, after you fly the model you may fine tune the amount of elevator travel so that the pitching tendency is eliminated.

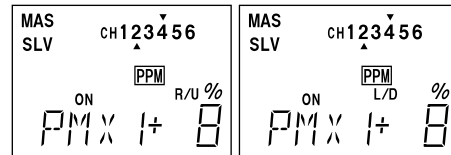

The sky's the limit — you'll enjoy using your T6XAs/XHs system!

Pattern Aircraft Flight Trimming Chart

The following chart may be used to systematically set up and trim a model for straight flight and aerobatic maneuvers. Please note that for best results, trimming should be done in near-calm conditions. Before you decide to make a change, be sure to try the test several times before making adjustments. If any changes are made, go back through the previous steps and verify that they are not also affected. If they are, make further adjustments as necessary.

To test for ...	Test Procedure	Observations	Adjustments
1. Control neutrals	Fly the model straight and level	Use the transmitter trims for hands-off straight & level flight.	Change electronic subtrims or adjust clevises to center transmitter trims.

2. Control throws	Fly the model and apply full deflection of each control in turn	Check the response of each control <ul style="list-style-type: none"> • Aileron high-rate: 3 rolls in 4 seconds; low-rate: 3 rolls/6 sec • Elevator high-rate: to give a smooth square corner; low-rate gives approx. 130 ft diameter loop • Rudder: high-rate 30-35° for stall turns; low rate maintains knife-edge 	Change ATV (for high rates), and Dual Rate settings (for low rates) to achieve desired responses.
3. Decalage	Power off vertical dive (crosswind if any). Release controls when model vertical (elevator trim must be neutral)	A. Model continues straight down B. Model starts to pull out (nose up)? C. Model starts to tuck in (nose down)?	A. No adjustment B. Reduce incidence C. Increase incidence
4. Center of Gravity	Method 1: Roll into near vertically-banked turn. Method 2: Roll model inverted	A1. Nose drops B1. Tail drops A2. Lots of forward stick (down elevator) required to maintain level flight B2. No forward stick (down elevator) required to maintain level flight, or model climbs	A. Add weight to tail B. Add weight to nose
5. Tip weight (coarse adjustment)	Fly model straight & level upright. Check aileron trim maintains level wings. Roll model inverted, wings level. Release aileron stick.	A. Model does not drop a wing. B. Left wing drops. C. Right wing drops.	A. No adjustment B. Add weight to right tip. C. Add weight to left tip.
6. Side Thrust & Warped Wing	Fly model away from you into any wind. Pull it into a vertical climb, watch for deviations as it slows down.	A. Model continues straight up. B. Model veers left C. Model veers right D. Model rolls right	A. No adjustment B. Add right thrust C. Reduce right thrust D. Put trim tab under left wing tip *
7. Up/Down Thrust	Fly the model on normal path into any wind, parallel to strip, at a distance of around 100 meters from you (elevator trim should be neutral as per Test 3). Pull it into a vertical climb & neutralize elevator	A. Model continues straight up B. Model pitches up (goes toward top of model) C. Model pitches down (goes toward bottom of model)	A. No adjustment B. Add down thrust C. Reduce down thrust
8. Tip weight (fine adjustment)	Method 1: fly the model as per Test 6 and pull into a reasonably small diameter loop (one loop only) Method 2: fly the model as per Test 6 and then push into an outside loop (one only, fairly tight)	A. Model comes out with wings level B. Model comes out right wing low C. Model comes out left wing low	A. No adjustment necessary B. Add weight to left tip C. Add weight to right tip
9. Aileron differential	Method 1: fly model toward you & pull into a vertical climb before it reaches you. Neutralize controls, then half-roll the model. Method 2: fly model on normal pass and do three or more rolls Method 3: fly the model straight and level and gently rock the aileron stick back and forth	A. No heading changes B. Heading change opposite to roll command (i.e. heading veers left after right roll) C. Heading change in direction of roll command A. Roll axis on model centerline B. Roll axis off to same side of model as roll command (i.e. right roll, roll axis off right wing tip) C. Roll axis off to opposite side of model as roll command A. Model flies straight ahead without yawing B. Model yaws away from roll command (i.e. right roll, yaw left) C. Model yaws towards roll command (i.e. right roll, yaw right)	A. Differential settings OK B. Increase differential C. Decrease differential A. Differential settings OK B. Increase differential C. Decrease differential A. Differential settings OK B. Increase differential C. Decrease differential

10. Dihedral	Method 1: Fly the model on normal pass and roll into knife-edge flight; maintain flight with top rudder (do this test in both left & right knife-edge flight) Method 2: Apply rudder in level flight	A. Model has no tendency to roll B. Model rolls in direction of applied rudder C. Model rolls in opposite direction in both tests	A. Dihedral OK B1. Reduce dihedral B2. Use mixer to produce aileron opposing rudder travel (start with 10%) C1. Increase dihedral C2. Mix ailerons with rudder direction 10%
11. Elevator alignment (for models with independent elevator halves)	Fly the model as in Test 6 and pull up into an inside loop. Roll it inverted and repeat the above by pushing it up into an outside loop.	A. No rolling tendency when elevator applied B. Model rolls in same direction in both tests — halves misaligned. C. Model rolls opposite directions in both tests. One elevator half has more throw than the other (model rolls to side with most throw).	A. Elevators in correct alignment B. Either raise one half, or lower the other C. Reduce throw on one side, or increase throw on the other.
12. Pitching in knife-edge flight	Fly the model as in Test 10	A. There is no pitch up or down B. The nose pitches up (the model climbs laterally) C. Nose pitches down (model dives laterally)	A. No adjustment needed B. Alternate cures: 1) move CG aft; 2) increase incidence; 3) droop ailerons; 4) mix down elevator with rudder C. Reverse 'B' above



*Trim tab is 3/16" x 3/4" x 4" trailing edge stock, placed just in front of aileron on bottom, pointed end forward.

ATV – Adjustable Travel Volume

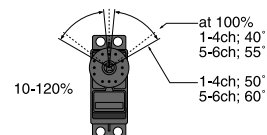
The ATV function is used to set (or limit) the travel of each servo, and may be set independently between a value of 10% and 120% for each travel direction. At a 100% setting, the throw of the servo for full stick motion is approximately 40° for channels 1 – 4 and approximately 55° for channels 5 – 6. Reducing the percentage settings reduces the total servo throw in that direction. The ATV function is normally used to prevent any servos from binding at the ends of their travel.

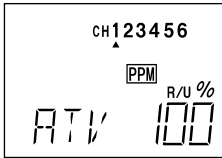

Setting ATV values on your system:

1. Enter the programming mode, and get to the ATV screen with the up or down arrow keys. The channel indicator is below numeral 1 for ailerons, the percent symbol will be flashing, and you'll notice that you can change the L/D indicator to R/U (or vice versa) by moving the aileron (right) stick. In Steps 2 & 3 you will see how you set the travel directions independently for each stick (or knob or gear switch) motion.
2. To set the RIGHT aileron motion, move the aileron stick all the way to the right and hold it. The letters "R/U" should appear next to the flashing percent sign, meaning you are setting either Right or Up travel (with ailerons it's right or left only, but the display is set up to use the same indicators for elevator and throttle, thus the dual meanings for the letters). Now if your servo is stalled or binding, you'll hear a buzzing sound. Hit the minus DATA INPUT key until the buzzing stops. If the servo is not buzzing, leave the setting at 100%. Later, after flying the model, you may wish to increase or decrease this number depending on how rapidly the model rolls to the right (you may also use dual rates to reduce your model's responses).
3. To set the LEFT aileron motion, move the aileron stick all the way to the left and hold it. The letters "L/D" should appear next to the flashing percent sign. Again listen and hit the minus DATA INPUT key until the buzzing stops. If the servo is not buzzing, leave the setting at 100%. You may wish to increase or decrease this number depending on how rapidly the model rolls to the left (or use dual rates as mentioned before).
4. To set travel volumes for other channels, press the CURSOR key to select the channel you wish to change. The little triangle moves and indicates the active channel. Repeat steps 1-3 with each channel in sequence, taking care to set the travel for both directions.
5. You may set each channel separately, anywhere in between 10% and 120%, and if you wish to rapidly return to the default 100% setting, press both the (+) and (-) keys simultaneously.

If this is your first computer radio, you may have never been introduced to dual rates before. Dual rates are used because most models respond more rapidly to control inputs while they're flying at higher speeds, and it is possible to be really gentle with the controls and yet still over-control. Dual rates are used to adjust the transmitter so that a control actuated at high speed will not cause a radical response, so they are very useful for beginning pilots as well as experts.

Dual rates are invoked by flipping a switch on the transmitter. The T6Xs/XHs has two dual rate switches, one each for elevator and ailerons. The aileron dual rate switch is located over the right-hand stick, and the elevator dual rate switch is located over the left-hand stick. If you prefer to have both operate on a single switch, you may combine them to both operate on the aileron dual rate switch in the DRSW window (within the PARA menu).

You can use D/R dual rate settings to reduce (or increase) the aileron and elevator servo travels by flipping a switch. The amount of travel reduction or increase may be set anywhere between 0 and 120% **Note: if you set the dual rate amount to zero, you will get no response from that channel, which may cause a crash.**

Inputting Dual Rate Values

1. Get to the D/R screen with the up or down arrow keys.
2. Use the CURSOR key to select the channel (aileron, elevator or rudder) you wish to reverse. The active channel number is indicated by the arrow above or below. The arrow's position depends on the position of that channel's dual rate switch. In the figure, the aileron (CH1) dual rate setting at the D/R switch's lower position is being programmed.

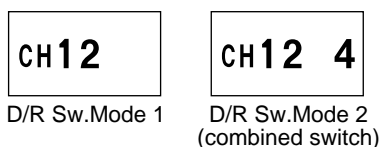
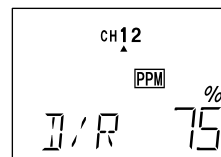

3. Choose the amount of dual rate with the (+) or (-) keys. You may set the travel for both sides of the switch simply by flipping the switch to the other position (the arrow will also switch sides). If you wish to return to the original 100% value, press both keys simultaneously.
4. Repeat this procedure for the dual rate settings on the other channel remaining.

EXP – Exponential Settings

Exponential settings may be used to changes the response curve of the servos to make flying more pleasant. You can make the servo movement less or more sensitive around neutral for aileron, elevator, throttle (except HELI type), and rudder. It can also be set for each side of the dual rate switches. Negative exponential (-) makes the servo movement around the stick neutral less sensitive and positive (+) makes the servo movement more sensitive.

For throttle, exponential is applied from the end of travel rather than for neutral like the other controls. When the (-) side is increased, the idle sensitivity decreases and the high throttle sensitivity increases. This is best understood by experimenting with a servo.

Inputting Exponential Values

1. Get to the EXP screen with the up or down arrow keys.
2. Use the CURSOR key to select the channel (aileron, elevator, throttle or rudder) you wish to change the response curve. The active channel number is indicated by the arrow above or below. The arrow's position depends on the position of that channel's dual rate switch. In the figure, the aileron (CH1) exponential setting at the D/R switch's lower position is being programmed.
3. Choose the amount of exponential with the (+) or (-) keys. You may set the amount for both sides of the switch simply by flipping the switch to the other position (the arrow will also switch sides). If you wish to return to the original 0% value, press both keys simultaneously.
4. Repeat this procedure for the exponential settings on the other channel remaining.

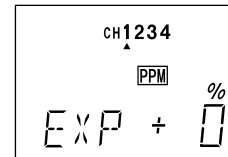

REV – Servo Reversing

The servo reverse function may be used when you need to change the direction that a servo responds to a control stick motion. When you use this function, **BE SURE THAT YOUR CONTROL IS MOVING THE CORRECT DIRECTION**. If you are using any preprogrammed mixers such as flaperon, be sure to set correct travels in the REV menu setting up the preprogrammed function.

Reversing Servos

1. Get to the REV screen with the up or down arrow keys.
2. Use the CURSOR key to select the channel you wish to reverse. The active channel number will flash.
3. Select normal (N) with the (+) key, or select reverse (R) with the (–) key.

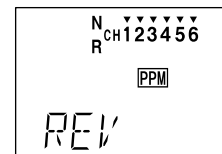

- The arrow above the number indicates normal travel, while the arrow below indicates reversed travel (the figure shows all channels normal, none reversed).
4. Repeat this procedure for each channel needing to be reversed.

STRM – Subtrim Settings

The Subtrim window is used to make small adjustments or corrections in the neutral position of each servo. The recommended procedure is to zero out both the trims (see TMEM menu) and the subtrims (this menu). Next, mount the servo arms and set up your linkages so that the neutral position of each control surface is as close to where it should be as possible, with the arm 90° to the pushrod. Finally, use a small amount of subtrim to make fine corrections. We recommend that you try to keep all of the subtrim values of as small as possible. Otherwise, when the subtrims are large values, the servo's full range of travel may be restricted.

Setting Subtrims

1. Use the up or down arrow keys to call up the STRM window.
2. Press the CURSOR key until the small arrow is underneath the channel you wish to adjust (the figure shows subtrim adjustment for CH1).
3. Adjust the neutral position using the (+) or (–) keys. You may adjust between -120% and +120%. If you want to reset the value back to zero, press both the (+) and (–) keys simultaneously.
4. Repeat steps 2 and 3 for each channel to be adjusted in turn.

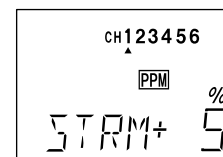

The Flaperon mixing function uses two servos to individually control two ailerons, combining the aileron function with the flap function. Both ailerons can be raised and lowered simultaneously for a flap effect. Of course, aileron function, where the two controls move in different directions, is also performed. The down travel of the left and right ailerons can be adjusted, so you can also get a differential effect. (Left and right flap travel are adjusted individually in the ATV menu.) To take advantage of the flaperon mixing function, you'll need to connect the right aileron servo to CH1 (AIL) and the left aileron servo to CH6 (FLP).

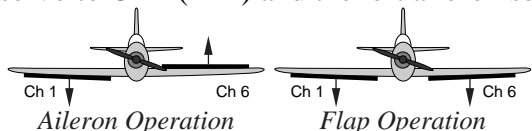

You can combine the flaperon function with the airbrake function (ABRK), to get steeper descents without building up airspeed. This is very convenient for making short approaches on small fields.

Please note that you may only use one function from flaperon, elevon, or V-tail at a time. The one you activate overrides the others. If you need V-tail with a flaperon model, use the programmable mixers (PMX1 & PMX2) to program in the V-tail function.

Setting up the Flaperon function

1. Use the up or down arrow keys to select the FLPR window.
2. When first accessed, the flaperon function is inhibited (INH). Press the CURSOR key to get to the activation menu. The INH indicator will flash on and off.
3. Now press the (+) key to activate the flaperon function. At this time, the ON indicator will blink on and off.
4. Next you may set aileron differential. Aileron differential means that one aileron has more travel in one direction than the other direction. Normally the down travel is reduced to about half of the up travel, especially on slower-flying models.

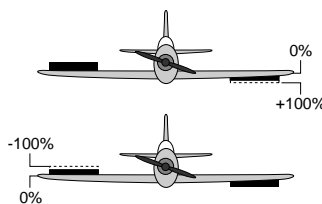
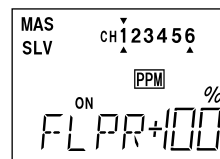

Pressing the CURSOR key one time causes the large sign in front of the number to blink. You may reduce the down travel by selecting the minus (-) sign. If you choose 0% down, the ailerons will move up only. This is preferred over reducing the up travel.

5. Pressing the CURSOR key again moves to the differential setting number (the percent sign should now be flashing). For the 100% value, the up and down travel are both the same. Reducing to less than 100% causes less travel. 50 - 75% is a good starting value, but observe your model in flight to fine tune this setting. If you wish to return to 100%, press both the (+) and (-) keys simultaneously.

FLTR – Flap Trim Function

The Flap Trim function is used to specify the amount of flap travel produced by moving the flap control (the CH6 knob). If flaperon (FLPR) function has been activated, FLTR is automatically turned on. Sailplane folks call this effect “camber,” because the model’s airfoil is changed across the span.

Setting Flap Trim function

1. Use the up or down arrow keys to select the FLTR window.
2. Press the CURSOR key to get to the activation setting. The INH indicator will flash on and off.
3. Now press the (+) key to activate the flap trim function. At this time, the ON indicator will blink on and off.

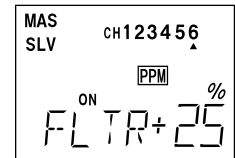

4. Now you’ll set the flap knob’s travel direction. This is similar to the reversing menu, but it reverses the response of both flaperons if flaperon mode is active.

Pressing the CURSOR key one time causes the large sign in front of the number to blink. You may reverse the travel direction by selecting the minus (–) sign.

5. Pressing the CURSOR key again moves to the flap travel setting number (the percent sign should now be flashing). The 30% default value produces “reasonable” travel for many models, but you must try it out on your own model to be sure. A 100% setting causes extreme travel and is not recommended. You may want to set it to a smaller number, say 10% for starters. If you wish to return to the default 50% setting, press both the (+) and (–) keys simultaneously.

ABRK – Airbrake Function

The ABRK function, when activated, simultaneously moves the flaps and offsets the elevator, and may be used to make steep descents or limit airspeed in dives. All the controls move to the defined positions by flipping the airbrake switch downwards. Normally, with a single flap, the flap is dropped. With flaperons, you'll want to raise both to prevent tip-stalling, but you may experiment with small values of down flaperons to slow the model down.

When the airbrake function is active, both ailerons' travel is set by a single number. The elevator offset should be chosen to maintain trim when the airbrake function is turned on and the ailerons rise.

Setting up Airbrake function

1. Use the up or down arrow keys to select the ABRK window.
2. Press the CURSOR key twice to get to the activation setting. The INH indicator will flash on and off.
3. Now press the (+) key to enable the airbrake function. Depending on the position of the airbrake switch, the display will show a flashing OFF or ON.

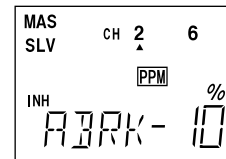

4. First the amount of elevator offset is programmed. Press the CURSOR one time. A small arrow is displayed under the numeral 2 (representing elevator), and the percent sign will blink on and off. You may adjust the amount of travel with the (+) and (-) keys. You may use anywhere between -100% and +100%, but the default value of -10% is the recommended starting value. Be careful setting elevator offset, as this has a very powerful effect on the model's trim. Press both the (+) and (-) simultaneously if you wish to reset to -10%.



5. To get to the flap travel setting, press the CURSOR key. A small triangle is now displayed underneath the numeral 6, indicating the flap channel. In addition, the percent indicator will flash on and off. You may input any desired flap travel with the (+) and (-) keys. Although the default is -50%, you may set this anywhere from -100 to +100%. You may return to the default settings by hitting both the (+) and (-) keys together.

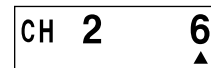

Note: if you have the flaperon function active, the ABRK function will cause both flaperons to move. Be very cautious with large flap settings, as they may reduce the aileron authority when you are flying slowly.

VTAL – V-Tail Mixing

V-tail mixing is used with V-tail aircraft so that both elevator and rudder functions are combined for the two tail surfaces. Both elevator and rudder travel can be adjusted independently. However, if you program in too much elevator or rudder travel, when both rudder and elevator are commanded the servos may reach their travel limits before full stick motion has occurred. Therefore, you should keep the travel settings at 50% or below and adjust the control linkages to get the travel you desire.

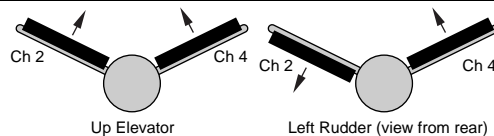

Please note that you may only use one function from flaperon, elevon, or V-tail at a time. The last one activated has priority. If you need V-tail with a flaperon model, use the programmable mixers (PMX1 & PMX2) to program in the V-tail function.

Setting up V-Tail mixing

1. Use the up or down arrow keys to select the VTAL window.
2. Press the CURSOR key three times to get to the activation setting. The INH indicator will flash on and off.

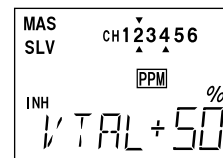

3. Press the (+) key to enable the V-tail function. The display will show a flashing ON.
4. Press the CURSOR key once, to get to the elevator setting menu. A small arrow is displayed over the numeral 2 (representing elevator), and the plus or minus sign above the large setting number will blink on and off.

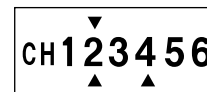

Pull back on the elevator stick: both sides of the V-tail should move upwards. If they don't, you may change the elevator travel direction with the (+) and (-) keys. Note that this reverses the response at both V-tail servos (not just one as in the REV menu). If only one servo moves up, reverse the other one in the REV menu.

5. Now you'll input the amount of elevator travel by pressing the CURSOR key once. Now the percent sign will blink on and off, and you may adjust the amount of elevator travel with the (+) and (-) keys. You may change the initial 50% setting to be anywhere between 0% and 100% (press the plus and minus keys together if you wish to reset to 50%).

6. Next: the rudder inputs. Press the CURSOR key once. A small arrow should appear over the numeral 4 in the screen, and the sign in front of the large setting number will flash on and off. Holding left rudder stick, verify that the servos move the correct direction (see figure). If they move incorrectly, change the direction by pressing the (+) or (-) key which changes the flashing sign displayed.

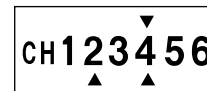

7. Now input the amount of rudder travel. Press the CURSOR key once; the percent sign will blink on and off. You may adjust the amount of rudder with the (+) and (-) keys, changing the initial 50% setting to be between 0% and 100% (press the (+) and (-) keys together if you wish to reset to 50%). Remember to be sure not to have so much travel as to cause binding when both elevator and rudder are commanded simultaneously.

The Elevon function should be used with delta wings, flying wings, and other tailless aircraft whose layouts combine the aileron and elevator functions, and requires one servo for each elevon. Connect the right aileron to receiver CH1/AIL and the left aileron to CH2/ELE.

The amount of aileron and elevator response can be adjusted independently. However, if you program in too much elevator or rudder travel, the servos may reach their travel limits before full stick motion has occurred. Therefore, you should keep the travel settings at 50% or below and adjust the control linkages to get the travel you desire.

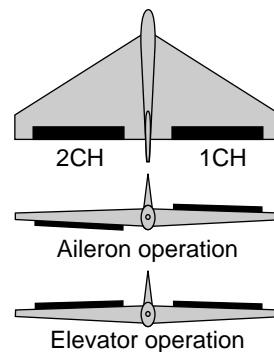

NOTE: The elevon, V-tail, and flaperon functions cannot be activated simultaneously. The function activated last has priority.

Setting up elevon mixing

1. Use the up or down arrow keys to select the ELVN window.
2. Press the CURSOR key three times to get to the activation setting. The INH indicator will flash on and off.
3. Now press the (+) key to enable the elevon function. The display will show a flashing ON.
4. Press the CURSOR key once, to get to the aileron setting menu. A small arrow is displayed over the numeral 1 (representing aileron master channel), and the plus or minus sign above the large setting number will blink on and off.

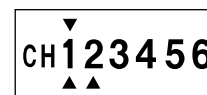
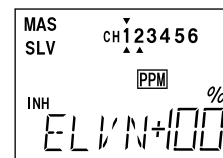

Move the aileron stick all the way to the right: the right elevon should move upwards, and the left elevon should move downwards. If they move opposite to this, change the aileron travel direction with the (+) and (-) keys. Note that this reverses the response at both elevon servos (not just one as in the REV menu). If both servos move the same direction, reverse the one that moves improperly in the REV menu.

5. Now you'll input the amount of aileron travel by pressing the CURSOR key once. Now the percent sign will blink on and off, and you may adjust the amount of aileron travel with the (+) and (-) keys. You may change the initial 50% setting to be anywhere between 0% and 100% (press the plus and minus keys together if you wish to reset to 50%).
6. Next: the elevator inputs. Press the CURSOR key once. A small arrow should appear over the numeral 2 in the screen (indicating elevator is the master channel), and the sign in front of the large setting number will flash on and off. Verify that when you pull back on the elevator stick, both the elevon servos move upwards. If they move the incorrect direction, change the direction by pressing the (+) or (-) key which changes the flashing sign displayed.
7. Now you'll input the amount of elevator travel by pressing the CURSOR key once. Now the percent sign will blink on and off, and you may adjust the amount of elevator travel with the (+) and (-) keys. You may change the initial 50% setting to be anywhere between 0% and 100% (press the plus and minus keys together if you wish to reset to 50%). Remember to be sure not to have so much travel as to cause binding when both elevator and aileron are commanded simultaneously.

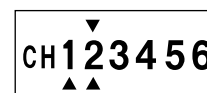

1->4 – Aileron -> Rudder Mixing

Aileron-to-rudder mixing is a function which causes the rudder to move automatically with the motion of the aileron stick. This is done because when ailerons are used to command a turn, the down-moving aileron has more drag than the up-moving one, so the plane's fuselage tries to yaw *against* the turn. Adding rudder mixing cures this problem by making the fuselage point straight into the oncoming air stream (this is also called “coordinating the turn”).

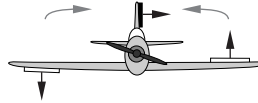

The slower the model flies, the more mixing is needed, and the faster it moves, the less is needed. It is ideal to make slow-flying scale models fly realistically. The amount of coupling is highly dependent on the model configuration. Usually only a small amount of rudder is needed, especially if a large amount of differential (more up aileron motion than down motion) is present.

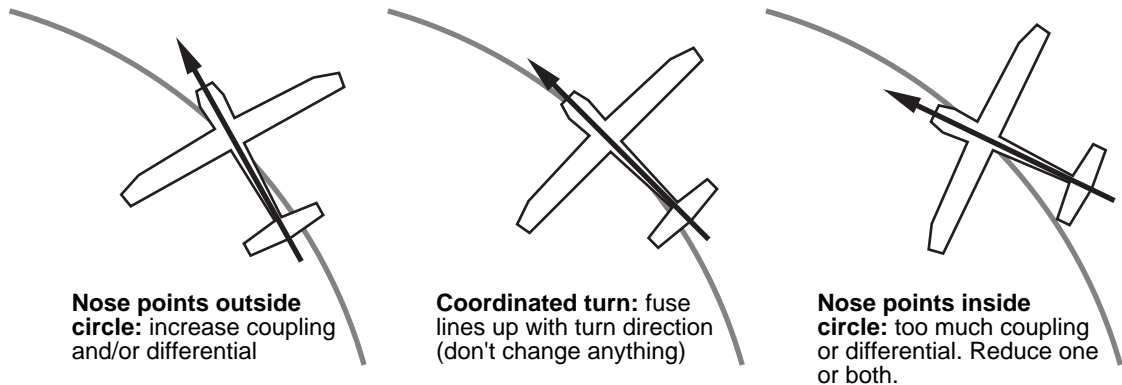

Setting Up 1->4 Mixing (Rudder Coupling)

1. Use the MODE buttons until the 1->4 window appears, as shown. The default is for the function to be inhibited, as shown. To activate, press the press CURSOR key once, then press the (+) DATA INPUT key. The flashing letters “INH” will turn to “ON.”
2. Press the CURSOR key once, and the plus or minus sign in front of the number will flash. Move the aileron stick to the right (or left). If the rudder moves the *same* direction, proceed to the next step. Otherwise, change the sign in front of the number by pressing one of the DATA INPUT keys.
3. Press the CURSOR key once, and now the Percent sign will be flashing. Move the aileron stick all the way to the right, and adjust the mixing amount by pressing the DATA INPUT keys. You may set any amount between 0 and 100%. To return to the initial 50% value, pressing both DATA INPUT keys.

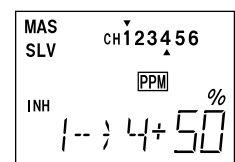

6->2 – Flap -> Elevator Mixing

Flap-to-elevator mixing trims the elevator to compensate for trim changes when the flaps are commanded to drop or rise. This usually requires a relatively small amount of elevator travel. The mixing point may also be offset to match the neutral flap position.

Inputting settings for 6 -> 2 mixing

1. Press one of the MODE buttons until the 6->2 window appears. The default is for the function to be inhibited. Press the CURSOR key twice to make the INH display flash on and off. To activate, press the (+) DATA INPUT key. The ON display should flash on and off.
2. Press the CURSOR key once. At this time, the plus or minus sign in front of the numbers will flash on and off. Check the direction the elevator moves: with down flaps, the elevator should also go downwards, and for up flaps the elevator should rise (note, however, that some models will need the opposite mix, so you'll have to verify the proper direction by flight test). To change the sign, press the (+) or (-) DATA INPUT key.
3. Now hit the CURSOR arrow again to get to the mixing rate setting. Now the little percent sign will flash. You can use the (+) and (-) DATA INPUT keys to increase or decrease the amount of mixing over or under the default 50% (pressing both DATA INPUT keys resets this number to 50%).
4. Now move the flap knob to the position you'll use in normal flight (flaps even with the wing, probably). To make the mixing occur when you move the knob away from the normal position, press both (+) and (-) DATA INPUT keys to enter the position. This changes the position from which offset is applied to the elevator servo.

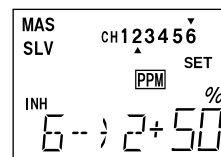

2->6 – Elevator -> Flap Mixing

Elevator-to-flap mixing makes the flaps drop or rise whenever you pull on the elevator stick. It is used to make tighter “pylon” turns or squarer corners in maneuvers. Elevator-to-flap mixing is set up so that the flaps droop (are lowered) when up elevator is commanded.

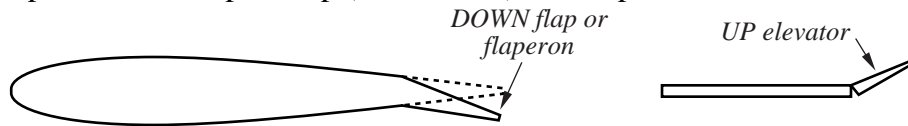

Notice that this mixing function works with the flaperon setting. If flaperon mixing (FLPR) AND 2->6 mixing are activated, when you pull up elevator, BOTH ailerons will droop.

Setting Up 2 -> 6 Mixing

1. Press one of the MODE SELECT buttons until the 2->6 window appears.

The default is for the function to be inhibited. To activate, press the CURSOR key, then press the (+) DATA INPUT key. This will cause the flashing INH display to change to a flashing ON display.

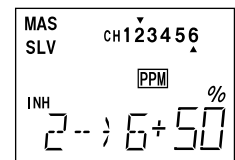

2. Check the direction the flaps move: with up elevator, the flaps should droop downwards, and for down elevator they should come up. In other words, they should move opposite the elevator motion. Press the CURSOR key to get the large plus or minus sign in front of the number flashing, then press the (+) or (-) DATA INPUT keys to get the direction correct.
3. Now hit the CURSOR key again to get to the mixing rate setting. Now the little Percent sign will flash. You can use the (+) and (-) DATA INPUT keys to increase or decrease the amount of mixing over or under the default 50% (pressing both DATA INPUT keys resets this number to 50%). You should probably start with a smaller number (say 20% or so) and slowly increase it to learn how the model reacts.

PMX1, PMX2 – Programmable Mixes 1 & 2

Your T6XAs/XHs system contains two separate programmable mixers (PMX1 and PMX2) with unique capabilities. You may use mixing to correct unwanted tendencies of the aircraft during aerobatics. Each one of these mixers may be programmed to do things that are not built-in programs. This makes them useful for all sorts of different things.

The elevator dual-rate switch in its down position turns on the mixers (if they've been activated). The method to be used to program mixers is given for Mixer #1, but the other mixer may be programmed in an identical fashion.

You can use both PMXs to create a custom dual elevator function, where you use two servos for your elevator control, one for each side. Or you may also use the mixers for correcting unwanted flying tendencies, like automatically applying a bit of rudder with throttle to account for torque/P-factor effects, to a corrective elevator motion during knife-edge flight to

correct for an undesired pitching tendency (the latter is described in the ACRO model setup section).

Using the Programmable mixers

1. Call up the mixer screen by repeatedly pressing one of the MODE buttons until the PMX1 or PMX2 window appears. The default is for the function to be inhibited. To activate, press the CURSOR key, then press the (+) DATA INPUT key. This will cause the flashing INH display to change to a flashing ON display.

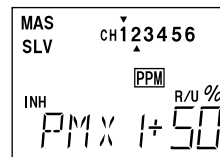

2. Now you'll select the *Master* channel for the mixing, the channel that causes the mixing to occur. Press the CURSOR key to get the little arrow *above* the channel numbers flashing on and off, then press the (+) or (-) DATA INPUT keys to get to the number of the desired master channel.

3. Next you'll put in the *Slave* channel, the one that is affected by motion of the master channel. Press the CURSOR key to get the little arrow *below* the channel numbers flashing on and off, then press the (+) or (-) DATA INPUT keys to get to the number of the desired slave channel.

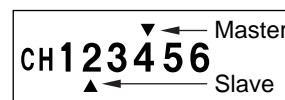

4. Now press the CURSOR key, this will cause the plus or minus sign in front of the large number to flash on and off. You can set the direction the mixer works on each side of the master channel's control's motion by changing this flashing sign with the (+) or (-) DATA INPUT keys. For example, for a model that pitches during knife-edge flight, you'll want to input either up or down elevator for *either* direction of full rudder. Therefore, you'll either set plus or minus for both sides of the master channel's motion (indicated by the R/U or L/D indicator in the window). Verify that you get the proper motion of the slave channel when you move the master (don't worry if the *amount* of travel is incorrect, you'll set this in the next step).
5. Again press the CURSOR key; this will cause the small percent sign in front of the large number to flash on and off. At this point you choose the percentage of mixing for *both* directions of motion of the master channel. You may set a value of 0% to 100% for each direction by moving the master channel in both directions, one at a time, and changing the percentage number to suit. Now verify that the slave channel responds both the correct direction and amount for travel on both sides with the master control. If you wish to return the mixing percentage to the default 50% value, press both the (+) and (-) keys simultaneously.

F/S – Fail Safe Function (PCM mode only)

The Fail Safe function is used to prescribe what the PCM receiver will do in the event radio interference is received, and doesn't work with FM receivers. In this menu, you may select from one of two options of operation for each channel. The "NORM" (normal) setting holds the servo in its last commanded position, while the "F/S" (Fail Safe) function moves each servo to a predetermined position. The default setting is NORM (normal) for all channels.

The use of the fail safe function is recommended from the standpoint of safety. You may wish to set the throttle channel so that the throttle is moved to idle when there's interference. This may give enough warning to allow you to fly towards yourself and recover from the radio interference. If you choose to specify a failsafe setting, the fail safe data are automatically transmitted once each minute.

Battery Failsafe

Your system provides a second safety function called Battery Failsafe. When the airborne battery voltage drops below approximately 3.8V, the battery fail safe function moves the throttle to a predetermined position or fast idle, if you haven't set it. If this happens, you should immediately land! If you need to increase throttle for your landing approach, you may temporarily reset the failsafe function by moving the throttle stick to idle, after which you'll have about 30 seconds of throttle control before the battery function reactivates.

Setting the Failsafe Function

1. Enter the failsafe (F/S) program mode by hitting the two MODE SELECT keys, then press one MODE key repeatedly until the F/S menu appears, as shown.
2. To set the failsafe mode for a channel, move the arrow by pressing the CURSOR key repeatedly until the small arrow appears under or over the channel number you want.
3. Now select the type of failsafe you want by pressing one of the DATA INPUT keys: the (+) key gives you the normal function (holds the last command), and the (-) key gives you the F/S or Failsafe function. Repeat this step for each channel that you are using.
4. If you have chosen only HOLD settings, you're done. But if you have chosen FAILSAFE settings, you will need to tell the transmitter the exact position that you want each servo to assume when there is interference.
5. Now you'll input all the control positions. Let's say that you want the throttle servo to command idle when interference is received. Use the CURSOR key to command the set mode (SET will begin flashing in the display). Hold the throttle stick in the position you desire (say a bit above idle), and then press the two DATA INPUT keys. The servo position is indicated in the numbers to the lower right, the position is stored in memory, and simultaneously sent to the receiver. If you have more than one channel you wish to set, you'll have to set them all at once by holding all the controls where you want them, and pressing the two DATA INPUT keys.
6. Verify that your failsafe programming works by switching off transmitter power and observing the motion of the servos.

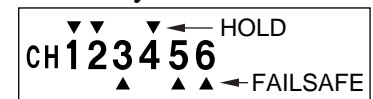
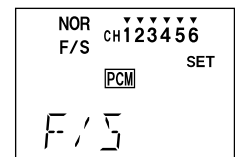

PARA – Parameter Menus

The parameter function includes a number of submenus that are used to input basic model data settings. This is best understood by viewing the menu structure on p. 14. These are placed in a submenu under PARA because they are not changed very often.

There are five submenus within the PARA menu, including REST (Data Reset), DRSW (Dual Rate Switches), ACRO/HELI (Model Type), and MOD (Modulation). To access these menus, you press the CURSOR key to step through them in sequence. Each of these commands is described in more detail below.

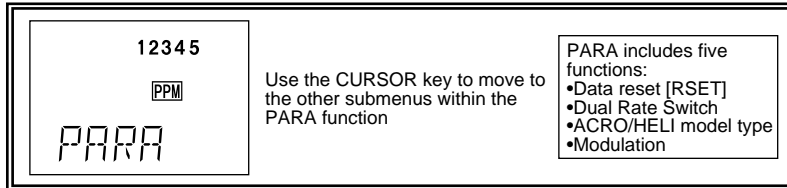

REST – Data Reset (PARA sub-function)

The Reset function is used to clear out an existing set of model data. This may be used to get a “fresh start” so that you may begin with a clear memory before you input new model settings into a memory that had been used for another model. It resets all data to initial values. A safety feature allows you to verify that you wish to reset before all data are lost.

Resetting the memory

1. Press on the MODE buttons until the PARA window appears, then press the CURSOR button until REST appears.
2. To reset the memory, press both DATA INPUT keys simultaneously. The word SET? appears blinking on and off in the display.
3. If you are sure you wish to reset, press both DATA INPUT keys simultaneously again. This resets the memory. If you do not wish to reset the data, press the CURSOR key or a MODE key or return to the regular window.

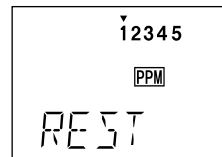

CAUTION: WHEN YOU COMMAND RESET, YOU’LL ERASE THE MEMORY YOU’RE IN AND LOSE ANY PROGRAMMING YOU HAVE ENTERED. DON’T DO THIS UNLESS YOU ARE POSITIVE YOU WANT TO FLUSH OUT THAT MEMORY AND START FROM SCRATCH.

DRSW – Dual Rate Switch (PARA sub-function)

If this is your first computer radio, you may have never used dual rates before. Dual rates are used because most models have different response characteristics depending on their airspeed. Usually they respond more rapidly to control inputs at high speeds, and it is possible to be really gentle with the controls and yet still over-control. Dual rates are used to adjust the transmitter so that a control actuated at high speed will not cause a radical response, so they are very useful for beginning pilots.

The T6XAs/XHs has two dual rate circuits, one each for elevator and ailerons. The switches that activate them are located facing forwards on either side of the display on the top front face. In Mode 1 operation, the two dual rate circuits are activated by separate switches. The DRSW option is convenient in that it allows you to select Mode 2 operation, which combines aileron, elevator and rudder dual rates to operate when the Aileron dual rate switch is moved.

Combining the Dual Rate Switches

1. Press on the MODE buttons until the PARA window appears, then press the CURSOR button until DRSW appears.
2. To switch between Modes 1 and 2, press the (+) or (–) DATA INPUT keys. The blinking 1 (and arrow under the small 1 only) indicates Mode 1 (individual switches), and a blinking 2 along with arrows under numerals 1 and 2 indicates Mode 2 (combined switch) operation.

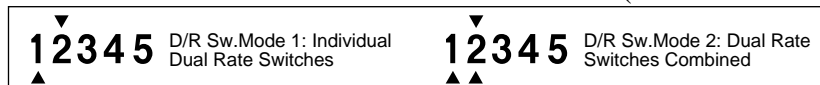
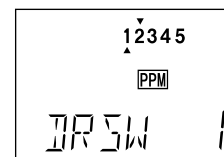

ACRO, HELI – Model Type Select (PARA sub-function)

This function is used to select the type of model to be programmed in the current model memory. You may select from aircraft (ACRO) and helicopters (HELI). Note that when the model select function is executed, the contents of that model memory are reset.

Selecting the Model Type

1. Press on the MODE buttons until the PARA window appears, then press the CURSOR button until the model type you want, either ACRO or HELI, appears. A steady display indicates the current model type, a flashing display indicates a changed model type.
2. To select your desired model type, press both the (+) or (–) DATA INPUT keys simultaneously. The word SET? appears blinking on and off in the display. If you do not wish to reset the data, press the CURSOR key or a MODE key or return to the regular window.

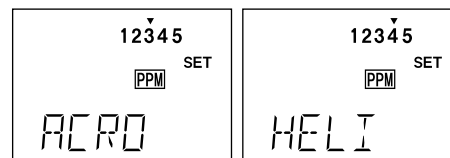

- If you are sure you wish to choose a new model type, press both DATA INPUT keys simultaneously again. This resets the model type and erases the memory. The model type letters will stop flashing to indicate the changed model type.

MOD – Modulation Select (PARA sub-function)

The Modulation menu is used to select the PCM or PPM mode of transmission, to match the receiver being used (PCM = Pulse Code Modulation, and PPM = Pulse Position Modulation, also called FM for Frequency Modulation). The T6XA/XH system ships with a PPM receiver, but if you also will be using a PCM receiver, you should select the PCM mode for that receiver. Note that you have to turn your transmitter on and off before a modulation change becomes effective.

Changing your transmitter's modulation

- Press on the MODE buttons until the MOD window appears.
- To select PCM modulation, press the (+) DATA INPUT key. The letter C is displayed. To select PPM modulation, press the (-) DATA INPUT key. The letter P is displayed.
- To get the transmitter to operate in the new mode, switch transmitter power off and then on. The small indicator will indicate the new mode, either PPM or PCM.

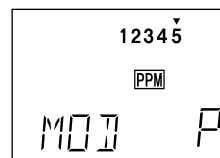

COPY – Copy Model

The COPY function is used to copy the current model data into another model memory. This function is handy to use to start a new model that's similar to one you have already programmed, and is also handy for copying the current model data into another model memory as a backup.

Copying from one model memory to another

- Press on the MODE buttons until the COPY window appears.
- The source model memory (the memory that will be duplicated) is the current one. To select your destination model number, press the (+) or (-) DATA INPUT keys. The selected destination memory number will flash on and off, and a small triangle will appear under it.
- Press the CURSOR key, and the word SET? appears blinking on and off in the display. If you do not wish to reset the data, press the CURSOR key or a MODE key or return to the regular window.

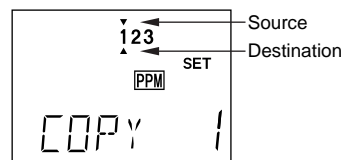

3. If you are sure you wish to copy the current memory contents into the destination memory, press both DATA INPUT keys simultaneously again. This carries out the copy function and overwrites the destination memory. A beep indicates that copying is complete.

TMEM – Trim Memory

The trim memory function is one that you will find extremely useful. It is used after the model is trimmed out and flying the way you like. Unless you build perfectly, after test flying and trimming one or more of the trim tabs will be off-center. This is not a problem if you are only flying one model with the transmitter and you never accidentally move one or more of the trim tabs, but if you have several models in memory or do accidentally move one or more of the tabs, all the trims could be different. The trim memory function solves this problem by memorizing the trim tab positions needed for each model in memory.

When the trim memory function is executed, the trim position is now reproduced when the trim tabs are moved back to their center position. If the model memory is changed, whenever that model number is recalled, the original trims are reproduced if the trim tabs are centered. This means that you never have to worry about where the trim tabs were with the model, the transmitter keeps track of that information.

Note that the trim levers perform a different function than the subtrims. Subtrims affect the position the servos are commanded to, the receiver OUTPUTS. Trims affect the transmitter inputs. (As an example, if you have dual aileron servos and the flaperon function active, aileron trim moves BOTH servos, but subtrim only affects the individual servo being adjusted.)

Memorizing Trim Positions

1. Press on the (+) or (–) MODE buttons until TMEM appears in the window.
2. With the trim tabs in the desired position, simply press both DATA INPUT keys at the same time, and a beep-beep sound indicates that the trim positions have been stored.
3. Now you must move the trims back to their neutral position to get the previous trim locations. Move the tabs until you feel the detent at each one's center. If you do this with each of the models stored in memory, you will know the model is trimmed when the trims are centered. The throttle trim position is not memorized, so you can always use the trim to shut the motor off.

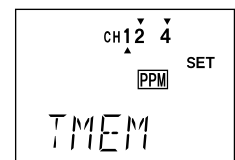

Resetting Trim Memory:

If you want to zero out the trim memory, go to the TMEM menu, and observe the marks over or under the channel numbers 1 2 4. If the trim memory has a non-zero value (meaning you memorized a trim setting), a little triangle will appear over the corresponding channel. Now

move the trim tab for that channel until the triangle disappears — this is the nominal neutral trim. Repeat for the other channel numbers. When you've done all three, hit the DATA INPUT keys simultaneously, then center the trim tabs. You've initialized the trim.

MODL – Model Select

Your T6XAs/XHs system can store up to six independent sets of model data in its memory. The Model Select (MODL) function allows you to choose from any of the six sets of model data.

There are several ways to keep track of which model is in each memory. You may attach a small piece of white tape to the transmitter front and write the model's name along with the model setup number, or you may use a notebook, or label the model with its memory number prominently near its on-off switch inside the fuselage.

Choosing another model memory to load

1. Press on the MODE buttons until MODL appears on the menu.
2. Select the desired model number by pressing the (+) or (–) keys. At this time, the selected model number will blink on and off.
3. Press the CURSOR key, and the word SET? appears blinking on and off in the display.
4. Press both the (+) and (–) DATA INPUT keys at the same time. A beep-beep sound indicates that the selected memory is now the active one.

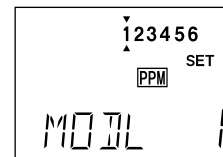

HELICOPTER (HELI) MENU FUNCTIONS

The following section (pages 43 – 54) describes how to use the helicopter-specific menu functions for helicopters (model types HELI). Descriptions of the other functions are contained in the aircraft (ACRO) section which precedes this one, pages 14 –42.

Helicopter Functions Map	43
Helicopter Setup Example	45
Helicopter Trimming Chart	48
P-AT	Pitch Adjustable Travel Volume49
HV-T	Hovering Throttle49
IDLE	Idle-Up function.....50
HOLD	Throttle Hold51
REVO	Revolution mixing51
R-OF	Rudder Offset.....52
HV-P.....	Hovering Pitch.....53
SWSH.....	Swashplate Type & AFR.....53

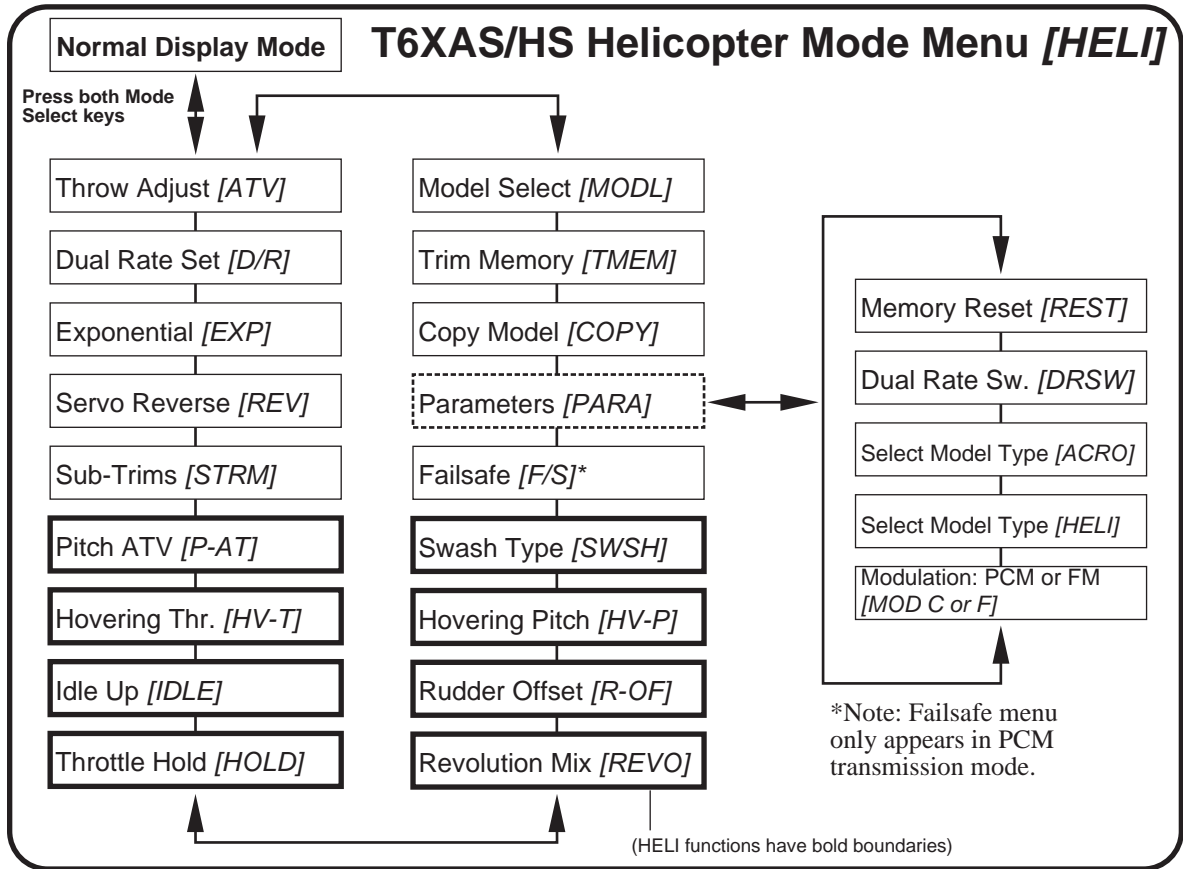

TRANSMITTER CONTROLS - HELICOPTER (T6XHs System)

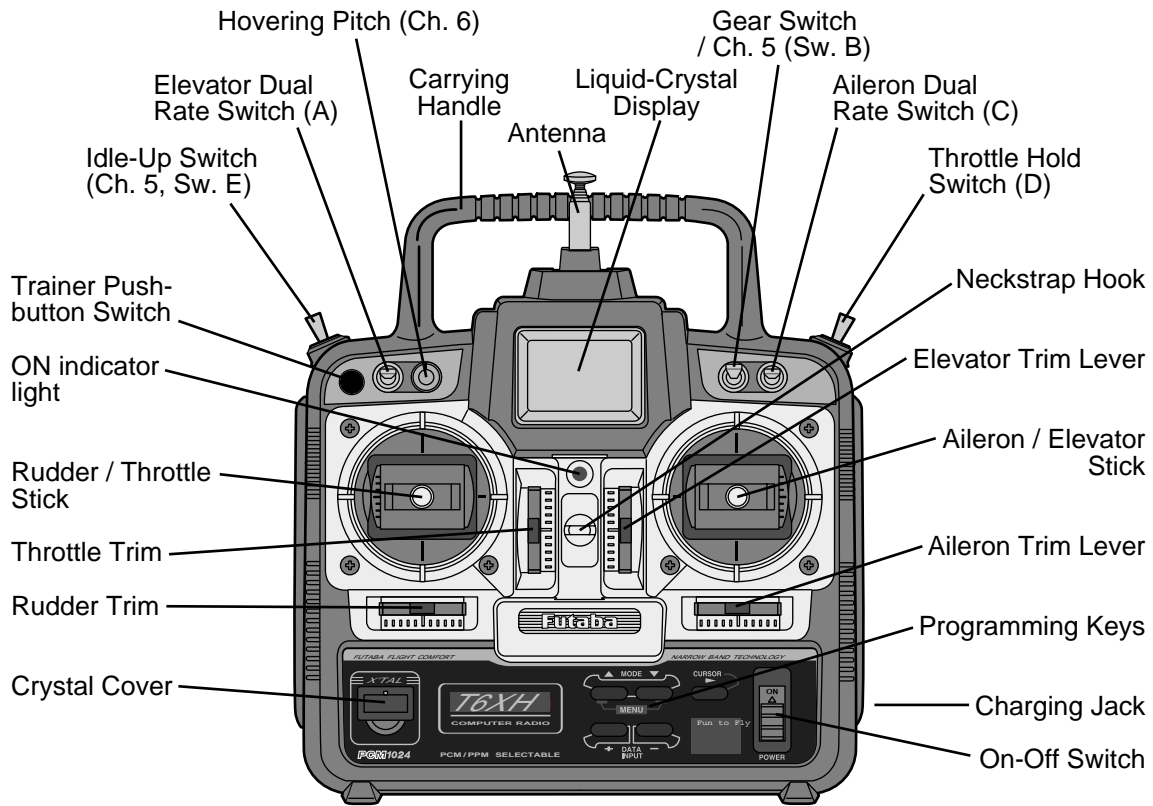

This figure shows the default assignments for a Mode 2 helicopter system as supplied by the factory.

HELICOPTER SETUP INSTRUCTIONS

The following example shows how the T6XAs/XHs may be programmed for a helicopter model. Your model's settings will be dependent on the setup and linkages. Ask an experienced pilot for assistance.

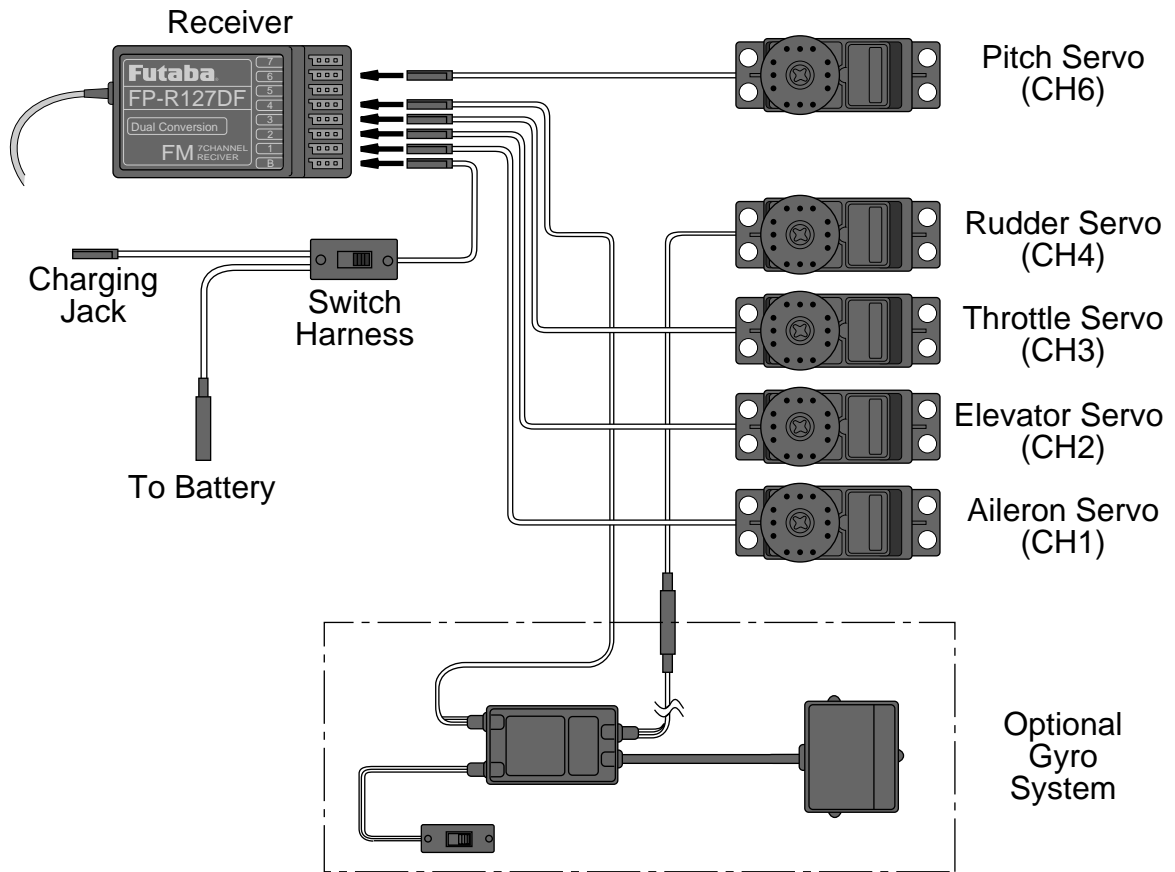

1. Memory Selection

Use the model select function [MODL] to select an available model memory.

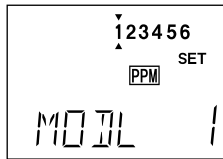

Choose Helicopter settings from within the parameter menu.

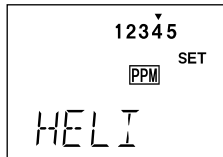

CAUTION: if you select a new type of model, you'll lose all the data already in the model memory.

2. Hook up controls.

In the helicopter, install each servo and hook up the aileron, elevator, throttle, rudder, and pitch pushrods to the servos in accordance with the model's instructions or plans.

3. Plug In Servos (see figure above).

- CH1.....Aileron
- CH2.....Elevator
- CH3.....Throttle
- CH4.....Rudder
- CH5.....spare (or Gyro Sensitivity)
- CH6.....Pitch

4. Set Servo Throw Direction

Check the proper direction of throw for each servo. Use the reversing function [REV]

to reverse channels as necessary to get proper throw directions.

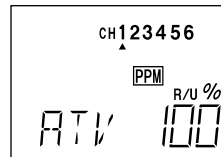
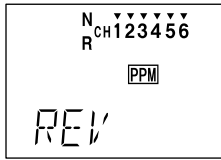

Pitch: the pitch angle (CH6) should vary from -2° to $+10^\circ$ with full stick motion. Adjust servo arms and ATV values to get this motion, measured with a pitch meter. If you need to change it on the ground while the engine is running, use the convenient P-AT function.

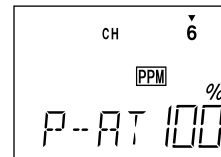

After you've set the pitch, be sure to check that both aileron and elevator motions do not cause binding at extreme pitch settings. If they do, use ATV to reduce travels. Check for binding on full left and right rudder as well.

Set up the carburetor pushrod with trim centered or above center so that at full throttle there is no binding, and so the engine idles smoothly at low throttle. Be sure that trim may be used to fully close the carburetor, to shut off the engine without binding.

7. Hovering Pitch

We recommend setting the hovering pitch to $+4.5^\circ$ by moving the hovering pitch knob (CH6). If it takes a lot of knob travel, reset the the knob to center, then adjust your linkages to get the 4.5° . Then check to see that pitch travel is still correct at high and low stick, and correct with ATV as needed.

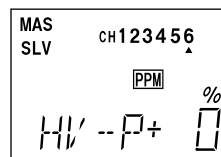

8. Hovering Throttle

Hovering throttle should adjusted to get the desired head RPM around hover.

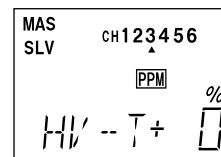

5. Servo Neutrals

First, set up all linkages so that all servos are as close to mechanical neutral as possible. Then, use the Subtrim (STRM) window to make fine adjustments on the servo neutrals.

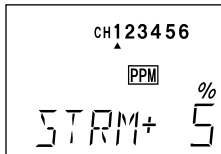

6. Servo Travel

Use the ATV command to limit servo travels to prevent binding.

9. Revolution Mix Setting

Revolution mixing (REVO) uses the tail rotor to suppress the torque reaction of the main rotor due to changes in collective pitch. It is disabled whenever Idle-Up or Throttle Hold are activated.

REVO may be set on either side of the stick (note the letters R/U and L/D displayed). Adjust REVO mixing for both travel directions as described in the trimming instructions following.

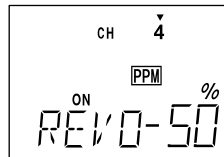

Idle-Up & Throttle Hold

Your system is already programmed to provide Idle-up [IDLE] and Throttle Hold [HOLD]. Idle-up is typically used for 540° stall turns, looping, and rolling stall turns; throttle hold is used to disengage the throttle during autorotations. After activation, these functions are switched on as follows:

- Idle-up [IDLE] – ON at Switch E's forward position. Idle-up also turns on Rudder offset function
- Throttle Hold [HOLD] – ON at Switch D forward position.

When these two switches are OFF, the radio is set up for regular hovering and flight.

As these functions are switched on or off, HOLD has highest priority, followed by IDLE. Regular settings are when both are off.

10. Rudder Offset Setting

The Rudder Offset menu [R-OF] is only turned on when Idle-up has been activated. Rudder trim may be offset to different positions so that the model flies straight ahead during normal flight. Recommended settings are small, from 6% to 10% or as needed.

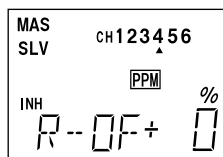

11. Throttle Hold Setting

Throttle hold (HOLD) commands the throttle to a preset position near idle and disconnects it from pitch when activated. Move to the HOLD menu and activate by pressing the (+) key, then move switch D to the forward position. Set the hold position to maintain engine speed near idle without engaging the main rotor clutch.

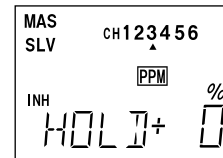

12. Dual Rate Settings

If you find that your aileron and elevator controls are too sensitive, you may set dual rates to reduce them. Use the dual rate (D/R) window to adjust them to the desired amount of response when the switch is flipped.

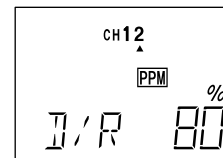

If you want both dual rate circuits to be controlled by a single switch, use mode 2 in the DRSW menu. Otherwise, leave it at mode 1.

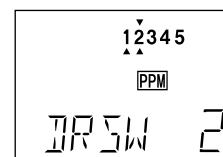

12. Trim Memory

Once your chopper is flying the way you like, memorize the trim positions with the TMEM window.

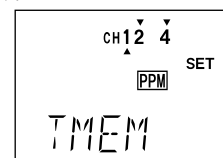

This concludes the example setup procedure for helicopters. Be sure to browse through the pages following this example to see the details about the menus for helicopters.

Helicopter Flight Trimming Chart

This procedure assumes helicopter is trimmed for hovering. Trimming must be done in near-calm conditions. Repeat tests several times before making adjustments. If any changes are made, go back over the previous steps and verify, or further adjust as necessary.

To test ...	Test Procedure	Observations	Adjustments
1. Revo mixing — Up settings (Part 1)	Fly the model straight and level into the wind at 100 ft altitude, lower pitch to 0°	Observe rotation as copter descends A. No rotation B. Model rotates counterclockwise C. Model rotates clockwise	A. None B. Add right rudder trim C. Add left rudder trim
2. Revo mixing — Up settings (Part 2)	Bring the copter into hover, add full pitch and ascend 75 ft	Observe rotation as copter ascends A. No rotation B. Model rotates counterclockwise C. Model rotates clockwise	A. None B. Increase UP revo mix C. Decrease UP revo mix
3. Revo Down mixing settings	Begin Down Revo mixing with same number as UP mix. From inverted flight (top of loop, or mid-point of roll, or inverted part of split-S), add full negative pitch	Observe rotation as copter ascends A. No rotation B. Model rotates clockwise C. Model rotates counterclockwise	A. No adjustment B. Increase Down revo mix C. Decrease Down revo mix

PI-N, I, H – Pitch Rate (Normal, Idle-Up, Hovering)

The Pitch Rate may be used to adjust the rotor pitch high-end pitch angle without having to shut off the engine. When active, you may directly input the top-end ATV percentage. This convenient function allows you to bypass the ATV menu, whose use would require that you move the throttle stick above its halfway position to input numbers for its top end. As you might imagine, this is very inconvenient with the engine running as it will cause the chopper to take off!

Inputting Pitch Rate Values

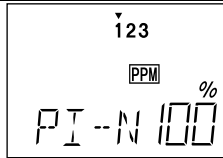

1. Get to the PI-N screen with the up or down arrow keys.
2. Use the CURSOR key to select the pitch rate screen you wish to change.

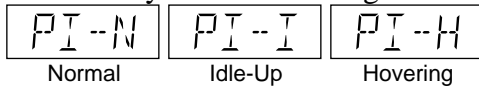

The arrow's position indicates the direction of the pitch servo.

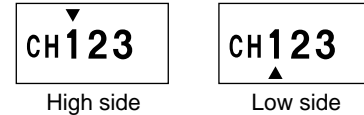

3. Choose the amount of pitch rate with the (+) or (-) keys. If you wish to return to the original 100% value, press both keys simultaneously.
4. Repeat this procedure for the pitch rate settings on the other rate remaining.

HV-T – Hovering Throttle

The Hovering Throttle function may be used to trim the throttle near hover without affecting pitch. This function is handy to make up for changes in rotor speed caused by variations in temperature, humidity, or other conditions. Changing the percentage in the window moves the throttle curve above or below the straight line as shown in the figure. Its value is stored in the model memory so that when the model is recalled, the original setting is repeated. This function is best used with the hovering pitch function, so that more exact trimming may be carried out.

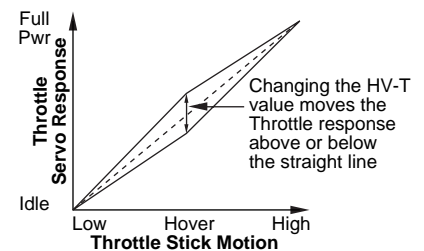

Working with Hovering Throttle

1. Press one of the MODE SELECT buttons until the HV-T window appears. A flashing percent indicator should appear.

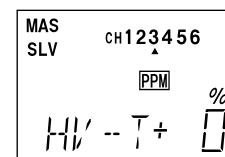

- Adjust the hovering setting value by pressing the (+) or (-) DATA INPUT keys. You may select any value between -100%

and +100%. You may return to the default setting of 0% by pressing both DATA INPUT keys.

IDLE – Idle-Up

The Idle-Up function changes the response of the engine servo below one-half throttle and disengages it from the throttle stick. Idle-up is commonly used during autorotation or any other time you want to keep engine speed above normal idle when pitch is reduced.

This function is turned on whenever switch E is moved to its forward position (and the function has been activated). You can set the fixed throttle position over a 0 to +100% range (as shown in the figure). The smaller the selected percentage, the closer to idle you may come when you retard the throttle stick.

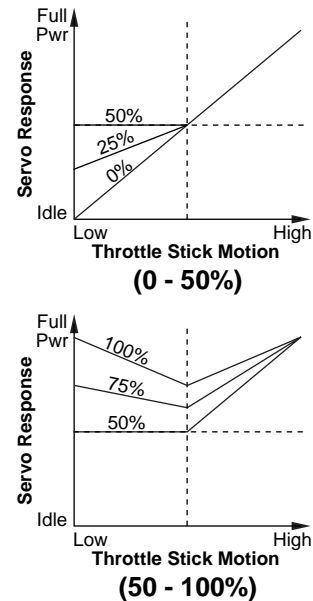

Using the Idle-Up Function

- Press one of the MODE SELECT buttons until the IDLE window appears. The default is for the function to be inhibited. To activate, press the CURSOR key, then press the (+) DATA INPUT key. This will cause the flashing INH display to change to a flashing ON display.
- Now press the (+) key to enable the Idle-Up function. The display will show a flashing ON or OFF display, depending on the idle-up switch's position.
- Press the CURSOR key once. A flashing percent indicator should appear.
- Now you can adjust the amount of Idle-Up with the (+) or (-) DATA INPUT keys, anywhere between 0 and 100% (to return to the default 25%, press both DATA INPUT keys).

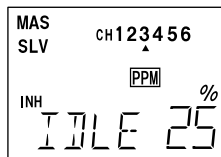

HOLD – Throttle Hold

The Throttle Hold function moves the engine throttle servo to a selected position near idle, and disengages it from the throttle stick. It is commonly used during autorotation, and activated with switch D . You can set the throttle position to be held over a -50 to +50% range centered about the throttle idle position. Activating throttle hold also disables revolution mixing (REVO).

Setting Up Throttle Hold

1. Press one of the MODE SELECT buttons until the HOLD window appears. The default is for the function to be inhibited.

To activate the throttle hold function, press the CURSOR key, then press the (+) DATA INPUT key. This will cause the flashing INH display to change to a flashing ON or OFF display, depending on the throttle hold switch's position.

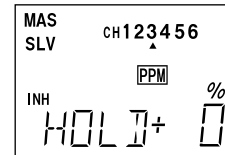

2. Press the CURSOR key once. A flashing percent indicator should appear.
3. Now you can adjust the throttle hold position with the (+) or (-) DATA INPUT keys, anywhere between -50 and +50% (to return to the default 0%, press both DATA INPUT keys).

REVO – Revolution Mixing

The revolution mixing function mixes pitch commands into rudder in order to suppress the torque generated by changes in the main rotor's pitch angle and rotational speed. You can input separate values for revolution mixing above and below one-half throttle. Revolution mixing is disabled whenever throttle hold is on.

For a clockwise-turning rotor, revolution mixing should apply right rudder when pitch is increased; for a counterclockwise-turning rotor, the opposite should occur. The operating direction is changed by changing the sign of the numbers in the display from plus (+) to minus (-) and vice versa.

NOTE: A procedure for adjusting revolution mixing is given in a table after the section on helicopter setup and trimming.

Revolution Mixing Programming

1. Call up the revolution mixing screen by repeatedly pressing one of the MODE SELECT buttons until the REVO window appears. The default is for the function to be activated. (To turn it off, press the

CURSOR key, then press the (-) DATA INPUT key. This will cause the flashing ON display to change to a flashing INH display.)

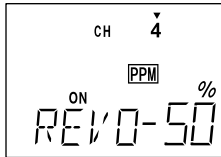

- Now press the CURSOR key twice, this will cause the plus or minus sign in front of the large number to flash on and off. You can set the direction of revolution mixing on each side of the half-throttle position by changing this flashing sign with the (+) or (-) DATA INPUT keys. Therefore, you'll either set plus or minus for both sides of the throttle stick's motion (indicated by the R/U or L/D indicator in the window). Use the (+) or (-) key to match the mixing direction to the rotor rotation: (-) gives right rudder, (+) gives left rudder. Verify that you get the proper motion of the

rudder channel when you move the throttle. You'll set the *amount* of travel in the next step.

- Again press the CURSOR key; this will cause the small percent sign in front of the large number to flash on and off. At this point you choose the percentage of revo mixing for *both* sides of half throttle. You may set a value of 0% to 100% for each side by moving the throttle stick in both directions, one at a time, and changing the percentage number to suit. Now verify that the rudder responds both the correct direction and amount for travel on both sides with the master control. If you wish to return the mixing percentage to the default 50% value, press both the (+) and (-) keys simultaneously.

R-OF – Rudder Offset

The rudder offset function is used to change the neutral position (offset) of the rudder when switch E is used to switch to idle-up. This function may be used to automatically change the trim of a helicopter flying at high speed. A clockwise-rotation rotor helicopter tends to drift to the right at high speed, so a rudder offset may be applied to yaw the helicopter to the left.

The necessary offset varies with model geometry, so it must be determined by noting changes at high speed. The rudder offset is affected by both revolution mixing and trim.

Rudder offset is turned on at the same time as idle-up, switched by switch D.

Setting up Rudder Offset

- Press one of the MODE SELECT buttons until the R-OF window appears. The default is for the function to be inhibited. To activate, press the CURSOR key, then press the (+) DATA INPUT key. This will cause the flashing INH display to change to a flashing ON or OFF display, depending on the idle-up switch's position.
- Press the CURSOR key once. The percent indicator should begin flashing.
- Now you can adjust the rudder offset position with the (+) or (-) DATA INPUT keys, anywhere between -100 and +100%

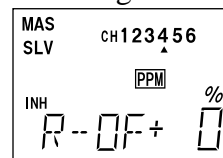

(to return to the default 0%, press both DATA INPUT keys).

HV-P – Hovering Pitch

The Hovering Pitch function may be used to trim the rotor pitch near hover without affecting the throttle setting. Changes in rotor speed caused by temperature, humidity, or other conditions can be accommodated. When used with the hovering throttle function, more exact trimming is possible.

Hovering pitch is controlled by the hovering pitch knob. When the hovering pitch knob is turned clockwise, the rotor pitch increases, and when turned counterclockwise, the rotor pitch decreases. Its settings may vary between values of +100% to -100%.

Using the Hovering Pitch Function

1. Press one of the MODE SELECT buttons until the HV-P window appears. The percent indicator should be flashing.
2. Move the hovering pitch knob to its center position. Now you can adjust the hovering point with the (+) or (-) DATA INPUT keys, anywhere between -100 and +100% (to return to the default 0%, press both DATA INPUT keys).

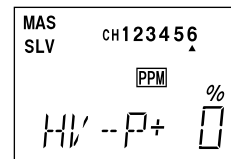

SWSH – Swashplate Type & AFR

The Swashplate Type function allows you to choose from any of the four swashplate types. (S1, S2, SR3 or SN3) You can also use Swash AFR rate settings to reduce (or increase) the function rate when S2, SR3 or SN3 type is selected as the swash type. The function rate reduction or increase for the aileron, elevator, and pitch may be controlled by this menu.

S1 Type: This type's helicopter has independent aileron and elevator servos linked to the swashplate. Most kits are S1 type. (SWSH1)

S2 Type: Use SWSH2 mixing when the pushrods are positioned as shown in the figure. Elevator operates with a mechanical linkage.

With Aileron inputs, the aileron and pitch servos tilt the swashplate left and right. With Pitch inputs, the aileron and pitch servos raise the swashplate up and down.

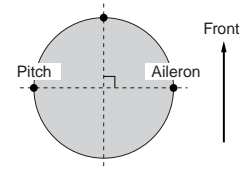

SR3 Type: If the servo inputs match the figure, use SWSH3 Mixing.

With Aileron inputs, the aileron and pitch servos tilt the swashplate left and right. With Elevator inputs, the three servos tilt the swashplate fore and aft. With Pitch inputs, all three servos raise the swashplate up and down.

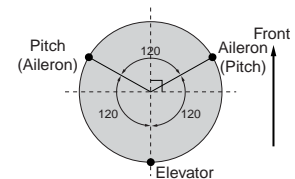

SN3 Type: Use SWSH3E Mixing if the servo inputs match the figure.

With Aileron inputs, the three servos tilt the swashplate left and right. With Elevator inputs, the elevator and pitch servos tilt the swashplate fore and aft. With Pitch inputs, all three servos raise the swashplate up and down.

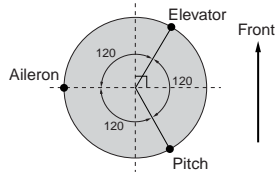

Use the reversing function (REV) as necessary to get the proper aileron, elevator, and pitch operations.

Choosing the swashplate type

1. Press on the MODE buttons until SWSH appears on the menu.
2. Select the desired swashplate type by pressing the (+) or (-) keys. At this time, the selected type will blink on and off.

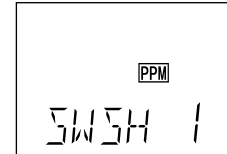

3. Press the CURSOR key, and the word SET? appears blinking on and off in the display.
4. Press both the (+) and (-) DATA INPUT keys at the same time. A beep-beep sound indicates that the selected type is now the active one.

Inputting AFR rate Values

5. Use the CURSOR key to select the channel (aileron, elevator or pitch) you wish to change the AFR rate. The active channel number is indicated by the arrow below. In the figure, AFR rate of SWSH2 type is being programmed.

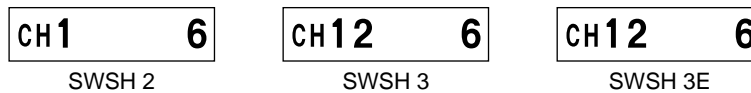
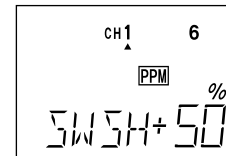

6. Choose the amount of AFR rate with the (+) or (-) keys. If you wish to return to the original 50% value, press both keys simultaneously.
7. Repeat this procedure for the AFR rate settings on the other channel remaining.

GLOSSARY

The abbreviations used with the T6XAs/T6XHs are defined below alphabetically. Related pages are given in parenthesis following the definition.

A

ABRK.... Airbrake function (30)
ACRO ... Acrobatic aircraft menu (39)
ATL Adjustable Travel Limit. Limits throttle trims to only the throttle idle position. (built in to your system)
ATV..... Adjustable Travel Volume. Function that adjusts the servo travel at the left and right sides. (24)

B

BACK.... Backup error. All programming was lost. Return transmitter for repair. (11)

C

camber . see FLTR
COPY ... Data copy: command used to copy one memory to another (40)
CURSOR.... Key used to step through menus (10)

D

D/R Dual rate: switch-controlled function reduces control travels. (25)
DATA INPUT Editing keys change numbers (10)
DRSW .. Dual rate switch mode menu (39)

E

ELVN Elevon function combines ailerons & elevators for tailless models. (32)
EXP Exponential Setting (26)

F

F/S Fail safe moves servos to preset positions during interference. (37)
FLPR Flaperon function gives the ailerons a flap function. (28)
FLTR..... Flap trim function; controls flap neutral position (29)

G

Gear..... Landing gear control. (2)

H

HELI..... Helicopter settings menu. (39)
HOLD ... Throttle hold function holds the throttle in a near-idle position (used for autorotation). (51)
HV-P Hovering pitch. Pitch trim function near hovering. (53)
HV-T Hovering throttle. Throttle trim function near hovering. (49)

I

IDLE..... Idle-up: use for loops, 540° stall turns, and other maneuvers by helicopters

INH Inhibit. Function will not operate

L

L/D Stick left or down motion

LBAT Low battery warning. The battery voltage is unsafe. (11)

M

MAS..... Master channel in mixer (35)
MIX Mix indicator when mixing active (11)
MOD Modulation: PCM or PPM (40)
MODE... Programming key changes menu (10)
MODL ... Model select menu (42)

N

NOR Normal failsafe (holds). (37)

O

OFF Function or Switch in OFF position.
ON Function or Switch in ON position.

P

PARA.... Parameter function. (38)
PCM Pulse Code Modulation. (40)
PI Pitch Rate Settings (49)
PMX..... Programmable mixer. Mixing between arbitrary channels. (35)
PPM..... Pulse Position Modulation, also known as FM (40)

R

R Reversed channel indicator (27)
R-OF.... Rudder offset function. (52)
R/U Right or Up stick motion
REST.... Data reset: clear model memory (38)
REV Reverse. Servo operating direction switching function. (27)
REVO ... Revolution. Mixing function that cancels the main rotor torque. (51)

S

SEL..... Select a model number. (42)
SET? Used to reset a memory or enter a stick or knob position.
SBTR.... Subtrim function used to adjust servo neutrals. (27)
SLV Slave channel in mixer (35)
STCK.... Stick (transmitter mode) function (5)
STRM ... Subtrim (neutral) adjust function (27)
SWSH... Swashplate Type & AFR (53)

T

TMEM... Trim memory function. (41)
TREV.... Throttle stick reversing function (5)

V

VTAL V-tail function combines the elevators and rudder. (31)

Numerical

1->4 Aileron -> Rudder mixing (33)
2->6 Elevator -> Flap mixing (35)
6->2 Flap -> Elevator mixing (34)

MODEL DATA RECORDING SHEET

Make copies before using

Model Name _____

Memory No. 1 • 2 • 3 • 4 • 5 • 6 **Model Type** ACRO • HELI **Modulation** FM • PCM

MENU FUNCTION			CH 1	CH 2	CH 3	CH 4	CH 5	CH 6
REV	Servo Reverse	(circle N or R)	N • R	N • R	N • R	N • R	N • R	N • R
SBTR	Subtrims	Value	%	%	%	%	%	%
ATV	Adj. Travel Volume	R/U	%	%	%	%	%	%
		L/D	%	%	%	%	%	%
D/R	Dual Rate settings Up/ Down		%	%	Dual Rate Sw Mode 1•2			
F/S	Failsafe function Normal • F/S		N • F	N • F	N • F	N • F	N • F	N • F
EXP	Exponential	Up/ Down	%	%	%	%		

ACRO Settings

FLPR	Flaperon Mixing	ACT•INH	Direction + • - Amount ____%					
FLTR	Flap Trim	ACT•INH	Direction + • - Amount ____%					
ABRK	Airbrake Mixing	ACT•INH	CH2 ____%		CH6 ____%			
V-TAL	V-tail Mixing	ACT•INH	CH2 + • - ____%		CH6 + • - ____%			
ELVN	Elevon Mixing	ACT•INH	CH 1	%	CH 2	%		
1->4	Ail -> Rud Mixing	ACT•INH	Direction + • - Amount ____%					
6->2	Flap -> Elevator Mixing	ACT•INH	Direction + • -		Amount ____%	Offset ____%		
2->6	Elevator -> Flap Mixing	ACT•INH	Direction + • - Amount ____%					
PMX1	Programmable Mixer 1	ACT•INH	M CH ____	S CH ____	R/U + • - ____%		L/D + • - ____%	
PMX2	Programmable Mixer 2	ACT•INH	M CH ____	S CH ____	R/U + • - ____%		L/D + • - ____%	

HELI Settings

HV-T	Hovering Throttle	Always on	Setting ____%						
IDLE	Idle Up	ACT•INH	Setting ____%						
HOLD	Thr. Hold	ACT•INH	Setting ____%						
REVO	Revolution Mixing	ACT•INH	Low Side (R/U) + • - ____%		High Side (L/D) + • - ____%				
R-OF	Rudder Offset	ACT•INH	Setting ____%						
HV-P	Hovering Pitch	Always on	Setting ____%						
PI-N	Pitch Rate	Always on	(N) ____% ____% (I) ____% ____% (H) ____% ____%						
SWSH	Swash Type & AFR	Always on	Type 1 • 2 • 3 • 3E	CH1	%	CH2	%	CH6	%

REPAIR SERVICE

Before you decide to have your system repaired, if there is no apparent physical damage, read this instruction manual again and check to be sure that you are operating the system as it is supposed to be operated. If you are still having trouble, pack up your system in its original shipping materials and send it to your nearest authorized Futaba R/C Service Center.

Be sure to include a note in your package that describes the trouble in as much detail as possible, including:

- Symptoms of the problem, any unusual mounting conditions
- A list of items you are sending, and what you want to be repaired.
- Your name, address, and telephone number.
- When requesting warranty repair, please include the warranty card.

Read the warranty card supplied with your system.

If you have any questions regarding this product, please consult Futaba. The address and telephone numbers of our service center is given below. Telephone inquiries are accepted from 9:00 AM to 5:00 PM weekdays, except on holidays.

Futaba Corporation of America

P.O. Box 19767, 4 Studebaker
Irvine CA 92613-9767

Telephone: 1-949-455-9888

FAX 1-949-455-9899