

**INSTRUCTIONS FOR USE**  
**EVERYSDI® [ev-RIZ-dee]**  
(risdiplam)  
for oral solution

Please read and understand this **Instructions for Use** and the Patient Information leaflet before you start taking EVRYSDI for information about EVRYSDI and how to prepare and give EVRYSDI through an oral syringe, gastrostomy tube (G-tube), or nasogastric tube (NG-tube).

If you have any questions about how to take EVRYSDI, contact your healthcare provider.

EVERYSDI should come as a liquid in a bottle when you receive it from the pharmacy. **Do not** take EVRYSDI and contact your pharmacist if the medicine in the bottle is a powder.

**Each EVRYSDI carton contains (see Figure A):**

- ❶ 1 Cap
- ❷ 1 Bottle adapter
- ❸ 1 EVRYSDI bottle
- ❹ 2 Reusable oral syringes
- ❺ 1 Instructions for Use (not shown)
- ❻ 1 Prescribing Information and Patient Information (not shown)

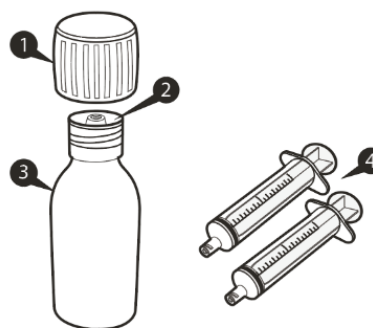

Figure A

**Reusable Oral Syringe Overview (see Figure B)**

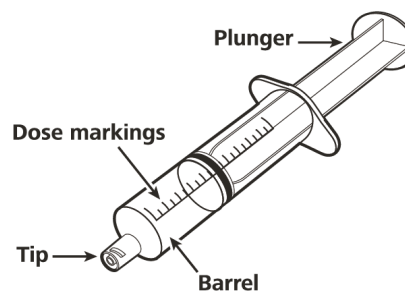

Figure B

## Important information about EVRYSDI

- Ask your healthcare provider to show you the correct oral syringe you should use and how to measure your prescribed daily dose.
- Always use the reusable oral syringes that come with EVRYSDI to measure your prescribed daily dose. If your carton does not contain two identical syringes, contact your pharmacist.
- Always take EVRYSDI exactly as your healthcare provider tells you to take it.
- Take EVRYSDI 1 time daily after a meal at approximately the same time each day.
- **Do not** take EVRYSDI if the bottle adapter is not in the bottle. If the bottle adapter is not in the bottle, contact your pharmacist.
- **Do not** mix EVRYSDI into food or liquids. Do not mix EVRYSDI with formula or milk.
- **Do not** take EVRYSDI if the bottle or oral syringes are damaged.
- **Avoid** getting EVRYSDI on your skin or in your eyes. If EVRYSDI gets on your skin, wash the area with soap and water. If EVRYSDI gets in your eyes, rinse your eyes with water.
- If you spill EVRYSDI, dry the area with a dry paper towel and then clean with water. Throw away the paper towel in the trash and wash your hands well with soap and water.
- If there is not enough EVRYSDI left in the bottle for your prescribed dose, throw away (discard) the bottle with remaining EVRYSDI and used oral syringes according to your local requirements.
- Use a new bottle of EVRYSDI to get your prescribed dose.  
**Do not** mix EVRYSDI from the new bottle with the bottle you are currently using.

## How to store EVRYSDI

- Store EVRYSDI in the refrigerator between 36°F to 46°F (2°C to 8°C). Do not freeze.
- Store EVRYSDI in the original amber bottle in an upright position with the cap tightly closed.
- Throw away (discard) any unused portion of EVRYSDI 64 days after constitution. Please see the **Discard After** date written on the bottle label (see Figure C).
- Ask your pharmacist for the **Discard After** date if it is not written on the bottle label.
- **Keep EVRYSDI and all medicines and syringes out of the reach of children.**

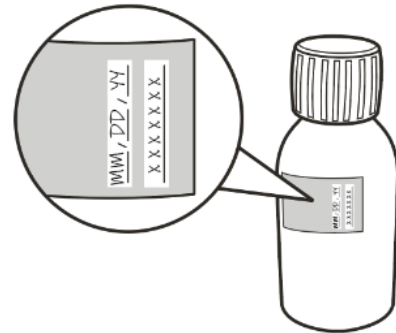

Figure C

## A) Preparing and withdrawing your dose

### How to prepare your dose of EVRYSDI

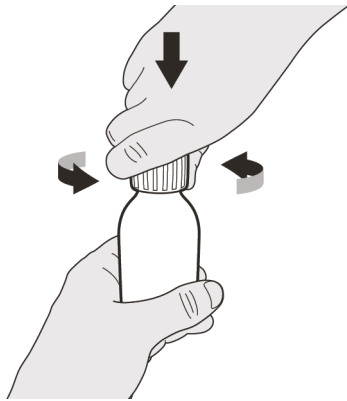

Figure D

#### Step A1

Remove the cap by pushing it down and then twisting the cap to the left (counterclockwise) (See Figure D).

Do not throw away the cap.

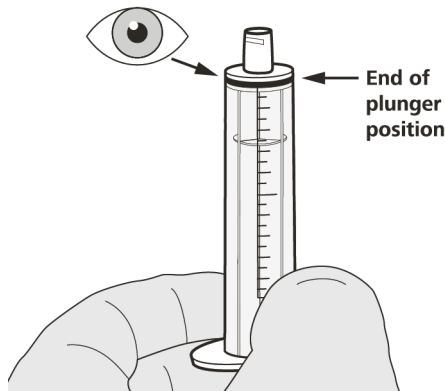

Figure E

#### Step A2

Push the plunger of the oral syringe all the way down to remove any air in the oral syringe (See Figure E).

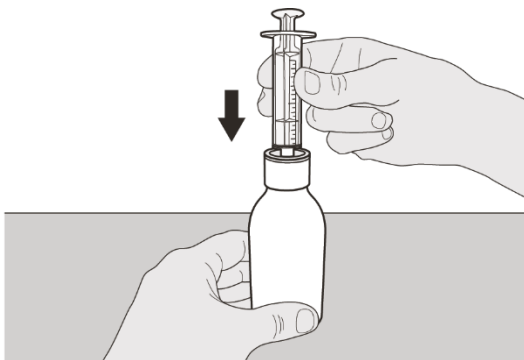

Figure F

#### Step A3

Place the EVRYSDI bottle on a flat surface. While keeping the bottle in an upright position, insert the syringe tip into the bottle adapter (See Figure F).

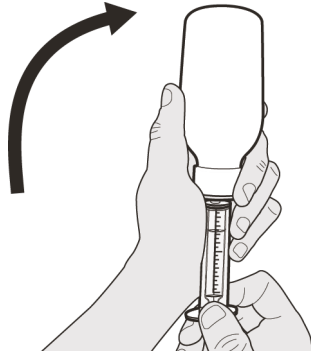

Figure G

#### Step A4

Carefully turn the bottle upside down with the syringe tip firmly inserted into the bottle adapter (See Figure G).

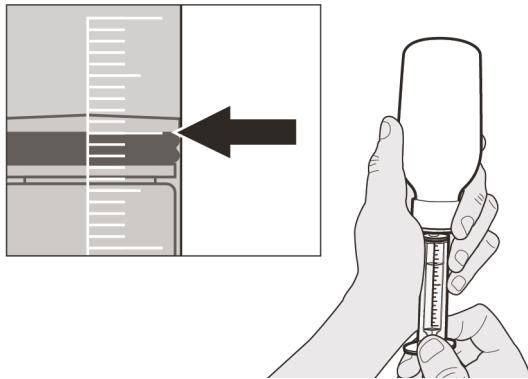

Figure H

#### Step A5

Slowly pull back on the plunger to withdraw your prescribed dose of EVRYSDI.

The top of the black plunger stopper must line up with the mL marking on the oral syringe for your prescribed daily dose (See Figure H).

After the correct dose is withdrawn, **hold the plunger in place to keep the plunger from moving.**

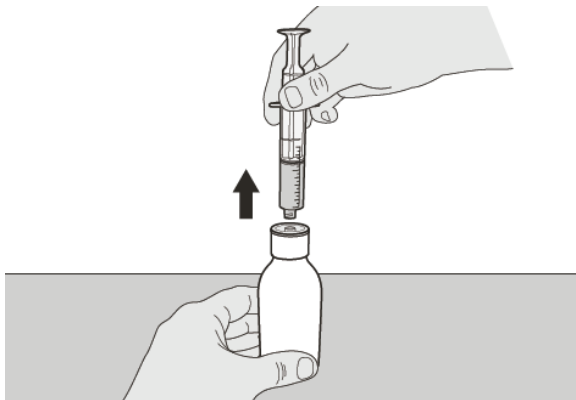

Figure I

#### Step A6

**Continue to hold the plunger in place to keep the plunger from moving.** Leave the oral syringe in the bottle adapter and turn the bottle to an upright position. Place the bottle onto a flat surface. Remove the oral syringe from the bottle adapter by gently pulling straight up on the oral syringe while holding the plunger in place (See Figure I).

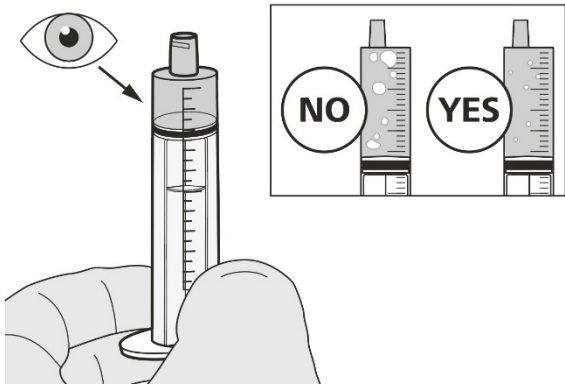

Figure J

#### Step A7

Hold the oral syringe with the syringe tip pointing up. Check the EVRYSDI in the oral syringe. **If** there are large air bubbles in the oral syringe (See Figure J) **or if** you have drawn up the wrong dose of EVRYSDI, insert the syringe tip firmly into the bottle adapter while the bottle is in an upright position. Push the plunger all the way down so that EVRYSDI flows back into the bottle and repeat Steps A4 through A7.

**Take or give EVRYSDI right away after it is drawn up into the oral syringe.** If it is not taken within 5 minutes, throw away EVRYSDI liquid from your oral syringe into the household trash. Do this by pushing the plunger all the way down to remove EVRYSDI from the oral syringe. Prepare a new dose starting with Step A2.

#### Step A8

Put the cap back on the bottle. Turn the cap to the right (clockwise) to tightly close the bottle (See Figure K). Do not remove the bottle adapter from the bottle.

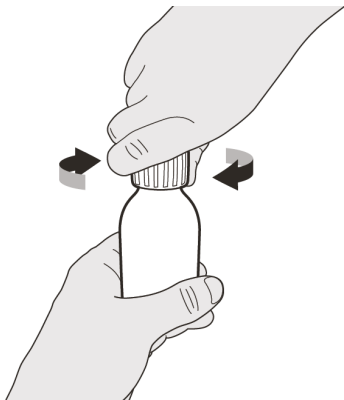

Figure K

If you are taking your dose of EVRYSDI by mouth, follow the instructions in “**B) How to take a dose of EVRYSDI by mouth**”.

If you are taking your dose of EVRYSDI through a gastrostomy tube, follow the instructions in “**C) How to give a dose of EVRYSDI through a gastrostomy tube**”.

If you are taking your dose of EVRYSDI through a nasogastric tube, follow the instructions in “**D) How to give a dose of EVRYSDI through a nasogastric tube**”.

## B) How to take a dose of EVRYSDI by mouth

Sit upright when taking a dose of EVRYSDI by mouth.



Figure L

### Step B1

Place the oral syringe into the mouth **with the tip along either cheek**.

**Slowly** push the plunger all the way down to give the full dose of EVRYSDI (See Figure L).

**Giving EVRYSDI into the throat or too fast may cause choking.**

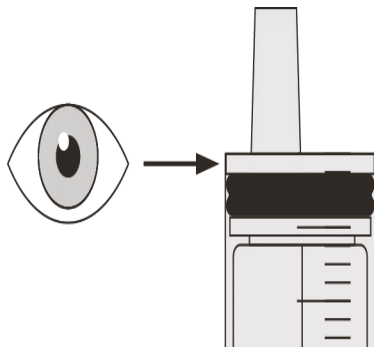

Figure M

### Step B2

Check that there is no EVRYSDI left in the oral syringe (See Figure M).



Figure N

### Step B3

**Drink about a tablespoon (15 mL)** of water right after taking the prescribed dose of EVRYSDI to ensure the drug has been completely swallowed (See Figure N).

**Go to Step E for cleaning of the syringe.**

### C) How to give a dose of EVRYSDI through a gastrostomy tube

If you are giving EVRYSDI through a gastrostomy tube, ask your healthcare provider to show you how to inspect the gastrostomy tube before giving EVRYSDI.

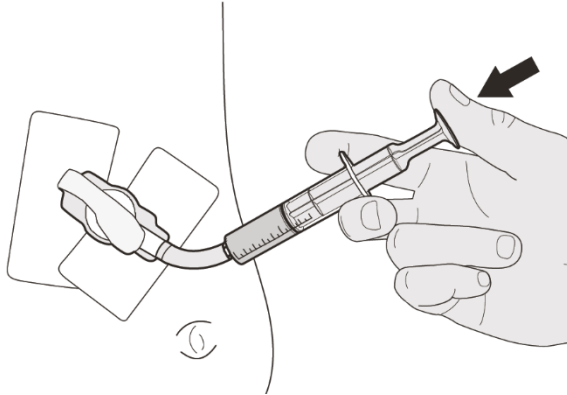

Figure O

#### Step C1

Place the oral syringe tip into the gastrostomy tube. Slowly push the plunger all the way down to give the full dose of EVRYSDI (See Figure O).

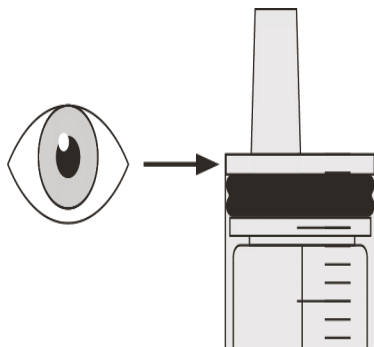

Figure P

#### Step C2

Check that there is no EVRYSDI left in the oral syringe (See Figure P).

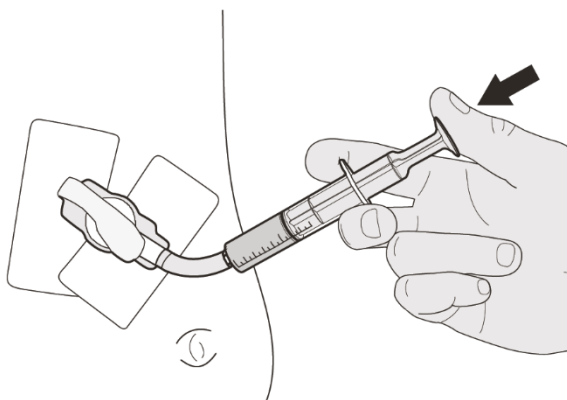

Figure Q

#### Step C3

Flush the gastrostomy tube with 10 mL to 20 mL of water right after giving the prescribed dose of EVRYSDI (See Figure Q).

**Go to Step E for cleaning of the syringe.**

## D) How to give a dose of EVRYSDI through a nasogastric tube

If you are giving EVRYSDI through a nasogastric tube, ask your healthcare provider to show you how to inspect the nasogastric tube before giving EVRYSDI.

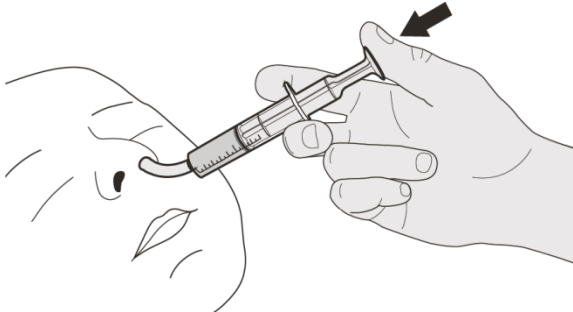

Figure R

### Step D1

Place the oral syringe tip into the nasogastric tube. Slowly press the plunger all the way down to give the full dose of EVRYSDI (See Figure R).

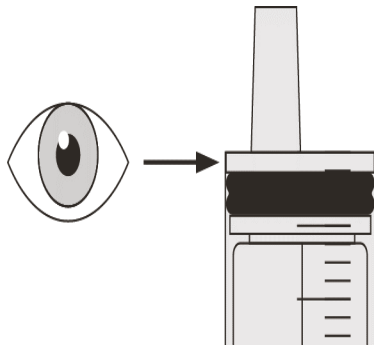

Figure S

### Step D2

Check that there is no EVRYSDI left in the oral syringe (See Figure S).

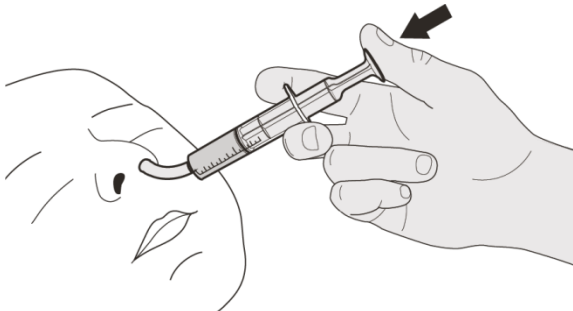

Figure T

### Step D3

Flush the nasogastric tube with 10 mL to 20 mL of water right after giving the prescribed dose of EVRYSDI (See Figure T).

**Go to Step E for cleaning of the syringe.**



## E) How to clean the oral syringe after use

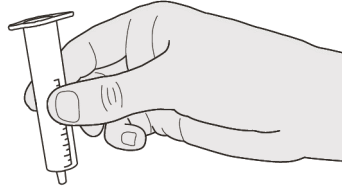
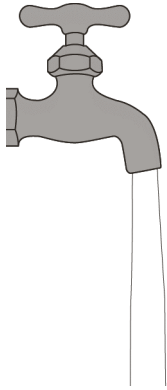

Figure U

### Step E1

Remove the plunger from the oral syringe by pulling the plunger away from the syringe until the plunger comes out of the syringe.

Rinse the oral syringe barrel well under clean water (See Figure U).

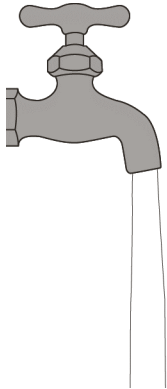

Figure V

### Step E2

Rinse the plunger well under clean water (See Figure V).

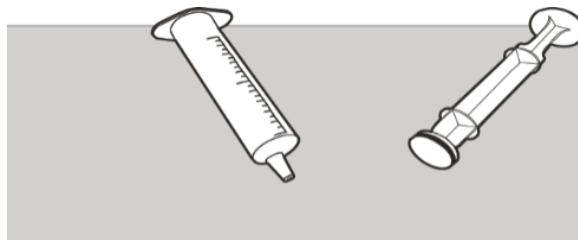

Figure W

### Step E3

Check that the oral syringe barrel and plunger are clean.

Place the oral syringe barrel and plunger on a clean surface in a safe place to dry (See Figure W).

Wash your hands with soap and water.

After the oral syringe barrel and plunger are dry, put the plunger back into the oral syringe barrel and store the syringe with your medicine.

EVRYSDI is a registered trademark of Genentech, Inc.

Distributed by:

**Genentech, Inc.**

1 DNA Way

South San Francisco, CA 94080-4990

Approved: 4/2021

This Instructions for Use has been Approved by the U.S. Food and Drug Administration.

©2021 Genentech, Inc. All Rights Reserved