

INSTRUCTIONS FOR USE

# Sara 3000



## **WARNING**

**To avoid injury, always read this Instructions for Use and accompanied documents before using the product.**



**Mandatory to read the Instructions for Use**

Design Policy and Copyright

® and ™ are trademarks belonging to the Arjo group of companies.

© Arjo 2019.

As our policy is one of continuous improvement, we reserve the right to modify designs without prior notice. The content of this publication may not be copied either whole or in part without the consent of Arjo.

## Contents

<b>Safety Instructions</b> .....	<b>3</b>
Intended use .....	3
General Safety Instructions .....	4
Symbols and Definitions used in this document .....	4
<b>Foreword</b> .....	<b>5</b>
<b>Parts designation / legend</b> .....	<b>6</b>
<b>Product Description and Handling Instructions</b> .....	<b>7</b>
Installation Instructions .....	7
Features and functions .....	7
Hand control .....	7
Dual control switch .....	7
Emergency Stop Button .....	7
Power on / Reset Button .....	7
Power off button .....	7
Automatic Cut Out - for use when Raising .....	7
Automatic Stop Function - for use when Lowering .....	8
OverHeat protection .....	8
System failure lower override .....	8
Battery Discharge Indicator .....	8
Hour /Cycle Meter .....	8
Chassis Castor Brakes .....	8
Foot Support .....	8
Lower Leg Straps .....	8
Adjustable Width Chassis Legs .....	9
Scale (optional) .....	9
Check list before use .....	9
Preparation before transfer .....	9
Using Standing Sling or using Transfer Sling .....	9
<b>Battery Charging</b> .....	<b>13</b>
<b>Disinfection, Cleaning and Maintenance</b> .....	<b>15</b>
General Equipment Cleaning and Care .....	15
Daily checks .....	15
Servicing Advice .....	15
Parts lists and circuit diagrams .....	16
Periodic Testing .....	16
Environmental Advice .....	16
Slings .....	16

**Care and Preventive Maintenance** ..... 17  
Preventive Maintenance Schedule .....17  
**Labels** ..... 18  
**Technical Specification** ..... 20  
Component Weights .....20  
Electrical .....20  
Environment .....21  
Maximum sound power level .....21  
Sara 3000 Dimensions .....22  
**Troubleshooting** ..... 23  
**Electromagnetic Compatibility (EMC)** ..... 24

# Safety Instructions

---

## Intended use

*Sara 3000* is a mobile standing and raising aid, with Safe Working Load of 200 kg (440 lbs), intended to be used for raising the patient or resident to a standing position and for short indoor transfer of patients/residents (e.g. raising from bed and transit to wheelchair, or from wheelchair to toilet) in hospitals, nursing homes, home care environment (including private households) or other health care facilities.

*Sara 3000* shall always be handled by a trained caregiver, continuously attending to the patient/resident, and in accordance with the instructions outlined in the Instructions for Use.

This equipment is intended to be used with clip slings, except for the transfer sling which also have loops for attachment of the leg flaps to the central lug situated on the resident support arms. Use slings that are designed for *Sara 3000*.

*Sara 3000* should only be used for the purpose specified in this Instructions for Use. Any other use is prohibited.

### Patient/Resident assessment

We recommend that facilities establish regular assessment routines. Caregivers should assess each resident/patient according to the following criteria prior to use:

- Patient/resident sits in a wheelchair;
- is able to partially bear weight on at least one leg;
- has some trunk stability;
- is dependent on carer in most situations;
- is physically demanding for carer;
- stimulation of remaining abilities is important.

If the patient/resident does not meet these criteria an alternative equipment/system shall be used.

Before attempting to use *Sara 3000*, a full clinical assessment of the patient/resident condition and suitability must be carried out according to above by caregiver.

*Sara 3000* shall only be used after the patient/resident has been carefully assessed by a caregiver trained in following the instructions for use or the patient/resident's clinician. Different conditions such as spinal injuries, paraplegics, osteogenesis imperfecta or epileptic seizures may exclude the use of *Sara 3000*.

## Installation requirements

The installation process might be done by potential operator subject to completely clear and understood the Instructions for Use before using *Sara 3000*.

### Expected service life

The expected service life of *Sara 3000* is the maximum period of useful life.

Expected operational life of *Sara 3000* is 10 (ten) years, subject to preventive maintenance being carried out in accordance with the instructions for care and maintenance found in the *Instructions for Use*.

The actuator shall be replaced every 50 000 lifting cycles.

The operational life of the slings is dependent on the actual use conditions.

The equipment will not be suitable for use if it is damaged.

*Sara 3000* is a reusable device. The requirements of chapter "Disinfection, cleaning and maintenance" should be considered.

Other consumable parts, e.g. batteries, slings, etc. are also subject to wear and their expected operational life is dependent on usage.



**Caution:** Although manufactured to a high standard, the *Sara 3000* and its accessories shall not be left for extended periods in humid or wet areas.

Do not under any circumstances spray the *Sara 3000* or accessories (excluding slings or Arjo approved wet environment equipment) with water, such as under the shower.

# Safety Instructions

---

## General Safety Instructions

Any references made to the 'resident' or 'patient' in this document, means the person being raised.

These Instructions for use are mandatory for the safe and effective handling of *Sara 3000*, including the safety of the resident and the caregiver.



**Warning: READ BEFORE USE.** Before using your *Sara 3000* you must read and fully understand these Operating and Product Care Instructions. You must be trained on *Sara 3000*, and any accessories, as well as its functions and controls.

If you require assistance in the setting up, use or maintenance of the *Sara 3000*, or if you experience any unexpected operation while using it, please contact your local Arjo office. A list is given inside the back cover of this manual.



**Warning:** Only Arjo designated parts, designed for the purpose shall be used for *Sara 3000* to avoid injuries attributable to the use of inadequate parts.

Unauthorised modifications or repairs on *Sara 3000* may affect its safety and will invalidate any warranty. Arjo will not accept responsibility for any accidents, incidents or lack of performance that occur as a result of any such unauthorised modification or repair.



**Warning:** This equipment includes small parts that may present a choking hazard to small children if inhaled or swallowed.

Keep children and pets away from the equipment.

The hand control cable presents a strangulation risk; take all precautions necessary to prevent this.

## Definitions used in this document



### Warning

This means failure to understand and obey this warning may result in injury to you or to others.



### Caution

This means failure to follow these instructions may cause damage to all or parts of the system or equipment.

# Foreword

---

Thank you for using *Sara 3000*.

If you would require information, further to these Operating and Product Care Instructions, or replacement parts, please contact your local Arjo representative who can provide comprehensive support and service programs to maximize the long-term safety, reliability and value of your *Sara 3000*.

If there is anything in these Operating and Product Care Instructions that is confusing or difficult to understand, please contact your local Arjo representative.

Contact details appear on the back cover of this document.

Should any other information (e.g. a video or abbreviated Guidelines For Use) accompany these Operating and Product Care Instructions, please note that they do not replace the information in this booklet as the latter also contains important safety instructions. Any abridged guidelines are not a replacement of the full instructions for *Sara 3000*, its parts and Arjo sling. Before operating *Sara 3000* be sure that you read, understand and follow all the instructions and guidelines for both *Sara 3000* and the Arjo sling.

If a serious incident occurs in relation to this medical device, affecting the user, or the patient then the user or patient should report the serious incident to the medical device manufacturer or the distributor. In the European Union, the user should also report the serious incident to the Competent Authority in the member state where they are located.

# Parts designation / legend

Parts referred to in this manual

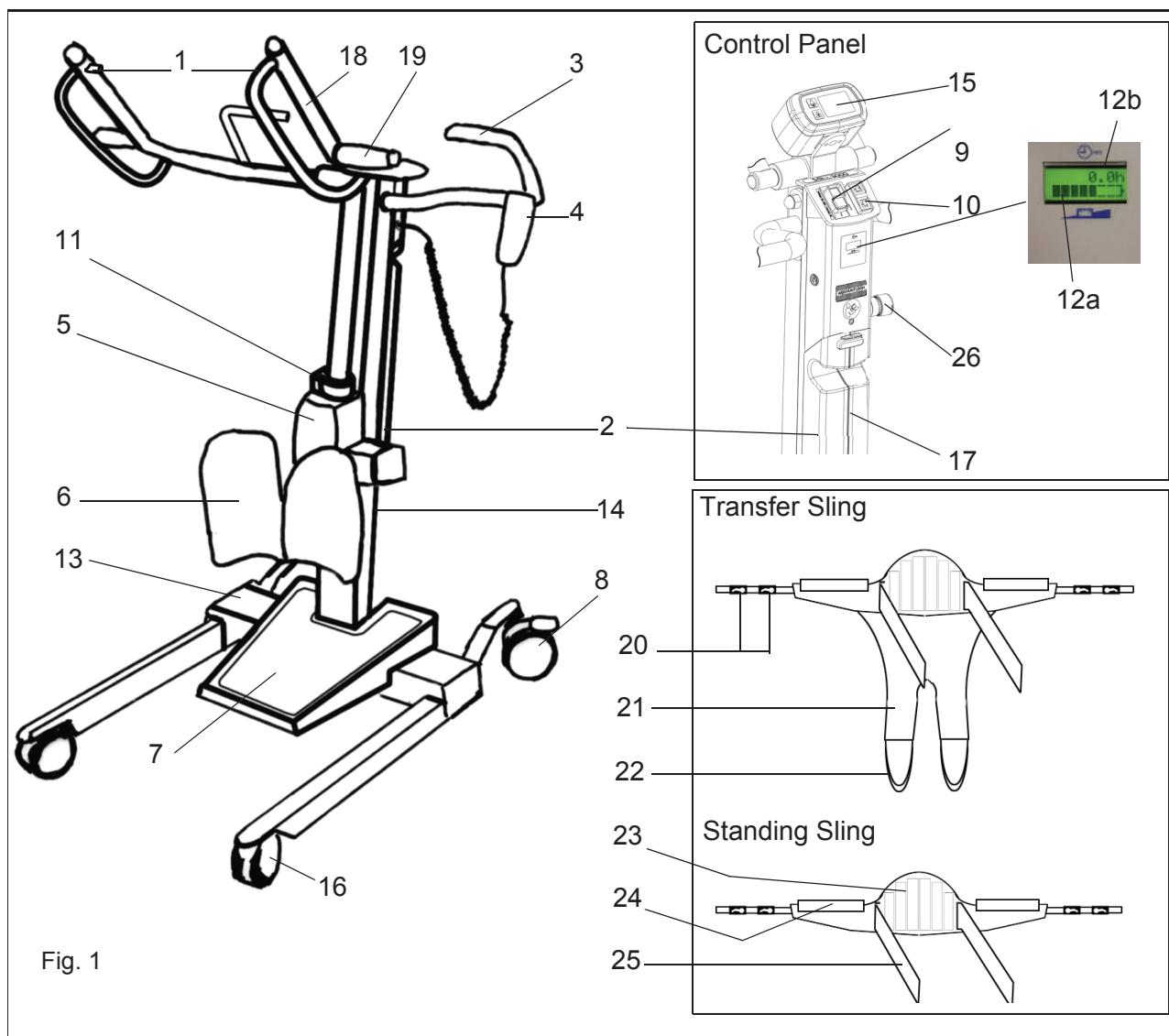

- |   |   |
|---|---|
| 1. Clip Attachment Points                                     | 14. Chassis Vertical Mast                       |
| 2. Battery Pack   | 15. Scale Unit Display (if fitted)              |
| 3. Steering Handgrips   | 16. Front Castors                               |
| 4. Hand Control   | 17. Battery Release Button                      |
| 5. Motor/Actuator   | 18. Resident Support Arms                       |
| 6. Knee Support   | 19. Resident Support Grips                      |
| 7. Foot Support   | 20. Clips                                       |
| 8. Rear Castors with Brake                                    | 21. Leg Flaps                                   |
| 9. Power off button (red) and Power on / Reset button (green) | 22. Loops                                       |
| 10. Dual Up/Down Control                                      | 23. Anti-skid Back Support                      |
| 11. System Failure Lowering Override                          | 24. Padding                                     |
| 12. Battery Discharge Indicator (a) and Hour/ Cycle Meter (b) | 25. Chest Fixation Strap                        |
| 13. Base of Chassis   | 26. Emergency Stop button (red) (on side panel) |



# Product Description and Handling Instructions

## Installation Instructions.

The *Sara 3000* is delivered to you in fully assembled state.

Unpack the battery pack supplied, and fully charge it until the charger indicates full charge, see “Battery Charging” section.

When the battery pack is fully charged, disconnect the electric power, remove the pack from the charger, and insert it fully back into the *Sara 3000* battery compartment located at the rear of the mast.

## Features and functions

**Hand control:** A semi-remote control unit attached to the *Sara 3000* by an extending cable. The hand controls are for the raising / lowering and chassis leg opening/closing functions. Direction arrows adjacent to the buttons indicate each function (see Fig. 2). If pressure is released from any button during use, the powered movement will stop immediately.

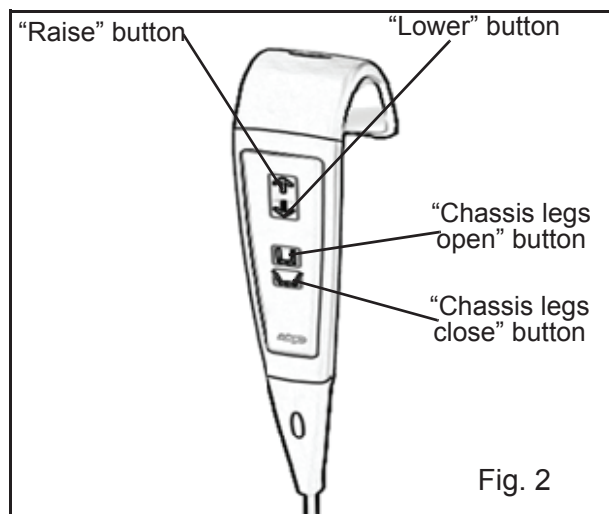

Fig. 2

**Dual control switch:** as an option to the hand control, the raising and lowering of the resident support arms can be controlled from this switch, situated on the front of the electronics/battery compartment. A label adjacent to the switch is for function identification (see Fig. 1). This switch will function even if the hand control cable has been unplugged.

**Emergency Stop Button**(red) (see Fig. 1): If you have to immediately stop any powered movement (other than by releasing pressure on the button on the hand control), press the red emergency stop button located on the side panel above the battery.

Once the Emergency Stop button has been operated, it must be reset by turning the red cap until it pops out. Now the *Sara 3000* can be operated again.

**Power on / Reset Button**(green) (see Fig. 1): On the top control panel. Press this button to turn on power to the *Sara 3000*. Also used to reset if the automatic overload fuse has operated (indicated by the button projecting outwards slightly). If the fuse has operated and, once reset, operates again, withdraw the lifter from use and contact Arjo service department or their appointed distributor.

**Power off button**(red) (see Fig. 1): On the top control panel. Press this button to turn off power to the *Sara 3000*.



**Warning:** The caregiver shall be aware that from the moment the lowering and raising functions are used, the resident support arms shall follow the movement of the used function.

If the resident support arms do not follow the movement indicated by the use of the pressed control button, release the button immediately and check for obstructions. Before removing the obstruction, make sure the resident will be supported and in a safe position at all times.

The following safety features have been put in place;

**Automatic Cut Out - for use when Raising:** (see Fig. 1) (not a caregiver / operator control but a function built into the electronics)

# Product Description and Handling Instructions

If the equipment is inadvertently overloaded (trying to raise a resident heavier than permitted), an automatic ‘cut out’ operates to prevent the *Sara 3000* lifting a load in excess of the safe working load; this will stop the lift motion automatically. “overload” occurs on Display and Buzzer beeps continuously. If this automatic cut out occurs, the electronics will reset when the button on the handset is released. After this, the resident can be lowered, by pressing the “lower” function button on the handset. Remove the resident from the equipment.

## Automatic Stop Function - for use when

**Lowering:**(see Fig. 1) Great care shall be taken not to lower the resident support arms onto the resident or any other obstruction, particularly when the resident is standing up and weight bearing. If this shall happen, the motor will continue to run but downward movement will be blocked by the obstruction. If this occurs, release pressure from the “lower” button immediately and operate the “raise” button until the equipment is clear. Then remove the obstruction.

**OverHeat protection:** Buzzer will beep twice every 15 seconds and “OverHeat” is displayed on the Hour/Cycle Meter (see Fig. 1) when the operator exceeds the duty cycle for the lift actuator (2 minutes/18 minutes). When signal occurs movement is still possible. The function protects the actuator against damage.

**System failure lower override:**This can be used in the event of main control failure. In the unlikely event that the hand control or dual control feature fails to operate the *Sara 3000*, with a resident still supported by the sling, provision for lowering has been made, using the system failure lower override, situated on the actuator, (see Figs. 1 & 3).

A label situated on the control collar is for quick and easy recognition (see Fig. 3) To operate this function, pull the slide control upwards until the resident’s own weight enables the mast to slowly lower. To cease lowering release the slide control. Only use this function in the event of normal control failure, do not use it for normal function lowering.



**Warning:** Before operating the “system failure lower override” to lower a resident, always ensure that a chair or suitable support is underneath ready to support the resident.

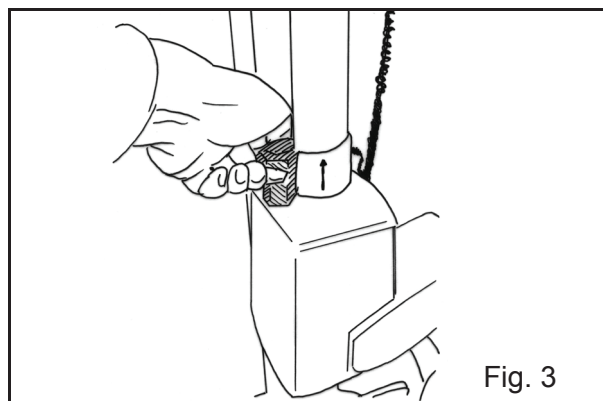

Fig. 3

**Battery Discharge Indicator:**(see Fig. 1) There is a small battery symbol on the bottom of the LCD. The battery symbol shows the level of battery charge.

**Hour /Cycle Meter:** (see Fig. 1) The upper line of the display shows the total duration of lifting and lowering operation in hours. The display can also show number of cycles by pressing the raise and lowering buttons at the same time. This is intended as an aid to help calculating the service intervals.

**Chassis Castor Brakes:** The chassis rear castors have brakes which can be foot operated if required (see Fig. 4), to keep the *Sara 3000* in position.

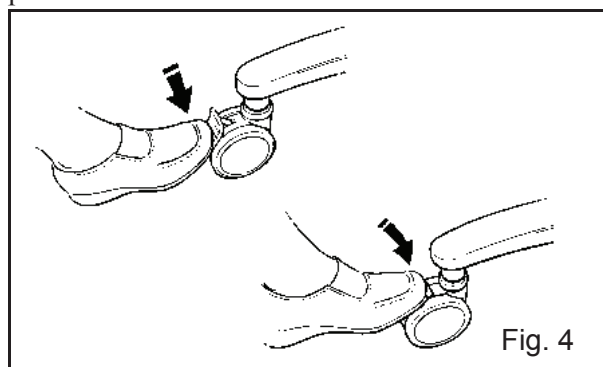

Fig. 4

**Foot Support:**For positioning before and supporting the resident’s feet during raising and transferring.

**Lower Leg Straps:**Accessory used to ensure that the lower parts of the resident’s legs stay close to the knee support. They pass around the knee supports, then around the resident’s lower calves. To fasten, click the strap into it’s socket as with a seatbelt. Ensure that the straps are firm but comfortable for the resident.

# Product Description and Handling Instructions

---

**Adjustable Width Chassis Legs:** To open the chassis legs to any variable width, press the appropriate button on the hand control. When pressure is released from the button, movement will stop and the chassis legs will remain securely in position.

The resident shall be transferred with the chassis legs closed, as this will be easier to manoeuvre through doorways, etc.

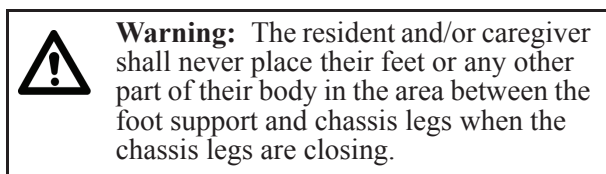

**Scale (optional):** To use the scale, if available, refer to the *Scale IFU*.

## Check list before use

For a list of what to check before use, please read the “Care and Preventive Maintenance” section of this document.

## Preparation before transfer

Before approaching the resident, the caregiver shall always tell the resident what they are going to do, and have the correct size sling ready.

If required, the chassis legs may be opened to go around a chair, wheelchair or to avoid bed legs or any other obstruction

Although a resident can be put into the sling with the *Sara 3000* close by, it may be easier to do so with the *Sara 3000* moved away.

For the transfer of residents and use of various slings refer to the instruction provided by the manufacturer of the sling.

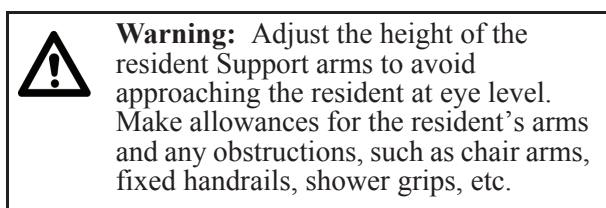

## Using Standing Sling or using Transfer Sling

For more information on slings, please read the sling documentation that was delivered with the sling, and the sling label.

Fig. 1 shows a Transfer Sling and a Standing Sling, and their different parts referred to in this manual.

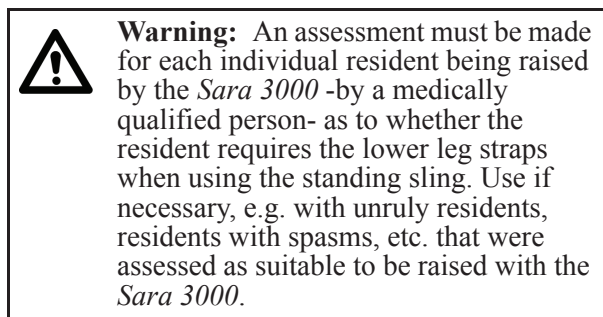

Do not use the leg fixation strap when using the Transfer sling.

The top of the sling can be recognised by the washing label which is placed on the outside top rim of the sling.

Encourage the resident to lean forward slightly to enable the sling to be placed around his/her lower back (see Fig. 6). Position the sling around the resident’s back so that the bottom of the sling lies horizontally about two inches or five centimetres above the resident’s waistline, with the resident’s arms outside the sling. Ensure that the support strap is separated and brought loosely around the body, and is not twisted or trapped behind the resident’s back.

# Product Description and Handling Instructions

When applying the transfer sling, take each leg section of the sling in turn and slide under each leg, (see Fig. 5).

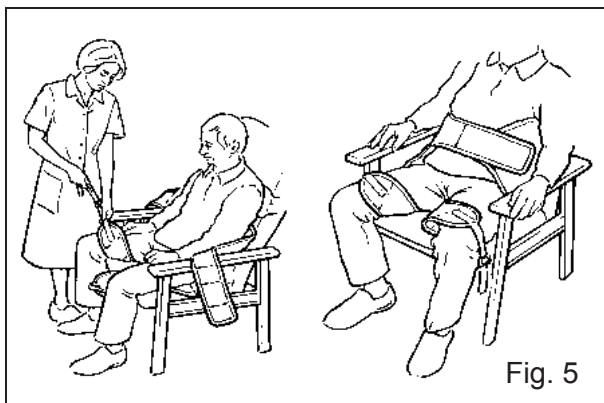

Fig. 5

To fasten the support strap securely, press the buckles (if available) or hook and loop strap (if available) together. The strap shall be tight, but comfortable for the resident. See fig 9. Remember to tighten the strap once the resident becomes raised from the chair.

The sling may be applied before or after the *Sara 3000* is brought into position.

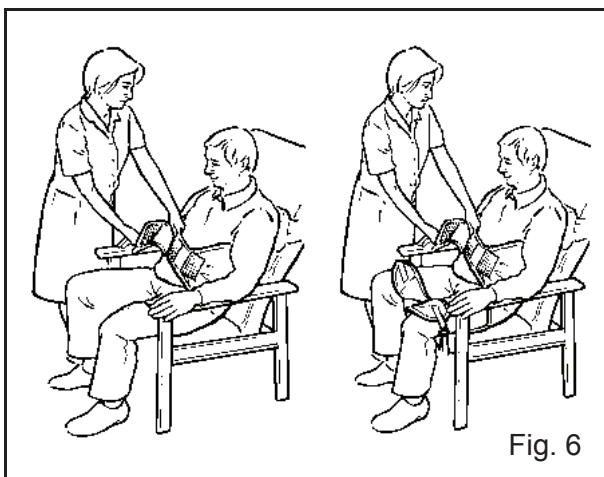

Fig. 6



**Warning:** The sling chest support strap must always be applied and fastened when using the sling.

The sling support strap will help to support the resident in the sling during the raising procedure. The strap also retains the sling in the correct position around the resident.

If the *Sara 3000* is not already close to the resident, bring it to the resident.

Apply the clips to the attachment points, and secure them for safety by pulling the clips as shown in Fig. 7.

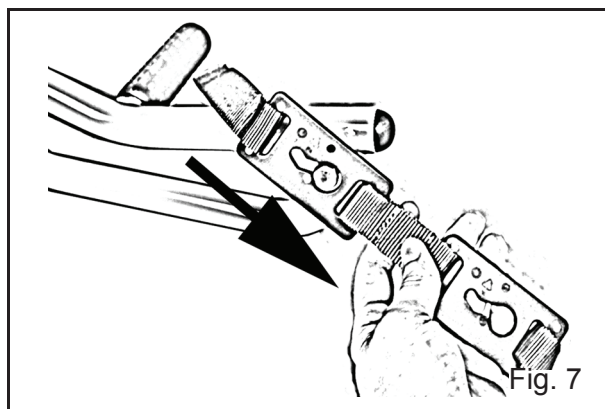

Fig. 7

When using the transfer sling; identify the attachment loop on each leg-side -left and right- of the sling and attach them on the central lug located in between the resident support arms, positioned towards the resident. (see Fig 8)

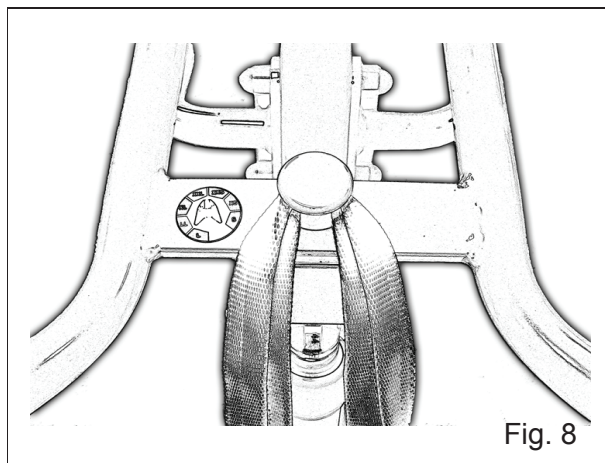

Fig. 8

# Product Description and Handling Instructions

When the resident is ready, help or allow the resident to place his/her feet on the foot support. Push the *Sara 3000* toward the resident to easily assist with this.

If required, the chassis legs may be opened to go around a chair, by operating the appropriate control button.

Carefully push the *Sara 3000* in closer to make full lower leg contact with the knee support. (see Fig. 9)

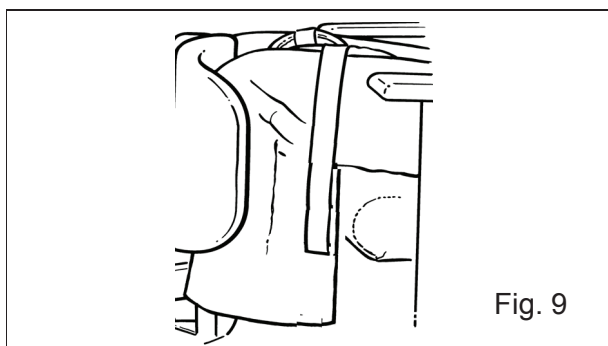

 **Warning:** Always check that all the sling attachment clips are securely connected and fully in position before and during the lifting cycle, and in tension as the resident's weight is gradually taken up.

Make sure each clip is attached to the correct clip attachment point on the resident support arms, and each loop is attached correctly and secure onto the lug should the Transfer Sling be used.

The resident then must hold on to the resident support grips with one or both hands. The resident is then ready to be raised (see Fig 10).

Operate the button on the hand control or dual control panel to raise the resident just clear of the chair, then stop the equipment by letting go of the button. (See Fig. 2).

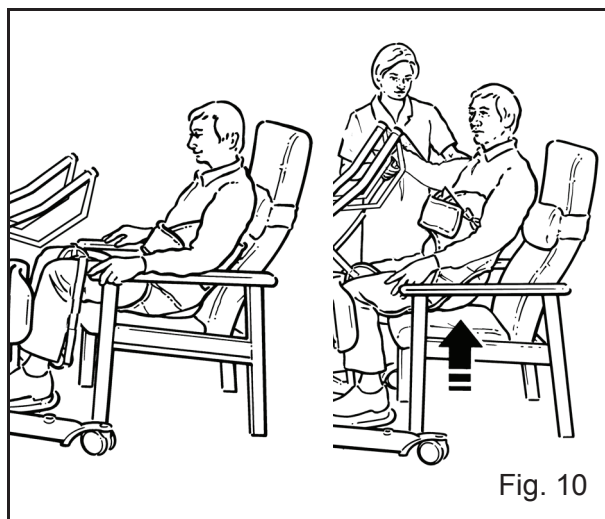

When raising the resident with a standing sling, the resident's body posture shall go from seated to standing position. When raising the resident with a transfer sling, the resident's body posture shall go from seated to seated / recumbent position.

The resident's body will be supported by the sling under the armpits, at the lower back and the chest. When raising with the transfer sling, the resident's lower body will also be supported.

When raising with the standing sling, if the resident is able to offer some assistance to stand, this may be beneficial for resident confidence and muscular exercise. Encourage the resident to give as much assistance as possible to raise from the chair and/or steady themselves. Ensure resident lies back against sling at all times.

When raising with the transfer sling, the resident shall not aid in being raised.

When using the transfer sling, do not raise the resident higher than seating position, as doing so will not be comfortable for the resident.

Use the raise button on the hand control to raise the resident to a suitable and comfortable height for the particular function (see Fig. 11).

If the hand control button or the dual control button is released during a function, powered motion will stop immediately.

# Product Description and Handling Instructions

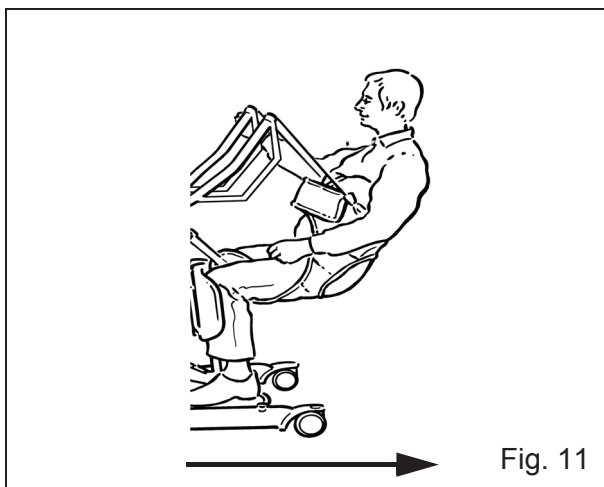

When using the standing sling, the resident can be raised to a fully standing position (see Fig. 12).

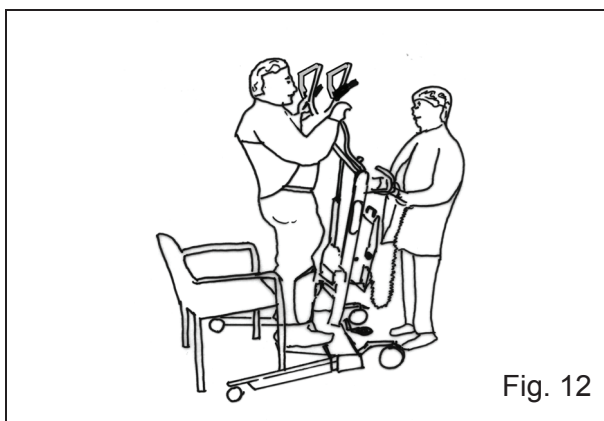

**Warning:** The resident's feet shall always remain in full contact with the foot support.

When raising, check to ensure that the resident's feet do not lift from the foot support. If they do, lower the resident immediately until resident's feet fully reach the foot support.

If residents can stand sufficiently well and lock their knees in the normal way when fully raised, their knees may come away from the knee- support and they will be able to lean back into the sling.

Residents who can only hold on to the resident support grips with one hand, such as those who have suffered a stroke, may still be raised with the *Sara 3000*, but their disabled arm shall be held down in front of the body during the raising by the caregiver (or a second caregiver), while their functioning hand holds the resident support arm in the normal way.

Now transfer the resident to desired position such as the toilet, wheelchair, chair, bed, etc. The resident shall not be transferred over long distances.

The transfer shall be performed with the chassis legs closed, as this will be easier when manoeuvring through doorways, etc.



**Warning:** Always move the *Sara 3000* in the direction shown in Fig. 11.

While the resident is raised, make any necessary adjustments to clothing, incontinence pads, etc., before lowering again.

Use the hand control to carefully lower the resident.

Apply the foot operated rear castor brakes to keep the *Sara 3000* in position.



**Warning:** When lowering the resident back into a seated position, ensure that the resident is positioned in such a way that the resident is fully supported by the seat, chair, toilet, etc. the resident is lowered on. Great care shall be taken not to lower the resident support arms onto the resident or any obstructions.

Remove the sling when the resident is seated by opening chest support strap, then pull the clips of the sling upward to unlock them from the resident support arms.



**Warning:** Do not attempt to release the attachment clips, loops or the Chest Fixation Strap (see Fig. 1) while the resident is supported by the sling.

# Battery Charging

The *Sara 3000* incorporates a battery discharge indicator, situated on the rear of the battery/electronics compartment (see inset to Fig. 1).

It is recommended that the battery is removed from the equipment and charged when the battery discharge indicator displays three filled segments and buzzer beeps once every 10 seconds, but lifting is possible until the display shows one filled segment and buzzer beeps continuously, at this point the battery must be charged as soon as possible.

Recharging the battery pack before it reaches a low state of battery charge or certainly totally discharged will prolong its life.

To ensure the *Sara 3000* is always ready for use, it is recommended that a freshly charged battery pack is always available. This is achieved by having additional battery packs available and keeping one on charge while the other is in use.

A battery that is charged for the first time, or after a long storage period, must be charged until the charger indicates full charge.

It may be considered good protocol to have a freshly charged battery ready for the start of every work shift.

The battery life is variable (2-5 years) and mainly depending on proper charging practices.

To extend the battery life, the battery must be charged at regular intervals until the charger indicates full charge.



**Warning:** Do not crush, puncture, open, dismantle or otherwise mechanically interfere with batteries.

Should the battery casing become cracked, and electrolyte come into contact with skin or clothing, wash immediately with water.

If the electrolyte contacts the eyes, wash immediately with copious amounts of water, and seek medical attention.

No smoking or naked flames in battery vicinity.

Do not charge batteries in a sealed container.

Do not place batteries near, or dispose of, in a fire.

Do not short circuit a battery.

Do not store batteries at temperatures in excess of 60°C (140°F).

When disposing of batteries, contact the appropriate local authority for advice.

The abbreviation 'Pb' shown adjacent to the recycling and trash bin symbols on the battery pack label is the element symbol for lead, and indicates that the battery contains lead and therefore should not be disposed of in the normal manner but must be recycled.

## Place the battery pack on charge as follows:

When the battery discharge indicator displays 3 filled segments, complete your lift cycle then take the *Sara 3000* to a convenient situation and remove the battery pack by holding the grip handle on the top and lift clear (see Fig 19).

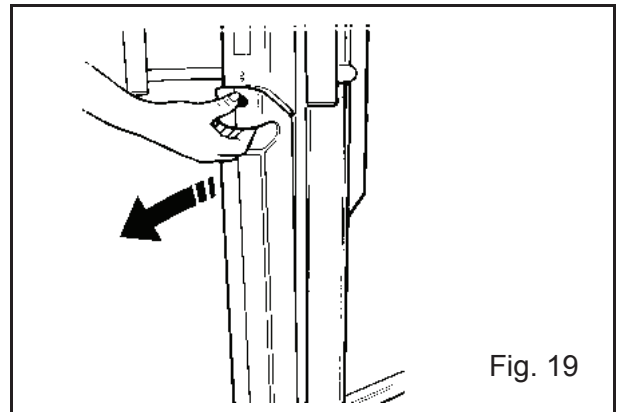

Fig. 19

Take the battery to the battery charger unit.



**Warning:** Hold the pack firmly when taking it out and putting it back into the *Sara 3000* or with the battery charger, to ensure it does not drop and become damaged, or cause personal injury.

## How to charge the battery

See *Battery Charger IFU 001-24257*.

A discharged battery shall be left to charge until the charger indicates full charge.

# Battery Charging

---

When the battery pack is fully charged, insert it back into the *Sara 3000*.

An electrical connection is made automatically.

Ensure the green Power on/Reset button is pressed in.

The *Sara 3000* is now ready for use.



**Caution:** After use, turn off the *Sara 3000* by pressing the red Power off button (Fig. 1). This will reduce power consumption.



# Disinfection, Cleaning and Maintenance

## General Equipment Cleaning and Care

How often the following actions are taken depends on how often the equipment is used.

Unless otherwise stated, before each and every use follow the cleaning, care and inspection procedures described in this section.



**Caution:** It is recommended that equipment, accessories and slings supplied by Arjo are regularly cleaned and/or disinfected between each resident use if necessary, or daily as a minimum. If the slings and equipment need cleaning, or are suspected of being contaminated, follow the cleaning and/or disinfection procedures recommended below, before re-using the equipment. This is especially important when using the same equipment for another resident, to minimise the risk of cross infection.

For cleaning your equipment and accessories wipe down with a damp cloth using warm water to which a disinfectant/cleaner has been added e.g. “ARJO CLEAN” disinfectant/cleaner or equivalent. Take extra care with areas that may trap dust or dirt.

For disinfection of contaminated equipment and accessories, use the preferred method of wiping the product completely with “hard surface disinfectant wipes” that are supplied impregnated with a 70% v/v solution of Isopropyl Alcohol.

A rubbing action will be necessary when using the wipes to promote effective disinfection of the surfaces.

70% v/v Isopropyl Alcohol wipes have been proved to be effective against MRSA and several other micro-organisms under light soiling conditions.



**Warning:** The lifter should be cleaned before it is used by another patient.



**Warning:** Do not soak the product which could cause corrosion.



**Caution:** If a hot air dryer is used to dry the equipment, the temperature must not exceed 80°C (176°F). Do not use petroleum based solvents or similar, since this may damage plastic parts.



**Warning:** Cleaning and disinfection products must be used in accordance with the manufacturers instructions and suitable eye, hand and clothing protection must be worn at all times when handling disinfectants.

## Daily checks

Please read the Care and Preventive maintenance section of this document for instructions on what needs to be checked daily.



**Warning:** Ensure that the castors are firmly secured to the chassis and that they roll and swivel freely.

Clean with water. (the function can be affected by soap, hair, dust and chemicals from floor cleaning).

Carefully inspect all plastic parts, in particular where there is personal contact with the resident's body, ensure that no cracks or sharp edges have developed which could injure the resident's skin or become unhygienic.

Check that all external fittings are secure and that all screws and nuts are tight.

## Servicing Advice



**Warning:** Arjo recommends that *Sara 3000* be maintained at regular intervals. See Preventive Maintenance Schedule section in this document.

# Disinfection, Cleaning and Maintenance

---

## Parts lists and circuit diagrams

These are available on request from Arjo or its approved distributors.

Spare parts, if required, are available from Arjo or its approved distributors.

Special tools are required for certain component replacement.

## Periodic Testing

To be carried out at weekly intervals:

For normal operation - raise and lower the resident support arms using the hand control and dual control switch, this is to test for full and efficient movement.

### Emergency Stop:

Test the emergency stop facility by operating the hand control to raise or lower the resident support arms, and whilst operating, press in the emergency stop button. (See inset to Fig. 1).

Powered movement should stop immediately.

Reset to normal function by resetting out the button.

Repeat this test using the dual control switch.

### Adjustable Width Chassis Function:

Open and close the chassis legs to check for full and efficient movement.

### General Equipment Condition:

A general visual inspection of all external parts should be carried out, and all functions should be tested for correct operation, to ensure that no adverse damage has occurred during use.



**Warning:** If in any doubt about the correct functioning of the *Sara 3000*, withdraw it from use and contact Arjo Service Department.

## Environmental Advice



This device is marked with the WEEE symbol (crossed-out wheeled bin) to indicate that it is electronic equipment covered by the Directive 2002/96/EC on waste electrical and electronic equipment. This is a European directive but applies worldwide. In European countries the WEEE symbol reminds you that all electrical and electronic products must be taken to a separate collection at the end of their working life. Do not dispose of this product in normal domestic or commercial waste - contact your local authority for advice on disposal.

## Slings



**Warning:** The slings shall be checked before using with each resident and if necessary washed according to instructions on the sling.

With regard to laundering, slings shall not be classified as linen. Slings shall be cleaned and disinfected only in strict accordance with the manufacturers instructions.

Mechanical pressure shall be avoided during the washing and drying procedure e.g. rolling or pressing, as these can damage parts vital to the safe and comfortable operation of the sling.



**Caution:** Wash using normal detergents, do not iron. Follow the instructions on the label of the sling.

It is essential that the sling attachment cords, the slings, their straps and attachment clips are carefully inspected before each and every use -as indicated in the Preventive Maintenance Schedule.

If the slings, cords or straps are frayed, or the clips damaged, the sling or attachment cord should be withdrawn from use immediately and replaced.

# Care and Preventive Maintenance

---

The *Sara 3000* is subject to wear and tear, and the following actions must be performed when specified to ensure that the product remains within its original manufacturing specification.

## Warning

**The points on this checklist are the minimum the manufacturer recommends. In some cases due to heavy use of the product and exposure to aggressive environment, more frequent inspections shall be carried out. Continuing to use this product without conducting regular inspections or when a fault is found will seriously compromise the user and residents' safety. Local regulations and standards may be higher than the manufacturers. Preventive maintenance specified in this manual can prevent accidents.**

## Note:

*Product cannot be maintained and serviced while in use with the patient.*

## Preventive Maintenance Schedule

Action/Check	Before each use	Every week	Every 12 months
<b>CAREGIVER OBLIGATIONS</b>			
Examine the sling, straps and clips for damage or fraying as required. Refer to sling documentation.	<b>X</b>		<b>S</b>
Visually check exposed surfaces for damage, sharp edges, etc.	<b>X</b>	<b>X</b>	
Visually check sling attachment points. Do not use if damaged.		<b>X</b>	
Make sure all labels are attached.		<b>X</b>	
Check to make sure the hand grips are secure. Re-bond if required.	<b>X</b>		<b>S</b>
Examine the charger and wires for integrity and connections.			<b>S</b>
Operate the <i>Sara 3000</i> through its full range.		<b>X</b>	
Visually check the handset and cable for damage.		<b>X</b>	
Perform a full function test on the <i>Sara 3000</i> .		<b>X</b>	<b>S</b>
Check operation of the Stop/Reset and System Lower Override Device.		<b>X</b>	<b>S</b>
Check batteries for leakage and/or deterioration. Replace if required.		<b>X</b>	<b>S</b>
Make sure all fixings, screws, nuts are secure and tight.		<b>X</b>	<b>S</b>
Check all castor wheels for wear. Replace as required.		<b>X</b>	<b>S</b>
Check that the covers fit correctly and are not damaged. Replace as required.		<b>X</b>	<b>S</b>
Check for evidence of corrosion. Replace as necessary.		<b>X</b>	<b>S</b>

## Warning

The actions marked with 'S' must be carried out by qualified personnel, using correct tools and knowledge of procedures. Failure to meet these requirements could result in personal injuries and/or unsafe product.

# Labels

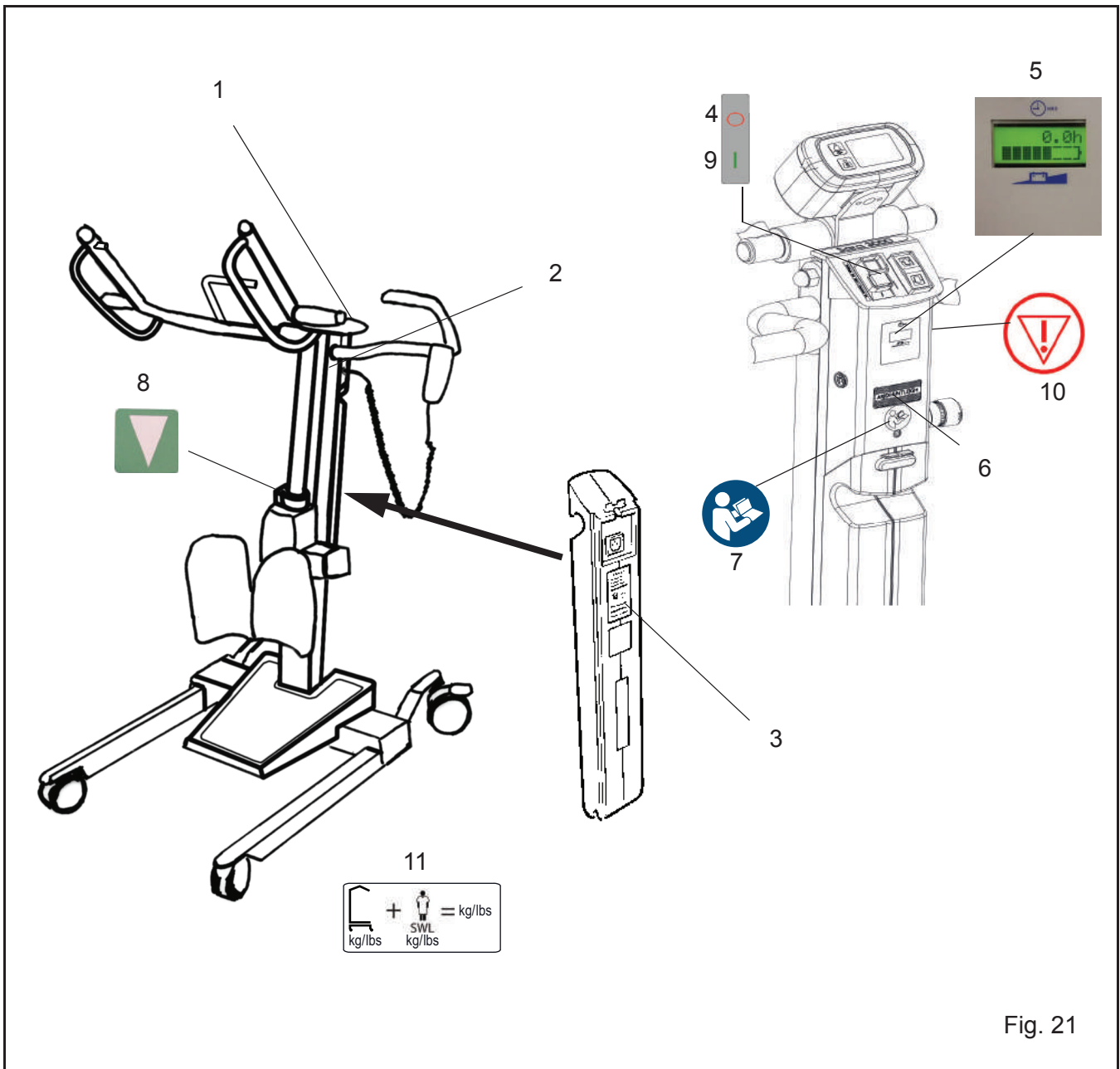







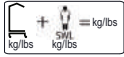



Fig. 21

1. Product Name
2. Safe Working Load - 200 kg (440 lbs) and serial number
3. Battery Information
4. Power off button identification
5. Battery Discharge Indicator and Hour/Cycle Meter
6. Arjo logo
7. Attention: Read Operating Instruction
8. System Failure Lowering Override Identification
9. Power on / Reset button identification
10. Emergency stop button
11. Maximum total weight of lift

# Labels

Symbol Explanation	
	Mandatory to read the Instructions for Use
	A battery is the power source of this equipment.
	Separate electrical and electronic components for recycling in accordance with the European Directive 2012/19/EU (WEEE)
	Recyclable
IP 24	Degree of protection (i.e. the product is protected against insertion of fingers and splashing water
	Type BF Applied part: protection against electrical shock in accordance with EN/IEC 60601-1.
	CE marking indicating conformity with European Community harmonised legislation Figures indicate Notified Body supervision.
	Indicates the product is a Medical Device according to EU Medical Device Regulation 2017/745
	Total mass of equipment including its safe working load.
	Name and address of the manufacturer
	Manufacturing date

# Technical Specification

---

## Component Weights

	kg	lbs
<i>Sara 3000</i> complete	62	137
<i>Sara 3000</i> complete with scale and battery	72	158
Maximum total weight of lift (lift + patient)	272	598

In normal use, the complete *Sara 3000* can be broken up into two parts:

<b>Battery Pack</b>	3.8	8.4
<i>Sara 3000</i> (without Battery Pack)	58.2	128
<i>Sara 3000</i> with Scale (without Battery Pack)	67.9	150

The *Sara 3000* is not intended to be broken up into more than these parts.

## Safe Working Load

<i>Sara 3000</i>	200	440
------------------	-----	-----

All slings - check the safe working load on the sling label

## Electrical

Battery Type	Rechargeable - sealed lead acid
Battery Part Number	NDA0100-20
Battery capacity	24 V 4 Ah
Lift - Protection Class - intrusion of liquid	IP24*
Lift - Protection Class - shock protection	Internally powered equipment
Lift nominal voltage	24 V
Fuse	6 A (Thermal overcurrent circuit breaker)
Fuse - PCBA	20 A
Fuse - battery	30 A
Battery Charger	NDA8200
Operating force of controls	< 5 N

Medical Equipment: type BF 

\*The symbol IP n<sub>1</sub>n<sub>2</sub> indicates the degree of ingress protection against solid particles (n<sub>1</sub>) and liquids (n<sub>2</sub>).  
2: Protection against solid particle ingress larger than 12.5 mm - fingers or similar objects.  
4: Protection against liquid ingress - water splashing against the enclosure from any direction shall have no harmful effect.

# Technical Specification

---

Conforms to IEC 60601-1:2012(ed.3.1), ANSI/AAMI ES60601-1:2005 / A2:2010, CAN/CSA-C22.2 No. 60601-1:08 and ISO 10535:2006.

	Duty cycle/Max volts/Max amps
Mast Lift Actuator	10% - (2 min/18min)/24 V/10,5 A
"V" Chassis Actuator	10% - (2 min/18min)/24 V/2,2 A
Mode of operation: intermittent	

## Environment

### Operating, transport and storage

Temperature	+10 °C to + 40 °C (+50 °F to +104 °F) Operation -20 °C to +70 °C (-4 °F to +158 °F) Transport -20 °C to +70 °C (-4 °F to 158 °F) Storage
Relative humidity range	30% to 75% Operation 10% to 80% including condensation Transport and Storage
Atmospheric pressure	800 hPa to 1060 hPa Operating 500 hPa to 1100 hPa Transport 500 hPa to 1100 hPa Storage

## Maximum sound power level

In accordance with ISO 3746 53 dB (dB re 1pW ± 3 dB)

## End of Life Disposal

- All batteries in the product must be recycled separately. Batteries are to be disposed in accordance with national or local regulations.
- Slings including stiffeners/stabilizers, padding material, any other textiles or polymers or plastic materials etc. should be sorted as combustible waste.
- Lift systems having electrical and electronic components or an electrical cord should be disassembled and recycled per Waste of Electrical and Electronic Equipment (WEEE) or in accordance with local or national regulation.
- Components that are primarily be made up of different kinds of metal (containing more than 90% metal by weight) for example sling bars, rails, upright supports, etc., should be recycled as metals.

# Technical Specification

## Sara 3000 Dimensions

A. Max. Height of C.S.P.	: 1715 mm : 67.5"	N. lifting Reach Min. Height C.S.P.	: 590 mm (N is also Max. lifting Reach) : 19.7"
B. Raising / Lifting Range	: 795 mm : 31.3"	O. lifting Reach Max. Height C.S.P.	: 10 mm : 0.4"
C. Min. Height of C.S.P.	: 920 mm : 36.2"	P. Turning circle	: 1035 mm : 40.7"
D. Height	: 1140 mm : 44.9"	Q. Minimal distance from wall to CSP with maximum high (legs spread)	: 810 mm : 31,9"
E. Chassis Min. Clearance	: 45 mm : 1.8"	R. Minimal distance from wall to CSP with maximum range (legs spread)	: 200 mm : 7.9"
F. Chassis Max. Height	: 110 mm : 4.3"	S. Minimal distance from wall to CSP with minimum high (legs spread)	: 210 mm : 8,3"
G. Chassis Total External Length	: 1040 mm : 40.9"	T. Reach from base with legs spread to	: 700 - 620 mm : 27,6" - 24,4"
H. Chassis Max. Internal Length	: 625 mm : 24.6"	U. Internal width at maximum reach	: 905 mm : 35,6"
I. Chassis Footplate/support Length	: 270 mm : 10.6"		
J. Chassis Min. Internal Width	: 540 mm : 21.3"		
K. Chassis Min. External Width	: 645 mm : 25.4"		
L. Chassis Max. Internal Width	: 805 mm : 44.9"		
M. Chassis Max. External Width	: 1010 mm : 1.8"		

'C.S.P.' stands for 'Central Suspension Point': a reference point on the *Sara 3000* used for measurements. As CSP on the *Sara 3000* we have used the clips attachment point closest to the resident at the start of the raising cycle.

Technical specifications may be revised and changed without prior notice.

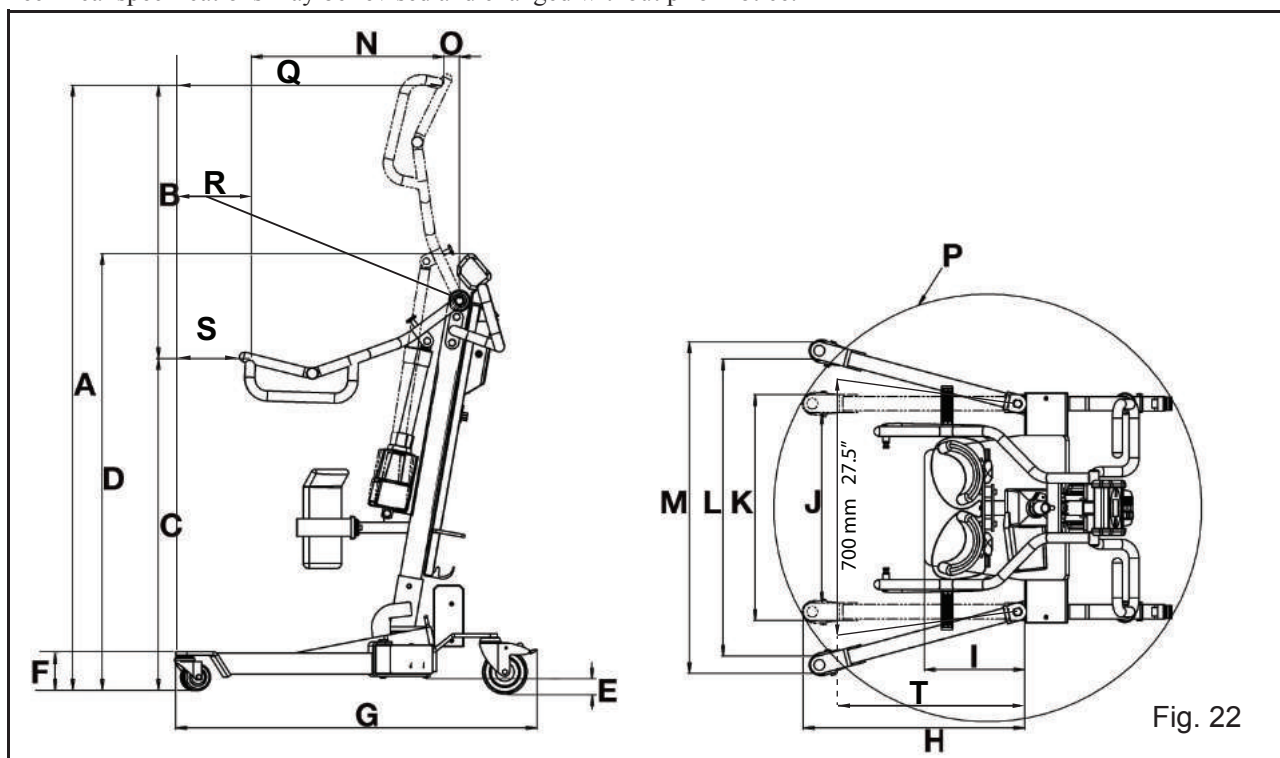



# Troubleshooting

Problem description	Possible cause	Resolution
The <i>Sara 3000</i> is (brand new and) not functioning	Power Off button (red) is still engaged	Press green Power On /reset button.
The <i>Sara 3000</i> is raising and lowering more slowly than normal.	Low battery power level.	Check the LCD battery segments and Hour/Cycle meter on the mast of the <i>Sara 3000</i> , just above the battery. This will indicate the power level of the battery. If in doubt, replace the battery on the <i>Sara 3000</i> with a fully charged one and compare performance. In case of low battery power level, charge the battery and use a fully charged one to continue using the <i>Sara 3000</i> .
The <i>Sara 3000</i> is not raising or lowering and / or the chassis legs cannot be opened or closed.	Hand control is damaged	Try operating the <i>Sara 3000</i> with the Dual Up/Down Control situated on the mast of the <i>Sara 3000</i> . Should the equipment function properly when these controls are used but does not function properly when using the hand control, replace the hand control.
The <i>Sara 3000</i> does not function correctly when using the hand control or the Dual Up/Down switches.	Electronics PCB fault Actuator on resident support arms or chassis malfunctioning	Contact your Arjo dealer or an approved Arjo service engineer.
While pressing the “Raise” button, the <i>Sara 3000</i> makes a noise “overload” displays on LCD and buzzer beeps continuously but the resident support arms do not move upwards.	An obstruction is blocking the resident support arms	Remove the obstruction and check thoroughly for damage before continuing the lifting cycle. If in doubt, use the System Failure Lowering Override to return the resident to a safe seated position before removing the hoist and withdrawing it from use. Only use the <i>Sara 3000</i> again after it has been inspected and approved for safe use by a qualified technician.
While pressing the “Chassis Legs Open” button, the <i>Sara 3000</i> makes a noise “overload” displays on LCD and buzzer beeps continuously but the chassis legs do not open.	An obstruction is blocking the chassis legs	Remove the obstruction and check thoroughly for damage before continuing the lifting cycle. If in doubt, use the System Failure Lowering Override to return the resident to a safe seated position before removing the hoist and withdrawing it from use. Only use the <i>Sara 3000</i> again after it has been inspected and approved for safe use by a qualified technician.
Unexpected movement of the hoist	Faulty hand control, push buttons or electronics.	If releasing the buttons does not work: Push the red Emergency Stop button and remove the battery from the hoist. Use the System Failure Lowering Override to put the patient back into a safe seated position before removing the hoist and withdrawing it from use. Only use the <i>Sara 3000</i> again after it has been inspected and approved for safe use by a qualified technician.
“OverHeat” displays on LCD and buzzer beeps twice every 15 seconds	Actuator duty cycle is exceeded (2 minutes).	Finish operation cycle and wait 18 minutes. This prevents from actuator damage.

# Electromagnetic Compatibility (EMC)

---

Product has been tested for compliance with current regulatory standards regarding its capacity to block EMI (electromagnetic interference) from external sources.

Some procedures can help reduce electromagnetic interferences:

- Use only Arjo cables and spare parts to avoid increased emissions or decreased immunity which can compromise the correct functioning of the equipment.
- Ensure that other devices in patient-monitoring and/or life-support areas comply to accepted emissions standards.

## **WARNING**

**Wireless communications equipment such as wireless computer network devices, mobile phones, cordless telephones and their base stations, walkie-talkies, etc. can affect this equipment and should be kept at least 1.5 m away from the equipment.**

Intended Environment: Home Healthcare Environment and Professional Healthcare facility environment

Exceptions: HF Surgical Equipment and the RF Shielded room of an ME SYSTEM for magnetic resonance imaging

## **WARNING**

**Use of this equipment adjacent to or stacked with other equipment should be avoided because it could result in improper operation. If such use is necessary, this equipment and the other equipment should be observed to verify that they are operating normally.**

## **Guidance and manufacturer's declaration – electromagnetic emission**

<b>Emission test</b>	<b>Compliance</b>	<b>Guidance</b>
RF emissions CISPR 11	Group 1	This equipment uses RF energy only for its internal functions. Therefore its RF emissions are very low and are not likely to cause any interference in nearby electronic equipment.
RF emissions CISPR 11	Class B	This equipment is suitable for use in all establishments, including domestic establishments and those directly connected to the public low voltage power supply network that supplies buildings used for domestic purposes.

<b>Guidance and manufacturer's declaration – electromagnetic immunity</b>			
<b>Immunity test</b>	<b>IEC 60601-1-2 test level</b>	<b>Compliance level</b>	<b>Electromagnetic environment – guidance</b>
Electrostatic discharge (ESD)  EN 61000-4-2	±2kV, ±4kV, ±8kV, ±15kV air  ±8kV contact	±2kV, ±4kV, ±8kV, ±15kV air  ±8kV contact	Floors should be wood, concrete or ceramic tile. If floors are covered with synthetic material, the relative humidity should be at least 30%.
Conducted disturbances induced by RF fields  EN 61000-4-6	3V in 0,15 MHz to 80 MHz  6V in ISM and amateur radio bands between 0,15 MHz and 80 MHz  80% AM at 1 kHz	3V in 0,15 MHz to 80 MHz  6V in ISM and amateur radio bands between 0,15 MHz and 80 MHz  80% AM at 1 kHz	Portable and mobile RF communications equipment should be used no closer to any part of the product, including cables, than 1.0m, if the transmitter's output power rating exceeds 1W <sup>a</sup> . Field strengths from fixed RF transmitters, as determined by an electromagnetic site survey, should be less than the compliance level in each frequency range <sup>b</sup> .  Interference may occur in the vicinity of equipment marked with this symbol:  
Radiated RF electromagnetic field  EN 61000-4-3	Home Healthcare environment 10 V/m  80 MHz to 2,7 GHz 80% AM at 1 kHz	Home Healthcare environment 10 V/m  80 MHz to 2,7 GHz 80% AM at 1 kHz	
Proximity fields from RF wireless communications equipment  EN 61000-4-3	385 MHz - 27 V/m  450 MHz - 28 V/m 710, 745, 780 MHz - 9V/m 810, 870, 930 MHz - 28 V/m 1720, 1845, 1970, 2450 MHz – 28 V/m 5240,5500, 5785 MHz - 9V/m	385 MHz - 27 V/m  450 MHz - 28 V/m 710, 745, 780 MHz - 9V/m 810, 870, 930 MHz - 28 V/m 1720, 1845, 1970, 2450 MHz – 28 V/m 5240,5500, 5785 MHz - 9V/m	
Electrical fast transient/burst EN 61000-4-4	±1kV SIP/SOP ports  100 kHz repetition frequency	±1kV SIP/SOP ports  100 kHz repetition frequency	
Power frequency Magnetic field  EN 61000-4-8	30 A/m  50 Hz or 60 Hz	30 A/m  50 Hz	Power frequency magnetic fields should be at levels characteristic of a typical location in a typical commercial or hospital environment.
<p><sup>a</sup> Field strengths from fixed transmitters, such as base stations for radio (cellular/cordless) telephones and land mobile radios, amateur radio, AM and FM radio broadcast and TV broadcast cannot be predicted theoretically with accuracy. To assess the electromagnetic environment due to fixed RF transmitters, an electromagnetic site survey should be considered. If the measured field strength in the location in which the product is used exceeds the applicable RF compliance level above, the product should be observed to verify normal operation. If abnormal performance is observed, additional measures may be necessary.</p> <p><sup>b</sup> Over the frequency range 150 kHz to 80 MHz, field strengths should be less than 1 V/m.</p>			