

INSTRUCTIONS FOR USE

# Maxi 500



To avoid injury, always read this *Instructions for Use* and accompanied documents before using the product.



**Mandatory to read the *Instructions for Use*.**

#### Design Policy and Copyright

® and ™ are trademarks belonging to the Arjo group of companies.  
© Arjo 2019.

As our policy is one of continuous improvement, we reserve the right to modify designs without prior notice. The content of this publication may not be copied either whole or in part without the consent of Arjo.

# Table of Contents

<b>Foreword</b> .....	<b>1</b>
Please Read this Manual Thoroughly! .....	1
Service and Support .....	1
Manufacturer Information .....	1
Definitions Used in this Manual .....	1
<b>Safety Instructions</b> .....	<b>2</b>
Intended Use .....	2
Operational Life .....	2
Important Safety Instructions .....	2
Policy on Number of Staff Members Required for Patient Transfer .....	3
Safe Working Load (SWL) .....	3
Battery and Battery Charger Safety Practices .....	4
Shock Prevention .....	4
Fire and Explosion Prevention .....	4
Human and Environmental Safety Practices .....	4
<i>Homecare Environment Considerations</i> .....	4
<b>Symbols Used</b> .....	<b>5</b>
General Symbols .....	5
Charger Related .....	5
<b>Product Description</b> .....	<b>6</b>
<b>How to use the <i>Maxi 500</i></b> .....	<b>7</b>
Adjusting Legs Spreading .....	7
Brakes .....	7
Emergency Stop .....	7
Boom Control .....	7
<i>To Raise the Patient</i> .....	7
<i>To Lower the Patient</i> .....	7
Moving the <b><i>Maxi 500</i></b> .....	<b>8</b>
Emergency Lowering .....	8
Automatic Cut-out .....	8
<i>During lifting</i> .....	8
<i>During lowering</i> .....	8
Hour Meter .....	8
Battery Charge Indicator .....	9
Battery Charging .....	9
Inserting/Removing the Battery Pack .....	9
Scale (optional) .....	9
<b>Clip Slings Application</b> .....	<b>10</b>
Clip Sling Compatibility .....	10
Sling Selection .....	11
Spreader Bar Compatibility .....	11
Attaching the Sling to the DPS .....	12
Detaching the Sling from the DPS .....	12
Operating the DPS .....	12
Transferring Patients Using Clip Slings .....	13
<i>Lifting Patient from a Seated Position</i> .....	13
<i>Lowering Patient to a Seated Position</i> .....	13
<i>Lifting Patient from a Bed</i> .....	14
<i>Lowering Patient to a Bed</i> .....	14
<i>Lifting Patient from the Floor</i> .....	15
<i>Lowering Patient to the Floor</i> .....	15

<b>Loop Slings Application .....</b>	<b>16</b>
Compatible Loop Slings.....	16
Sling Selection.....	17
Spreader Bar Compatibility.....	17
Attaching the Sling to the Spreader Bar .....	17
<i>Positioning the Patient</i> .....	17
<i>Attachment Methods</i> .....	18
Transferring Patients Using Loop Slings .....	19
<i>Lifting Patient from a Seated Position</i> .....	19
<i>Lowering Patient to a Seated Position</i> .....	19
<i>Lifting Patient from a Bed</i> .....	20
<i>Lowering Patient to a Bed</i> .....	20
<i>Lifting Patient from the Floor</i> .....	21
<i>Lowering Patient to the Floor</i> .....	21
<b>Care and Maintenance .....</b>	<b>22</b>
Lift Cleaning and Care .....	22
<b>Preventive Maintenance Schedule.....</b>	<b>23</b>
<b>Troubleshooting .....</b>	<b>25</b>
<b>Labels on the Lift.....</b>	<b>26</b>
<b>Technical Specifications.....</b>	<b>27</b>
<i>Dimensions</i> .....	28
<b>Electromagnetic Compatibility.....</b>	<b>29</b>
Electromagnetic Compliance .....	29
Electromagnetic Emissions.....	29
Electromagnetic Immunity .....	30

## Please Read this Manual Thoroughly!

The information in this manual is crucial to the proper use and maintenance of the *Maxi 500* floor lift. It will help protect your product as well as ensure that it performs to your satisfaction.

Lifting and transferring a person always presents a potential risk. This manual contains safety related information that must be read and understood to help prevent injuries.

Arjo strongly advises and warns that to avoid injuries that can be attributed to the use of inadequate parts, only parts designated by Arjo should be used on product and other appliances supplied by Arjo.

Unauthorized modifications on any Arjo product may affect its safety. Arjo will not be held responsible for any accidents, incidents or lack of performance that occur as a result of any unauthorized modification to its products.

If a serious incident occurs in relation to this medical device, affecting the user, or the patient then the user or patient should report the serious incident to the medical device manufacturer or the distributor. In the European Union, the user should also report the serious incident to the Competent Authority in the member state where they are located.

## Service and Support

A service routine has to be done on your *Maxi 500* floor lift by Arjo trained service personnel. This will ensure it remains safe and functional.

Please contact your local Arjo vendor for any of the following:

- If you require further information.
- Want to report an unexpected event, change in the performance or a malfunction.
- Need any help in setting up, using or maintaining your *Maxi 500*.

- Need replacement parts.

Your Arjo vendor can offer support and service programs to maximize the long-term safety, reliability and value of the product.

## Manufacturer Information

This product was manufactured by:

ArjoHuntleigh AB  
Hans Michelsensgatan 10  
211 20 Malmö,  
SWEDEN

☎: +46 (0) 10-335 45 00

📠: +46 (0) 413-138 76

🌐: [www.arjo.com](http://www.arjo.com)

## Definitions Used in this Manual

### WARNING:

Means: Failure to understand and follow this instruction may result in injury to yourself and others.

### CAUTION:

Means: Failure to follow this instruction may cause damage to the product(s).

### NOTE:

Means: Important information regarding correct use of the product.

# Safety Instructions

The *Maxi 500* floor lift must always be handled by a trained caregiver, as per instructions herein, who shall attend to the patient during lift operation.

## Intended Use

The *Maxi 500* floor lift has been designed to assist caregivers in hospitals, long-term care, nursing homes and home care environments, including private homes. It is intended for lifting patients with reduced mobility for the following purposes:

- Transferring to or from adjacent location, such as chair, wheelchair, bed, bath, toilet, floor or stretcher.
- Assisting patient with tasks such as, toileting.

**WARNING:** This product is not intended to be operated by the patient.

Patient could get stuck in many circumstances.

**WARNING:** The *Maxi 500* floor lift must be solely used for the purposes stated above.

Do not use the lift for any other purpose, it could compromise product's reliability and/or patient's safety.

## Operational Life

The *Maxi 500* floor lift has been designed and tested to achieve up to 10 000 cycles with a load of 227 kg (500 lb).

It is subject to maintenance as specified in the "Care and Maintenance" section in this manual.

The following table shows number of years in relation to cycles per day. One cycle is defined as transferring a 227 kg (500 lb) patient including a raising action, a lateral displacement and a descending action.

Cycles per Day	Years (10,000 transfers)
4	7
6	4.5
8	3.5

**WARNING:** Using a floor lift or an accessory beyond its life span may result in an incident causing serious injuries.

Following are factors that have an impact on the lift's life span:

- aging of the unit;
- transfers per day;
- weight of the patient;
- maintenance frequency.

The expected life for other consumable items, such as batteries, fuses, slings, straps and cords is dependent upon the care and usage of the product. Consumable must be maintained in accordance with published *Instructions for Use* and "Preventive Maintenance Schedule".

## Important Safety Instructions

- Before using the *Maxi 500*, a clinical assessment of the patient's suitability for transfer must be carried out by a qualified health professional considering that, among other things, the transfer may induce substantial pressure on the patient's body.
- Keep this manual at proximity from the lift and refer to it as required. Make sure that all users are regularly trained in the use of the *Maxi 500* floor lift as per the information found therein.
- All controls and safety features are used only as per the rules specified in this manual. Never attempt to force a control or button on the lift.

**WARNING:** Do not put fingers, hands or feet where space is limited (see "Fig. 1"). This could pinch, cut, or seriously harm body parts.

- Avoid any impact during transfer.

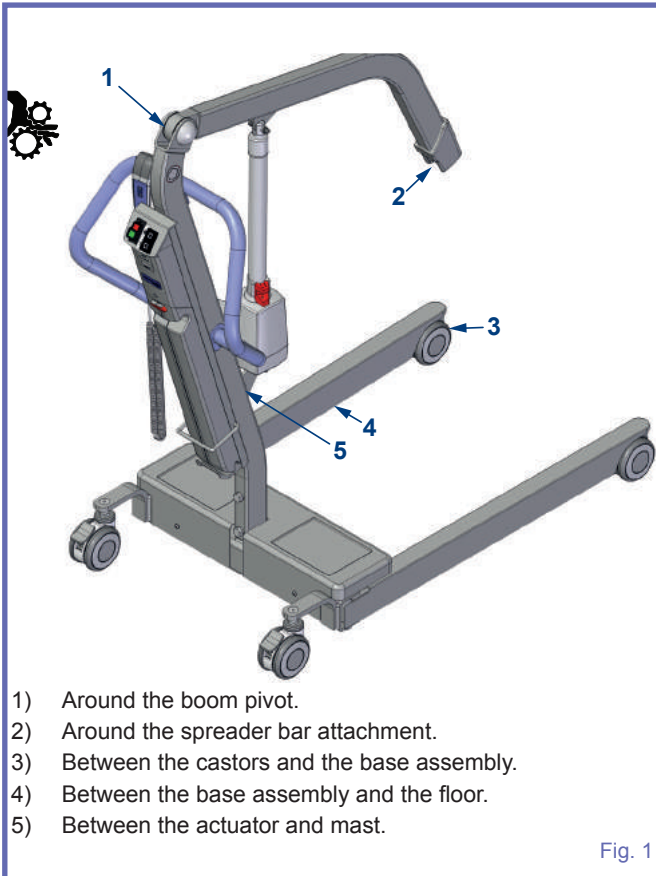

- 1) Around the boom pivot.
- 2) Around the spreader bar attachment.
- 3) Between the castors and the base assembly.
- 4) Between the base assembly and the floor.
- 5) Between the actuator and mast.

Fig. 1

**WARNING:** Arjo warns of possible strangulation risks related to the hand control cable.

**WARNING:** Some plastic parts hiding screw heads on the lift may represent a choking hazard for young children. Make sure to replace them if they become loose or damaged.

**CAUTION:** Do not drop either the lift or the battery pack, as it may cause internal damage that is not easily seen. If the lift is suspected to be damaged, contact your local Arjo vendor for servicing.

**CAUTION:** Using the *Maxi 500* in humid, salty, or chlorinated conditions may cause premature wear of the lift.

In such cases, we recommend to perform a proactive maintenance program with more frequent inspections.

## Policy on Number of Staff Members Required for Patient Transfer

Arjo's floor lifts are designed for safe usage with one caregiver. There are circumstances that may dictate the need for a two-person transfer. It is the responsibility of the caregiver to determine if a one or two person transfer is more appropriate, based on the following:

- resident's condition (combativeness; obesity, contracture etc.);
- the task;
- resident's weight;
- environment;
- capability;
- skill level of the caregiver.

Do not hesitate to contact your medical professional for guidance.

## Safe Working Load (SWL)

The *Maxi 500* floor lift has been made for a maximum lifting capacity of 227 kg (500 lb) .

Do not attempt to lift more than the lowest weight limit indicated on the following:

- the "maximum load" label on the lift;
- on the spreader bar;
- on the accessories;
- on the sling.



## Battery and Battery Charger Safety Practices

**WARNING:** Following the instructions is important for the safe use of the battery and to keep the user (resident/caregiver) from harm.

Make sure the battery belongs to the device by comparing the battery label with the “Technical Specifications” section on page 27. If battery type cannot be confirmed, call your vendor for assistance.

**CAUTION:** Do not expose the battery connectors or the battery charger to water. Humid air or water can cause premature wear to the battery or the charger.

Refer to the Wall Mounted Battery Charger - Instructions for Use #001-24257-XX.

### Shock Prevention

- Electrically live equipment can result in serious injuries. If the lift or charger has any exposed or damaged wires, contact your local Arjo vendor immediately.
- Do not attempt to expose, service or repair the lift, battery or charger. If any unit is malfunctioning, contact your local Arjo vendor.

### Fire and Explosion Prevention

- Do not place or store the battery under direct sunlight or near a heat source.
- Do not expose the batteries or battery charger to flames.
- Do not use the charger in the presence of flammable anaesthetic gases.
- Do not short circuit the battery terminals.

## Human and Environmental Safety Practices

- Should the battery casing crack, allowing its contents to come into contact with skin or clothing, rinse immediately with water. If the contents comes in contact with the eyes, rinse immediately with plenty of water and seek medical attention.
- Inhalation of the contents can cause respiratory irritation. Seek out fresh air and medical attention.
- For recycling and disposal of the batteries, the rules according to the WEEE directive (Waste of Electronic and Electrical Equipment) as well as local laws and regulations must be

followed. When returning batteries, insulate their terminals with adhesive tape. Otherwise, the residual electricity in used batteries may cause fire or explosion.

In case of doubt about the way to proceed, please contact your local authorities to determine the proper method of disposal.

### Homecare Environment Considerations











**WARNING:** The *Maxi 500* is not intended to be operated by children. Serious injuries could occur.







**NOTE:** Cleaning actions should be done rigorously when the *Maxi 500* is exposed to an animal.

Pet hair trapped around mobile parts can affect lift's performance.

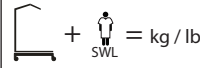

## General Symbols

	This symbol points out the manufacturer's name and address. May also point out manufacturing date.
	CE marking indicating conformity with European Community harmonised legislation.
	This symbol means that the product is certified according to NTRL through TÜV SÜD.
	This symbol means that the product is certified through TÜV SÜD.
	This symbol points out the manufacturer's catalogue number.
	This symbol points out the manufacturer's serial number.
	Waste Electrical and Electronic Equipment (WEEE) – do not dispose of this product in general household or commercial waste.
	This symbol means that the item can be recycled.
	This symbol means that you must refer to the Instructions for Use (IFU).
	This symbol points out a Type BF applied part.
	This symbol points out a Type B applied part.

	This symbols points out a risk of pinching.
<b>SWL</b>	SWL is the maximum load the device is rated for safe usage.
	This symbol points out the emergency stop device.
	This symbol points out the reset switch.
	Correct.
	Incorrect.
	Maximum total mass of equipment including its safe working load.
	Indicates the product is a Medical Device according to the EU Medical Device Regulation 2017/745.

## Charger Related

Refer to the Wall Mounted Battery Charger - Instructions for Use #001-24257-XX.

When applicable, symbol reference can be found in EN 60601-1 and WEEE Directive.

## Acronyms

DPS	Dynamic Positioning System
-----	----------------------------

# Product Description

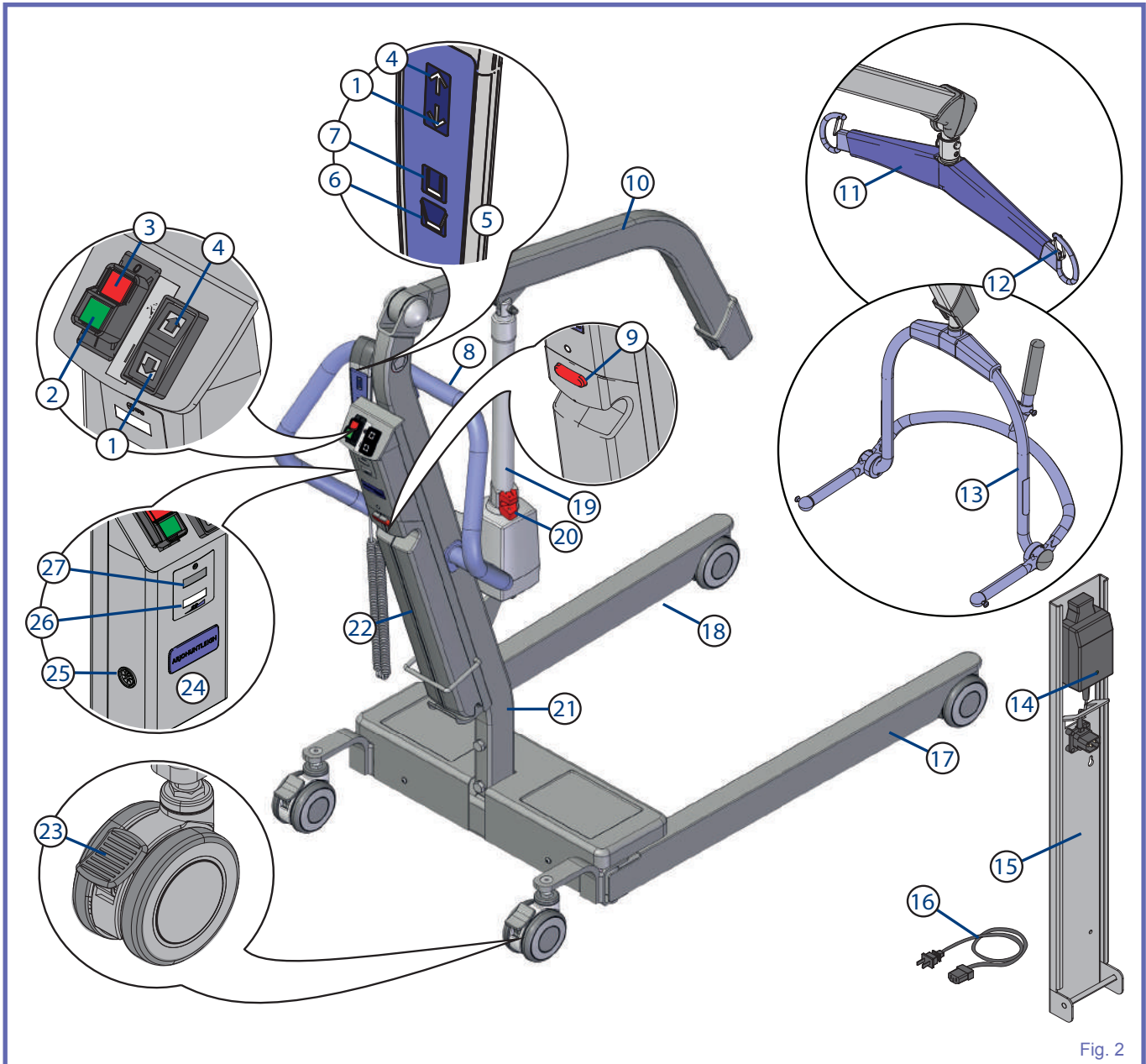

Fig. 2

## Legend

- |                           |                               |
|---------------------------|-------------------------------|
| 1) Down Button            | 14) Charger Status LED        |
| 2) Reset Button           | 15) Wall-Mounted Charger      |
| 3) Emergency Stop Button  | 16) Charger Power Cord        |
| 4) Up Button              | 17) Right Leg                 |
| 5) Hand Control           | 18) Left Leg                  |
| 6) Leg Opening Button     | 19) Actuator                  |
| 7) Leg Closing Button     | 20) Emergency Lowering Handle |
| 8) Handle                 | 21) Mast                      |
| 9) Battery Release Button | 22) Battery Pack              |
| 10) Boom                  | 23) Castor Break              |
| 11) 2-Point Spreader Bar  | 24) Control Box               |
| 12) Safety Latch          | 25) Hand Control Connector    |
| 13) DPS Spreader Bar      | 26) Battery Status Display    |
|                           | 27) Hour Meter                |

# How to use the *Maxi 500*

## Adjusting Legs Spreading

The legs' opening width can be adjusted by using the two bottom buttons on the hand control.

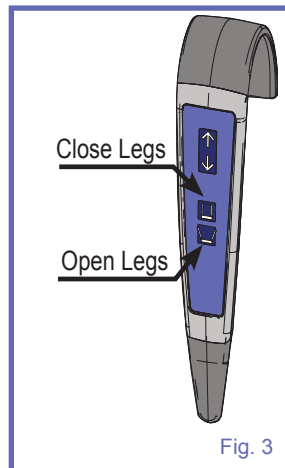

## Brakes

Foot operated brakes are fitted on both rear castors.

**To apply brakes**, step on the back portion of pad.

**To release brakes**, push the top portion of the pad forward.

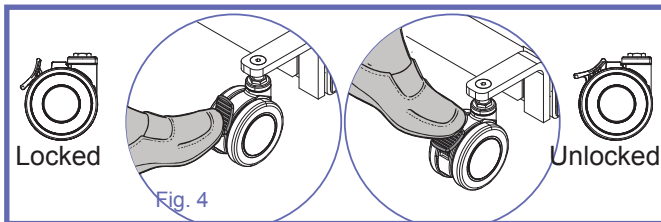

## Emergency Stop

The operator can shut off the power at any time by pressing the red emergency button on the control panel or by pressing the red button on the battery while pulling it backward to remove it.

Reset the emergency stop function by pressing on the green power button or by replacing the battery.

First-time users should practice the emergency stop manoeuvre before operating the lift with a patient in it.

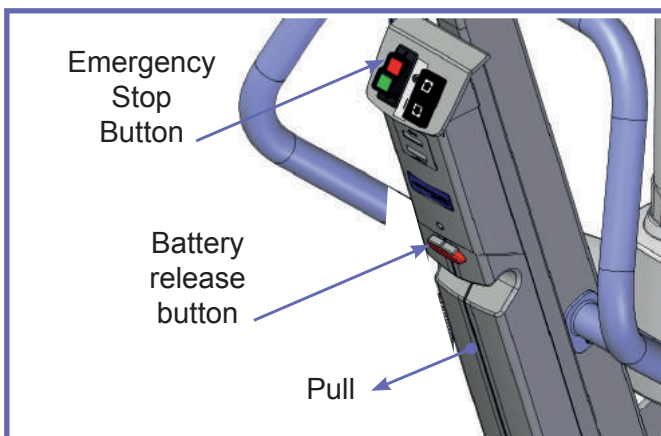

## Boom Control

The electrical actuator can be operated in both directions. It allows the operator to raise or lower the patient without any physical effort. The boom raising/lowering action is controlled by the "Up"/"Down" buttons located on the control box and on the hand control.

If two buttons are pressed simultaneously, the first function button pressed overrides the other function until it is released.

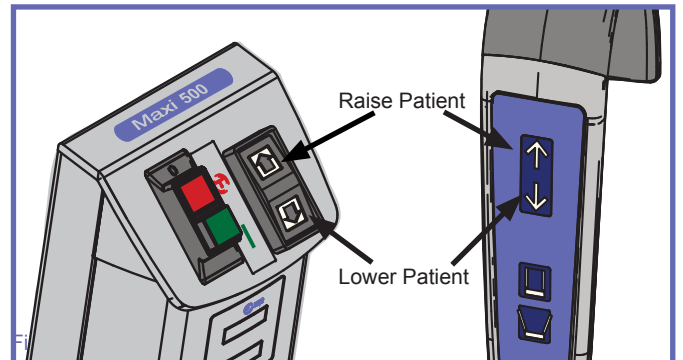

## To Raise the Patient

**WARNING:** Always make sure that the spreader bar is above the patient before lifting.

Failure to follow this instruction may cause the patient to swing resulting in injury.

The "UP" buttons are used to raise the boom. The boom keeps rising as long as the button is pressed or until it reaches its upper travel limit.

## To Lower the Patient

The "Down" buttons are used to lower the boom. The boom keeps lowering as long as the button is pressed or until it reaches its lower travel limit.

## Moving the Maxi 500

Always use the handles to manoeuvre the lift.

Close the legs and move the lift in the direction of travel as shown in the figure below.

If necessary, initiate the movement by pushing on the back of the base with your foot. Do not push on the legs.

**WARNING:** Never attempt to manoeuvre the lift by pulling on the mast, boom, actuator or patient. Doing so could cause incidents resulting in injuries.

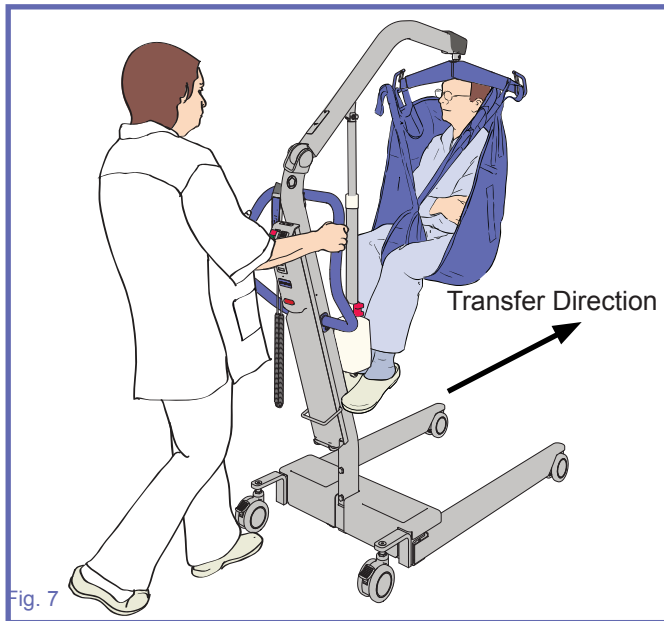

Never attempt to push or pull a loaded lift over a floor obstruction which the castors are unable to ride over easily, including steps, door thresholds or moving sidewalk.

Do not push the lift at a speed which exceeds a slow walking pace (3 km/hour or 0.8 meter/second).

## Emergency Lowering

This feature allows the boom to be lowered in the event of a main control failure.

In the event of a hand control or control box failure, locate the red handle above the actuator.

Gradually pull the handle up and hold it until the actuator is lowered to the desired level. The force exerted on the handle and the patient weight affects the speed of descent.

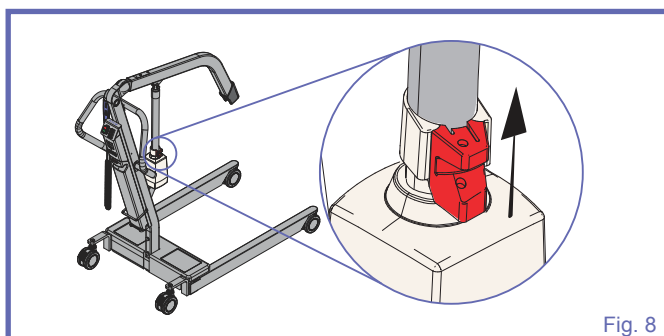

**WARNING:** Before operating the “emergency lowering”, always ensure that a suitable support is underneath, ready to receive, the patient.

The handle is spring loaded and will return to normal position and stop the lowering process when released. Note that a load must be applied to the boom for the device to function.

**CAUTION:** This function should only be used in the event of control failure, and not as a regular lowering function for the equipment.

## Automatic Cut-out

### During lifting

This feature will stop the lifting motion in the event where the Maxi 500 is trying to raise a patient heavier than the SWL.

### During lowering

This feature disables the down motion when the boom is being lowered onto the patient or any other obstruction.

## Sleep Mode

The control box includes an automatic switch-off control that disables part of the circuitry, after 2 minutes of inactivity, to prevent battery from draining.

Power is re-established when a control button is pressed.

## Hour Meter

The hour meter is an LCD display which shows the total duration of powered operation (in hours).

This is primarily intended as an aid for scheduling maintenances.





## Battery Charge Indicator

The battery charge indicator is a bar graph display, located on the battery pack holder, which shows the charge condition of the battery.

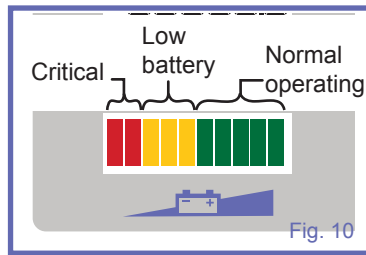

The lift is equipped with an audible warning device, which will beep when the battery level reaches the critical range.

**CAUTION:** When the indicator reaches the critical range, recharge the battery immediately to prevent reducing its lifespan.

When a fully charged battery is inserted into the lift, the display will return to the green fully charged position, regardless of the level the indicator had reached previously. However, if a partially charged battery is inserted, the previous indicator level will be maintained, even though the recently inserted battery may be in a better state of charge than indicated. To achieve a true indication of battery condition, a fully charged battery must be inserted into the lift.

## Battery Information

For safe handling and to extend the battery lifetime, please follow and remember these instructions.

The *Maxi 500* uses a 24 volts sealed lead-acid battery pack that can deliver up to 100 lifts per charge.

Battery life is variable (2-3 years) and is influenced by: frequency of use, frequency of charging, temperature of operation/storage and storage time.

To prolong the battery pack life, recharge it before the indicator reaches the Low Battery range.

To ensure that the *Maxi 500* is always ready for use, it is recommended that a fully charged battery pack always be available. Do this by having additional battery packs, and keeping one battery pack charging while the other is in use.

Remove the battery pack from the lift when storing for an extended period of time. Stored batteries should be recharged at least every two weeks to maximize their life span.

## Battery Charging

The battery should be recharged as soon as the discharge indicator displays amber.

Refer to the Wall Mounted Battery Charger - Instructions for Use #001-24257-XX for charging details.

Note that the battery pack may remain connected to the charger when fully charged.

## Inserting/Removing the Battery Pack

The same method applies for inserting/removing the battery pack into/from the lift or the charger.

### Inserting the Battery Pack

- 1) Align the bottom of the battery pack with the bottom of the battery support.
- 2) Insert the battery pack until it rests into the support base.
- 3) Push the top of the battery until it latches to the support.

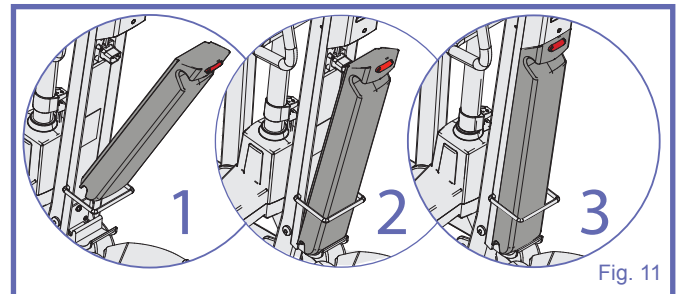

### Removing the Battery Pack

- 1) Push the release button.
- 2) Pull the battery back.
- 3) Lift the battery to pull it out of the battery rack.

## Scale (optional)

To use the scale, if available, refer to the *Scale IFU*.

# Clip Slings Application

## Clip Sling Compatibility

This section only applies for model supplied with the DPS spreader bar.

Following is a list of typical Arjo clip slings that are compatible with the *Maxi 500* floor lift.

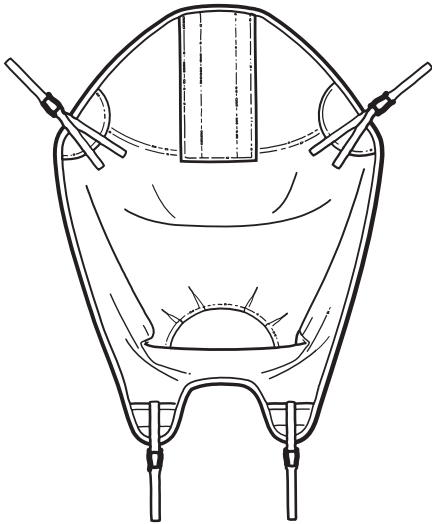

MAA2090-XX  
Four-Point Amputee

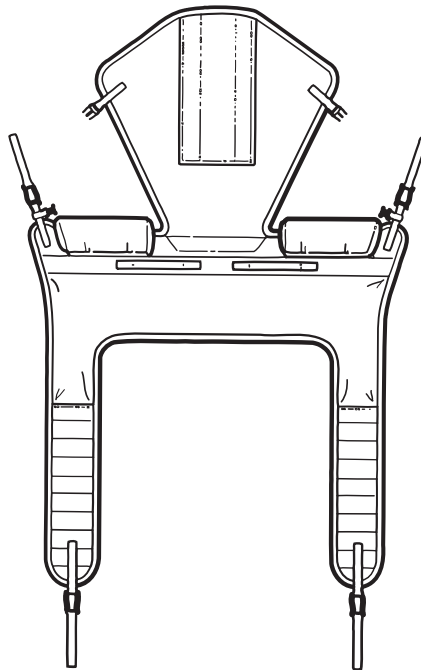

MAA4031-XX  
Four-Point Hygienic

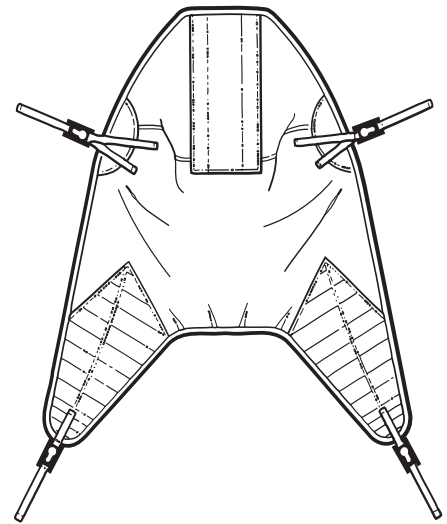

MAA4000-XX  
Four-Pointed Padded

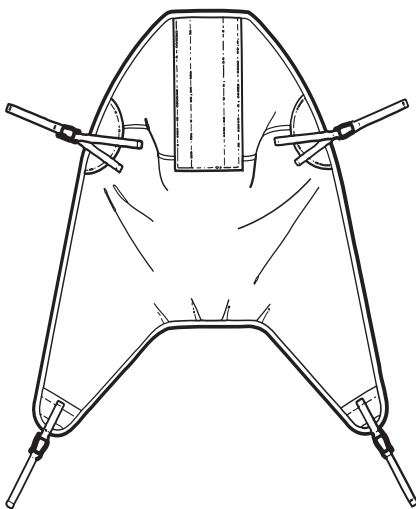

MAA-2000-XX  
Four Point Non-padded

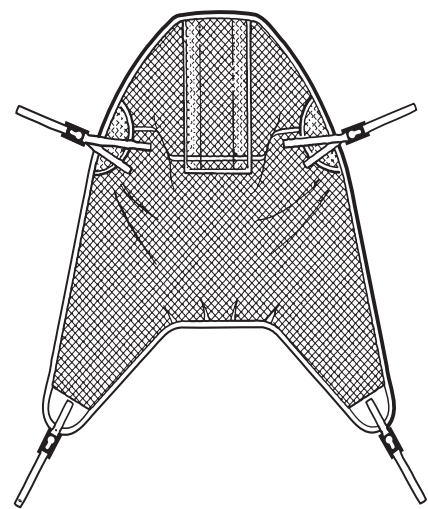

MAA4060-XX  
Four-Pointed Mesh

**NOTE:** Other sling models are available. Contact your Arjo vendor for more information about clip slings and how to use them.

## Sling Selection

The spreader bar that is attached to the lift determines what slings can be used to transfer a patient.

Slings are colour coded for size by having a different colour edge binding or attachment strap colouring:

- Teal - Extra Extra Small - XXS
- Brown - Extra Small - XS
- Red - Small - S
- Yellow - Medium - M
- Green - Large - L
- Purple - Large Large - LL
- Blue - Extra Large - XL
- Terracotta - Extra Extra Large - XXL

Note that some sling models are not available in all sizes.

A wide variety of slings are available for each application. Please contact your local Arjo vendor for more information.

Flites® (single patient multi-use slings) are also available for most sling models. If Arjo *Flites* slings are to be used with the *MAXI 500* floor lift, refer to the separate Arjo *Flites* slings *Instruction for Use*.

## Spreader Bar Compatibility

The *Maxi 500* floor lift is only compatible with the spreader bar that is delivered with the lift.

*Maxi 500* floor lift model that is designed for use with clip slings is delivered with a manual DPS spreader bar.

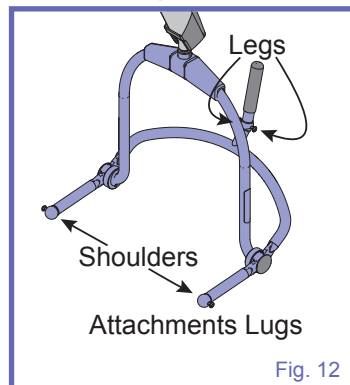

**WARNING:** Using the DPS with amputee sling may cause injuries if not used correctly.



## Attaching the Sling to the DPS

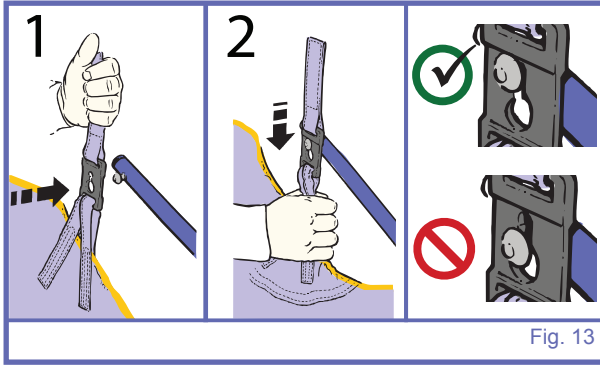

Insert the clip attachment over the lug on the DPS.  
Secure the clip in place by pulling the sling down so that the lug is in the top portion of the clip hole.

**WARNING:** Make sure all clips are correctly engaged. Failure to do so could result in patient fall.

### Method 1 - Straight Attachment

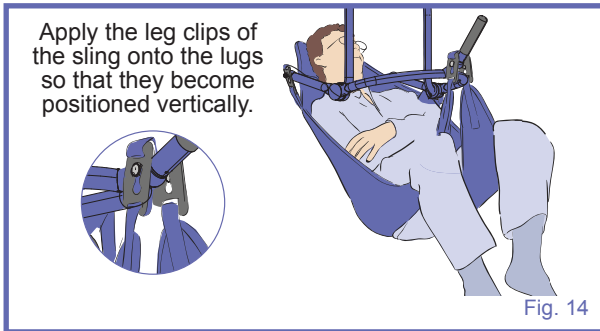

For most patients, the straight attachment of the leg clips is recommended.

### Method 2 - Crossed Legs Attachment

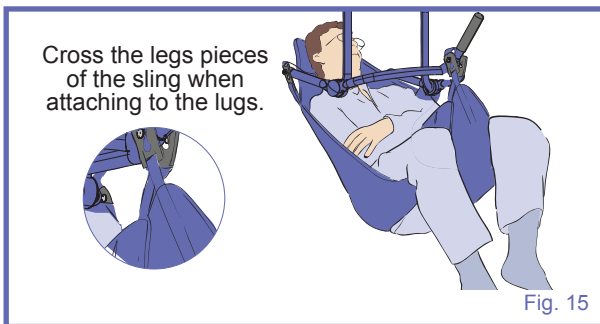

If the patient is prone to kicking off the leg clip, the crossed attachment of the leg clips shall be applied, which will prohibit the clip from being kicked off.

## Detaching the Sling from the DPS

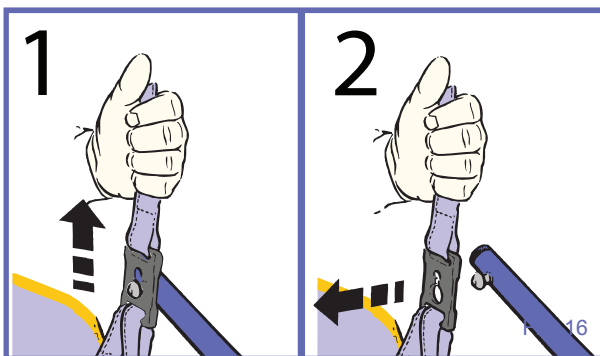

Pull the sling up to release the lock.

Remove the clip attachment from the lug on the DPS.

## Operating the DPS

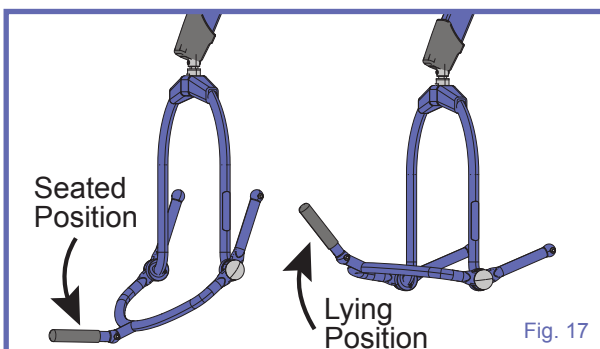

**Note:** To ensure maximum patient comfort, do not allow them to hold onto the spreader bar.

The DPS spreader bar is adjusted by rising or lowering the tilt handle until the patient is in the desired position.

## Transferring Patients Using Clip Slings

Before using the *Maxi 500* ensure that:

- A clinical assessment of the patient's suitability for transfer is carried out by a qualified health professional considering that, among other things, the transfer may induce substantial pressure on the patient's body.
- Special consideration is taken when transferring a patient who is connected to electrodes, catheters, or other medical devices.
- Always carry out the items marked as "Before every use" in the "Preventive Maintenance Schedule" before using the lift.

**WARNING:** Always hold the spreader bar when near a patient. The spreader bar could hit the patient resulting in injury.

**WARNING:** To avoid injury or discomfort, do not lower the spreader bar onto the patient.

**WARNING:** Before raising the patient, always make sure the sling is not caught on any obstructions (for instance, the wheelchair brakes or armrests). Sling catching in such obstructions could result in patient fall.

**WARNING:** Always confirm that the sling clips remain attached as the weight of the patient is gradually taken up. A wrongly clipped attachment could detach resulting in patient fall.

### Lifting Patient from a Seated Position

- 1) Place the sling around the patient so that the base of the sling sits slightly below the tail bone. A *MaxiSlide*® or *MaxiTube*® positioning aid can be used to assist with placement of the sling.



Fig. 18

- 2) Ensure that the head support area of the sling is behind the head covering it.

- 3) Pull each leg strap under the thigh so that it emerges on the inside of the thigh.

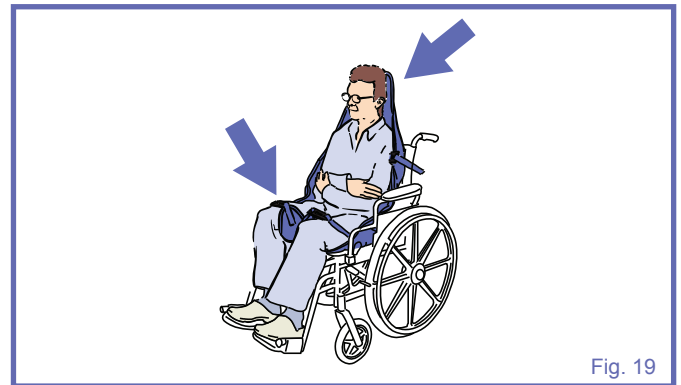

Fig. 19

- 4) Approach the patient with the lift, ensure that:
  - The spreader bar is in sitting position.
  - The wide part of the spreader bar is at or just below shoulder level.
  - The spreader bar is close enough to be able to connect the shoulder strap clips of the sling to the frame.
- 5) Connect the shoulder strap clips, then tilt the frame and attach the leg sections. If necessary, lower the spreader bar a little further, being careful not to lower it onto the patient.



Fig. 20

- 6) Raise the patient using the hand control, positioning him comfortably to a semi-reclined position for the transfer. The patient should not be lifted above the caregiver's eye level.
- 7) Turn the patient to face the caregiver, and keep at a normal chair height.
- 8) Proceed with the transfer.

### Lowering Patient to a Seated Position

- 1) Once the patient has arrived at destination, reposition the patient according to the destination position.
- 2) Lower the patient down onto the new location by making small adjustments during the descent.
- 3) When the patient's body weight is fully supported, detach the connections clips.
- 4) Move the lift away from the patient.
- 5) Remove the sling from under the patient.

## Lifting Patient from a Bed

Before you start, make sure the bed is in correct working height.

**WARNING:** Make sure that the bed safety side is installed to prevent the patient from falling.

- 1) Roll the patient onto their side.
- 2) Fold the sling in half and place on the bed marking it, along the back of the patient so that the base of his spine is aligned with the base of the sling, making sure the sling extends to the top of the patient's head.



- 3) Roll the patient back onto the sling and then slightly further in the opposite direction, so that the folded part of the sling can be unfolded.



- 4) If possible, slightly raise the head of the bed.
- 5) Approach the patient with the lift, and ensure that:
  - the spreader bar is in reclined position;
  - the spreader bar is close enough to be able to connect the shoulder strap clips of the sling to the frame.

- 6) Using the hand control, lower the spreader bar taking care not to lower the frame onto the patient.
- 7) Connect the sling shoulder and leg strap clips to the spreader bar.

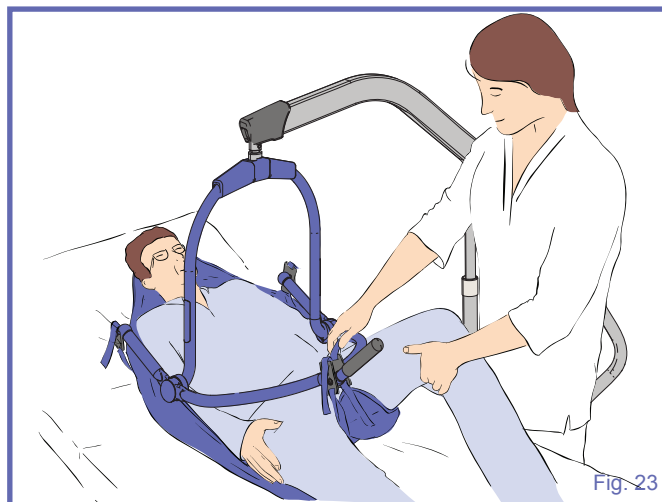

- 8) Raise the patient using the hand control, positioning him comfortably to a semi-reclined position for the transfer. The patient should not be lifted above the caregiver's eye-level.
- 9) Turn the patient to face the caregiver, and keep at a normal chair height.
- 10) Proceed with the transfer.

## Lowering Patient to a Bed

- 1) Once the patient has arrived at destination reposition the patient according to the destination position.
- 2) Lower the patient down onto the new location by making small adjustments during the descent so that the patient is always in the best comfortable position.
- 3) When the patient's body weight is fully supported, detach the connections clips.
- 4) Move the lift away from the patient.
- 5) Remove the sling from under the patient.

### **Lifting Patient from the Floor**

The technique described here can be used for transferring patients lying on the floor.

Patients being lifted from the floor due to a slip or fall should only be lifted after examination by qualified medical personnel. The patient can be lifted from a completely reclined position on the floor, but for his comfort, put a pillow under his head first.

- 1) Roll the patient onto their side.
- 2) Fold the sling in half and place on the floor and marking it, along the back of the patient so that the base of his spine is aligned with the base of the sling, making sure the sling extends to the top of the patient's head.

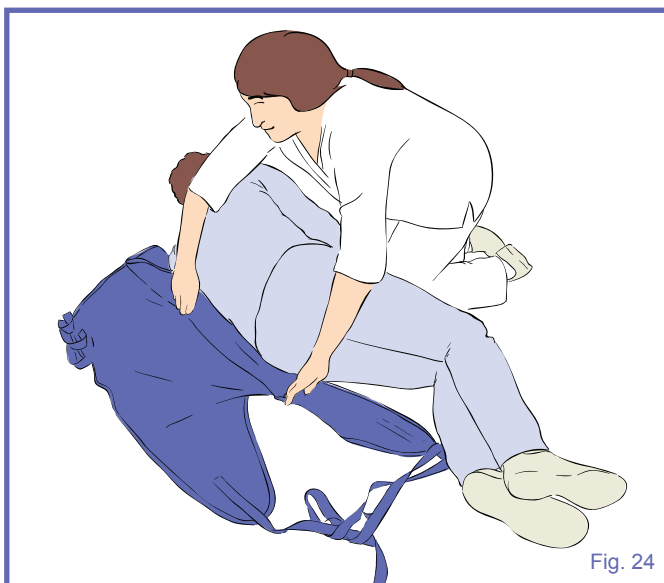

- 3) Roll the patient back onto the sling and then slightly further in the opposite direction, so that the folded part of the sling can be unfolded.

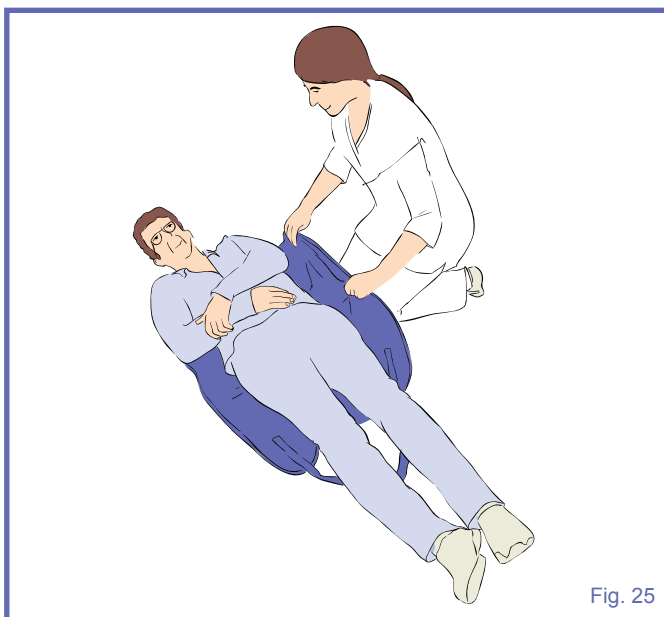

- 4) Depending on circumstances, space or position of patient, approach the patient with the open part of the chassis.

- 5) Adjustment of the spreader bar height may have to be made before connection is possible.
- 6) Attach the shoulder strap clips first, then, with the open part of the sling, support frame pointing downwards towards the shoulders, connect the leg strap clips.



- 7) When all the clips are securely attached, raise the patient from the floor in a semi-recumbent position.
- 8) Once raised from the floor, ensure the patient's legs are clear of the chassis before continuing to lift.
- 9) Turn the patient to face the caregiver, and keep at a normal chair height.
- 10) Proceed with the transfer.

### **Lowering Patient to the Floor**

- 1) Lower the patient down onto the new location by making small adjustments during the descent so that the patient is always in the best comfortable position.
- 2) When the patient's body weight is fully supported, detach the connections clips.
- 3) Move the lift away from the patient.
- 4) Remove the sling from under the patient.

# Loop Slings Application

## Compatible Loop Slings

This section only applies for lifts supplied with a 2-point spreader bar.

Arjo loop sling profiles that can be used with the *Maxi 500*.

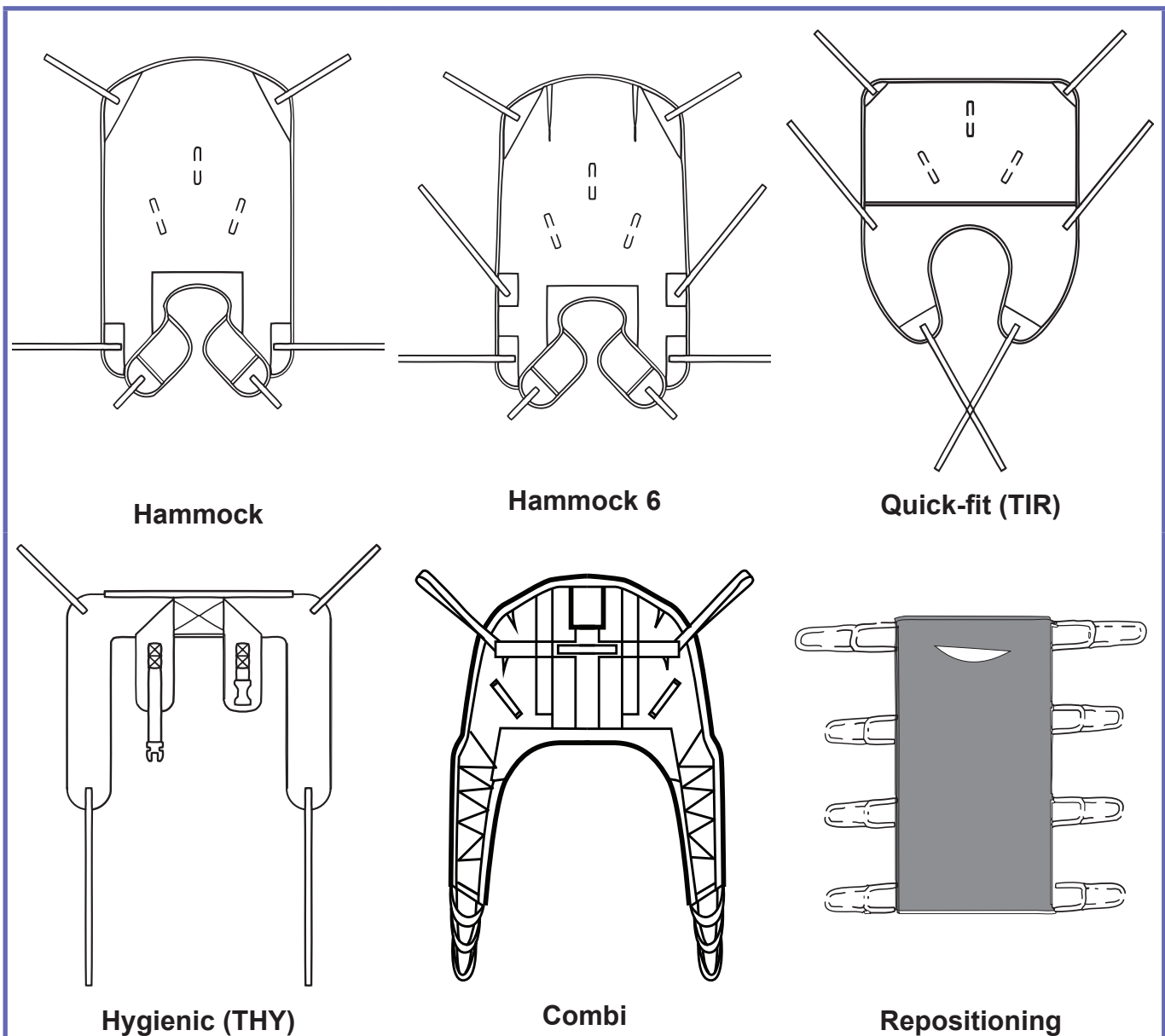

**NOTE:** Other sling models are available. Contact your Arjo vendor for more information about loop slings and how to use them.



## Sling Selection

The spreader bar that is attached to the lift determines what slings can be used to transfer a patient.

Slings are colour coded for size by having a different colour edge binding or attachment strap colouring:

- Red - Small - S
- Yellow - Medium - M
- Green - Large - L
- Blue - Extra Large - XL

Note that some sling models are not available in all sizes.

A wide variety of slings are available for each application. Please contact your local Arjo vendor for more information.

Flites® (single patient multi-use slings) are also available for most sling models. If Arjo Flites slings are to be used with the *Maxi 500* floor lift, refer to the separate Arjo Flites slings *Instruction for Use*.

**WARNING:** Only use Arjo slings with the *Maxi 500* floor lift. Use of non-approved slings could result in patient fall.

## Spreader Bar Compatibility

The *MAXI500* floor lift is only compatible with the spreader bar that is delivered with the lift.

*MAXI500* floor lift model that is designed for use with loop slings is delivered with a

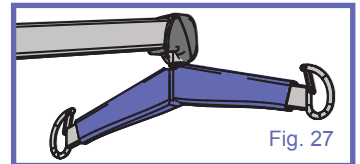

2-point spreader bar.

## Attaching the Sling to the Spreader Bar

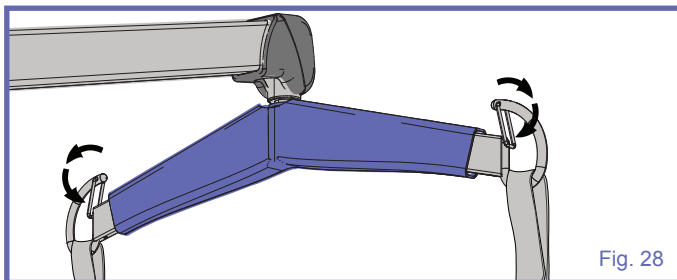

Place the attachment loops onto the hooks.

Make sure the loops are positioned correctly and that the safety latches are closing the hooks as shown in “Fig. 28”.

## Positioning the Patient

Loop slings are available in many sizes. The correct size sling will be able to support the patient’s shoulders during the transferring procedure.

Body Position According to Selection of Loop Straps			
SHOULDERS	SHOULDERS	LEGS	HIPS*
	3	1	2
	2	1	2
	1	1	2
	1	2	1

The specific loop sling chosen determine the position of the patient. Different loop combinations can be used to allow the patient to be lifted and transferred in positions ranging from semi-reclined to seated.

**NOTE:** Slings with more loops allow additional alternative positions.

\*Hip loops only available on THA6i model

## Attachment Methods

Once the loop sling has been fitted around the patient, it can be configured in three ways. With each of the three methods described below, it is necessary to first connect each shoulder loop of the sling to both sides of the spreader bar.

### Attachments Points

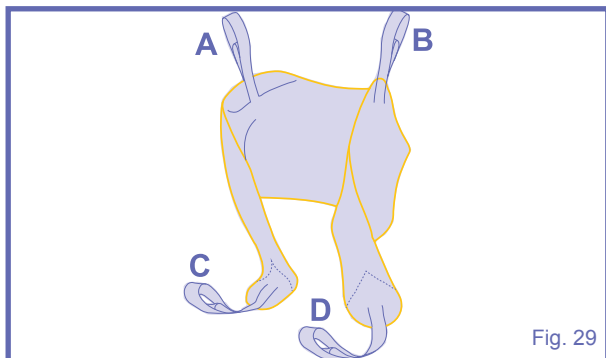

Fig. 29

The attachment point designation shown here are only for the purpose of the explanations below.

### Method 1 - Cross-through

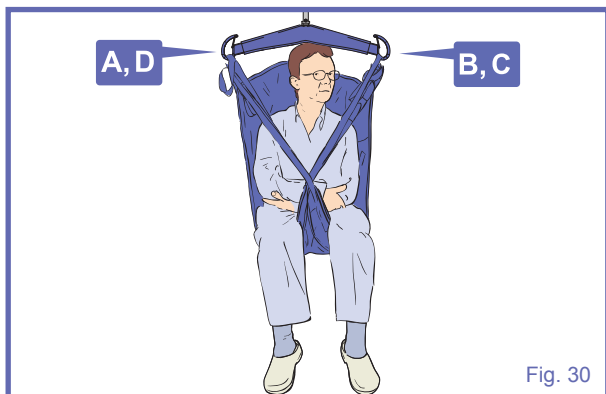

Fig. 30

This method is recommended for most general transfer

Legs closed with crossing straps

### Method 2 - Hammock

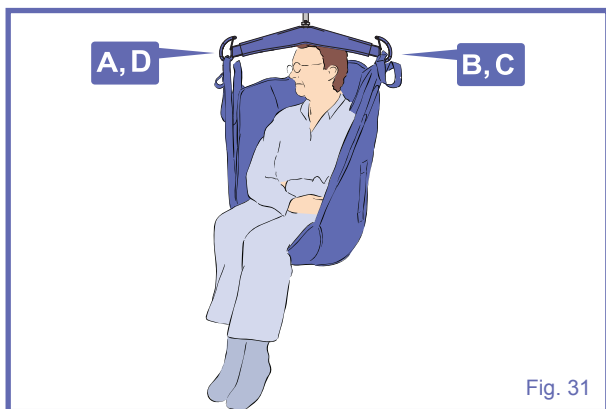

Fig. 31

This method can provide a comfortable cradle for amputee patient.

It is also a useful method for patients with contractures, making it difficult to bring a sling strap between the legs.

**WARNING: Method 2** might not be suitable for confused, combative or erratic patients as they can fall forward and get injured.

Bridge, legs closed

### Method 3 - Abduction

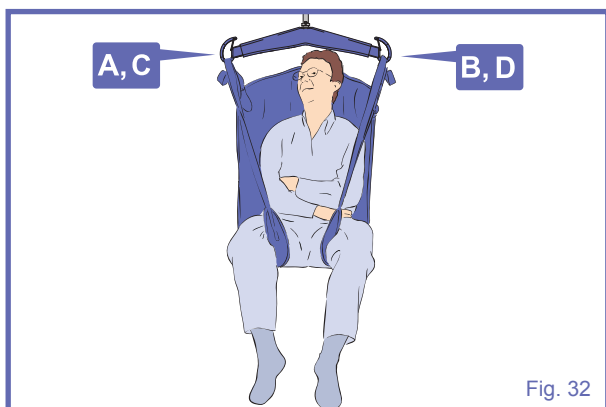

Fig. 32

In this method, legs are held in abduction which is convenient for toileting and hygiene care.

**WARNING: Method 3** might not be suitable for patients with no upper body control as they can slide down and almost out of the sling.

Legs opened with non-crossing straps



## Transferring Patients Using Loop Slings

Before using the *Maxi 500* ensure that:

- A clinical assessment of the patient's suitability for transfer is carried out by a qualified health professional considering that, among other things, the transfer may induce substantial pressure on the patient's body.
- Special consideration is taken when transferring a patient who is connected to electrodes, catheters, or other medical devices.
- Always carry out the items marked as "Before every use" in the "Preventive Maintenance Schedule" before using the lift.

**WARNING:** To avoid injury or discomfort, do not lower the spreader bar onto the patient.

**WARNING:** Always hold the spreader bar when near a patient. The spreader bar could hit the patient resulting in injury.

**WARNING:** Make sure the sling is not caught on any obstructions (for instance, the wheelchair brakes or armrests). Sling catching in such obstructions could result in patient fall.

### Lifting Patient from a Seated Position

The techniques described here can be used for transferring patients regardless of where they may be seated (e.g. in a bed, in a chair, wheelchair or similar).

- 1) Place the sling around the patient so that the base of the sling sits slightly below the tail bone.  
A MaxiSlide® or MaxiTube® positioning aid can be used to assist with placement of the sling.



Fig. 33

- 2) Ensure that the head support area of the sling is behind the head covering it.
- 3) Pull each leg strap under the thigh so that it emerges on the inside of the thigh.

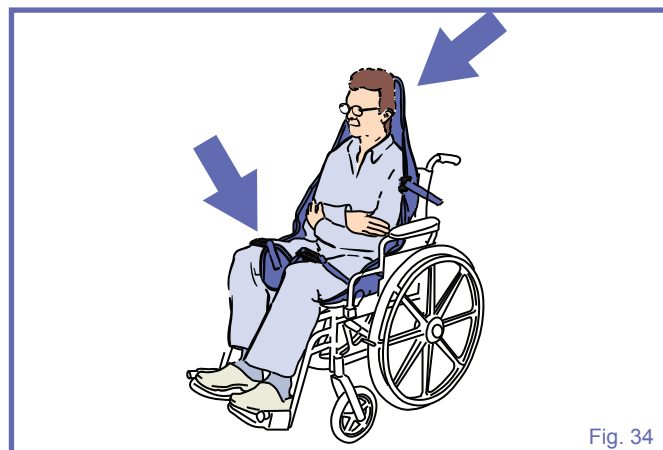

Fig. 34

- 4) Approach the patient with the lift, ensure that:
  - the spreader bar is at or just below shoulder level;
  - the spreader bar is close enough to be able to fix all the sling loops onto the spreader bar hooks.
- 5) Connect the shoulder loops, and then the leg section using one of the three methods previously described.
- 6) If necessary, lower the spreader bar a little further.

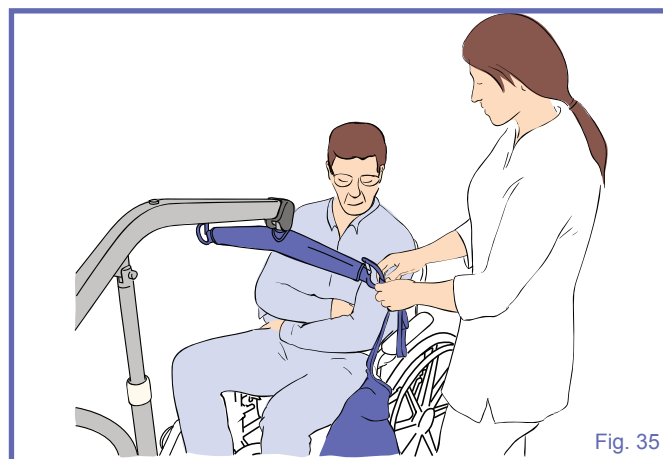

Fig. 35

- 7) Raise the patient using the hand control, positioning him comfortably to a semi-reclined position for the transfer. The patient should not be lifted above the caregiver's eye level.
- 8) Turn the patient to face the caregiver, and keep at a normal chair height.
- 9) Proceed with the transfer.

### Lowering Patient to a Seated Position

- 1) Once the patient has arrived at destination, reposition the patient according to the destination position.
- 2) Lower the patient down onto the new location.
- 3) When the patient's body weight is fully supported, detach the sling.
- 4) Move the lift away from the patient.
- 5) Remove the sling from under the patient.

## Lifting Patient from a Bed

Before you start, make sure the bed is in correct working height.

**WARNING:** Make sure that the bed safety side is installed to prevent the patient from falling.

- 1) Roll the patient onto their side.
- 2) Fold the sling in half and place on the bed land marking it, along the back of the patient so that the base of his spine is aligned with the base of the sling, making sure the sling extends to the top of the patient's head.



- 3) Roll the patient back onto the sling and then slightly further in the opposite direction, so that the folded part of the sling can be unfolded.

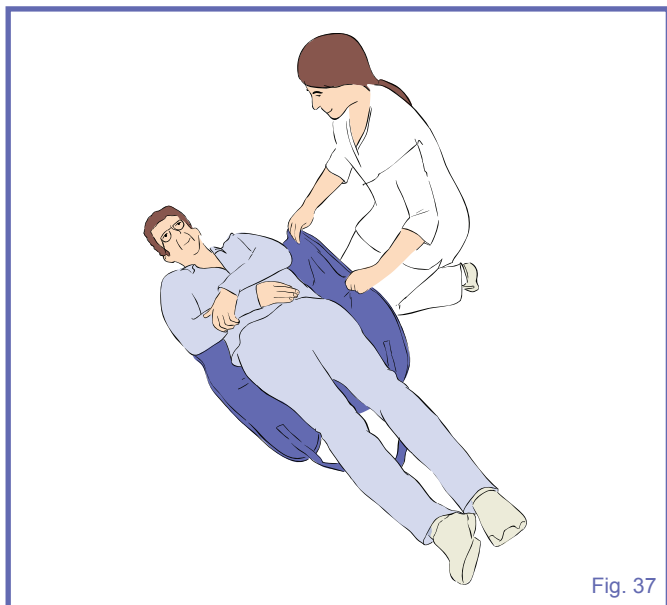

- 4) If possible, slightly raise the head of the bed.
- 5) Approach the patient with the lift. Ensure that the spreader bar is close enough to be able to fix all the sling loops onto the spreader bar hooks.

**WARNING:** Always hold the spreader bar when near a patient. The spreader bar could hit the patient resulting in injury.

- 6) Connect the shoulder loops, and then the leg section using one of the three methods previously described.



- 7) Raise the patient using the hand control, positioning him comfortably to a semi-reclined position for the transfer. The patient should not be lifted above the caregiver's eye-level.
- 8) Turn the patient to face the caregiver, and keep at a normal chair height.
- 9) Proceed with the transfer.

## Lowering Patient to a Bed

- 1) Once the patient has arrived at destination reposition the patient according to the destination position.
- 2) Lower the patient down onto the new location.
- 3) When the patient's body weight is fully supported, detach the sling.
- 4) Move the lift away from the patient.
- 5) Remove the sling from under the patient.

### ***Lifting Patient from the Floor***

The technique described here can be used for transferring patients lying on the floor.

Patients being lifted from the floor due to a slip or fall should only be lifted after examination by qualified medical personnel. The patient can be lifted from a completely reclined position on the floor, but for his comfort, put a pillow under his head first.

- 1) Roll the patient onto their side.
- 2) Fold the sling in half and place on the floor land marking it, along the back of the patient so that the base of his spine is aligned with the base of the sling, making sure the sling extends to the top of the patient's head.



- 3) Roll the patient back onto the sling and then slightly further in the opposite direction, so that the folded part of the sling can be unfolded.



- 4) Depending on circumstances, space or position of patient, approach the patient with the open part of the chassis.

- 5) Adjustment of the spreader bar height may have to be made before connection is possible.
- 6) Connect the shoulder loops, and then the leg section using one of the three methods previously described.
- 7) When all the connectors are securely attached, raise the patient from the floor in a semi-recumbent position.
- 8) Once raised from the floor, ensure the patient's legs are clear of the chassis before continuing to lift.

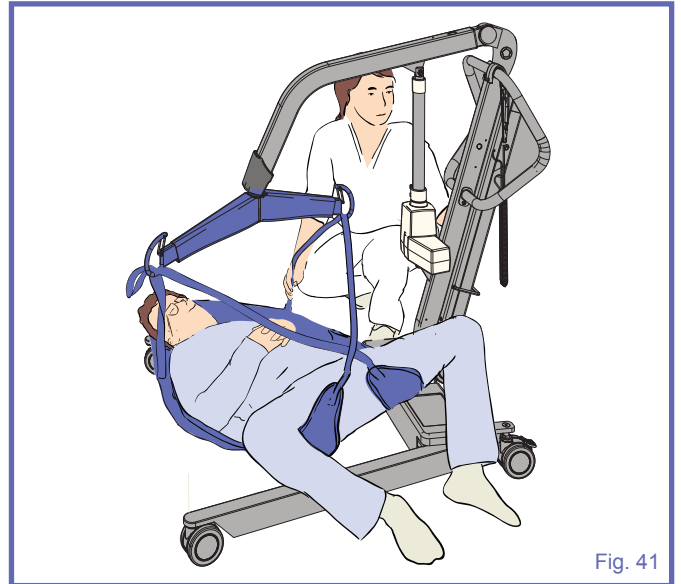

- 9) Turn the patient to face the caregiver, and keep at a normal chair height.

### ***Lowering Patient to the Floor***

- 1) Lower the patient down onto the new location.
- 2) When the patient's body weight is fully supported, detach the sling.
- 3) Move the lift away from the patient.
- 4) Remove the sling from under the patient.

# Care and Maintenance

## Lift Cleaning and Care

**Note:** It is recommended that your *Maxi 500* and its accessories are cleaned and disinfected between each patient use, or daily as a minimum. If the lift and equipment needs cleaning, or is suspected of being contaminated, follow the cleaning and disinfection procedures recommended below, before re-using the equipment.

For cleaning your lift and its accessories wipe down with a damp cloth using warm water to which a disinfectant/cleaner has been added (e.g. "Arjo" - disinfectant/cleaner or equivalent).

**CAUTION:** Never use a wet cloth on the control box, the battery support or the battery pack as it may cause corrosion on electrical components.

If a hot air dryer is used to dry the lift, the temperature must not exceed 80°C (176°F.) Do not use petroleum based solvents or similar, as this may damage plastic parts.

When cleaning, pay special attention to parts that are most likely to be touched such as:

- the handset;
- the control box;
- the battery pack;
- the lift handle;
- the spreader bar.

# Preventive Maintenance Schedule

The *Maxi 500* is subject to wear and tear, and the following actions must be performed when specified to ensure that the product remains within its original manufacturing specification.

**WARNING:** The points on this checklist are the minimum the manufacturer recommends. In some cases more frequent inspections should be carried out. Continuing to use this equipment without conducting regular inspections will seriously compromise the user and resident/patient's safety. Preventive maintenance specified in this manual can prevent accidents

**WARNING:** Safety related maintenance and authorized service must be carried out by qualified personnel, fully trained in servicing procedures by Arjo, and equipped with correct tools and proper documentation, including Parts List and Service Manual. Failure to meet these requirements could result in personal injuries and/or unsafe equipment

**WARNING:** Never proceed to maintenance or service while lift is in use with a patient.

POINTS TO BE INSPECTED BY USER/SERVICE TECHNICIAN	FREQUENCY		
	Annually (12 Hours*)	Before every use	
	Initially ↓	↓	↓
1) When equipped with a 2-point spreader bar, ensure that the bar safety latches are present and are freely pivoting.		x	
2) Ensure that the battery charge indicator is within the normal range.		x	
3) Ensure that the casters are firmly fixed to the chassis.			x
4) When equipped with a DPS, make sure that the DPS is properly attached with the pin and that the pin is secured with the locking spring.		x	
5) Make sure that the mast is secured to the base with the locking screw.		x	
6) Verify the proper functioning of the rear castor brakes.	x		x
7) Ensure that the actuator attachments are tightened at both ends.	x		x
8) Check front and rear castors regularly for hair and debris; clean when necessary.			x
9) Press the emergency stop button and make sure that all electrical power is cut off. No action should occur when activating the "Up" or "Down" buttons. Hour meter and battery indicator should also shut down.	x		x
10) Check all the functions on the hand control. Ensure that the hand control touch pad membrane is intact.	x		x
11) Check all the functions on the control box.	x		x
12) Check the function of the emergency lowering device by applying weight to the lift and pulling the red handle on the actuator.	x		x

\* Time period indicated by the Hour meter.

ADDITIONAL POINTS TO BE INSPECTED BY SERVICE TECHNICIAN	FREQUENCY		
	Annually (12 Hours*)		
	Before every use		
	Initially	↓	↓
13) Make sure the shoulder bolt between the boom and the mast is securely fastened and that the cotter pin is present.			x
14) Inspect all weld sites for cracking or separation.			x
15) Make sure that all nuts and locknuts of the base open/close mechanism are securely fastened and the ball joints are in good condition.			x
16) Check all bolts, nuts and locknuts to ensure they are tight.			x
17) Check if the leg pivot bolts are secured with locknuts; tighten, if necessary.			x
18) Make sure that the straight section of both legs is perpendicular to the base, in closed position.			x
19) If the product does not work as intended, immediately contact your local Arjo vendor for support.			x
20) Check that the Spreader Bar flange bushings, pivot bolt and welds are in good condition.			x
21) Check the condition of the friction discs and bushings of the DPS within the pivot points. If found worn and/or damaged, parts must be replaced.			x
22) When the friction discs and bushings of the DPS have been checked/replaced, reset friction assembly to support a 5.4 kg (12 lb) load at the handle.			x

\* Time period indicated by the Hour meter.

Lift Trouble	Resolution
Hand control does not respond.	<ul style="list-style-type: none"> <li>• Check the red emergency stop button on the control box.</li> <li>• Check the connector on hand control cord.</li> <li>• Check the battery condition (replace with a fully charged battery pack).</li> </ul>
UP and DOWN buttons on control box do not respond.	<ul style="list-style-type: none"> <li>• Check the red emergency stop button on the control box.</li> <li>• Check the battery condition (replace with a fully charged battery pack).</li> </ul>
Actuator does not respond.	<ul style="list-style-type: none"> <li>• Check the red emergency stop button on control box.</li> <li>• Check if the battery is installed correctly and fully charged. Test with a new, fully-charged battery pack.</li> <li>• Check if the hand control is connected.</li> <li>• Check if control box is in automatic cut-out mode, make sure boom is not obstructed or overloaded.</li> </ul>
Audible “beep” is heard from the control box.	<ul style="list-style-type: none"> <li>• Battery is low. Replace with a freshly charged battery pack.</li> </ul>
Actuator “stalls” during lift.	<ul style="list-style-type: none"> <li>• Battery is low. Replace with a freshly charged battery. Make sure not to exceed the lifting capacity.</li> </ul>
Battery Trouble	Resolution
Yellow indicator light does not go off after several hours of charging time.	<ul style="list-style-type: none"> <li>• Internal batteries need replacing. Call Arjo for replacement.</li> </ul>
Battery pack indicates it is fully charged when in the charger, but when placed in the lift, will only do a few lifts.	<ul style="list-style-type: none"> <li>• Replace the battery.*</li> </ul>

(\*) Generally, a humming noise coming from the actuator indicates low battery power.



# Labels on the Lift

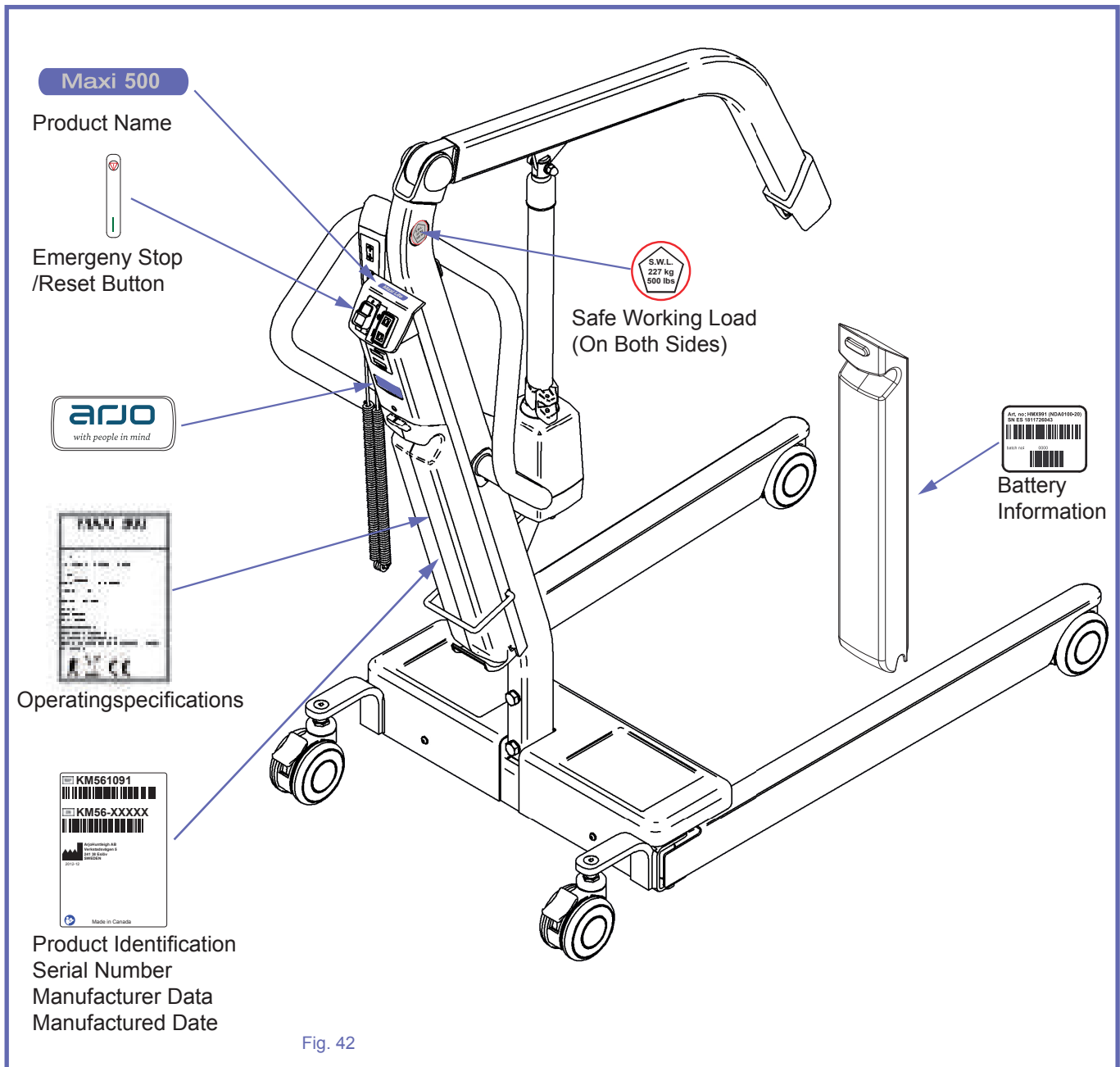
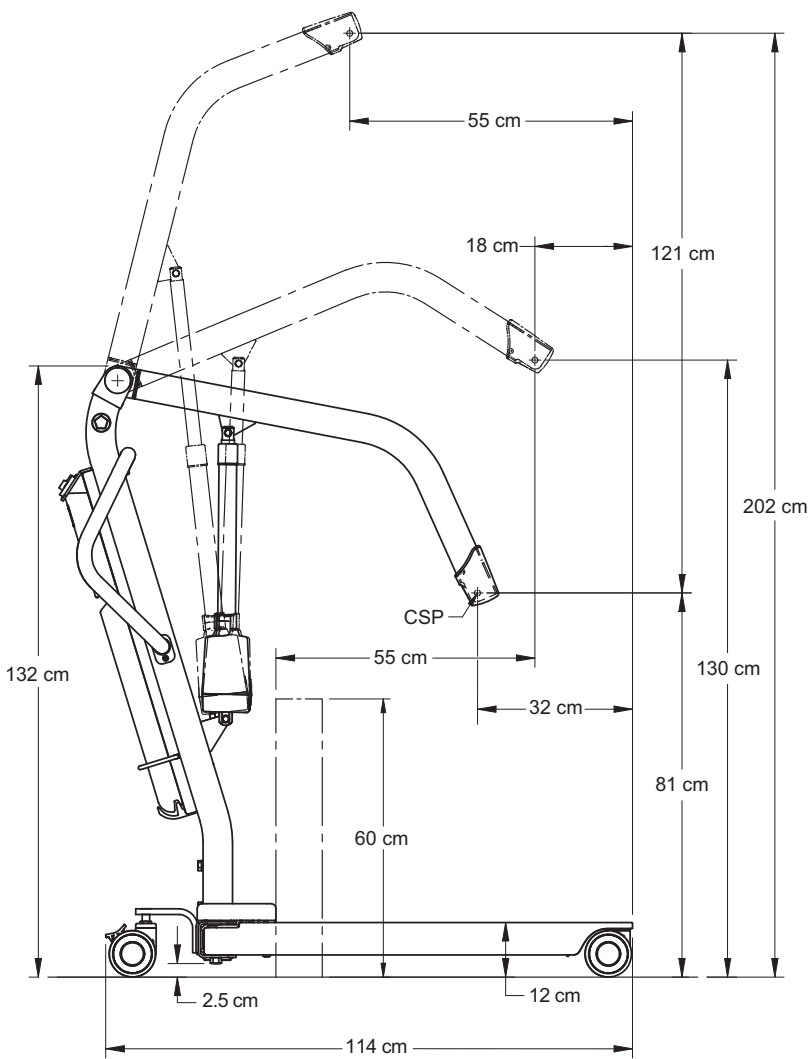
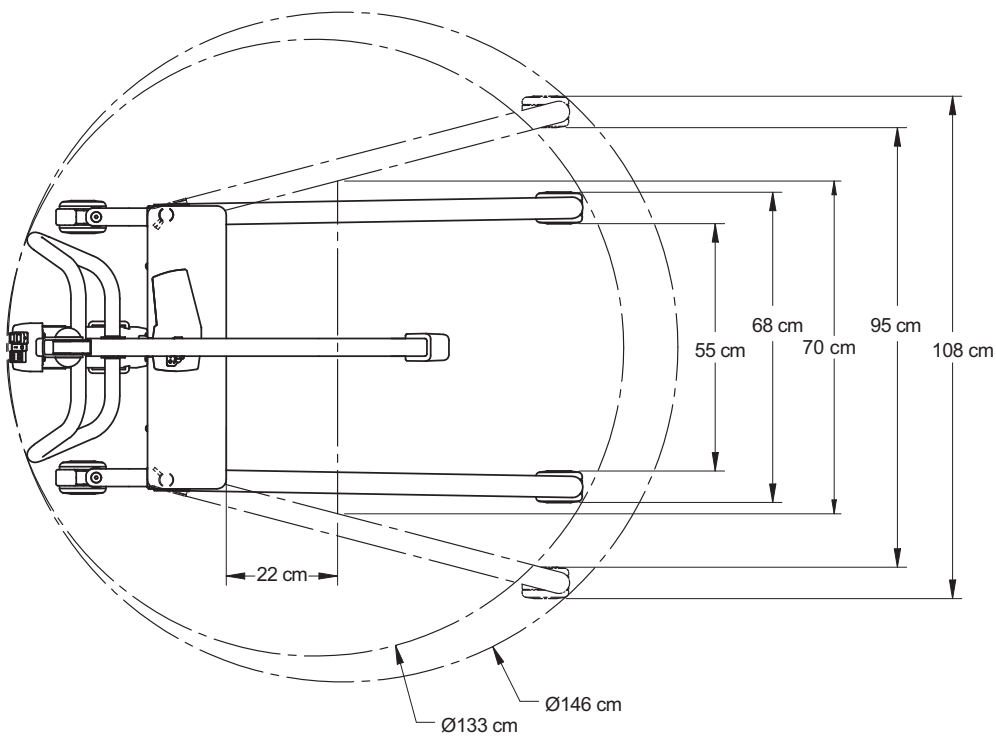

Fig. 42

# Technical Specifications

PRODUCT INFORMATION	
<b>MAXI 500 (KM56XXXX)</b>	
Total weight (without battery or accessory)	46,4 kg (102 lb)
Battery pack weight	5 kg (11 lb)
Lifting capacity	227 kg (500 lb)
Minimum door requirement	700 mm (27.5 in)
MECHANICAL	
IP rating control lift	Lift: Refer IP24 Hand Control : IPX7
Operating forces of controls	Hand Control: < 5 N
Sound power level	< 65 dBA
ELECTRICAL	
Battery Type	Rechargeable (Sealed Lead-Acid)
Battery Capacity	24V, 4Ah
Battery charger input	(NDA8200): 100 to 240 Vac / 50-60 Hz / 50VA
Battery charger output	24 Vdc, 1A, 24VA
Protection class	Class II, double insulated
Up and down current limiting	10 A
Duty cycle	10%, 6 min / hour, 1 min continuous
Protection against electrical shock	Refer to product label
<p>The <i>Maxi 500</i> meets the requirements of Electromagnetic Compatibility (EMC) as stated in clause 12.5 of the Medical Devices Directive 93/42/EEC.</p> <p>The <i>Maxi 500</i> is compliant to IEC 60601-1 series including applicable collateral standards and national deviations. The <i>Maxi 500</i> is compliant to ISO 10535 standard.</p>	
<p><b>WARNING:</b> Portable RF communications equipment (including peripherals such as antenna cables and external antennas) should be used no closer than 30 cm to any part of the <i>Maxi 500</i>, including cables specified by the manufacturer. Otherwise, performance degradation of this equipment could result. See “Electromagnetic Compatibility” section for more details.</p>	
ENVIRONMENTAL CONDITIONS	
Ground Requirement	Maximum Slope: 1° Surface condition: Flat hard surface
Ambient temperature range (lift, batteries)	Operation: 5° to 40°C (+41 to +104 F) Storage: - 25 to 70°C (-13 to 158F)
Relative humidity range	Operation: 15 to 93%, non-condensing Storage: < 93%, non-condensing
Atmospheric pressure range	Operation: 795 hPa to 1060 hPa (2000 m max) Storage: 500 hPa to 1060 hPa
<p><b>WARNING:</b> Product is not suitable in the presence of flammable anaesthetic mixture with air or oxygen, or with nitrous oxide.</p>	
SAFE DISPOSAL at END of LIFE	
Battery	All batteries in the product must be recycled separately. Batteries are to be disposed in accordance with national or local regulations. Sealed lead-acid, rechargeable, recyclable.
Package	Wood and corrugated cardboard, recyclable.
Product	Components that are primarily be made up of different kinds of metal (containing more than 90% metal by weight) for example sling bars, rails, upright supports, etc., should be recycled as metals.
Electrical and electronic components	Lift systems having electrical & electronic components or an electrical cord should be disassembled & recycled per Waste of Electrical and Electronic Equipment (WEEE) or in accordance with local or national regulation.
Slings	Slings including stiffeners/stabilisers, padding material, any other textiles or polymers or plastic materials etc. should be sorted as combustible waste.



Height of Accessories

2 Hooks Spreader Bar

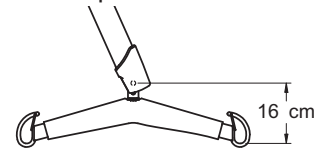

2 Hooks Spreader Bar with Scale

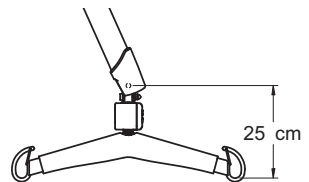

DPS

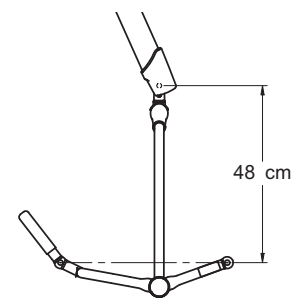

DPS with Scale

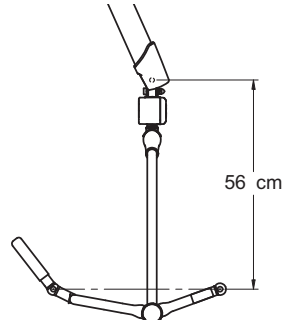

CSP stands for Central Suspension Point: a reference point on the lift for measurements. On the *Maxi 500* the CSP is the Accessory attachment point located at the boom end.

Fig. 43

# Electromagnetic Compatibility

## Electromagnetic Compliance

The *Maxi 500* has been tested for compliance with current regulatory standards regarding its capacity to block EMI (electromagnetic interference) from external sources.

Nonetheless, some procedures can help reduce electromagnetic interferences:

- Ensure that other devices in patient-monitoring and/or life-support areas comply to accepted emissions standards.
- Maximize the distance between electro-medical devices. High-powered devices may produce EMI that can affect the floor lift.

For more information on how to manage the unit's RF electromagnetic environment, please consult the AMI TIR 18-1997 - Guidance on Electromagnetic Compatibility of Medical Devices for Clinical/Biomedical Engineers.

**WARNING:** Use of accessories, cables and spare parts other than those specified or provided by Arjo could result in increased electromagnetic emissions or decreased electromagnetic immunity of this equipment and result in improper operation.

**WARNING:** Use of this equipment adjacent to or stacked with other equipment should be avoided because it could result in improper operation. If such use is necessary, this equipment and the other equipment should be observed to verify that they are operating normally.

**WARNING:** The equipment may cause radio interference or may disrupt the operation of nearby equipment. It may be necessary to take action, such as reorienting, relocating the equipment or shielding the location.

## Electromagnetic Emissions

### Guidance and Manufacturer's Declaration - Electromagnetic Emissions - For all Equipment and Systems

The *Maxi 500* is intended for use in the electromagnetic environment indicated below. The customer or the user of the MAXI500 should assure that it is used in such an environment.

Emissions test	Compliance	Electromagnetic environment - guidance
RF emissions CISPR 11	Group 1	The <i>Maxi 500</i> uses RF energy only for its internal function. Therefore, its RF emissions are very low and are not likely to cause any interference in nearby electronic equipment.
RF emissions CISPR 11	Class B	The <i>Maxi 500</i> is suitable for use in all establishments, including domestic establishments and those directly connected to the public low-voltage power supply network that supplies buildings used for domestic purposes.

## Electromagnetic Immunity

### Guidance and Manufacturer's Declaration - Electromagnetic Immunity - For all Equipment and Systems

The MAXI 500 is intended for use in electromagnetic environment specified below. The customer or the user of the MAXI 500 should assure that it is used in such an environment.

Immunity test	IEC 60601 test level	Compliance level	Electromagnetic environment - guidance
Electrostatic discharge (ESD) IEC 61000-4-2	±8 kV contact ±15 kV air	±8 kV contact ±15 kV air	Floors should be wood, concrete or ceramic tile. If floors are covered with synthetic material, the relative humidity should be at least 30%.
Electrical fast transient/burst IEC 61000-4-4	±1 kV, I/O Ports 100 kHz repetition frequency	±1 kV, I/O Ports 100 kHz repetition frequency	Mains power quality should be that of a typical commercial or hospital environment.
Power frequency (50/60 Hz) magnetic field IEC 61000-4-8	30 A/m 50/60 Hz	30 A/m 50/60 Hz	Power frequency magnetic fields should be at levels characteristic of a typical location in a typical commercial or hospital environment.

NOTE:  $U_T$  is the AC mains voltage prior to application of the test level.

(continued)

Guidance and Manufacturer's Declaration - Electromagnetic Immunity - For all Equipment and Systems			
Immunity test	IEC 60601 test level	Compliance level	Electromagnetic environment - guidance
Conducted RF IEC 61000-4-6	3 V outside ISM bands between 0.15-80 MHz  6 V inside ISM and amateur radio bands between 0.15-80 MHz	3 V outside ISM bands between 0.15-80 MHz  6 V inside ISM and amateur radio bands between 0.15-80 MHz	N/A
Radiated RF IEC 61000-4-3	10 V/m 80 MHz to 2.7 GHz	10 V/m 80 MHz to 2.7 GHz	N/A
Proximity fields from RF wireless communications equipment  IEC 61000-4-3	380 - 390 MHz 27 V/m; PM 50%; 18 Hz  430 - 470 MHz 28 V/m; (FM ±5 kHz, 1 kHz sine) PM; 18 Hz  800 - 960 MHz 28 V/m; PM 50%; 18 Hz  1700 - 1990 MHz 28 V/m; PM 50%; 217 Hz  2400 - 2570 MHz 28 V/m; PM 50%; 217 Hz  5100 - 5800 MHz 9 V/m; PM 50%; 217 Hz  704 - 787 MHz 9 V/m; PM 50%; 217 Hz	380 - 390 MHz 27 V/m; PM 50%; 18 Hz  430 - 470 MHz 28 V/m; (FM ±5 kHz, 1 kHz sine) PM; 18 Hz  800 - 960 MHz 28 V/m; PM 50%; 18 Hz  1700 - 1990 MHz 28 V/m; PM 50%; 217 Hz  2400 - 2570 MHz 28 V/m; PM 50%; 217 Hz  5100 - 5800 MHz 9 V/m; PM 50%; 217 Hz  704 - 787 MHz 9 V/m; PM 50%; 217 Hz	N/A