

Living up to Life

Leica
MICROSYSTEMS

Leica DMi8

Instructions for Use · Gebrauchsanweisung · Mode d'emploi

Leica Microsystems CMS GmbH · Instructions 11934056, Revision 1.1 from 2015-07-15





Living up to Life



Leica DMi8

Instructions for Use

Leica Microsystems CMS GmbH • Instructions 11934056, Revision 1.1 from 2015-07-15



Copyright

All rights to this documentation are held by Leica Microsystems CMS GmbH. Reproduction of text or illustrations (in whole or in part) by print, photocopy, microfilm or other method (including electronic systems) is not allowed without express written permission from Leica Microsystems CMS GmbH.

The instructions contained in the following documentation reflect state-of-the-art technology. We have compiled the texts and illustrations as accurately as possible. Still, we are always grateful for comments and suggestions regarding potential mistakes within this documentation.

The information included in this manual may be changed without prior notice.

Revision 1.1, published on 2015-07-15 by:

Leica Microsystems CMS GmbH
Ernst-Leitz-Straße 17-37
D-35578 Wetzlar (Germany)
<http://www.leica-microsystems.com>
Responsible for contents:
Marketing CMS

Contents

1	Important Notes about this Manual	4
1.1	Text symbols and their meanings.....	4
2.	Intended Purpose of the Microscope	6
3.	Safety Notes	8
3.1	General safety notes	8
3.2	Electrical safety	8
3.3	Laser safety	11
3.3.1	Safety switch (interlock) on the microscope	11
3.3.2	Screwed-on filter turret cover.....	12
3.3.3	Laser coupling by the user	12
3.3.3.1	Safety hazard due to folded back Transmitted Light arm	13
3.3.3.2	Safety hazard at eyepiece.....	13
3.3.3.3	Safety hazard in the condenser area during operation.	13
3.3.3.4	Safety hazard above the condenser.....	14
3.3.3.5	Safety hazard in the specimen area.....	14
3.3.3.6	Safety hazard due to openings at microscope	15
3.3.3.7	Note regarding the safety hazards in Sections 3.3.3.1 and Section 3.3.3.2.....	16
3.3.4.	Exception for Class 1 lasers	17
3.5	Storage and transport.....	18
3.6	Ambient conditions.....	18
3.7	Notes on handling light sources	19
3.8	Notes on handling the Touch Screen	20
3.9	Notes on handling immersion oil.....	20
3.10	Notes on handling acids and bases	20
3.11	Disposal.....	20
4.	Leica DMI8 configurations instrument overview	21
4.1	Microscope configurations (examples).....	21
4.2	Dimensions (specified in mm).....	22
4.3	Specifications ⁺	24
4.4	Controls	28
4.4.1	Control panel fields.....	29
4.4.2	Additional control elements.....	31
4.4.3	The Touch Screen.....	34
4.4.4	The Leica SmartMove control element.....	36
4.4.5	Leica STP4000/8000 external control panel.....	37

5.	Operation	38	6.	Troubleshooting	86
5.1	Switching on the microscope	39	7.	Care of the Microscope.....	89
5.2	Illumination	41	7.1	Dust Cover.....	89
5.2.1	Transmitted Light.....	41	7.2	Cleaning.....	89
5.2.2	Fluorescence.....	42	7.3	Handling acids and bases	90
5.2.3	Infinity port.....	44	8.	Essential Consumable and Spare Parts	91
5.2.4	Shutter	45	9.	Appendix.....	92
5.3	Objectives	46	9.1	Assigning the variable function keys	92
5.4	Tube.....	49	9.2	Abbreviation glossary	94
5.5	Eyepieces.....	50	9.3	Overview of Touch Screen pictograms.....	95
5.6	Stages and object displacement.....	51	9.4	Additional information.....	96
5.6.1	Object displacement	51	10.	Index	97
5.6.2	Adjusting the step sizes on motorized stages.....	52	11.	EC Declaration of Conformity.....	99
5.7	Focusing	54			
5.7.1	Focusing the image	54			
5.7.2	Focus thresholds.....	55			
5.7.3	Adjusting the step sizes	56			
5.7.4	AFC (Adaptive Focus Control).....	57			
5.8	Selecting the ports	58			
5.9	Magnification Changer	59			
5.10	Aperture diaphragm and field diaphragm	60			
5.11	Filter	62			
5.11.1	Transmitted Light filter	62			
5.11.2	Fluorescence Cubes.....	63			
5.11.3	Leica RFID Module.....	65			
5.11.3.1	Product Description	65			
5.11.3.2	Specifications LID Module 1.0.....	65			
5.11.3.3	Specifications RFID Tag D6.7 special.....	65			
5.11.3.4	Ports.....	65			
5.11.3.5	FCC / IC Compliance	65			
5.12	The memory function on the Touch Screen	66			
5.13	Transmitted Light contrast method	66			
5.13.1	Brightfield (TL).....	67			
5.13.2	Phase Contrast (TL)	69			
5.13.3	Darkfield (TL)	71			
5.13.4	Polarization (TL)	72			
5.13.5	Differential Interference Contrast – DIC (TL)	74			
5.13.6	Integrated Phase Contrast – IPH (TL)	76			
5.13.7	Integrated Modulation Contrast – IMC (TL)	78			
5.14	Fluorescence	82			
5.15	Combination method	85			

1 Important Notes about this Manual



Caution!

These Instructions for Use are an essential component of the product; they must be read carefully before the product is assembled, put into operation or used, and must be kept for later reference.

These Instructions for Use include important instructions and information related to the operating safety and maintenance of the instrument.

1.1 Text symbols and their meanings

(1.2)

Numbers in brackets, e.g. (1.2), refer to illustrations, in the example to Fig. 1, item 2.

→ p.20

Numbers with an arrow, e.g. → p. 20, refer to a specific page of the manual.



WARNING indicates a hazard with a medium degree of risk that, if not avoided, can result in death or serious injury.



CAUTION indicates a hazard with a low degree of risk that, if not avoided, can result in minor or moderate injury.



Caution!

In this manual, additional safety notes are indicated with the triangle symbol shown here, and have a gray background.



Caution! The instrument and accessories can be damaged when operated incorrectly.

1. IMPORTANT NOTES ABOUT THIS MANUAL



Warning of hazardous electrical voltage! Risk of electrical shock!



Danger due to hot surface



Warning of optical radiation! Never look directly into the light beam! Wear safety goggles!



Warning of electromagnetic field



Warning of UV radiation! Wear safety goggles!



Warning of hazardous laser radiation – take appropriate safety precautions!



Warning of hand injuries



Instructions for disposing of the instrument, its accessories and consumables.



Connection to ground



Explanatory note

*

Item not contained in all equipment configurations



Manufacturing date, e.g. 11 / 2011 for November 2011



China RoHS 50 years EFUP
(Environmentally friendly use period)

2. Intended Purpose of the Microscope

DMi8 Leica microscopes are inverted light microscopes and are intended for use as general lab microscopes for routine examinations of biological specimens.

The Leica DMi8 series can be used universally. All contrast methods, such as Brightfield, Darkfield, Phase Contrast, DIC, fluorescence or modulation contrast, are integral components of the microscope and can be adapted or exchanged quickly and easily. Variable illumination and imaging beam paths as well as HCSoptics, modular accessories and a wider range of available peripherals supplement the inverted Leica research stand from Leica Microsystems CMS GmbH.

Leica DMi8 microscopes:

Leica DMi8 manual	11889110
Leica DMi8 coded	11889111
Leica DMi8 automated	11889112
Leica DMi8 automated	11889113
Leica DMi8 automated	11889014

Directives of European Community (EC-Directives)

The named microscope meets the requirements of the Council Directives 2006/95/EC and 2014/35/EC concerning electrical apparatus and 2004/108/EC and 2014/30/EC concerning electromagnetic compatibility.

Reasonably foreseeable misuse

The following are prohibited:

- To use the microscope for any purpose not in accordance with the Declaration of Conformity (e.g. the use of medical products in accordance with *EU Directive 93/42/EEC*)
- Making use of auxiliary equipment to use the area between the microscope stage and objectives as a clamp or holder (working like a vice)
- Operating the microscope in an inclined position
- Cleaning the microscope in a way other than specified in the manual
- Modifying the built-in safety circuits in the instrument
- Allowing unauthorized personnel to open the instrument
- Using cables that Leica Microsystems CMS GmbH has not provided or permitted
- Using the swiveling Touch Screen of the microscope as a transport handle
- Using combinations with non-Leica components that go beyond the scope of the manual



Caution!

The manufacturer assumes no liability for damage caused by, or any risks arising from, using the microscope for other purposes than those for which they are intended or not using them within the specifications of Leica Microsystems CMS GmbH.
In such cases, the Declaration of Conformity shall be invalid.



Notes on handling laser devices

In the standard design without additional laser safety precautions, the microscopes are not suitable for coupling laser radiation (such as to the camera ports), since this radiation poses a hazard for the user (eye injury in particular).

For use of the microscope with lasers, Leica Microsystems CMS GmbH offers special microscope variants with additional safety features. Laser couplings require corresponding safety devices that have to be inspected and installed by trained personnel. For further information, please contact your authorized Leica Microsystems CMS GmbH representative.

3. Safety Notes

3.1 General safety notes

These instruments of protection class 1 are built and inspected in accordance with *EN 61010-1 / IEC 61010-1 Safety requirements for electrical equipment for measurement, control and laboratory*.

They also meet the requirements in *EN / IEC 61326-1 Electrical equipment for measurement, control and laboratory use – EMC requirements*.

The products were also tested in accordance with *EN 62471 / IEC 62471 Photobiological safety of lamps and lamp systems*.



Caution!

In order to maintain this condition and to ensure safe operation, the user must follow the instructions and warnings contained in this operating manual.



Caution!

The instruments and accessories described in this Instructions for Use have been tested for safety and potential hazards.

The responsible Leica Microsystems CMS GmbH affiliate or the main plant in Wetzlar must be consulted whenever the device is altered, modified or used in conjunction with non-Leica components that are outside of the scope of this manual.

Unauthorized alterations to the instrument or noncompliant use shall void all rights to any warranty claims!

3.2 Electrical safety

General specifications

Compact Leica CTR electronics box

For indoor use only.

Supply voltage:	100 – 240 VAC
Frequency:	50 / 60 Hz
Power consumption:	max. 150 VA
Fuses:	3.15 A, slow-blowing, Breaking capacity H, 250 VAC Size: 5x20 mm
Ambient temperature:	15° - 35°C
Relative humidity:	90% up to 30°C, non-condensing
Protection class:	I
Overvoltage category:	II
Pollution degree:	2

Advanced/Advanced+ Leica CTR electronics box

For indoor use only.	
Supply voltage:	100 – 240 VAC
Frequency:	50 / 60 Hz
Power consumption:	max. 290 VA
Fuses:	6.3 A, slow-blowing, Breaking capacity H, 250 VAC Size: 5x20 mm
Ambient temperature:	15° - 35°C
Relative humidity:	90% up to 30°C, non-condensing
Protection class:	I
Overvoltage category:	II
Pollution degree:	2

Leica DMI8 manual

For indoor use only.	
Supply voltage:	100 – 240 VAC
Frequency:	50 / 60 Hz
Power consumption:	max. 55 VA
Fuses:	1.6 A, slow-blowing, Breaking capacity H, 250 VAC Size: 5x20 mm
Ambient temperature:	15° - 35°C
Relative humidity:	90% up to 30°C, non-condensing
Protection class:	I
Overvoltage category:	II
Pollution degree:	2

Leica DMI8 coded

For indoor use only.	
Supply voltage:	100 – 240 VAC
Frequency:	50 / 60 Hz
Power consumption:	max. 55 VA
Fuses:	1.6 A, slow-blowing, Breaking capacity H, 250 VAC Size: 5x20 mm
Ambient temperature:	15° - 35°C
Relative humidity:	90% up to 30°C, non-condensing
Protection class:	I
Overvoltage category:	II
Pollution degree:	2

Leica DMI8 automated

For indoor use only.	
Supply voltage:	100 – 240 VAC (→ Leica CTR)
Frequency:	50 / 60 Hz (→ Leica CTR)
Power consumption:	see Leica CTR
Fuses:	see Leica CTR
Ambient temperature:	15° - 35°C
Relative humidity:	90% up to 30°C, non-condensing
Protection class:	I (→ Leica CTR)
Overvoltage category:	II (→ Leica CTR)
Pollution degree:	2 (→ Leica CTR)

Leica EL6000*

For indoor use only.	
Supply voltage:	100 – 240 VAC
Frequency:	50 / 60 Hz
Power consumption:	max. 200 VA
Fuses:	2.5 A, slow-blowing, Breaking capacity H, 250 VAC Size: 5x20 mm
Ambient temperature:	0° - 40°C
Relative humidity:	90% up to 30°C, non-condensing
Protection class:	I
Overvoltage category:	II
Pollution degree:	2
(* See provided Instructions for Use)	



The power plug may only be plugged into an outlet equipped with a grounding contact.

Do not interfere with the grounding function by using an extension cord without a ground wire. Any interruption of the ground wire inside or outside of the instrument, or release of the protective conductor terminal, can cause the instrument to become hazardous. Intentional ground interruption is not permitted!



Caution!

By connecting it to the grounding connection (earth screw at the back of the electronics box) ancillary equipment with its own and/or extra power supply may be brought to the same ground wire potential. For connections without a ground protection conductor, Leica Microsystems CMS GmbH Service must be consulted.



Caution!

Never use any fuses as replacements other than those of the types and the current ratings listed here. Using other fuses or bridging the fuse holder is not permitted. The use of incorrect fuses may result in a fire hazard.



Caution!

The microscope's electrical accessory components are not protected against water. Water can cause electric shock.



Caution!

Protect the microscope from excessive temperature fluctuations. Such fluctuations can lead to the accumulation of condensation, which can damage the electrical and optical components.
Operating temperature: 15-35°C



Before exchanging the fuses or lamps, be absolutely certain to switch off the main power switch and remove the power cable.

! Caution!

Only insert or unplug data and control circuits when the instrument is switched off; otherwise, the instrument may be damaged.



By definition, the main circuit breaker of this instrument is the connection between the power cable and device port. The user must ensure unobstructed access to the main circuit breaker at all times.



Only use power cables, or alternative cables with VDE/HAR codes that minimally fulfill the following conditions: 3x0.75 mm² and 10A/250V.

3.3 Laser safety

3.3.1 Safety switch (interlock) on the microscope

Two safety switches are integrated into the microscope using a laser safety kit option. These must be integrated into the laser safety concept so that the light path of the laser beam is interrupted when the interlock switch is opened.



Interlock switch (1) and (2)

Interlock switch 1:

An interlock switch is integrated on the Transmitted Light arm and activated when the Transmitted Light arm is folded back (interlock switch opens).

Interlock switch 2:

An additional interlock switch is also installed in the microscope, which is activated (interlock switch opens) when the beam path to the eyepiece is released.

Two equivalent interlock connectors, which lead to the microscope's interlock switch, are attached to the back of the microscope. The interlock connector of the microscope must be connected to your laser beam interrupter.

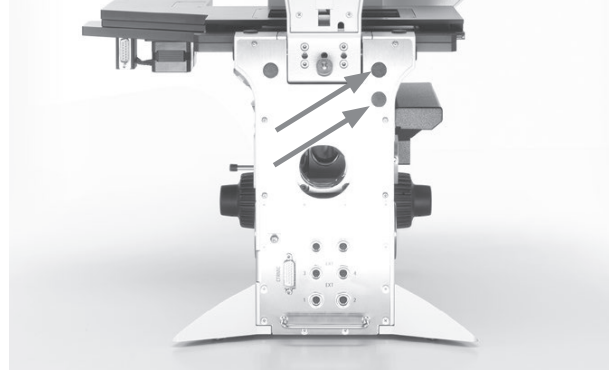

Interlock connectors on the rear side of the stand

Technical data for the interlock connector:

Plug:

Manufacturer: Binder
 Type: 09-0097-20-05
 (5-pin flange plug,
 711 series subminiature round plug connector)

Compatible coupling:

Manufacturer: binder
 Type: 99-0096-102-05
 (5-pin cable socket,
 711 series subminiature round plug connector)

Type: 79-1414-12-05
 (5-pin cable socket with 2m cable,
 702 series subminiature round plug connector)

Type: 99-0414-00-05
 (5-pin cable socket,
 712 series subminiature round plug connector)

Pin assignment:

Switching contact between pin 1 and pin 5.

Maximum permitted electrical characteristic values of the integrated interlock switch:

$U_{max} = 40 \text{ V DC}$
 $I_{max} = 0.2 \text{ A}$

3.3.2 Screwed-on filter turret cover

As a safety precaution on laser microscope systems, the fluorescent turret disk cover is secured using 2

DIN 912 M4x6 lens head Allen screws.
(Order No. 11 703 121 630 000)



Store the screws in a safe place. Never operate the microscope when the cover is not screwed into place!

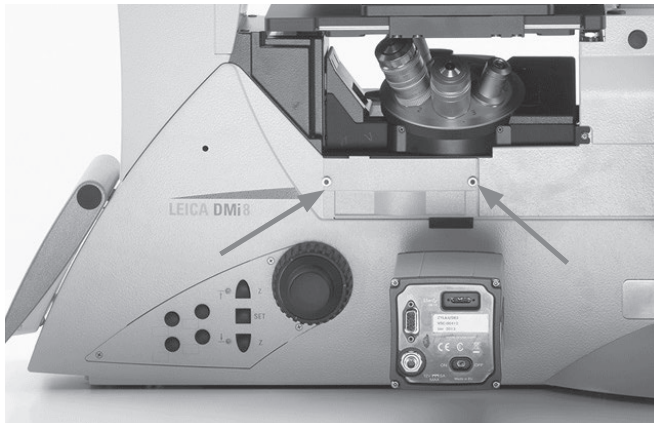

Turn the screws to secure the filter turret cover

3.3.3 Laser coupling by the user

Because of a danger for the user due to laser radiation, the Leica DMI8 microscopes in the standard version are not suitable without additional laser safety measures for coupling laser radiation¹⁾.

If you are, however, modifying a microscope and couple a laser beam into it, as the user, you assume responsibility as the manufacturer of the complete system.

We do not make provisions for your interference with the device and, therefore, you are fully responsible for the modifications regarding the adherence to basic safety requirements and laser protective measures set forth by the European Union guidelines and by the national legal and technical directives and standards.

If you modify your microscope by coupling a laser beam without authorization, when determining and implementing laser safety measures, also take note of the subsequently described hazards at the microscope, as here the danger exists of serious and irreversible eye damage and skin injuries!



Danger of serious and irreversible eye damage from laser radiation!

Radiation of the eye or skin from direct or indirect laser radiation has to be avoided by all means! The laser light can cause serious eye damage and skin damage!

1) Laser radiation of Class 1 lasers is exempt. Further details regarding this topic in Section 3.3.4

3.3.3.1 Safety hazard due to folded back Transmitted Light arm

If you fold back the Transmitted Light arm, the laser radiation escaping from the lenses is beamed directly into the open space.



Important safety note

As a safety measure, we recommend the microscope models with integrated interlock connectors as mentioned in Section 3.3.3.7.



Folded back Transmitted Light arm; the light output out of the objective is not shadowed by the condenser base.

3.3.3.2 Safety hazard at eyepiece

The laser radiation that you coupled into the microscope can disperse from the eyepiece and directly hit the user's eye!



Important safety note

As a safety measure, we recommend the microscope models with integrated interlock connectors as mentioned in Section 3.3.3.7.



Eyepieces

3.3.3.3 Safety hazard in the condenser area during operation.

If you couple a high power laser beam into the microscope, the laser radiation, broadened by the lens, that passes the condenser laterally, can exceed the permitted limit values for eyes and skin.



Increased laser radiation can beam laterally past the condenser

3.3.3.4 Safety hazard above the condenser

The laser beam path between the condenser base and the illuminated field diaphragm is without obstruction.

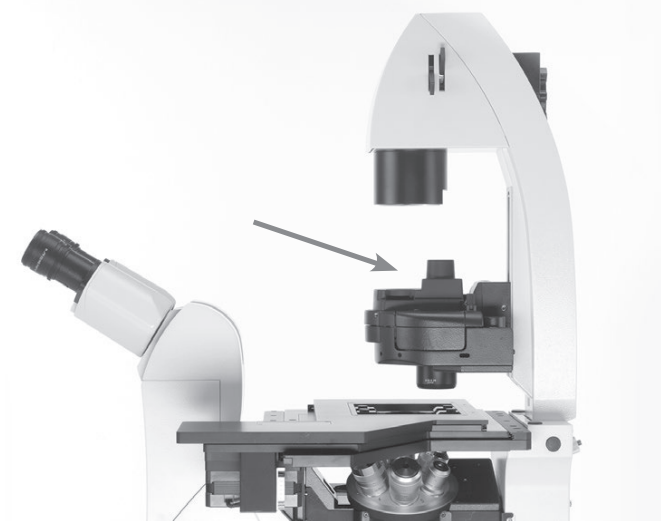

Laser beam path between condenser base and illuminated field diaphragm without obstruction

3.3.3.5 Safety hazard in the specimen area

The laser radiation is accessible without obstruction in the specimen area of the microscope!

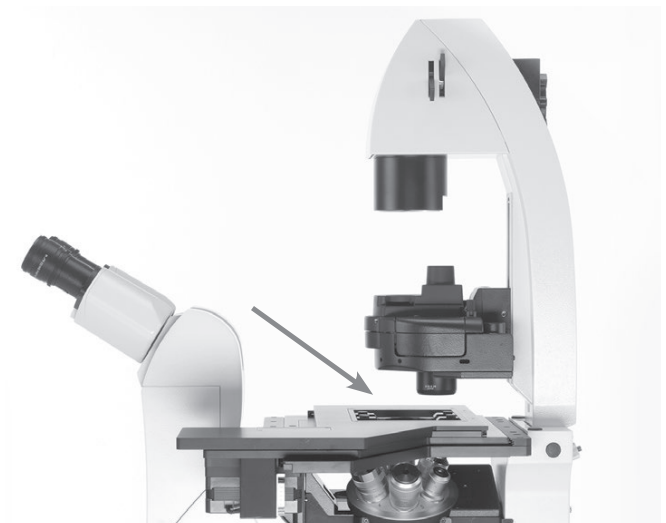

Specimen area

3.3.3.6 Safety hazard due to openings at microscope

Make sure, as part of your risk assessment, that all openings at the microscope are tightly sealed and can only be opened with tools to prevent laser radiation from escaping!

The openings to consider, for example: top port next to the eyepieces, left and right side port, bottom port, infinity port, connection for Transmitted Light lamp housing at the arm, lamp connection for fluorescence/connection for incident light lamp housing, cover for fluorescent turret disk.

The material that is used to seal off the openings has to be suitable for the intensity of the coupled laser beam.

Furthermore, the terminals that are not occupied by objectives have to be closed with caps at the objective nosepiece.

Openings at the stand that have to be tightly sealed

- a Cover for fluorescent turret disk
- b Transmitted Light lamp housing
- c Incident light lamp housing
- d Side port right
- e Bottom port
- f Side port, left
- g Objective nosepiece
- h Top port
- i Infinity port
- j Openings at objective nosepiece

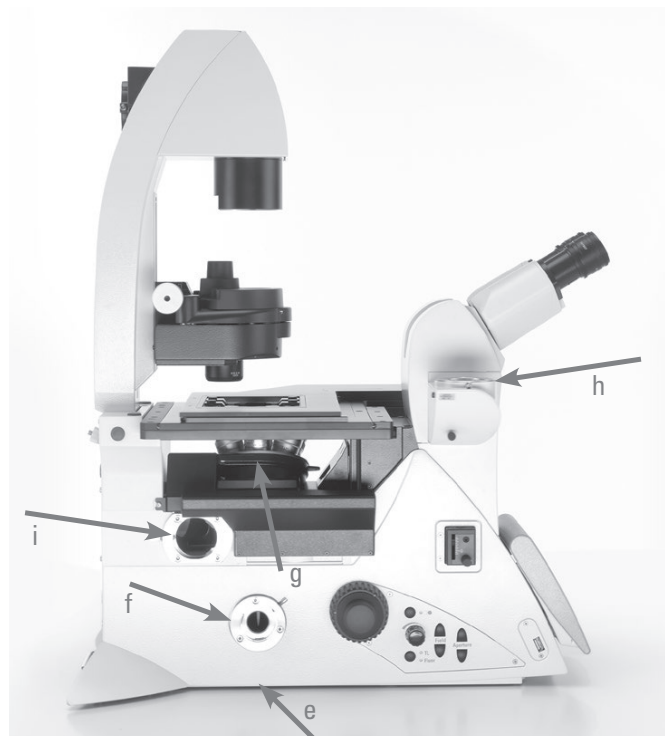
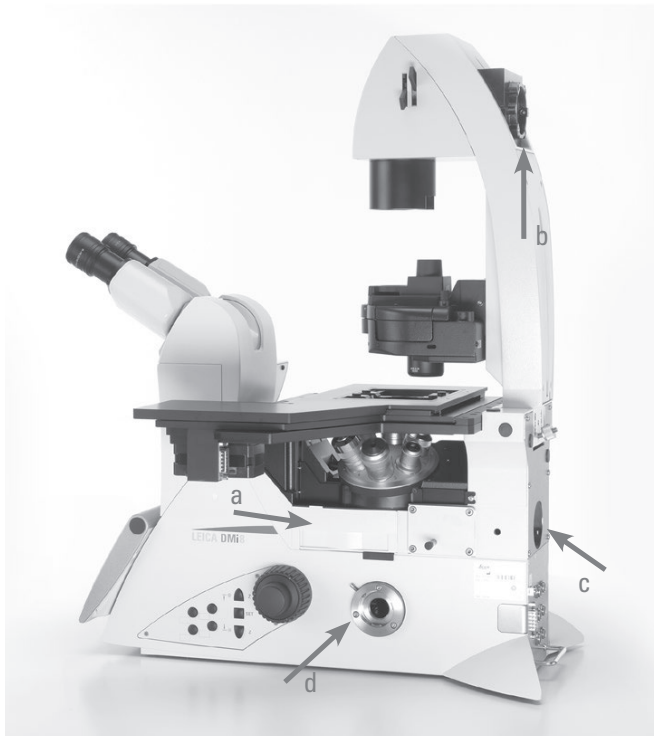

3.3.3.7 Note regarding the safety hazards in Sections 3.3.3.1 and Section 3.3.3.2



Important safety note

The overall responsibility for laser safety of the laser microscope system assembled by you remains with you as the responsible body, even if you use the microscopes from Leica Microsystems CMS GmbH listed below in conjunction. Within the context of your system composition and modifications, you have to verify whether the component selected by you from this chapter is effective and suitable for your laser protection concept.

We recommend that for your laser applications you use a microscope variant with the following selection options because the microscope is already equipped with interlock switches at the factory:

Leica No. 11889086
Laser Safety Kit

and also one of the following options:

Leica No. 11889077
Left motorized side port, 100% and interlock

Leica No. 11889078
Right motorized side port, 100% and interlock

Leica No. 11889079
Right/left motorized side port, 100% and interlock

Leica No. 11889087
Manual side port (100/0), Int.

Leica No. 11889088
Left manual side port (100/0)



Note:

The fixed Transmitted Light arm (order No. 11525105 (with short cable) or order No. 11525116 (with long cable) is not suitable for laser applications and therefore is not provided for these applications.

a) Safety function for the safety hazard mentioned in Section 3.3.3.1.

The special microscope variants have a built-in interlock switch on the Transmitted Light arm that is activated when folding back the Transmitted Light arm (interlock switch opens).

The interlock connector of the microscope must be connected to your laser beam interrupter, which interrupts the laser beam coupled into the microscope when opening the interlock switch or folding back the illumination arm.

b) Safety function for the safety hazard mentioned in Section 3.3.3.2.

An additional interlock switch is also installed in the microscope, which is activated (interlock switch opens) when the beam path to the eyepiece is released.

The interlock switch of the microscope must be connected to your laser beam interrupter, which interrupts the laser beam coupled into the microscope when opening the interlock switch or releasing the beam path towards the eyepiece.

Please note that the laser radiation may not be coupled via the bottom port!

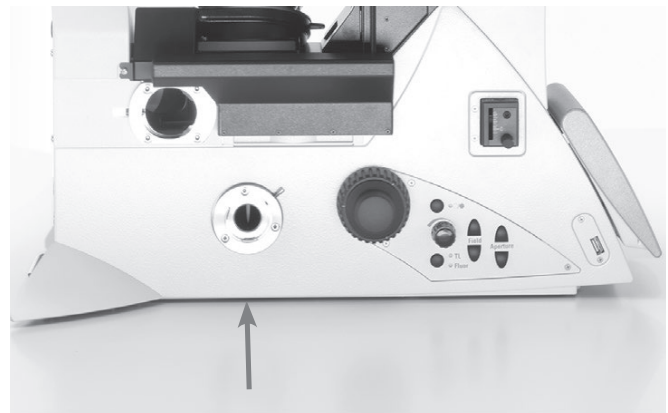

Bottom port

Both interlock switches a) and b) are routed to a shared interlock connector on the microscope; you have to connect your laser beam interrupter to this connector.

When doing so, note the electrical characteristic values of the integrated interlock switches in the microscope. You must not exceed these values by connecting a laser beam interrupter, as otherwise the interlock switches will be damaged and no longer function safely and reliably:

Maximum permitted electrical characteristic values of the integrated interlock switch:

$U_{\max} = 40 \text{ V DC}$

$I_{\max} = 0.2 \text{ A}$

The integrated interlock switches in the microscope and their wiring with a laser beam interrupter/laser ensure that the laser radiation you coupled into the microscope cannot get into the user's eyes through the eyepieces.

3.3.4. Exception for Class 1 lasers

Coupling a laser of Class 1 in accordance with IEC/EN 60825-1 into a microscope does not result in any danger to the user.

The listed safety hazards apply only for lasers of Class 1M, 2, 2M, 3R, 3B and 4.

Note that the rules and regulations of the United States FDA 21CFR1040.10 Class I (CFR – Code of Federal Regulation Title 21, revised as of April 1, 2011) do not distinguish between Class 1 and 1M. Thus the statement that there are no safety hazards on the microscope do not apply for the laser classification in accordance with FDA Class 1.



Important safety note

In addition, observe the safety hazards described in Section 3.3.3.3 to 3.3.3.6!

3.5 Storage and transport

Transport



Caution!

Transport and storage at -20 °C – +85 °C and max. 90% humidity.

For shipping or transporting the microscope and its accessory components, the original packaging should be used.

As a precaution to prevent damage from vibrations, the following components should be disassembled and packaged separately:

- Unscrew the objectives.
- Secure the objective nosepiece, e.g. with adhesive tape.
- Remove the eyepieces.
- Remove the condenser.
- Remove the specimen stage.
- Remove the Transmitted Light arm.
- Remove the lamp housings.
- Secure the magnetic fluorescent turret cover e.g. with adhesive tape.
- Remove all moving or loose parts
- Protect the microscope from dust and dirt using a plastic bag.

Weight



At a full load, the microscope weighs more than 18 kg. The user must take corresponding precautions for transporting the instrument.



Caution!

For transport, always remove all components listed under "Transport!".

3.6 Ambient conditions



Caution!

This microscope may not be used at elevations over 2000 m above sea level.



Caution!

Do not use this instrument near sources of high electromagnetic radiation (for example, unshielded, intentionally operated ultra-high frequency sources), because these can disrupt proper operation.

We recommend assessing the electromagnetic environment before operation of this instrument and then giving corresponding instructions.

Installation location

Work with the microscope should be performed in a dust-free room, which is free of oil vapors, other chemical vapors and extreme humidity. At the workstation, large temperature fluctuations, direct sunlight and vibrations should be avoided. These conditions can distort measurements and longer microscopic scans.

Permitted ambient conditions:

Temperature	15–35°C ⁺⁾
Relative humidity	maximum 90% up to 30°C non-condensing

Microscopes in warm and warm-damp climatic zones require special care in order to prevent fungus contamination. For additional instructions, see the chapter on "Care of the Microscope" → S. 89



Caution!

The microscope must be set up so that the power voltage input is not obstructed and the instrument can quickly be removed from the power supply if necessary.



Caution!

Electrical components must be placed at least 10 cm away from the wall and from flammable substances.

3.7 Notes on handling light sources



Light sources pose a potential irradiation risk (glare, UV radiation, IR radiation). Therefore, lamps may only be operated in closed housing and in an installed condition. Never look directly into the beam path (blinding hazard).



Do not switch on the light source until the light guide is connected to the microscope. Uncontrolled light output from the light guide poses a blinding hazard! There is also a burn hazard at the light guide output!



Make sure to follow the safety notes in the operating manual for the light source.



Switch on the light source only if it is firmly connected to the microscope. Uncontrolled light output poses a blinding hazard!



Do not look into the eyepieces when toggling the contrast method! During the toggling procedure, the maximum radiant power of the light source may be present on the eyepieces for a short time and can cause blindness in the user!

⁺⁾ Up to 40°C in microscope climate chambers sold by Leica Microsystems GmbH



CAUTION

Lamps and lamp housing may be hot!
They must be placed at least 10 cm away from the wall and away from flammable substances.
Supply and data lines in particular may not come into contact with lamp housings!

3.8 Notes on handling the Touch Screen



Caution!

Touch the touch screen using your finger only. Never use a pen or other hard, sharp or pointed objects.

3.9 Notes on handling immersion oil



Caution!

When using immersion oil, take care to avoid skin contact! Ask the supplier for a safety data sheet!

3.10 Notes on handling acids and bases

For examinations using acids or other aggressive chemicals, particular caution must be taken.



Caution!

Be absolutely certain to avoid direct contact with these chemicals.

3.11 Disposal

Once the product has reached the end of its service life, please contact Leica Microsystems GmbH Service or Sales about disposal.

Please observe and comply with the national and federal laws and regulations that are equivalent to EC directives such as WEEE.



Note!

Like all electronic devices, the microscope, its accessory components and consumables must never be disposed of with general household waste.

4. Leica DMI8 configurations instrument overview

4.1 Microscope configurations (examples)



Leica DMI8 with manual components
With a fixed Transmitted Light arm



Leica DMI8 with manual components
With a tiltable Transmitted Light arm



Leica DMI8 with encoded components



Leica DMI8 with at least one motorized component

4.2 Dimensions (specified in mm)

Leica CTR compact

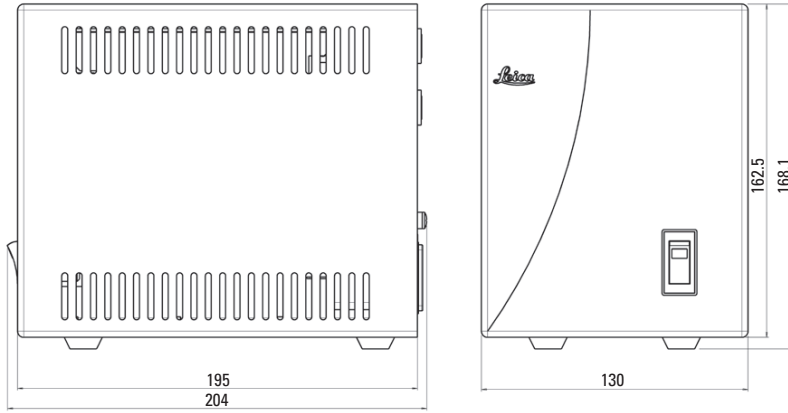

Weight: approx. 2 kg

Leica CTR Advanced/Advanced+

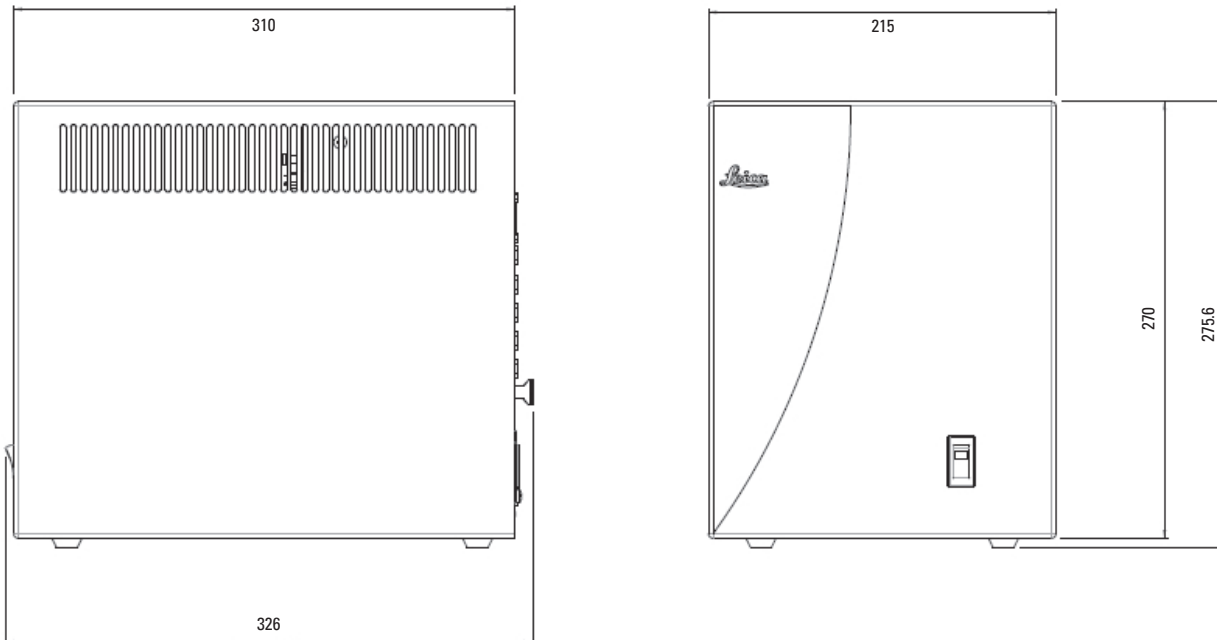

Weight: approx. 4 kg

Leica DMi8 (with tiltable Transmitted Light arm)

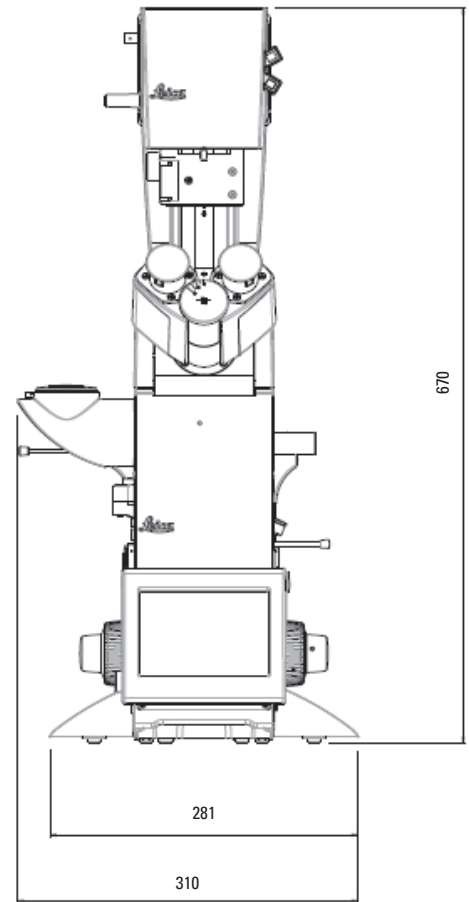
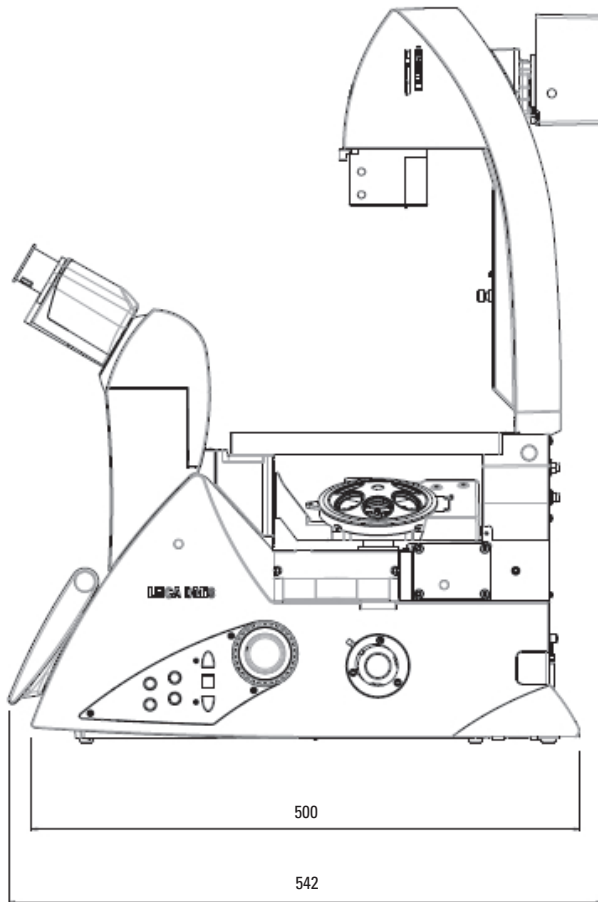

Weight: approx. 19 kg

Height compensation plate*

In order to enlarge the viewing height by 23 mm, raise the side camera ports for very large cameras or spinning disks, or to use a microscope with an inactive bottom port even without a hole in the work table, a height compensation plate (order No. 11525200) was developed.

4.3 Specifications⁺⁾

<p>Contrast methods</p>	<p><u>Leica DMI8 series - depending on Transmitted Light arm</u></p> <ul style="list-style-type: none"> • Transmitted Light (TL): BF, DF, PH, DIC, Pol • Intermediate eyepoint: IMC (Integrated Modulation Contrast) IPH (Integrated Phase Contrast) • Incident light (IL): Fluo <p><u>Leica DMI8 with motorized condenser and motorized fluorescence</u></p> <ul style="list-style-type: none"> • Combination (TL/IL): Fluo/DIC, Fluo/PH
<p>Transmitted Light arm</p>	<p><u>Tiltable Transmitted Light arm</u></p> <ul style="list-style-type: none"> • Manual and encoded • With integrated mechanical tilting mechanism with sufficient room for specimens and micromanipulators • For ≤ S40 condensor with an integrated manual or motorized illuminated field diaphragm • Filter magazine for 2 replaceable filters • With condenser quick change • Manual shutter • Lamp housing receptacle for replaceable LEDs • With integrated cable duct • Condensor stop (to prevent from being pushed down accidentally) <p>or</p> <p><u>Fixed Transmitted Light arm</u></p> <ul style="list-style-type: none"> • With integrated LED illumination • Manual adjustment of brightness and aperture diaphragm • Automatic brightness adjustment when changing the contrast method • Automatic shutoff (adjustable) • Integrated condenser holder • Receptacle for Transmitted Light filter

⁺⁾ Depending on configuration

<p>Fluorescence axis</p>	<p><u>Manual, external</u></p> <ul style="list-style-type: none"> • Manual shutter • Manual field and aperture diaphragm • Receptacle for light guide • Receptacle for EFW (external filter wheel) • Receptacle for structured illumination (Optigrid) • Manual fluorescence intensity manager (FIM) (Reduces the light intensity of the incident light illumination) <p>or</p> <p><u>Manually integrated</u></p> <ul style="list-style-type: none"> • Manual shutter • Manual field and aperture diaphragm • Receptacle for light guide • Lamp housing receptacle for external lamp housing • Manual fluorescence intensity manager (FIM) (Reduction of light intensity from the incident light illumination) <p>or</p> <p><u>Motorized</u></p> <ul style="list-style-type: none"> • Motorized field and aperture diaphragm • Motorized shutter via FIM • Receptacle for light guide adapter • Motorized fluorescence intensity manager (FIM) (Reduction of light intensity from the incident light illumination)
<p>Infinity port and T-Houses</p>	<ul style="list-style-type: none"> • With a mirror for switching between the left or right and the rear ports <p>or</p> <ul style="list-style-type: none"> • With prism <p>With 2 possible positions:</p> <ul style="list-style-type: none"> 50% rear port/50% left/right port 80% rear port/20% left/right port 100% rear port/0% left/right port <p>Additional T-Houses:</p> <ol style="list-style-type: none"> 1. No fluorescence, holder for Transmitted Light arm 2. One infinity port aperture in the rear 3. Special with integrated fluorescence 4. Special port for TIRF/GSD
<p>Fluorescence nosepiece disk</p>	<ul style="list-style-type: none"> • 6-position • Encoded manually or electronically with color-coded ring <p>or</p> <ul style="list-style-type: none"> • motorized
<p>Tube</p>	<ul style="list-style-type: none"> • Ergonomic with or without photo output on the left side • 2 switching positions: 100% VIS and 50%VIS/50%CAM or • 2 switching positions: 100% VIS and 0%VIS/100%CAM • Optional with Bertrand lens • Interpupillary distance control • Height and angle adjustment (30° - 45°)

Magnification Changer	<p><u>Motorized</u></p> <ul style="list-style-type: none"> • 2 or 3 switch positions Magnification factors 1x; 1.6x; 2x or 1x; 1.6x or 1x; 2x • Works on all camera ports and eyepieces <p>or</p> <p><u>Manual</u></p> <ul style="list-style-type: none"> • 2 switch positions Magnification factors 1x; 1.6x • Works on the tube port and eyepieces
Objective turret	<p><u>motorized</u></p> <ul style="list-style-type: none"> • 6-position for objectives with M25 threads and a 45mm parfocalizing distance • For DIC: motorized or manual/encoded Wollaston prism turntable • With splash protection <p>or</p> <p><u>encoded</u></p> <ul style="list-style-type: none"> • 6-position for objectives with M25 threads and a 45mm parfocalizing distance • For DIC: motorized or manual/encoded Wollaston prism turntables <p>or</p> <p><u>Manual</u></p> <ul style="list-style-type: none"> • 6-position for objectives with M25 threads and a 45mm parfocalizing distance • For DIC: manual Wollaston prism turntable
Stages	<ul style="list-style-type: none"> • Fixed stages • Stage plate coated in ceramic (248 mm x 204 mm) <ul style="list-style-type: none"> • Heated stage plate (3°C above room temperature up to 60°C) (248 x 212 mm) • Temperature-adjustable stage plate (0°C to 60°C) (248 mm x 212 mm) • Fixed micromanipulation stages <ul style="list-style-type: none"> • Stage plate coated in ceramic (248 mm x 204/122 mm) • Heated stage plate (3°C above room temperature up to 60°C) (248 mm x 204/122 mm) • Temperature-adjustable stage plate (0°C to 60°C) (248 mm x 204/122 mm) • Manual and motorized 3-plate cross-stage <ul style="list-style-type: none"> • Travel range: 83 mm x 127 mm • Optional inserts (normal, heatable and coolable) for diverse applications, Size of inserts: 160 mm x 110 mm (compatible with scanning stages) • Scanning stage <ul style="list-style-type: none"> • Optional inserts (normal, heatable and coolable) for diverse applications, Size of inserts: 160 mm x 110 mm • LMT 200 linear motorized stage

Condensers	<p><u>For tiltable Transmitted Light arms:</u></p> <ul style="list-style-type: none"> • Motorized and encoded or manual and encoded • Motorized or manual aperture diaphragm • Contrast method: BF, DF, PH, DIC, Pol, IMC, IPH • Automatic method toggling • Condenser disk with 5 or 7 positions for contrast methods • 2 condenser housings (S1–S28 and S40, S70) • Condenser heads: S1/1.4 oil, S1/0.9 dry, S23/0.53, S28/0.55, S40/0.40 • Condenser heads can be swung out • All condensers for magnifications of 2.5x to 100x • With or without motorized or manual polarizer (optional) • With motorized or encoded Wollaston prism disk (optional) <p><u>For the fixed Transmitted Light arm</u></p> <ul style="list-style-type: none"> • S40/0.50 condenser • S80/0.30 condenser
Z-focus	<p><u>Leica DMI8 motorized</u></p> <ul style="list-style-type: none"> • Motorized and encoded • 12 mm travel path (2mm below, 10 mm above the stage) • Maximum travel speed: 5mm/s • 5 focus increments: 0.05 μm; 0.1 μm; 0.7 μm; 1.5 μm; 5.0 μm • Electronic focus repositioning • Automatic lowering before objective change • Electronic parfocality • Optional: Adaptive Focus Control (AFC) • Optional: Closed Loop (repositioning ability ≤ 20 nm) • Handwheels, each with 2 increments for coarse and fine focusing (4 increments) <p><u>Leica DMI8 manual</u></p> <ul style="list-style-type: none"> • Manual • 12 mm travel path (2mm below, 10 mm above the stage) • Handwheels, each with 1 increment for coarse and fine focusing (2 increments)
Observation ports	<p><u>Leica DMI8 motorized</u></p> <ul style="list-style-type: none"> • Motorized and encoded • Left side ports (100%, 80% or 50% transmission) • Optional: Right side ports (100%, 80% or 50% transmission) • Optional: Bottom port • Optional: Top port with 2 switch positions <ul style="list-style-type: none"> • 100% to the eyepieces • 50% to the eyepieces/50% to the port <p><u>Leica DMI8 manual</u></p> <ul style="list-style-type: none"> • Manual • Left side port (80% or 100% transmission) • Optional: Top port with 2 switch positions <ul style="list-style-type: none"> • 100% to the eyepieces • 50% to the eyepieces/50% to the port

Controls	Depending on level of motorization <ul style="list-style-type: none"> • Touch Screen (only for motorized Leica DMI8) • Button for TL/Fluor toggling • 2 buttons for motorized aperture diaphragm adjustment • 2 buttons for motorized illuminated field diaphragm adjustment • 1 button for operating the motorized shutter • 4 variable function keys • 3 operating buttons for focus thresholds (only for electronic focusing) • 2 handwheels for focusing • Rotary knob for setting the brightness • 6 buttons for fluorescence cubes • 6 buttons for objectives • Leica SmartMove: ergonomic control element for monitoring x,y,z and 4 additional variable function keys • Leica STP4000: operation via external Touch Screen • Leica STP8000: operation via Touch Screen using control element for monitoring x,y,z and additional variable function keys • Switch rods for operating the port, manual shutter and Magnification Changer • Slider for manual FIM, IMC and IPC adjustment • Switch rod for operating the infinity port
Electronics box	<ul style="list-style-type: none"> • Separate unit for controlling all motorized and electronic elements of the microscope Alternatively: <ul style="list-style-type: none"> • Leica CTR Compact • Leica CTR Advanced • Leica CTR Advanced (without power supply) • Leica CTR Advanced+
Interfaces	<ul style="list-style-type: none"> • Service port for saving/loading microscope settings via the Touch Screen <u>Leica DMI8 motorized</u> <ul style="list-style-type: none"> • 6 x I²C for external/internal peripheral devices • CTR boxes • 2 x interlock for laser applications

4.4 Controls

Depending on the configuration of your microscope, various controls are available to you. Accordingly, the control panel fields on the left and right sides of the stand contain a different number of buttons. However, the functions themselves are assigned to specific buttons.

The controls are displayed below using typical examples for the manual, encoded and fully automated microscope variant.

The Touch Screen is available as a control element on the Leica DMI8 with at least one motorized component.

The external controls are the Leica SmartMove control and the Leica STP4000 and Leica STP8000 control panels.

4.4.1 Control panel fields

Control panel field on the left microscope side

- 1 Motorized aperture diaphragm adjustment
- 2 Motorized illuminated field diaphragm adjustment
- 3 Motorized toggling between the TL/Fluor illumination axes

- 4 Adjusting the Transmitted Light brightness of the intensity levels for the automated FIM (fluorescence intensity manager)

An LED indicates the illumination method which is currently affected by the brightness adjustment.

- 5 Opening/closing the motorized shutter or during manual shutter light control

An LED displays the state of the shutter:

LED on = shutter opened

LED off = shutter closed.

- 6 Focusing

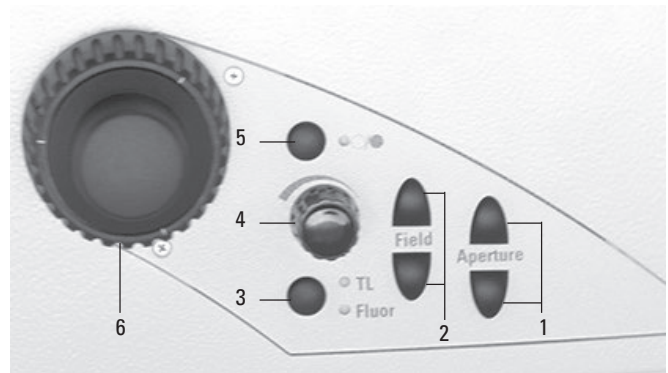

Maximum system design of the left control panel field
The number of buttons may vary depending on the configuration.

Control panel field on the right microscope side

- 1 Variable function keys (freely configurable)

The function keys are preassigned at the factory (see "Identification Sheet" and S. 92)

- 2 Focus threshold (the LED illuminates when the focus threshold is set)

- 3 Setting the focus position and focus threshold

- 4 Focus position (the LED illuminates when the focus position is set)

- 5 Focusing

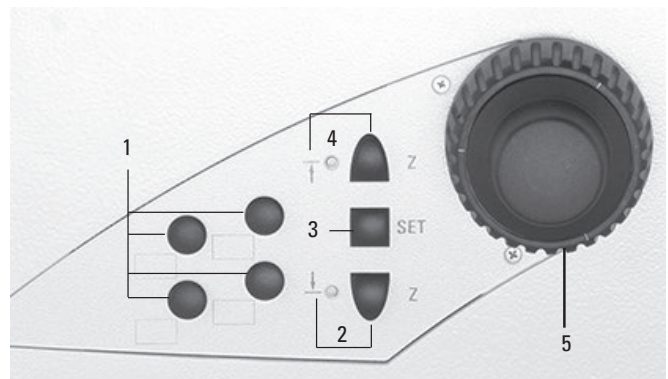

Maximum system design of the right control panel field
The number of buttons may vary depending on the configuration.

Control panel fields on the front side

Swiveling Touch Screen for adjusting all automated components on the Leica DMI8.

Adjustable angle for better readability.

Refer also to the chapter titled "The Touch Screen" S. 34



Encoded objective nosepiece

- 1 6 LEDs for indicating the current objective
- 2 Label fields ⁺⁾



Encoded objective nosepiece and encoded fluo turret

- 1 6 LEDs for indicating the filter cube
- 2 Label fields ⁺⁾
- 3 6 LEDs for indicating the current objective



Motorized objective nosepiece

- 1 6 objective changer buttons with LEDs for indicating the current objective
- 2 Label fields ⁺⁾



Motorized objective nosepiece and motorized fluo turret

- 1 6 filter cube changer buttons with LEDs for indicating the current filter
- 2 Label fields ⁺⁾
- 3 6 objective changer buttons with LEDs for indicating the current objective



⁺⁾ Stickers for labeling are included in the delivery package

4.4.2 Additional control elements

Left side of the Leica DMI8 with a fixed Transmitted Light arm

- 1 Filter receptacle
- 2 Aperture Diaphragm Adjustment
- 3 Stop lever for condenser height adjustment
- 4 IMC or light ring slide
- 5 Bertrand lens centering
- 6 Toggling the top port and Bertrand lens
- 7 Manual objective change
- 8 Left side port
- 9 Manual filter change
- 10 Focusing
- 11 Brightness adjustment
- 12 IMC module

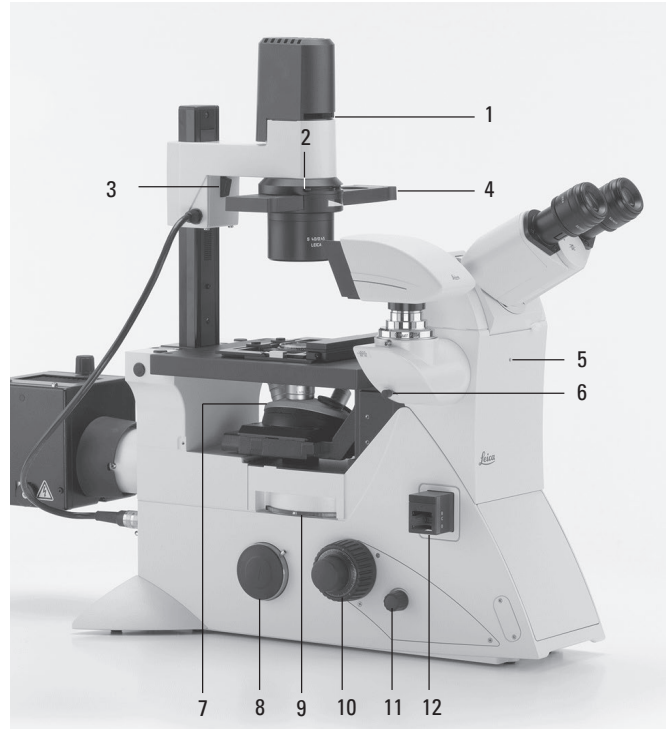

Left side of the Leica DMI8 with a tiltable Transmitted Light arm

- 1 Illuminated field diaphragm adjustment (motorized or manual)
- 2 Condenser height adjuster
- 3 Swinging in the polarizer
- 4 Aperture Diaphragm Adjustment
- 5 Condenser setting
- 6 Condenser height stop

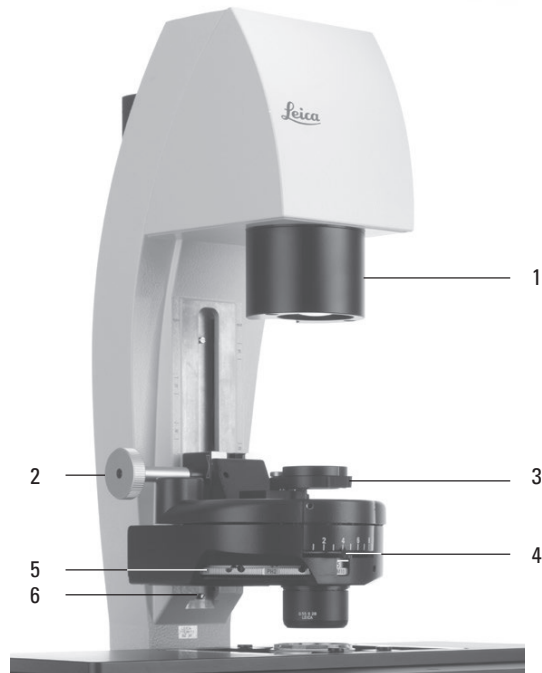

DIC setting

- 1 DIC fine adjustment
- 2 Selecting the objective prisms

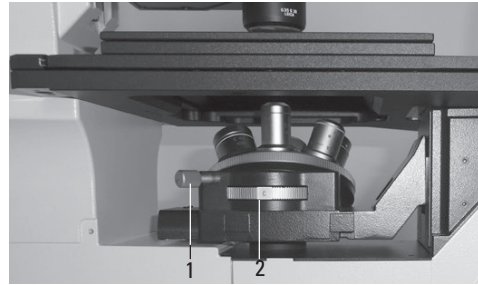

Manual DIC objective prism disk

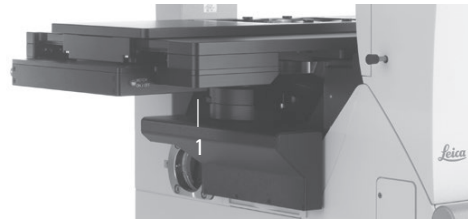

Motorized DIC objective prism disk

Right side of the Leica DMi8 with a tiltable Transmitted Light arm

- 1 Switching the Transmitted Light filter on and off

The front position is assigned at the factory using a shutter (dark stop), which is interchangeable with a filter.

- 2 Tube setting
- 3 Toggling the infinity port
- 4 Analyzer slot
- 5 Identification label
- 6 Right side port
- 7 Cover for fluorescent turret disk
- 8 Focusing
- 9 Focus thresholds
- 10 Variable function keys



Right side of Leica DMI8 with manual integrated fluorescence axis

- 1 Manual Magnification Changer
- 2 Focusing
- 3 Manual filter change
- 4 Receptacle for analyzer
- 5 Toggling the left side port
- 6 Stage movement
- 7 On/off switch (only on manual stands)
- 8 Illuminated field diaphragm adjustment
- 9 Manual setting for FIM
- 10 Centering illuminated field diaphragm
- 11 Manual shutter

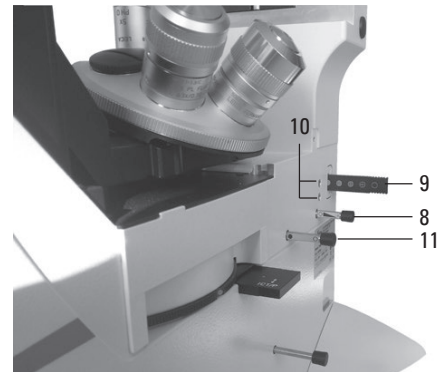

Section of manual integrated fluorescence axis

Manual external fluorescence axis

(Alternative connection on the left or rear microscope side)

- 1 Connection for light guide
- 2 FIM
- 3 Diaphragm module
- 4 Receptacle for EFW or structured illumination
- 5 Manual Shutter

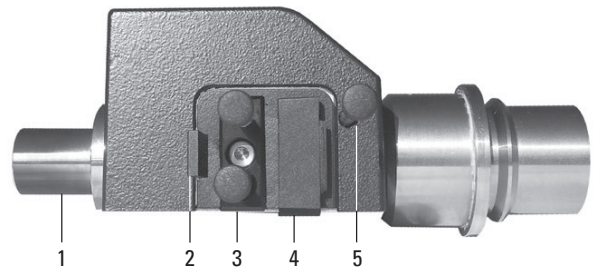

4.4.3 The Touch Screen

The Touch Screen adjusts all motorized components of the Leica DMI8 automatically via buttons. After the device is switched on, the display shows the current microscope status. The display and functions that can be operated using the Touch Screen depend on the features of the individual microscope.



The meanings of the most important pictograms are listed in the Appendix → S. 95

The display shows various levels of operation:

- Level 1: Navigation bar
- Level 2: Menu bar
- Level 3: Control panel field

When you select a pictogram in the navigation bar (on the left-hand border of the display), the corresponding menu bar (on the top border of the display) is shown. The display on the control panel changes accordingly. For some functions, an additional information field appears above the operating keys.

The navigation bar allows you to quickly move between navigation items:

-  **Basic microscope settings**
-  **Contrast methods**
-  **Magnification**
-  **Stage and focus controls**
-  **Optional**
-  **Touch screen settings**



Initialization

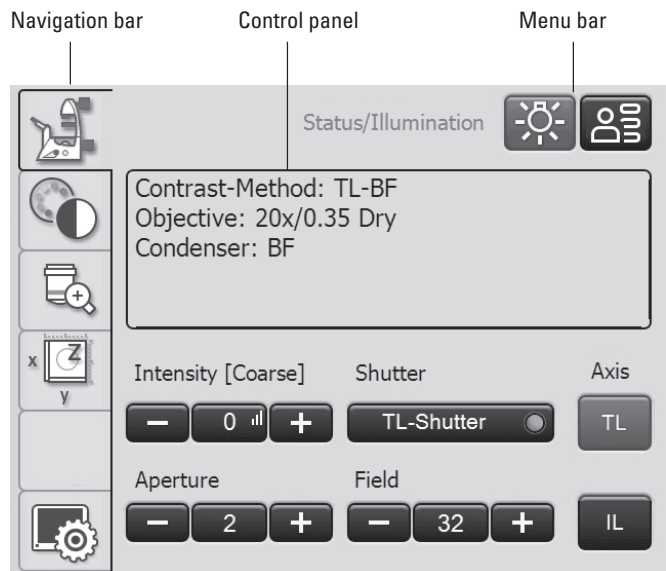



Touch Screen after initialization



Note:

Before working with the touch screen, we recommend calibrating it first.

Calibration

- Press the  button.
- Press the  button.
- Follow the instructions and press all 4 corners of the working area using your finger. Press and hold the calibration cross until the next cross is displayed. This adjusts the sensitivity of the Touch Screen and the pressure surface to the user.

Other Touch Screen settings:

Language selection

The current language for the display texts is shown, and you can change it by selecting the corresponding flag.

Saving the microscope settings

In Microscope Settings, press **Save** to write the current microscope settings to a USB stick, inserted into the left side of the microscope (Service port). Pressing **Load** restores all settings.

Display brightness

To prevent unwanted interference from light, you can switch off the display using the **Switch off** key. To switch it back on, simply touch any location on the display. You can also change the brightness incrementally using the **Brightness** key.

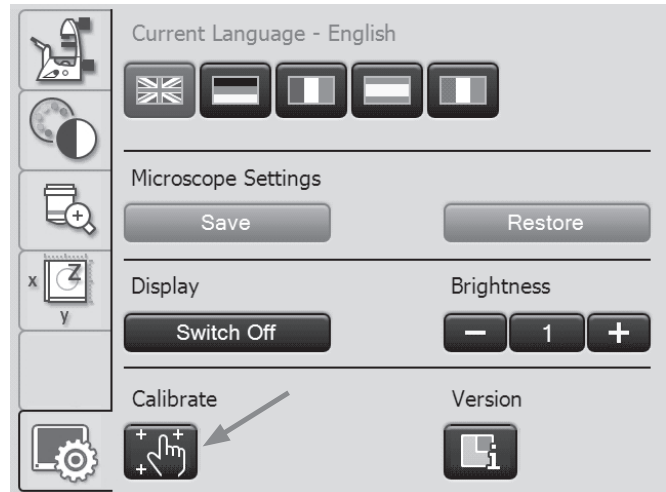

Version number



This key shows you the version number of the Touch Screen software and that of the master firmware of the connected microscope. Please have these available for any inquiries.



Note:

The meaning of the other menu items of the navigation bar is explained in the respective chapters.

4.4.4 The Leica SmartMove control element

Rotary knobs on the SmartMove

The rotary knobs 1 and 2 move the specimen stage in the x and y-direction.

The image is focused using the rotary knob 3.

You can adjust the height of the rotary knobs by turning the wheel 4 to a working height that is convenient for you.

Variable function keys on the SmartMove

The variable function keys are assigned functions at the factory that are appropriate to the features of your microscope. They are labeled accordingly. For details on key assignments, please refer to the included identification sheet. For information on the abbreviations used, please refer to the list → S. 94



Note:

The key assignment can be changed using the LAS X software.



Note:

To lock the controls, press and hold the two front keys (5) simultaneously for 5 seconds. Repeat this process to unlock the controls. The status LED (6) indicates whether the Leica SmartMove is in normal mode or locked mode.

Red LED = Entries blocked

Green LED = Normal mode

Leica SmartMove control

- 1 Movement in x-direction
- 2 Movement in y-direction
- 3 Focus setting
- 4 Individual setting of the knob height position
- 5 Variable function keys (preset at the factory)
- 6 Status LED

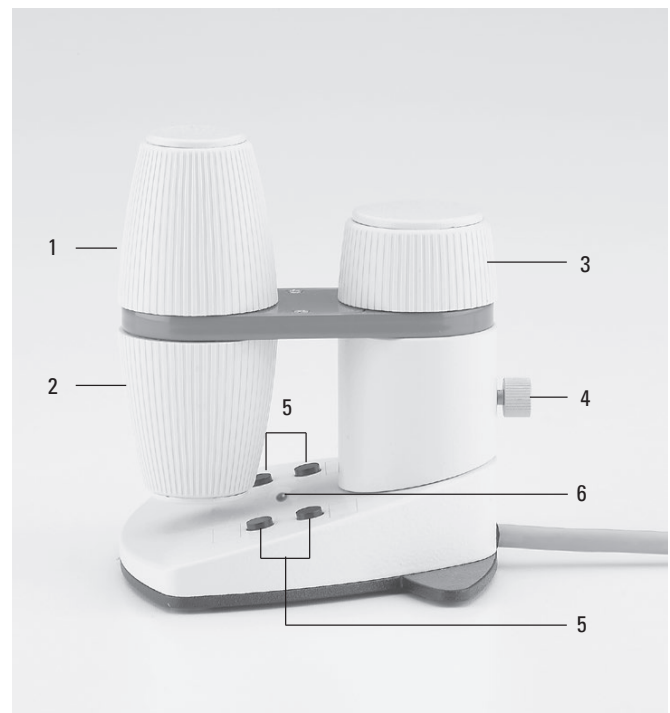

4.4.5 Leica STP4000/8000 external control panel

The Leica STP4000 enables remote control of all automated microscope functions using an external Touch Screen. The Leica STP8000 control panel also enables monitoring in X, Y and Z and has user-definable function keys.

Separate instructions are provided for operation of the Leica STP4000/8000.

Leica STP4000

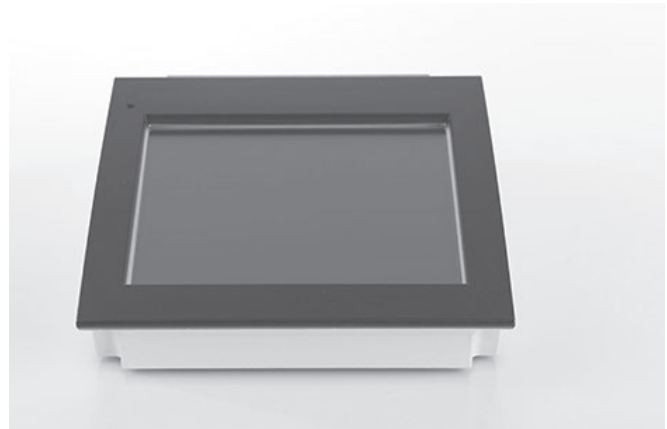

Controls of the Leica STP8000

- 1 Touch Screen
- 2 Information key
- 3,4 Variable function keys, user-programmable
- 5 Fine focus adjustment
- 6 Coarse focus adjustment
- 7 Movement in y-direction
- 8 Movement in x-direction

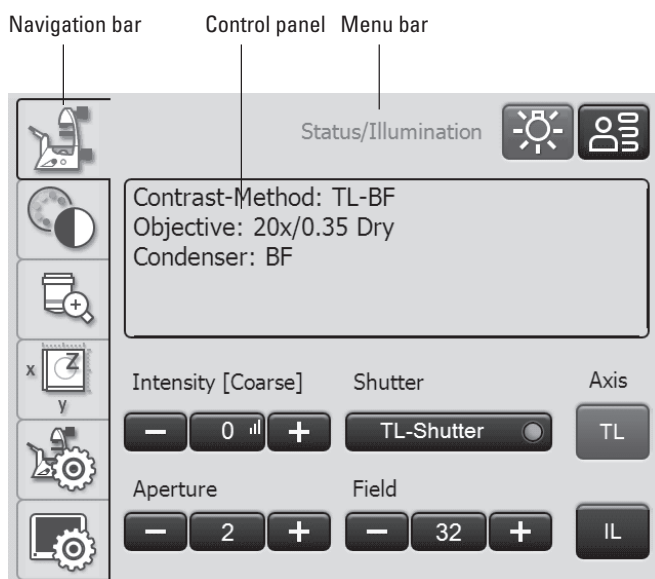

Touch Screen for STP4000/8000

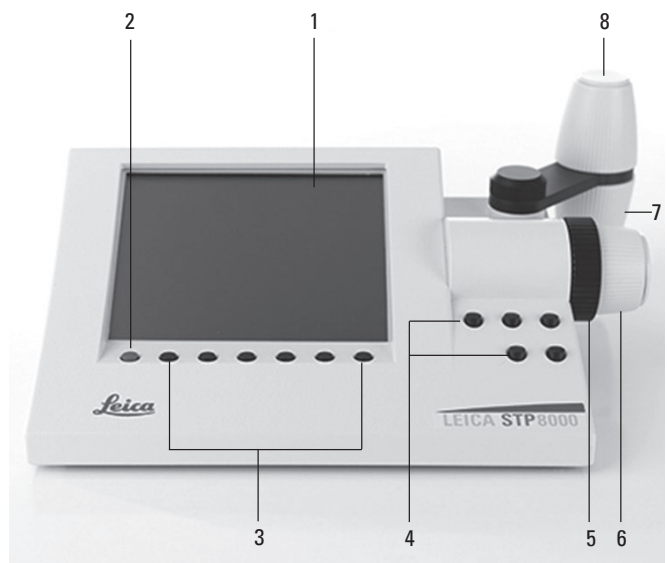

5. Operation



Caution!

The microscope may only be set up, installed and put into operation by authorized Leica personnel!



Caution!

The microscope may only be operated by personnel who have been instructed by an authorized Leica employee!



Note:

If at all possible, avoid touching optical surfaces such as the lens surfaces on the objective. If fingerprints do appear on the glass surfaces, remove them with a soft leather or linen cloth. Even small traces of finger perspiration can damage the surfaces in a short time. For additional instructions, see the chapter entitled "Care of the Instrument" → S. 89



Note:

Operating the motorized components using the Leica STP4000/8000 control panel is described in separate Instructions for Use.



Note:

For information about using the LAS X software, refer to the corresponding online help.

5.1 Switching on the microscope

Leica DMI8 without motorized components and without Leica CTR electronics box

- Switch on the microscope at the on/off switch on the right side of the stand. The indicator lamp is illuminated in green during operation.



Leica DMI8 with at least one motorized component and Leica CTR electronics box

- Switch on the electronics box on the on/off switch. The indicator lamp is illuminated in green during operation.



Note:

If you have connected a PC, switch on the **electronics box first**, and **then the computer**.

All motorized microscope components will then run through an initialization phase.



Note:

At initialization, all of the user's most recent settings are restored.



Caution:

The focus position and lower threshold are stored when switching off the microscope.

After the initialization is completed, the Touch Screen shows the status screen with the current microscope setting.

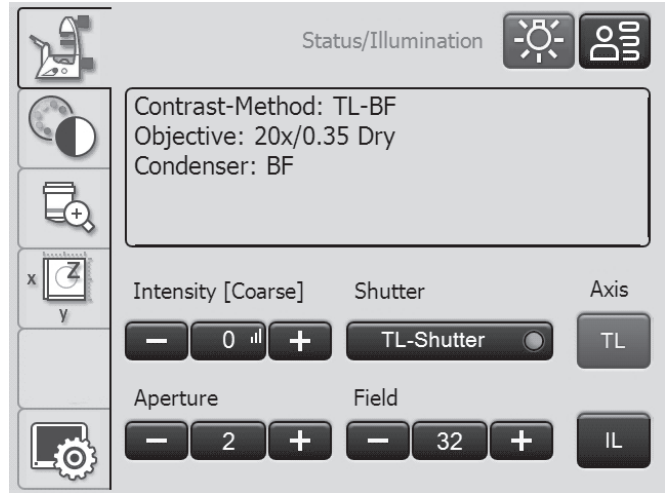

For fluorescence:

- Switch on the Leica EL6000 compact light source on the on/off switch. The indicator lamp is illuminated during operation.



Do not switch on the light source until the light guide is connected to the microscope.
 Uncontrolled light output from the light guide poses a blinding hazard!
 There is also a burn hazard at the light guide output!



Caution!

When using other light sources, observe the respective instructions for the light source.



5.2 Illumination



Caution!

When using other light sources than those described here, observe the respective instructions for the light source.

5.2.1 Transmitted Light

- If necessary, first switch over to the fluorescence axis (TL) by closing the shutter (push in the switch rod for the manual shutter or press the shutter button for motorized shutter).
- Set the light intensity using the knob on the left side of the stand.
- If the microscope has a manual shutter and a shutter button, the light is switched off when pressing the button. To switch it on again, press the rotary knob for the light intensity.

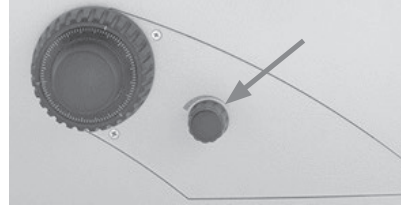

Leica DMi8 with automated fluorescence

- If necessary, switch to the Transmitted Light axis using the **TL/Fluor** key (TL).

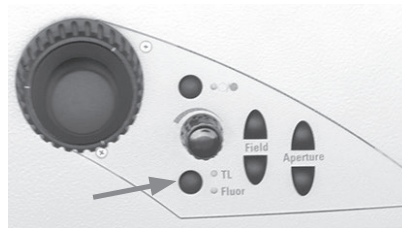

- Set the light intensity using the knob on the left side of the stand.

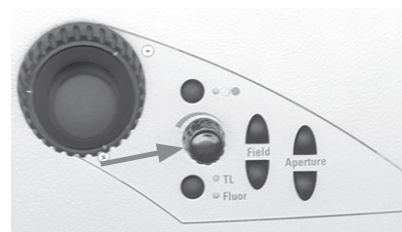

Adjusting the Transmitted Light brightness using the Touch Screen:

- If necessary, switch to the Transmitted Light axis (TL) using the **TL** key.
- Adjust the intensity using **+** and **-**.
The setting can be made in coarse and fine steps in a range from 0 to 255. Pressing the middle key, which also displays the current value, switches between coarse and fine adjustment.
- The intensity is individually adjusted and stored for each objective and contrast method.

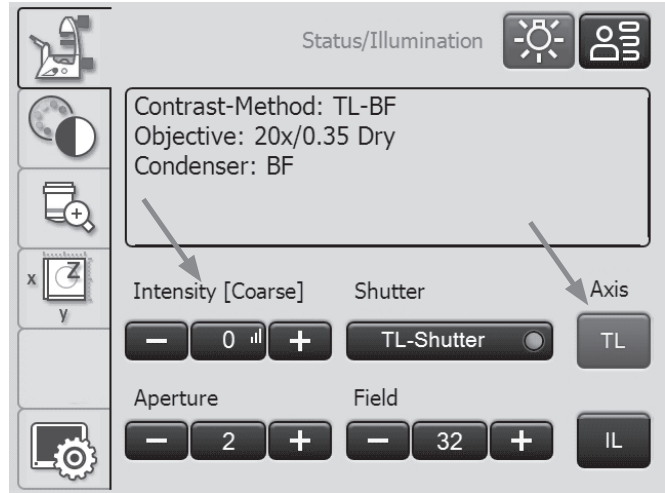

5.2.2 Fluorescence

Leica DMI8 with manual encoded fluorescence

- If necessary, first switch over to the fluorescence axis (Fluor) by opening the shutter (pull out switch rod at the manual integrated fluorescence axis or on the manual external fluorescence axis).
- Set the light intensity on the Leica EL6000 compact light source.
(See separate Instructions for Use).



Do not switch on the light source until the light guide is connected to the microscope.
Uncontrolled light output from the light guide poses a blinding hazard!
There is also a burn hazard at the light guide output!



- When using the Fluorescence Intensity Manager (FIM):
The brightness is adjusted in 5 defined increments (FIM) using a slider:
100% / 55% / 30% / 17% / 10%



Note:

If the Leica DMI8 is equipped with a 2 port infinity port (→ S. 44) switch over to the current port. → S. 58

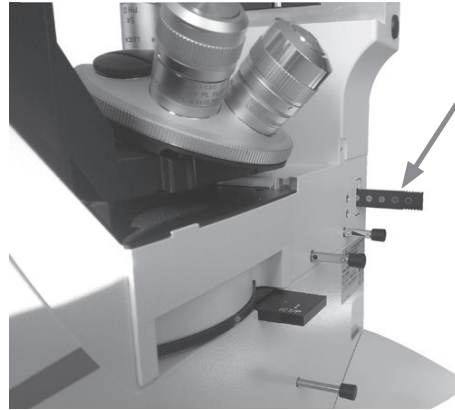

Manual integrated fluorescence axis



Manual external fluorescence axis

Leica DMI8 with motorized fluorescence

- If necessary, switch over to the fluorescence axis (Fluor) with the **TL/Fluor** button.

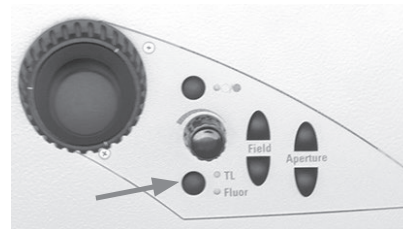

- Set the light intensity on the Leica EL6000 compact light source.
(See separate Instructions for Use).



CAUTION

Do not switch on the light source until the light guide is connected to the microscope.
Uncontrolled light output from the light guide poses a blinding hazard!
There is also a burn hazard at the light guide output!



- When using the Fluorescence Intensity Manager (FIM):
The brightness is adjusted in 5 defined increments on the brightness adjusting knob:
100% / 55% / 30% / 17% / 10%

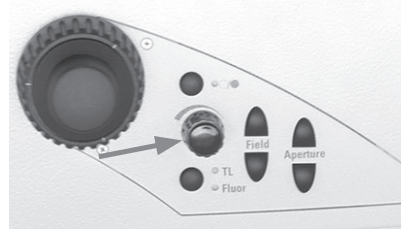

Setting the fluorescence using the Touch Screen:

- If necessary, switch over to the fluorescence axis (Fluor) with the **IL** button.
- When using the Fluorescence Intensity Manager (FIM):
The brightness is adjusted in 5 defined increments on the brightness adjusting knob:
100% / 55% / 30% / 17% / 10%

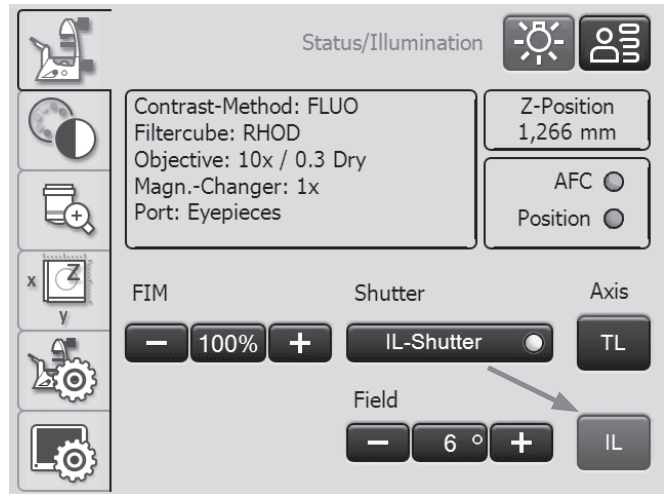

5.2.3 Infinity port

If the microscope is equipped with an infinity port, in addition to the rear output, there is another access to the fluorescence axis on the left/right side of the stand. The infinity port is equipped with a mirror or a prism.

Infinity port with mirror

- The infinity port slide bar on the right/left side of the stand guides 100% of the light to the rear output (mirror swung out) or 100% of the light to the left/right output (mirror swung in).

Infinity port with prism

- The infinity port slide bar on the right/left side of the stand guides 100% of the light to the rear output (prism swung out) or 50% of the light each to the rear and left/right output (mirror swung in).



5.2.4 Shutter

Leica DMi8 with manual shutter

- Open and close the manual shutter using the switch rod on the manually integrated fluorescence axis or using the switch rod on the manual external fluorescence axis.

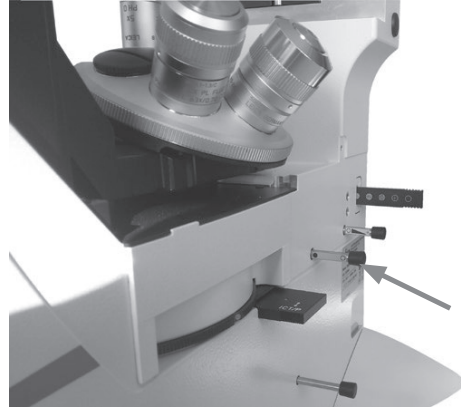

Manual integrated fluorescence axis

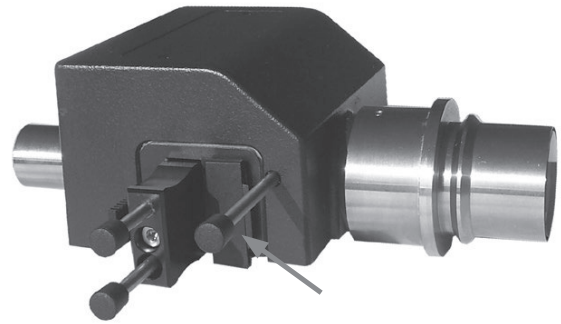

Manual external fluorescence axis

Leica DMi8 with motorized shutter

- Open or close the shutter using the shutter key on the left side of the stand.
This switches the active illumination axis (TL or Fluor) on or off.
When the shutter is open, the LED is illuminated.

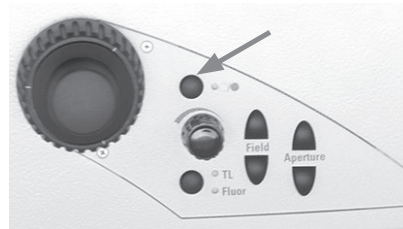

- Alternatively, the shutter can be operated using buttons on the Touch Screen.

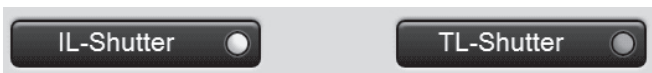

Gray = Shutter closed
Yellow = Shutter open

5.3 Objectives

! Caution:

If necessary, first lower the focus to prevent damaging the objective front lenses!

5.3.1 Changing objectives

Leica DMI8 with manual objective nosepiece

- Configure an objective by rotating the objective nosepiece on the knurled disk. During the manual objective change, be sure that the nosepiece locks into place.



Leica DMI8 with manually encoded objective nosepiece

- Configure an objective by rotating the objective nosepiece on the knurled disk. During the manual objective change, be sure that the nosepiece locks into place. The LED assigned to the selected objective on the front side of the microscope is illuminated.

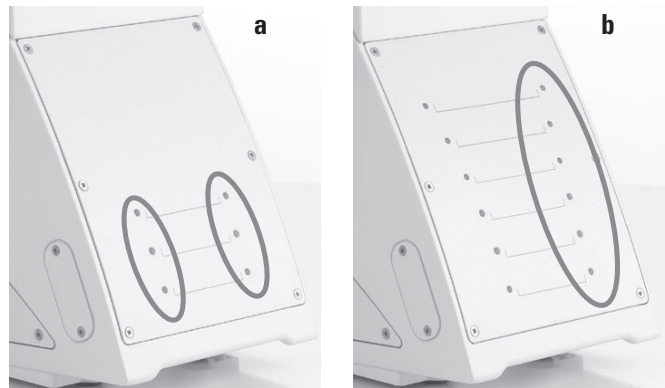

- a Keypad for encoded objective nosepiece
- b Keypad for encoded objective nosepiece and coded fluo turret

Leica DMI8 with motorized objective nosepiece and front operating panel with function keys

- Configure an objective by pressing the corresponding objective changer button on the keypad of the front side of the microscope. The LED of the objective changer button is illuminated.

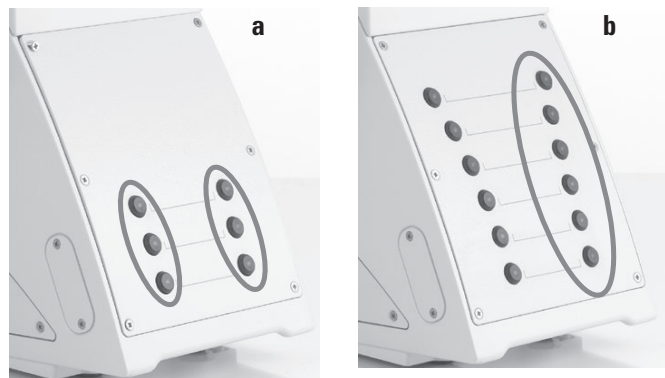

- a Keypad for motorized objective nosepiece
- b Keypad for motorized nosepiece and motorized fluo turret

Leica DMi8 - automated variants

The objectives can be swung into the beam path by motorized action using variable function keys on the stand or Leica SmartMove or using the Touch Screen.



Note:

The positions of the objectives in the objective turret have been specified at the factory and must be observed when installing the objectives. (See Installation Manual).

When selecting an objective, the microscope automatically selects:

- The most recently configured position of the illuminated field diaphragm
- The most recently configured position of the aperture diaphragm
- The most recently configured light intensity in the respective contrast method (with DIC fine adjustment where applicable)
- The most recently configured focus (including parfocality)

Adjusting the objectives using the Touch Screen:

- Use the  tab to switch to the Magnification menu.

The information field on the top edge of the screen shows the current total magnification at the specified observation port.



Pressing the  key allows you to switch between details for the various observation outputs.

The objective keys are labeled with the corresponding objective magnification. The objectives permitted for the selected contrast method are identified with a white triangle. Immersion objectives are also marked with drop symbol.

- To switch between objectives, press the corresponding key, which is then color-coded.

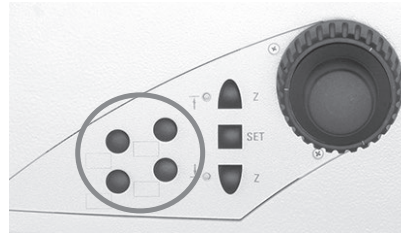

Function keys on the right side of microscope

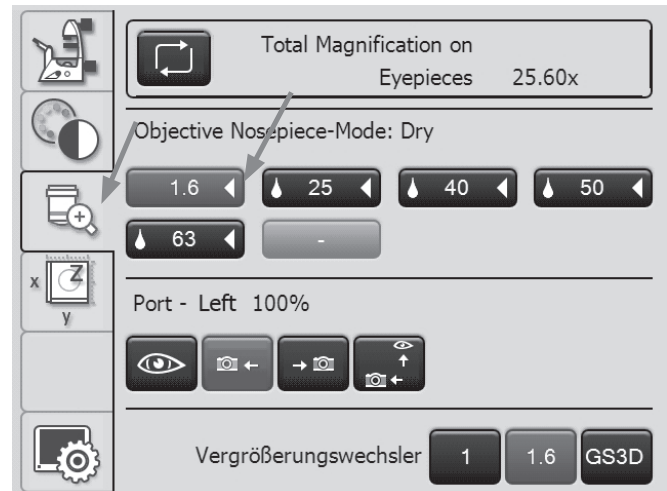

Immersion objectives

- For **immersion objectives** use the appropriate immersion medium.

OIL: Use optical immersion oil in accordance with DIN/ISO standards

only

Cleaning → S. 89

W: Water immersion

IMM: Universal objective for water, glycerin,
Oil immersion



Caution!

Follow safety data sheet for immersion oil!

- Select an immersion objective.
The objective nosepiece is lowered to the lower threshold. This makes it possible to apply the immersion fluid when switching from the dry objective to the immersion objective. Conversely, the immersion fluid can be removed.
The current objective remains in the beam path.
- Press the key for the desired immersion objective, which is now approached.



Note:

For lockable immersion objectives, press the front part upwards as far as it will go (approx. 2 mm). Then, after a gentle turning motion to the right, the objective is locked.

For objectives with a correction mount, adapt the objective to the thickness of the cover slip by turning the knurled knob.



Note:

If objectives are retrofitted, they have to be taught in using the LAS X software: Afterwards, the parfocality should also be taught in again.
See the instructions for the LAS X.

5.4 Tube

There are also Leica DMi8 without tube.



Note:

Close any unused tube openings, as otherwise stray light can interfere with observation.

Adjusting the interpupillary distance

- Adjust the viewing distance of the eyepiece tubes so that a congruent total image is seen.

Adjusting the viewing angle

- For the ergo tubes, the viewing angle can be adjusted from 30° to 45° by tilting the binocular eyepiece.



Beam splitting in photo tubes

The light division is set manually by pulling out a control bar.

	Observation(VIS)	Photo
<input type="checkbox"/> 100 %	100 %	0 %
<input type="checkbox"/> 0%	0%	100 %
Alternatively:	50%	50%
BL <input type="checkbox"/>	Activating the Bertrand lens*	

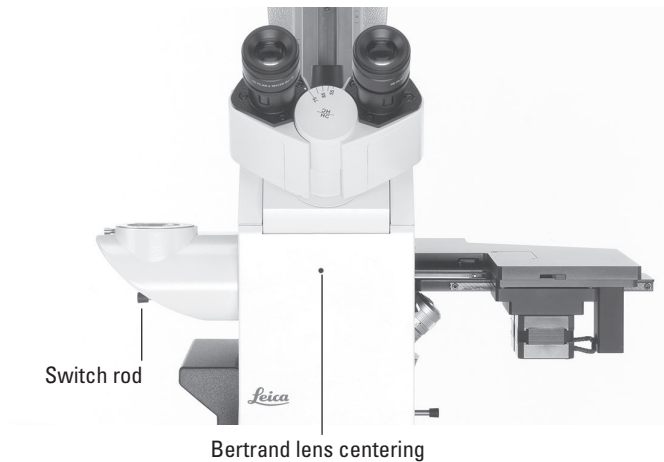

5.5 Eyepieces



Note:

The eyepiece's aperture protector must be removed or folded back during microscopy while wearing eyeglasses. We recommend removing bifocals and spectacles with progressive-addition lenses when using the microscope.

- For the adjustable tubes with documentation output, choose the 100% VIS position.

Eyepieces with inlaid graticule

- Focus the graticule by adjusting the eyelens in the eyepiece.
- Focus on the object through this eyepiece.
- Then, close that eye and focus on the object by adjusting the second ocular only.

Correction for vision problems

- With your right eye, look through the right eyepiece and bring the specimen into sharp focus.
- Then, with your left eye, view the same position of the specimen and rotate the left eyepiece tube until this position is brought into sharp focus. While doing so, do not change the adjustment of the z-position!



Note:

We recommend using the LAS X software to teach in eyepieces that are not included in the scope of delivery or are retrofitted. This ensures that the total magnification specified on the Touch Screen is correct. See the instructions for the LAS X.

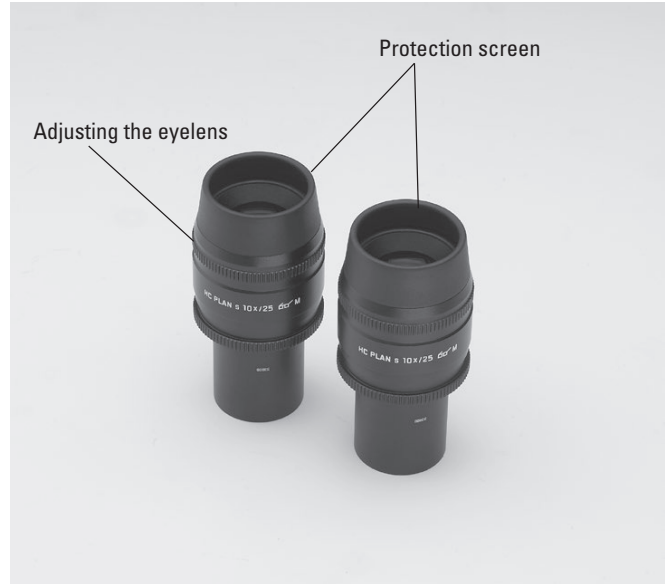

5.6 Stages and object displacement

A wide variety of stages is available in variants with fixed stage, manual and motorized 3-plate cross-stage and scanning stage with various mechanical stages and inserts.

The "Live on Stage" brochure provides an overview of the accessories for live cell microscopy including the various specimen stages, specimen holders and inserts.

You can download the brochure from <http://www.leica-microsystems.com/products/light-microscopes/accessories/environmental-equipment-for-inverted-microscopes/>.

5.6.1 Object displacement

Fixed stage

The object displacement is carried out manually by moving the specimen on the specimen stage or using the object guide.

Manual 3-plate cross-stage

The object displacement in the x- and y-direction takes place using a coaxial drive.

Motorized 3-plate cross-stage

Object displacement in the x- and y-direction can be performed by the Leica SmartMove control element, the Leica STP8000 main switch board or LAS X software.

Scanning stage/linear motorized stage

Also read the separately provided instruction manual.



Note:

When using other external stages, observe the respective instructions for the external stages.



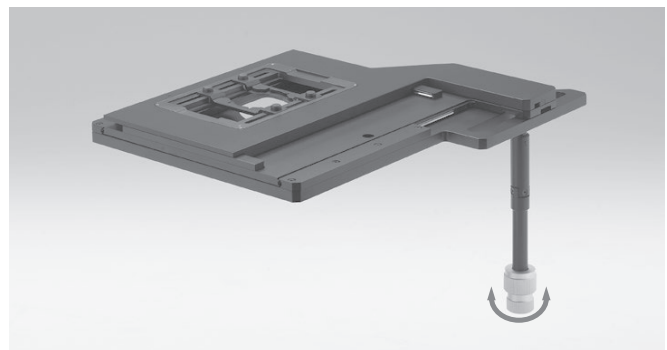

In spite of the low speed, there is a risk of pinching and crushing injuries when moving the scanning stage. Never put objects or body parts in the travel path!



Stage movement using Leica SmartMove

5.6.2 Adjusting the step sizes on motorized stages

- On the Touch Screen, use the  key to switch to stage and focus controls. The X/Y coordinates of the current stage position are displayed.
- Select the **Stage** menu using the  key.
- You can change the travel speed of the stage by switching between the **Coarse** and **Fine** step sizes. If the **Coarse** value is selected, the travel speed is the same for all objectives. The **Fine** value is adapted to the respective objective.

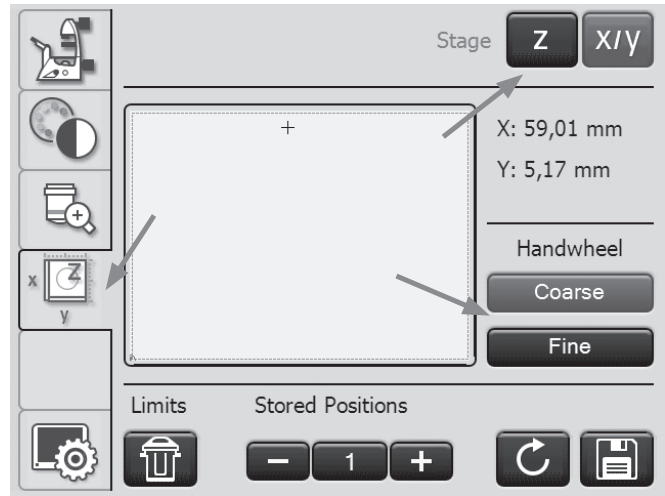

5.6.3 Saving and moving to stage positions

In the LAS X software, the programmed working area is marked by a dashed line frame.

You can reset the working area to the  maximum stage travel range via the **Limits** key.

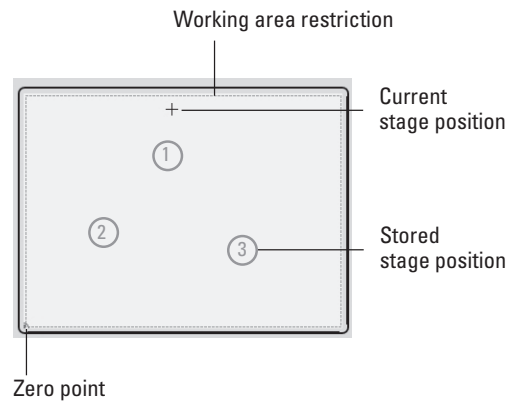

Up to 5 stage positions and one load position (L) can be stored.

- Selecting stored positions using the + and – keys

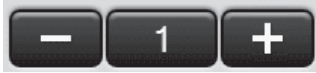

- Saving the current stage position under this number using the key



If a stage position was previously saved in this location, it will be overwritten.

- Moving to the current stored position using the  key
When driving to the load position, the objective nose-piece is raised to the lower threshold.



Note:

If a stored position is outside the travel range of the stage, for example as a result of subsequent changes to the travel range in the LAS software, you must restore the maximum

range of the stage via  **Limits** to reach the position.

The stored positions will be saved until the microscope is switched off and are deleted after a restart.

5.7 Focusing



Note:

If your microscope is equipped with a closed loop, this can be switched on and off using the LAS X software. See the instructions for the LAS X.

5.7.1 Focusing the image

Leica DMi8 manual focus

- Focus the image by turning the focus dials on the left and right sides of the stand.



Leica DMi8 with motorized focus/closed loop

- Focus the image using the rear rotary knob on the Leica SmartMove control element.
- Alternatively, the focus dials on the left and right sides of the stand can also be used.



Note:

For coarse and fine focusing with the handwheel, 2 focus stages each can be selected using the LAS X software.



5.7.2 Focus thresholds

Leica DMI8 with motorized focus/closed loop



Note:

The parfocality is taught in at the factory. As a result of screwing in the objectives during assembly, it might be necessary to teach in the parfocality again. We recommend checking the parfocality before setting the thresholds and, if necessary, teaching them in again using the LAS X software.



Note:

The focus position and stops are stored by the microscope and retained from one session to the next when power is switched off.

Setting thresholds

Lower focus threshold:

- Press the **SET** key and the key



When the threshold is set, the LED is illuminated. Pressing the same key combination again deletes the threshold.

The **lower threshold** is the same for all objectives and cannot be exceeded.

Focus position:

- Press the **SET** key and the key



When the focus position is set, the LED is illuminated. Pressing the same key combination again deletes the focus position.

The **focus position** cannot be exceeded. It should be defined for the dry objective with the highest magnification level. For all other objectives, it is set automatically, taking into account the parfocality adjustment and the working distance.

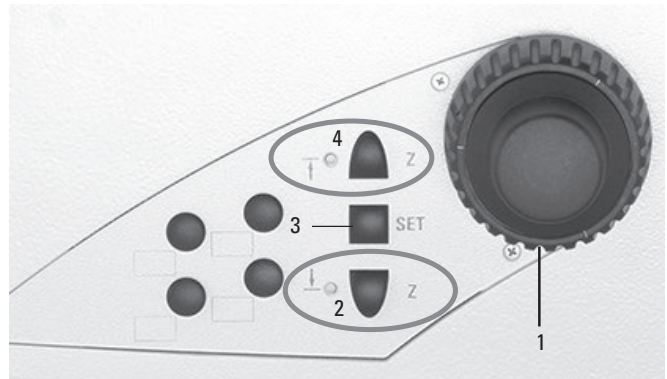

Right side of Leica DMI8 with motorized focus

- 1 Focusing
- 2 Focus stop
(the LED illuminates when focus threshold is set)
- 3 Setting the focus position and focus threshold
- 4 Focus position
(the LED illuminates when the focus position is set)

Moving to the thresholds

Lower focus threshold:

- Press and hold the key



Focus position:



Press and hold the key



Note:

When moving to the thresholds, the keys must be held until the position has been reached.

Setting the focus via the Touch Screen

- On the Touch Screen, use the  key for switching to stage and focus controls.
- Select the **Focus Drive** menu using the  key. The current Z position is shown in the information field.
- When the focus position is set, it can be approached directly using the  key.

When the lower threshold is set, use the  key to reach the lower threshold.

The Z drive continues only as long as the button is held depressed. The process can be interrupted at any time to prevent a collision of the objective and specimen in case of an incorrectly set lower stop.

- To set or clear the focus position or the lower threshold, select the corresponding position under **Set/Delete**, then press the **Set** or **Delete** key.

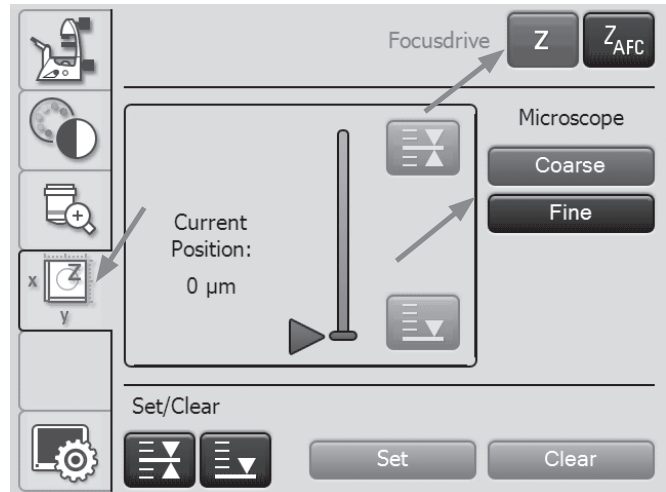
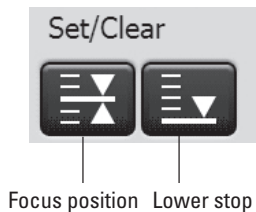

5.7.3 Adjusting the step sizes

Leica DMI8 with motorized focus/closed loop

- Use **Coarse** and **Fine** to switch between coarse and fine focusing at the stand handwheel or the focus knob of the Leica SmartMove as applicable.

The **Fine** value is adapted to the respective objective. The values are predefined logically. You can change the allocation using the LAS X software.

If the **Coarse** value is selected, the travel speed is the same for all objectives. **Coarse** corresponds to the maximum speed.



Note:

The allocation of a certain step size to an objective applies not only for the z-drive, but also for defining the stage step size, which is allocated to this objective after selecting **Fine**.

5.7.4 AFC (Adaptive Focus Control)



Leica DMI8 with motorized focus/closed loop

The AFC can be used to actively hold a defined focus position and automatically readjust this position regularly. This is useful if, for example, a temperature change is caused by opening the climate chamber during living cell experiments at 37°C.

The AFC is activated, then the specimen on the stand is focused using the handwheel and the stopping position is saved.

- AFC monitoring can be performed using variable function keys, LAS X software or via the Touch Screen.

Setting the AFC via the Touch Screen

- On the Touch Screen, use the  key for switching to stage and focus controls.
- Select the **Adaptive Focus Control** menu using the  key.
- Activate the AFC using the **On/Off** key. The knob behind **AFC** turns green.
- Focus the specimen and save the position using the **Hold** key.
- If the position is held, the knob behind **Position** will turn green.

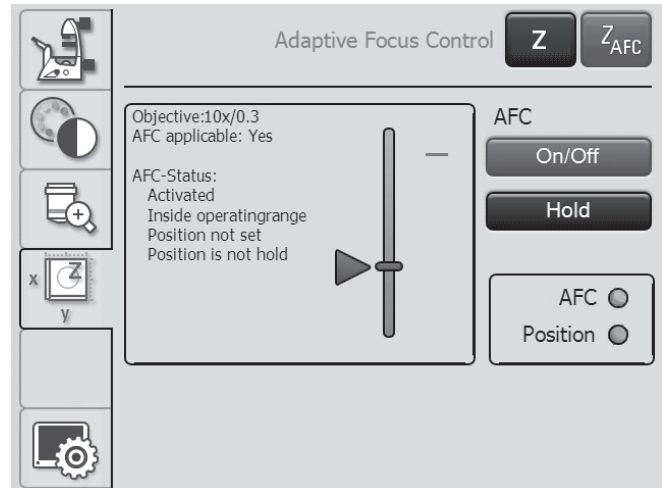



5.8 Selecting the ports

- The top port can be operated manually using the switch rod (see Tube Operation).

Leica DMi8 with manual or manually encoded ports

The manual switch rod on the right side of the stand enables or disables the left side port.

	VIS	LEFT
	100 %	0 %
	20 %	80 %
Alternatively:	0 %	100 %



Leica DMi8 with motorized ports

Setting the ports via the Touch Screen:

- Use the  key to switch to the Magnification menu.
- Select the right or left side port using the corresponding key or point 100% of the light at the eyepiece.

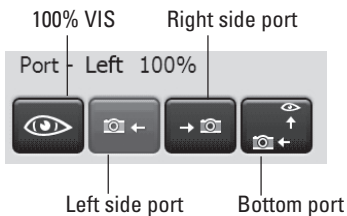

Note:

The "Select the bottom port" function can be assigned to one of the variable function keys on the stand or Leica SmartMove.



Note:

Side ports not in use must be covered with cover caps.

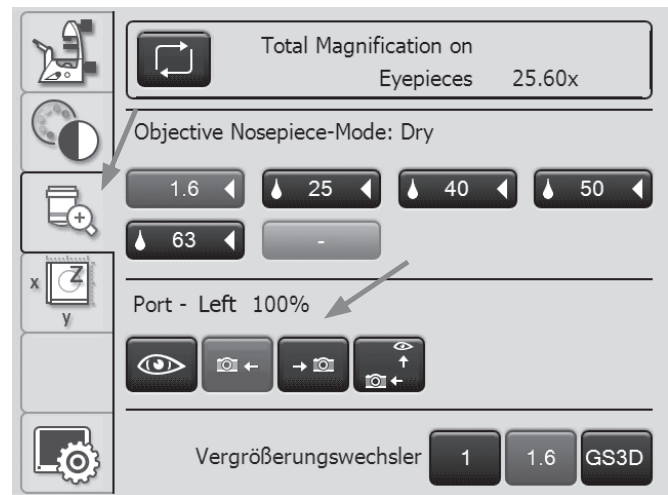

5.9 Magnification Changer

Leica DMI8 with manually encoded Magnification Changer

As an option, a mechanical Magnification Changer can be used.

Magnification factors: 1x; 1.6x

- Using the slide bar, toggle between 1x and the magnification factor.



Note:

The mechanical Magnification Changer works on the eyepiece and the top port.



Leica DMI8 with motorized Magnification Changer

As an option, a motorized Magnification Changer with 2 or 3 switch positions can be used.

Magnification factors:

For 3 switch positions: 1x ; 1.6x; 2x

For 2 switch positions: 1x ; 1.6x

Setting the Magnification Changer via the Touch Screen:

- Use the  key to switch to the Magnification menu.
- Select the magnification factor using the corresponding key.



Note:

The selected factor is included in the calculation of the total magnification.



Note:

The motorized Magnification Changer works on all ports.

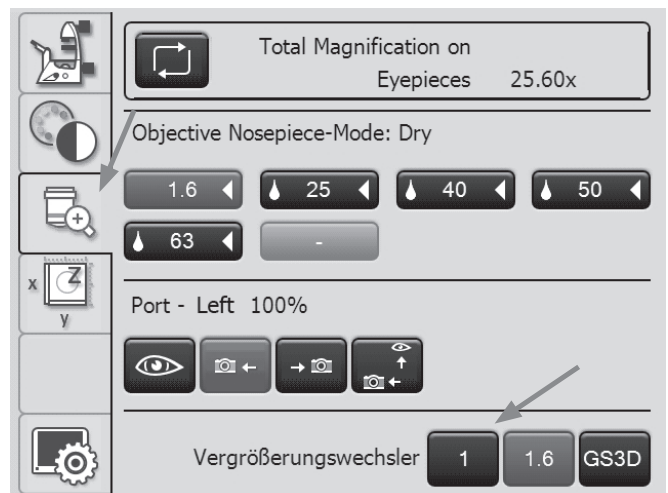

5.10 Aperture diaphragm and field diaphragm

Leica DMi8 with manual aperture diaphragm

For a tiltable Transmitted Light arm:

- The manual aperture diaphragm is adjusted on the condenser.

For a fixed Transmitted Light arm:

- The manual aperture diaphragm is adjusted on the arm.

Leica DMi8 with a fixed Transmitted Light arm

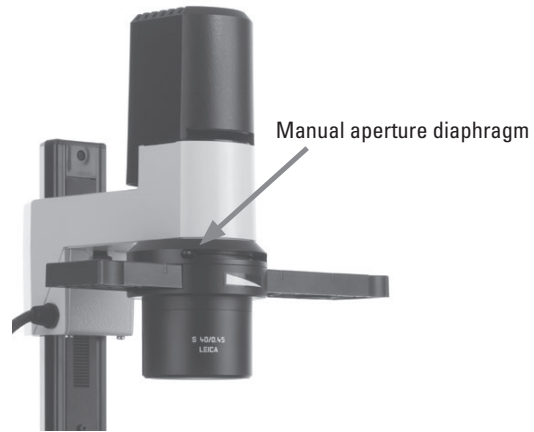

Leica DMi8 with manual illuminated field diaphragm

For a tiltable Transmitted Light arm:

- The manual illuminated field diaphragm is adjusted on the arm.



Note:

The illuminated field diaphragm is available only in conjunction with \leq S28 condensers.

Leica DMi8 with tiltable Transmitted Light arm

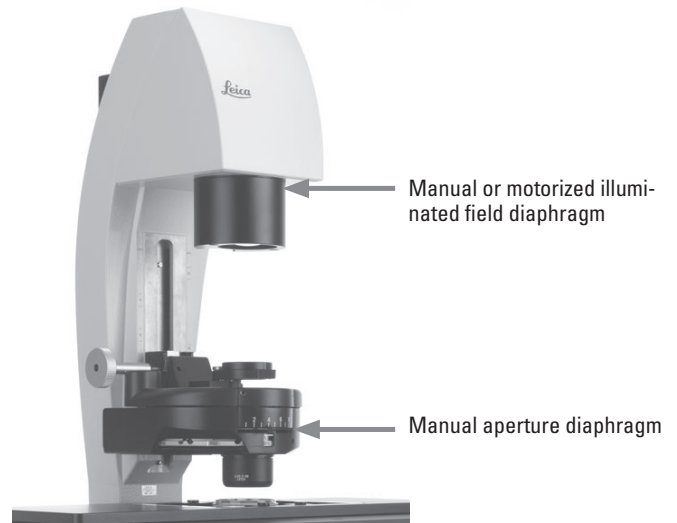

For an integrated fluorescence axis:

- The manual illuminated field diaphragm is adjusted using a slide bar on the right side of the microscope.

Leica DMi8 with manual integrated fluorescence axis

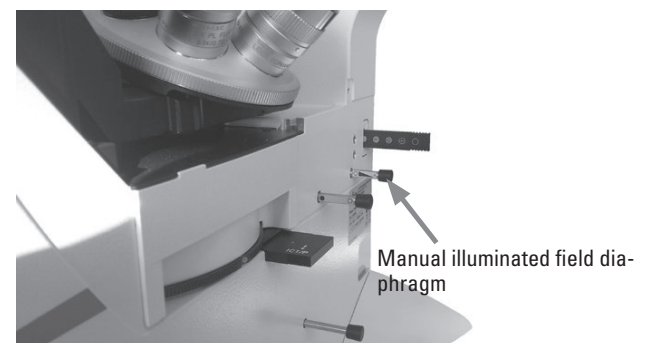

Leica DMI8 with motorized aperture and illuminated field diaphragm

Both diaphragms have been set to suitable values for the current objective and contrast method at the factory.

- Using the **Aperture** (aperture diaphragm) or **Field** (field diaphragm) keys, the motorized diaphragms can be changed at any time. The display on the Touch Screen changes accordingly.



Note:



The old values will be overwritten by the current ones!



Note:

When using **PH** or **DF**, the aperture diaphragm is open all the way and cannot be closed.

Setting the diaphragms via the Touch Screen

- On the Touch Screen, use the  key for basic microscope settings.
- Select the **Status/Illumination** menu using the  key.
- Adjust the aperture and field diaphragms using the + and - keys.

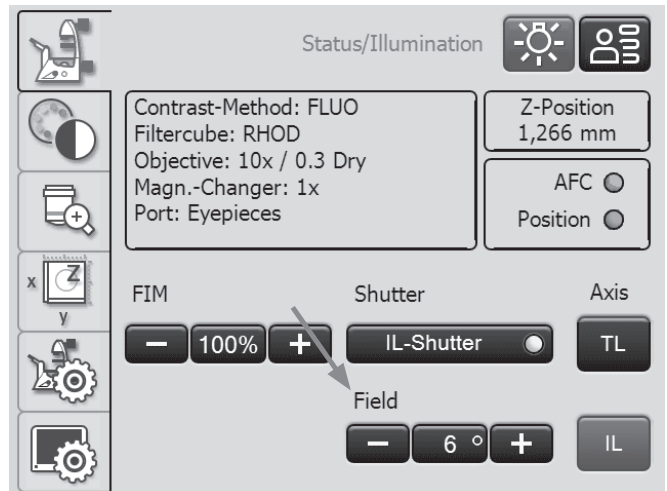
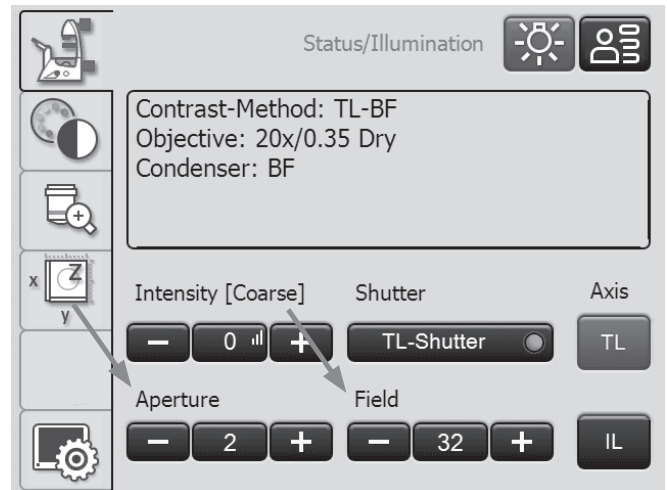

5.11 Filter

5.11.1 Transmitted Light filter

For a tiltable Transmitted Light arm:

- The Transmitted Light filter and the dark stop are swung in and out on the right side of the Transmitted Light arm.



Note:

The front position is assigned at the factory using a shutter (dark stop), which is interchangeable with a filter.

Leica DMI8 with tiltable Transmitted Light arm: Transmitted Light filter



For a fixed Transmitted Light arm:

- Insert the filter into the filter receptacle on the Transmitted Light arm.

Leica DMI8 with a fixed Transmitted Light arm: Transmitted Light filter



5.11.2 Fluorescence Cubes



Note:

Observe the Installation Manual when equipping the fluo turret or replacing individual filter cubes.

Leica DMi8 with manual fluorescent turret disk

- The filter cubes are swiveled manually into the beam path by turning the fluorescent turret disk.
- A color mark on the edge of the disk indicates the current filter cube. If the shipped configuration is changed by inserting another filter cube, note the color of the position where the filter cube was inserted so you can allocate it later.

Changing filter cubes:

- Remove the cover from the fluorescent turret disk. The cover is secured in place by a magnetic holder and can be detached from the front.
- Pull the filter cube forward to remove it and slide the new filter cube straight into the receptacle.
- Put the cover back in place.
- Using a motorized fluorescence turret disk with LID (Leica Radio Frequency Identification Device), there is an automatic full rotation of the turret to read out the filter. For additional instructions, see the chapter entitled "Leica RFID Module" → S. 65

Leica DMi8 with manually encoded fluorescent turret disk

- The filter cubes are swiveled manually into the beam path by turning the fluorescent turret disk. The LED allocated to the filter cube and located on the front side of the microscope is illuminated.

Leica DMi8 with motorized fluorescent turret disk and front operating panel with function keys

- Configure a filter cube by pressing the corresponding filter cube changer button on the keypad of the front side of the microscope. The LED of the filter cube changer button is illuminated.



Color mark
Knurled ring for setting the filter cube
Cover



Empty position for mounting a filter cube. The filter cube is pushed in from the front evenly until it clicks into place.

For encoded fluorescence nosepiece disk



For motorized fluorescent turret disk



Leica DMi8 - motorized variants

Operating the fluorescence via Touch Screen

- On the Touch Screen, use the  key to configure the contrast method.
- Select **FLUO**.
- The available filter cubes are displayed. Select the desired cube using the corresponding key.

Changing filter cubes → S. 63

Change filter cubes for laser applications



For use of the microscope with lasers, Leica Microsystems CMS GmbH offers special microscope variants with additional safety features. Laser couplings require corresponding safety devices that have to be inspected and installed by trained personnel.

- The cover of the fluorescent turret disk is secured using 2 DIN 912 M4x6 lens head Allen screws. (Order No. 11 703 121 630 000)
Detach both screws.



Store the screws in a safe place. Never operate the microscope when the cover is not screwed into place!

- Change the filter cubes as described for the manual Leica DMi8.
- Close and refasten the cover.

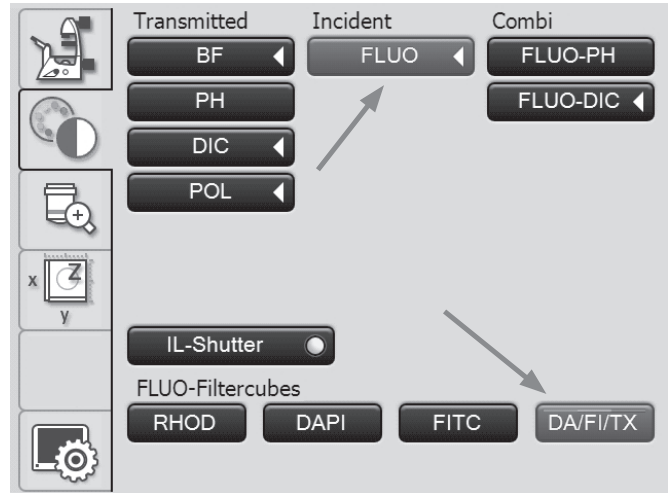

5.11.3 Leica RFID Module

5.11.3.1 Product Description

This microscope contains the RFID module „LID Module 1.0“.

It recognizes the used filter cubes in the fluturret. The different filter cubes are equipped with corresponding passive tags (Type D6.7 special). During initialization phase of the turret, these tags are read by the LID Module 1.0.

The tags cannot be written or modified by the LID Module 1.0.



LID Module 1.0

5.11.3.2 Specifications LID Module 1.0

Supply Voltage	5V
Dimensions	36 x 25 x 9.8 mm
RFID Protocol	ISO 15693
Transmit frequency	13,56 MHz
Operating temperature	-5°C to +65°C
Storage temperature	-20°C to +85°C
Communication interface	I ² C

5.11.3.3 Specifications RFID Tag D6.7 special

Modulation Scheme	Close coupling
Dimensions	D=6,7mm TH=2,6mm
RFID Protocol	ISO 15693
Transmit frequency	13,56 MHz
Read write type	2kbit EEPROM
Operating temperature	-15°C to +65°C
Storage temperature	-25°C to +125°C

5.11.3.4 Ports



I²C-Port

5.11.3.5 FCC / IC Compliance



Note:

This equipment has been tested and found to comply with the limits for a Class A digital device, pursuant to Part 15 of the FCC Rules. These limits are designed to provide reasonable protection against harmful interference when the equipment is operated in a commercial environment. This equipment generates, uses, and can radiate radio frequency energy and, if not installed and used in accordance with the instruction manual, may cause harmful interference to radio communications. Operation of this equipment in a residential area is likely to cause harmful interference in which case the user will be required to correct the interference at his own expense.



Notice:

This device complies with Part 15 of the FCC Rules [and with Industry Canada licence-exempt RSS standard(s)].

Operation is subject to the following two conditions:

1. this device may not cause harmful interference, and
2. this device must accept any interference received, including interference that may cause undesired operation.





Notice:

Changes or modifications made to this equipment not expressly approved by Leica Microsystems CMS GmbH may void the FCC authorization to operate this equipment.

Hereby, Leica Microsystems CMS GmbH declares that the radio equipment type LID Module 1.0 designation of type of radio equipment is in compliance with Directive 2014/53/EU. The full text of the EU declaration of conformity is available at the following internet address: www.leica-microsystems.com

5.12 The memory function on the Touch Screen

Up to 6 user-specific settings can be saved via the Touch Screen. In doing so, combinations of contrast method and objective are stored. One exception is fluorescence mode. In this mode, the combination of fluorescence filter and objective is stored.

- On the Touch Screen, use the  key to switch to basic microscope settings.
- Select the **Memory Function** menu using the  key.

Teaching in a combination

- Set the desired combination.
- Press the key to be allocated.
- Then, press the **Set** key.

Deleting a saved combination

- Press the corresponding key.
- Then, press the **Delete** key.

Setting a saved combination

- Press the corresponding key.
- Finally, press **Set**.

5.13 Transmitted Light contrast method

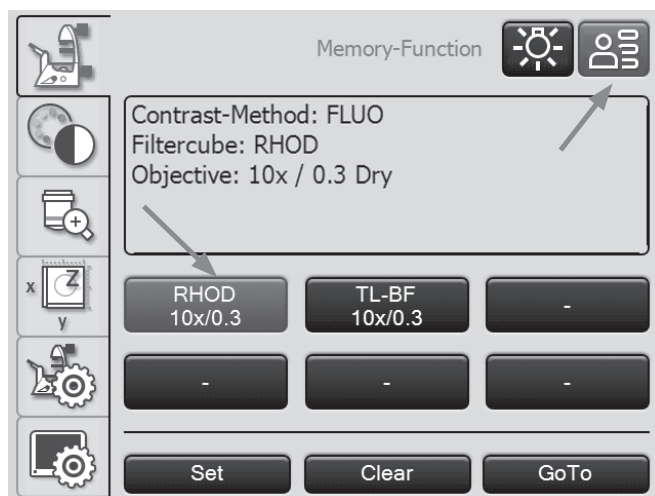

Do not look into the eyepieces when toggling the contrast method!

During the toggling procedure, the maximum radiant power of the light source may be present on the eyepieces for a short time and can temporarily blind the user!

Leica DMI8 with manual Transmitted Light method

The contrast method on the manual or encoded Leica DMI8 can be operated using the manual condenser, the manual objective nosepiece, or the rotary knobs and slide bars on the stand.

- If necessary, first toggle to the Transmitted Light axis (TL) by opening the shutter.
(Slide bar on the manual external or integrated fluorescence axis or using the shutter key for the motorized shutter.)

Leica DMI8 with motorized Transmitted Light method

All contrast methods on the automated Leica DMI8 can be selected and operated via the Touch Screen, the variable function keys or the LAS X software. The only exceptions are methods involving components that have to be operated manually (e.g. systems with manual analyzers). The following describes operation of the automated Leica DMI8 via the Touch Screen. Refer to the separate instructions for operation via the software.

- If necessary, switch to the Transmitted Light axis using the **TL/Fluor** key (TL).

- On the Touch Screen, use the  key to configure the contrast method.

- Select the desired Transmitted Light contrast method.



Note:

If all positions of the fluorescent turret disk have been assigned, the "DAPI" filter cube can be replaced with the "DAPI-TL" filter cube using LAS X software. Transmitted Light contrast methods are possible with this filter cube.

5.13.1 Brightfield (TL)

Leica DMI8 with manual Transmitted Light method

- If necessary, set the TL Brightfield position or an empty position on the fluo turret, or select the "DAPI-TL" filter cube.

For a tiltable Transmitted Light arm:

- Select the Brightfield position on the condenser **BF**.

For a fixed Transmitted Light arm:

- For correct height adjustment of the S80/0.30 and S40/0.45 condensers, the stand has marks (1). These marks pertain to a liquid height of 15 mm. For stands with double marks, the upper and lower mark represent a range with different liquid heights. Move the condenser holder while observing the specimen to attain an optimal image.



Note:

For the stands with 3-plate mechanical stages, position the arm 25 mm below the marks, as the illumination axis is installed 25 mm higher on an adapter than on the fixed stage.

- Press the stop lever (2) and adjust the Transmitted Light illumination arm until the upper edge of the carrier is even with the corresponding condenser height mark.
- Swing all remaining optical components, such as the analyzer, polarizer or IC prisms, from the beam path.
- Insert a Transmitted Light specimen.
- Select your objective.

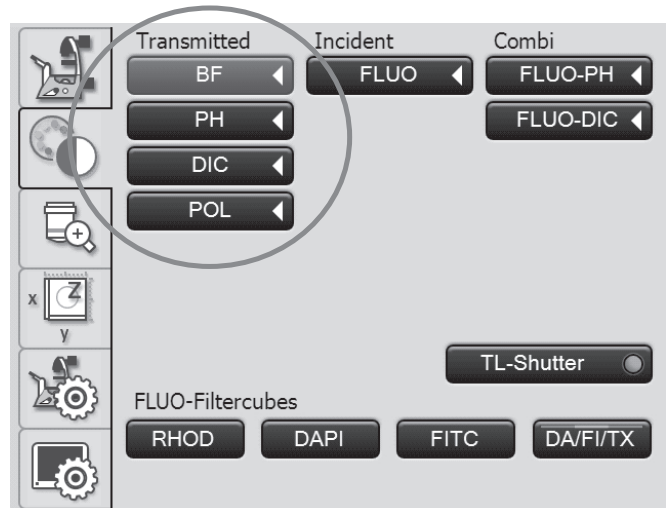
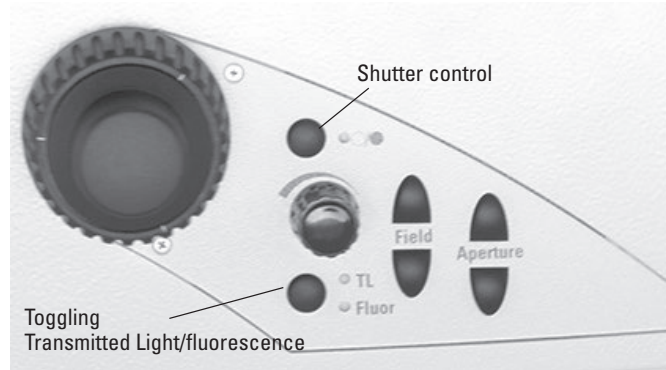

- Focus the image using the focus dials.
- Configure the brightness on the intensity rotary knob.
- For an optimal field diaphragm setting, check the Koehler illumination.

Leica DMI8 with motorized Transmitted Light method

- Select the contrast method **BF** (Brightfield).

The Brightfield position is approached for the motorized condenser.

An empty position or the filter cube "DAPI-TL" on the fluorescent turret disk is approached automatically.

- Insert a Transmitted Light specimen.
- Select a suitable objective in the magnification menu.
- Focus the image using the rotary knob on the Leica SmartMove or using the focus dial.
- Configure the brightness on the intensity rotary knob.



Note:

You can find additional information regarding the correct settings for Koehler illumination in Leica Science Lab.

Link:

<http://www.leica-microsystems.com/science-lab/>



Condenser setting for tiltable Transmitted Light arm - configuring **BF** position

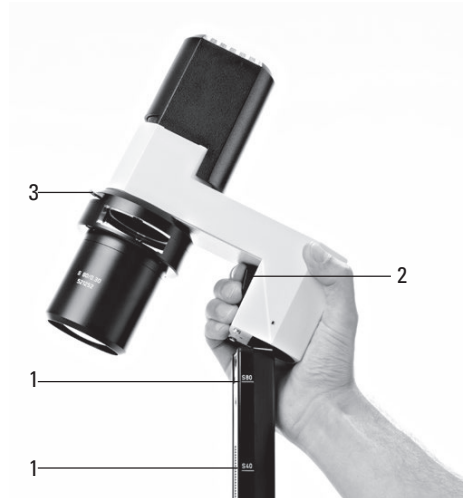

Condenser setting for fixed Transmitted Light arm

- 1 Marks
- 2 Stop lever for condenser adjustment
- 3 Aperture diaphragm

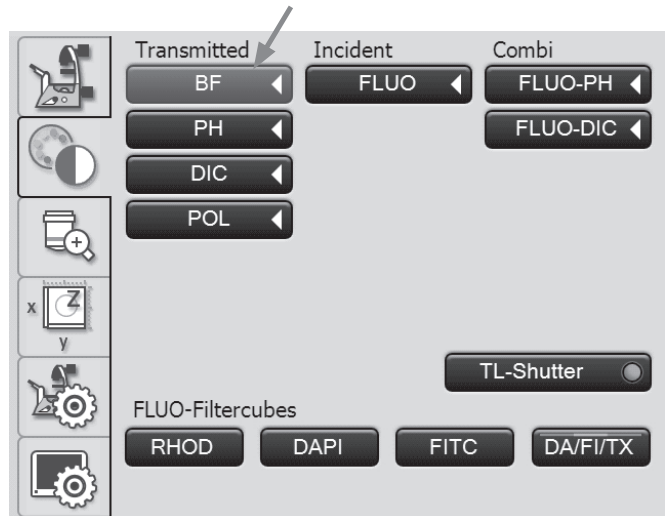

5.13.2 Phase Contrast (TL)
(Integrated Phase Contrast, see 5.13.6)

Leica DMI8 with manual Transmitted Light method

- If necessary, set the TL Brightfield position or an empty position on the fluo turret, or select the "DAPI-TL" filter cube.
- Select a Phase Contrast objective. Objectives that are suitable for Phase Contrast are engraved with PH.

For a tiltable Transmitted Light arm:

- Select the corresponding light ring on the condenser.

For a fixed Transmitted Light arm:

- Configure the condenser height and remove the IMC slit diaphragm slider, if necessary.
- Guide the Phase Contrast light ring slide with the marking "TOP LEFT" on the top left laterally into the receptacle until it clicks into place.
 (Caution: there are various slide bars for the condensers!)
- Use the light ring of the light ring slide that corresponds to the magnification (5, 10/20 or 40).



Note:

The Phase Contrast light ring slide is encoded. As soon as the slider is taken out of the Brightfield position (available opening) and engaged in a Phase Contrast position (any light ring), the brightness increases. Conversely, switching from Phase Contrast to Brightfield decreases the brightness.

- 1 Slider for light rings (S80/0.30)
- 2 Slider for light rings (S40/0.45)
- 3 Click stop
- 4 Light rings
- 5 Brightfield position
- 6 "TOP LEFT" marking



Condenser setting for tiltable Transmitted Light arm - configuring light ring, e.g. **PH1**

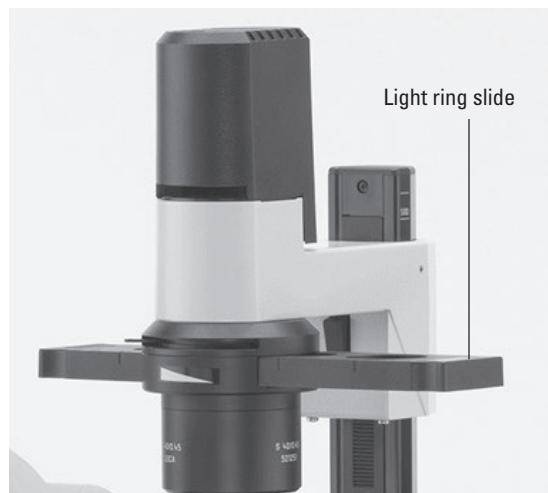

Phase Contrast for fixed Transmitted Light arm

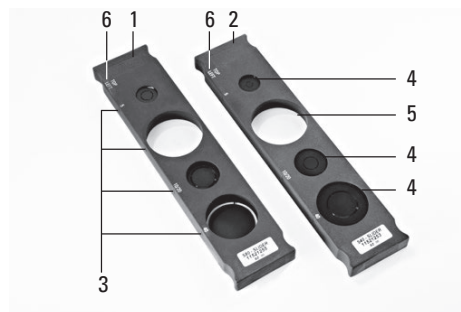

Light ring slide for fixed Transmitted Light arm

- Completely open the aperture on the condenser.
- Swing all remaining optical components, such as the analyzer, polarizer or IC prisms, from the beam path.
- Insert a Phase Contrast specimen.
- Focus the image using the focus dials.
- Configure the brightness on the intensity rotary knob.

Leica DMI8 with motorized Transmitted Light method

- Select the **PH** contrast method (Phase Contrast).

The correct light ring on the motorized condenser is swung inwards.

- Insert a Transmitted Light specimen.
- Select a suitable objective in the magnification menu. Objectives that are suitable for Phase Contrast are engraved with PH.
- Focus the image using the rotary knob on the Leica SmartMove or using the focus dial.
- Configure the brightness on the intensity rotary knob.

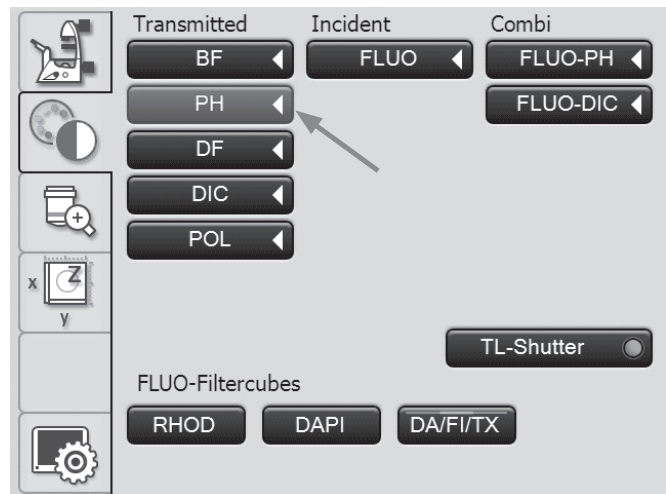

Note:

When selecting the Phase Contrast method, the aperture diaphragm is opened fully and can not be adjusted.

5.13.3 Darkfield (TL)

Leica DMI8 with manual Transmitted Light method

- If necessary, set the TL Brightfield position or an empty position on the fluo turret, or select the "DAPI-TL" filter cube.
- Select a Darkfield objective.
- Select the corresponding Darkfield stop (light ring) on the condenser.
- Completely open the aperture on the condenser.
- Swing all remaining optical components, such as the analyzer, polarizer or IC prisms, from the beam path.
- Insert a Darkfield specimen.
- Focus the image using the focus dials.
- Configure the brightness on the intensity rotary knob.



Condenser setting for tiltable Transmitted Light arm - configuring Darkfield stop (light ring)

Leica DMI8 with motorized Transmitted Light method

- Select the contrast method **DF** (Darkfield).

The Darkfield ring (dark stop) is swung in for the motorized condenser.

- Insert a Transmitted Light specimen.
- Select a suitable objective in the magnification menu.
- Focus the image using the rotary knob on the Leica SmartMove or using the focus dial.
- Configure the brightness on the intensity rotary knob.

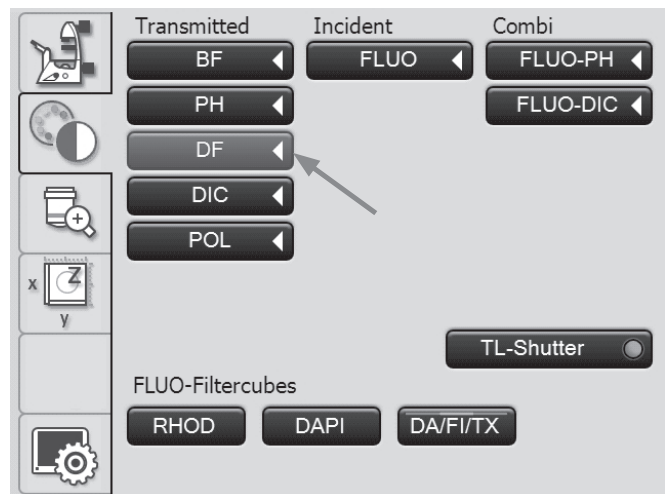

Note:

The maximum applicable objective aperture for the Darkfield is for the condenser S1 0.70 and for the condenser S23/S28/S40 0.40.



Note:

When the Darkfield method is selected, the aperture diaphragm is opened fully and cannot be adjusted.

5.13.4 Polarization (TL)

Leica DMi8 with manual Transmitted Light method

- If necessary, set the TL Brightfield position or an empty position on the fluo turret, or select the "DAPI-TL" filter cube.
- Select the Brightfield position on the condenser.
- Swing all IC prisms out of the beam path.
- Select your objective.
- Swing the polarizer on the condenser into the beam path.
- Insert the analyzer on the right side of the stand up to the click stop.
- Bring the polarizer and analyzer into cross position until they reach maximum darkness.
- Insert a specimen.
- Focus the image using the focus dials.
- Configure the brightness on the intensity rotary knob.

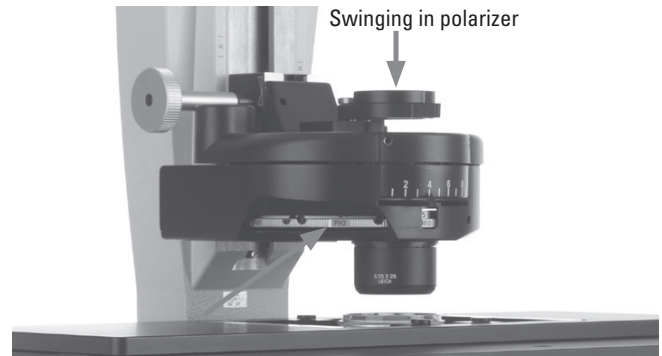

Condenser setting for tiltable Transmitted Light arm - configuring **BF** position



Leica DMI8 with motorized Transmitted Light method

- Select the **POL** (Polarization) contrast method

Motor procedure:

- After the **POL** contrast method has been selected, the polarizer is swung in (if the microscope is equipped with these components). The analyzer cube is also automatically brought into the beam path.

Combined procedure:

- You also have the option of combining purely mechanical and motorized components, i.e. you can combine a mechanical analyzer and a motorized polarizer.

Manual procedure:

For a manual swing polarizer and a mechanical analyzer, proceed with the manual Transmitted Light method as described for the Leica DMI8.

- Select a suitable objective in the magnification menu.
- Insert a specimen.
- Focus the image using the rotary knob on the Leica SmartMove or using the focus dial.
- Configure the brightness on the intensity rotary knob.

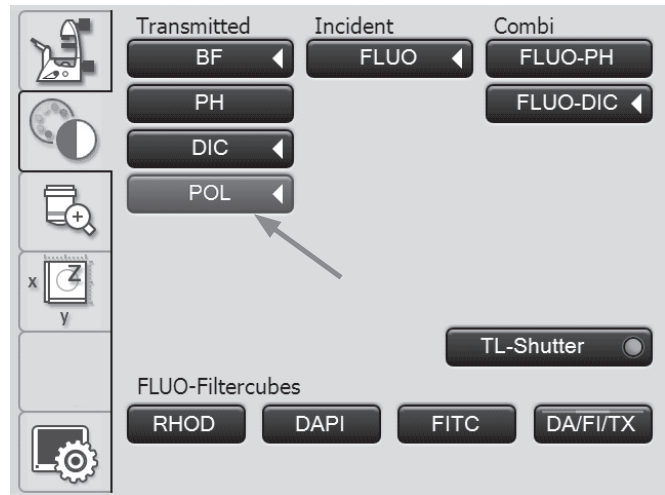

5.13.5 Differential Interference Contrast – DIC (TL)

Leica DMi8 with manual Transmitted Light method

- If necessary, set the TL Brightfield position or an empty position on the fluo turret, or select the "DAPI-TL" filter cube.
- Select an objective.
- Select the corresponding Wollaston prism condenser on the condenser.
- Select the corresponding Wollaston prism objective on the objective nosepiece.
- Swing the polarizer on the condenser into the beam path.
- Then, insert the analyzer on the right side of the stand until it locks into place.
- Insert a specimen.
- Focus the image using the focus dials.
- Configure the brightness on the intensity rotary knob.
- For fine adjustment, use the adjusting screw below the objective nosepiece.

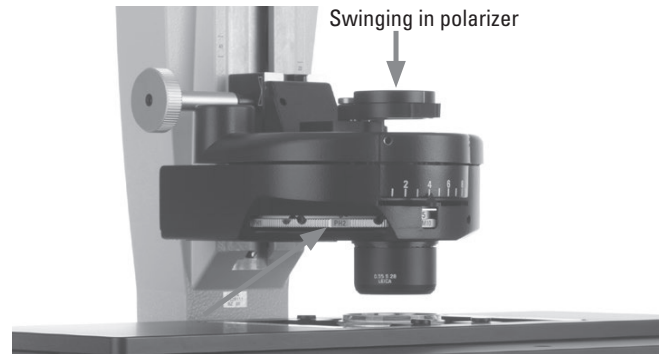

Condenser setting for tiltable Transmitted Light arm - configuring Wollaston prism

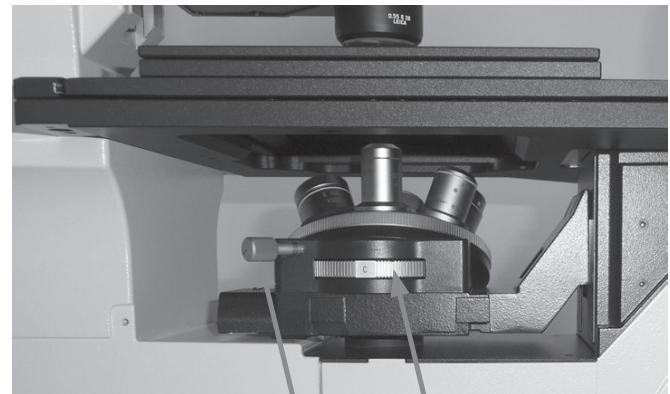

Fine adjusting the objective prism
Setting objective prism

Leica DMI8 with motorized Transmitted Light method

- Select the **DIC** (Differential Interference Contrast) contrast method.
- The polarizer located in the condenser and the fitting condenser prisms are automatically brought into the beam path. The corresponding objective prism and the analyzer cube are also approached automatically.
- Place a DIC specimen on the stage.
- Select a suitable objective in the magnification menu.
- Focus the image using the rotary knob on the Leica SmartMove or using the focus dial.
- Configure the brightness on the intensity rotary knob.
- The adjustment is carried out via the buttons + and – on the Touch Screen.

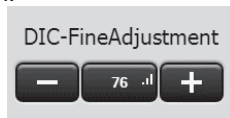
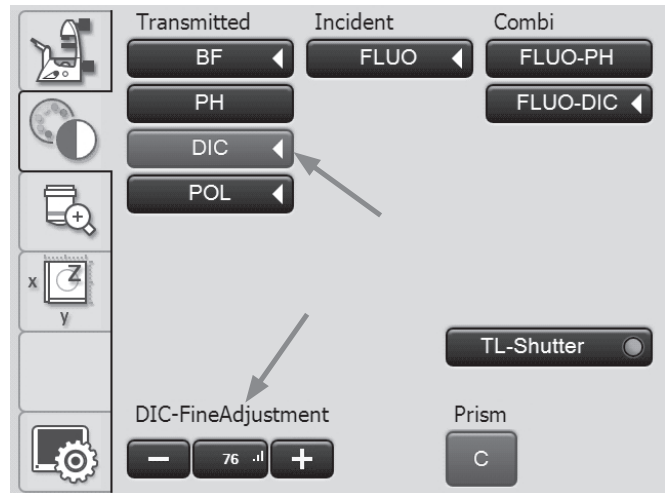

Manual alternative:

- Manually swing the polarizer on the condenser into the beam path.
 - Then, also manually insert the analyzer on the right side of the stand until it locks into place.
- Guide the objective and condenser prisms manually until a correct combination is displayed in the Touch Screen.
- For fine adjustment use the knurled ring below the objective nosepiece.



Fine adjusting the objective prism

5.13.6 Integrated Phase Contrast – IPH (TL)



Note:

The Integrated Phase Contrast requires a condenser on the tiltable Transmitted Light arm.

Leica DMI8 with manual Transmitted Light method

- If necessary, set the TL Brightfield position or an empty position on the fluo turret, or select the "DAPI-TL" filter cube.
- Select a Brightfield objective with eyepoint B or C.
- Select the corresponding light ring on the condenser (see table).
- Completely open the aperture on the condenser.
- Swing all remaining optical components, such as the analyzer, polarizer or IC prisms, from the beam path.
- If necessary, remove the cover of the holder and insert the Phase Contrast module evenly from the front on the left side of the microscope.
- Slide the Phase Contrast module into the correct eyepoint B or C.
- Insert a Phase Contrast specimen.
- Focus the image using the focus dials.
- Configure the brightness on the intensity rotary knob.

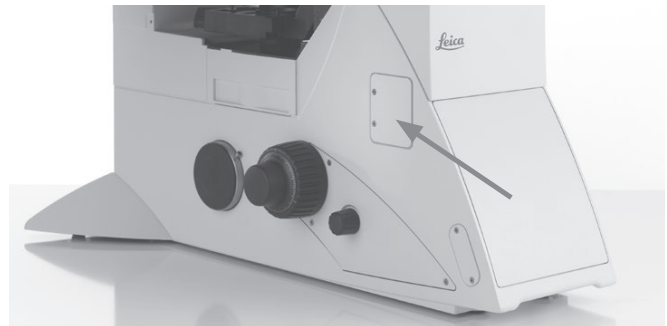

Receptacle for Phase Contrast module

Phase Contrast module for tiltable Transmitted Light illumination carrier

- 1 Centering screws for light ring 20x - 63x
- 2 Position for objectives 20x - 63x
- 3 Brightfield position
- 4 Position for objectives 5x - 10x
- 5 Phase ring 20x - 63x
- 6 Phase ring 5x - 10x
- 7 Fastening screw for light ring 20x - 63x

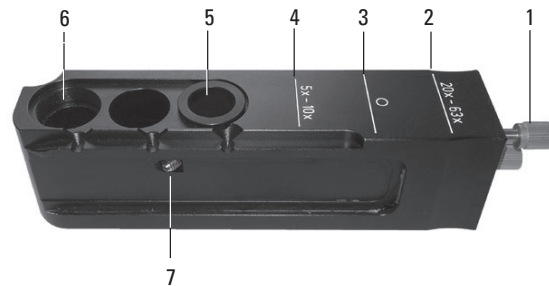

IP0	for 5x	e.g. NPlan 5x	Objective with eyepoint B
IP1	for 10x for 20x	e.g. NPlan 10 x e.g. NPlan L 20 x	Objectives with eyepoint B and Objectives with eyepoint C
IP2	for 40x	e.g. HCX PL FL L 40 x	Objectives with eyepoint C
IP3	for 63x	e.g. PL FL 63x/0.70	Objectives with eyepoint C

Leica DMI8 with motorized Transmitted Light method

- Select the **PH** (Phase Contrast) contrast method.

The correct light ring on the motorized condenser is swung inwards.

- Insert a Transmitted Light specimen.
- Select a suitable objective in the magnification menu (eyepoint B or C).
- If necessary, remove the cover of the holder and insert the Phase Contrast module evenly from the front on the left side of the microscope.
- Slide the Phase Contrast module into the correct eyepoint B or C.
- Focus the image using the rotary knob on the Leica SmartMove or using the focus dial.

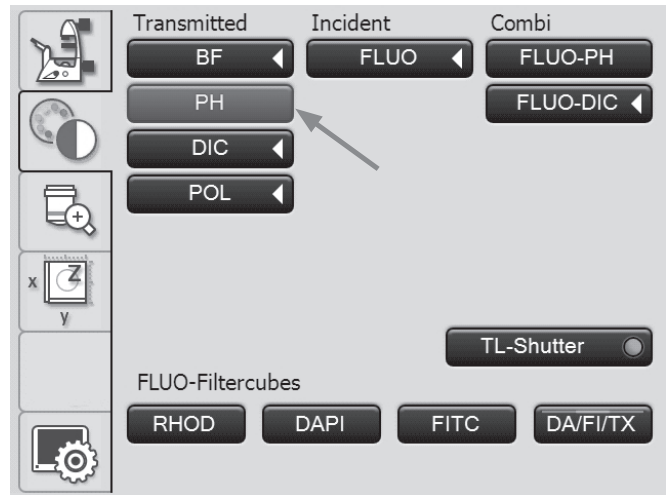

Note:

When selecting the Phase Contrast method, the aperture diaphragm is opened fully and can not be adjusted.



Note:

For centering the phase ring 20x-63x, refer to the Installation Manual.

5.13.7 Integrated Modulation Contrast – IMC (TL)

Leica DMi8 with manual Transmitted Light method

- If necessary, set the TL Brightfield position or an empty position on the fluo turret, or select the "DAPI-TL" filter cube.
- Select a Brightfield objective with eyepoint B or C.
- Swing all remaining optical components such as the analyzer or IC prisms from the beam path.

Inserting the IMC module:

- If necessary, remove the cover of the holder and insert the IMC module evenly from the front on the left side of the microscope.

For a tiltable Transmitted Light arm:

- Slide the IMC module into the correct eyepoint B or C.

For a fixed Transmitted Light arm:

- Insert the IMC modulator into the IMC module from the side according to the eyepoint B, C or D of the objective.
Ensure that the "TOP" marking faces upwards.

- Engage the slide in the IMC position.
(Push in for IMC, pull out for the Brightfield).

IMC module for tiltable Transmitted Light arm

- 1 Position for objectives with eyepoint C
- 2 Position for objectives with eyepoint B
- 3 Brightfield position
- 4 Height adjustment
- 5 Fine adjustment

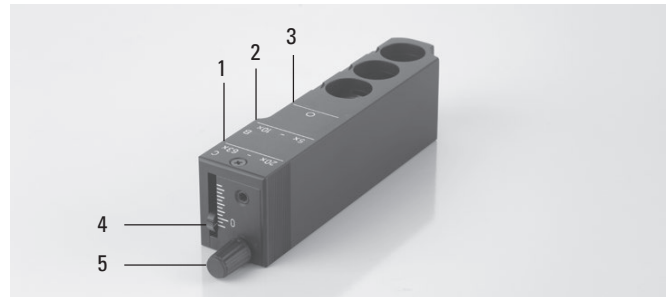

IMC module for fixed Transmitted Light arm

- 1 IMC module
- 2 IMC modulator
- 3 Fine adjustment
- 4 Positioning depending on eyepoint B, C or D

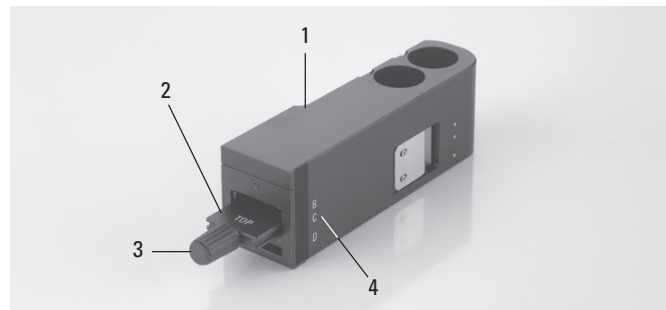

IMC module used for fixed Transmitted Light arm

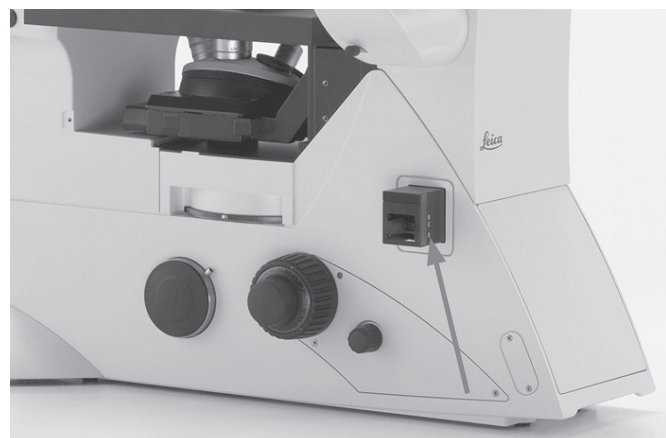

Setting the IMC slit diaphragms:

For a tiltable Transmitted Light arm:

- On the condenser, select the corresponding slit illumination for the current magnification.
- Swing the polarizer on the condenser into the beam path.



Note:

The position of the polarizer influences the appearance of the relief. The best relief images are obtained in the extinction position; the relief disappears at a 90° position.

For a fixed Transmitted Light arm:

- If necessary, remove the Phase Contrast slider in the Transmitted Light arm.
- Hold the IMC slide so that the marking "TOP LEFT" is at the top left and the rest of the marking faces forwards. The click stops are on the front longitudinal side of the slide.
(Depending on whether the S40/0.45 or S80/0.30 condenser is used, various IMC slit diaphragm sliders exist).
- Insert the diaphragm slide from the right into the Transmitted Light arm.
- Engage the slide in the IMC position. The round opening is the Brightfield position.



Note:

The IMC slit diaphragm slider is encoded. As soon as the slider is taken out of the Brightfield position (available opening) and engaged in the IMC position, the brightness increases. Conversely, switching from IMC to Brightfield decreases the brightness.

- To adjust the slit width, adjust the slider of the IMC slit diaphragm slider to the position allocated on the objective, e.g. to the 10x marking for the 10x objective.

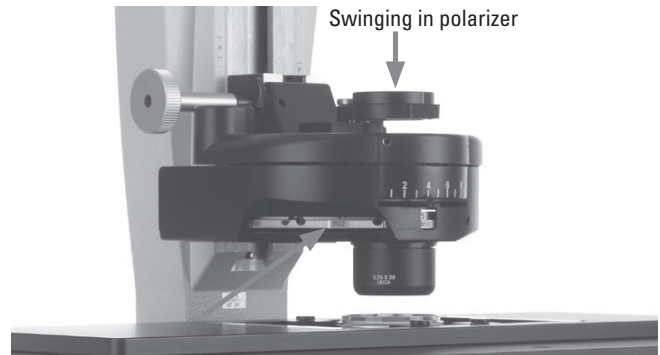

Condenser setting for tiltable Transmitted Light arm - configuring slit diaphragm

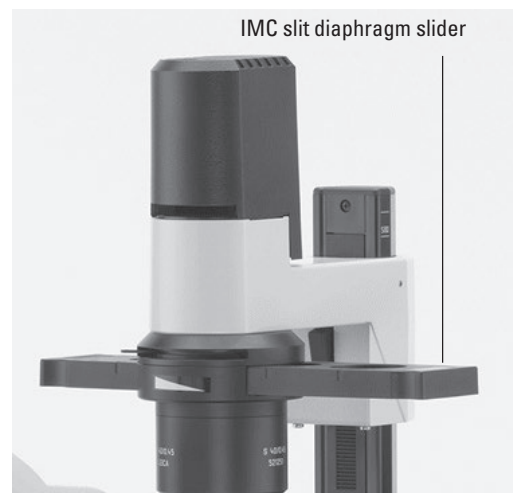

- 1 "TOP LEFT" marking on the diaphragm slide
- 2 Click stops
- 3 IMC slit diaphragm slider for S80/0.30
- 4 IMC slit diaphragm slider for S40/0.45
- 5 Adjusting screw on the IMC slit diaphragm slider

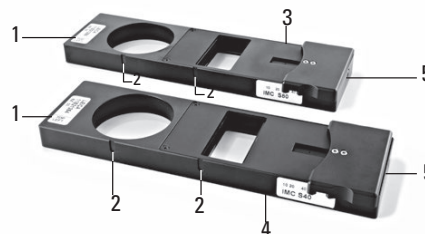

- Insert a specimen.
- Focus the image using the focus dials.
- Configure the brightness on the intensity rotary knob.

Fine adjustment:

For a tiltable Transmitted Light arm:

- The fine adjustment is made using the knurled screw on the IMC modulator and the polarizer.
- Using the slider, you can also offset the height to adjust the slit diaphragms to the focal plane. This setting depends on the specimen being observed.



Note:

The position of the polarizer influences the appearance of the relief. The best relief images are obtained in the extinction position; the relief disappears at a 90° position.

For a fixed Transmitted Light arm:

- The fine adjustment occurs via the knurled screw on the IMC modulator.



Note:

For adjusting the aperture diaphragms, refer to the Installation Manual.

IMC module for tiltable Transmitted Light arm



IMC module for fixed Transmitted Light arm



Leica DMi8 with motorized Transmitted Light method

- Caution: For the Integrated Modulation Contrast, first enable the **DIC** button!

The correct slit diaphragm is configured and the polarizer is automatically swung inwards on the motorized condenser.

- Insert a specimen.
- Select a suitable objective in the magnification menu (eyepoint B or C).

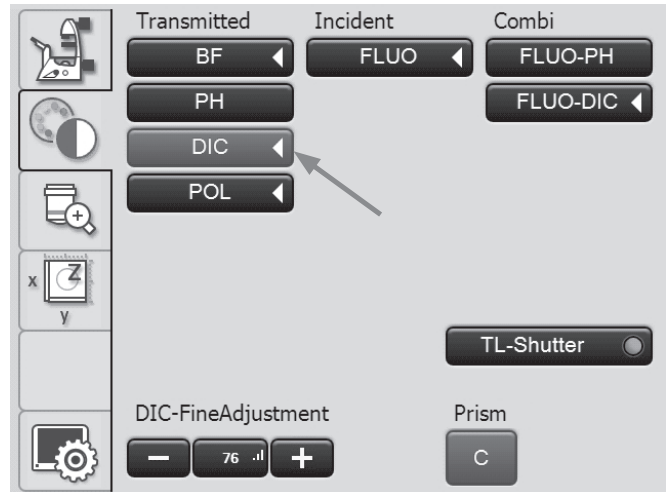

- If necessary, remove the cover of the holder and insert the IMC module evenly from the front on the left side of the microscope.
- Slide the IMC module into the correct eyepoint B or C.
- Focus the image using the rotary knob on the Leica SmartMove or using the focus dial.
- Configure the brightness on the intensity rotary knob.
- The fine adjustment is made using the knurled screw (5) and the polarizer.



Note:

The position of the polarizer influences the appearance of the relief. The best relief images are obtained in the extinction position; the relief disappears at a 90° position.

- Using the slider (4), you can also offset the height to adjust the slit diaphragms to the focal plane. This setting depends on the specimen being observed.



Note:

For adjusting the aperture diaphragms, refer to the Installation Manual.

IMC module for tiltable Transmitted Light arm

- 1 Position for objectives with eyepoint C
- 2 Position for objectives with eyepoint B
- 3 Brightfield position
- 4 Height adjustment
- 5 Fine adjustment

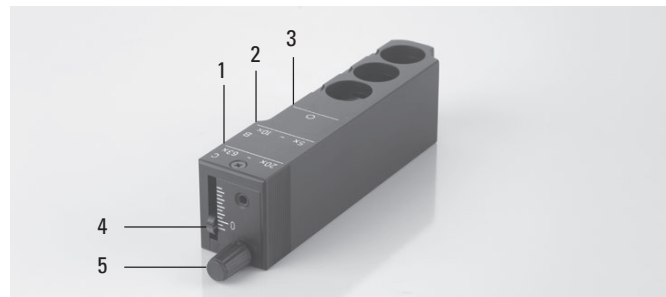

5.14 Fluorescence



Note:

To replace filter cubes, refer to Chapter 5.11, Filters →. S. 63

Leica DMI8 with manual fluorescence

- If necessary, first switch over to the fluorescence axis (**Fluor**) by opening the shutter (pull out switch rod (3) for manual shutter or push shutter button for motorized shutter).
- If necessary, pull out the analyzer slider (2) completely to open the beam path.
- Set the light intensity on the Leica EL6000 compact light source.



Note:

If the Leica DMI8 is equipped with a 2 port infinity port (→ S. 44) switch over to the current port .→ S. 58

- When using the Fluorescence Intensity Manager (FIM):
The brightness is adjusted in 5 defined increments on the FIM slider (4).
100% / 55% / 30% / 17% / 10%
- The filter cubes are swiveled manually into the beam path by turning the fluorescent turret disk (1).
- A color mark on the edge of the disk indicates the current filter cube. If the shipped configuration is changed by inserting another filter cube, note the color of the position where the filter cube was inserted so you can allocate it later.

Manual integrated fluorescence axis

- 1 Manual filter change
- 2 Analyzer
- 3 Manual shutter
- 4 Manual setting for FIM

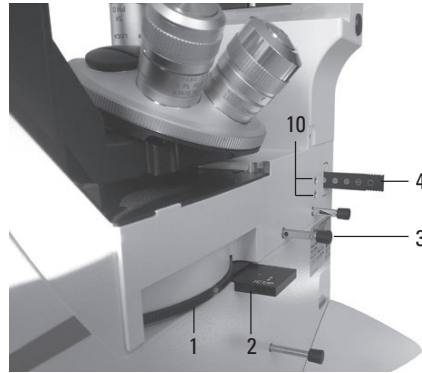

Manual external fluorescence axis

- 3 Manual shutter
- 4 Manual setting for FIM
- 5 Connection for light guide
- 6 Diaphragm module
- 7 Receptacle for EFW or structured illumination

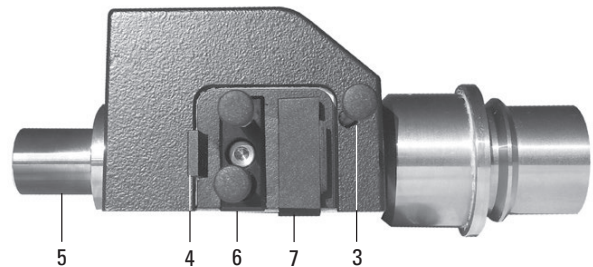

Leica DMi8 with manually encoded fluorescent turret disk

- The filter cubes are swiveled manually into the beam path by turning the fluorescent turret disk. The LED allocated to the filter cube and located on the front side of the microscope is illuminated.

Manually encoded Leica DMi8 with motorized fluorescent turret disk

- Adjust a filter cube by pressing the corresponding filter cube changer button on the keypad of the front side of the microscope. The LED of the filter cube changer button is illuminated.

For encoded fluorescence nosepiece disk



For motorized fluorescent turret disk





Leica DMi8 with motorized fluorescence

- If necessary, switch over to the fluorescence axis (**Fluor**) with the button **TL/Fluor**.

Operating the fluorescence via Touch Screen:

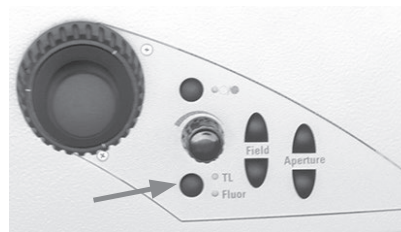
- If necessary, switch over to the fluorescence axis (Fluor) with the **IL** button.



- Rotate on the Touch Screen via the button  for configuring the contrast method.

- For incident light, select the contrast method **FLUO**.

- Insert a specimen.

- Select a suitable objective in the magnification menu.

- The current fluorescence filter cube is displayed on the Touch Screen. If necessary, push the button for the desired fluorescence filter cube.

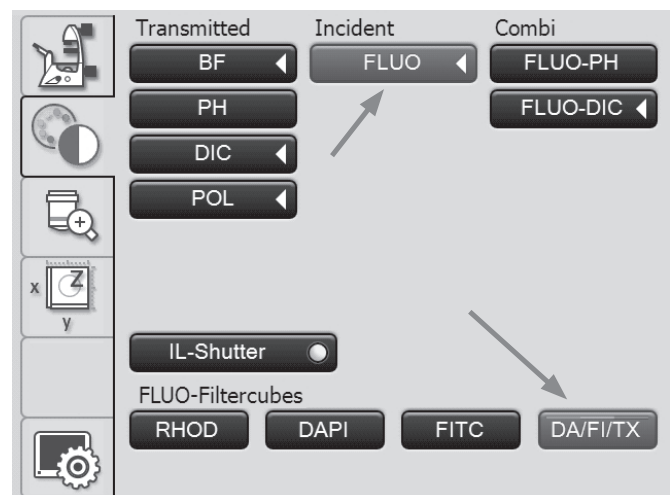

- You may protect your specimen from fading by closing the incident light shutter. To do so, push the **IL shutter** button.
- Focus the image using the rotary knob on the Leica SmartMove or using the focus dial.

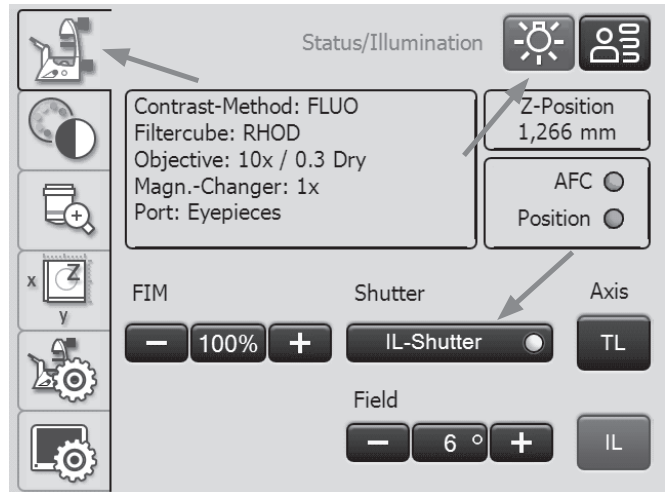

- Set the light intensity on the Leica EL6000 compact light source. (See separate Instructions for Use).



- When using the Fluorescence Intensity Manager (FIM): The brightness is adjusted in 5 defined increments on the brightness adjusting knob: 100% / 55% / 30% / 17% / 10%

or alternatively, on the Touch Screen via the button **FIM**

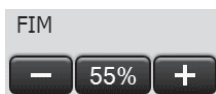
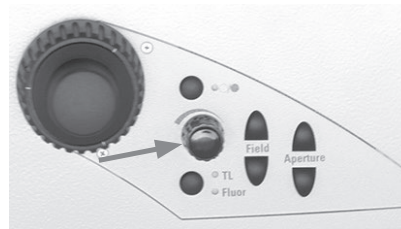

5.15 Combination method

Leica DMi8 with motorized Transmitted Light method and motorized fluorescence:

Depending on the configuration of your microscope, up to two combination methods are possible:

FLUO/PH and FLUO/DIC

- On the Touch Screen, use the  key to configure the contrast method.
- Insert a specimen.
- Select a suitable objective in the magnification menu.
- For the combination, select the contrast method **FLUO-PH** or **Fluo-DIC**.

FLUO-PH:

- The current fluorescence filter cube is displayed on the Touch Screen. If necessary, push the button for the desired fluorescence filter cube.
- The illumination settings for the fluorescence and Transmitted Light axis can be adjusted separately. To do so, toggle between the using the **TL/Fluor** button.

FLUO-DIC:

- Switch between the two contrast methods by pressing the **FLUO-DIC** key.
- In FLUO mode, the current fluorescence filter cube is displayed on the Touch Screen. If necessary, push the button for the desired fluorescence filter cube.
- In DIC mode, the DIC fine adjustment is made using the + and – key.



Note:

The manual analyzer must be used for the FLUO/DIC method.

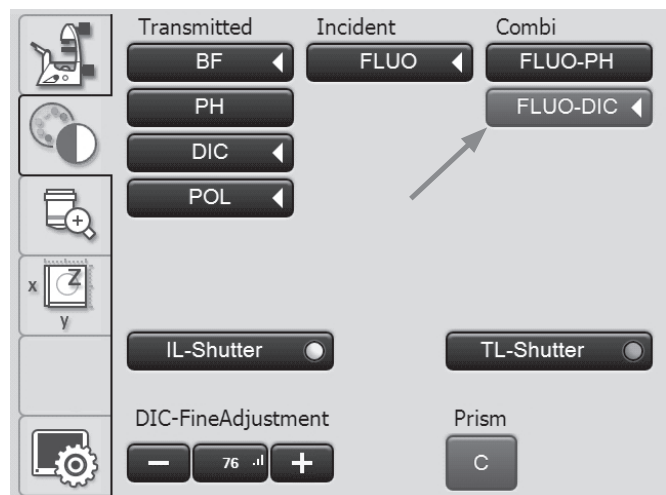
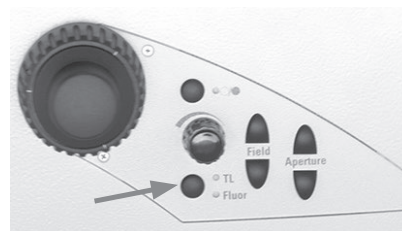
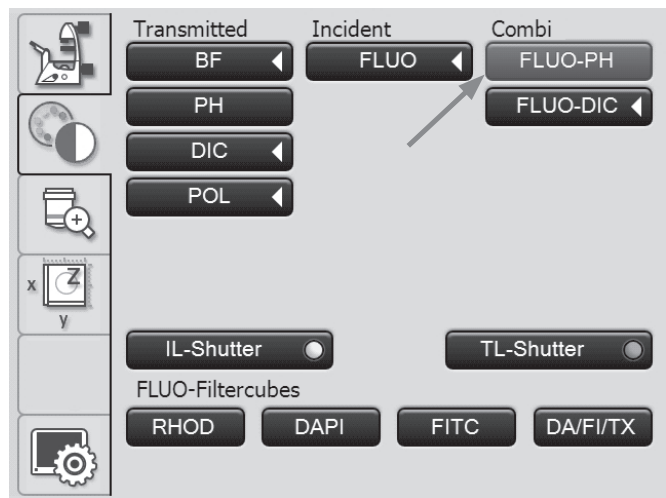

6. Troubleshooting

Problem	Cause/remedy
Stand	
The microscope does not respond.	<ul style="list-style-type: none"> ▶ Ensure that the AC outlet has power. ▶ Make sure that the electronics box or the microscope is connected to the power supply. ▶ Check the cable connections. ▶ Inform Service and have the supply unit fuse checked.
Illumination	
The image is completely dark.	<ul style="list-style-type: none"> ▶ Open the shutter. ▶ Check the connection of the lamp housing to the microscope (Transmitted Light). ▶ Ensure that the lamps are not defective. ▶ Check the connection of the EL6000 compact light source (fluorescence). ▶ Switch over to the active port. ▶ Inform the service department and have them check whether a fuse is defective.
The image is not uniformly illuminated.	<ul style="list-style-type: none"> ▶ Remove all unneeded filters from the light path.
Brightfield	
The specimen cannot be brought into focus.	<ul style="list-style-type: none"> ▶ Use the correct immersion medium. ▶ Place the specimen with the cover slip downward onto the stage. ▶ Make sure that the thickness of the cover slip is correct and corresponds to the specifications on the objective. ▶ Make sure that you are using an objective with cover slip correction. ▶ Adjust the correction ring if present on the objective.

Problem	Cause/remedy
Darkfield	
No definite DF contrast is possible.	<ul style="list-style-type: none"> ▶ Be sure that a DF objective is being used. ▶ The objective aperture setting is too high: Maximum 0.7 for condenser S1 Maximal 0.4 for condenser S23/28/40 If necessary, reduce the objective aperture using the iris diaphragm on the objective. ▶ Check the condenser centering.
The image is not uniformly illuminated.	<ul style="list-style-type: none"> ▶ The magnification is too weak. Use a higher magnification. ▶ If necessary, remove the condenser lenses or the condenser head.
Unwanted stray light.	<ul style="list-style-type: none"> ▶ Clean the specimen and neighboring lens surfaces.
Phase Contrast	
Phase Contrast cannot be adjusted.	<ul style="list-style-type: none"> ▶ The specimen is too thick, too thin or too brightly stained. ▶ Refractive indexes of the mounting medium and specimen are identical, so that there is no phase jump. ▶ The cover glass is not placed uniformly. ▶ Check that the correct light ring is positioned. ▶ Check that the correct light slider is positioned. ▶ The S40/0.45 condenser has been switched with the S80/0.30 condenser. ▶ Open the aperture diaphragm completely. ▶ IMC modulator in IMC position. ▶ Check the centering of the light rings.
Polarization	
Polarization contrast cannot be adjusted.	<ul style="list-style-type: none"> ▶ Bring the polarizer and analyzer into cross position until they reach maximum darkness (without specimen).

Problem	Cause/remedy
Transmitted-light interference contrast	
No Transmitted Light interference contrast is possible.	<ul style="list-style-type: none"> ‣ The specimen is too thick or too thin. ‣ The mounting medium or specimen are of birefringent material. Rotate the specimen. ‣ The difference in the refractive indices of the specimen and the mounting medium is too small. ‣ The cover slip is too thick. ‣ Check the Koehler illumination. ‣ Bring the polarizer and analyzer into cross position until they reach maximum darkness (without specimen). ‣ Check whether the compatible condenser prism and the corresponding objective prism are configured. ‣ Check the correct placement of the IC condenser prisms.
Integrated Modulation Contrast	
IMC cannot be adjusted.	<ul style="list-style-type: none"> ‣ Check that the correct objective is positioned (eyepoint C or D). ‣ Check the position of the aperture diaphragm. ‣ For a fixed Transmitted Light arm: Check that the IMC modulator and the IMC slit diaphragm slider are inserted correctly and engaged in the IMC position. ‣ For a tiltable Transmitted Light arm: Check that the IMC module is inserted correctly and engaged in the position compatible to the objective. ‣ Check that the correct condenser (S40/0.45 or S80/0.30) is positioned and that the condenser height is correct. ‣ Switch off the fluorescence filter. ‣ Open the aperture diaphragm completely. ‣ IMC modulator in IMC position.
Fluorescence	
The image is completely dark (no fluorescence).	<ul style="list-style-type: none"> ‣ Open the shutter. ‣ Check the antigen-antibody combination. ‣ Switch over to the active port (or Infinity Port).
The fluorescence is too weak.	<ul style="list-style-type: none"> ‣ Unsuitable specimen (stored incorrectly, too old, bleached). ‣ Unspecific filter combination. ‣ Objective with too low of a numerical aperture. ‣ Eyepiece magnification too high. ‣ Room where microscope is located too bright. ‣ Incorrect beamsplit on the trinocular tube. ‣ Secondary light due to reflection at condenser.

7. Care of the Microscope



Caution!

Unplug the power supply before performing cleaning and maintenance work!
Protect electrical components from moisture!

Microscopes in warm and warm-damp climatic zones require special care in order to prevent the build up of fungus. The microscope should be cleaned after each use, and the microscope optics should be kept painstakingly clean.

7.1 Dust Cover



Note:

To protect against dust, cover the microscope and accessories with the dust cover after each use.



CAUTION

Let the microscope and lamp housings cool down before covering the stand with a dust cover. The dust cover is not heat-resistant. In addition, condensation may occur.

7.2 Cleaning

! Caution:

Residual fiber and dust can create unwanted background fluorescence during fluorescence microscopy.

Cleaning coated parts

Dust and loose dirt particles can be removed with a soft brush or lint-free cotton cloth.

Clinging dirt can be cleaned as necessary with a low-concentrated soap solution, petroleum ether or ethyl alcohol. For cleaning coated parts, use a linen or leather cloth that is moistened with one of these substances.

! Caution:

Thinners containing acetone, xylene or nitrogen can harm the microscope and thus must not be used.

Test cleaning solutions of unknown composition on a less visible area of the unit first. Be sure that coated or plastic surfaces do not become matted or etched.

Cleaning the specimen stage

Remove light-colored spots on the stage by rubbing with paraffin oil or acid-free Vaseline.

Cleaning glass surfaces and objectives

The cleaning of glass surfaces and objectives in particular should be carried out exclusively as outlined in the brochure "Cleaning of Microscope Optics". The information can be downloaded at:

<http://www.leica-microsystems.com/products/light-microscopes/life-science-research/inverted-microscopes>

Select the microscope type and go to the "Download" page.

In case of questions, please contact our Technical Service.

Removing immersion oil



Caution!

Follow safety notes for immersion oil!

First, wipe off the immersion oil with a clean cotton cloth, and then re-wipe the surface several times with ethyl alcohol.

7.3 Handling acids and bases

For examinations using acids or other aggressive chemicals, particular caution must be taken.

! Caution:

Never allow the optics and mechanical parts to come into direct contact with these chemicals.

8. Essential Consumable and Spare Parts

Order No.		
Material No.	Name	Used for
<u>Screw cap for unused objective receptacles</u>		
020-422-570-000	Screw cap M 25	Objective nosepiece
<u>Cover for unoccupied objective-DIC-disk opening</u>		
11 090-144-020-088	DIC cover	microscope stand
<u>Dust and light stop for analyzer opening</u>		
11 020-437-101-013	Analyzer opening cover	microscope stand
<u>Dust and light stop for camera port openings</u>		
11 020-387-556-009	Analyzer opening cover	microscope stand
<u>Replacement eyecup (antiglare protection) for HC PLAN eyepiece</u>		
021-500-017-005	HC PLAN eyecup	10x/25 eyepiece
021-264-520-018	C PLAN eyecup	10x/22 eyepiece
021-264-520-018	HC PLAN eyecup	10x/20 eyepiece
<u>Immersion oil in accordance with DIN/ISO standards, fluorescence-free</u>		
11 513 859	Type F, ISO 8036, Very low self-fluorescence Expressly recommended for fluorescence applications and all APO objectives, 10 ml	OIL and IMM objectives and oil condenser heads
11 513 860	Type N, ISO 8036, Low self-fluorescence, 20 ml	
11 513 861	Type N, ISO 8036, Low self-fluorescence, 250 ml	
<u>Screws for the fluorescence nosepiece cover</u>		
11 703 121 630 000	DIN 912 Allen screw M4x6 lens head	Cover of the fluo turret disk for laser microscope systems

Additional spare parts such as cover caps, stickers, screws, dust covers etc., on request.

9. Appendix

9.1 Assigning the variable function keys

The variable function keys can always be defined by the user via the LAS X software.

Depending on the configuration, useful functions are already assigned to the function key upon delivery.

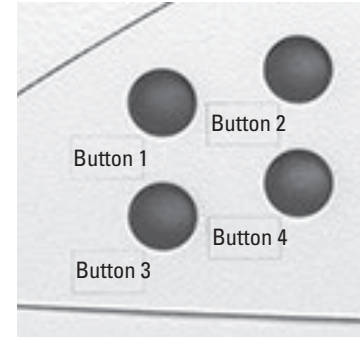

Preassigning the function keys:









Biological applications Microscope with Magnification Changer:	
Button 1	TL
Button 2	Photo
Button 3	Toggle Magnification Changer
Button 4	Toggle bottom port (if present) Otherwise: Port switchover

Biological applications Microscope without Magnification Changer:	
Button 1	Switch through objectives to the right
Button 2	Photo
Button 3	Switch through objectives to the left
Button 4	Toggle bottom port (if present) Otherwise: Port switchover

Industry applications Microscope with Magnification Changer:	
Button 1	TL
Button 2	Photo
Button 3	Toggle Magnification Changer
Button 4	Toggle ports

Industry applications Microscope without Magnification Changer:	
Button 1	Switch through objectives to the right
Button 2	Photo
Button 3	Switch through objectives to the left
Button 4	Toggle ports

Possible assignments of the variable function keys to the stand and SmartMove:

Function button	Function
BF	Brightfield Transmitted Light
PH	Phase Contrast Transmitted Light
ICT	Interference contrast, Transmitted Light
DF	Darkfield Transmitted Light
POL	Polarization Transmitted Light
CHANGE TL 	Switches through all Transmitted Light contrast methods
INT ↑	Increases the brightness (Transmitted Light)
INT ↓	Reduces the brightness (Transmitted Light)
AP ↑	Opens aperture diaphragm (Transmitted Light)
AP ↓	Closes the aperture diaphragm (Transmitted Light)
FD ↑	Opens the field diaphragm (Transmitted Light)
FD ↓	Closes the field diaphragm (Transmitted Light)
SHT TL	Opens/closes the Transmitted Light shutter
CHG FLT	Switch TL filter
FLUO	Fluorescence (last filter cube)
CUBE 1-6	Chooses the fluorescence cube at position 1-6
CUBE 	Switches through the fluorescence cube clockwise (1 → 6)
CUBE 	Switches through the fluorescence cube counterclockwise (6 → 1)
CHG FLUO	Switches through all fluorescence cubes
INT FLUO ↑	Increases the brightness (fluorescence)
INT FLUO ↓	Reduces the brightness (fluorescence)
FD FLUO ↑	Opens the field diaphragm (fluorescence)
FD FLUO ↓	Closes the field diaphragm (fluorescence)
CHG FW	Toggles the filter wheel functions
IFW	Activates the internal filter wheel
SHT FL	Opens/closes the fluo shutter
ExMan	Activates the excitation manager
FIM	Activates the fluorescence intensity manager
COMBI 	Combination method (PH fluorescence or DIC fluorescence)
CHG CB 	Switches through all combination methods
CHG OBJ 	Switches through objectives clockwise
CHG OBJ 	Switches through objectives counterclockwise
DRY/IMM	Switch dry/immersion
CHG  Mag.-Chg.	Switches through the Magnification Changer clockwise
XY PRECISE	Activate stage precisely
1x Tube lens	Activate lens 1x
Z COARSE	Enable coarse focus
XY PRECISE	Activate stage precisely
XY FAST	Activate stage quickly
Bottom P 	Bottom port on/off
AFC ON/OFF	Switches AFC on/off
AFC HOLD	Holds the current position
Acquire Image/Photo	Capture an image with the camera





Additional abbreviations for objective names, filter name, magnifications.

9.2 Abbreviation glossary





AFC	Adaptive Focus Control
AP	Aperture diaphragm
BF	Brightfield
COMBI	Combination methods
CUBE	Fluorescence cube
DF	Darkfield incident / Transmitted Light
DIC	Differential Interference Contrast
ExMan	Excitation manager
FD	Field diaphragm
FIM	Fluorescence intensity manager
FLUO/Fluor	Fluorescence axis (incident light)
ICR	Interference contrast, incident light
ICT	Interference contrast, Transmitted Light
IFW	Internal filter wheel
IL	Incident light
INT	Intensity
IMC	Integrated Modulation Contrast
IPH	Integrated Phase Contrast
PH	Phase Contrast
POL	Polarization, incident / Transmitted Light
TL	Transmitted Light
SET	Set focus position or lower threshold
SHT	Shutter
$\overline{\uparrow}$ Z	Focus position
$\overline{\downarrow}$ Z	Lower threshold

9.3 Overview of Touch Screen pictograms



Navigation bar

-  Basic microscope settings
-  Contrast method
-  Magnification
-  Stage and focus controls
-  Touch screen settings



Menus

-  Status/illumination
-  Memory function
-  Focus operation
-  Stage operation
-  AFC (Adaptive Focus Control)

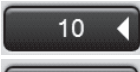

Z-drive

-  Focus position
-  Lower threshold





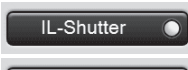



Objectives

-  10 Valid dry objective
-  25 Valid immersion objective





Shutter

-  IL-Shutter Incident-light shutter open
-  TL-Shutter Transmitted-light shutter closed



Observation ports

-  100% eyepiece
-  100% camera
-  Eyepiece/camera splitting
-  100% to lower, left or right port
-  Top port: eyepiece/camera splitting
-  Lower port/left or right port split
-  Left or right port split/top port with further splitting
-  Top port/rear port split

Control

-  Toggle button
-  Saving
-  Delete
For the table: reset working area to the maximum positioning range of the stage
-  Reload
For the table: move the current stored position

Various

-  Touch Screen calibration
-  Call up the version number

9.4 Additional information

General microscopy

Refer to the Leica Science Lab

<http://www.leica-microsystems.com/science-lab/>

to find additional useful information and instructions on the microscope methods.

Under the category "Basics in Microscopy", you can find, for instance:

- The instructions for setting the correct Koehler illumination
- The procedure for contrast methods such as
 - Phase Contrast
 - Modulation contrast
 - Differential Interference Contrast
- Fluorescence techniques
- The instructions for cleaning the microscope optics

and much more.

Objectives

For information on the objectives such as the objective classes and the marking of objectives, refer to

<http://www.leica-microsystems.com/de/produkte/objektive/>

Accessories

The "Live on Stage" brochure provides an overview of the accessories for live cell microscopy including the various specimen stages, specimen holders and inserts.

You can download the brochure from

[http://www.leica-microsystems.com/de/produkte/Lichtmikroskope/Zubehör/Inkubationssysteme für Leica inverse Mikroskope.](http://www.leica-microsystems.com/de/produkte/Lichtmikroskope/Zubehör/Inkubationssysteme für Leica inverse Mikroskope)