

Gentle Lady

2-METER-SAILPLANE



Instructions

Introduction. The **Gentle Lady** sailplane was designed to be a gentle trainer for the beginning R/C modeler, yet to possess competition capability in the hands of the experienced glider pilot. As a very efficient machine, she reacts quickly to rising air (called lift, or thermals). To stay in the thermal, she can circle very tightly without falling off. The model has good penetration into the wind and can really “cruise” when desired. Before starting to build, read through these instructions and familiarize yourself with the plans. If a 6-1/2 ft. wing will not fit into your car, you will want to build the wing version with removable tips.

The **Gentle Lady** can be flown a number of ways: hand tow, high-start, slope soar, or power. The simplest method is hand tow, which resembles towing a kite into the air. High-start is a combination of elastic cord and tow line. When stretched, the high-start will gently tow the model up to an altitude of several hundred feet from which a flight of three minutes or more in dead air (no Thermals) can be obtained. A variation of the high-start is the more expensive powered winch, popular with glider clubs. If you live near unobstructed hills or ridges, slope soaring is easily possible, so long as you have a suitable landing area. Hand launching the model off the upwind side of the slope, directly into the wind, will enable you, with practice, to soar back and forth along the slope in the rising air for as long as the wind remains. Finally, the use of power is an excellent option, and this book and the plan show typical installations. For the modeler who wishes to power fly the **Gentle Lady** at all times, nose mounting of engine is recommended. Pod mounting has two advantages: the power pod assembly can be easily removed for flying the model as a pure glider, and engine oils are less likely to dirty the fuselage.

Warning

A radio-controlled model is not a toy. It is capable of causing serious bodily injury and property damage. It is the buyer’s responsibility to build this kit correctly and to properly install the motor, radio, and all other equipment. The first test flights should be made only with the assistance of an experienced R/C flyer. The model must always be operated and flown in accordance with the safety standards of the Academy of Model Aeronautics.

Per the Federal Communications Commission, you are required to use only those radio frequencies specified “for Model Aircraft.”

Pt. #2044- 2/97

© Copyright 1981 Carl Goldberg Products, P.O. Box818 Oakwood, Ga. 30566 Phone 678 450 0085

Items needed to complete this kit.

- 1 Radio Guidance system(2 channel minimum required)
- 2 Rolls covering material
- 1 2oz. bottle CA glue
- 1 CA accelerator
- 1 30 minute epoxy
- 1 Tub Balsa-tinted **CGP Model Magic™**.
- 1 Box #64 Rubber bands.
- 1 Servo mounting Tape
- 1 1/4 x 8 x 12” **CGP Foam Padding**
- CGP Scuff Guard** (To Protect Bottom From Scratching)

For Removable Tip Option

- 1 1/8” x 3” x 18” Balsa Sheet
- 1 Piece 3/32” Dia. x 6” Music Wire
- 1 3/32” x 6” **GCP Nylon Reinforcing Tape**

For Engine Power

Engine, Propeller, Mounting Screws, Nuts, and Washers

For Servo Mounting

CGP #360 Pushrod Connectors

Selecting Radio Control Equipment

Radio sets are battery powered with either dry cells or the more reliable, rechargeable nickel-cadmium (ni-cad) batteries. Although ni-cad powered units are more expensive, the cost of routinely replacing worn out batteries may be much higher in the long run. Many of the radio systems now available feature “servo reversing” switches which allow you to reverse the response of the servo. This simplifies radio installation and is worth considering. Exponential or dual rates are popular features which , if used properly, can help smooth out the flight of a sensitive model. Your local hobby dealer should be able to help you select the proper radio for your needs and skill level. And be sure to get a system designed for aircraft, as only certain frequencies are available for model aircraft.

Necessary Tools and Supplies.

- Miscellaneous Rubber Bands
- Roll of waxed Paper
- Modeling Knife and Single Edge Razor Blade
- Sandpaper(assorted grits, including Medium(150) and Fine(220-320)
- Sanding Block
- “T” Pins (at least 50)
- Building Board (24”x70”)
- Electric Drill
- 1/16” Drill Bit
- 1/8” Drill Bit
- Allen Wrench (.050 for #4 socket set screw)
- Small Screwdriver (1/8” Blade Tip)
- Covering Iron and Heat Gun
- Masking Tape
- Pliers
- Flexible Straight-Edge
- 30-60 Degree x 6” Triangle
- Pencil

Limited Warranty

Carl Goldberg Models takes pride in the care and attention given to the manufacture of components for its model airplane kits. The company warrants replacement of any materials found to be defective for their intended use, **prior to their use in construction of the aircraft**, provided the buyers requests such replacement within a one year period from the date of purchase and provided the defective part is returned, if so requested by the company.

No other warranty, expressed or implied, is made by the company with respect to this kit. The buyer hereby assumes full responsibility for the risk and all liability for personal or property damage or injury arising out of the buyer’s use of the components of this kit.

Introduction

Using This Instruction Manual

Before you start gluing and sanding, take some time to look through this entire instruction booklet. It is designed to guide you through the construction process step by step, so build in the order given in this book. Radio selection and installation, covering, and balancing and flying the model are all covered. Also spend time becoming familiar with the plans.

Like a full-size airplane, the Gentle Lady is built from basic structures (stabilizer, fin, wing, etc.), which are then assembled into the complete airplane.

Special procedures or comments will usually be explained before a step, so you will be prepared. If a step begins with a statement like "Note," "Warning," or "Important," it is a good idea to read through the step before doing it.

A check-off box appears at the beginning of each step. Check these boxes as you build, so you can tell at a glance what steps you have completed. Some steps require you to repeat them, as in the case of the left and right wing panel.

Some of the instructions deal with general procedures. Boxes are not needed for these sections.

How to read the plan

The plan shows the Fuselage (Body), the Wing, and the Tail Parts. Everything on the plan is drawn to full-size and shape and shows how the finished parts fit together.

The plan is drawn to show the model completely assembled, but as a result, the areas inside or underneath are covered up, making it hard to understand how these parts fit together. Therefore, for clarity, some parts are drawn with hidden lines, others with breakaway views, and some are entirely removed from the structure and shown separately.

For example, on the fuselage, the left side of the completed model has been removed to show the details inside. Sometimes a surface is broken away to reveal the detail behind or underneath. Dashed lines indicate details that are hidden behind or under another part of the surface.

The model is made from four varieties of wood: balsa, bass, birch, and various plywoods. Each kind of wood has its own characteristic end grain pattern (as viewed from the end) which has been drawn on the plan. You can easily use these end grain patterns to identify what kind of wood is shown for a part, if you are in doubt.

How to use the plan

The plan is used in several ways. The wings, stabilizer, and fin are assembled directly over the plan. Each wood part is matched over its corresponding location printed on the plan and pinned in place. To prevent ruining your plan from gluing your wings, etc. to it, cover the area you are working on with waxed paper or plastic kitchen wrap.

The paper the plan is printed on can expand or contract slightly with changes in temperature or humidity. Because of this, a preformed part such as the notched wing trailing edge may not exactly match the plan. This is no problem, as slight deviations in the outline or size will not noticeably affect flight performance.

Because the fuselage plugs together and is self-aligning, it is not built directly over the plan. However, make sure the stabilizer and fin are mounted square and true to the fuselage. As you assemble the fuselage, you will find the plan helpful in identifying parts and how things fit together.

The plan also shows the installation of a typical radio, battery and all remaining equipment and hardware needed to complete the model. By referring to the examples shown, you should be able to install your own radio, etc., even if it is not the same as what is shown on the plan.

Identifying Parts

Parts for the wing are bundled together; likewise, parts for the tail assembly are also grouped. Die-cut plywood and balsa sheets of common sizes are bundled together, so they are less likely to be damaged during shipping and handling.

The various screws, hinges, and fittings are packaged in plastic bags.

Preparing For Assembly

Place a flat, warp-free pinning board on your work bench. Any material that accepts pins, such as insulation board, soft plywood, or dry-wall (sheet rock) will work. **Important: any warps or bends in the pinning board will result in wings or tail surfaces that are also warped or bent, making your model more difficult to fly.** Make sure that the pinning board is flat by laying a straight edge across it. You may be able to correct a warped board by shimming its low areas.

Position the area of the plan (such as the stabilizer) on which you are going to build over the pinning board and tape it in place so the plan lies flat and wrinkle free.

Place a sheet of waxed paper or plastic kitchen wrap over the work area to prevent CA from sticking to your plan and ruining it.

Construction Tips

If you have never assembled a built-up model before, the following tips will prove helpful.

IMPORTANT: ALWAYS READ A FEW STEPS AHEAD. This will alert you to coming instructions and will help you plan accordingly.

You may find it convenient to empty all of the small parts from the hardware bags into a common container, such as a margarine tub. This will help you find items quickly.

When drilling any 1/16" holes in balsa, you may find it easier to twist the drill between your thumb and index finger. This procedure allows more control in positioning the drill on the center mark.

Punch out only the die-cut (D/C) parts you need as you proceed. This will help you keep track of parts, especially the small ones.

After completing each section of the aircraft, you may want to go back and reglue the joints, just in case some area has been missed. Be careful not to use too little glue, which will leave the model weak or too much glue, which can make the model heavy. Properly glued joints are important to the overall strength of the model. CA is recommended for most parts of the assembly, although epoxy may be used when more time is needed for careful placement.

Wood Parts

Be careful when removing parts (such as fuselage sides) from the die-cut sheets. Long parts are fragile until glued into a structural unit. If necessary, use a razor knife or razor saw to assist in the removal of parts from the sheet. Sometimes a little trimming and sanding can improve parts, where desired. Save scrap until the model is completed, in case a part is missing or damaged. Also, scrap is used in some building steps. Solid lines indicate die-cut parts; dashed lines indicate cuts to be made as described. Some easily recognized pieces, such as nose block, are not shown.

Parts Identification: Heavy lines indicate die-cut parts. Dashed lines indicate cuts to be made as described in the instructions.

About The Wood In The Kit

We strive to supply good quality materials in your kit. Wood parts are inspected with regard to the function they will serve. If an imperfection is spotted in a scrap corner of a die-cut sheet and doesn't affect actual parts, the sheet is considered acceptable. Also, internal stresses in wood are relieved as it is cut into parts. These relieved stresses may cause some parts to bow. Bows in wood parts (such as leading edges) readily straighten out as they are glued into a structural unit.

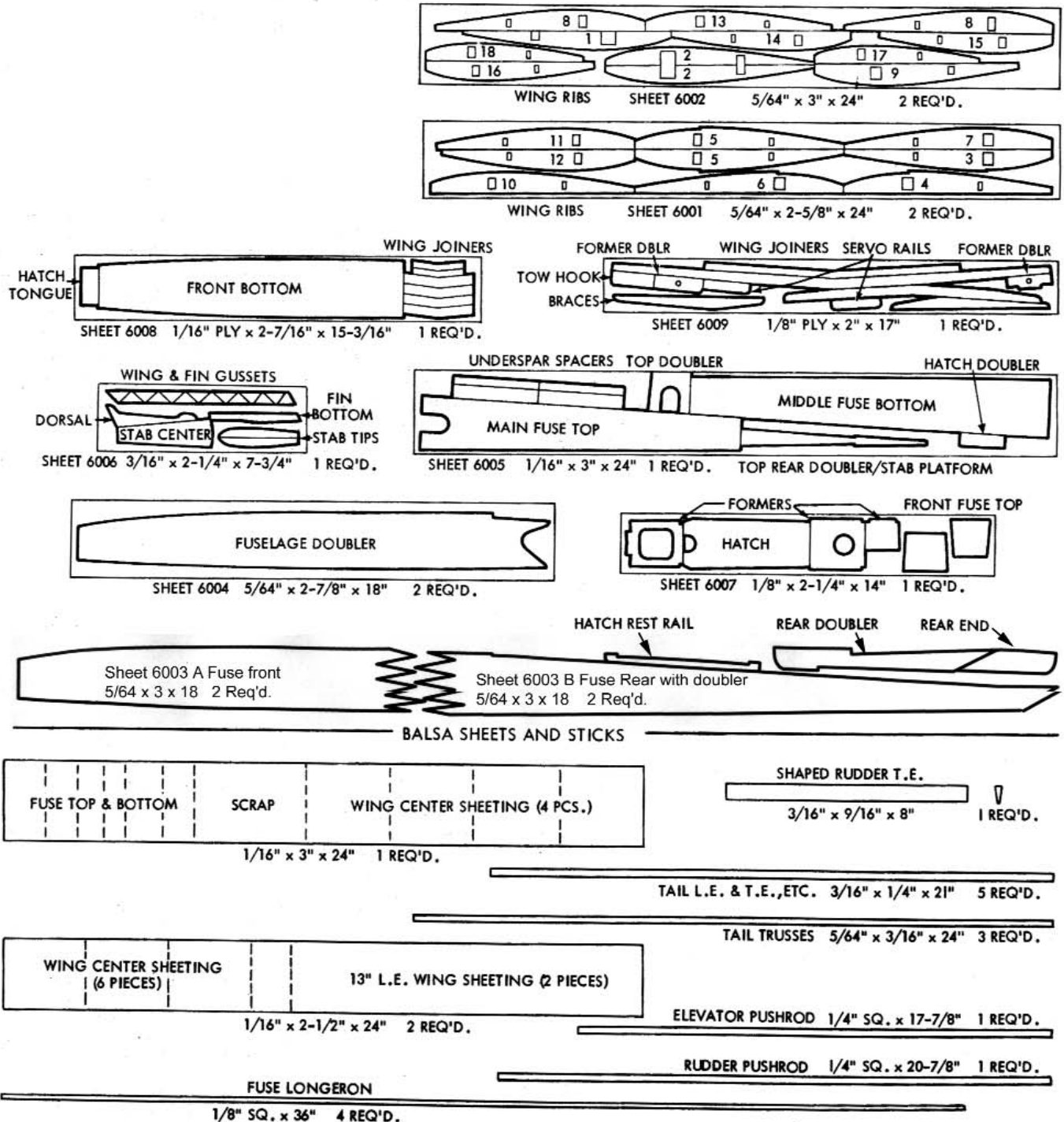

Horizontal and Vertical Stabilizer Construction (6 Steps)

Important: This booklet has recently been revised. Therefore, some of the steps in the booklet may not match what is shown on the plan. Whenever you find such a divergence, follow the instructions in this booklet.

1. Collect all of the items you will need to construct the HORIZONTAL STABILIZER. They include:

- | | | | |
|----------------------------------|----------|---|-----------|
| (1) D/C Sheet 6006 (3/16" Balsa) | Pt.#3455 | (5) TAIL L.E. & T.E. (3/16" X1/4" X21") | PT. #4697 |
| Includes: (1) STAB CENTER | | (3) TAIL TRUSSES (5/64" X3/16" X24") | PT. #4698 |
| (2) STAB TIPS | | (1) RUDDER T.E. (3/16" X9/16" X8") | PT.#4701 |
| (1) DORSAL | | (1) ELEVATOR GUSSETS | PT#4696 |
| (1) FIN BOTTOM | | | |

Select strongest pieces for stab L.E. and T.E.

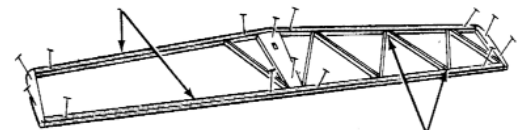

Fit trusses carefully. Don't force in place.

2. Lie the horizontal stabilizer portion of the plan over the building board and place the waxed paper over the plan.
- The main members of the tail assembly are 3/16" x 1/4" balsa strips. Check to see which strips are the strongest, and use these for the stabilizer. Lighter ones can be used in the fin and rudder.
- Pin in position and glue at center joint.
- Using die-cut stab tips, the center platform and 3/16" x 1/4" balsa, assemble stab outline.
- In cutting the diagonal trusses for the tail, trim them to fit well. If a bit oversize, don't force them in place. The pieces should fit before gluing. It's better to have them not meet at the points than to force them in.
- Let all parts dry thoroughly.

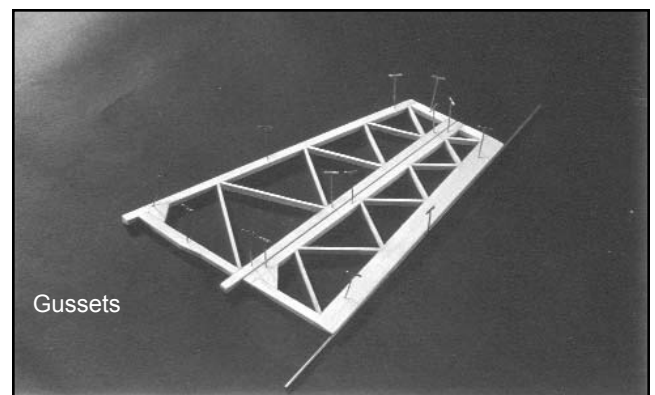

3. Assemble fin and rudder in same manner.

Note: Trailing edge of rudder is tapered.-use 1/16" x12" wire for shim as shown.

- Add gussets and let dry thoroughly.
4. **Temporarily tack-cement** elevator to stab, and rudder to fin (to be removed later). Flat sand parts for uniform smooth surfaces. Then sand edges, rounding corners and blending surfaces. **Important: Do Not sand the lower 2" of fin L.E. at this time.**
 - Carefully separate elevator and rudder from main units.
5. Lie the widest side of both 3/4" x 3/4" tri-strips down. Align strips using a straight edge and separate them by about 3". Pin in position.
 - Position elevator so that its trailing edge rests on top of tri-strips. Pin elevator in place.
 - Using a square cornered block, sand front surface of elevator to match with view on plan.

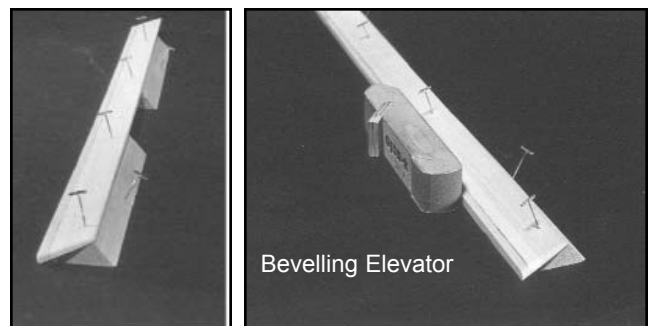
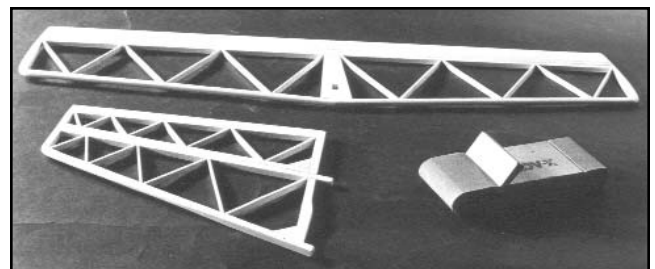

6. Pin down 3/4" wide side of one tri-strip. Position rudder so it rests against angled side of tri-strip. Pin in place.
 - Sand front surface of rudder to match with view on plan.

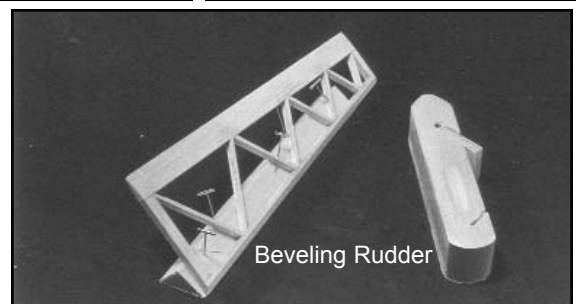

Wing Construction (13 steps)

Wing Terms Defined

Dihedral-The upward bend of the wings, which usually starts at wing center.

Polyhedral- Additional dihedral at the wing tips, often used with glider wings.

1. Collect the items needed to construct the WING. They include:

(2) D/C Sheet 6001 (5/64" x3" x24") Wing Rib	PT.# 3450	(2) Tri-strips (5/16" x5/16" x4")	PT# 4876
(2) D/C Sheet 6002 (5/64" x3" x24") Wing Ribs	PT# 3451	(2) Inboard T.E. (L)	PT# 4688
(1) D/C Sheet 6005 (1/16" x3" x24")	PT# 3454	(2) Outboard T.E. (S)	PT# 4689
		(2) Inboard L.E. (L)	PT#4690
		(2) Outboard L.E. (S)	PT#4691
Includes: Double Spar Spacers		(2) Inboard Main Spar (1/4" x7/16" x20-3/4") (Bass wood)	PT#4692
(1) D/C Sheet 6008 (1/16" Ply x 2-7/16" x 15-3/16")	PT# 3457	(2) Inboard Rear Spar (1/8" x1/4" x20-3/4") (Bass wood)	PT# 4693
Includes: Wing Joiners		(2) Outboard Main Spar (1/4" x7/16" x17-5/8")	PT# 4694
(1) D/C Sheet 6009 (1/8" Ply x2" x17")	PT# 3458	(2) Outboard Rear Spar 1/8" x1/4" x 17-5/8")	PT# 4695
Includes: Wing Joiners and Braces			
(1) Wing, Fuse Top & Bottom Sheeting (1/16" x3" x24")	PT# 4686		
(2) Wing Sheeting (1/16" x 2-1/2" x24")	PT#4687		

2. Place the plan on a building board or other flat surface. Working over the RIGHT INBOARD PANEL section of plan, pin inboard leading and trailing edges (L.E. & T.E.) in place. Align notches in T.E. with those shown on plan. Cut two pieces of bottom sheeting from 1/16" x 2-1/2" x24" balsa. Then fit and trim one piece from 1/16" x3" x24" balsa.

Assemble sheeting and glue to L.E. and T.E.

- Glue ribs 6 and 7 to L. E. and T. E.
- Position 1/8" ply spar brace in front slots, but **DO NOT GLUE AT THIS TIME.**
- 3 Continuing to work on a flat surface, position and glue remaining ribs 2 through 8.

- Position 1/16" die-cut balsa spacers in rib slots, and glue to bottom sheeting per sketch.

4. Sand dihedral angle in one end of bass wood main and rear spars, following angle indicated on plan.
- Insert spars through ribs, with dihedral angle at wing center joint. Use a flat block to sand spar ends flush with the L.E. and T.E. at sheeted end.
- Glue spars to ribs 5,6,7 and 8 **Only.**

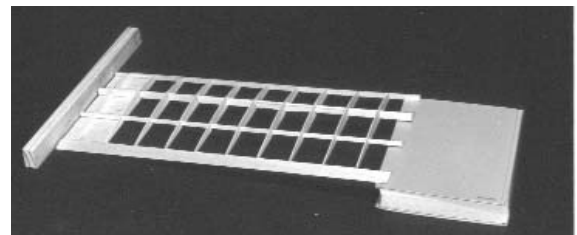
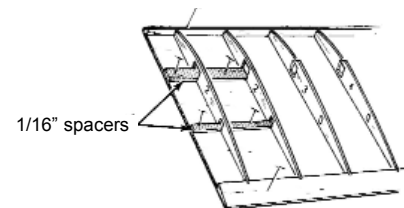
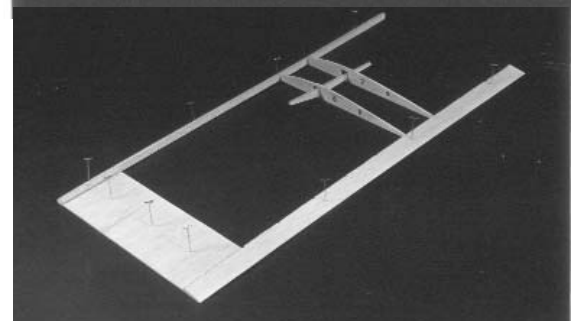
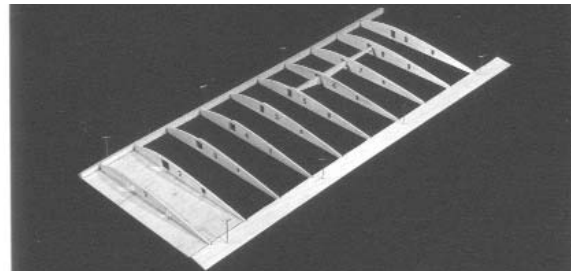

- Stuff double thickness of wing rib scrap into rib slots as shown in sketch to center spars in their respective slots. Glue spar bottoms to spacers.

- Glue spar brace firmly to spar. Let dry thoroughly.

5. Using a square-cornered sanding block, lightly sand L.E. and T.E. to match with spar angles.

6. Pin **RIGHT OUTBOARD** L.E. and T.E. in place over plan.
 Position and glue ribs 10 through 18. Add gusset at corner of rib 18 and T.E.

Scrap material for spacing-Do not glue

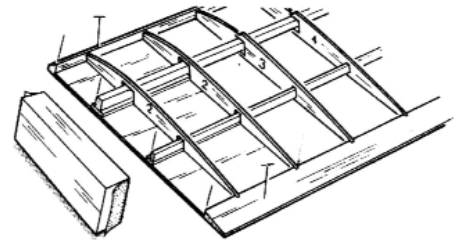
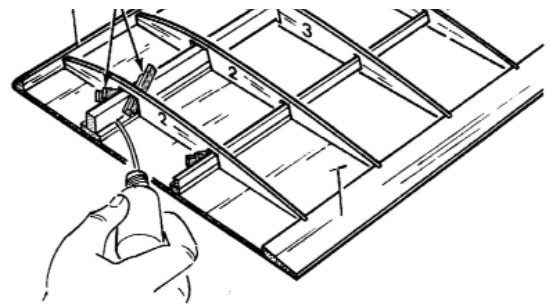

NOTE:IF YOU ARE MAKING THE WING WITH THE REMOVABLE TIP OPTION, OMIT THE NEXT 3 BOXES AND PROCEED DIRECTLY TO STEP 7.

- Sand one end of spars for proper polyhedral angle shown on plan.
- Slide spars in place (angled ends at rib 9 position), but do not yet glue.
- Lightly sand L.E. and T.E. to conform to spar polyhedral angles. **Proceed directly to Step 8.**

NOTE: Some people have wondered why we show an optional 3-piece wing. The reason is that, in a 2-piece wing, the structural requirements at the center are very high. This leads to a more difficult structure, and a heavier one. Having removable outboard panels is much simpler and lighter.

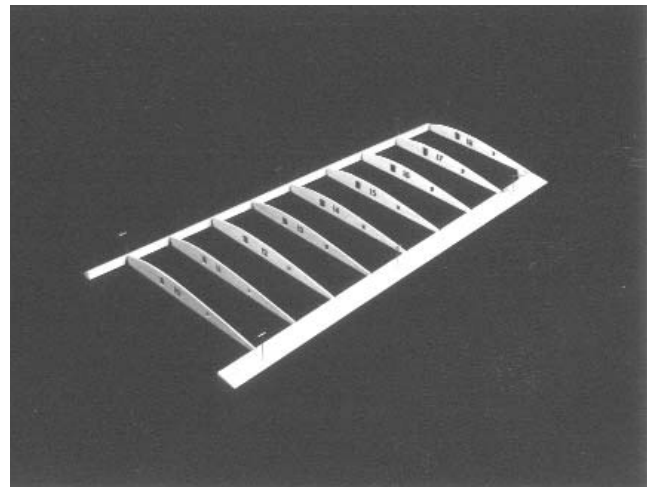

IMPORTANT

THIS STEP IS FOR THE REMOVABLE TIP OPTION ONLY!

7. Cut four new #9 ribs from 1/8" hard balsa, using rib pattern at upper right corner of plan labeled "REMOVABLE TIP OPTION." **Do not use die-cut rib #9.**
- Use **SANDING ANGLE TEMPLATE** (cut or copy from right corner of plan) and 1/8" ply scrap to establish proper sanding block angle, as shown in sketch.
- Slide outboard spars in place, but **do not glue yet.**
- Gently sand polyhedral ends of spars, L.E.'s and T.E.'s for uniform vertical surfaces.

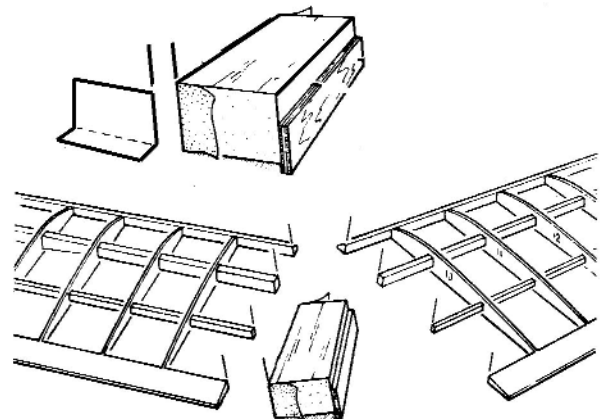

- ❑ Position outboard and inboard panels together at polyhedral joint. Raise wing tip end of outboard panel 4" off work surface. With outboard spars touching inboard spars, glue outboard spars to ribs.
- ❑ Position 3/32" x3" wire on back of spars as shown, and mark wire location on spars. Carefully groove spars for wire and brass tube respectively, as shown in TIP OPTION detail on plan.
- ❑ Tack-cement wire to outboard spar, and brass tube to inboard spar. Plug wing panels together, re-check wing tip height (4"), and observe that wing structures butt evenly at polyhedral joint. If corrections are necessary, rework grooves slightly, then reglue metal parts in place.
- ❑ Position the #9 ribs on spars and plug wing panels together. Butt these ribs at the polyhedral joint, tilting them slightly towards the inboard panel, so that they match the spar angles. Carefully glue ribs to their respective wing panels. **BE CAREFUL TO AVOID gluing the panels together.**
- ❑ Remove outboard panel. Using 3/4" wide nylon fabric and CA or Epoxy, securely bond wire and brass tube in place. Securely glue #9 ribs in place.
- ❑ Add gussets.

NOTE: Later on, after wing parts have been covered, the removable tip panels are fastened to inboard wing sections using vinyl electrical tape. This tape holds firmly, yet can be removed without damaging covering material.

PROCEED DIRECTLY TO STEP 9.

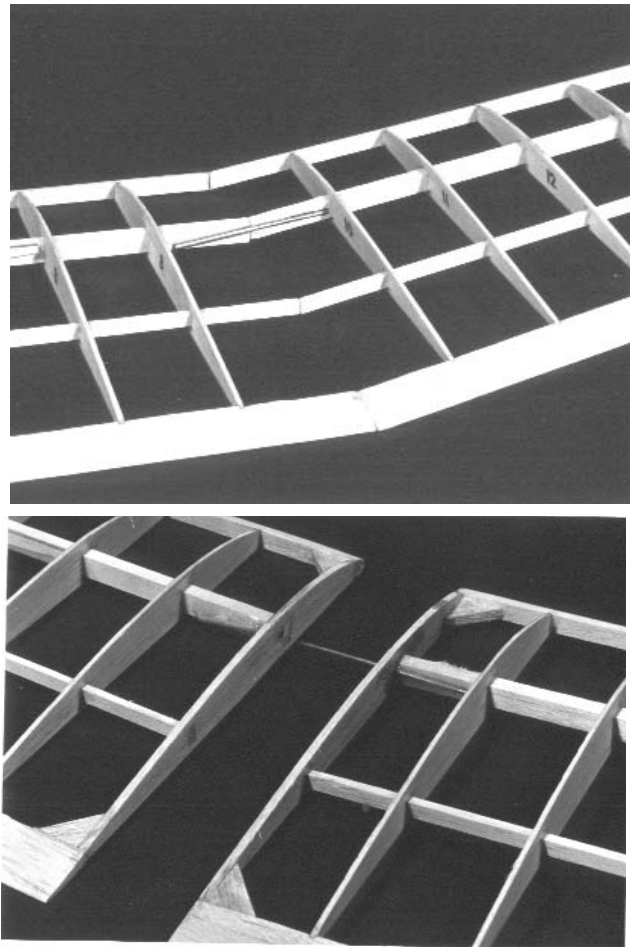

NOTE: Some people have tried to get a slightly better glide with the Gentle Lady by flattening the polyhedral of the wing somewhat. Unfortunately, this degrades the turning ability of the ship and it is no longer able to respond quickly. We recommend keeping the polyhedral measurements as indicated.

8. ❑ Position rib #8 on inboard spars, and slide it over next to rib #8.
 - ❑ Position outboard and inboard panels together at polyhedral joint. Raise wing tip 4" off work surface. Join inboard to outboard spars using 1/16" ply joiners. Clamp until dry.
 - ❑ Glue L.E. and T.E.'s together.
 - ❑ Glue rib #9 at polyhedral joint and add gussets.
 - ❑ Glue outboard spars to ribs.
9. ❑ Repeat steps 2 through 8 for left inboard and outboard panels
10. ❑ Trim off excess spar material extending beyond ribs #18. Glue balsa tri-strips in place on wing tips.
 - ❑ Carve and sand, *following top contour* of rib (see plan).

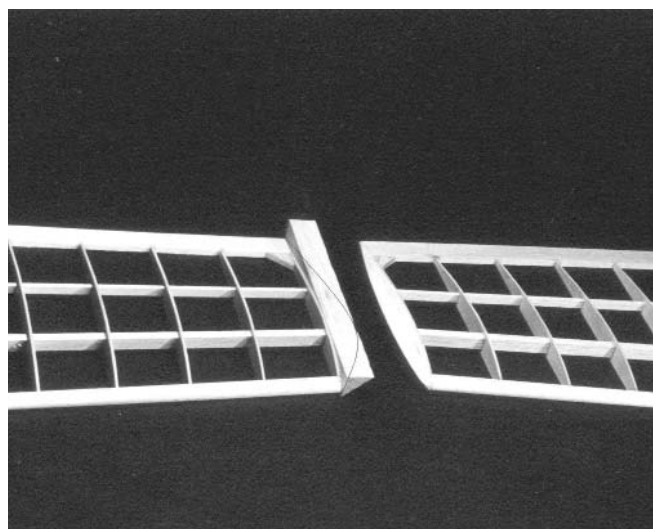
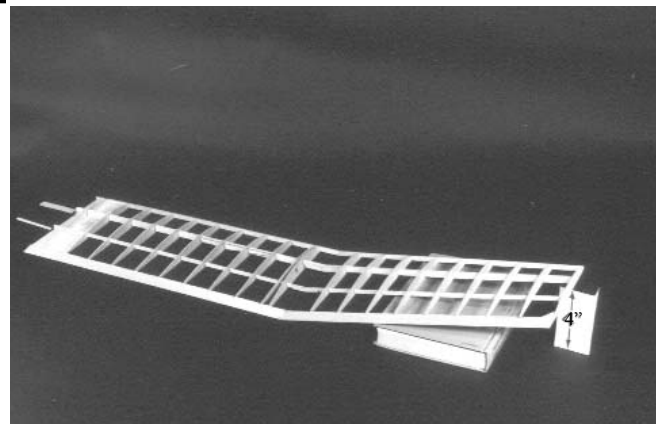

11. **DO NOT USE GLUE YET. Temporarily** join wing panels, using 1/8" ply joiners. Observe and correct fit and placement of parts for proper dihedral angle. (Each tip should be about 6-3/8" above the work surface.) Separate panels and remove joiners.
 - Now, permanently glue** joiners into one side of wing. Working carefully, apply a slow setting glue, such as **Slow ZAP**, to joiners and slide them into position. Clamp until dry.
 - Apply glue to joiners, ect., and join both wing halves. Again check for correct dihedral-each wing tip should be about 6-3/8" above the table. Clamp joiners and let wing assembly dry thoroughly.
 - Glue ribs #2, 3 and 4 to spars and joiners. Turn wing upside down and glue ribs #3 through #18 to spar bottoms. Examine entire wing, top and bottom, for any joints which still need to be glued.

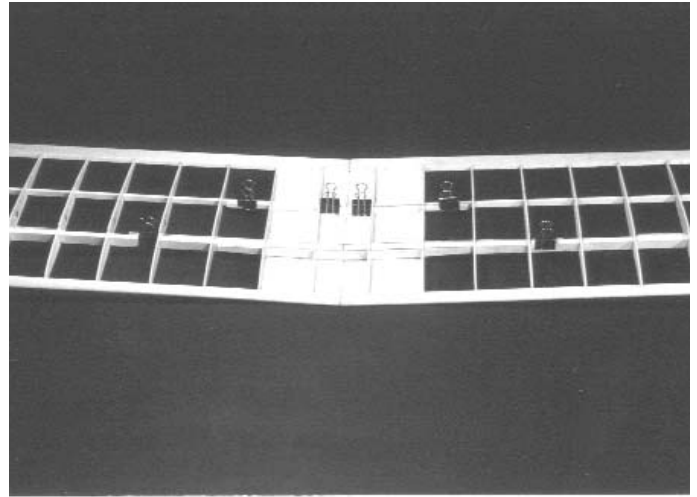

12. Glue two of rib 1 together to make double thickness rib.
 - Glue doubled rib 1 at dihedral joint.

NOTE: If you're going to fly a lot in windy weather or use a powerful winch, you may want to strengthen the wing as follows. Before adding the sheeting in step 12, notch each rib from the top down to the spar, on ribs #1,2,2,3, 4 and 5. Glue to the top of the spar a strip of hard balsa 3/16"x1/4"x10-3/4" (not furnished), and sand it lightly to match the rib curvature. When the sheeting is glued in place, glue it also to the 3/16" strip.

- Cut L.E. sheeting from 2-1/2" balsa. Glue sheeting securely to L.E., ribs and center joint.
 - From 2-1/2" and 3" wide balsa, make remaining sheeting pieces and glue in place.
13. Cut and sand a recess in T.E. at dihedral joint for rubber bands.
 - Flat sand entire wing smooth.

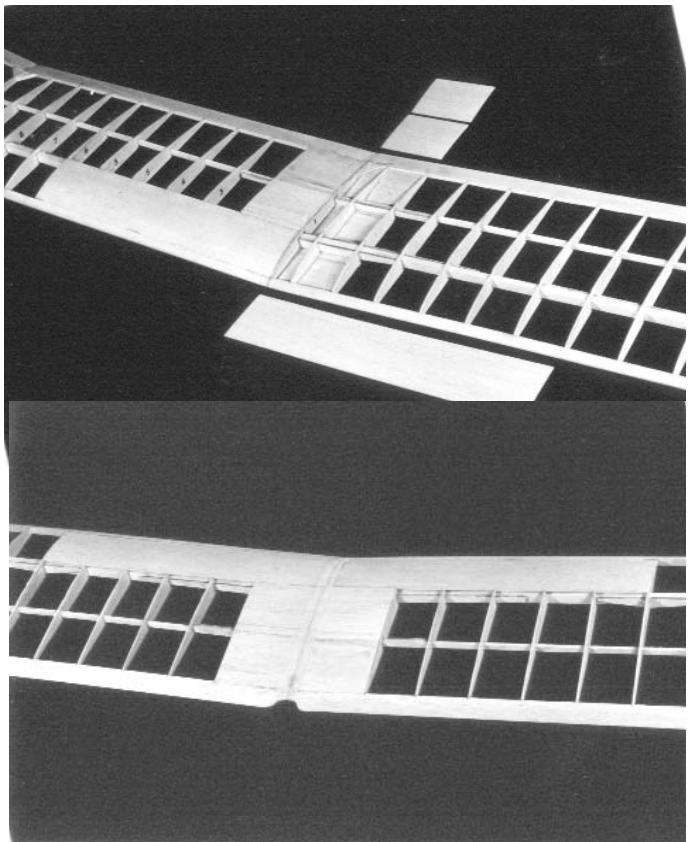
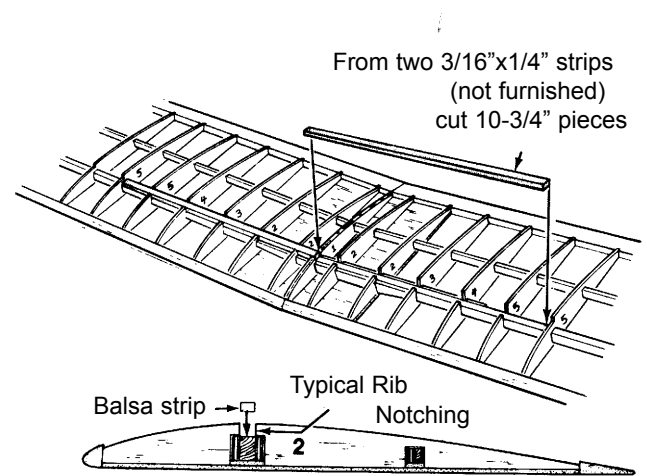

FUSELAGE CONSTRUCTION (18 Steps)

1. Collect all of the items you will need to construct the FUSELAGE. They include:

(1) D/C Sheet 6008 Front Bottom/Triplers (1/16"x2-7/16"x15-3/16" ply)	PT#3457	(2) D/C 6003 (5/64"x2-7/8"x36") Fuselage Side 2 front and 2 rear	PT#3452
(1) D/C Sheet 6009 (1/8"plyx2"x17") Doublers/Servo rails	PT#3458	(1) D/C Sheet 6007 (1/8"x2-1/4"x14") Formers/Hatch	PT#3456
(1) D/C Sheet 6005 (1/16"x3"x24") Main fuse top/Middle fuse bottom	PT#3454	(1) Balsa sheet/Fuse top (1/16"x3"x24")	PT#4686
(2) D/C Sheet 6004 (5/64"x2-7/8"x18") Fuselage doubler	PT#3453	(1) Firewall (1/8"x1-7/16"x1-9/16"ply)	PT#4685
		(1) Nose Block	PT#4704
		(4) Fuse longeron (1/8"SQ. x36")	PT#4705
		(2) Dowel (3/16"x3/4")	PT#1746

Fuselage side construction

2. Locate the front and rear half of each fuselage side. They will need to be glued together at the finger joint to form a complete side.
- Trial fit the front and rear half of the fuselag sides.

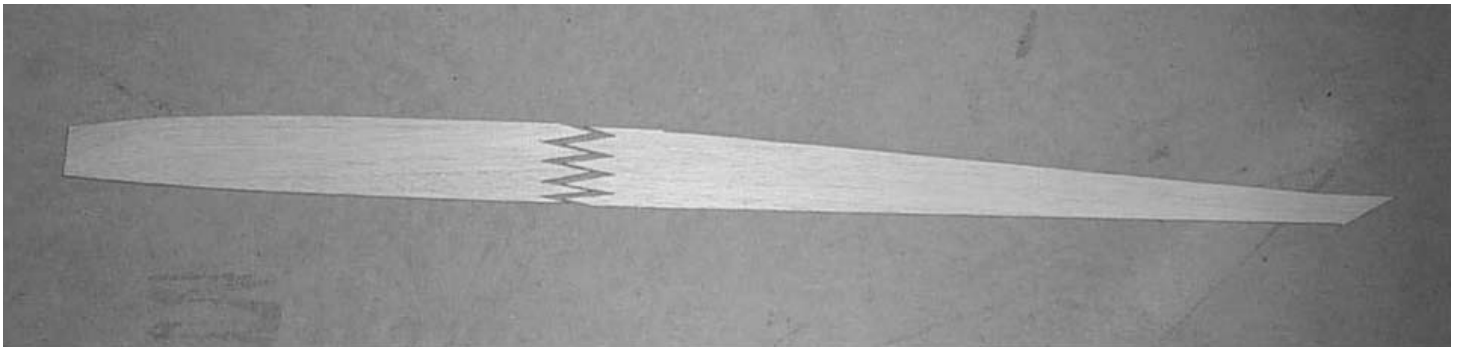

3. Lay out a piece of wax paper over the plans long enough to cover the fuselage sideview.
- Use the plans as a guide to make sure the fuselage sides are straight. When everything is aligned properly glue with thin CA glue. You don't have to take the sides apart, the thin CA will "wick" right into the joint.
- After the glue has cured, use a sanding block and make sure the joint is smooth.

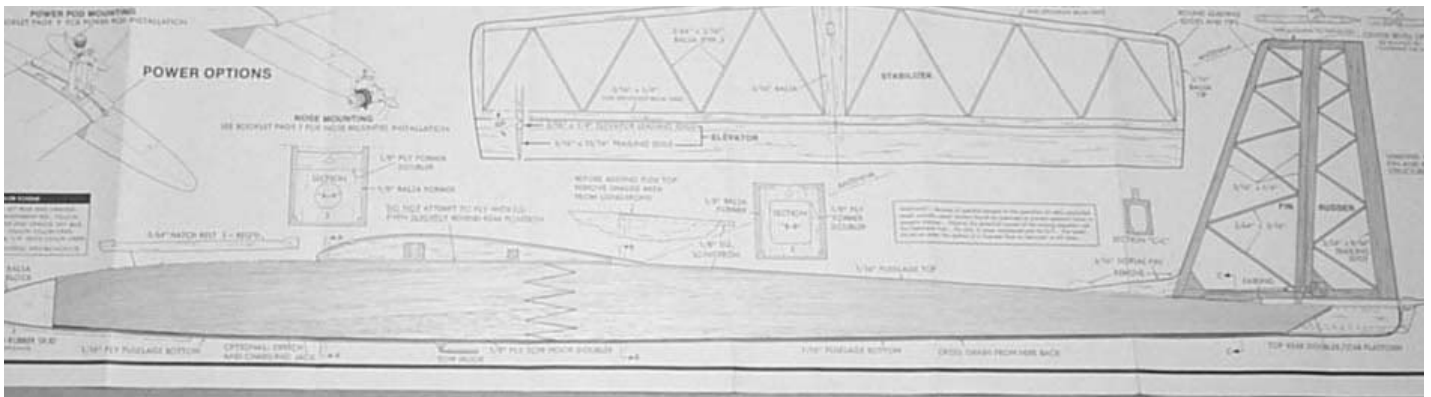

Fuselage

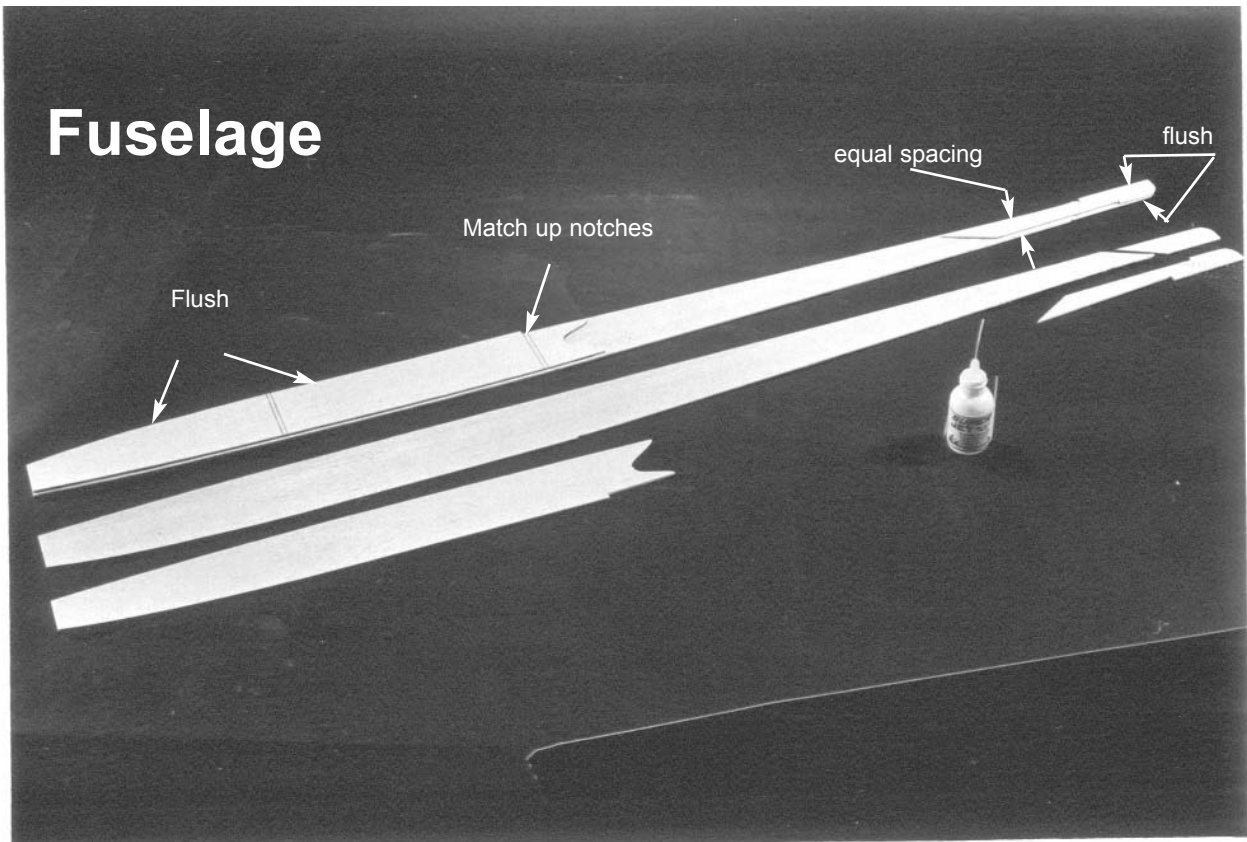

4. Glue rear pieces of fuselage (fuse) sides.
- Temporarily position doublers and check for fit and correct placement (flush along top edge).
- Glue doublers to fuse sides using CA or epoxy. Apply CA smoothly in a series of ribbons or stripes to the doubler. Then, when the doubler is

set carefully in correct position and pressed down firmly, the adhesive is squeezed into a very thin layer and sets up almost instantaneously. (Epoxy allows more time for application and adjustment.)

- Lie fuse sides over side view on plan and mark locations of formers 2 and 3.

5. Refer to plan for locations, then glue 1/16" ply tongue and balsa brace to hatch.
- Glue balsa hole doubler to fuse top.

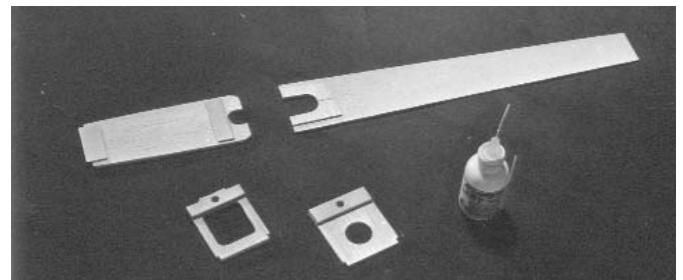

- Glue the 1/16" ply triplers to formers 2 and 3. Then glue the 1/8" ply doublers to the formers as shown.
- Carefully drill 3/16" dowel holes through formers using die cut holes in doublers as guides. When drilling, lay formers on scrap wood to prevent break out.

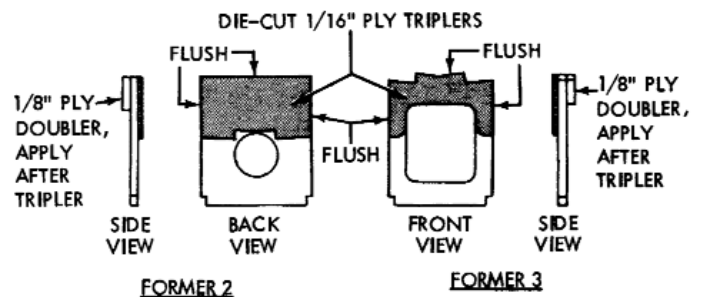

- 6. Refer to plan for correct location, then cut and glue 1/8" square longerons to sides. Top longeron starts at former 3 and bottom longeron starts at fuse front. **Both** longerons stop at notches in rear doubler.
- Glue formers 2 and 3 to right side. Refer to plan to see which way ply doublers face when properly installed.

Important: Make sure formers stand straight (not tilted) until dry.

- Glue left fuse side to formers 2 and 3 and let dry thoroughly. Make sure formers 2 and 3 are glued firmly to fuse sides. Re-glue the joints for additional strength.
- 7. From 1/8" die-cut sheet scrap, cut a spacer 1/2" square.
 - Position fuse assembly over top view outline on plan.
 - Pull fuse nose together, gluing former 1 in place. Use tape to hold joint.
 - Pull tail end together with spacer tack-cemented between (to be removed later). Spacer should be centered between fuse top and bottom. Hold with tape.
- 8. Position and glue hatch rests so that tops of spacing lugs are flush with fuse top, and rear lugs butt against former 2.

- When dry, trim spacing lugs off hatch rests.

- 9. Glue 3/16" dowels securely in formers 2 and 3.
- Glue front fuse top in place.

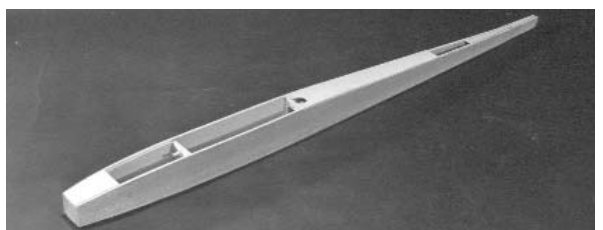
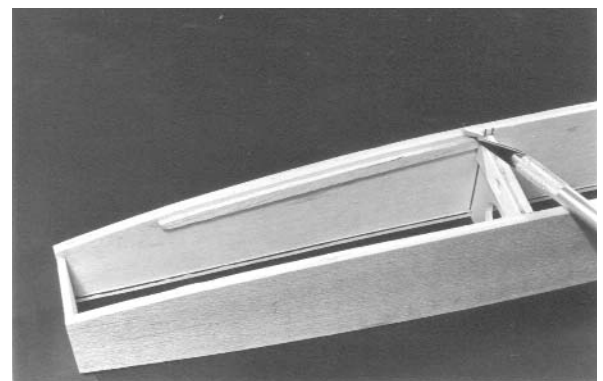
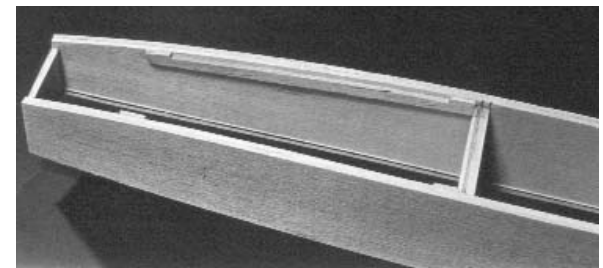
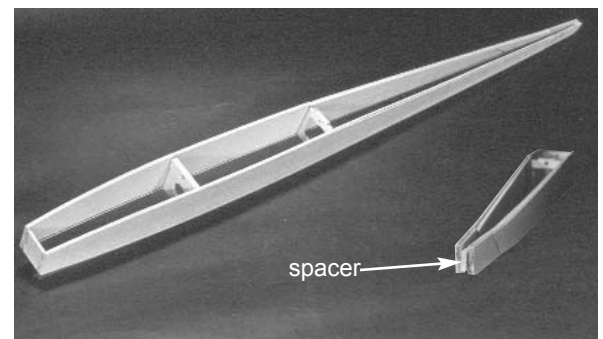
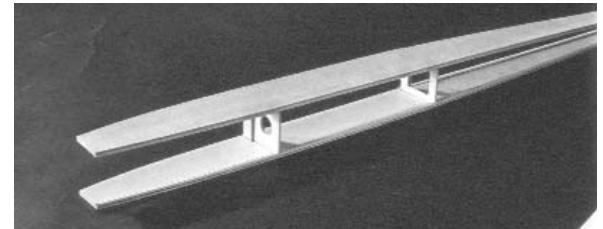
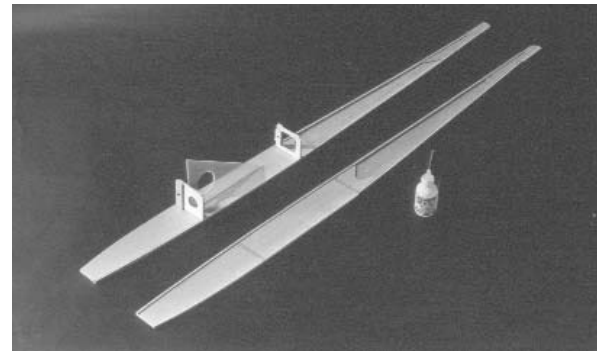

- ❑ Glue main fuse top, and top rear doubler/stab platform in place, and let fuse dry thoroughly. **Note:** Stab platform fits **between** the fuse sides.

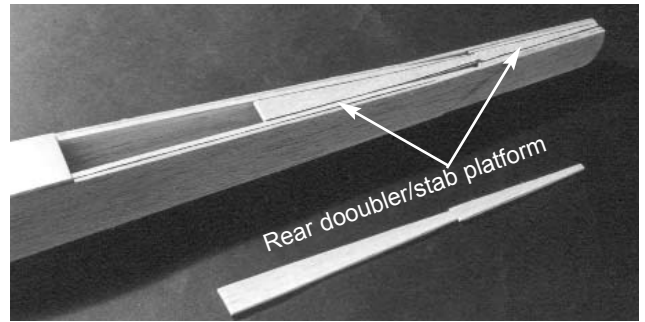

10.
 - ❑ Remove fuse from work surface, and glue 1/16" ply bottom and main balsa bottom in place. If necessary, spread sides in the hatch area to match the width of the 1/16" ply bottom.
 - ❑ From plan, locate the correct position for 1/8" ply tow hook doubler, and glue securely in place inside fuse.

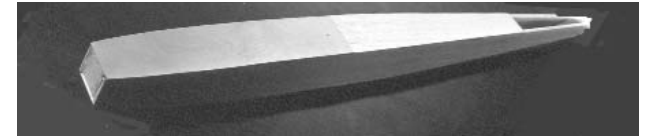

11.
 - ❑ From 1/8" square balsa cut two wing rails, and glue to fuse sides as shown on plan. **Note:** front end of rails is tapered.
 - ❑ Temporarily tack-cement hatch in place (it must be removed later!)
 - ❑ Glue nose block to fuse front (unless, of course, you intend to mount an engine there! In that case see next step).

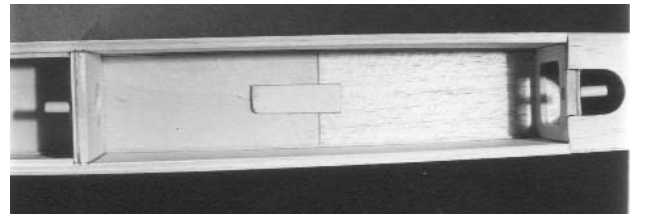

NOSE-MOUNTED ENGINE OPTION

12.
 - ❑ Remove tank and rotate it 90 degrees so you can side-mount engine. Side-mounting helps to keep gunk off model.
 - ❑ Center engine on 1/8" ply mount. Mark and drill 3/32" holes for engine mounting screws.
 - ❑ Install engine on mount using screws, washers and nuts as shown on the plan. Press mounted engine in position to impress nut locations into former 1. Make recesses in former 1 for nut clearance.
 - ❑ Gently sand fuse front to remove rough spots. Securely glue engine mount to fuse front. Let dry.
 - ❑ Remove engine for easier sanding of fuse.

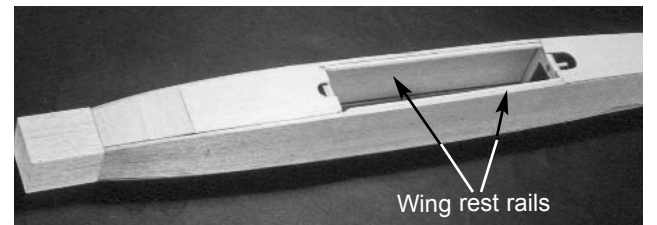

13.
 - ❑ From 1/16"x3"x18" balsa, cut rear top and bottom sheeting (grain running across fuse). Glue sheeting in place.

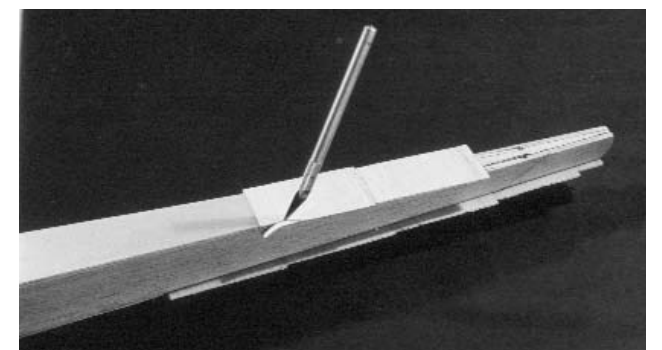
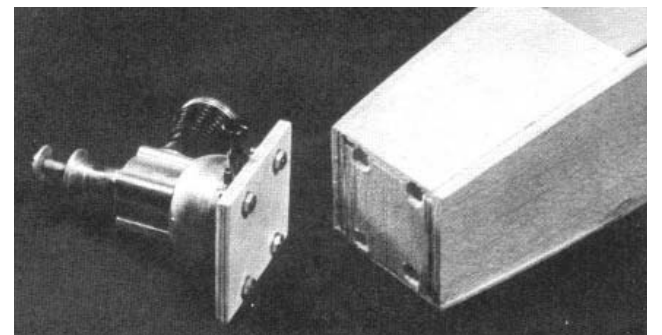

14. Remove 1/2" square spacer from tail end of fuse.
 Carefully drill or carve 1/4" hole at bottom of tail opening for pushrod exit.

NOTE: AFTER SANDING in Step 13, harden pushrod exit area using CA.

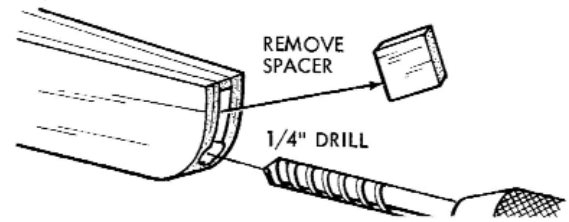

15. Carve nose to shape as shown in top and side views.
 Install wing, holding it in position with rubber bands.
 Trim hatch rear to match wing dihedral, so hatch will be held down by wing, yet can be slid back under wing 1/4".
 Flat sand hatch, nose and complete fuse. For easier covering, keep nose flat surfaced, with minimal rounding of corners. (**Caution:** excess sanding or trimming of stab mounting area can alter the incidence angle which has been die-cut on the fuse sides. Sand this area as little as possible).

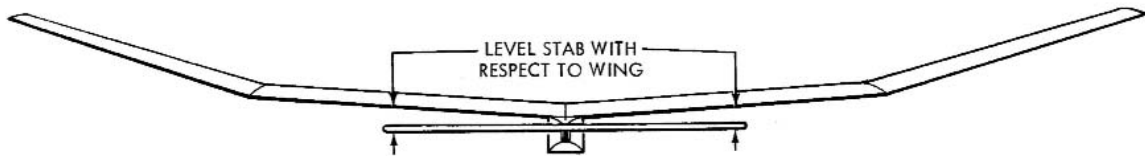
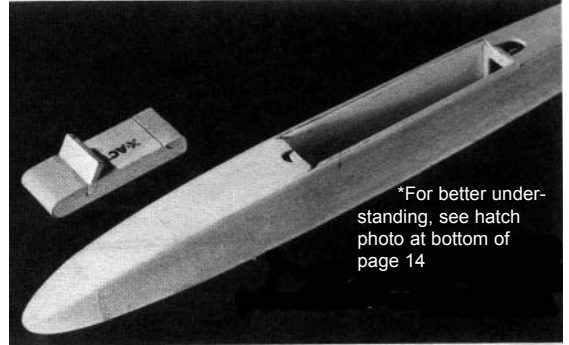

16. Rubber band wing in place on fuse. Viewing model from rear, see if stab sets level with respect to wing.
 Sand stab platform area as may be necessary to provide a good level fit for stab. Do not alter pre-set stab incidence angle (exactly horizontal in side view).
 Center stab on fuse using a tape measure to obtain equal distance from side to side, and from nose to rear corner of each stab tip. Pin in place. **DO NOT GLUE AT THIS TIME.**
 From 1/8" scrap make a stab leading edge fairing and glue in place on fuse. (**DO NOT GLUE TO STAB**).

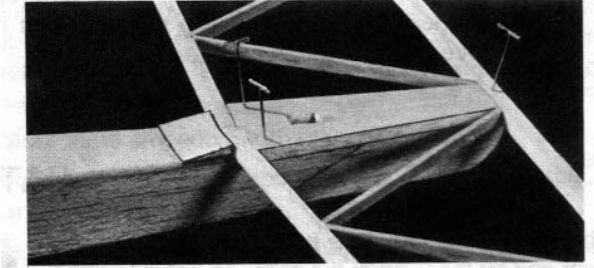

17. With stab centered on fuse, mark through stab center hole. Remove stab and cut hole in fuse top to receive fin trailing edge.
 Re-position stab on fuse and hold in place with pins. Insert fin trailing edge in stab center hole. View model from front and carefully align fin so it points exactly straight ahead. Pin in position.
 Mark location, then cut hole for fin leading edge in fuse top.

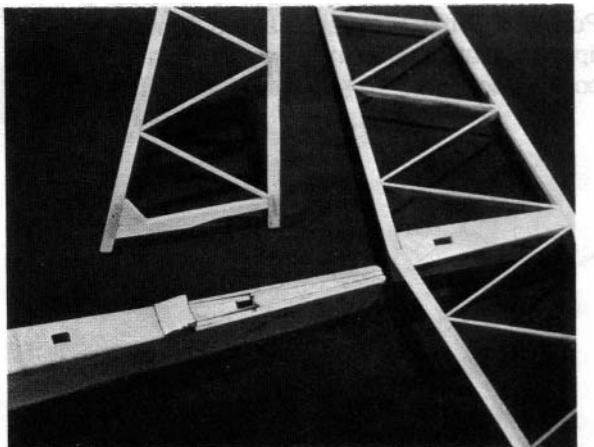

- Trial fit fin in place. Glue dorsal fin to fin, but not to fuse. When dry, watch grain and very carefully trim off die-cut bumps. Finish sanding.

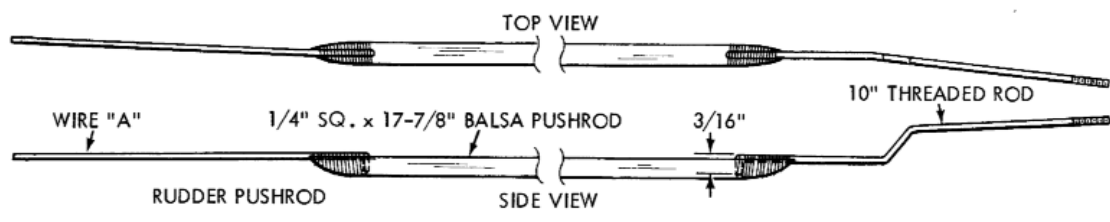
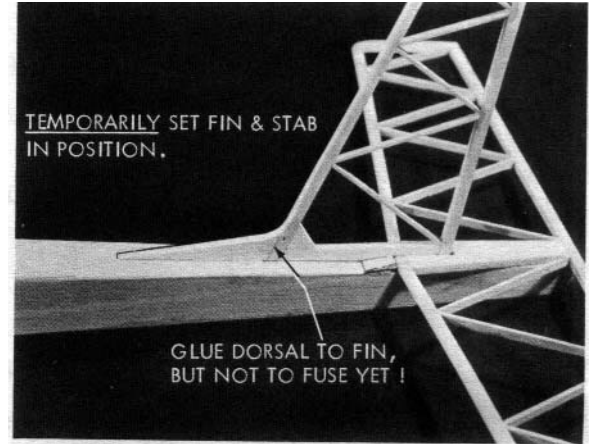

18. □ For rudder pushrod, bend 10" threaded rod as accurately as possible over plan. Cut off excess, leaving about 3/16" at right angle.
- Cut 1/16"x12" wire into two 6" pieces.
- Make 3/16" bend in one end of 1/16" wire "A". Drill holes near each end of balsa pushrod, and make a groove to recess wires part way.
- Glue wire "A" and threaded rod to balsa pushrod.
- When dry, taper both ends of pushrod, and round off corners. Bind with strong thread, and re-glug.
- Repeat process for elevator pushrod (Note: it is longer).

HATCH OPERATION

The hatch is held in place by the ply tongue at the front and by the wing at the rear. In order to open the hatch without removing the wing, the hatch rear is trimmed to allow it to slide back under the wing, thus releasing the hatch front from the fuse (see sketch below). After hatch is covered, a 1/4" Push-Pull Screw is installed at the front for fingertip manipulation (after installing screw in hatch, file point off bottom).

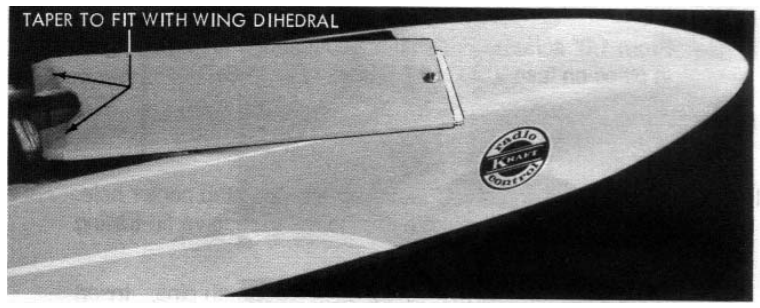

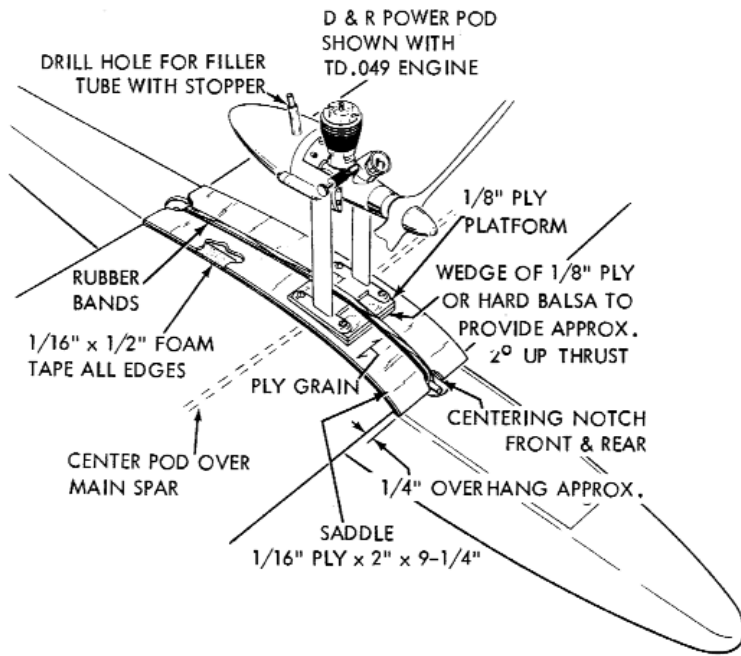

POWER POD OPTION

Make saddle from 1/16" ply x 2" x 9-1/4", grain going the 2" direction. Make center notches front and back for centering with wing hold down bands. Position 1/16" ply on wing with an approximately 1/4" overlap at leading edge, and tape or band to curve of wing. While in this position, add platform of 1/8" ply x 1-3/8" x 1-3/4" with 1/8" ply or hard base wedge underneath front to provide approximately 2 degrees upthrust. Center platform directly over main spar and cement to saddle. Drill four holes in base of power pod and screw to saddle platform. After fuel-proofing, finish, etc. Add four pieces of 1/16" by 1/2" foam tape on underside of saddle to protect top of wing surface.

COVERING

A good covering job should be preceded by careful sanding. Filling nicks and dents with **MODEL MAGIC™**, then more sanding. Any irregularities in the wood surface will show on the covering, so a smooth sanding job is a must for appearance. A simple color scheme, such as one main color plus some trim, is recommended for the novice.

COVERING THE WING

1. First read the directions which are supplied with every roll of covering. Cut a piece of covering slightly larger than one inboard panel and remove backing.
2. Position covering on bottom of wing and, using a covering iron (set at proper temperature), tack covering across center of wing. Working outward, firmly tack the covering to all ribs, and to the perimeter edges of the wing, gently smoothing out the larger wrinkles as you go. Besides sticking the film firmly to the end of the panel, run some of the film down the vertical side of the rib.
3. After sealing all edges, glide iron (or use a heat gun) over interior area to tighten the covering. Trim and iron edges.
4. When the bottom of the panel has been completed, repeat the process on the top side. Follow the same procedure for all wing panels.

Whenever overlapping one piece of the film on top of another, make sure you have at least 1/8" of the top firmly stuck to the one below for the full width of the joint. Otherwise, with little carelessness in tightening, you can find yourself having developed an opening to be patched. Where two transparent colors join, use **CGM ColorStripe** 1/4" wide to cover joint lines.

TRUING WING AND SETTING WASHOUT

Truing the wing is an **important** step, and should not be rushed or omitted. Also, "washout" (explained below) improves the wing's efficiency, and increases the glider's stability at slow speeds (prevents tip stalls).

1. Set inboard panel on a flat surface to detect warp. To counter any warp found, twist panel slightly in direction opposite to the warp, and hold position while gliding iron over covering to re-tension structure. Repeat process until panel is true.
2. Follow same procedure with other inboard panel.
3. Check first panel and correct any change caused by truing second panel.
4. Block up wing as shown so polyhedral break and outboard panel leading edge are flat on table. As necessary, twist wing while gliding iron over covering. Repeat process until 1/4" washout is achieved.
5. Follow same procedure for other outboard panel.

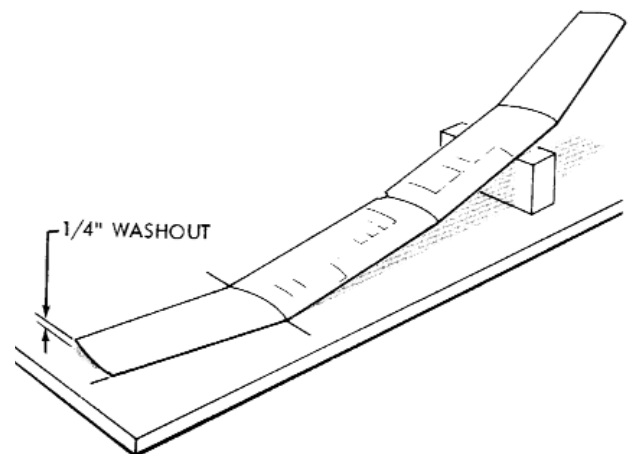

Covering the Tail

The rudder and elevator can be hinged using the film covering hinge technique. This combines covering and hinging into one operation. Conventional hinges may be used if you prefer. In that case, center beveling is recommended. The instructions below apply to fin and rudder also.

1. Make sure stab trailing edge and elevator leading edge are perfectly straight. Otherwise binding will occur.
2. Position 1/32" thick cardboard spacer along top of stab trailing edge and at least 1/16" back from edge (to avoid the film adhesive).
3. Apply covering to bottom of stab, up and around hinge joint, and elevator bottom.
4. Flop elevator full down, and remove spacer from stab top.
5. Apply top covering, and seal hinge and edges.
6. Complete covering by trimming off excess film, and adhering covering firmly to all wood structure except truss and ribs. Check for trueness on a flat surface, and correct as necessary.

COVERING THE FUSELAGE

A non-transparent film should be used on the fuse to avoid showing discolored areas where filler materials were used.

1. Cover the fuse areas in the following order: bottom first, then the sides, and the top last. **Do not cover stab platform.**
2. To minimize abrasion in landing, triple cover the underside from the nose to about 6" back.

Finally, it's a very good idea to place your name, address, phone number, AMA number and the word REWARD! permanently on the inside wall of the servo compartment. Then if your **Gentle Lady** should fly away for any reason, you'll have a chance of getting it back!

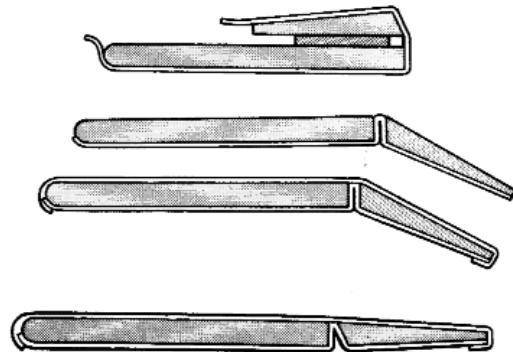
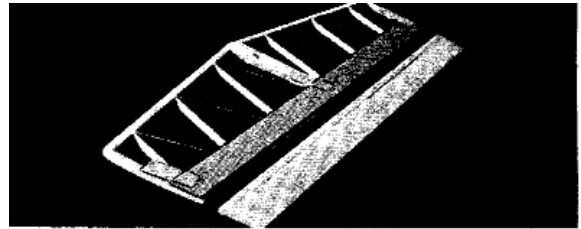
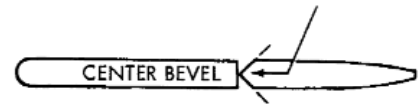

DECAL INSTRUCTIONS

Clean model surfaces thoroughly before applying decals. Cut decal sheets apart in sections as needed. Fold decal in half, front to rear. Open at fold and lay decal out straight, the protective backing will bubble away from decal at fold location. Using scissors, cut backing along bubble, removing about 1" wide strip of backing. Carefully position decal on model and stick in place. Working from center, rub decal down while peeling off backing.

FINAL ASSEMBLY

1. Obtain some 1/16"x1/4" wing seating foam tape and attach it to the wing rest areas of the fuselage. This prevents unexpected shifting of the wing.
2. Mount wing on the fuse using rubber bands (five #64s are used for flying). Measure carefully from the fuselage sides out to the polyhedral breaks (arrows 'A') to be sure that the wing is centered. Then measure from the polyhedral breaks to the back end of the fuse (arrows 'B') to make sure wing is square with fuse. Mark the wing and fuse with matching line-up points. The prototype uses white Color Stripe to indicate clearly when the wing is lined up.

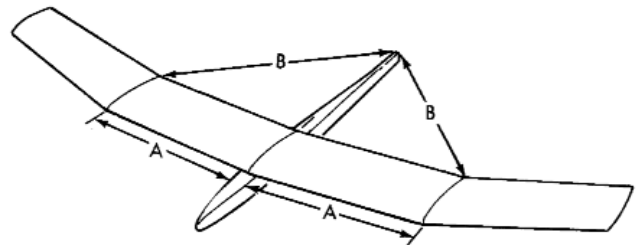

2. Trial fit stab in place on fuse, marking it for center, and adjust as necessary to line up with wing. Then measure from the stab tips to the fuse front (arrows 'C') to make sure stab is square with fuse. To provide a firm, balsa-to-balsa glue joint, strip covering (minimum 1/8") to retain firm covering bond to stab center. Be certain to leave enough covering bond to stab center. Likewise, if stab area on fuse was covered, remove covering. Glue stab firmly to fuse and let dry.

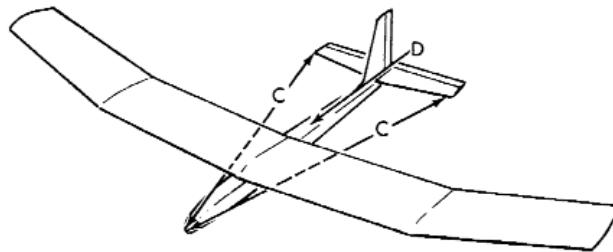

3. Trial fit fin in place on fuse/stab (arrow "D"). Strip covering from fin bottom (if covered) and respective area on fuse/stab. Glue fin firmly in place, and square with stab. Let dry.
4. After covering and final assembly, glue 4" long tri-strip in place as show above. Cover the top of the tri-strip with film before placement.

5. Remove the wing, and make hole on left side of fin for the rudder pushrod exit guide at location shown on plan. Trim off one side of the exit guide flange, so guide will fit flush against the fin.

6. Try the pushrods in working position inside the fuse, but without mini-snaps. Make adjustments as necessary so threaded rods head right for their control horns. Move pushrods back and forth to simulate servo action, and remove and adjust pushrods as necessary for smooth operation. If required, trim out channel inside fuse, going forward from exit guide hole, to make it easier to get threaded rod up to and out exit guide hole. When operation is satisfactory, glue exit guide in place.

- Re-install pushrods, and add mini-snaps to the threaded ends of pushrods.
7. To open mini-snap, insert small screw driver blade, then twist. Refer to plan for elevator control horn location. Connect mini-snap to bottom hole in horn, and hold horn in place on elevator. Move elevator up and down to observe control horn and mini-snap clearance through fuse tail exit. Shift control horn or trim exit as necessary. Mark location and install control horn on elevator.

8. Refer to plan for rudder horn location, and install horn.

9. Adjust rudder pushrod as necessary, and connect mini-snap to 2nd closest hole to hinge.

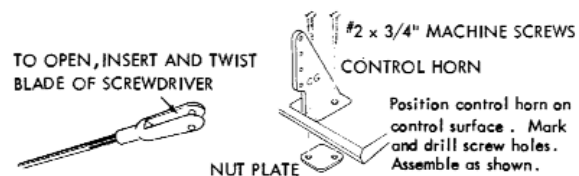
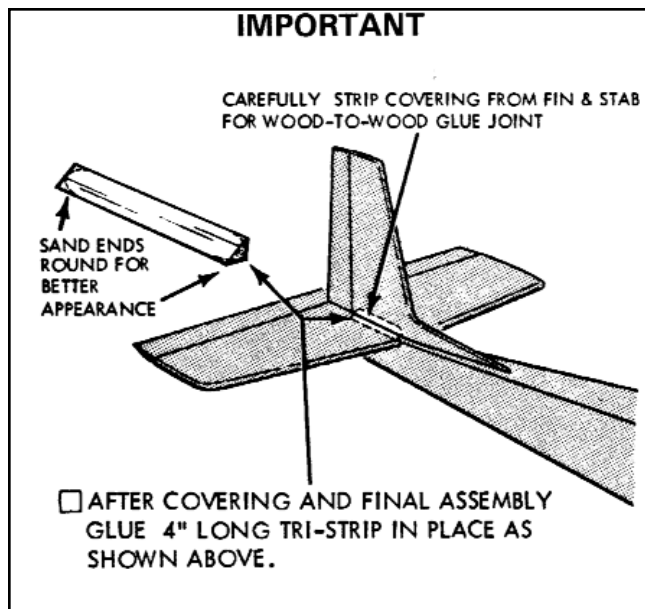

RADIO INSTALLATION

Prepare for installation

1. The pushrods should be in place in the fuselage and connected to the control horns. The wires at the front end of the pushrods should have some excess length, reaching close to former #2.
2. Read and follow the instructions that come with your radio.
3. If your batteries are dry cells, they should be fresh; if they are rechargeable nicads, they should be fully charged.

Radio Pre-Check

Assemble and try the radio before installation.

1. Move the control stick from side to side. Apply tape (on which you can write) to the particular plug from the receiver which goes to the servo that moves. Mark that plug "RUD".

If your receiver doesn't have separate plugs coming from it, but does have places for the servos to plug in, apply a piece of tape nearby that you can mark "R" opposite the appropriate plug-in location.

2. Move the control stick up and down (away from you, and towards you). Mark the appropriate plug or plug -in location "ELEV" or "E".

NOTE: The servo functions are determined by where they are plugged into the receiver. Be sure to assemble them the same way each time so that the servos give you the proper responses.

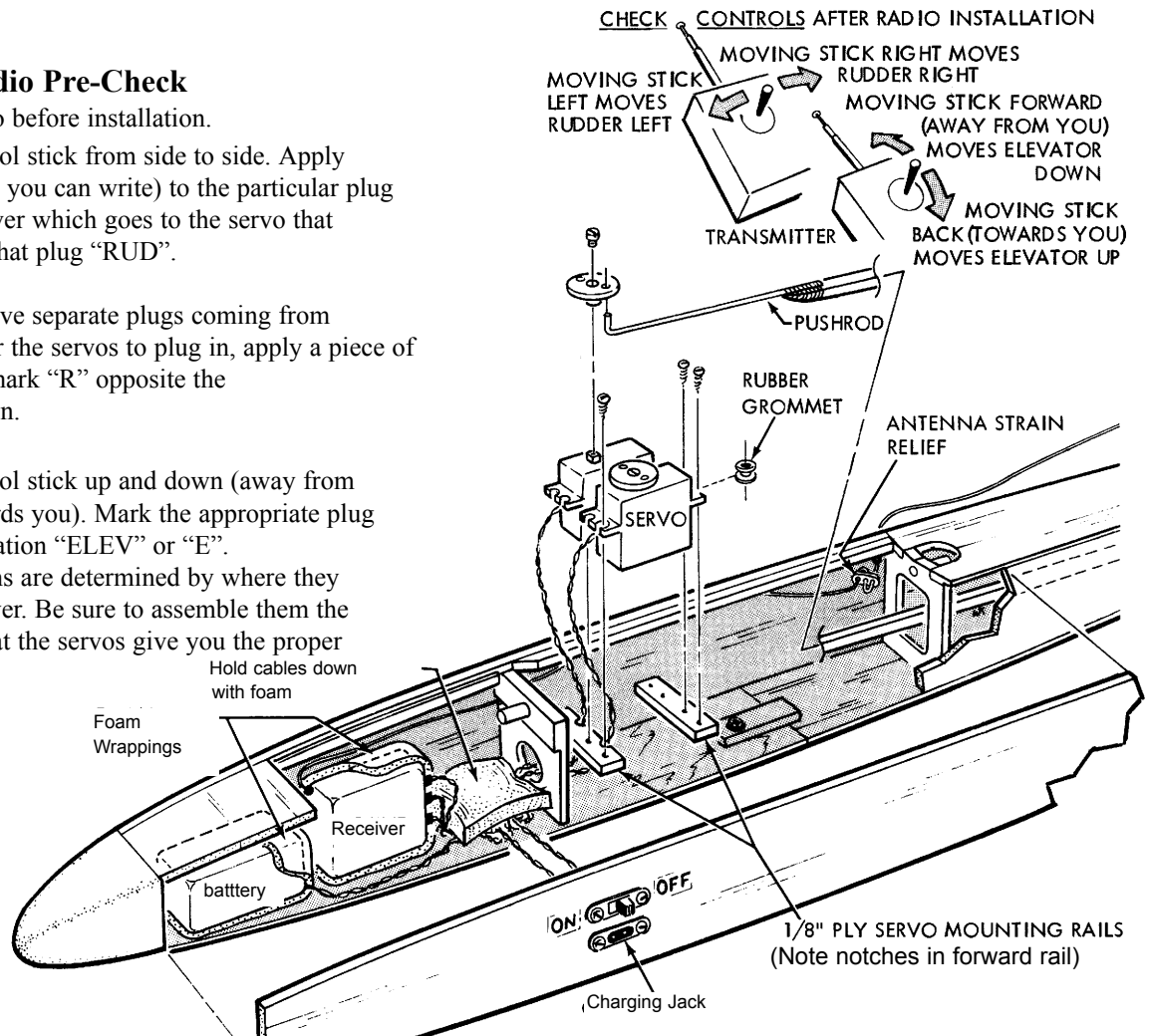

Radio Protection

Locate and protect airborne part of radio. Begin by installing the servo rails.

1. With pushrods installed, tape the front wires up out of the way beneath the 1/8" sq. wing rest strips.
2. Insert the soft rubber grommets into the mounting holes of your servos.
- Measure from the bottom of your servo to the underside of a grommet. Add 3/16" to this measurement. The total is the height of the tip of the servo rail above the fuselage floor.

- Mark the inside of the fuselage for the height of rails.
3. Notch one rail as necessary to clear the cables where they exit from the servo. This will be the forward rail.
- Glue the forward rail in place with CA or epoxy.
4. Place one servo on the rail. Allow 1/16" clearance from the back of the servo.
- Glue the rear rail in place.

5. With both servos in position, and approximately 1/16" between them, mark through the grommets for the location of the servo mounting screws.
 - Remove the servos. With a 1/16" drill bit, drill through the rails for the screws.
6. Determine which is the elevator and which is the rudder servo. Locate the rudder servo on the left, and the elevator servo on the right, as shown in the plans.
 - Fasten gently with #2 x 3/8" sheet metal screws.
 - Untape the pushrod wires from the fuselage sides and hook them up to the servos as shown.

Next, protect the battery pack. Remember, you must have fresh dry cells or fully charged nicads for flying.

1. Wrap your battery pack in polyethylene foam or foam rubber to cushion it against shock. If you are going to use an engine with your model, foam rubber is preferable because it is much better at protecting against vibration. Use scotch or masking tape to hold the ends of the foam in place.
2. Because the battery pack is the heaviest piece, it should be mounted as far forward as possible.

Installing the Receiver

1. Do not cut the antenna wire attached to the receiver.
2. Wrap the receiver carefully in foam, as was done for the battery pack. Then place the receiver just to the rear of the battery pack.
3. Lead the antenna back just under the hatch rest.
 - Drill a small hole in former #2, and lead the antenna further back, just under the 1/8" sq. balsa wing rest rails.

BALANCING

With everything installed, mount the wing and carefully check the Center of Gravity (CG). One way is to perch the model on the thumb and forefinger of your left hand (if you're right handed), while steadying the model with the other. A much better way is to use a balancing set-up, which can be made with a couple of 1/4" dowels with rounded tops, spaced just enough apart to clear the fuse. Mark the desired CG on the underside of the wing, and then set the model on the dowels at that location. Add weight if necessary for balance. The least weight is needed when added as far forward or back as possible.

DO NOT attempt to fly the model with the CG EVEN SLIGHTLY BEHIND the rearmost recommended position.

RADIO CHECK

Before going to the field to fly, with batteries fully charged, turn on receiver and transmitter and actuate all controls many times until you are satisfied with all functions.

Prior to the beginning of each day's flying, make a range check of your equipment in accordance with the manufacturer's instructions in general, with antenna

4. Just ahead of former #3, drill a small hole in the fuselage side for the antenna to exit.
 - Lead the antenna to the top of the fin and scotch tape in place.

Installing the Switch and Charging Jack

1. Mark fuselage side for switch location.
 - Cut hole through fuselage side, and make it long enough for switch button to move to On an Off positions.
2. Determine On and Off positions of switch. Mount switch with On position forward.
 - Install switch screws.
3. On the outside of fuselage, identify On and Off positions with decals provided.
4. Mount the charging jack for the battery in the fuselage side by the same method.

Cable Storage

1. Gather all excess cables together behind receiver, and hold down with foam.

Set Control Surfaces

1. With elevator trim tab on transmitter set in the center position, adjust elevator mini-snap until top of elevator is flat with top of stab.
2. With rudder trim tab on transmitter set in center position, adjust rudder mini-snap until rudder points dead straight ahead.

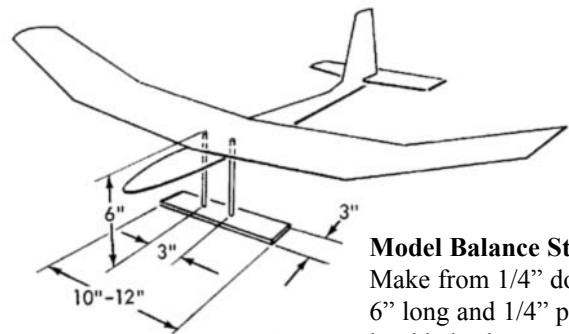

Model Balance Stand
Make from 1/4" dowels 6" long and 1/4" ply or hard balsa base

collapsed, you should have at least 100 feet range on the ground. To check this, set the model facing away from you, turn on both the transmitter and receiver switches, and walk away while transmitting signals. Watch to see that no signals are missed until you are at least 100 feet away. Do not attempt any flights unless the equipment works perfectly. **Be careful not to use your transmitter when someone else on the field is flying or testing on the same frequency.**

FLYING YOUR GENTLE LADY

IMPORTANT: Always check to be sure no one else is using the same frequency as you, before operating your radio. Make hand launched test flights before first high-start or powered flight.

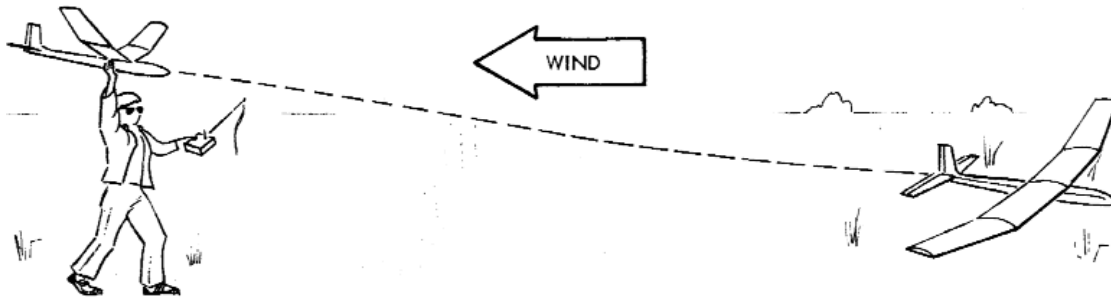

With transmitter and receiver switched on, hand launch the model directly into the wind. Gently correct the flight path as necessary. Make any adjustments indicated in the rudder or elevator by means of the clevises.

In flight control, most of the beginner's trouble comes from overcontrolling or holding a signal too long. It is better to operate your transmitter slowly and smoothly.

A troublesome tendency is letting the model get downwind. New flyers should try to keep the model upwind at all times prior to the landing approach. It is more difficult to fly a model when it is downwind, and if a mistake is made, the model will end up farther downwind, making it impossible to fly it back to the field.

If you are a novice, seek the help of an experienced flyer. If nothing else, ask one of the better flyers at the field for help. Usually, they are glad to spend a little time to get somebody started right, and they very likely were helped in the same manner themselves.

Here are some additional tips from Dave Brown, a multiple R/C Pattern National Champion, which have helped many fliers get started. They are reprinted by permission of **R/C Modeler Magazine** and are excerpted from Dave's article, "Learning How to Fly", which appeared in the **RCM** October 1979 issue.

from "Learning How To Fly"
by Dave Brown

Although Dave strongly recommends learning to fly with the help of an instructor, he feels that if you must teach yourself, a powered glider is the best type of plane to learn on

Set the airplane up with a very minimal amount of control surface throw, particularly on elevator. Now, before you fly it, spend a considerable amount of time "hanger flying" it simply by pointing it at many different angles (including coming straight at you) and working the controls, imagining that it is flying and you are trying to steer it around the sky. If possible, it's better if you can mount the airplane up on a camera tripod while doing this to get the perspective of the airplane being above you as well as it climbing, diving, or banking. I realize you may feel ridiculous while doing this and it

probably should be done out of sight of other sane people to retain your stature in the community, but believe me, it is important and it works. I still use this system when trying to straighten out a particular problem or maneuver.

Now...you must get the airplane trimmed out by test gliding it over some tall grass. Only when you can consistently throw the airplane at the right speed to make it glide smoothly to the landing without dropping like a brick or stalling and dropping in, are you ready to continue. During all these test glides it is best to have the radio turned on, but leave the transmitter on the ground, using it only in emergency to get the model out of a thermal! Don't laugh, I've seen this happen. After you can consistently throw in this manner, try it holding the transmitter in the other hand and try steering it just a little. Don't make any sharp turns, but rather try to make it do very shallow S-turns, never exceeding about 10 to 15 degrees from that straight line. Don't touch the elevator control yet and don't move the rudder stick any more than about half its travel.

Reprints of Dave's complete article may be obtained by calling Carl Goldberg Products. Dave closes with his "ten commandments" for the self-taught R/C pilot. We think most of them make sense and should be heeded everyone!

- 1) Thou shalt get help if at all possible.
- 2) Thou shalt fly only a trainer type airplane, preferable a motorglider
- 3) Thou shalt fly only when it is calm.
- 4) Thou shalt fly only in a very large open area with its owner's permission.
- 5) Thou shalt not fly to impress friends.
- 6) Thou shalt proceed slowly and with caution.
- 7) Thou shalt not panic; let the airplane fly itself out of trouble.
- 8) Thou shalt steer the model carefully and delicately, using only rudder at first.
- 9) Thou shalt check thy equipment frequently and change batteries faithfully.
- 10) Thou shalt be patient, lest thee bust thy toy!

REMEMBER.....

FLY ONLY IN AREAS SUITABLE AND/OR SANCTIONED FOR R/C AND KNOWN TO BE FREE OF RADIO INTERFERENCE. Great help can be found in all phases of building and flying by reading **R/C Modeler Magazine's** "Flight Training Course, Vol. 1." There also are a number of videos ("Old Buzzard Goes Flying!") deals specifically with sailplanes) and flight simulation programs available to help you. Happy Flying!