

## Chapter 5

### Insulation Materials and Techniques

The key to an effective insulation system is proper installation of quality insulation products. A house should have a continuous layer of insulation around the entire building envelope. Studies show that improper installation can cut performance of the insulation by 30% or more.

**Figure 5-1**  
**Insulating the Building Envelope**  
**Recommended Insulation Values**

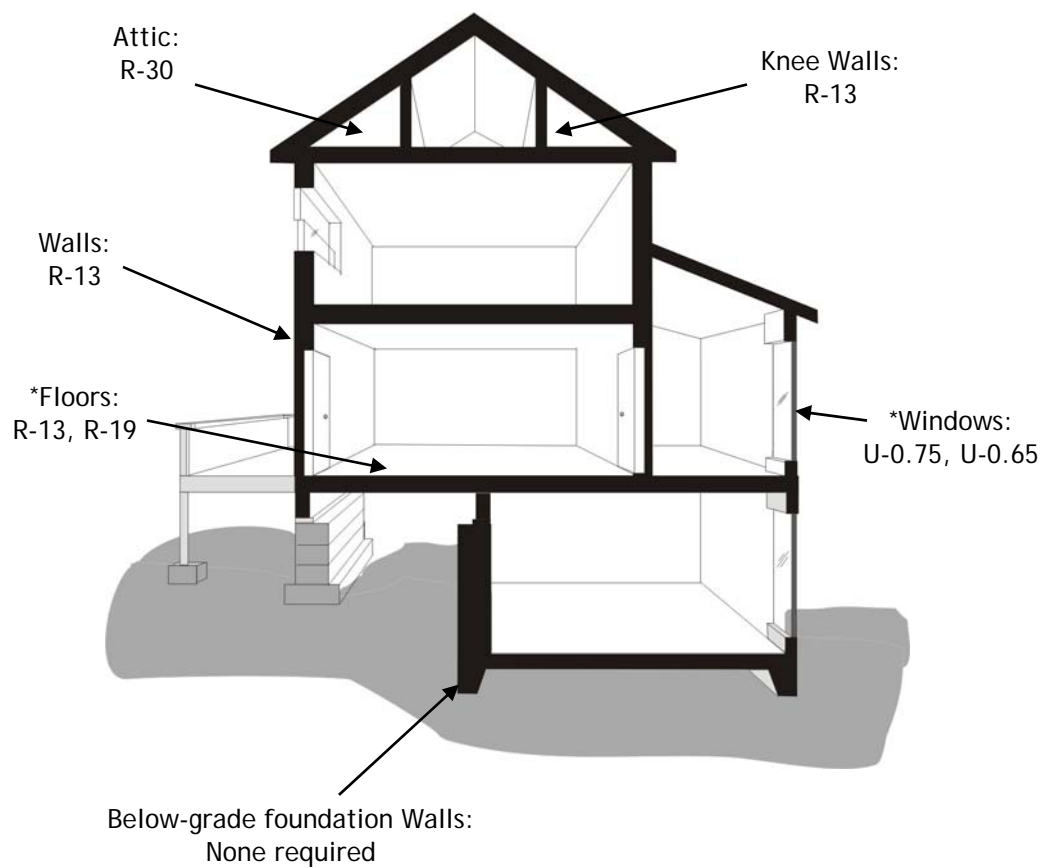

*\*Where two numbers are listed, first number is for climate zone 2 and the second number is for climate zone 3.*

### **Insulation Materials**

The wide variety of insulation materials makes it difficult to determine which products and techniques are the most cost effective.

Fiberglass insulation products come in batt, roll, and loose-fill form, as well as a high-density board material. Many manufacturers use recycled glass in the production process. Fiberglass is used for insulating virtually every building component – from foundation walls to attics to ductwork.

**Table 5-1  
Fiberglass Batt Insulation Characteristics**

Thickness (inches)	R-value	Cost (\$/sq ft)
3 1/2	11	0.28 - 0.35
3 1/2	13	0.34 - 0.37
3 1/2	15	0.64 - 0.67
6 to 6 1/4	19	0.43 - 0.55
8	30	0.64 - 0.91
9 1/2 to 9 3/4	30	0.61 - 0.81
12	38	0.78 - 0.83

This chart is for comparison only. Determine actual thickness, R-value, and cost from manufacturer or local building supply.

- *Cellulose insulation*, made from recycled newsprint, comes primarily in loose-fill form. Cellulose batt insulation has also been introduced in the marketplace. Loose-fill cellulose is used for insulating attics and can be used for walls and floors when installed with a binder, netting, or covering.
- *Rock wool insulation* is mainly available as a loose-fill product and can be installed in attics or blown using damp spray methods into walls. It is fireproof and manufacturers use recycled materials in the production process.
- *Molded-expanded polystyrene*, often known as beadboard, is a foam product made from molded beads of plastic. While it has the lowest R-value per inch of the foam products, it is also the lowest in price. It is used in several alternative building products discussed in this chapter, including insulated concrete forms and structural insulated panels. It performs well in below-grade applications.
- *Extruded polystyrene*, also a foam product, is a homogenous polystyrene product made primarily by three manufacturers with characteristic colors of blue, pink, and green. It is an excellent product for below-grade applications or exterior sheathing.
- *Polyisocyanurate and closed-cell polyurethane* are insulating foams with some of the highest available R-values per inch. Another benefit of these foams is that they provide structural support to the bracing members and sheathing.
- *Open-cell polyurethane* is used primarily to seal air leaks and provide an insulating layer. Polyurethane is one of the only spray foams which can be used in existing buildings, as it will not expand and damage the interior finish.
- *Isocyanate foam*, used primarily to seal air leaks and provide an insulating layer, is foamed with carbon dioxide.
- *Aerated Concrete*, including lightweight, autoclaved (processed at high temperature) concrete can provide a combination of moderate R-values and thermal mass for floors, walls, and ceilings.

Use extra care with all insulation – see the manufacturer’s label for specific product handling information.

**Table 5-2  
Comparison of Envelope Insulation Materials  
(Environmental Characteristics and Health Impacts)**

Type of Insulation	Installation Method(s)	R-Value per Inch	Raw Materials	Pollution from Production	Indoor Air Quality Impacts	Comments
<b>Fibrous Insulation</b>						
Cellulose	loose fill, wet spray, dense pack, stabilized	3.0 - 3.7	newspaper, borates, ammonium sulfate	Negligible	Fibers and chemicals can be irritants, should be isolated from interior space	High recycled content, very low embodied energy
Fiberglass	batts, loose fill, stabilized, rigid board	3.0 - 4.3	silica, sand, limestone, boron, resin, cullet, some types contain trace amounts of phenol formaldehyde in the binder	Air pollution from energy use	Fibers and chemicals can be irritants, should be isolated from interior space	some loose-fill products have no binder.
Mineral Wool	loose fill (no binder), batts, wet spray	2.3 - 4.0	steel slag or rock, phenol formaldehyde,	Air pollution from energy use	Fibers and chemicals can be irritants, should be isolated from interior space	Sound deadening capacity
Perlite	loose fill	2.5 - 3.3	volcanic rock	Negligible	Some nuisance dust	
<b>Rigid Insulation and Sheathing</b>						
Expanded Polystyrene	rigid boards	3.85 - 5.0	fossil fuels, pentane	Pentane emissions contribute to smog	Concern only for those with chemical sensitivities	Primary non-HCFC foam board
Extruded Polystyrene	rigid boards	3.1 - 5.0	fossil fuels, HCFC-142b	Ozone depletion	Concern only for those with chemical sensitivities	At one time, a recycled product was available
Polyisocyanurate	foil-faced rigid boards	3.6 - 5.6	fossil fuels, HCFC-141b	Ozone depletion	Concern only for those with chemical sensitivities	One non-HCFC-based product is available
Closed-cell Polyurethane	sprayed-in	3.4 - 6.2	fossil fuels, HCFC-141b	Ozone depletion	Concern only for those with chemical sensitivities	
Open-cell Polyurethane	sprayed-in	3.5	fossil fuels, soy oil	Negligible	Unknown, appears to be very safe	Doesn't harden; good air sealing
Fiberboard Sheathing	rigid boards	2.6	sawmill waste, organic by-products, asphalt, wax	Dryer emissions	n/a	

## Insulation Strategies

As shown in Table 5-3, fiberglass, rock wool, and cellulose products are the most economical and should serve as bulk insulation in attics, walls, and floors. In attics, loose-fill products are usually less expensive than batts or blankets. Blown cellulose and rock wool are denser than fiberglass, helping reduce air leakage.

### *Foam Insulation Strategies*

Foam products are primarily economical when they can be applied as part of a structural system or to help seal air leaks. Examples include:

- Exterior sheathing over wall framing
- Insulated concrete forms
- As part of a structural insulated panel for walls and roofs
- Spray-applied foam insulation
- Foundation wall or slab insulation – not recommended in Louisiana.

### *Critical Guidelines*

When installing any insulating material, the following guidelines are critical for optimum performance:

- Seal all air leaks between conditioned and unconditioned areas
- Obtain complete, uniform coverage of the insulation
- Minimize air leakage through the material
- Avoid compressing insulation
- Avoid lofting (installing with too much air) in loose-fill products.

**Table 5-3**  
**Cost Comparison of Insulating Materials**  
**(Does not including installation)**

	Typical R-Value (per inch)*	Typical Cost (\$/sq ft per R-value)*
Batts, blankets and loose-fill insulation		
Mineral wool, fiberglass, rock wool		
Batts or blankets	2.9 - 3.8	.020 - .032
Loose-fill	2.2 - 2.9	.015 - .020
Cellulose (loose-fill)	3.1 - 3.7	.009 - .036
Cotton Insulation	3.0 - 3.7	.048 - .055
Foam insulation and sheathing		
Polyisocyanurate and polyurethane	5.0 - 7.0	.172
Extruded polystyrene	5.0	.075 - .091
Expanded polystyrene	4.0	.063 - .084
Fiberboard sheathing (blackboard)	2.6	.082 - .136
Isocyanate Foam	3.6 - 4.3	n/a
*Determine actual R-values and costs from manufacturers or local suppliers.		

## Foundation Insulation

### Slab-on-Grade Insulation

Many of Louisiana's homes have slab-on-grade floors for the first story of conditioned space. Slab insulation is not recommended anywhere in the state by the IRC due to problems with termites, which can tunnel undetected through the foam to gain access to the wood framing in the walls. Because of the severity of the problem, this publication does not recommend foam slab insulation in Louisiana.

### Foundation Wall Insulation

Foundation walls and other masonry walls are usually built of concrete blocks or poured concrete.

#### *Insulating concrete block cores*

Builders can insulate the interior cores of concrete block walls with insulation such as:

- Vermiculite – R-2.1 per inch (see <http://www.epa.gov/asbestos/pubs/verm.html> for more information on vermiculite)
- Polystyrene inserts or beads – R-4.0 to 5.0 per inch
- Polyurethane foam – R-5.8 to 6.8 per inch

Unfortunately, the substantial thermal bridging in the concrete connections between the cores depreciates the overall R-value. Thus, this approach is only a partial solution to providing a quality, well-insulated wall.

**Figure 5-2**  
**Insulating Concrete Block Cores**  
**(R-4 to R-6 overall)**

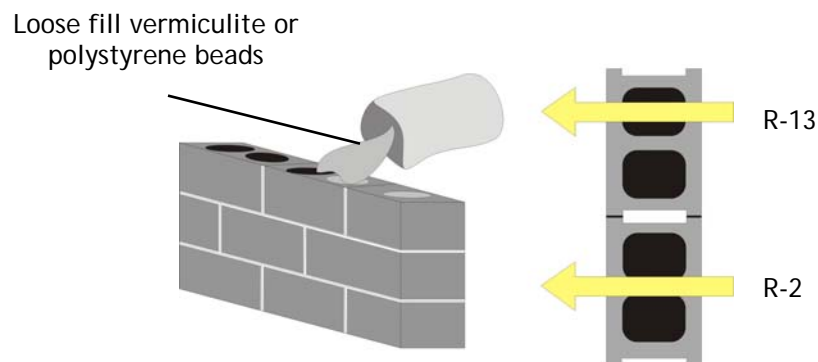

### Foundation Vents

The purpose of crawl space vents is to dry out the air under the house. The major source of moisture is the earth floor of the crawl space in most homes. Covering the earth with a layer of polyethylene will eliminate most of the moisture from this source.

In Louisiana, the second greatest source of moisture is air coming in through the vents. Venting crawl spaces which have air conditioning ducts can be of particular concern. Often the ductwork is leaky and poorly insulated, which creates a cold surface that causes water vapor in the air to condense. Air conditioning often cools the floor framing and crawl spaces below the dew point temperature of the outside air. Warm, moist outside air coming through the vents can then condense inside the crawl space as shown in Figure 5-6. In some cases, water accumulating in duct insulation has become heavy enough to pull the entire duct loose.

Because of the poor ability of outdoor air to aid in dehumidifying crawl spaces in summer and a desire to avoid ventilation in winter in order to keep crawl spaces warmer, many building professionals feel that an unvented crawl space is the best option in homes with good exterior drainage systems and no natural gas piping. However, get approval from local code officials before omitting vents.

**Figure 5-3**  
**Relative Humidity (RH) and**  
**Foundation Vents**

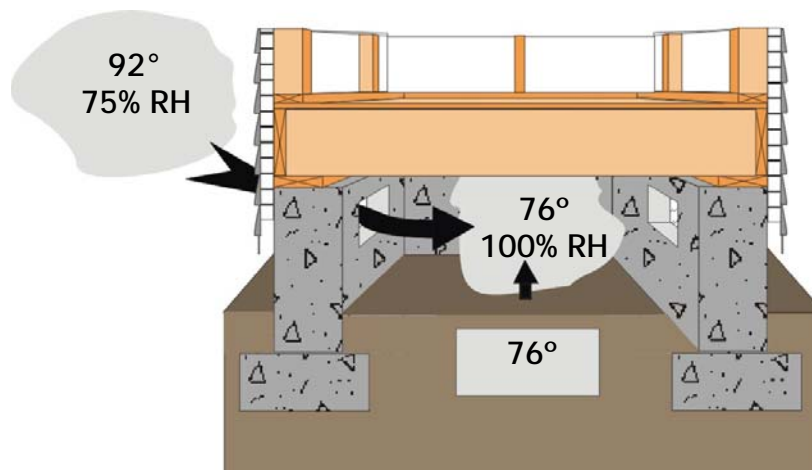

## ***Basement Wall Insulation***

### ***Interior Foam Wall Insulation***

Foam insulation can be installed on the interior of basement walls; however, it must be covered with a material that resists damage and meets local fire code requirements. Half-inch drywall will typically comply. Furring strips will need to be installed as nailing surfaces. Furring strips are usually installed between sheets of foam insulation. To avoid the direct, uninsulated thermal bridge between the concrete wall and the furring strips, a continuous layer of foam may be installed underneath the nailing strips.

**Figure 5-4**  
**Interior Foam Wall Insulation**  
**(R-10 to R-14 overall)**

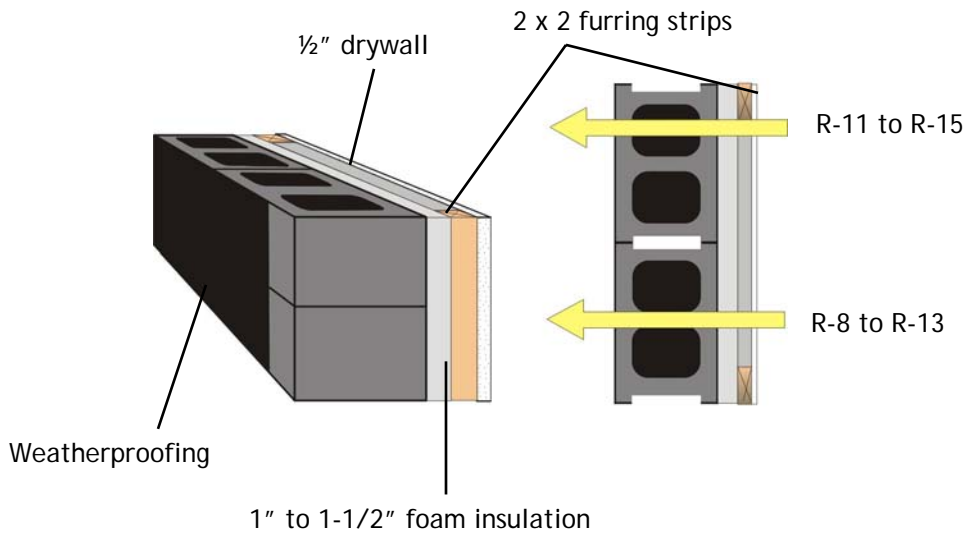

***Interior Framed Wall***

In some cases, designers will specify a framed wall on the interior of a masonry wall. Standard framed wall insulation and air sealing practice can then be applied.

**Figure 5-5**  
**Interior Framed Wall**  
**(R-11 to R-13 overall)**

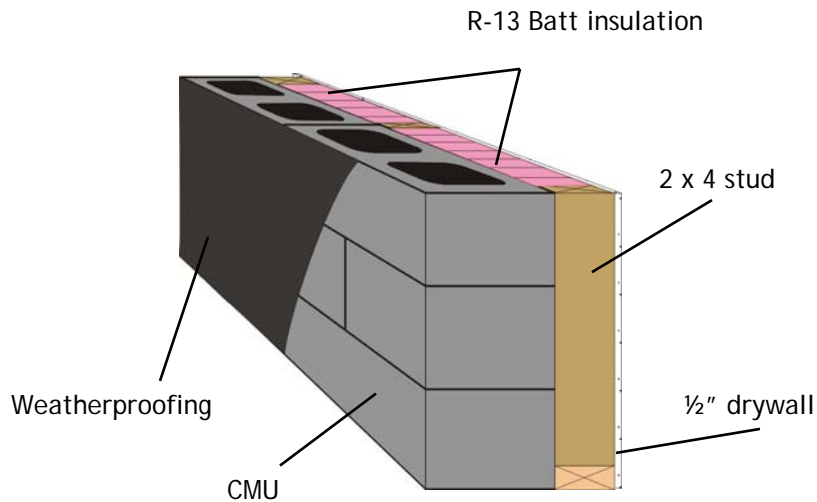

***Lightweight Concrete Products***

Lightweight, air entrained concrete is an alternative wall system. The aerated concrete, which can be shipped as either blocks or panels, combines elevated R-values (compared to standard concrete) with thermal mass.

## ***Integrated Foam and Concrete Wall Systems***

Polystyrene or polyurethane foam can be used as formwork for poured or spray-on structural concrete. Only products containing termiticides should be in direct contact with the ground.

*Insulated Concrete Form (ICF)* – Several companies manufacture foam blocks that can be installed quickly on the footings of a building. Once stacked, reinforced with rebar, and braced, they can be filled with concrete. ICFs that serve as formwork for concrete basement walls or the entire exterior wall system of the home can save on the cost of materials and reduce heat flow. Advantages include improved termite control due to lack of wood in the exterior structure, durability, hurricane resistance, continuous insulation, and noise control.

**Figure 5-6**  
**Insulated Concrete Form Wall Systems**  
**(R-17 to R-24 overall)**

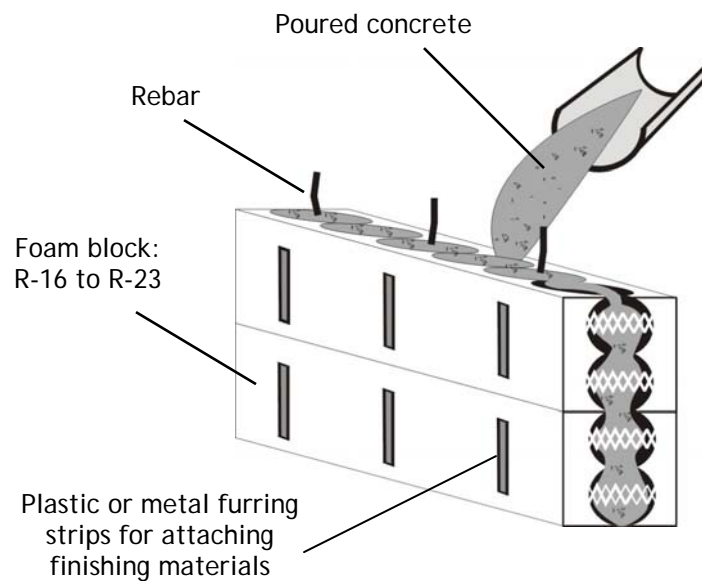

*Foam Panel or Snap Tie Systems* – Some companies produce systems in which insulation panels are locked together with plastic snap ties. A space, typically eight inches, is created between the foam panels. This space is then filled with concrete. As with foam block systems, installers must follow the manufacturer's recommendations carefully for a successful system. Key considerations are:

- Bracing requirements – the cost of bracing the foam blocks before construction may outweigh any labor savings from the system. Some products require little bracing while others need substantially more.
- Stepped foundations – make sure of the recommendations for stepping foundations – some systems have 12" high blocks or foam sections, while others are 16" high.
- Reinforcing – follow the manufacturer's recommendations for placement of rebar and other reinforcing materials.
- Concrete fill – make sure that the concrete ordered to fill the foam foundation system has the correct slump to meet the manufacturer's requirements. These systems have been subject to blowouts when the installer did not fully comply with the manufacturer's specifications. A blowout is when the foam or its support structure breaks and concrete pours out of the form.



- Termites – follow the guidelines in this chapter concerning termite prevention strategies with any foam product. Homes built completely with ICFs will reduce termite risks because they eliminate framing lumber.

*Spray-on Systems* – Concrete can be sprayed onto foam panels which are covered by a metal reinforcing grid, part of which is exposed. A structural concrete mixture is sprayed onto the exposed reinforcing metal. As with foam block systems, installers must follow the manufacturer’s recommendations carefully for a successful system.

Note: These systems should not be used below grade to reduce potential for termite infestation.

## ***Framed Floor Insulation***

### **Insulating Under Floors**

Many Louisiana homes have floor structures consisting of 2x10 or 2x12 wood joists, wood I-beams, or trusses over unconditioned crawl spaces or basements. Insulation should be installed underneath the subfloor between the framing members. To meet the International Residential Code for floor insulation, R-13 is required in Zone 2 and R-19 in Zone 3.

Most builders use insulation batts with an attached vapor barrier for insulating framed floors. The batts should be installed flush against the subfloor without any gaps, which may serve as a passageway for cold air between the insulation and floor. Special rigid wire supports called “tiger teeth” hold the insulation in place.

**Figure 5-7  
Insulated Wood Framed Floors**

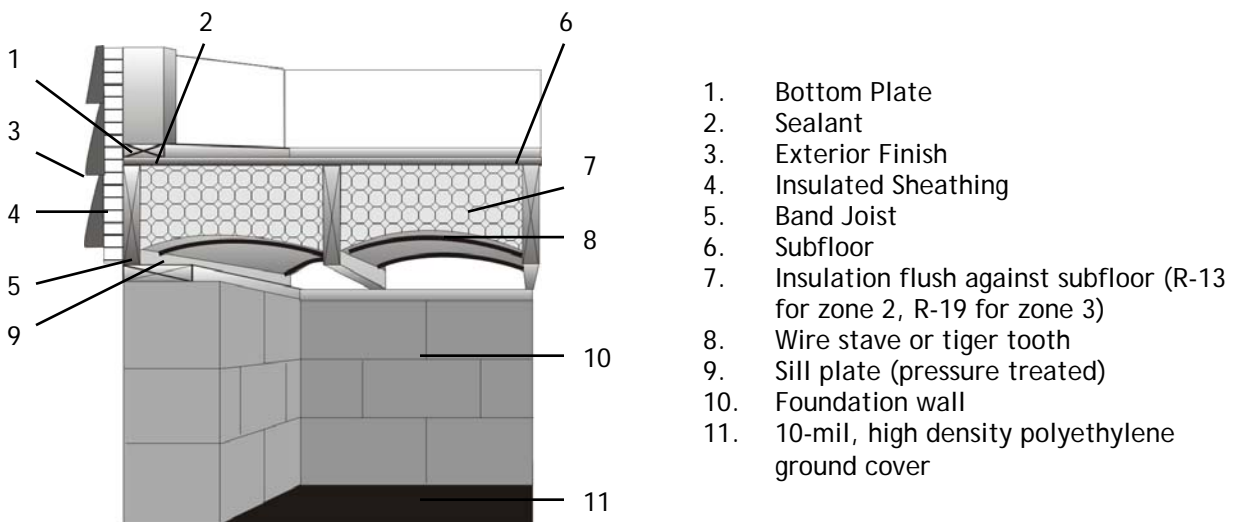

Run wiring, plumbing, and ductwork below the bottom of the insulation so that the continuous layer can be installed. Be certain to insulate all plumbing and ductwork in the unconditioned spaces such as crawl spaces, basements, and attics.

**Figure 5-8  
Insulated Floor over Pier Foundation**

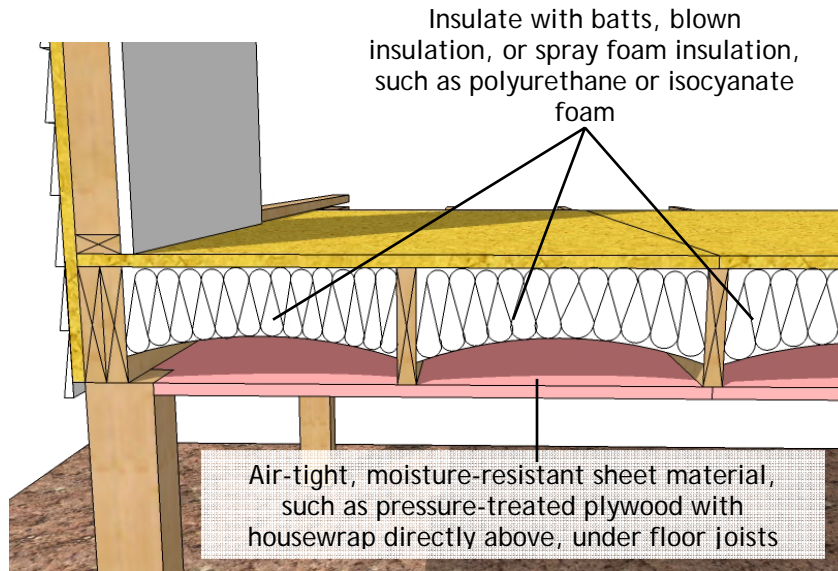

**Table 5-4  
Economics of Framed Floor Insulation  
Compared to an Uninsulated Floor**

	Energy Savings (\$/yr)	Extra Installed Costs (\$)	Annual Rate of Return	Extra Mortgage Costs (\$/yr)
1. R-11 Batt	363	1030	37.2	83
2. R-13 Batts	380	1110	36.2	89
3. R-19 Batts	431	1380	33.2	111
4. R-30 Batts	474	1820	28.0	147

\*For a home with a 2,000 square-foot floor located in Baton Rouge. Analysis assumes 2% annual fuel price escalation; mortgage is 30 year, 7% loan; the energy savings were estimated using REMRate v 12.0 software.

### Insulating Crawl Space Walls Rather Than Floors

For years, building professionals have assumed the optimal practice for insulating floors over unheated areas was to insulate underneath the floor. However, studies performed in Tennessee several years ago found that insulating the walls in well-sealed crawl spaces and unconditioned basements can be an effective alternative to under-floor insulation. While the annual heating bills in the homes tested were one to three percent higher than those with under-floor insulation, the cooling bills dropped by approximately the same amount. Because the crawl space remains cool in summer, the home can conduct heat to the crawl space if there is no insulation under the floor.

**Figure 5-9**  
**Insulated, Sealed Crawl Space Walls**

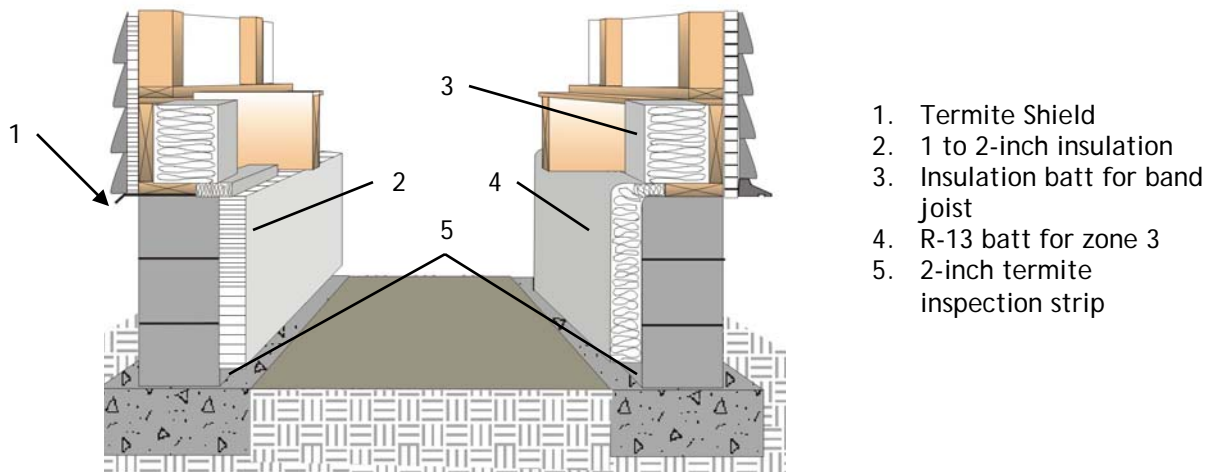

***Crawl Space Wall Insulation Requirements:***

- Cover the entire earth floor with 6- to 10-mil polyethylene (recommended in all homes)
- A one- or two-inch gap should be left at the bottom of the insulation to serve as a termite inspection strip.
- Insulate the band joist area in addition to the foundation wall.
- The crawl space or basement must have an airtight barrier to the house.
- Review plans for the insulation with local building officials to ensure code compliance

***Advantages of Crawl Space Wall Insulation***

- Less insulation required (about 800 square feet for a 2000 square-foot crawl space with 4-foot walls).
- Pipe insulation is not required (spaces should stay warmer in winter).

***Disadvantages of Crawl Space Wall Insulation***

- The insulation may be damaged by rodents and other pests.
- If the crawl space leaks air to the outside, the home will lose considerably more heat than standard homes with under-floor insulation.
- Proper site drainage and a continuous ground cover are essential to keep the crawl space and insulation dry.

**Figure 5-10**  
**Floor Insulation Details**

• Dots represent critical air sealing locations

Truss - Band Joist Between Floors

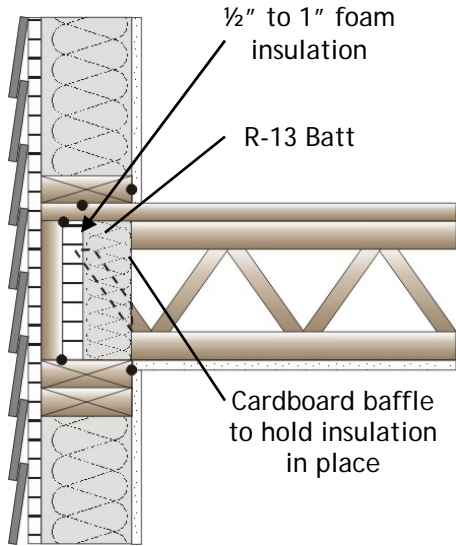

Cantilevered Floor

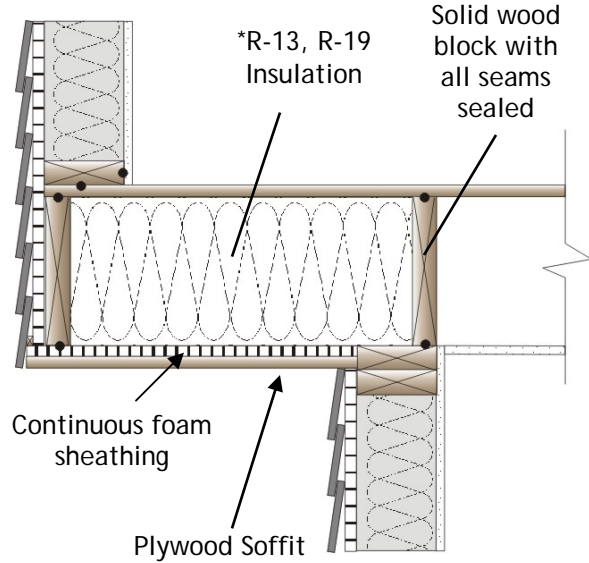

*Note: Floor trusses will measure 1" to 3" shorter than total width of exterior wall framing, depending on the exact treatment.*

Garage Ceiling Under Bonus Room

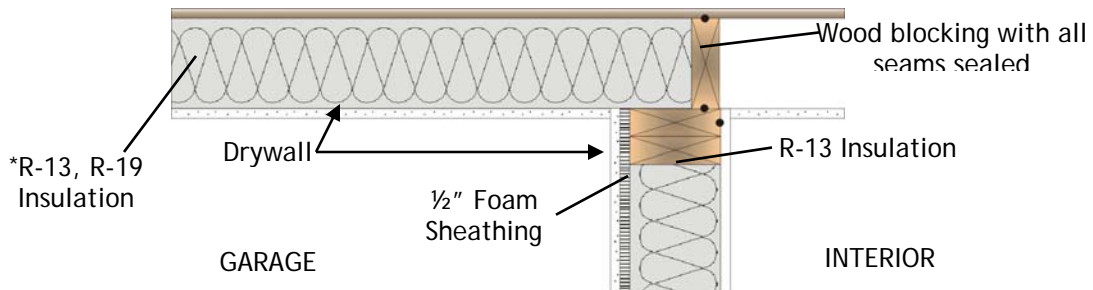

*\*Where two numbers are listed, first number is for climate zone 2 and the second number is for climate zone 3.*

## *Wall Construction*

Walls are the most complex component of the building envelope to insulate, air seal, and moisture-proof. Throughout the United States, debates continue on optimal wall construction. Issues include:

- Vapor barrier and air sealing systems
- 2 x 4 versus 2 x 6 framing; energy efficient framing
- Which types of wall insulation are best

### Wall Framing with Advanced Framing (See Chapter 2)

Advanced framing increases energy efficiency and reduces annual energy costs because of more effective insulation. Several approaches used in advanced framing are shown in Figure 5-12, including:

- Less framing in corners and partition wall intersections
- More efficient headers
- Eliminating curtailed studs (cripples)
- Using single top plates via point loading

### 2 x 4 Wall Insulation

Table 5-5 summarizes typical problems and solutions in walls framed with 2x4 studs. Solving wall construction problems requires preplanning. In addition to standard framing lumber and fasteners, the following materials will also be required during construction:

- Foam sheathing for insulating headers
- 1x4 let-in bracing or metal T-bracing with 1/2" drywall or other interior for corner bracing
- R-13 or R-19 batts for insulating areas during framing behind shower/tub enclosures or other hidden areas
- 1/2" drywall or other sheet material where needed for air sealing behind enclosures for showers and tubs and other areas that cannot be reached after construction
- Caulking or foam sealant for sealing areas that may be more difficult to seal later

**Figure 5-11  
Let-in Bracing**

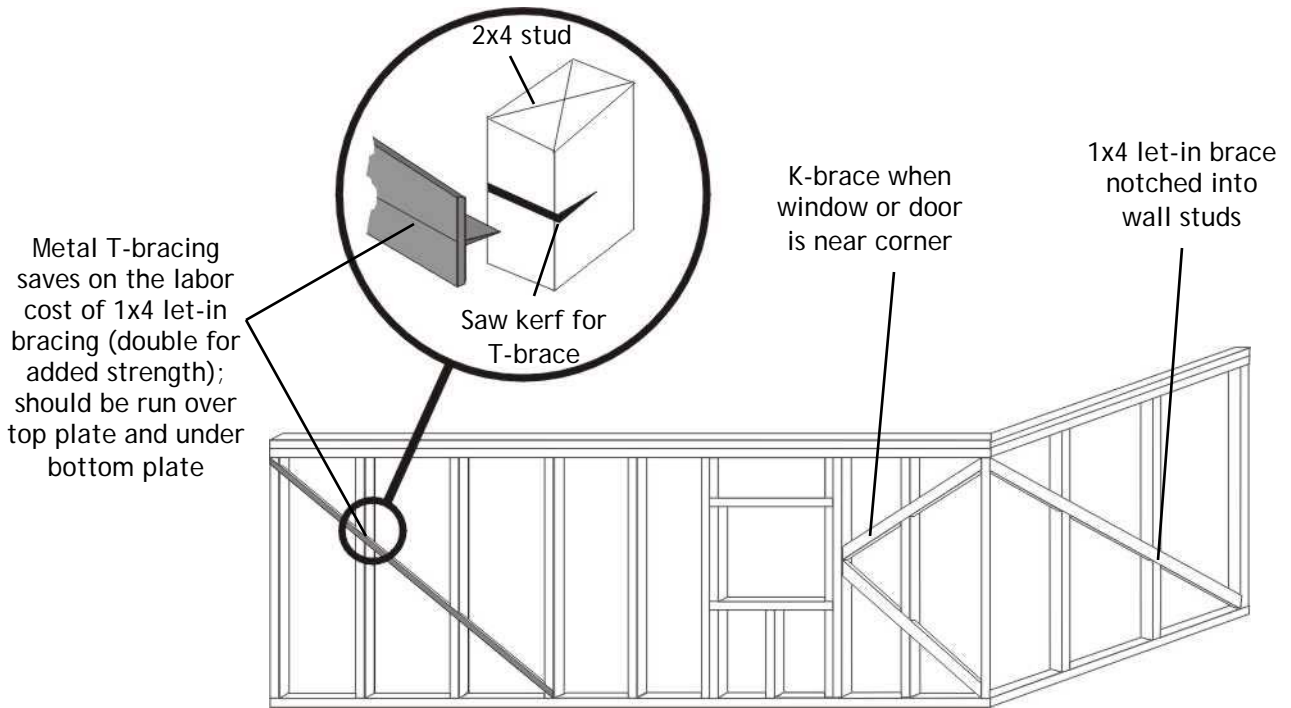
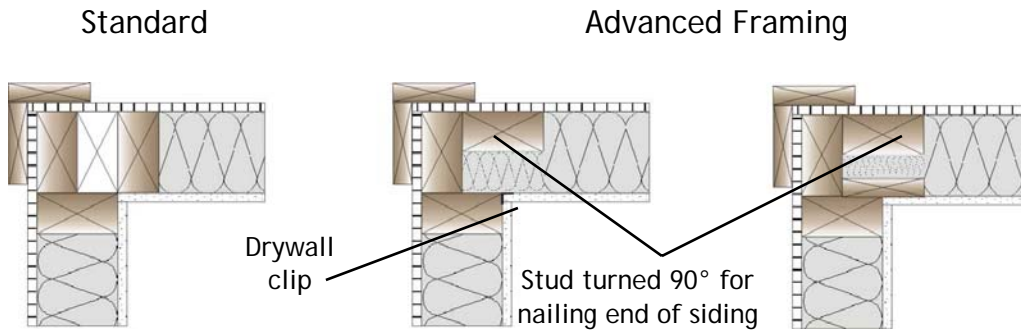

**Table 5-5  
2x4 Framed Wall Problems and Solutions**

Problem	Solution
Sometimes there is only a small space available for installation of insulation.	Install continuous exterior foam sheathing and medium (R-13) to high (R-15) density cavity insulation
Enclosed cavities are more prone to cause condensation when sheathing materials with low R-values are used	Install a continuous air barrier system and allow drying to the inside (no interior vapor barrier). Use continuous foam sheathing on the exterior.
Presence of wiring, plumbing, ductwork, and framing members lessens potential R-value and provides pathways for air leakage	Locate piping and ductwork in interior walls; avoid horizontal wiring runs through exterior walls; use air sealing insulation system.

**Figure 5-12**  
**Advanced Framing Insulation Details**

*Corner Framing*



*Partition Wall Framing*

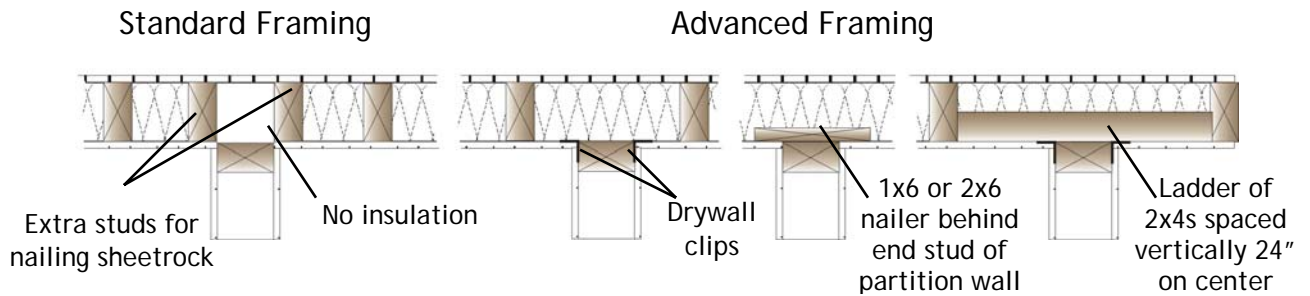

*Partition Wall Framing*

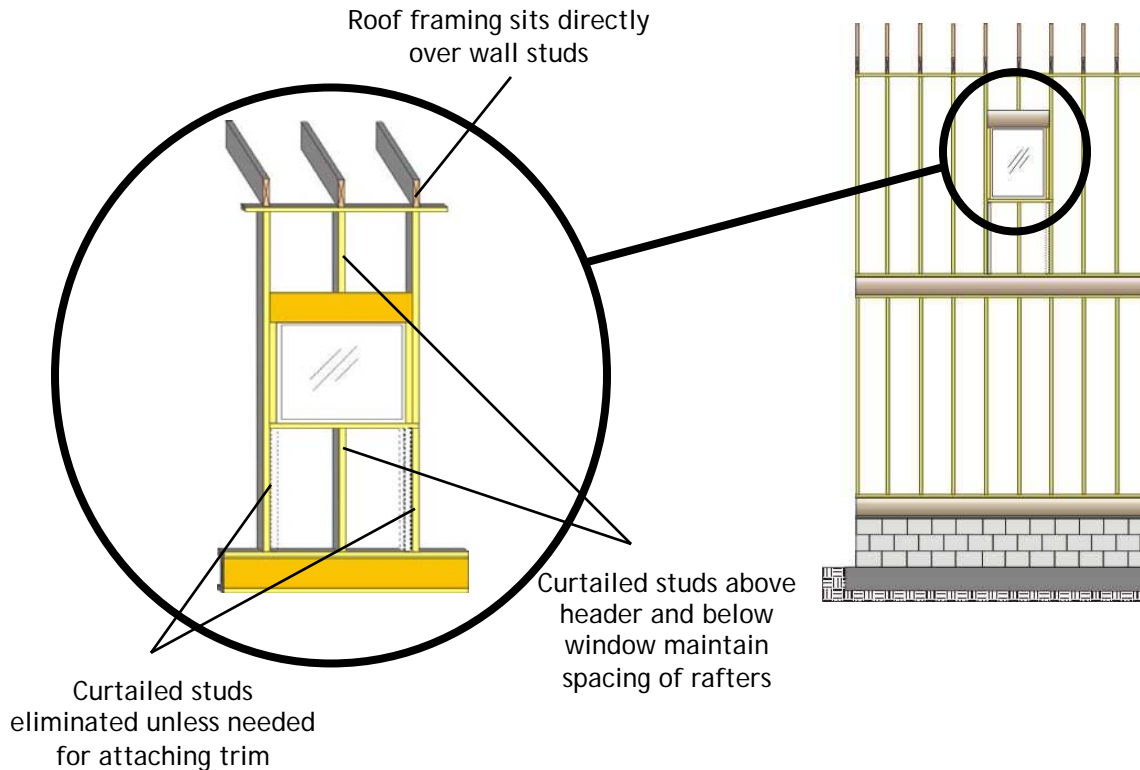

**Figure 5-13**  
**Standard Framing versus Advanced Framing**  
**Standard Framing (16" on center)--10 foot wall**

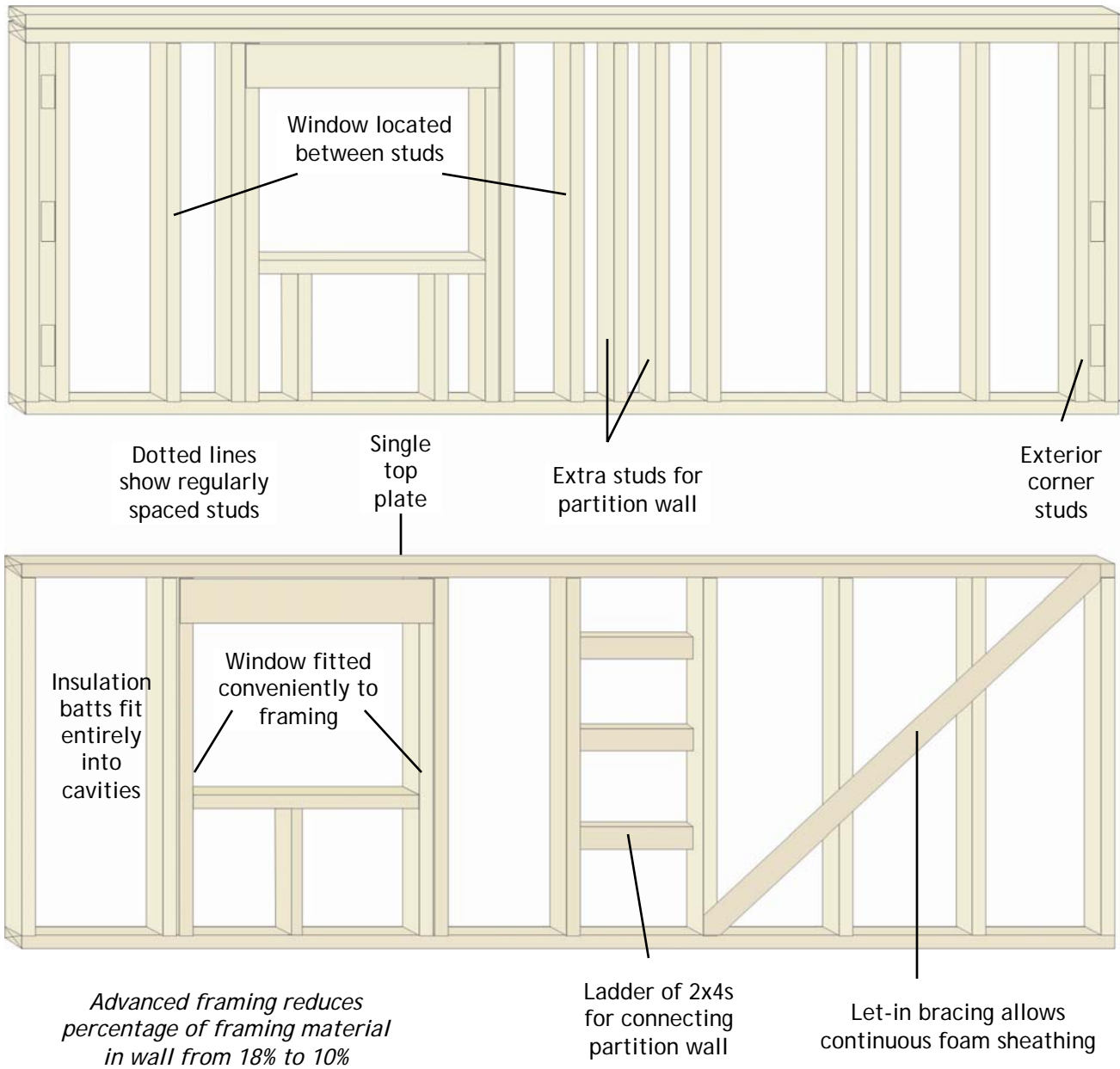

Comparison	Standard Framing	Advanced Framing
Insulation Voids	3%	0%
Framing Factor	15 to 25%	10 to 15%
Cavity R-value	R-13	R-13
Sheathing R-value	R-0.5	R-2.5
Average R-value	R-11.1	R-14.6 (30% better)



### ***Batt Insulation - Use Tight-Fitting, Unfaced Batts***

Vapor retarder-faced batts were previously considered the standard in Louisiana. However, this prevented wall cavities from being dried by the air conditioning inside the house. In Louisiana's climate, houses need to dry to the inside because the outdoor air is humid much of the time.

Completely fill wall cavities with insulation. Unfaced batts are slightly larger than the standard 16- or 24-inch stud spacing and rely on a friction-fit for support. Since unfaced batts are not stapled, they can often be installed in less time. In addition, it is easier to cut unfaced batts to fit around wiring, plumbing, and other obstructions in the walls.

**Figure 5-14**  
**Insulating Walls with Batts**

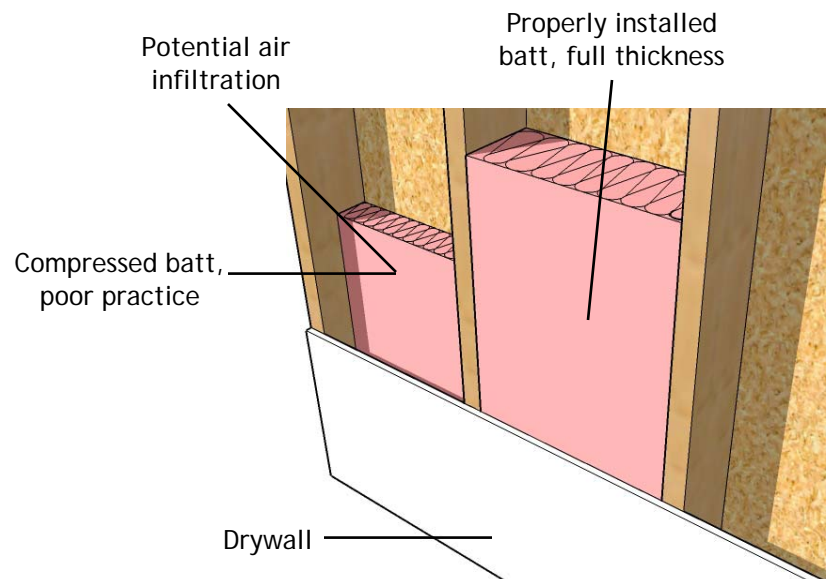

### ***Blown Loose-Fill Insulation***

Many contractors select loose-fill cellulose, fiberglass, and rock wool to insulate walls. The insulation is often installed with a blowing machine and held in place with a glue binder or netting. This blown insulation can provide good insulation coverage in the stud cavities; however, you must allow the binder to dry before the wall cavities are enclosed by the interior finish.

Loose-fill materials with high densities, such as cellulose installed at a density of three to four pounds per cubic foot, not only provide good insulation, but also retard air leaks. Fiberglass is less dense than cellulose and does not provide as much resistance to air circulation. Slag or rock wool insulation is denser than either which sound proofs better. All three are similarly priced and provide about the same insulating capability. The additional benefits of air sealing should be considered when evaluating the economics of cellulose or rock wool when installed in a dense-pack fashion.

**Figure 5-15**  
**Blown Sidewall Insulation Options**

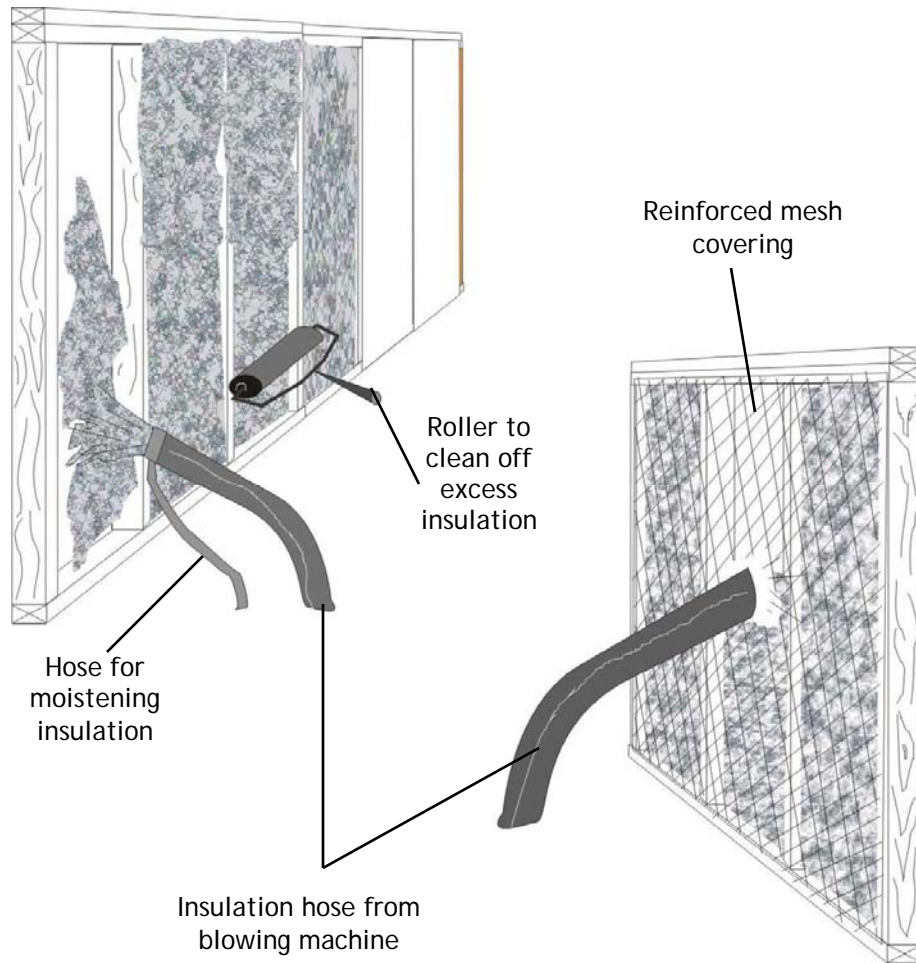

### *Spray Foam Insulation*

Insulation contractors now spray polyurethane or isocyanate foam insulation into walls of new homes. This technique provides high R-values in relatively thin space and seals air leaks effectively. The economics of foam insulation should be examined carefully before deciding on its use.

**Figure 5-16**  
**Spray Foam Insulation**

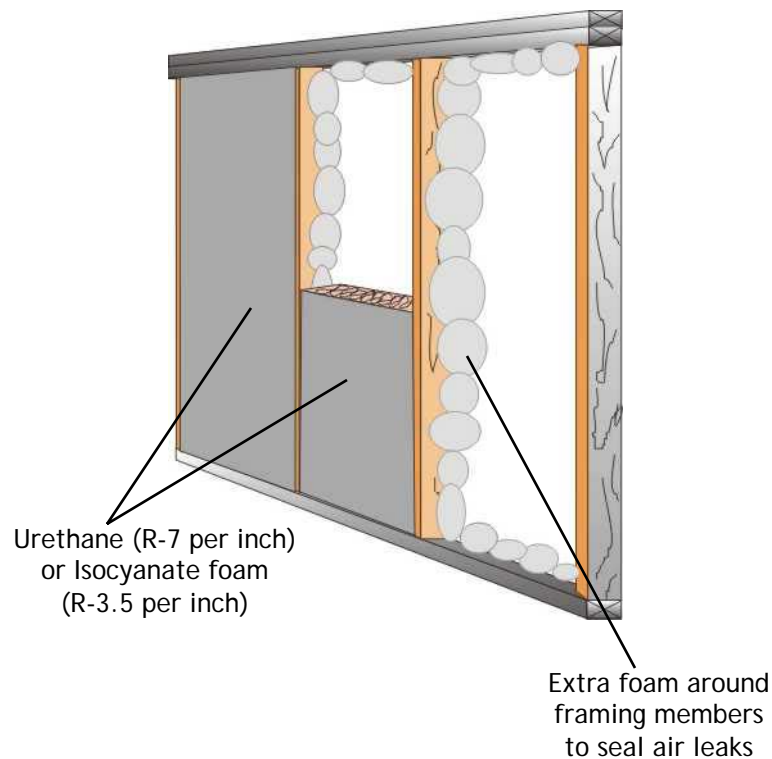

### ***Structural Insulated Panels***

Another approach to wall construction is the use of structural insulated panels (SIPs), also known as stress-skin panels. They consist of 3.5- or 5.5-inch thick foam panels onto which sheets of structural plywood or oriented strand board (OSB) have been glued. They reduce labor costs and, because of the reduced framing in the wall, have higher R-values and less air leakage than standard walls.

SIPs come in a variety of sizes up to whole walls. There are a number of manufacturers, each with its own method of attaching panels together. Procedures for installing windows, doors, wiring, and plumbing have been worked out by each manufacturer. In addition to their use as wall framing, SIPs can also form the structural roof of a building.

**Figure 5-17**  
**Structural Insulated Panels (SIP)**

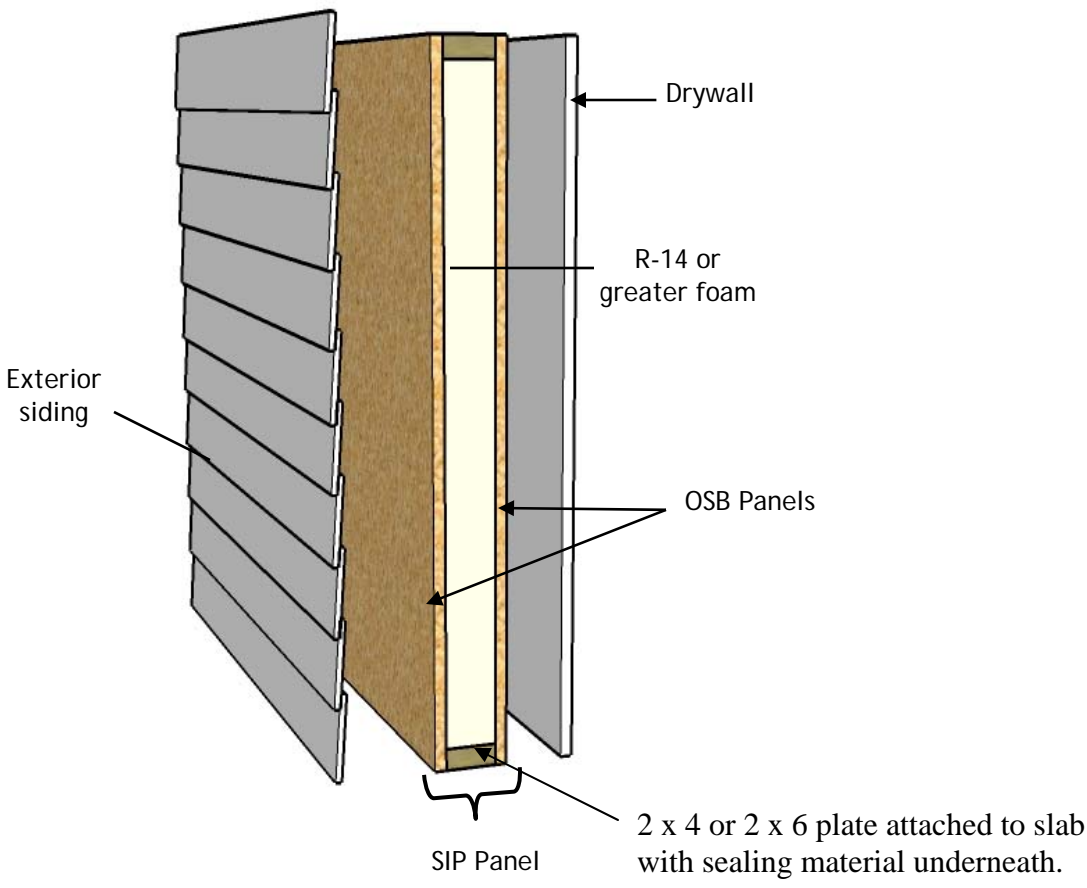

Homes built with SIPs are generally more expensive than those with standard framing and insulation. However, research has shown that they have higher average insulating values and less air leakage.

**Figure 5-18**  
**Structural Insulated Panels Construction**

1

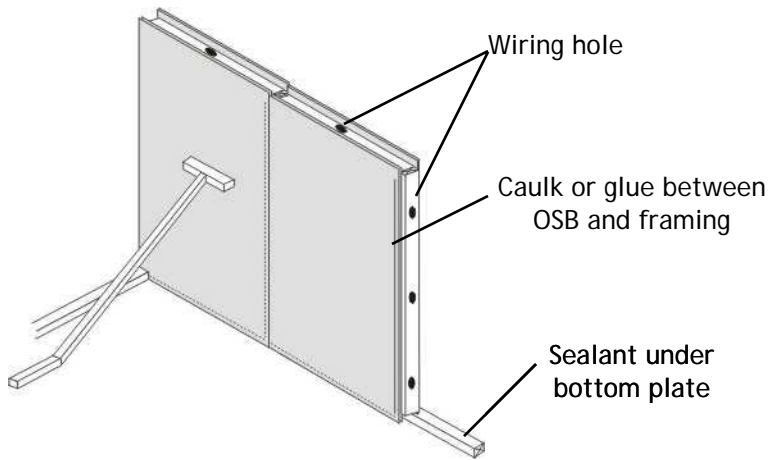

- Install first panel on top of bottom plate - caulk in place
- Be careful to install panel plumb and level

2

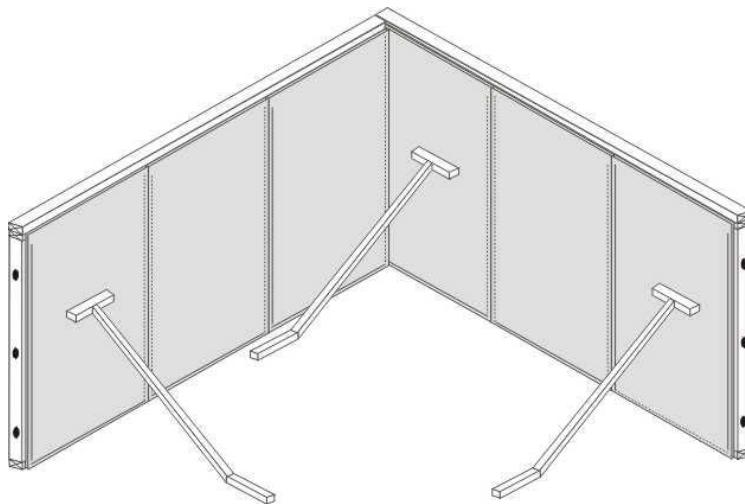

- Continue installing panels, caulking all seams and checking for plumb and level
- Install continuous top plate

3

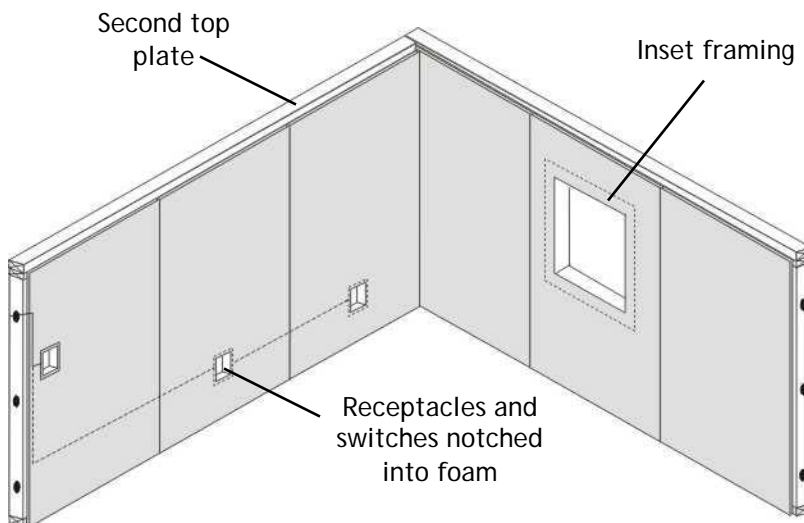

- Install second top plate
- Run wiring
- Cut holes for windows, if necessary
- Notch into foam using a special tool to inset framing around rough openings
- Install caulk and framing

## ***Metal Framing***

Builders and designers are well aware of the increasing cost and decreasing quality of framing lumber. As a consequence, interest in alternative framing materials, such as metal framing, has grown. While metal framing offers advantages over wood, such as consistency of dimensions, lack of warping, and resistance to moisture and insect problems, it has distinct disadvantages from an energy perspective.

Metal framing serves as an excellent conductor of heat. Homes framed with metal studs and plates usually have metal ceiling joists and rafters as well. Thus, the entire structure serves as a highly conductive thermal grid. Insulation placed between metal studs and joists is much less effective due to the extreme thermal bridging that occurs across the framing members.

There have been moisture-related problems in metal frame buildings in Louisiana that do not use insulated sheathing on exterior walls. Metal studs cooled by the air conditioning system can cause moisture in outdoor air to condense on the exterior sheathing and cause mildew streaks. Similar problems can also occur on interior walls in winter.

The American Iron and Steel Institute is well aware of the challenges involved in building an energy efficient steel structure. In their publication *Thermal Design Guide for Exterior Walls* (Publication RG-9405), the Institute provides information on the thermal performance of steel-framed homes. Table 5-6 shows options for meeting the requirements of the IRC in steel framed walls, as well as the impact of metal framing on the effective insulating value of walls. Even in walls with insulating foam sheathing, R-values drop 18% to 27% when substituting metal framing for wood.

**Table 5-6  
Steel Wall Insulation Options**

	Cavity R-Value	Sheathing R-Value	Effective R- Value**
Option 1	13	5	11.5
Option 2	15	4	10.4
Option 3	21 *	3	10.4
*2x6 studs, 16" on center **Does not include sheathing			

Researchers have delved into numerous ways to provide for a thermal break in walls with steel framing. The most effective solution has been to increase the insulating value of the sheathing. However, the home still suffers considerable conduction losses up to the attic if the ceiling joists and rafters are steel-framed. The best solution to the heat gain through steel framing in attics is to install a thermal break, such as a sill sealer material between wall framing and ceiling joists. Then, install a layer of foam sheathing underneath the ceiling joists before installing drywall.

## Wall Sheathings

Many Louisiana builders use 1/2-inch wood sheathing (R-0.6) or asphalt-impregnated sheathing, usually called blackboard (R-1.3), to cover the exterior walls of a building before installing the siding. A better method thermally is to use 1/2-inch expanded polystyrene (R-2), extruded polystyrene (R-2.5 to 3), polyisocyanurate or polyurethane (R-3.4 to 3.6) foam insulated sheathing with diagonal braces. Check with local building code officials before using this method.

**Figure 5-19**  
**Foam Sheathing Keeps Walls Warmer**

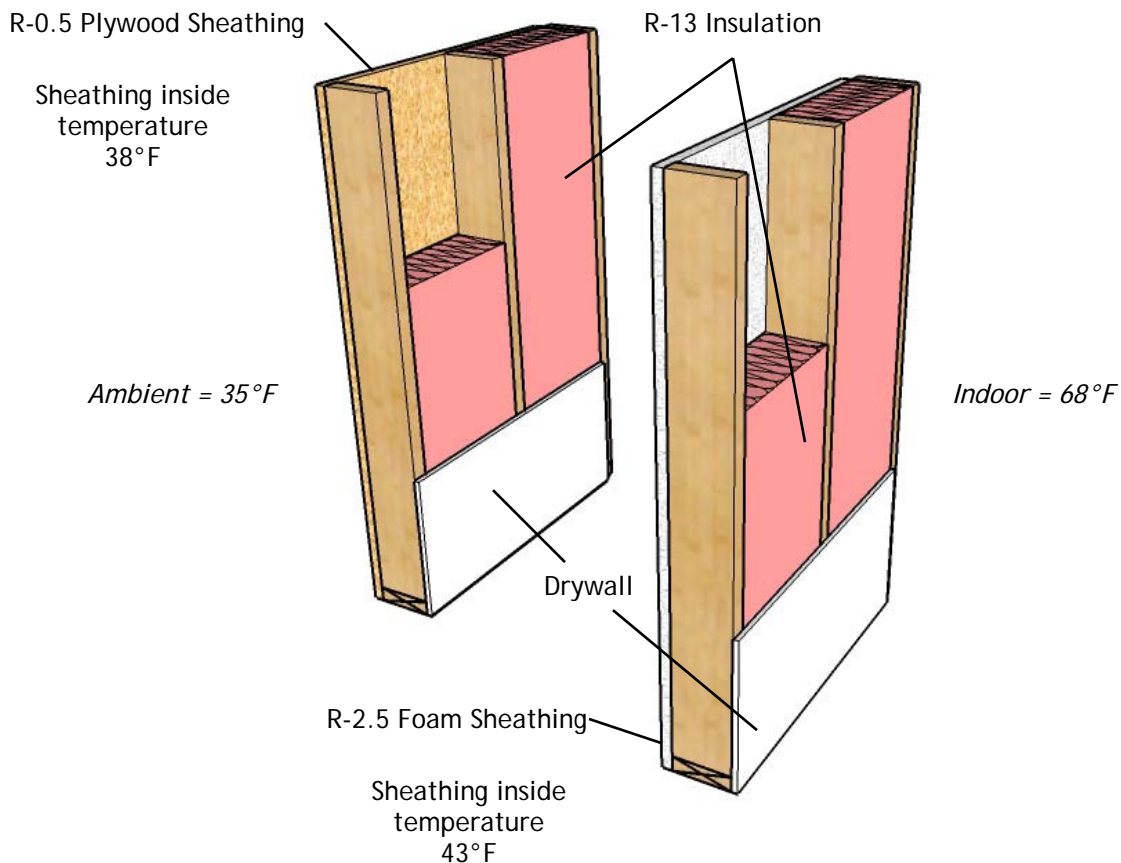

Advantages of foam sheathing over wood or blackboard include:

- Saves energy
- Easier to cut and install
- Protects against condensation (Figure 5-19)
- Less expensive than plywood

The recommended thickness of the sheathing is based on the desired R-value and the jamb design for windows and doors – usually 1/2-inch. Be certain that the sheathing completely covers the top plate and any band joist at the floor. Most manufacturers offer sheathing products in 9- or 10-foot lengths to allow complete coverage of the wall. Once it is installed, patch all holes.

**Table 5-7  
Sheathing Costs\***

Sheathing	Cost (\$)	R-value
1/2" asphalt impregnated fiberboard	349	1.3
1/2" beadboard (MEPS)	349	2.0
1/2" oriented strand board (OSB)	369	0.60
1/2" extruded polystyrene	480	2.5
1/2" polyisocyanurate	480	3.5 - 3.7

\* For a 2,000 square-foot home using 64 sheets of 4 x 8 material.

### **2x6 Wall Construction**

There has been some interest in northern Louisiana about the use of 2x6 lumber for construction. The International Residential Code 2006 allows 2x6s to be spaced on 24-inch centers, rather than the 16-inch centers required for 2x4s. This permits the use of R-19 or 21 insulation in the cavities.

#### ***The Advantages of Using Wider Wall Framing Are:***

- More space provides room for R-19 or R-21 wall cavity insulation.
- Thermal bridging across studs is less of a penalty due to the higher R-value of 2x6s.
- Fewer instances of thermal bridging occur in the wall.
- There is more space for insulating around piping, wiring, and ductwork.

#### ***Disadvantages of 2x6 Framing Include:***

- Wider spacing may not support the interior or exterior finishes adequately, allowing them to bow slightly between studs.
- Window and door jambs are wider and can add \$12 to \$15 per opening for jamb extenders.
- Walls with large window and door areas may require almost as much framing as 2x4 walls, leaving less space for insulation.

The economics of 2x6 wall insulation depends on the number of windows in the wall, since each window opening adds extra studs and requires the purchase of a jamb extender. Figure 5-20 compares 2x4 and 2x6 framing. Walls built with 2x6s having few windows may provide a positive economic payback in northern Louisiana. However, in walls where windows make up over 7.5% of the total area, the economics become questionable because of the cost of jamb extenders and the minor improvement in average wall R-value.



**Figure 5-20**  
**Average Wall R-Value**

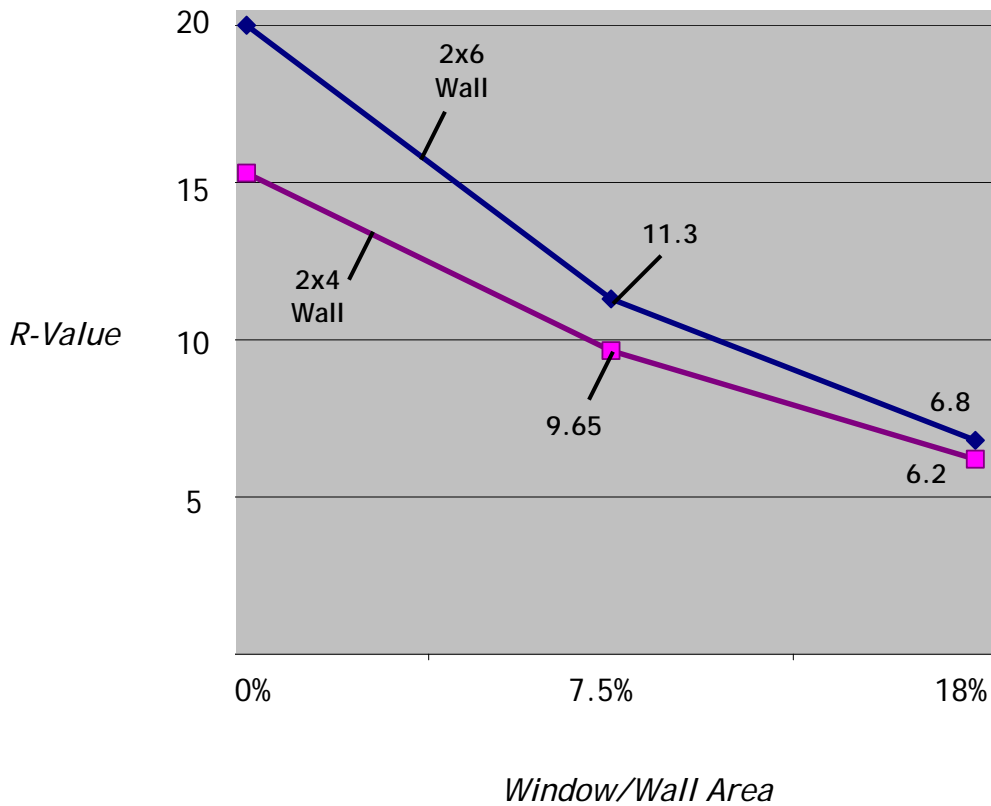

**Table 5-8**  
**Economics of Wall Insulation\***  
**(Compared to pre-code “Business as Usual” R-11 Batts with fair installation)**

	Energy Savings (\$/yr)	Extra Installed Costs (\$)	Annual Rate of Return	Extra Mortgage Costs (\$/yr)
<b>2 x 4 Wall</b>				
R-13 Batts	22	64	36.4%	5
R-15 Batts	38	544	7.6%	44
R-14 Cellulose Insulation (reduced air leakage)	95	534	19.7%	43
R-13 Batts, R-2.5 continuous sheathing	38	424	10.0%	34
<b>2 x 6 Wall</b>				
R-19 Batts	94	736	14.4%	59
R-19 Batts, R-5 continuous sheathing	136	1096	14.0%	88

\*For a home with a 2,000 square-foot floor located in Baton Rouge. Analysis assumes 2% annual fuel price escalation; mortgage is 30-year, 7% loan; the energy savings were estimated using REMRate v. 12.0 software.

## *Ceilings and Roofs*

Attics over flat ceilings are usually the easiest part of a home's exterior envelope to insulate. They are accessible and have ample room for insulation. However, many homes have cathedral ceilings that provide little space for insulation. It is important to insulate both types of ceilings properly.

### **Attic Ventilation**

In summer, ventilation reduces roof and ceiling temperatures, thus saving on cooling costs and lengthening the roof's life. In winter, properly designed roof vents expel moisture which could otherwise accumulate and deteriorate insulation or other building materials.

### ***Is Ventilation Necessary?***

At present, building science experts are questioning whether attic ventilation is beneficial. For years, researchers have believed the cooling benefits of ventilating a well insulated attic are negligible. However, some experts are now questioning whether ventilation is even effective at moisture removal. Until the results of current research have been accepted, builders should follow local code requirements.

### ***Unvented Attics***

Unventilated attics can provide durable, energy efficient structures if using structural insulated panels or aerated concrete panels as the roofing system of the structure. Some builders have opted to pack the rafter space in cathedral ceilings completely with high density insulation, such as cellulose or rock wool and eliminate attic ventilation. However, this approach will avoid moisture problems only with careful installations and detailing.

### ***Vent Selection***

If ventilating the roof, locate vents high along the roof ridge and low along the eave or soffit. Vents should provide air movement across the entire roof area. There are a wide variety of products available including ridge, gable, soffit, mushroom, and turbine vents.

The combination of continuous ridge vents along the peak of the roof and continuous soffit vents at the eave provides the most effective ventilation. Ridge vents come in a variety of colors to match any roof. Some brands are made of corrugated plastic that can be covered by cap shingles to hide the vent from view.

**Figure 5-21**  
**Ridge and Soffit Vents**

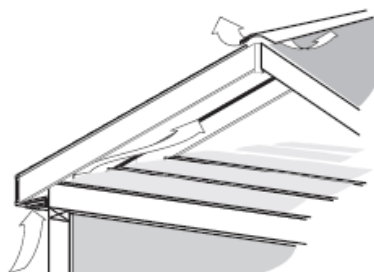

### ***Guidelines for Attic/Roof Ventilation***

The amount of attic ventilation needed is determined by the size of the attic floor and the amount of moisture entering the attic. General guidelines are:

- 1 square foot of attic vent for each 150 square feet of attic floor area without a ceiling vapor barrier, such as the backing on batt insulation.
- The total vent area should be divided equally between high and low vents; thus, if 10 total square feet of vent are needed, locate 5 square feet at the ridge and another 5 square feet at the soffit.
- Only the net free area is effective – about 70% of the total vent area (discounts the louvers and flange of the vents).

### ***Powered Attic Ventilator Problems***

Electrically powered roof ventilators can consume more electricity to operate than they save on air conditioning costs and are not recommended for most designs. NEVER use a powered ventilator with a sealed attic! Power vents can create negative pressures in the home, which may have detrimental effects such as:

- Drawing air from the crawl space into the home
- Removing conditioned air from the home through ceiling leaks and bypasses
- Pulling pollutants such as pesticides and sewer gases into the home
- Backdrafting fireplaces and fuel-burning appliances

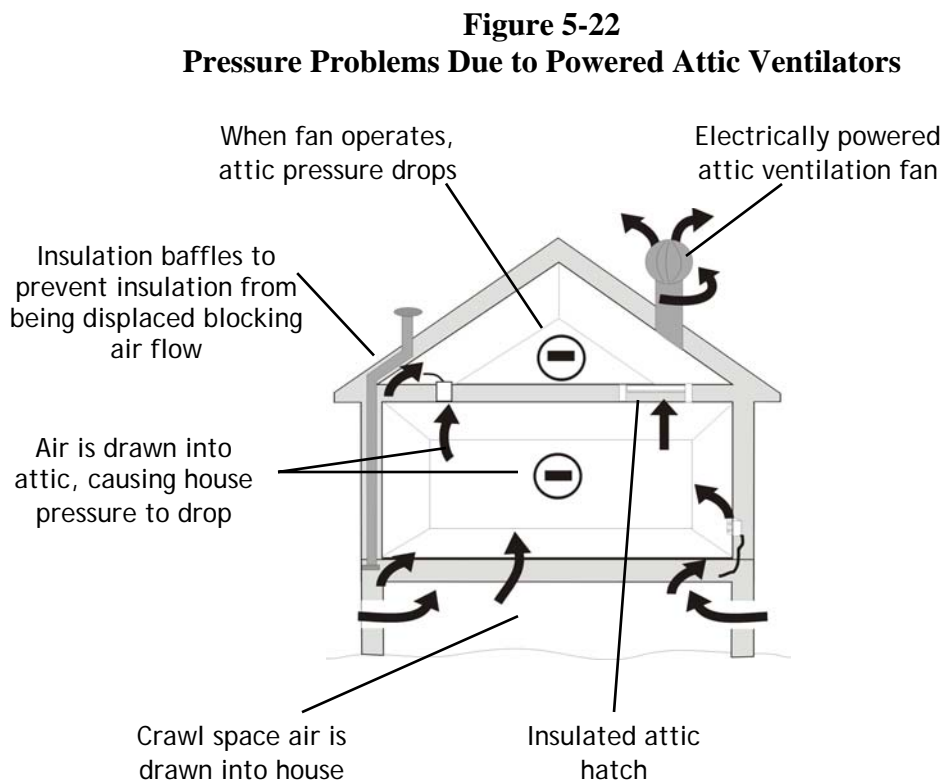

## Attic Floor Insulation Techniques

Either loose-fill or batt insulation can be installed on an attic floor. Unfaced batts should be installed. As shown in Table 5-9, blowing loose-fill attic insulation – fiberglass, rock wool or cellulose – is usually less expensive than installing batts or rolls. Batts are less likely to be moved by high air flows from storms in a vented attic, but baffles are available to keep loose-fill insulation in place.

**Table 5-9**  
**Typical Attic Insulation Costs (\$/sq ft)**

R-30 Batt Insulation	1.30
R-25 Blown Insulation	0.79
R-30 Blown Insulation	0.89
R-38 Blown Insulation	0.98

### *Steps For Installing Loose-Fill Attic Insulation:*

1. Seal attic air leaks, as prescribed by fire and energy codes.
2. Follow manufacturer’s clearance requirements for heat-producing equipment found in an attic, such as flues or exhaust fans. Other blocking requirements may be mandated by local building codes. Use metal flashing, plastic or cardboard baffles, or pieces of batt insulation for blocking. Attic blocking requirements are shown in Figure 5-23 on the previous page.
3. Use cardboard baffles, insulation batts, or other baffle materials to preserve ventilation from soffit vents at eave of roof.
4. Insulate the attic hatch or attic stair. There are foam boxes for providing a degree of insulation over a pull-down attic stairway.
5. Determine the attic insulation area. Based on the spacing and size of the joists, use the chart on the insulation bag to determine the number of bags to install. Table 5-10 shows a sample chart for cellulose insulation.
6. Avoid fluffing the insulation (blowing with too much air) by using the proper air-to-insulation mixture in the blowing machine. A few insulation contractors have “fluffed” loose-fill insulation to give the impression of a high R-value. The insulation may be the proper depth, but if too few bags are installed, the R-values will be less than claimed.
7. Obtain complete coverage of the blown insulation at similar insulation depths. Use attic rulers to ensure uniform depth of insulation. This is an IRC 2006 requirement – see details there.

**Table 5-10**  
**Typical Blowing Chart for Loose-Fill Insulation (Cellulose Insulation Example)**

R-value at 75° F	Minimum Thickness (in)	Minimum Weight (lb/sq ft)	2x6 Joists Spaced 24 Inches on Center		2x6 Joists Spaced 16 Inches on Center	
			Coverage per 25-lb bag (sq ft)	Bags per 1,000 sq ft	Coverage per 25-lb bag (sq ft)	Bags per 1,000 sq ft
R-40	10.8	2.10	12	83	13	77
R-30	8.1	1.45	17	59	19	53
R-24	6.5	0.98	21	48	23	43
R-19	5.1	0.67	37	27	41	24

**Figure 5-23  
Attic Blocking Requirements**

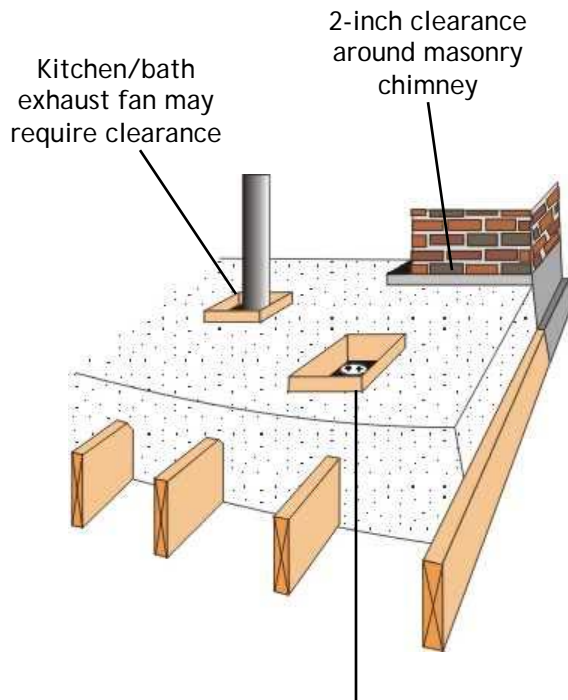
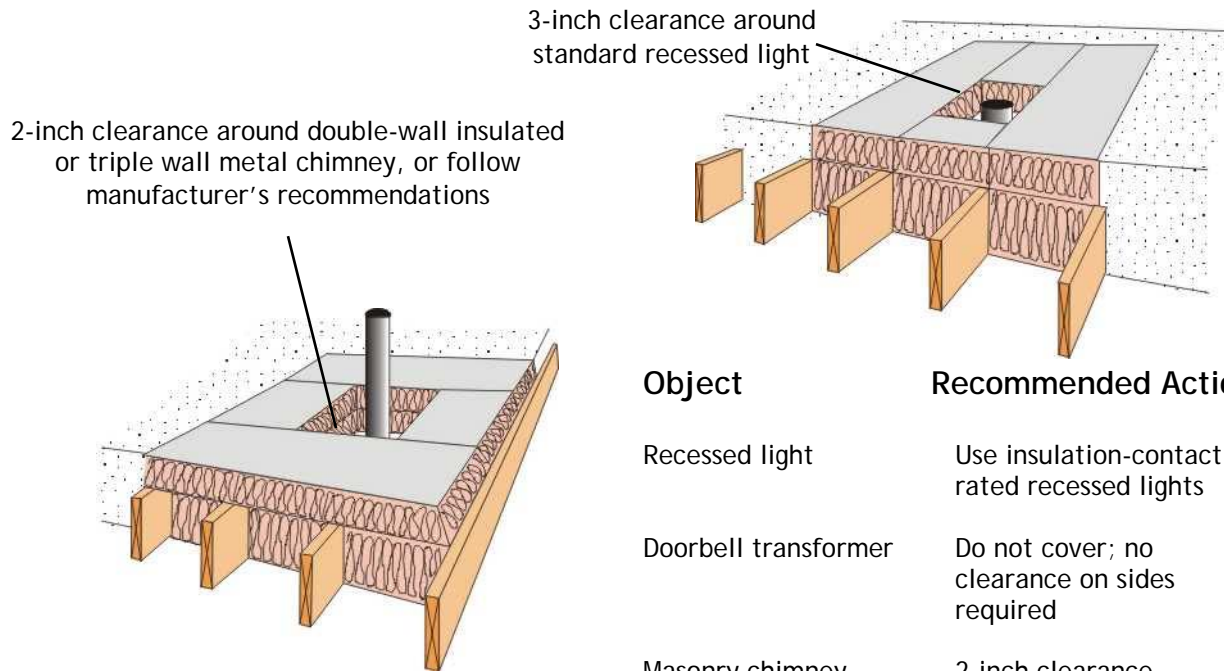

Put covers on all electric junction boxes and insulate.

Object	Recommended Action*
Recessed light	Use insulation-contact rated recessed lights
Doorbell transformer	Do not cover; no clearance on sides required
Masonry chimney	2-inch clearance
Metal chimney	2-inch clearance or follow manufacturer's recommendations
Vent pipes from fuel-burning equipment	Follow manufacturer's recommendations
Kitchen/bath exhaust	Duct to the outside
Heat/light/ventilator	3-inch clearance on all sides
Uncovered electric junction boxes	Cover the box and insulate over it; if it is left uncovered, leave a 3-inch clearance.
Whole house fan	Install blocking up to the fan housing; leave 3-inch clearance around fan motor
Attic access door	Block around the door if blowing in loose-fill insulation

*\*These are general guidelines. Follow specific manufacturer's guidelines.*

### Steps for Installing Batt Insulation

1. Seal attic air leaks, as prescribed by fire and energy codes.
2. Block around heat-producing devices, as described in Step 2 for loose-fill insulation.
3. Insulate the attic hatch or attic stair as described in Step 4 for loose-fill insulation.
4. Determine the attic insulation area based on the spacing and size of the joists; order sufficient R-30 insulation for the flat attic floor. Choose batts that are tapered cut – wider on the top – so that they cover the top of the ceiling joists. (Figure 5-24)
5. When installing the batts, make certain they completely fill the joist cavities. Shake batts to ensure proper loft. If the joist spacing is uneven, patch gaps in the insulation with scrap pieces. Try not to compress the insulation with wiring, plumbing, or ductwork. In general, obtain complete coverage of full-thickness, non-compressed insulation.
6. Attic storage areas can pose a problem. If the ceiling joists are shallower than the depth of the insulation (generally less than 2x10s), raise the finished floor using 2x4s or other spacing lumber. Install the batts before nailing the storage floor in place. (Figure 5-25)

**Figure 5-24**  
**Full Width Batts**

Batts are cut wider on top to cover tops of ceiling joists

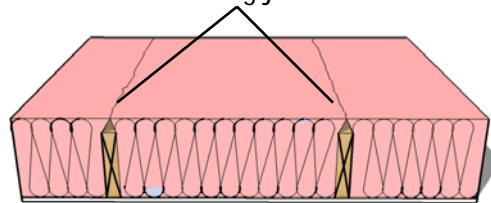

**Figure 5-25**  
**Insulating under Attic Floors**

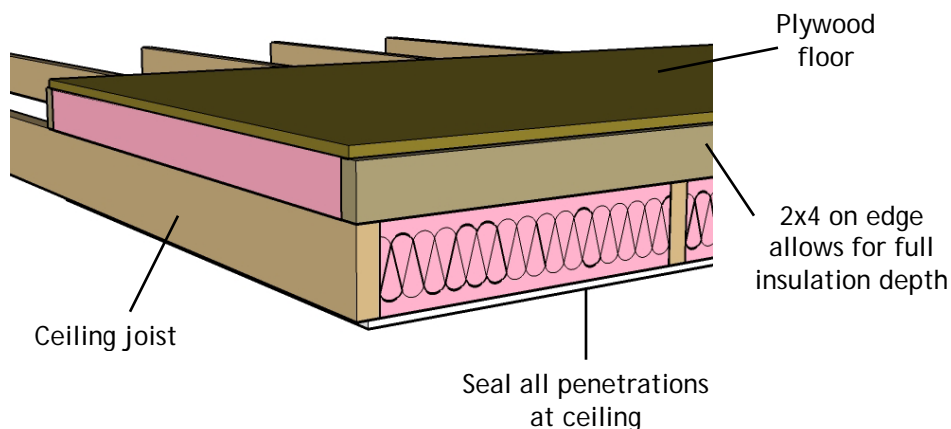

### Increasing the Roof Height at the Eave

One problem area in many standard roof designs is at the eave, where there is often insufficient space for full insulation without blocking air flow from the soffit vents. If the insulation is compressed, its R-value will decline. Figure 5-26 shows several solutions to this problem. If using a

truss roof, purchase raised heel trusses that form horizontal overhangs. They should provide clearance for both ventilation and insulation.

In stick-built roofs, where rafters and ceiling joists are cut and installed at the construction site, an additional top plate that lays across the top of the ceiling joists at the eave will prevent compression of the attic insulation. The rafters sitting on this raised top plate allow for both insulation and ventilation.

The raised top plate design also minimizes windwashing of the attic insulation, where air entering the soffit vents flows through the attic insulation. Place a band joist over the open joist cavities of the roof framing. The band joists help prevent windwashing, which can reduce attic insulation R-values on extremely cold days and can add moisture to the insulation. Another method of preventing windwashing is to use preformed cardboard or foam forms which fit snugly between rafters and are designed for this purpose.

Raised top plates also elevate the overhang of the home, which may enhance the building's attractiveness. The aesthetic advantage is especially useful in one-story homes with standard 8-foot ceilings. However, raised top plates can reduce shading on exposed windows.

**Table 5-11**  
**Economics of Attic Insulation\***  
**Compared to R-19 Blown Insulation**

	Energy Savings (\$/yr)	Extra Installed Costs (\$)	Annual Rate of Return	Extra Mortgage Costs (\$/yr)
R-25 Blown Insulation	38	210	20.0%	17
R-30 Blown Insulation	59	385	17.1%	31
R-38 Blown Insulation	81	665	13.7%	54
R-50 Blown Insulation	102	1085	10.6%	87

\*For a home with a 2,000 square-foot attic located in Baton Rouge. Analysis assumes 2% annual fuel price escalation; mortgage is 30-year, 7% loan; the energy savings were estimated using REMRate v. 12.0 software.

**Figure 5-26**  
**Insulation Options for Eaves**

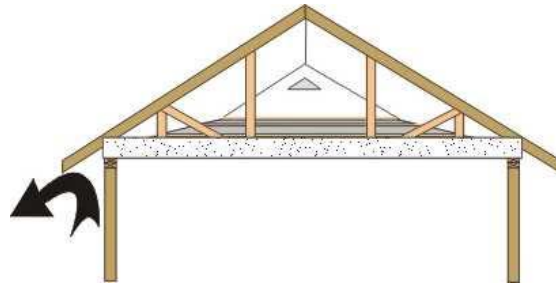

Problem - Roof deck compresses insulation and blocks air flow from soffit vent

Truss Roof

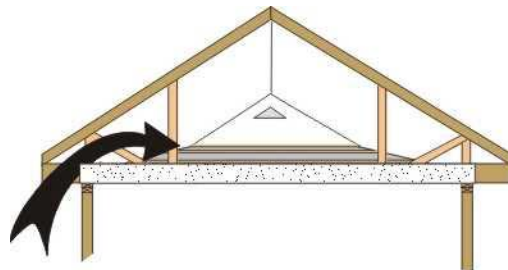

Solution - raised heel trusses  
Insulation not compressed; air flow path is open

Wood-Framed Roof

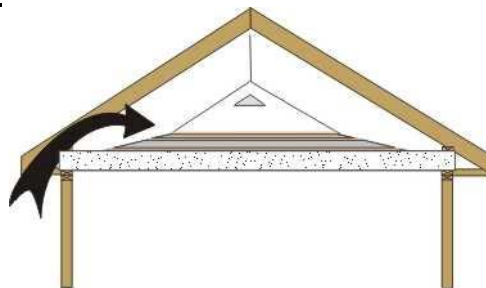

Solution - raised top plate  
Insulation not compressed; air flow path is open



### ***Problems with Recessed Lights***

Standard recessed fixtures require a clearance of several inches between the lamp's housing and the attic insulation. Even worse, recessed fixtures leak air between the attic and the conditioned space. IC-rated (insulation contact rated) fixtures have a heat sensor switch that allows the fixture to be covered with insulation. However, these units also leak air. Airtight, IC-rated fixtures are permitted by the 2006 International Residential Code and the 2006 International Energy Conservation Code. Otherwise the non-airtight fixture must be installed in a sealed recess. Alternatives to recessed lights include surface-mounted ceiling fixtures and track lighting, both of which typically contribute less air leakage to the home. For more information on lighting, see chapter 9.

**Figure 5-27**  
**Airtight, IC-rated Recessed Lamps**

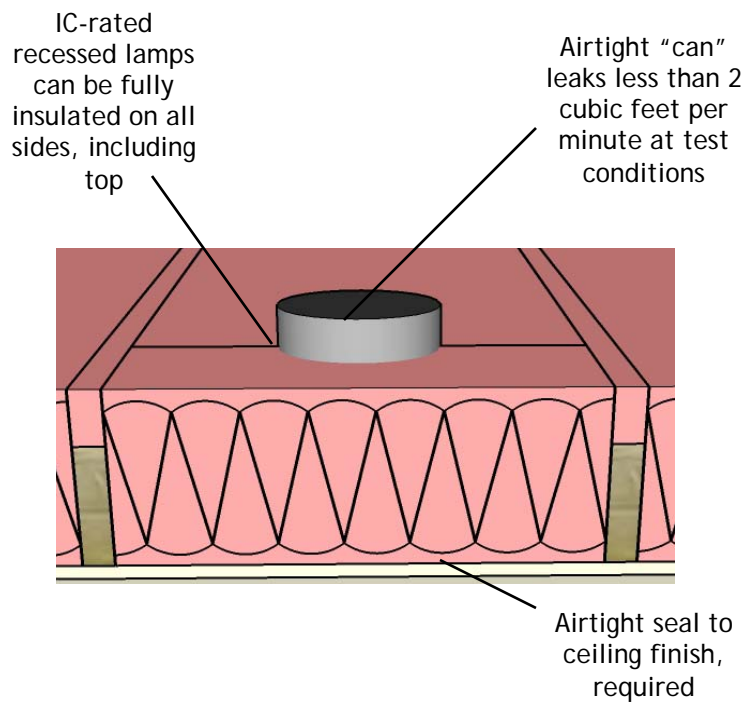

### **Cathedral Ceiling Insulation Techniques**

Cathedral ceilings are a special case because of the limited space for insulation and ventilation within the depth of the rafters. Fitting in a 10-inch batt (R-30) and still providing ventilation is impossible with anything less than a 2x12 rafter. For the entire state, R-30 insulation is now required.

### ***Building R-30 Cathedral Ceilings***

Cathedral ceilings built with 2x12 rafters can be insulated with standard R-30 batts and still have adequate space for ventilation. Some builders use a vent baffle between the insulation and roof decking to ensure that the ventilation channel is maintained. If 2x12s are not required structurally, most builders find it cheaper to construct cathedral ceilings with 2x10 rafters and high density R-30 batts, which are 8¼- inches thick.

Some contractors wish to avoid the higher cost of 2x10 lumber and use 2x8 rafters. These roofs are usually insulated with R-19 batts. However, 2x10 rafters can be spaced 24 inches on center and may cost little more than 2x8 rafters spaced 16 inches on center.

If framing with 2x6 or 2x8 rafters, insufficient space is available for standard R-30 insulation. Higher insulating values can be obtained by installing rigid foam insulation between the rafters. However, foam is expensive and using deeper rafters with batt or loose-fill insulation may be substantially less costly.

**Figure 5-28  
Cathedral Ceiling Insulation Options**

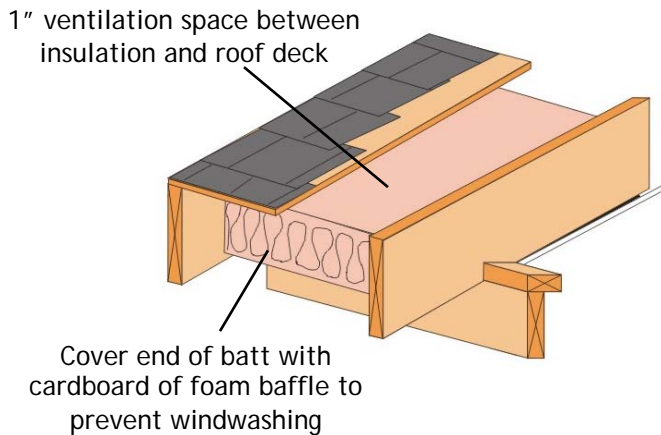

- Construction Options:
- 2x8 Rafter, R-30 foam
  - 2x10 Rafter, R-30 foam
  - 2x10 Rafter, moderate density R-30 batt
  - 2x12 Rafter, R-30 batt
  - 2x12 Rafter, blown-in cellulose, fiberglass or rock wool held in place

**Scissor Trusses**

Scissor trusses are another cathedral ceiling efficiency framing option. They have a greater roof pitch than ceiling pitch, thus creating more space than standard framing provides between the roof and the ceiling. Make certain that they have adequate room for both R-30 insulation and ventilation, especially at their ends, which form the eave section of the roof.

**Table 5-12  
Economics of Cathedral Ceiling Insulation\*  
Compared to R-19 Batt**

	Energy Savings (\$/yr)	Extra Installed Costs (\$)	Annual Rate of Return	Extra Mortgage Costs (\$/yr)
R-25 Batt	28	87	34.2%	7
R-30 High Density Batt	43	150	30.7%	12

\*For a 2,000 square-foot home with 25% vaulted ceiling located in Baton Rouge. Analysis assumes 2% annual fuel price escalation; mortgage is 30-year, 7% loan; the energy savings were estimated using REMRate v. 12.0 software.

**Ceilings with Exposed Rafters**

A cathedral ceiling with exposed rafters or roof decking is difficult and expensive to insulate well. Often, foam insulation panels are used over the attic deck as shown in Figure 5-29. However, to achieve R-30, 4- to 7-inches of foam insulation, costing \$1 to \$3 per square foot, is needed. Ventilation is also a problem and some shingle manufacturers do not offer product warranties unless

the outer roof decking is ventilated. In homes where exposed rafters are desired, it may be more economical to build a standard, energy efficient cathedral ceiling and then add exposed decorative beams underneath. Note that homes having tongue-and-groove ceilings can experience substantially more air leakage than those with, drywall ceilings. Install a continuous air barrier, sealed to the walls, above the tongue-and-groove roof deck.

**Figure 5-29**  
**Cathedral Ceiling – Exterior Roof Insulation**

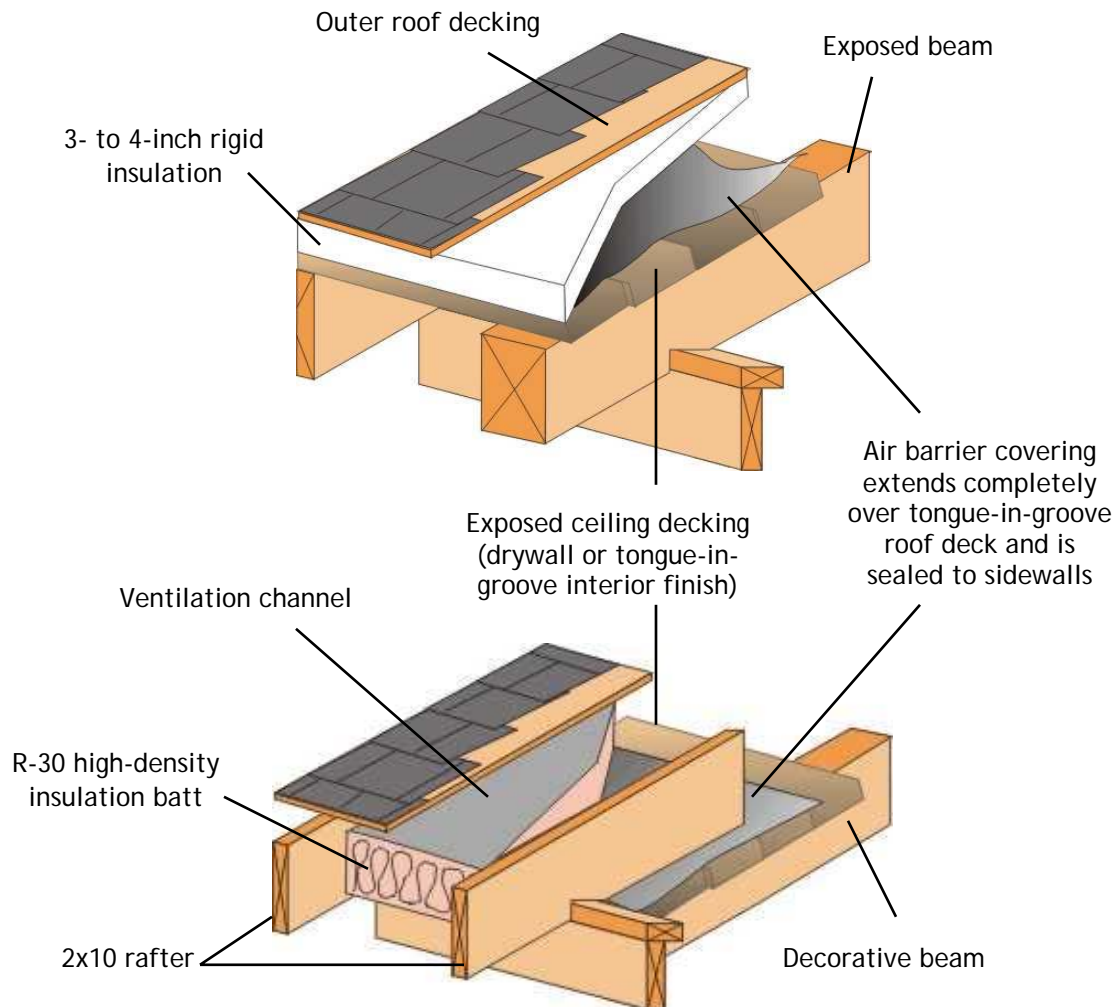

### **Radiant Heat Barriers**

Radiant heat barriers (RHBs) are reflective materials that can reduce summer heat gain in attics and walls. While not generally a substitute for insulation, they can be used in concert with minimum levels of insulation to lower air conditioning costs during warm and hot weather. Their use should be carefully considered as they may also act as vapor barriers causing condensation within structures and insulation. If used, in most cases a perforated material should allow water vapor to pass through the material.

The chapter on Natural Cooling provides more detailed information on radiant heat barriers. They have a controversial history in the Southeastern United States because manufacturers oversold their

benefits during the late 1980s and early 1990s. In particular, some sales representatives made excessive claims about the performance of the product and priced it too high to provide a reasonable payback.

Radiant heat barriers do not have to be expensive. Many are available for less than \$0.15 per square foot. Because RHBs can reduce cooling bills by 10% to 20%, inexpensive products can be cost effective.