

INTEGRATE

CASEGOODS SPEC GUIDE

High-Pressure Laminate · June 2020



OFG UNICOR
OFFICE
FURNITURE
GROUP

With an upscaled design tailored to create distinctive functional work environments, Integrate offers a myriad of choices to help you create a truly custom look.

Integrate's distinctive design maximizes its flexibility. A thin profile and fewer parts, gives this line a clean and modern aesthetic.

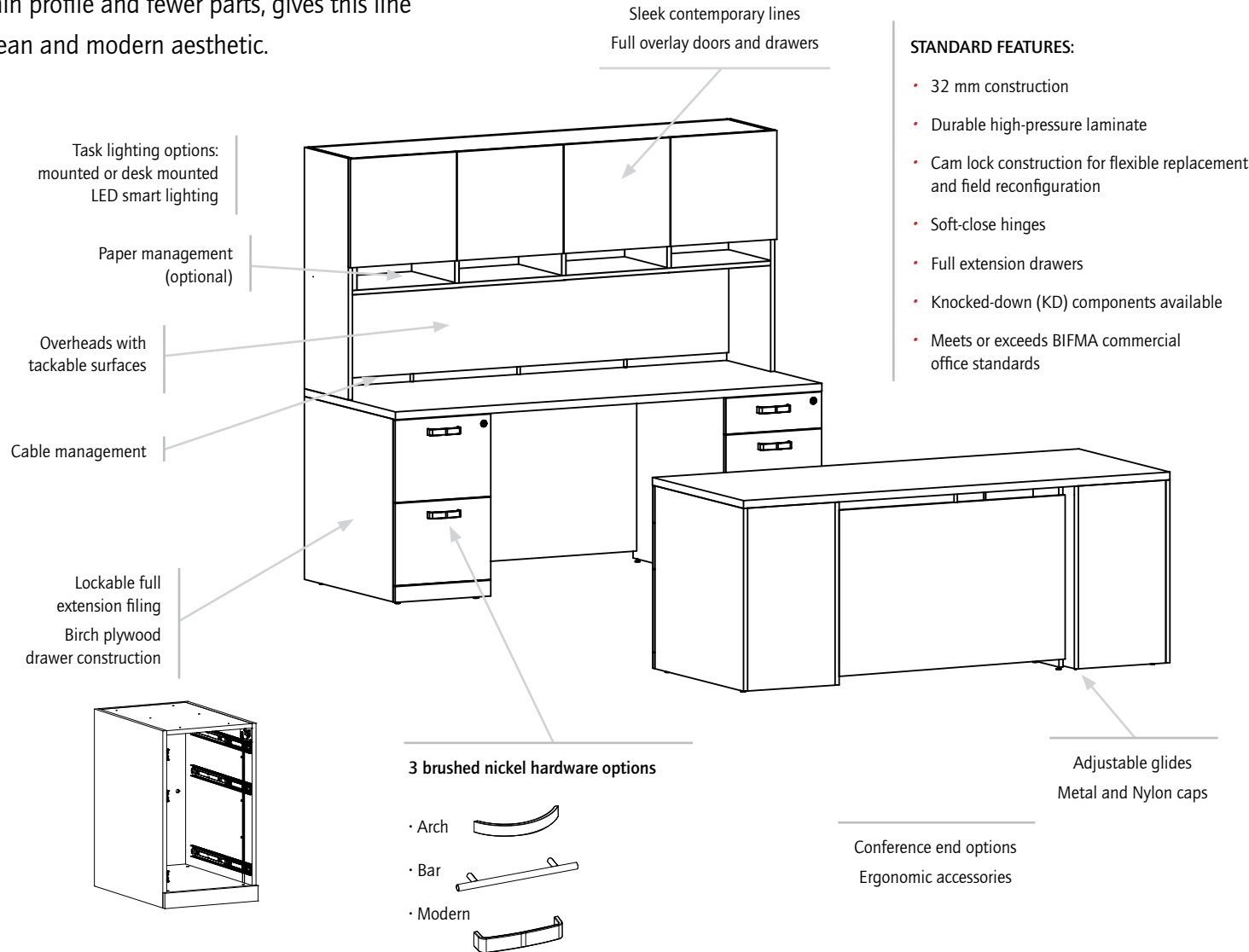

Integrate offers contract grade quality and durability all priced to fit your budget. Complementary, coordinating or contrasting color schemes, choices of hardware, and built-in flexibility make Integrate an excellent choice for any office setting.

Extensive ergonomic seating solutions are also available to complement this offering to complete one cohesive look.

With one of the best warranties in the industry, we stand behind everything we build.

Integrate proves you can have it all!



Spec Guide Contents

- Overview
- Configuration Ideas
- Standard Offering
- Accessories

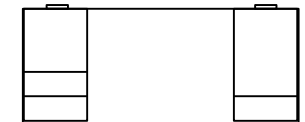
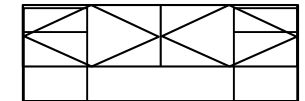

Product dimensions shown in approximate inches. *All components available in matching OFG Harmony Casegoods laminate colors – see page 55 for more information.

INTEGRATE • An Overview

INTEGRATE

DESKS

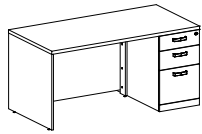

Single Pedestal Desk with Pencil, Box, File on right.

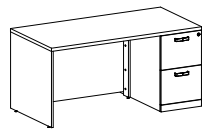

Single Pedestal Desk with Two Drawer File on right

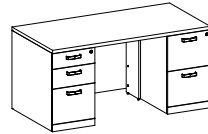

Double Pedestal Desk with Two Drawer File on right, Pencil, Box, File on left.



Double Pedestal Desk with Pencil, Box, File on right, Two Drawer File on left.

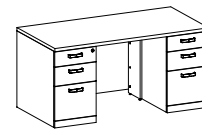

Double Pedestal Desk with Pencil, Box, File on left and right.

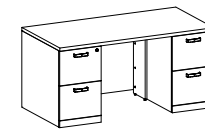

Double Pedestal Desk with Two Drawer File on left and right.

* All pedestals may be configured right or left.

SHELL DESK/CREDENZA

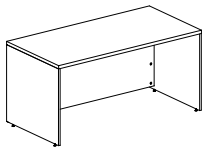

Shell Desk w/Full Modesty Panel

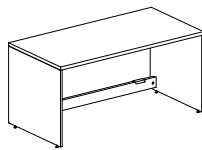

Shell Desk w/Access Panel **KD**

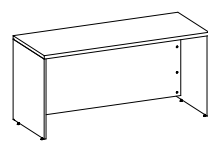

Shell Credenza w/Full Modesty Panel



Shell Credenza w/Access Panel **KD**

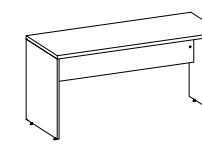

Shell Credenza w/Half Modesty Panel

CREDENZAS – SINGLE PEDESTAL

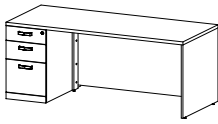

Single Pedestal Credenza w/Full Modesty with Pencil, Box, File

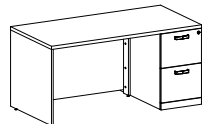

Single Pedestal Credenza w/Full Modesty with Two Drawer File

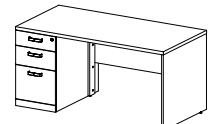

Single Pedestal Credenza w/Half Modesty with Pencil, Box, File

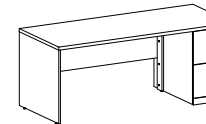

Single Pedestal Credenza w/Half Modesty with Two Drawer File

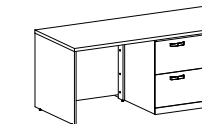

2 Drawer Lateral Credenza w/Full Modesty Panel

* All pedestals/laterals may be configured right or left.

EXTENSIONS

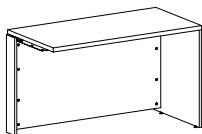

L-Unit Extension w/Full Modesty Panel **KD**

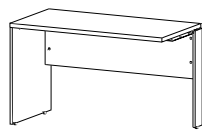

L-Unit Extension w/Half Modesty Panel **KD**

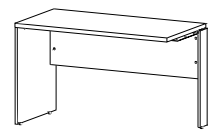

L-Unit Extension w/Support Modesty Panel **KD**

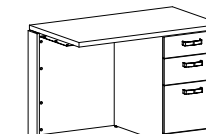

L-Unit Extension w/Full Modesty Panel & Pencil, Box, File **KD**

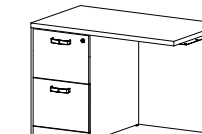

L-Unit Extension w/Full Modesty Panel & Two Drawer File

* L-Unit Extensions may be configured right or left.

- Non-handed/reconfigurable
- Field replaceable components
- Matching and contrasting finishes
- Wire/cable management
- Lockable storage components
- Easy access leveling
- 32mm fabrication system assures precision construction and assembly
- Durable, high-pressure laminate
- Freestanding modular components
- Metal hardware & leveling hinges
- Birch plywood drawer construction
- Engineered wood substrate (1-1/8" work surfaces, 5/8" vertical panels and 5/8" tops on freestanding components)
- All file drawers have central locking mechanism
- Adjust power & communications access panels without tools
- Indoor Air Quality Certified to SCSEC10.3-2014 Conforms to the ANSI/BIFMA Furniture Emissions Standard

NOTE:

KD – Indicates product available KD (knocked-down)
 WSS – Work Surface Supporting (without finish top)
 Freestanding Components – Pedestals, Credenza Bases and Lateral Files.

INTEGRATE • An Overview



BRIDGES

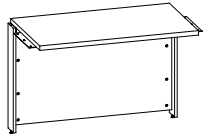

U-Unit Bridge
w/Full Modesty Panel **KD**

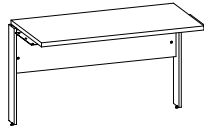

U-Unit Bridge
w/Half Modesty Panel **KD**

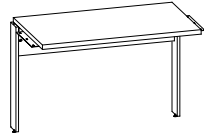

U-Unit Bridge
w/Supporting Modesty Panel **KD**

PEDESTALS

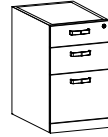

Pencil, Box, File
Pedestal

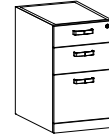

Pencil, Box, File
Mobile Pedestal



Pencil, Box, File Pedestal
WSS (without Top)

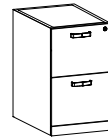

Two File Drawer
Pedestal

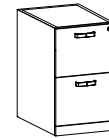

Two File Drawer
Mobile Pedestal

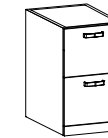

Two File Drawer Pedestal
WSS (without Top)

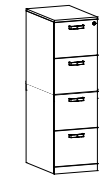

Vertical File, 4 Drawer
Freestanding

CREDENZA BASES

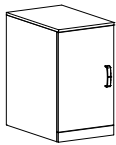

Credenza Base,
Single Door, Closed
Stand-Alone

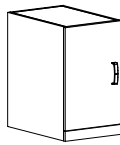

Credenza Base, Single Door,
Closed WSS (without Top)

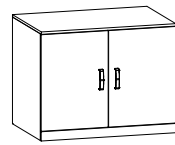

Credenza Base,
Double Door, Closed
Stand-Alone

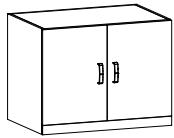

Credenza Base, Double Door,
Closed WSS (without Top)



Credenza Base,
Mixed Drawer
Stand-Alone

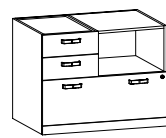

Credenza Base, Mixed Drawer
WSS (without Top)

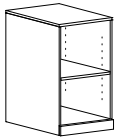

Credenza Base, Open, Stand-
Alone (1 adjustable shelf)

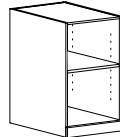

Credenza Base, Open
(1 adjustable shelf) WSS
(without Top)

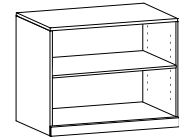

Credenza Base, Open, Stand-
Alone (1 adjustable shelf)

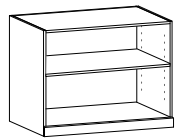

Credenza Base, Open
(1 adjustable shelf) WSS (
without Top)

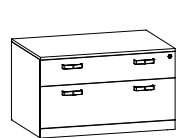

Credenza Base, Low
Box & Lateral Drawers

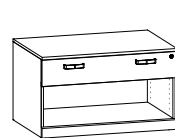

Credenza Base, Low
Box Drawer & Open Shelf

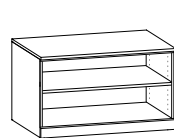

Credenza Base, Low
Open with 1 Shelf

RECEPTION CENTER

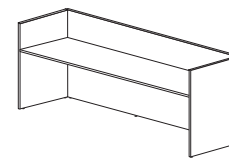

Reception Center
Desk **KD**

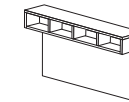

Reception Center
Transaction Counter **KD**

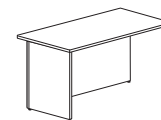

Reception Center
Return **KD**

- Non-handed/reconfigurable
- Field replaceable components
- Matching and contrasting finishes
- Wire/cable management
- Lockable storage components
- Easy access leveling
- 32mm fabrication system assures precision construction and assembly
- Durable, high-pressure laminate
- Freestanding modular components
- Metal hardware & leveling hinges
- Birch plywood drawer construction
- Engineered wood substrate (1-1/8" work surfaces, 5/8" vertical panels and 5/8" tops on freestanding components)
- All file drawers have central locking mechanism
- Adjust power & communications access panels without tools
- Indoor Air Quality Certified to SCSECT10.3-2014 Conforms to the ANSI/BIFMA Furniture Emissions

NOTE:

KD – Indicates product available KD (knocked-down)

WSS – Work Surface Supporting (without finish top)

Freestanding Components – Pedestals, Credenza Bases and Lateral Files.

INTEGRATE • An Overview



LATERAL FILES

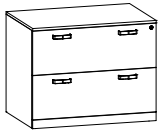

Lateral File,
Two Drawer
Stand-Alone (with Top)

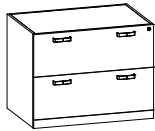

Lateral File,
Two Drawer
WSS (without Top)

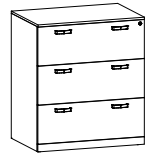

Lateral File,
Three Drawer
Stand-Alone (with Top)

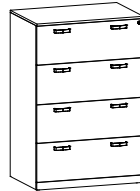

Lateral File,
Four Drawer
Stand-Alone (with Top)

BOOKCASES



Bookcase, 3 Shelf,
Freestanding

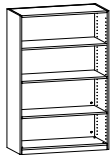

Bookcase, 4 Shelf,
Freestanding

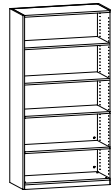

Bookcase, 5 Shelf,
Freestanding

SIDE SHELVING & UPPER SHELVING UNITS



Side Shelving, Upper
(use with Pedestal
or Credenza Base, WSS)

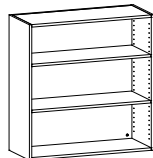

Upper Shelves, Open

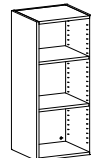

Upper Shelves, Open

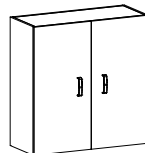

Upper Shelves, Closed

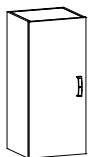

Upper Shelves, Closed

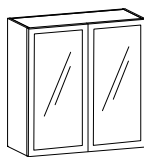

Upper Shelves, Closed with
Frosted Glass

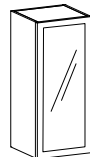

Upper Shelves, Closed with
Frosted Glass

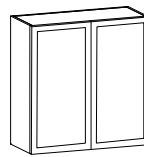

Upper Shelves, Closed with
White Marker Board

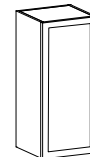

Upper Shelves, Closed with
White Marker Board

CONFERENCE ENDS

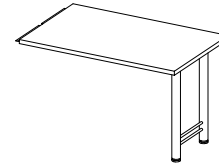

Conference End
H-Leg
with Mending Plate **KD**

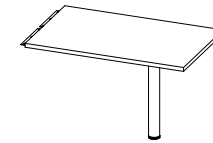

Conference End
3" Metal Column
with Mending Plate **KD**

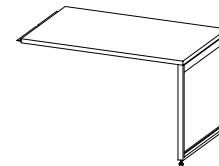

Conference End
Metal Frame
with Mending Plate **KD**

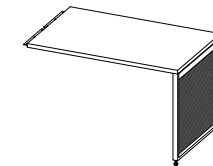

Conference End
Metal 1-Piece Insert
with Mending Plate **KD**

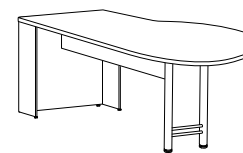

Conference "P" End
Free-Standing, w/H-Leg **KD**

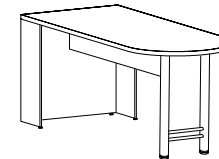

Conference "D" End
Free-Standing, w/H-Leg **KD**

- Non-handed/reconfigurable
- Field replaceable components
- Matching and contrasting finishes
- Wire/cable management
- Lockable storage components
- Easy access leveling
- 32mm fabrication system assures precision construction and assembly
- Durable, high-pressure laminate
- Freestanding modular components
- Metal hardware & leveling hinges
- Birch plywood drawer construction
- Engineered wood substrate (1-1/8" work surfaces, 5/8" vertical panels and 5/8" tops on freestanding components)
- All file drawers have central locking mechanism
- Adjust power & communications access panels without tools
- Indoor Air Quality Certified to SCSEC10.3-2014 Conforms to the ANSI/BIFMA Furniture Emissions

NOTE:

- KD** – Indicates product available KD (knocked-down)
- WSS – Work Surface Supporting (without finish top)
- Freestanding Components – Pedestals, Credenza Bases and Lateral Files.

INTEGRATE • An Overview

INTEGRATE

OVERHEADS

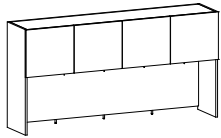

Overhead, Closed Full Back, with Solid Doors

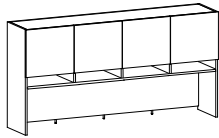

Overhead, Closed Full Back, Solid Doors with Paper Management

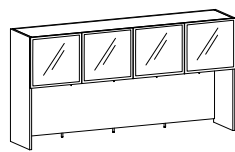

Overhead, Closed Full Back, Frosted Glass Doors

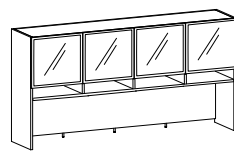

Overhead, Closed Full Back, Frosted Glass Doors with Paper Management

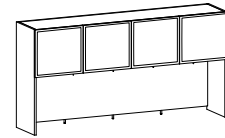

Overhead, Closed Full Back, with White Marker Board Doors

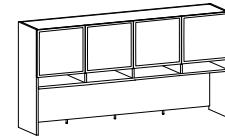

Overhead, Closed Full Back, White Marker Board Doors with Paper Management

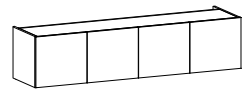

Overhead, Wall Mount, with Solid Doors

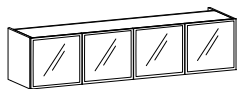

Overhead, Wall Mount, with Frosted Glass Doors

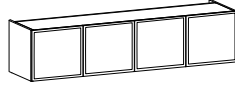

Overhead, Wall Mount, with White Marker Board Doors

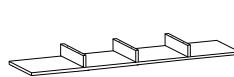

Paper Management (mounts under Overhead; not available on Wall Mount)

WARDROBES & STORAGE CABINETS

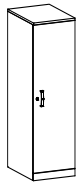

Wardrobe, Standard (1 adjustable shelf)

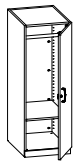

Wardrobe, Compact (1 adjustable shelf)

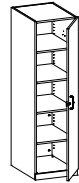

Storage Cabinet, Closed Standard (4 adjustable shelves)



Mirror

TABLES



Conference Table

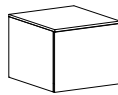

End Table



Round Table, Freestanding



Round Table, X-Base, Freestanding

WORK SURFACES

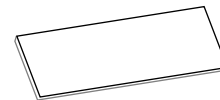

Work Surface, Top (1-1/8" thick)

- Non-handed/reconfigurable
- Field replaceable components
- Matching and contrasting finishes
- Wire/cable management
- Lockable storage components
- Easy access leveling
- 32mm fabrication system assures precision construction and assembly
- Durable, high-pressure laminate
- Freestanding modular components
- Metal hardware & leveling hinges
- Birch plywood drawer construction
- Engineered wood substrate (1-1/8" work surfaces, 5/8" vertical panels and 5/8" tops on freestanding components)
- All file drawers have central locking mechanism
- Adjust power & communications access panels without tools
- Indoor Air Quality Certified to SCSECT10.3-2014 Conforms to the ANSI/BIFMA Furniture Emissions
- Soft-close hinges

Product dimensions shown in approximate inches.

ACCESSORIES & HARDWARE

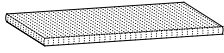

Seat Cushion*(1-1/4" thick)
* Fits Low Credenza Base
page 48

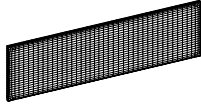

Tackboard
(used on Overheads)
page 49

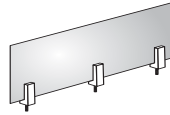

Desktop Acrylic Screen

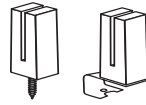

Desktop Screen Support

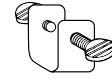

Ganging Bracket

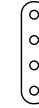

Brace

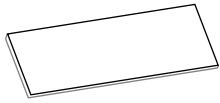

Shelf (extra)

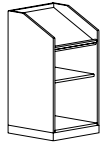

Podium



Magazine Rack

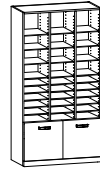

Mail Sorter



LED Task Light
page 53

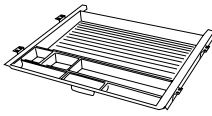

Center Drawer

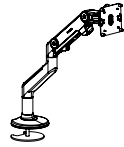

Monitor Arm
(Bolt-Through or Clamp-on
mount)

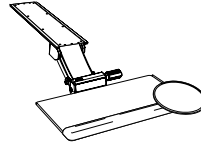

Keyboard and Mouse Pad

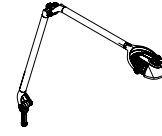

Element Light, 790
series

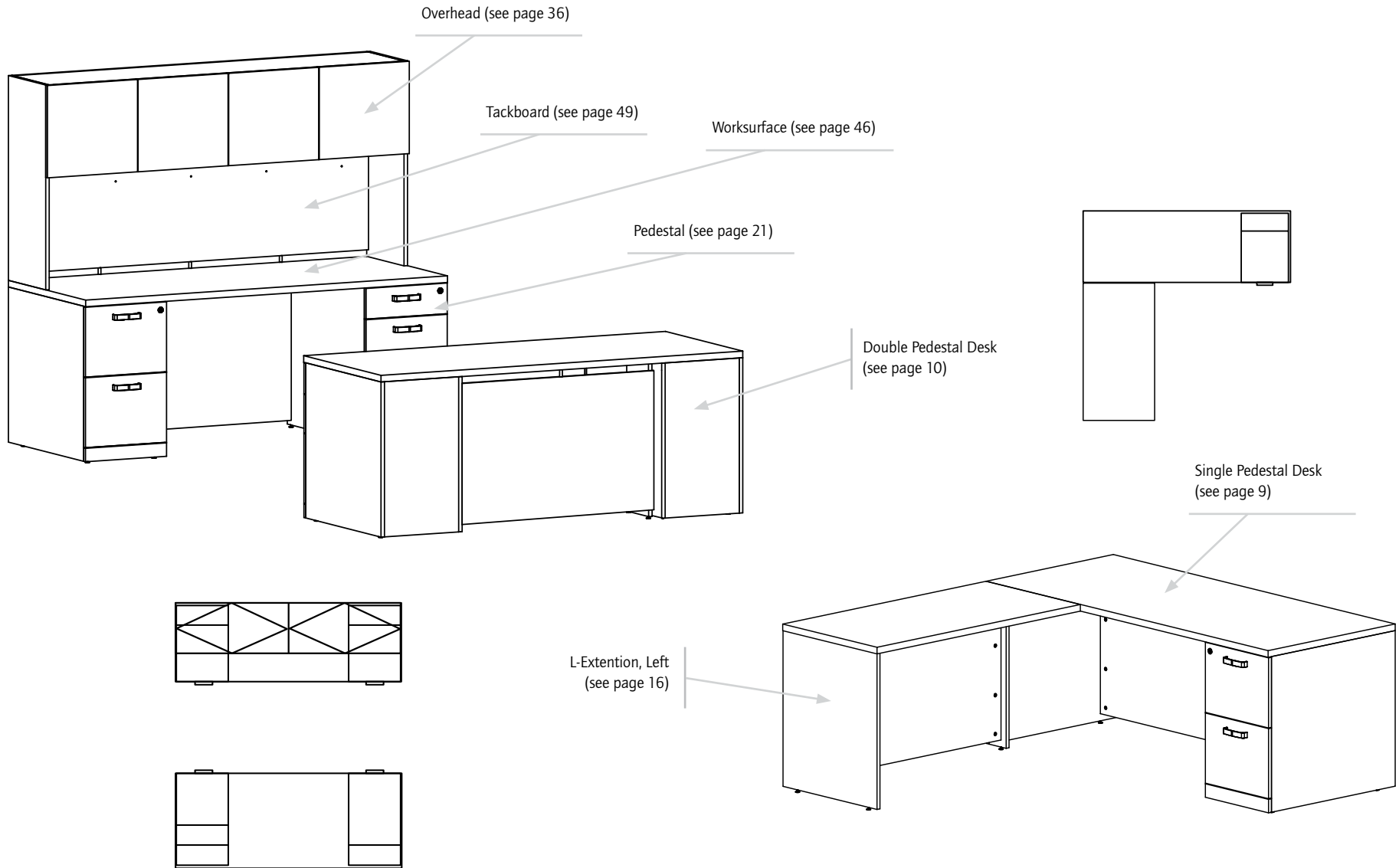

Product dimensions shown in approximate inches. *All components available in matching OFG Harmony Casegoods laminate colors – see page 55 for more information.

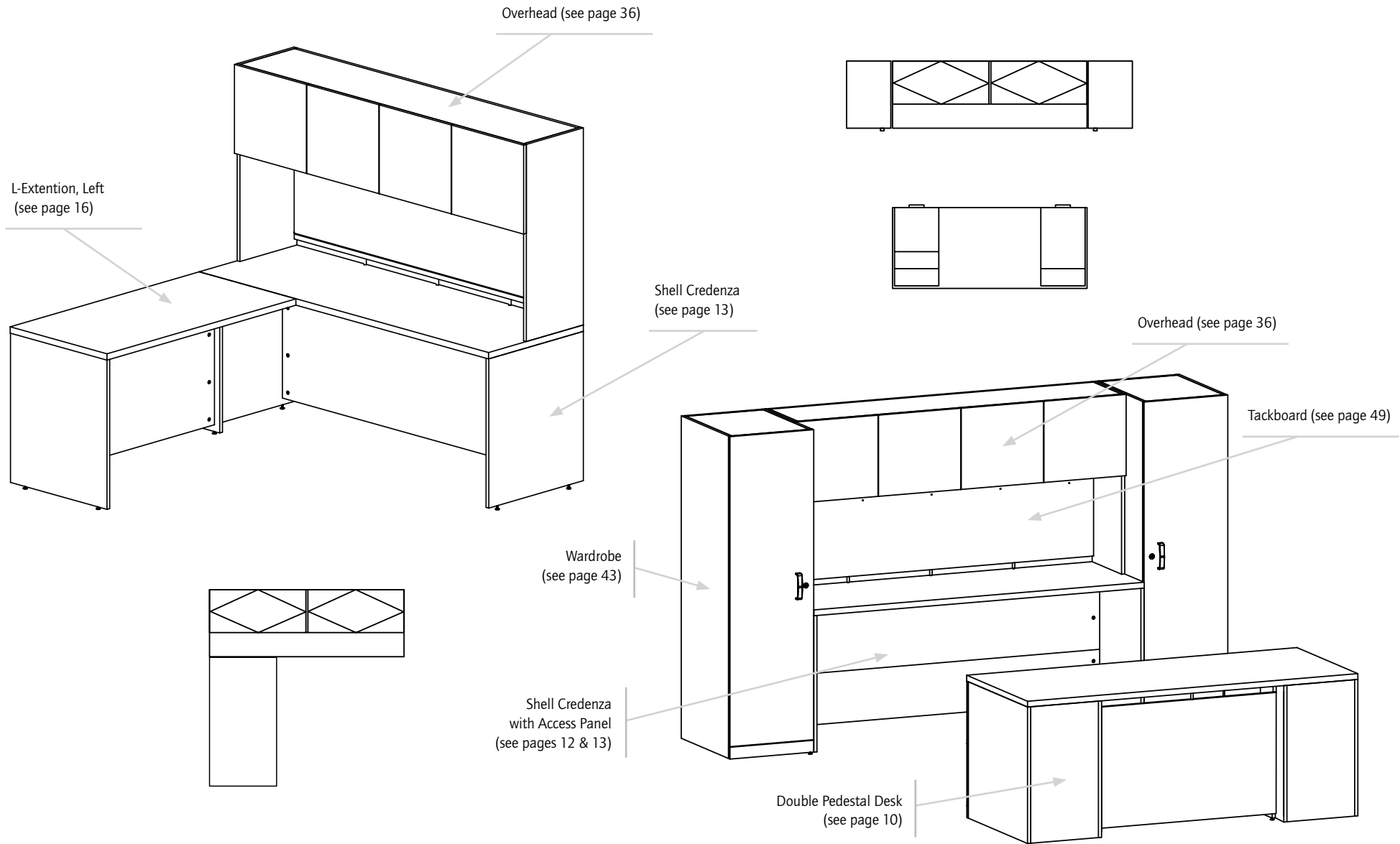

Product dimensions shown in approximate inches. *All components available in matching OFG Harmony Casegoods laminate colors – see page 55 for more information.

INTEGRATE • Desks – Single Pedestal

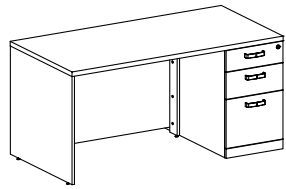

Pencil, Box, File Pedestal on right (R2)

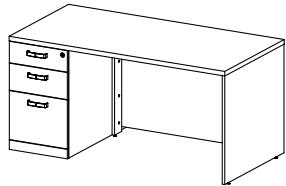

Pencil, Box, File Pedestal on left (L2)

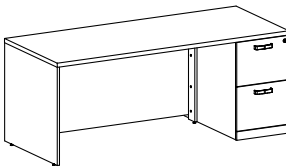

Two File Drawer Pedestal on right (R1)

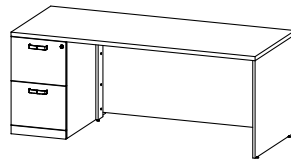

Two File Drawer Pedestal on left (L1)

DESCRIPTION	PRODUCT NUMBER	WIDTH	DEPTH	HEIGHT	SHIP WGT
60" Single Pedestal Desk	I60DKSP (see options below)	60"	30"	29"	220 lbs
66" Single Pedestal Desk	I66DKSP (see options below)	66"	30"	29"	234 lbs
72" Single Pedestal Desk	I72DKSP (see options below)	72"	30"	29"	248 lbs
72" Single Pedestal Desk w/Overhang	I7236DKSP (see options below)	72"	36"	29"	268 lbs

TO ORDER SINGLE PEDESTAL DESK:

Select the product number and then add the codes for the desired position & style of pedestals, hardware pull, laminate base color, top color & top trim color.

For example, to order an Integrate 72" Single Pedestal Desk (I72DKSP), Two File Drawer Pedestal on left (L1), Brushed Nickel Arch Pull (1), Biltmore Cherry Base (BT), Biltmore Cherry Top (BT) and Black Top Trim (AG), specify:

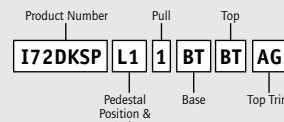

Laminate (Base, Top and Top Trim)

Color	Base/Top	Top Trim
Biltmore Cherry	= BT*	= CD *Wood Ticked
Colombian Walnut	= CI*	= CB Laminates
Kensington Maple	= KE*	= CC match original smooth
Shaker Cherry	= SK*	= CG Laminates on pg. 54 of this Spec Guide and can be specified on Top Work Surface and Base Components.
Studio Teak	= SU*	= CM
Amber Cherry	= AB*	= AB
Sterling Ash	= SA*	= SA
Light Oak	= LO*	= LO
Silver Oak	= SO*	= SO
Buka Bark	= BK*	= BK
Harvest Maple	= HM*	= HM
Rio	= RI*	= RI
Noble Mahogany	= NM	= NM
White Twill	= WT	= WT
Neural Twill	= NT	= NT
Sarum Twill	= ST	= ST
Graphite Twill	= GT	= GT
Earthen Twill	= ET	= ET
Fashion Gray	= RS	= RS
Black	= AG	= AG
Brite White	= FP	= FP

Pedestal

Position

L = Left

R = Right

Style

1 = Two file drawers

2 = Pencil, box, file



Pull

1 = Brushed Nickel Arch

2 = Brushed Nickel Bar

3 = Brushed Nickel Modern

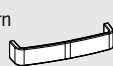

- Non-handed/reconfigurable
- Field replaceable components
- Matching and contrasting finishes
- Wire/cable management
- Lockable storage components
- Easy access leveling
- Nylon-capped leveling guides
- 32mm fabrication system assures precision construction and assembly
- Durable, high-pressure laminate
- Freestanding modular components
- Metal hardware & leveling hinges
- Birch plywood drawer construction
- Engineered wood substrate (1-1/8" work surfaces, 5/8" vertical panels and 5/8" tops on freestanding components)
- Pedestal drawers have central locking mechanism
- Work surface supported by one 52" stiffener bar and one decorative spacer
- Pedestal available in File/File or Pencil/Box/File style
- Modesty is recessed 3" which accommodates clamp mount monitor arm
- 1-1/4" opening of modesty panel (top & bottom) enables wire/cable management

Product dimensions shown in approximate inches. *All components available in matching OFG Harmony Casegoods laminate colors – see page 55 for more information.

INTEGRATE • Desks – Double Pedestal

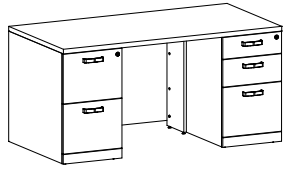

Two File Drawer (left), Pencil, Box, File (right) (L1, R2)

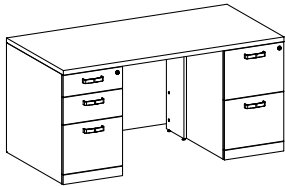

Pencil, Box, File (left), Two File Drawer (right) (L2, R1)

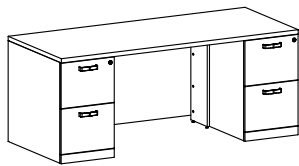

2 - Two File Drawer Pedestals (L1, R1)

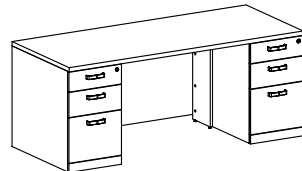

2 - Pencil, Box, File Pedestals (L2, R2)

DESCRIPTION	PRODUCT NUMBER	WIDTH	DEPTH	HEIGHT	SHIP WGT
60" Double Pedestal Desk	I60DKDP (see options below)	60"	30"	29"	281 lbs
66" Double Pedestal Desk	I66DKDP (see options below)	66"	30"	29"	299 lbs
72" Double Pedestal Desk	I72DKDP (see options below)	72"	30"	29"	316 lbs
72" Double Pedestal Desk w/Overhang	I7236DKDP (see options below)	72"	36"	29"	336 lbs

- Non-handed/reconfigurable
- Field replaceable components
- Matching and contrasting finishes
- Wire/cable management
- Lockable storage components
- Easy access leveling
- Nylon-capped leveling guides
- 32mm fabrication system assures precision construction and assembly
- Durable, high-pressure laminate
- Freestanding modular components
- Metal hardware & leveling hinges
- Birch plywood drawer construction
- Engineered wood substrate (1-1/8" work surfaces, 5/8" vertical panels and 5/8" tops on freestanding components)
- Pedestal drawers have central locking mechanism
- Pedestal available in File/File or Pencil/Box/File style
- Work surface supported by one 52" stiffener bar and one decorative spacer
- Modesty is recessed 3" which accommodates clamp mount monitor arm
- 1-1/4" opening of modesty panel (top & bottom) enables wire/cable management

TO ORDER DOUBLE PEDESTAL DESK:

Select the product number and then add the codes for the desired position & style of pedestals, hardware pull, laminate base color, top color & top trim color.

For example, to order an Integrate 60" Double Pedestal Desk (I60DKDP), Two File Drawer Pedestal on left (L1) and Pencil, Box, File Pedestal on right (R2), Brushed Nickel Arch Pull (1), Biltmore Cherry Base (BT), Biltmore Cherry Top (BT) and Black Top Trim (AG), specify:

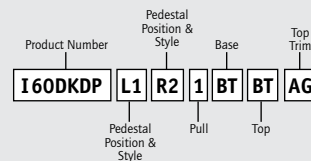

Laminate (Base, Top and Top Trim)

Color	Base/Top	Top Trim
Biltmore Cherry	= BT*	= CD *Wood Ticked
Colombian Walnut	= CI*	= CB Laminates
Kensington Maple	= KE*	= CC match original smooth
Shaker Cherry	= SK*	= CG Laminates on pg. 54 of this Spec Guide and can be specified on Top Work Surface and Base Components.
Studio Teak	= SU*	= CM
Amber Cherry	= AB*	= AB
Sterling Ash	= SA*	= SA
Light Oak	= LO*	= LO
Silver Oak	= SO*	= SO
Buka Bark	= BK*	= BK
Harvest Maple	= HM*	= HM
Rio	= RI*	= RI
Noble Mahogany	= NM	= NM
White Twill	= WT	= WT
Neural Twill	= NT	= NT
Sarum Twill	= ST	= ST
Graphite Twill	= GT	= GT
Earthen Twill	= ET	= ET
Fashion Gray	= RS	= RS
Black	= AG	= AG
Brite White	= FP	= FP

Pedestal

Position

L = Left

R = Right

Style

1 = Two file drawers

2 = Pencil, box, file



Pull

1 = Brushed Nickel Arch

2 = Brushed Nickel Bar

3 = Brushed Nickel Modern



Product dimensions shown in approximate inches. *All components available in matching OFG Harmony Casegoods laminate colors – see page 55 for more information.

INTEGRATE • Desks – Shell Desk

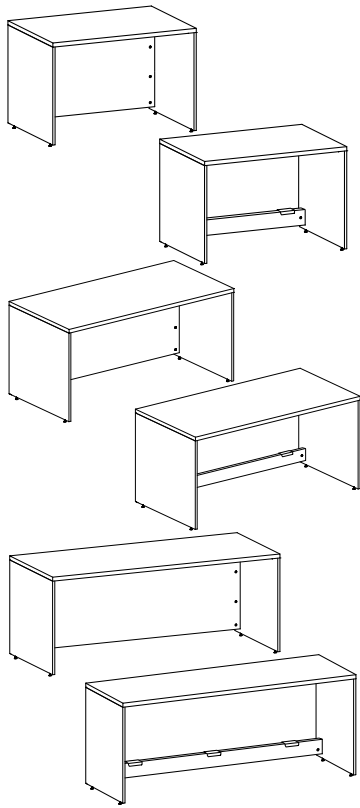

DESCRIPTION	PRODUCT NUMBER	WIDTH	DEPTH	HEIGHT	SHIP WGT
42" Shell Desk w/Full Modesty Panel	I42DKSH (see options below)	42"	30"	29"	140 lbs
42" Shell Desk w/Access Panel ^{KD} (ships unassembled)	IK42DKSHAP (see options below)	42"	30"	29"	160 lbs
60" Shell Desk w/Full Modesty Panel	I60DKSH (see options below)	60"	30"	29"	168 lbs
60" Shell Desk w/Access Panel ^{KD} (ships unassembled)	IK60DKSHAP (see options below)	60"	30"	29"	188 lbs
72" Shell Desk w/Full Modesty Panel	I72DKSH (see options below)	72"	30"	29"	196 lbs
72" Shell Desk w/Access Panel ^{KD} (ships unassembled)	IK72DKSHAP (see options below)	72"	30"	29"	216 lbs

TO ORDER SHELL DESK:

Select the product number and then add the codes for the laminate base color, top color & top trim color.

For example, to order an Integrate 72" Shell Desk w/Full Modesty Panel (I72DKSH), with Biltmore Cherry Base Laminate (BT), Biltmore Cherry Top (BT) and Black Top Trim (AG), specify:

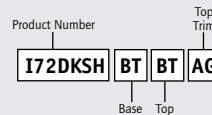

Laminate (Base, Top and Top Trim)

Color	Base/Top	Top Trim	
Biltmore Cherry	= BT*	= CD	*Wood Ticked Laminates
Colombian Walnut	= C1*	= CB	match original smooth
Kensington Maple	= KE*	= CC	Laminates on pg. 54 of this Spec Guide and can be specified on Top Work Surface and Base Components.
Shaker Cherry	= SK*	= CG	
Studio Teak	= SU*	= CM	
Amber Cherry	= AB*	= AB	
Sterling Ash	= SA*	= SA	
Light Oak	= LO*	= LO	
Silver Oak	= SO*	= SO	
Buka Bark	= BK*	= BK	
Harvest Maple	= HM*	= HM	
Rio	= RI*	= RI	
Noble Mahogany	= NM	= NM	
White Twill	= WT	= WT	
Neural Twill	= NT	= NT	
Sarum Twill	= ST	= ST	
Graphite Twill	= GT	= GT	
Earthen Twill	= ET	= ET	See Complete Laminate List on pg. 54.
Fashion Gray	= RS	= RS	
Black	= AG	= AG	
Brite White	= FP	= FP	

Access Panel Specs:

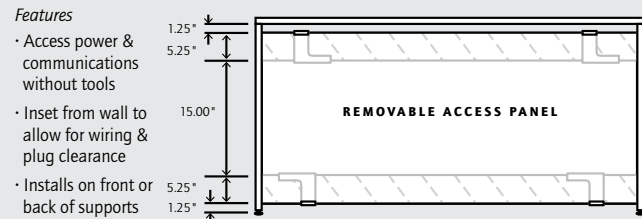

- Field replaceable components
- Matching and contrasting finishes
- Easy access leveling
- Nylon-capped leveling guides
- 32mm fabrication system assures precision construction and assembly
- Durable, high-pressure laminate
- Freestanding modular components
- Metal hardware & leveling hinges
- Engineered wood substrate (1-1/8" work surfaces, 5/8" vertical panels and 5/8" tops on freestanding components)
- Work surface supported by one 52" stiffener bar and one decorative spacer (60", 66" and 72" models)
- Modesty & access panels are recessed 3" which accommodates clamp mount monitor arm
- 1-1/4" opening of full modesty panel (top & bottom) enables wire/cable management
- Adjust power & communications access panels without tools
- Removable access panel is reversible for full access to electrical & communication outlets

NOTE:

^{KD} – Indicates product available KD (knocked-down) – contact your OFG sales representative.

Product dimensions shown in approximate inches. *All components available in matching OFG Harmony Casegoods laminate colors – see page 55 for more information.

INTEGRATE • Credenzas – Shell Credenza

DESCRIPTION	PRODUCT NUMBER	WIDTH	DEPTH	HEIGHT	SHIP WGT
42" Shell Credenza w/Full Modesty Panel	I42CRSH (see options below)	42"	24"	29"	116 lbs
42" Shell Credenza w/Access Panel ^{KD} (ships unassembled)	IK42CRSHAP (see options below)	42"	24"	29"	136 lbs
42" Shell Credenza w/Half Modesty Panel	I42CRHMP (see options below)	42"	24"	29"	110 lbs
60" Shell Credenza w/Full Modesty Panel	I60CRSH (see options below)	60"	24"	29"	140 lbs
60" Shell Credenza w/Access Panel ^{KD} (ships unassembled)	IK60CRSHAP (see options below)	60"	24"	29"	160 lbs
60" Shell Credenza w/Half Modesty Panel	I60CRHMP (see options below)	60"	24"	29"	134 lbs

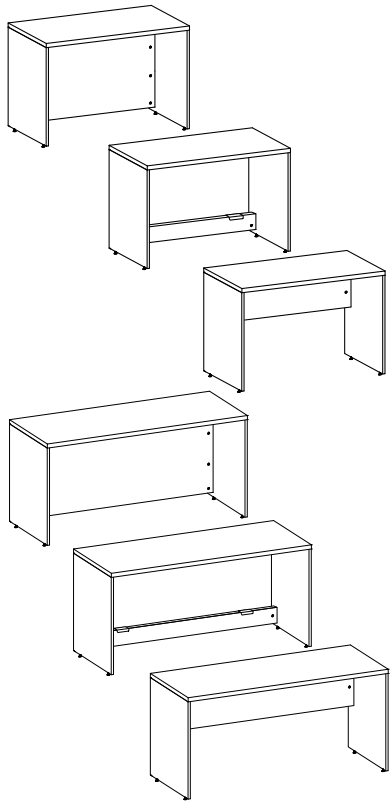

- Field replaceable components
- Matching and contrasting finishes
- Easy access leveling
- Nylon-capped leveling glides
- 32mm fabrication system assures precision construction and assembly
- Durable, high-pressure laminate
- Freestanding modular components
- Metal hardware & leveling hinges
- Engineered wood substrate (1-1/8" work surfaces, 5/8" vertical panels and 5/8" tops on freestanding components)
- Work surface supported by one 52" stiffener bar and one decorative spacer (60", 66" and 72" models)
- Modesty & access panels are recessed 3" which accommodates clamp mount monitor arm
- 1-1/4" opening of full modesty panel (top & bottom) enables wire/cable management
- Adjust power & communications access panels without tools
- Removable access panel is reversible for full access to electrical & communication outlets

TO ORDER SHELL CREDEZA:

Select the product number and then add the codes for the laminate base color, top color & top trim color.

For example, to order an Integrate 60" Shell Credenza w/Full Modesty Panel (I60CRSH), with Biltmore Cherry Base Laminate (BT), Biltmore Cherry Top (BT) and Black Top Trim (AG), specify:

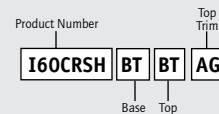

Laminate (Base, Top and Top Trim)

Color	Base/Top	Top Trim
Biltmore Cherry	= BT*	= CD *Wood Ticked Laminates
Colombian Walnut	= CI*	= CB match original smooth
Kensington Maple	= KE*	= CC Laminates on pg. 54 of this Spec Guide and can be specified on Top Work Surface and Base Components.
Shaker Cherry	= SK*	= CG
Studio Teak	= SU*	= CM
Amber Cherry	= AB*	= AB
Sterling Ash	= SA*	= SA
Light Oak	= LO*	= LO
Silver Oak	= SO*	= SO
Buka Bark	= BK*	= BK
Harvest Maple	= HM*	= HM
Rio	= RI*	= RI
Noble Mahogany	= NM	= NM
White Twill	= WT	= WT
Neural Twill	= NT	= NT
Sarum Twill	= ST	= ST
Graphite Twill	= GT	= GT
Earthen Twill	= ET	= ET
Fashion Gray	= RS	= RS
Black	= AG	= AG
Brite White	= FP	= FP

See Complete Laminate List on pg. 54.

Access Panel Specs:

Features

- Access power & communications without tools
- Inset from wall to allow for wiring & plug clearance
- Installs on front or back of supports

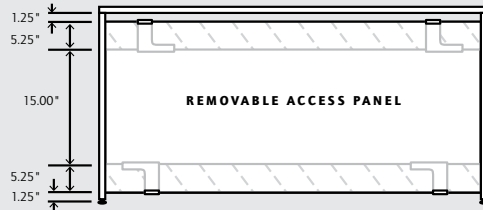

Half Modesty Panel Specs:

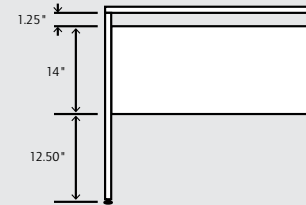

NOTE:

^{KD} – Indicates product available KD (knocked-down) – contact your OFG sales representative

Product dimensions shown in approximate inches. *All components available in matching OFG Harmony Casegoods laminate colors – see page 55 for more information.

INTEGRATE • Credenzas – Shell Credenza

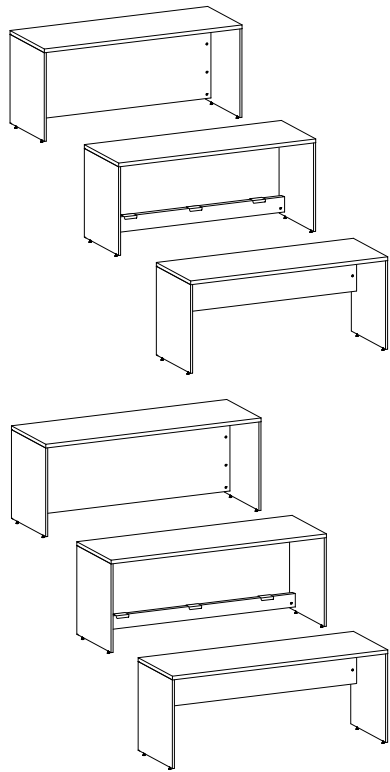

DESCRIPTION	PRODUCT NUMBER	WIDTH	DEPTH	HEIGHT	SHIP WGT
66" Shell Credenza w/Full Modesty Panel	I66CRSH (see options below)	66"	24"	29"	152 lbs
66" Shell Credenza w/Access Panel KD (ships unassembled)	IK66CRSHAP (see options below)	66"	24"	29"	172 lbs
66" Shell Credenza w/Half Modesty Panel	I66CRHMP (see options below)	66"	24"	29"	147 lbs

72" Shell Credenza w/Full Modesty Panel	I72CRSH (see options below)	72"	24"	29"	164 lbs
72" Shell Credenza w/Access Panel KD (ships unassembled)	IK72CRSHAP (see options below)	72"	24"	29"	184 lbs
72" Shell Credenza w/Half Modesty Panel	I72CRHMP (see options below)	72"	24"	29"	145 lbs

TO ORDER SHELL CREDENZA:

Select the product number and then add the codes for the laminate base color, top color & top trim color.

For example, to order an Integrate 66" Shell Credenza w/Full Modesty Panel (I66CRSH), with Biltmore Cherry Base Laminate (BT), Biltmore Cherry Top (BT) and Black Top Trim (AG), specify:

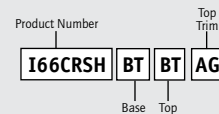

Laminate (Base, Top and Top Trim)

Color	Base/Top	Top Trim	
Biltmore Cherry	= BT*	= CD	*Wood Ticked
Colombian Walnut	= C1*	= CB	Laminates
Kensington Maple	= KE*	= CC	match original
Shaker Cherry	= SK*	= CG	smooth
Studio Teak	= SU*	= CM	Laminates on
Amber Cherry	= AB*	= AB	pg. 54 of this
Sterling Ash	= SA*	= SA	Spec Guide and
Light Oak	= LO*	= LO	can be specified
Silver Oak	= SO*	= SO	on Top Work
Buka Bark	= BK*	= BK	Surface
Harvest Maple	= HM*	= HM	and Base
Rio	= RI*	= RI	Components.
Noble Mahogany	= NM	= NM	
White Twill	= WT	= WT	
Neural Twill	= NT	= NT	
Sarum Twill	= ST	= ST	
Graphite Twill	= GT	= GT	
Earthen Twill	= ET	= ET	See Complete
Fashion Gray	= RS	= RS	Laminate List
Black	= AG	= AG	on pg. 54.
Brite White	= FP	= FP	

Access Panel Specs:

Features

- Access power & communications without tools
- Inset from wall to allow for wiring & plug clearance
- Installs on front or back of supports

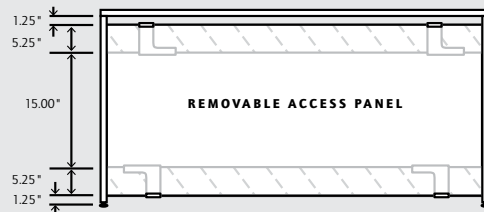

Half Modesty Panel Specs:

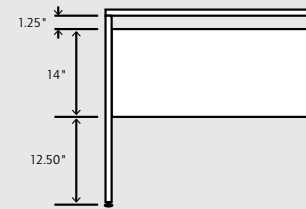

- Field replaceable components
- Matching and contrasting finishes
- Easy access leveling
- Nylon-capped leveling glides
- 32mm fabrication system assures precision construction and assembly
- Durable, high-pressure laminate
- Freestanding modular components
- Metal hardware & leveling hinges
- Engineered wood substrate (1-1/8" work surfaces, 5/8" vertical panels and 5/8" tops on freestanding components)
- Work surface supported by one 52" stiffener bar and one decorative spacer (60", 66" and 72" models)
- Modesty & access panels are recessed 3" which accommodates clamp mount monitor arm
- 1-1/4" opening of full modesty panel (top & bottom) enables wire/cable management
- Adjust power & communications access panels without tools
- Removable access panel is reversible for full access to electrical & communication outlets

NOTE:

KD – Indicates product available KD (knocked-down) – contact your OFG sales representative

Product dimensions shown in approximate inches. *All components available in matching OFG Harmony Casegoods laminate colors – see page 55 for more information.

INTEGRATE • Credenzas – Single Pedestal or 2 Drawer Lateral w/Full Modesty Panel

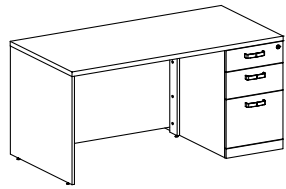

Pencil, Box, File Pedestal on right (R2)

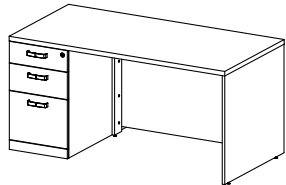

Pencil, Box, File Pedestal on left (L2)

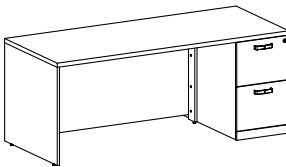

Two File Drawer Pedestal on right (R1)

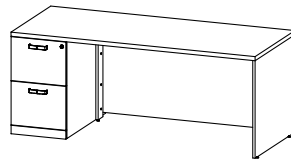

Two File Drawer Pedestal on left (L1)

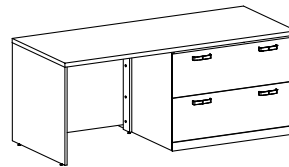

Two Drawer Lateral on right (R3)

DESCRIPTION	PRODUCT NUMBER	WIDTH	DEPTH	HEIGHT	SHIP WGT
60" Single Pedestal Credenza w/Full Modesty Panel	I60CRSP (see options below)	60"	24"	29"	216 lbs
66" Single Pedestal Credenza w/Full Modesty Panel	I66CRSP (see options below)	66"	24"	29"	230 lbs
72" Single Pedestal Credenza w/Full Modesty Panel	I72CRSP (see options below)	72"	24"	29"	244 lbs
72" 2 Drawer Lateral Credenza w/Full Modesty Panel	I72CRLF (see options below)	72"	24"	29"	285 lbs

TO ORDER SINGLE PEDESTAL OR 2 DRAWER LATERAL CREDENZA:

Select the product number and then add the codes for the desired position & style of pedestals, hardware pull, laminate base color, top color & top trim color.

For example, to order an Integrate 72" Single Pedestal Credenza w/Full Modesty Panel (I72CRSP), Two File Drawer Pedestal on left (L1), Brushed Nickel Arch Pull (1), Biltmore Cherry Base (BT), Biltmore Cherry Top (BT) and Black Top Trim (AG), specify:

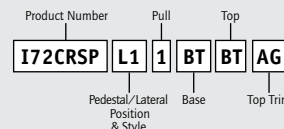

Laminate (Base, Top and Top Trim)

Color	Base/Top	Top Trim	
Biltmore Cherry	= BT*	= CD	*Wood Ticked
Colombian Walnut	= CI*	= CB	Laminates
Kensington Maple	= KE*	= CC	match original
Shaker Cherry	= SK*	= CG	smooth
Studio Teak	= SU*	= CM	Laminates on
Amber Cherry	= AB*	= AB	pg. 54 of this
Sterling Ash	= SA*	= SA	Spec Guide and
Light Oak	= LO*	= LO	can be specified
Silver Oak	= SO*	= SO	on Top Work
Buka Bark	= BK*	= BK	Surface
Harvest Maple	= HM*	= HM	and Base
Rio	= RI*	= RI	Components.
Noble Mahogany	= NM	= NM	
White Twill	= WT	= WT	
Neural Twill	= NT	= NT	
Sarum Twill	= ST	= ST	
Graphite Twill	= GT	= GT	
Earthen Twill	= ET	= ET	See Complete
Fashion Gray	= RS	= RS	Laminate List
Black	= AG	= AG	on pg. 54.
Brite White	= FP	= FP	

Pedestal

Position

L = Left

R = Right

Style

1 = Two file drawers

2 = Pencil, box, file



Lateral

Position

L = Left

R = Right

Style

3 = Two drawer Lateral file



Pull

1 = Brushed Nickel Arch

2 = Brushed Nickel Bar

3 = Brushed Nickel Modern



- Non-handed/reconfigurable
- Field replaceable components
- Matching and contrasting finishes
- Wire/cable management
- Lockable storage components
- Easy access leveling
- Nylon-capped leveling glides
- 32mm fabrication system assures precision construction and assembly
- Durable, high-pressure laminate
- Freestanding modular components
- Metal hardware & leveling hinges
- Birch plywood drawer construction
- Engineered wood substrate (1-1/8" work surfaces, 5/8" vertical panels and 5/8" tops on freestanding components)
- Pedestal drawers have central locking mechanism
- Work surface supported by one 52" stiffener bar and one decorative spacer
- Pedestal available in File/File or Pencil/Box/File style
- Full modesty is recessed 3" which accommodates clamp mount monitor arm
- 1-1/4" opening of full modesty panel (top & bottom) enables wire/cable management

Product dimensions shown in approximate inches. *All components available in matching OFG Harmony Casegoods laminate colors – see page 55 for more information.

INTEGRATE • Credenzas – Single Pedestal w/Half Modesty Panel

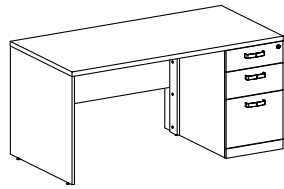

Pencil, Box, File Pedestal on right (R2)

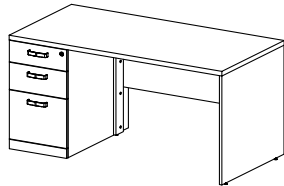

Pencil, Box, File Pedestal on left (L2)

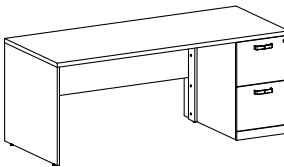

Two File Drawer Pedestal on right (R1)

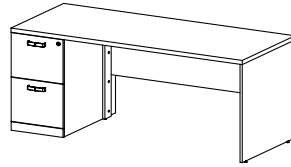

Two File Drawer Pedestal on left (L1)

DESCRIPTION	PRODUCT NUMBER	WIDTH	DEPTH	HEIGHT	SHIP WGT
60" Single Pedestal Credenza w/Half Modesty Panel	I60CRSPHMP (see options below)	60"	24"	29"	210 lbs
66" Single Pedestal Credenza w/Half Modesty Panel	I66CRSPHMP (see options below)	66"	24"	29"	224 lbs
72" Single Pedestal Credenza w/Half Modesty Panel	I72CRSPHMP (see options below)	72"	24"	29"	238 lbs

TO ORDER SINGLE PEDESTAL CREDENZA W/HALF MODESTY PANEL:

Select the product number and then add the codes for the desired position & style of pedestals, hardware pull, laminate base color, top color & top trim color.

For example, to order an Integrate 72" Single Pedestal Credenza w/Half Modesty Panel (I72CRSPHMP), Two File Drawer Pedestal on left (L1), Brushed Nickel Arch Pull (1), Biltmore Cherry Base (BT), Biltmore Cherry Top (BT) and Black Top Trim (AG), specify:

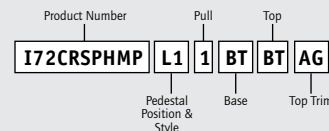

Laminate (Base, Top and Top Trim)

Color	Base/Top	Top Trim	
Biltmore Cherry	= BT*	= CD	*Wood Ticked
Colombian Walnut	= CI*	= CB	Laminates
Kensington Maple	= KE*	= CC	match original
Shaker Cherry	= SK*	= CG	smooth
Studio Teak	= SU*	= CM	Laminates on
Amber Cherry	= AB*	= AB	pg. 54 of this
Sterling Ash	= SA*	= SA	Spec Guide and
Light Oak	= LO*	= LO	can be specified
Silver Oak	= SO*	= SO	on Top Work
Buka Bark	= BK*	= BK	Surface
Harvest Maple	= HM*	= HM	and Base
Rio	= RI*	= RI	Components.
Noble Mahogany	= NM	= NM	
White Twill	= WT	= WT	
Neural Twill	= NT	= NT	
Sarum Twill	= ST	= ST	
Graphite Twill	= GT	= GT	
Earthen Twill	= ET	= ET	See Complete
Fashion Gray	= RS	= RS	Laminate List
Black	= AG	= AG	on pg. 54.
Brite White	= FP	= FP	

Pedestal

Position

L = Left

R = Right

Style

1 = Two file drawers

2 = Pencil, box, file



Pull

1 = Brushed Nickel Arch

2 = Brushed Nickel Bar

3 = Brushed Nickel Modern



Half Modesty Panel Specs:

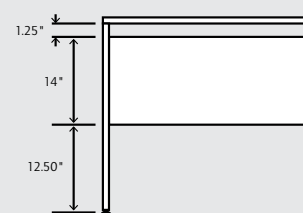

- Non-handed/reconfigurable
- Field replaceable components
- Matching and contrasting finishes
- Wire/cable management
- Lockable storage components
- Easy access leveling
- Nylon-capped leveling glides
- 32mm fabrication system assures precision construction and assembly
- Durable, high-pressure laminate
- Freestanding modular components
- Metal hardware & leveling hinges
- Birch plywood drawer construction
- Engineered wood substrate (1-1/8" work surfaces, 5/8" vertical panels and 5/8" tops on freestanding components)
- Pedestal drawers have central locking mechanism
- Work surface supported by one 52" stiffener bar and one decorative spacer
- Pedestal available in File/File or Pencil/Box/File style
- Half modesty is recessed 3" which accommodates clamp mount monitor arm
- 1-1/4" opening of half modesty panel (top) enables wire/cable management

Product dimensions shown in approximate inches. *All components available in matching OFG Harmony Casegoods laminate colors – see page 55 for more information.

INTEGRATE • L-Unit Extensions w/Full Modesty Panel

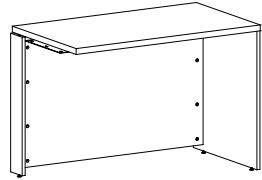

DESCRIPTION	PRODUCT NUMBER	WIDTH	DEPTH	HEIGHT	SHIP WGT
42" L-Unit Extension w/Full Modesty Panel ^{KD} (ships unassembled)	IK42EX (see options below)	42"	24"	29"	133 lbs

*End panel is field adjustable for left or right position.

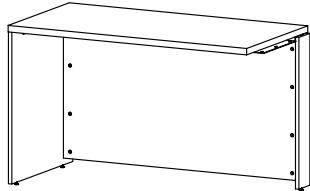

48" L-Unit Extension w/Full Modesty Panel ^{KD} (ships unassembled)	IK48EX (see options below)	48"	24"	29"	137 lbs
---	-------------------------------	-----	-----	-----	---------

*End panel is field adjustable for left or right position.

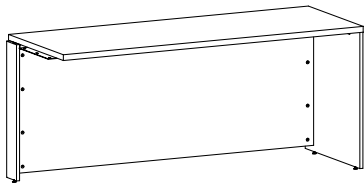

60" L-Unit Extension w/Full Modesty Panel ^{KD} (ships unassembled)	IK60EX (see options below)	60"	24"	29"	151 lbs
---	-------------------------------	-----	-----	-----	---------

*End panel is field adjustable for left or right position.

72" L-Unit Extension w/Full Modesty Panel ^{KD} (ships unassembled)	IK72EX (see options below)	72"	24"	29"	165 lbs
---	-------------------------------	-----	-----	-----	---------

*End panel is field adjustable for left or right position.

TO ORDER L-UNIT EXTENSIONS W/FULL MODESTY PANEL:

Select the product number and then add the codes for the end panel position, laminate base color, top color and top trim color.

For example, to order an Integrate 42" L-Unit Extension w/Full Modesty Panel (IK42EX), with Left End Panel Position (L), Biltmore Cherry Base Laminate (BT), Biltmore Cherry Top (BT) and Black Top Trim (AG), specify:

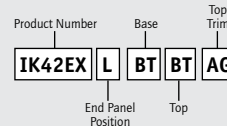

End Panel - Position

L = Left

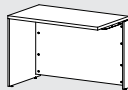

R = Right

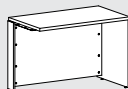

Laminate (Base, Top and Top Trim)

Color	Base/Top	Top Trim	
Biltmore Cherry	= BT*	= CD	*Wood Ticked
Colombian Walnut	= CI*	= CB	Laminates
Kensington Maple	= KE*	= CC	match original
Shaker Cherry	= SK*	= CG	smooth
Studio Teak	= SU*	= CM	Laminates on
Amber Cherry	= AB*	= AB	pg. 54 of this
Sterling Ash	= SA*	= SA	Spec Guide and
Light Oak	= LO*	= LO	can be specified
Silver Oak	= SO*	= SO	on Top Work
Buka Bark	= BK*	= BK	Surface
Harvest Maple	= HM*	= HM	and Base
Rio	= RI*	= RI	Components.
Noble Mahogany	= NM	= NM	
White Twill	= WT	= WT	
Neural Twill	= NT	= NT	
Sarum Twill	= ST	= ST	
Graphite Twill	= GT	= GT	
Earthen Twill	= ET	= ET	See Complete
Fashion Gray	= RS	= RS	Laminate List
Black	= AG	= AG	on pg. 54.
Brite White	= FP	= FP	

- Non-handed/reconfigurable
- Field replaceable components
- Matching and contrasting finishes
- Easy access leveling
- Nylon-capped leveling glides
- 32mm fabrication system assures precision construction and assembly
- Durable, high-pressure laminate
- Freestanding modular components
- Metal hardware & leveling hinges
- Engineered wood substrate (1-1/8" work surfaces, 5/8" vertical panels and 5/8" tops on freestanding components)
- Mounting screws provided for splice plate
- Field adjustable end panel position (left or right)
- Full modesty panel is recessed 3" which accommodates clamp mount monitor arm
- 1-1/4" opening of full modesty panel (top & bottom) enables wire/cable management
- Work surface supported by one 52" stiffener bar and one decorative spacer
- Indoor Air Quality Certified to SCSEC10.3-2014 Conforms to the ANSI/BIFMA Furniture Emissions Standard

NOTE:

L-Unit Extension ships KD (knocked-down)
^{KD} – Indicates product available KD (knock-down)

Product dimensions shown in approximate inches. *All components available in matching OFG Harmony Casegoods laminate colors – see page 55 for more information.

INTEGRATE • L-Unit Extensions w/Full Modesty Panel & Pedestal

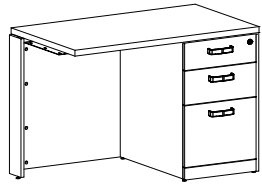

DESCRIPTION	PRODUCT NUMBER	WIDTH	DEPTH	HEIGHT	SHIP WGT
42" L-Unit Extension w/Full Modesty Panel & Pedestal	IK42EXPD (see options below)	42"	24"	29"	241 lbs

*End panel is field adjustable for left or right position.

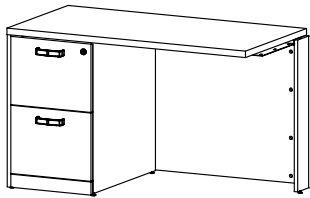

48" L-Unit Extension w/Full Modesty Panel & Pedestal	IK48EXPD (see options below)	48"	24"	29"	245 lbs
---	---------------------------------	-----	-----	-----	---------

*End panel is field adjustable for left or right position.

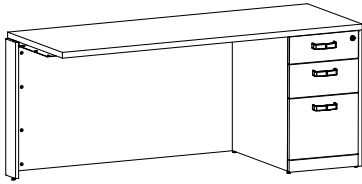

72" L-Unit Extension w/Full Modesty Panel & Pedestal	IK72EXPD (see options below)	72"	24"	29"	352 lbs
---	---------------------------------	-----	-----	-----	---------

*End panel is field adjustable for left or right position.

TO ORDER: L-UNIT EXTENSIONS W/FULL MODESTY PANEL & PEDESTAL

Select the product number and then add the codes for the desired position & style of pedestals, hardware pull, laminate base color, top color & trim color.

For example, to order an Integrate 42" L-Unit Extension w/Full Modesty Panel (IK42EXPD), with Right End Panel Position (R), Pencil, Box, File Pedestal on right (R2), Brushed Nickel Arch Pull (1), Biltmore Cherry Base (BT), Biltmore Cherry Top (BT) and Black Trim (AG), specify:

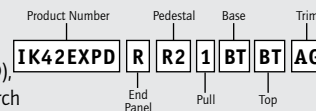

End Panel - Position

L = Left

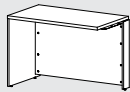

R = Right

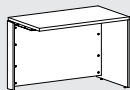

Pedestal

Position

L = Left

R = Right

Style

1 = Two file drawers

2 = Pencil, box, file



Pull

1 = Brushed Nickel Arch

2 = Brushed Nickel Bar

3 = Brushed Nickel Modern



Laminate (Base, Top and Top Trim)

Color	Base/Top	Top Trim
Biltmore Cherry	= BT*	= CD
Colombian Walnut	= C1*	= CB
Kensington Maple	= KE*	= CC
Shaker Cherry	= SK*	= CG
Studio Teak	= SU*	= CM
Amber Cherry	= AB*	= AB
Sterling Ash	= SA*	= SA
Light Oak	= LO*	= LO
Silver Oak	= SO*	= SO
Buka Bark	= BK*	= BK
Harvest Maple	= HM*	= HM
Rio	= RI*	= RI
Noble Mahogany	= NM	= NM
White Twill	= WT	= WT
Neural Twill	= NT	= NT
Sarum Twill	= ST	= ST
Graphite Twill	= GT	= GT
Earthen Twill	= ET	= ET
Fashion Gray	= RS	= RS
Black	= AG	= AG
Brite White	= FP	= FP

*Wood Ticked Laminates match original smooth Laminates on pg. 54 of this Spec Guide and can be specified on Top Work Surface and Base Components.

See Complete Laminate List on pg. 54.

- Non-handed/reconfigurable
- Field replaceable components
- Matching and contrasting finishes
- Easy access leveling
- Nylon-capped leveling glides
- 32mm fabrication system assures precision construction and assembly
- Durable, high-pressure laminate
- Freestanding modular components
- Metal hardware & leveling hinges
- Birch plywood drawer construction
- Engineered wood substrate (1-1/8" work surfaces, 5/8" vertical panels and 5/8" tops on freestanding components)
- Mounting screws provided for splice plate
- Field adjustable end panel position (left or right)
- Full modesty panel is recessed 3" which accommodates clamp mount monitor arm
- 1-1/4" opening of full modesty panel (top & bottom) enables wire/cable management
- Work surface supported by one 52" stiffener bar and one decorative spacer
- Indoor Air Quality Certified to SCSEC10.3-2014 Conforms to the ANSI/BIFMA Furniture Emissions Standard

Product dimensions shown in approximate inches. *All components available in matching OFG Harmony Casegoods laminate colors – see page 55 for more information.

INTEGRATE • L-Unit Extensions w/Half or Support Modesty Panel

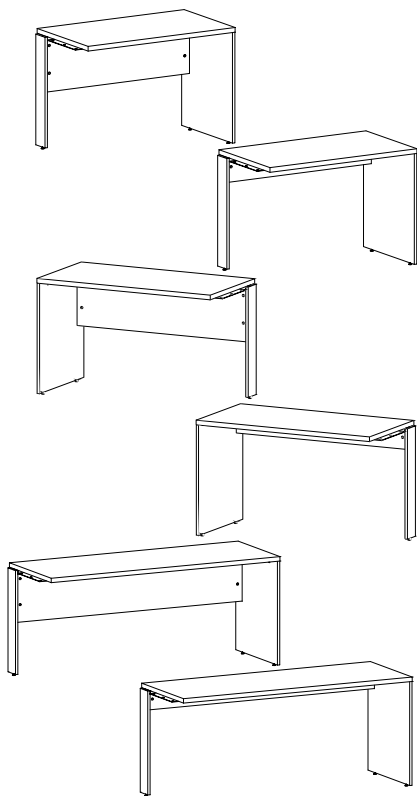

DESCRIPTION	PRODUCT NUMBER	WIDTH	DEPTH	HEIGHT	SHIP WGT
42" L-Unit Extension w/Half Modesty Panel ^{KD} (ships unassembled)	IK42EXHMP (see options below)	42"	24"	29"	112 lbs
42" L-Unit Extension w/Support Modesty Panel ^{KD} (ships unassembled)	IK42EXPSM (see options below)	42"	24"	29"	112 lbs
48" L-Unit Extension w/Half Modesty Panel ^{KD} (ships unassembled)	IK48EXHMP (see options below)	48"	24"	29"	111 lbs
48" L-Unit Extension w/Support Modesty Panel ^{KD} (ships unassembled)	IK48EXPSM (see options below)	48"	24"	29"	111 lbs
72" L-Unit Extension w/Half Modesty Panel ^{KD} (ships unassembled)	IK72EXHMP (see options below)	72"	24"	29"	140 lbs
72" L-Unit Extension w/Support Modesty Panel ^{KD} (ships unassembled)	IK72EXPSM (see options below)	72"	24"	29"	140 lbs

TO ORDER L-UNIT EXTENSIONS W/HALF OR SUPPORT MODESTY PANEL:

Select the product number and then add the codes for the end panel position, laminate base color, top color and top trim color.

For example, to order an Integrate 42" L-Unit Extension w/Half Modesty Panel (IK42EXHMP), with Left End Panel Position (L), Biltmore Cherry Base Laminate (BT), Biltmore Cherry Top (BT) and Black Top Trim (AG), specify:

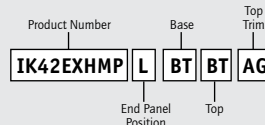

Laminate (Base, Top and Top Trim)

Color	Base/Top	Top Trim
Biltmore Cherry	= BT*	= CD
Colombian Walnut	= CI*	= CB
Kensington Maple	= KE*	= CC
Shaker Cherry	= SK*	= CG
Studio Teak	= SU*	= CM
Amber Cherry	= AB*	= AB
Sterling Ash	= SA*	= SA
Light Oak	= LO*	= LO
Silver Oak	= SO*	= SO
Buka Bark	= BK*	= BK
Harvest Maple	= HM*	= HM
Rio	= RI*	= RI
Noble Mahogany	= NM	= NM
White Twill	= WT	= WT
Neural Twill	= NT	= NT
Sarum Twill	= ST	= ST
Graphite Twill	= GT	= GT
Earthen Twill	= ET	= ET
Fashion Gray	= RS	= RS
Black	= AG	= AG
Brite White	= FP	= FP

**Wood Ticked Laminates match original smooth Laminates on pg. 54 of this Spec. Guide and can be specified on Top Work Surface and Base Components.*

See Complete Laminate List on pg. 54.

End Panel - Position

L = Left

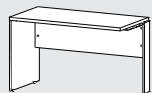

R = Right

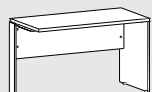

Half Modesty Panel Specs:

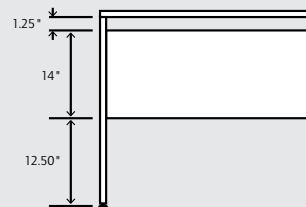

Support Modesty Panel Specs:

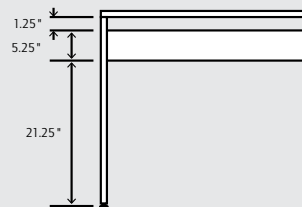

- Non-handed/reconfigurable
- Field replaceable components
- Matching and contrasting finishes
- Easy access leveling
- Nylon-capped leveling glides
- 32mm fabrication system assures precision construction and assembly
- Durable, high-pressure laminate
- Freestanding modular components
- Metal hardware & leveling hinges
- Engineered wood substrate (1-1/8" work surfaces, 5/8" vertical panels and 5/8" tops on freestanding components)
- Mounting screws provided for splice plate
- Modesty panels are recessed 3" which accommodates clamp mount monitor arm
- 1-1/4" opening of half modesty panel (top) enables wire/cable management
- Work surface supported by one 52" stiffener bar and one decorative spacer
- Indoor Air Quality Certified to SCSEC10.3-2014 Conforms to the ANSI/BIFMA Furniture Emissions Standard

NOTE:

L-Unit Extension ships KD (knocked-down)
^{KD} – Indicates product available KD (knock-down)

Product dimensions shown in approximate inches. *All components available in matching OFG Harmony Casegoods laminate colors – see page 55 for more information.

INTEGRATE • U-Unit Bridges

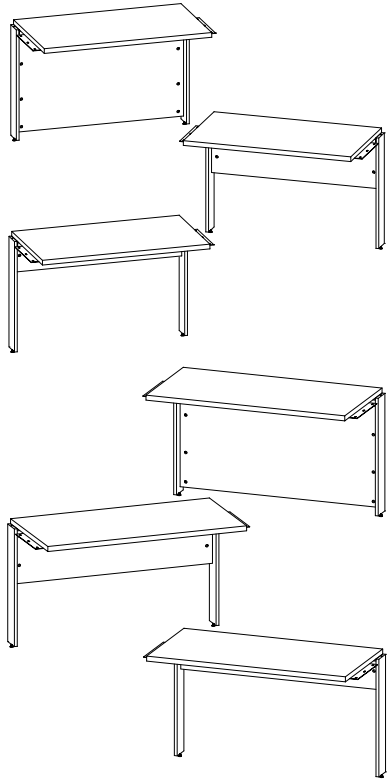

DESCRIPTION	PRODUCT NUMBER	WIDTH	DEPTH	HEIGHT	SHIP WGT
42" U-Unit Bridge w/Full Modesty Panel KD (ships unassembled)	IK42BR (see options below)	42"	24"	29"	112 lbs
42" U-Unit Bridge w/Half Modesty Panel KD (ships unassembled)	IK42BRHMP (see options below)	42"	24"	29"	105 lbs
42" U-Unit Bridge w/Support Modesty Panel KD (ships unassembled)	IK42BRPSM (see options below)	42"	24"	29"	105 lbs
48" U-Unit Bridge w/Full Modesty Panel KD (ships unassembled)	IK48BR (see options below)	48"	24"	29"	116 lbs
48" U-Unit Bridge w/Half Modesty Panel KD (ships unassembled)	IK48BRHMP (see options below)	48"	24"	29"	109 lbs
48" U-Unit Bridge w/Support Modesty Panel KD (ships unassembled)	IK48BRPSM (see options below)	48"	24"	29"	109 lbs

TO ORDER U-UNIT BRIDGE:

Select the product number and then add the codes for the laminate base color, top color & top trim color.

For example, to order an Integrate 48" U-Unit Bridge w/Full Modesty Panel (IK48BR), with Biltmore Cherry Base Laminate (BT), Biltmore Cherry Top (BT) and Black Top Trim (AG), specify:

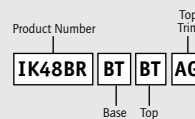

Laminate (Base, Top and Top Trim)

Color	Base/Top	Top Trim	
Biltmore Cherry	= BT*	= CD	*Wood Ticked Laminates match original smooth
Colombian Walnut	= CI*	= CB	Laminates on pg. 54 of this Spec. Guide and can be specified on Top Work Surface and Base Components.
Kensington Maple	= KE*	= CC	
Shaker Cherry	= SK*	= CG	
Studio Teak	= SU*	= CM	
Amber Cherry	= AB*	= AB	
Sterling Ash	= SA*	= SA	
Light Oak	= LO*	= LO	
Silver Oak	= SO*	= SO	
Buka Bark	= BK*	= BK	
Harvest Maple	= HM*	= HM	
Rio	= RI*	= RI	
Noble Mahogany	= NM	= NM	
White Twill	= WT	= WT	
Neural Twill	= NT	= NT	
Sarum Twill	= ST	= ST	
Graphite Twill	= GT	= GT	
Earthen Twill	= ET	= ET	See Complete Laminate List on pg. 54.
Fashion Gray	= RS	= RS	
Black	= AG	= AG	
Brite White	= FP	= FP	

Half Modesty Panel Specs:

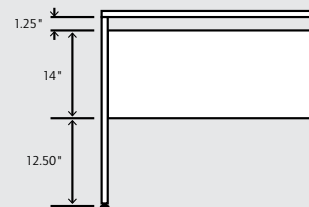

Support Modesty Panel Specs:

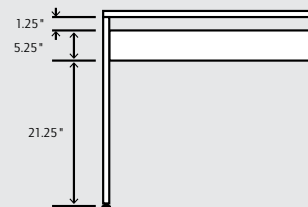

- Field replaceable components
- Matching and contrasting finishes
- Easy access leveling
- Nylon-capped leveling glides
- 32mm fabrication system assures precision construction and assembly
- Durable, high-pressure laminate
- Freestanding modular components
- Metal hardware & leveling hinges
- Engineered wood substrate (1-1/8" work surfaces, 5/8" vertical panels and 5/8" tops on freestanding components)
- Mounting screws provided for splice plates
- Field adjustable end panel position (left or right)
- Modesty panels are recessed 3" which accommodates clamp mount monitor arm
- 1-1/4" opening of full modesty panel (top & bottom) enables wire/cable management
- Work surface supported by one 52" stiffener bar and one decorative spacer
- Indoor Air Quality Certified to SCSEC10.3-2014 Conforms to the ANSI/BIFMA Furniture Emissions Standard

NOTE:

U-Unit Bridge ships KD (knocked-down)
KD – Indicates product available KD (knock-down)

Product dimensions shown in approximate inches. *All components available in matching OFG Harmony Casegoods laminate colors – see page 55 for more information.

INTEGRATE • Reception Center

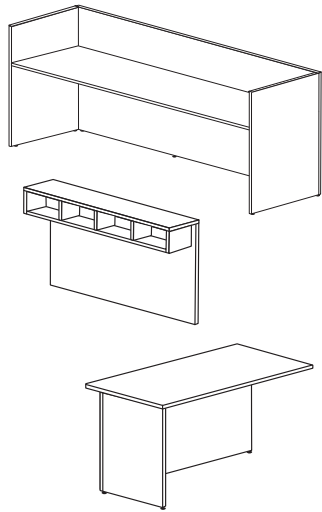

DESCRIPTION	PRODUCT NUMBER	WIDTH	DEPTH	HEIGHT	SHIP WGT
96" Reception Center – Desk* KD (freestanding desk – ships unassembled)	IK9630REC	96"	30"	43"	419 lbs
48" Reception Center – Transaction Counter* KD (waterfall approach for Desk; paper management on user side; slides right/left to position anywhere along Desk front – ships unassembled)	I48TR	48"	12"	29"	210 lbs
48" Reception Center – Return* KD (includes 6" overhang on top, approach side; attaches to left or right side of Desk – ships unassembled)	IK48HCR	48"	36"	29"	145 lbs

*Order individual pieces to configure Reception Center as desired.

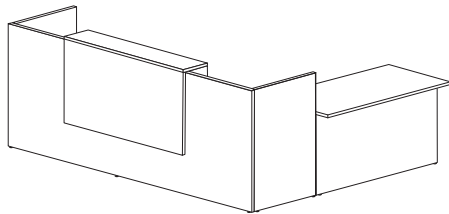

Reception Center (approach view)
configured with Transaction Counter & Return

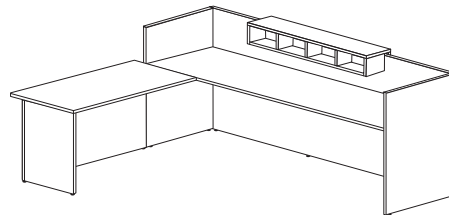

Reception Center (user view)
configured with Transaction Counter & Return

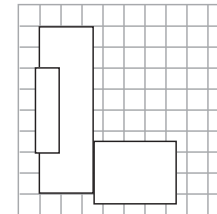

Reception Center footprint
(grid block = 12")

- Transaction Counter slides right/left to position anywhere along Desk front
- Non-handed/reconfigurable
- Field replaceable components
- Matching and contrasting finishes
- Easy access leveling
- Nylon-capped leveling glides
- 32mm fabrication system assures precision construction and assembly
- Durable, high-pressure laminate
- Freestanding modular components
- Metal hardware & leveling hinges
- Engineered wood substrate (1-1/8" work surfaces, 5/8" vertical panels and 5/8" tops on freestanding components)
- Work surface supported by one 52" stiffener bar
- Indoor Air Quality Certified to SCSEC10.3-2014 Conforms to the ANSI/BIFMA Furniture Emissions Standard

TO ORDER RECEPTION CENTER DESK:

Select the product number and then add the codes for the desired laminate base color, top color & trim color.

For example, to order an Integrate 96" Reception Center Desk (IK9630REC), in Biltmore Cherry Base (BT), Biltmore Cherry Top (BT) and Black Trim (AG), specify:

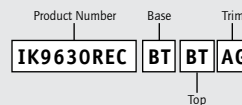

TO ORDER RECEPTION CENTER TRANSACTION COUNTER:

Select the product number and then add the codes for the desired laminate base color, top color & trim color.

For example, to order an Integrate 48" Reception Transaction Counter (I48TR), in Biltmore Cherry Base (BT), Biltmore Cherry Top (BT) and Black Trim (AG), specify:

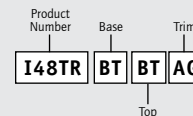

Laminate (Base, Top and Top Trim)

Color	Base/Top	Top Trim	
Biltmore Cherry	= BT*	= CD	*Wood Ticked Laminates match original smooth Laminates on pg. 54 of this Spec Guide and can be specified on Top Work Surface and Base Components.
Colombian Walnut	= CI*	= CB	
Kensington Maple	= KE*	= CC	
Shaker Cherry	= SK*	= CG	
Studio Teak	= SU*	= CM	
Amber Cherry	= AB*	= AB	
Sterling Ash	= SA*	= SA	
Light Oak	= LO*	= LO	
Silver Oak	= SO*	= SO	
Buka Bark	= BK*	= BK	
Harvest Maple	= HM*	= HM	See Complete Laminate List on pg. 54.
Rio	= RI*	= RI	
Noble Mahogany	= NM	= NM	
White Twill	= WT	= WT	
Neural Twill	= NT	= NT	
Sarum Twill	= ST	= ST	
Graphite Twill	= GT	= GT	
Earthen Twill	= ET	= ET	
Fashion Gray	= RS	= RS	
Black	= AG	= AG	
Brite White	= FP	= FP	

NOTE:

- KD – Indicates product available KD (knock-down)
- WSS – Work Surface Supporting (without top)

Product dimensions shown in approximate inches. *All components available in matching OFG Harmony Casegoods laminate colors – see page 55 for more information.

INTEGRATE • Pedestals

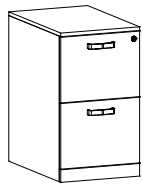

Two File Drawer Pedestal

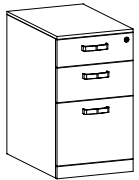

Pencil, Box, File Pedestal

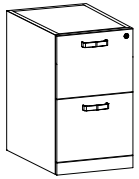

Two File Drawer Pedestal, WSS (without top)

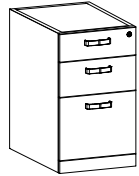

Pencil, Box, File Pedestal, WSS (without top)

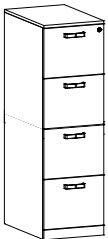

Vertical File, 4 Drawers

DESCRIPTION	PRODUCT NUMBER	WIDTH	DEPTH	HEIGHT	SHIP WGT
Pedestal, Freestanding* (with top)	I16PDF (see options below)	16"	24"	28.5"	108 lbs
Pedestal – Mobile, Freestanding* (with top – fits under 24" deep Credenza) Metal with laminate faces; includes 2 locking casters	I16PDFM (see options below)	15"	17.75"	27.5"	108 lbs
Pedestal, WSS (without top)	I16PDW (see options below)	16"	24"	28"	108 lbs
Pedestal, WSS (without top)	I18PDW (see options below)	18"	24"	28"	116 lbs
Pedestal, WSS (without top – fit under 24" deep Credenza)	I16PDD (see options below)	16"	19.5"	28"	100 lbs

*All Freestanding products have 5/8" tops.

INTEGRATE • Vertical File

DESCRIPTION	PRODUCT NUMBER	WIDTH	DEPTH	HEIGHT	SHIP WGT
Vertical File, 4 Drawers, Freestanding* (with top)	I4VFS (see options below)	16"	24"	54"	238 lbs

*All Freestanding products have 5/8" tops.

TO ORDER PEDESTAL & VERTICAL FILE:

Select the product number and then add the codes for the desired style of pedestal, hardware pull, laminate base color, top color & top trim color.

For example, to order an Integrate Pedestal, Freestanding (I16PDF), in Pencil, Box, File Style (2), with Brushed Nickel Arch Pull (1), Biltmore Cherry Base (BT), Biltmore Cherry Top (BT) and Black Top Trim (AG), specify:

For example, to order an Integrate Pedestal, Freestanding - Mobile, to fit under Credenza (I16PDFM), in Pencil, Box, File Style (2), with Brushed Nickel Arch Pull (1), standard Starlight Silver Metal Base (34), Biltmore Cherry Face & Trim (BT), specify:

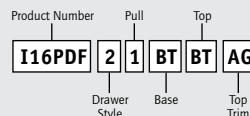

NOTE: Top Laminate & Top Trim Options do not apply to WSS Model.

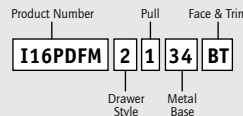

Laminate (Base, Top and Top Trim)

Color	Base/Top	Top Trim	
Biltmore Cherry	= BT*	= CD	*Wood Ticked
Colombian Walnut	= CI*	= CB	Laminates
Kensington Maple	= KE*	= CC	match original
Shaker Cherry	= SK*	= CG	smooth
Studio Teak	= SU*	= CM	Laminates on
Amber Cherry	= AB*	= AB	pg. 54 of this
Sterling Ash	= SA*	= SA	Spec Guide and
Light Oak	= LO*	= LO	can be specified
Silver Oak	= SO*	= SO	on Top Work
Buka Bark	= BK*	= BK	Surface
Harvest Maple	= HM*	= HM	and Base
Rio	= RI*	= RI	Components.
Noble Mahogany	= NM	= NM	
White Twill	= WT	= WT	
Neural Twill	= NT	= NT	
Sarum Twill	= ST	= ST	
Graphite Twill	= GT	= GT	
Earthen Twill	= ET	= ET	See Complete
Fashion Gray	= RS	= RS	Laminate List
Black	= AG	= AG	on pg. 54.
Brite White	= FP	= FP	

Pedestal Style

1 = Two file drawers



2 = Pencil, box, file



Pull

1 = Brushed Nickel Arch



2 = Brushed Nickel Bar



3 = Brushed Nickel Modern



- Field replaceable components
- Matching and contrasting finishes
- Easy access leveling
- Nylon-capped leveling glides
- 32mm fabrication system assures precision construction and assembly
- Durable, high-pressure laminate
- Freestanding modular components
- Metal hardware & leveling hinges
- Birch plywood drawer construction
- Engineered wood substrate (1-1/8" work surfaces, 5/8" vertical panels and 5/8" tops on freestanding components)
- Pedestal drawers have central locking mechanism
- Pedestal available in File/File or Pencil/Box/File style
- Indoor Air Quality Certified to SCSEC10.3-2014 Conforms to the ANSI/BIFMA Furniture Emissions Standard

NOTE:

WSS – Work Surface Supporting (without finish top)

All Freestanding products have 5/8" tops.

Product dimensions shown in approximate inches. *All components available in matching OFG Harmony Casegoods laminate colors – see page 55 for more information.

INTEGRATE • Credenza Bases, Closed

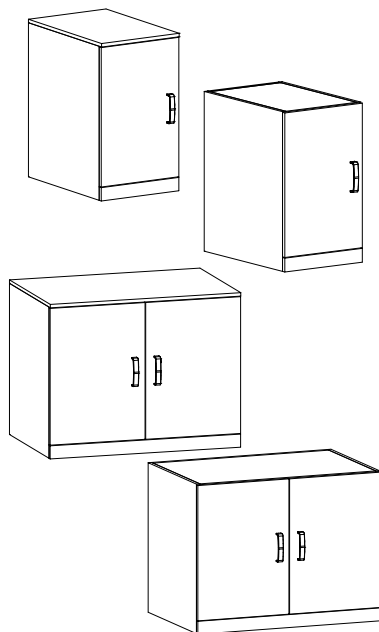

DESCRIPTION	PRODUCT NUMBER	WIDTH	DEPTH	HEIGHT	SHIP WGT
Credenza Base, Closed Freestanding* (with top – ships with 1 shelf)	I16CBCS (see options below)	16"	24"	28.5"	92 lbs
Credenza Base, Closed, WSS (without top – ships with 1 shelf)	I16CBCW (see options below)	16"	24"	28"	92 lbs
Credenza Base, Closed Freestanding* (with top – ships with 1 shelf)	I36CBCS (see options below)	36"	24"	28.5"	144 lbs
Credenza Base, Closed, WSS (without top – ships with 1 shelf)	I36CBCW (see options below)	36"	24"	28"	144 lbs
*All Freestanding products have 5/8" tops.					
Shelf (for 16" wide Credenza Base, includes 4 hanging clips) each	I16SHELF (see options below)	14.5"	22.5"		6 lbs
Shelf (for 36" wide Credenza Base, includes 4 hanging clips) each	I36SHELF (see options below)	34.5"	22.5"		10 lbs

- Non-handed/reconfigurable
- Field replaceable components
- Matching and contrasting finishes
- Easy access leveling
- Nylon leveling glides
- 32mm fabrication system assures precision construction and assembly
- Durable, high-pressure laminate
- Freestanding modular components
- Metal hardware & leveling hinges
- Engineered wood substrate (1-1/8" work surfaces, 5/8" vertical panels and 5/8" tops on freestanding components)
- Indoor Air Quality Certified to SCSEC10.3-2014 Conforms to the ANSI/BIFMA Furniture Emissions Standard
- Soft-close hinges

TO ORDER CREDENZA BASE, CLOSED FREESTANDING (single door):

Select the product number and then add the codes for the desired door position & style of hardware pull, laminate base color, top color & top trim color.

For example, to order an Integrate Credenza Base, Closed 16" wide, Freestanding (I16CBCS), with single Door Hang on Left (L), Brushed Nickel Arch Pull (1), Biltmore Cherry Base (BT), Biltmore Cherry Top (BT) and Black Top Trim (AG), specify:

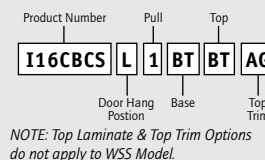

Laminate (Base, Top and Top Trim)

Color	Base/Top	Top Trim	
Biltmore Cherry	= BT*	= CD	*Wood Ticked
Colombian Walnut	= CI*	= CB	Laminates
Kensington Maple	= KE*	= CC	match original
Shaker Cherry	= SK*	= CG	smooth
Studio Teak	= SU*	= CM	Laminates on
Amber Cherry	= AB*	= AB	pg. 54 of this
Sterling Ash	= SA*	= SA	Spec Guide and
Light Oak	= LO*	= LO	can be specified
Silver Oak	= SO*	= SO	on Top Work
Buka Bark	= BK*	= BK	Surface
Harvest Maple	= HM*	= HM	and Base
Rio	= RI*	= RI	Components.
Noble Mahogany	= NM	= NM	
White Twill	= WT	= WT	
Neural Twill	= NT	= NT	
Sarum Twill	= ST	= ST	
Graphite Twill	= GT	= GT	
Earthen Twill	= ET	= ET	See Complete
Fashion Gray	= RS	= RS	Laminate List
Black	= AG	= AG	on pg. 54.
Brite White	= FP	= FP	

Door Hang

Position

L = Left

R = Right

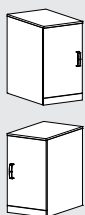

Pull

- 1 = Brushed Nickel Arch
- 2 = Brushed Nickel Bar
- 3 = Brushed Nickel Modern

TO ORDER CREDENZA BASE, CLOSED STAND-ALONE (double door):

Using same options as above, specify:

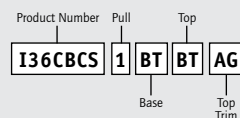

TO ORDER EXTRA SHELF (for double door):

Using same options as above, specify:

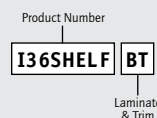

Product dimensions shown in approximate inches. *All components available in matching OFG Harmony Casegoods laminate colors – see page 55 for more information.

INTEGRATE • Credenza Bases, Open

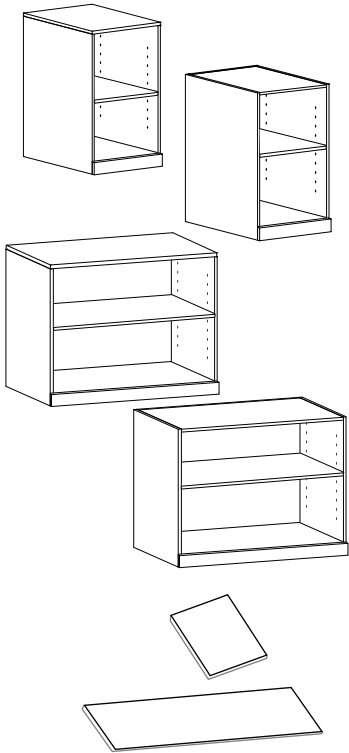

DESCRIPTION	PRODUCT NUMBER	WIDTH	DEPTH	HEIGHT	SHIP WGT
Credenza Base, Open Freestanding* (with top – ships with 1 shelf)	I16CBOS (see options below)	16"	24"	28.5"	92 lbs
Credenza Base, Open, WSS (without top – ships with 1 shelf)	I16CBOW (see options below)	16"	24"	28"	92 lbs
Credenza Base, Open Freestanding* (with top – ships with 1 shelf)	I36CBOS (see options below)	36"	24"	28.5"	144 lbs
Credenza Base, Open, WSS (without top – ships with 1 shelf)	I36CBOW (see options below)	36"	24"	28"	144 lbs
Shelf (for 16" wide Credenza Base, includes 4 hanging clips) each	I16SHELF (see options below)	14.5"	22.5"		6 lbs
Shelf (for 36" wide Credenza Base, includes 4 hanging clips) each	I36SHELF (see options below)	34.5"	22.5"		10 lbs

*All Freestanding products have 5/8" tops.

TO ORDER CREDENZA BASE, OPEN FREESTANDING:

Select the product number and then add the codes for the laminate base color, top color & top trim color.

For example, to order an Integrate Credenza Base, Open 16" wide, Freestanding (I16C-BOS), in Biltmore Cherry Base (BT), Biltmore Cherry Top (BT) and Black Top Trim (AG), specify:

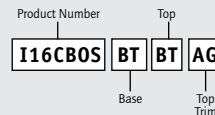

NOTE: Top Laminate & Top Trim Options do not apply to WSS Model.

Laminate (Base, Top and Top Trim)

Color	Base/Top	Top Trim	
Biltmore Cherry	= BT*	= CD	*Wood Ticked Laminates
Colombian Walnut	= CI*	= CB	match original smooth
Kensington Maple	= KE*	= CC	Laminates on pg. 54 of this Spec Guide and can be specified on Top Work Surface and Base Components.
Shaker Cherry	= SK*	= CG	
Studio Teak	= SU*	= CM	
Amber Cherry	= AB*	= AB	
Sterling Ash	= SA*	= SA	
Light Oak	= LO*	= LO	
Silver Oak	= SO*	= SO	
Buka Bark	= BK*	= BK	
Harvest Maple	= HM*	= HM	
Rio	= RI*	= RI	
Noble Mahogany	= NM	= NM	
White Twill	= WT	= WT	
Neural Twill	= NT	= NT	
Sarum Twill	= ST	= ST	
Graphite Twill	= GT	= GT	
Earthen Twill	= ET	= ET	See Complete Laminate List on pg. 54.
Fashion Gray	= RS	= RS	
Black	= AG	= AG	
Brite White	= FP	= FP	

TO ORDER EXTRA SHELF (for 36" Base):

Using same options as above, specify:

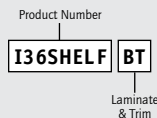

- Field replaceable components
- Matching and contrasting finishes
- Easy access leveling
- 32mm fabrication system assures precision construction and assembly
- Durable, high-pressure laminate
- Freestanding modular components
- Metal hardware & leveling hinges
- Engineered wood substrate (1-1/8" work surfaces, 5/8" vertical panels and 5/8" tops on freestanding components)
- Indoor Air Quality Certified to SCSEC10.3-2014 Conforms to the ANSI/BIFMA Furniture Emissions Standard

NOTE:

WSS – Work Surface Supporting (without finish top)

All Freestanding products have 5/8" tops.

Product dimensions shown in approximate inches. *All components available in matching OFG Harmony Casegoods laminate colors – see page 55 for more information.

INTEGRATE • Credenza Bases

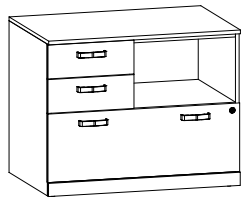

DESCRIPTION	PRODUCT NUMBER	WIDTH	DEPTH	HEIGHT	SHIP WGT
Credenza Base Mixed Drawer Freestanding* (with top – ships with 1 shelf)	I36CBMS (see options below)	36"	24"	28.5"	184 lbs

*All Freestanding products have 5/8" tops.

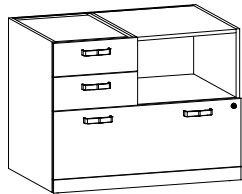

Credenza Base Mixed Drawer WSS (without top)	I36CBMW (see options below)	36"	24"	28"	184 lbs
Credenza Base Mixed Drawer WSS (without top – fits under 24" deep Credenza)	I36CBMD (see options below)	36"	19.5"	27.5"	184 lbs

- Field replaceable components
- Matching and contrasting finishes
- Easy access leveling
- Metal leveling glides
- 32mm fabrication system assures precision construction and assembly
- Durable, high-pressure laminate
- Freestanding modular components
- Metal hardware & leveling hinges
- Birch plywood drawer construction
- Bottom drawer has locking mechanism
- Engineered wood substrate (1-1/8" work surfaces, 5/8" vertical panels and 5/8" tops on freestanding components)
- Indoor Air Quality Certified to SCSEC10.3-2014 Conforms to the ANSI/BIFMA Furniture Emissions Standard

TO ORDER CREDENZA BASE, MIXED DRAWER, FREESTANDING:

Select the product number and then add the codes for the desired drawer position, hardware pull, laminate base color, top color & top trim color.

For example, to order an Integrate Credenza Base Mixed Drawer Freestanding (I36CBMS), with Drawer Position on left (L), Brushed Nickel Arch Pull (1), Biltmore Cherry Base (BT), Biltmore Cherry Top (BT) and Black Top Trim (AG), specify:

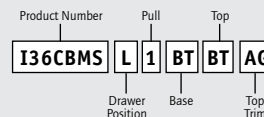

NOTE: Top Laminate & Top Trim Options do not apply to WSS Model.

Laminate (Base, Top and Top Trim)

Color	Base/Top	Top Trim	
Biltmore Cherry	= BT*	= CD	*Wood Ticked Laminates
Colombian Walnut	= CI*	= CB	match original smooth
Kensington Maple	= KE*	= CC	Laminates on pg. 54 of this Spec Guide and can be specified on Top Work Surface and Base Components.
Shaker Cherry	= SK*	= CG	
Studio Teak	= SU*	= CM	
Amber Cherry	= AB*	= AB	
Sterling Ash	= SA*	= SA	
Light Oak	= LO*	= LO	
Silver Oak	= SO*	= SO	
Buka Bark	= BK*	= BK	
Harvest Maple	= HM*	= HM	
Rio	= RI*	= RI	
Noble Mahogany	= NM	= NM	
White Twill	= WT	= WT	
Neural Twill	= NT	= NT	
Sarum Twill	= ST	= ST	
Graphite Twill	= GT	= GT	
Earthen Twill	= ET	= ET	See Complete Laminate List on pg. 54.
Fashion Gray	= RS	= RS	
Black	= AG	= AG	
Brite White	= FP	= FP	

Drawer Position

Position

L = Left



R = Right



Pull

1 = Brushed Nickel Arch



2 = Brushed Nickel Bar



3 = Brushed Nickel Modern



Product dimensions shown in approximate inches. *All components available in matching OFG Harmony Casegoods laminate colors – see page 55 for more information.

INTEGRATE • Credenza Bases, Low

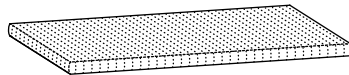
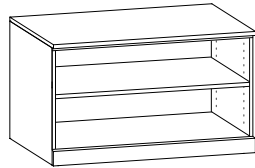
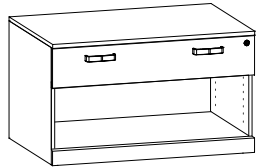
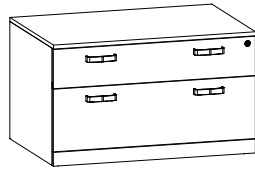

DESCRIPTION	PRODUCT NUMBER	CONFIGURATION	WIDTH	DEPTH	HEIGHT	SHIP WGT
Credenza Base, Low Box & Lateral Drawers	I36CBLS	BL	36"	18.75"	21"	160 lbs
Credenza Base, Low Box Drawer & Open Shelf	I36CBLS	B0	36"	18.75"	21"	130 lbs
Credenza Base, Low Open with 1 Shelf	I36CBLS	0S	36"	18.75"	21"	100 lbs

*Optional 36 x 18.75" Seat Cushion available – see below.

DESCRIPTION	PRODUCT NUMBER	WIDTH	DEPTH	HEIGHT	SHIP WGT
Seat Cushion, 36 x 18.75" (for Low Credenza Base)	I36SC (see options below)	36"	18.75"	1.25"	8 lbs
TEXTILE GRADE #1	TEXTILE GRADE #2	TEXTILE GRADE #3	TEXTILE GRADE #4	TEXTILE GRADE #5	TEXTILE GRADE #6

*Refer to Mayer-Paetz Upholstery Fabrics for Optional Seat Textile Choices (available fabric and grade.)

TO ORDER CREDENZA BASES, LOW:

Select the product number and then add the codes for the hardware pull, laminate base color, top color & trim color.

For example, to order an Integrate Credenza Base, Low (I36CBLS), configured with Box & Lateral Drawers (BL), with Brushed Nickel Bar Pulls (2), Biltmore Cherry Base (BT), Biltmore Cherry Top (BT) and Black Top Trim (AG), specify:

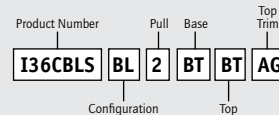

Pull

1 = Brushed Nickel Arch



2 = Brushed Nickel Bar



3 = Brushed Nickel Modern



TO ORDER SEAT CUSHION:

Refer to Mayer-Paetz Upholstery Fabrics for Optional Seat Textile Choices (available grade and fabric.)

For example, to order an Integrate Seat Cushion, 36 x 18.75" (I36SC), with Textile Grade #1 (1), in Basic/Pumice Fabric (FAB9231), specify:

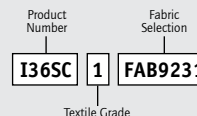

Note: COM (Customer's Own Material) Option is available. For more information or assistance, contact your UNICOR/OFG Sales Rep.

Laminate (Base, Top and Top Trim)

Color	Base/Top	Top Trim	
Biltmore Cherry	= BT*	= CD	*Wood Ticked Laminates
Colombian Walnut	= CI*	= CB	match original smooth
Kensington Maple	= KE*	= CC	Laminates on pg. 54 of this Spec Guide and can be specified on Top Work Surface and Base Components.
Shaker Cherry	= SK*	= CG	
Studio Teak	= SU*	= CM	
Amber Cherry	= AB*	= AB	
Sterling Ash	= SA*	= SA	
Light Oak	= LO*	= LO	
Silver Oak	= SO*	= SO	
Buka Bark	= BK*	= BK	
Harvest Maple	= HM*	= HM	
Rio	= RI*	= RI	
Noble Mahogany	= NM	= NM	
White Twill	= WT	= WT	
Neural Twill	= NT	= NT	
Sarum Twill	= ST	= ST	
Graphite Twill	= GT	= GT	
Earthen Twill	= ET	= ET	See Complete Laminate List on pg. 54.
Fashion Gray	= RS	= RS	
Black	= AG	= AG	
Brite White	= FP	= FP	

- Field replaceable components
- Matching and contrasting finishes
- Easy access leveling
- Metal leveling glides
- 32mm fabrication system assures precision construction and assembly
- Durable, high-pressure laminate
- Freestanding modular components
- Metal hardware & leveling hinges
- Birch plywood drawer construction
- Lockable storage components
- Engineered wood substrate (1-1/8" work surfaces, 5/8" vertical panels and 5/8" tops on freestanding components)
- Indoor Air Quality Certified to SCSEC10.3-2014 Conforms to the ANSI/BIFMA Furniture Emissions Standard

SEAT CUSHION

- Refer to Mayer-Paetz Upholstery Fabrics for Optional Seat Textile Choices (available fabric and grade.)
- Non-skid backing

Product dimensions shown in approximate inches. *All components available in matching OFG Harmony Casegoods laminate colors – see page 55 for more information.

INTEGRATE • Lateral Files

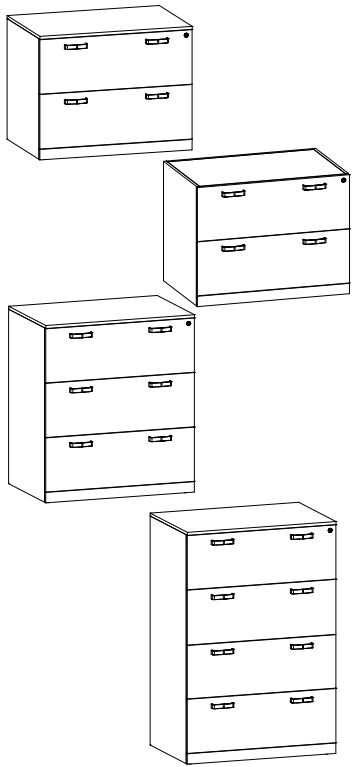

DESCRIPTION	PRODUCT NUMBER	WIDTH	DEPTH	HEIGHT	SHIP WGT
Lateral File, 2 Drawer Freestanding* (with top)	I2LFS (see options below)	36"	24"	28.5"	160 lbs
Lateral File, 2 Drawer, WSS (without top)	I2LFW (see options below)	36"	24"	28"	160 lbs
Lateral File, 2 Drawer, WSS (without top – fits under 24" deep Credenza)	I2LFD (see options below)	36"	19.5"	28"	159 lbs
Lateral File, 3 Drawer Freestanding* (with top)	I3LFS (see options below)	36"	24"	41"	208 lbs
Lateral File, 4 Drawer Freestanding* (with top)	I4LFS (see options below)	36"	24"	53.5"	256 lbs

*All Freestanding products have 5/8" tops.

- Field replaceable components
- Matching and contrasting finishes
- Easy access leveling
- Metal leveling glides
- 32mm fabrication system assures precision construction and assembly
- Durable, high-pressure laminate
- Freestanding modular components
- Metal hardware & leveling hinges
- Birch plywood drawer construction
- Engineered wood substrate (1-1/8" work surfaces, 5/8" vertical panels and 5/8" tops on freestanding components)
- Drawers have central locking mechanism
- Indoor Air Quality Certified to SCSEC10.3-2014 Conforms to the ANSI/BIFMA Furniture Emissions Standard

TO ORDER LATERAL FILE, 2 DRAWER FREESTANDING:

Select the product number and then add the codes for the desired hardware pull, laminate base color, top color & top trim color.

For example, to order an Integrate Lateral File, 2 Drawer Freestanding (I2LFS), with Brushed Nickel Bar (2), Biltmore Cherry Base (BT), Biltmore Cherry Top (BT) and Black Top Trim (AG), specify:

For example, to order an Integrate Lateral File, 2 Drawer Stand-Alone, to fit under Credenza (I2LFD), with Brushed Nickel Arch Pull (1), with Biltmore Cherry Base (BT), specify:

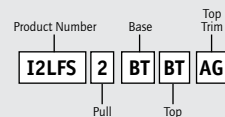

NOTE: Top Laminate & Top Trim Options do not apply to WSS Model.

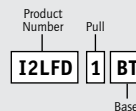

Laminate (Base, Top and Top Trim)

Color	Base/Top	Top Trim	
Biltmore Cherry	= BT*	= CD	*Wood Ticked
Colombian Walnut	= CI*	= CB	Laminates
Kensington Maple	= KE*	= CC	match original
Shaker Cherry	= SK*	= CG	smooth
Studio Teak	= SU*	= CM	Laminates on
Amber Cherry	= AB*	= AB	pg. 54 of this
Sterling Ash	= SA*	= SA	Spec Guide and
Light Oak	= LO*	= LO	can be specified
Silver Oak	= SO*	= SO	on Top Work
Buka Bark	= BK*	= BK	Surface
Harvest Maple	= HM*	= HM	and Base
Rio	= RI*	= RI	Components.
Noble Mahogany	= NM	= NM	
White Twill	= WT	= WT	
Neural Twill	= NT	= NT	
Sarum Twill	= ST	= ST	
Graphite Twill	= GT	= GT	
Earthen Twill	= ET	= ET	See Complete
Fashion Gray	= RS	= RS	Laminate List
Black	= AG	= AG	on pg. 54.
Brite White	= FP	= FP	

Pull

- 1 = Brushed Nickel Arch  2 = Brushed Nickel Bar  3 = Brushed Nickel Modern 

Product dimensions shown in approximate inches. *All components available in matching OFG Harmony Casegoods laminate colors –see page 55 for more information.

INTEGRATE • Conference Ends

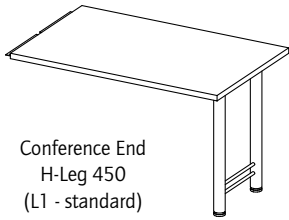

Conference End
H-Leg 450
(L1 - standard)

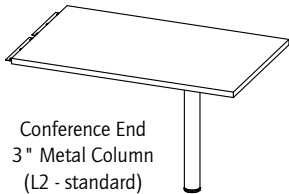

Conference End
3" Metal Column
(L2 - standard)

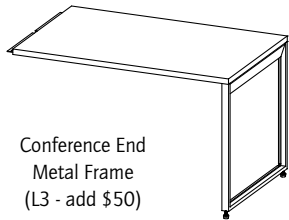

Conference End
Metal Frame
(L3 - add \$50)

DESCRIPTION	PRODUCT NUMBER	WIDTH	DEPTH	HEIGHT	SHIP WGT
48" Conference End w/Leg Style Options ^{KD} (ships unassembled with mending plate)	IK48CEP (see options below)	48"	30"	29"	92 lbs
54" Conference End w/Leg Style Options ^{KD} (ships unassembled with mending plate)	IK54CEP (see options below)	54"	30"	29"	98 lbs
60" Conference End w/Leg Style Options ^{KD} (ships unassembled with mending plate)	IK60CEP (see options below)	60"	30"	29"	104 lbs
72" Conference End w/Leg Style Options ^{KD} (ships unassembled with mending plate)	IK72CEP (see options below)	72"	30"	29"	116 lbs

*2 mending plates included with all Conference Ends.

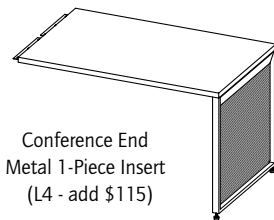

Conference End
Metal 1-Piece Insert
(L4 - add \$115)

TO ORDER CONFERENCE END:

Select the product number and then add the codes for leg style, top color & top trim color.

For example, to order an Integrate 48" Conference End (IK48CEP), with Metal 1-Piece Insert Leg Style (L4 – add \$115 to base price), with Biltmore Cherry Top (BT) and Black Trim (AG), specify:

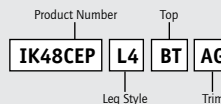

Laminate (Base, Top and Top Trim)

Color	Base/Top	Top Trim	
Biltmore Cherry	= BT*	= CD	*Wood Ticked
Colombian Walnut	= CI*	= CB	Laminates
Kensington Maple	= KE*	= CC	match original
Shaker Cherry	= SK*	= CG	smooth
Studio Teak	= SU*	= CM	Laminates on
Amber Cherry	= AB*	= AB	pg. 54 of this
Sterling Ash	= SA*	= SA	Spec Guide and
Light Oak	= LO*	= LO	can be specified
Silver Oak	= SO*	= SO	on Top Work
Buka Bark	= BK*	= BK	Surface
Harvest Maple	= HM*	= HM	and Base
Rio	= RI*	= RI	Components.
Noble Mahogany	= NM	= NM	
White Twill	= WT	= WT	
Neural Twill	= NT	= NT	
Sarum Twill	= ST	= ST	
Graphite Twill	= GT	= GT	
Earthen Twill	= ET	= ET	See Complete
Fashion Gray	= RS	= RS	Laminate List
Black	= AG	= AG	on pg. 54.
Brite White	= FP	= FP	

NOTE:

Leg Styles in Starlight Silver finish.
Conference End ships KD (knocked-down)
^{KD} – Indicates product available KD (knock-down)

Product dimensions shown in approximate inches. *All components available in matching OFG Harmony Casegoods laminate colors – see page 55 for more information.

INTEGRATE • Conference Ends



"P" End, Position Left
(select Leg Style below)

DESCRIPTION	PRODUCT NUMBER	WIDTH	DEPTH	HEIGHT	SHIP WGT
66" Conference "P" End ^{KD} (select leg below; ships unassembled)	I66CEPWS (see options below)	66"	42"*	29"	125 lbs
72" Conference "P" End ^{KD} (select leg below; ships unassembled)	I72CEPWS (see options below)	72"	42"*	29"	130 lbs

*Diameter of "P" = 42"; depth of rectangular section = 30"



"D" End
(select Leg Style below)

DESCRIPTION	PRODUCT NUMBER	WIDTH	DEPTH	HEIGHT	SHIP WGT
54" Conference "D" End ^{KD} (select leg below; ships unassembled)	I54CEDWS (see options below)	54"	30"	29"	113 lbs
60" Conference "D" End ^{KD} (select leg below; ships unassembled)	I60CEDWS (see options below)	60"	30"	29"	119 lbs
66" Conference "D" End ^{KD} (select leg below; ships unassembled)	I66CEDWS (see options below)	66"	30"	29"	127 lbs
72" Conference "D" End ^{KD} (select leg below; ships unassembled)	I72CEDWS (see options below)	72"	30"	29"	131 lbs

*2 mending plates included with all Conference Ends.

TO ORDER CONFERENCE "P" END:

Select the product number and then add the codes for "P" position, leg style, top color and top trim color.

For example, to order an Integrate 72" Conference "P" End (I72CEPWS), "P" Position Right (R), with H-Leg 450 Leg Style (L1), Biltmore Cherry Base & Top (BT) and Black Trim (AG), specify:

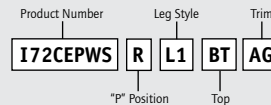

TO ORDER CONFERENCE "D" END:

Select the product number and then add the codes for leg, top color and top trim color.

For example, to order an Integrate 72" Conference "D" End (I72CEDWS), with Metal Frame Leg Style (L3), Biltmore Cherry Base & Top (BT) and Black Trim (AG), specify:

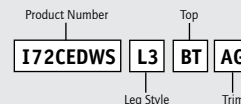

"P" Position

L = Left
R = Right

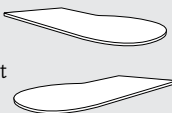

Conference End, Leg Style

L1 = H-Leg 450
(add \$87)

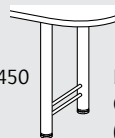

L2 = 3" Metal
Column
(add \$59)

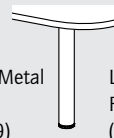

L3 = Metal
Frame
(add \$94)

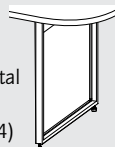

L4 = Metal
1-Piece Insert
(add \$141)

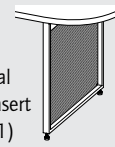

Laminate (Base, Top and Top Trim)

Color	Base/Top	Top Trim	
Biltmore Cherry	= BT*	= CD	*Wood Ticked Laminates match original smooth Laminates on pg. 54 of this Spec Guide and can be specified on Top Work Surface and Base Components.
Colombian Walnut	= CI*	= CB	
Kensington Maple	= KE*	= CC	
Shaker Cherry	= SK*	= CG	
Studio Teak	= SU*	= CM	
Amber Cherry	= AB*	= AB	
Sterling Ash	= SA*	= SA	
Light Oak	= LO*	= LO	
Silver Oak	= SO*	= SO	
Buka Bark	= BK*	= BK	
Harvest Maple	= HM*	= HM	
Rio	= RI*	= RI	
Noble Mahogany	= NM	= NM	
White Twill	= WT	= WT	
Neural Twill	= NT	= NT	
Sarum Twill	= ST	= ST	
Graphite Twill	= GT	= GT	
Earthen Twill	= ET	= ET	
Fashion Gray	= RS	= RS	
Black	= AG	= AG	
Brite White	= FP	= FP	

See Complete Laminate List on pg. 54.

NOTE:

Leg Styles in Starlight Silver finish.
Conference End ships KD (knocked-down)
^{KD} – Indicates product available KD (knock-down)

Product dimensions shown in approximate inches. *All components available in matching OFG Harmony Casegoods laminate colors – see page 55 for more information.

INTEGRATE • Conference Ends, Free-Standing

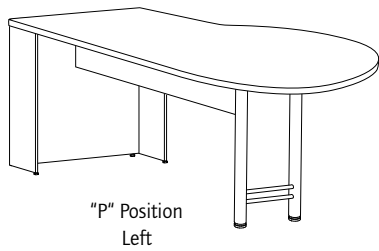

DESCRIPTION	PRODUCT NUMBER	WIDTH	DEPTH	HEIGHT	SHIP WGT
66" Conference "P" End Free-Standing, w/H-Leg only KD (ships unassembled)	IK66CEPFS (see options below)	66"	42"*	29"	230 lbs
72" Conference "P" End Free-Standing, w/H-Leg only KD (ships unassembled)	IK72CEPFS (see options below)	72"	42"*	29"	255 lbs

*Diameter of "P" = 42"; depth of rectangular section = 30"

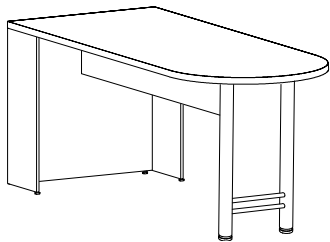

DESCRIPTION	PRODUCT NUMBER	WIDTH	DEPTH	HEIGHT	SHIP WGT
54" Conference "D" End Free-Standing, w/H-Leg only KD (ships unassembled)	IK54CED (see options below)	54"	30"	29"	185 lbs
60" Conference "D" End Free-Standing, w/H-Leg only KD (ships unassembled)	IK60CED (see options below)	60"	30"	29"	195 lbs
66" Conference "D" End Free-Standing, w/H-Leg only KD (ships unassembled)	IK66CED (see options below)	66"	30"	29"	205 lbs
72" Conference "D" End Free-Standing, w/H-Leg only KD (ships unassembled)	IK72CED (see options below)	72"	30"	29"	230 lbs

TO ORDER CONFERENCE "P" END, FREE-STANDING:

Select the product number and then add the codes for "P" position, base & top color and top trim color.

For example, to order an Integrate 72" Conference "P" End, Free-Standing (IK72CEPFS), "P" Position Left (L), with Biltmore Cherry Base & Top (BT) and Black Trim (AG), specify:

"P" Position

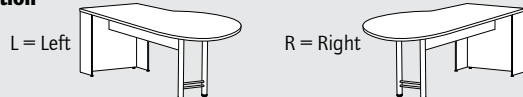

TO ORDER CONFERENCE "D" END, FREE-STANDING:

Select the product number and then add the codes for base & top color and top trim color.

For example, to order an Integrate 72" Conference "D" End, Free-Standing (IK72CED), with Biltmore Cherry Base & Top (BT) and Black Trim (AG), specify:

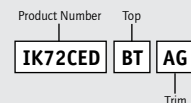
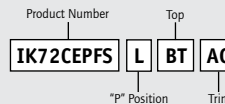

Laminate (Base, Top and Top Trim)

Color	Base/Top	Top Trim	
Biltmore Cherry	= BT* =	CD	*Wood Ticked Laminates
Colombian Walnut	= CI* =	CB	match original smooth
Kensington Maple	= KE* =	CC	Laminates on pg. 54 of this Spec Guide and can be specified on Top Work Surface and Base Components.
Shaker Cherry	= SK* =	CG	
Studio Teak	= SU* =	CM	
Amber Cherry	= AB* =	AB	
Sterling Ash	= SA* =	SA	
Light Oak	= LO* =	LO	
Silver Oak	= SO* =	SO	
Buka Bark	= BK* =	BK	
Harvest Maple	= HM* =	HM	
Rio	= RI* =	RI	
Noble Mahogany	= NM =	NM	
White Twill	= WT =	WT	
Neural Twill	= NT =	NT	
Sarum Twill	= ST =	ST	
Graphite Twill	= GT =	GT	
Earthen Twill	= ET =	ET	See Complete Laminate List on pg. 54.
Fashion Gray	= RS =	RS	
Black	= AG =	AG	
Brite White	= FP =	FP	

- H-Leg in Starlight Silver finish
- Non-handed/reconfigurable
- Field replaceable components
- Matching and contrasting finishes
- Easy access leveling
- Nylon-capped leveling glides
- 32mm fabrication system assures precision construction and assembly
- Durable, high-pressure laminate
- Freestanding modular components
- Metal hardware & leveling hinges
- Engineered wood substrate (1-1/8" work surfaces)
- Work surface supported by one 52" stiffener bar
- Indoor Air Quality Certified to SCSEC10.3-2014 Conforms to the ANSI/BIFMA Furniture Emissions Standard

NOTE:

H-Leg available in Starlight Silver finish only.

KD — Indicates product ships KD (knock-down)

Product dimensions shown in approximate inches. *All components available in matching OFG Harmony Casegoods laminate colors — see page 55 for more information.

INTEGRATE • Bookcases

DESCRIPTION	PRODUCT NUMBER	WIDTH	DEPTH	HEIGHT	SHIP WGT
Bookcase 3 Shelf	I3BK (see options below)	36"	16"	41"	100 lbs
Bookcase 4 Shelf	I4BK (see options below)	36"	16"	53.5"	140 lbs
Bookcase 5 Shelf	I5BK (see options below)	36"	16"	65.5"	180 lbs
Shelf (for 36" wide Bookcase, includes 4 hanging clips) each	ISHELFBK (see options below)	34.5"	15"		10 lbs

INTEGRATE • Side Shelving

DESCRIPTION	PRODUCT NUMBER	WIDTH	DEPTH	HEIGHT	SHIP WGT
Side Shelving	I16SS (see options below)	16"	24"	25.5"	90 lbs
Shelf (for 24" deep Side Shelving, includes 4 hanging clips) each	ISHELFSS (see options below)	15.5"	22.5"		6 lbs

*Side Shelving for use with I16PDW or I16CBCW (Work Surface Supporting bases).

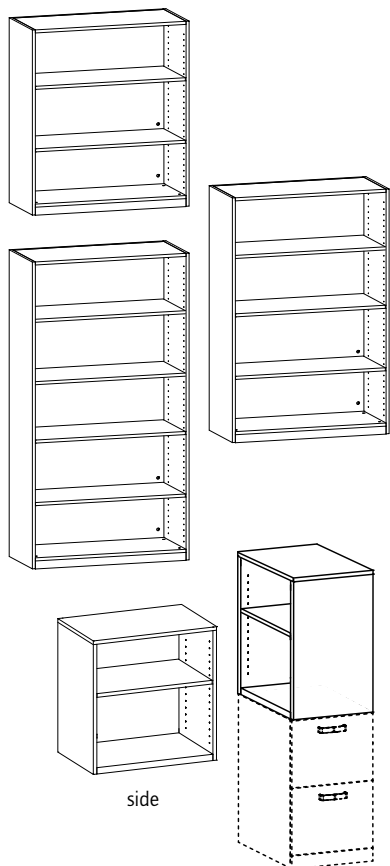

- Field replaceable components
- Matching and contrasting finishes
- Nylon-capped leveling glides
- 32mm fabrication system assures precision construction and assembly
- Durable, high-pressure laminate
- Freestanding modular components
- Metal hardware & leveling hinges
- Engineered wood substrate (5/8" panels)
- Indoor Air Quality Certified to SCSEC10.3-2014 Conforms to the ANSI/BIFMA Furniture Emissions Standard
- Adjustable shelves

TO ORDER BOOKCASES & SIDE SHELVING:

Select the product number and then add the codes for the desired laminate base color & shelf color. Trim will match laminate selected for Base and Shelves respectively.

For example, to order an Integrate Bookcase, 3 Shelf (I3BK), with Biltmore Cherry Base (BT) and Brite White Shelves (FP), specify:

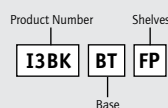

TO ORDER EXTRA SHELF (for Bookcase):

Using same options as above, specify:



Laminate (Base, Top and Top Trim)

Color	Base/Top	Top Trim	
Biltmore Cherry	= BT*	= CD	*Wood Ticked
Colombian Walnut	= CI*	= CB	Laminates
Kensington Maple	= KE*	= CC	match original
Shaker Cherry	= SK*	= CG	smooth
Studio Teak	= SU*	= CM	Laminates on
Amber Cherry	= AB*	= AB	pg. 54 of this
Sterling Ash	= SA*	= SA	Spec Guide and
Light Oak	= LO*	= LO	can be specified
Silver Oak	= SO*	= SO	on Top Work
Buka Bark	= BK*	= BK	Surface
Harvest Maple	= HM*	= HM	and Base
Rio	= RI*	= RI	Components.
Noble Mahogany	= NM	= NM	
White Twill	= WT	= WT	
Neural Twill	= NT	= NT	
Sarum Twill	= ST	= ST	
Graphite Twill	= GT	= GT	
Earthen Twill	= ET	= ET	See Complete
Fashion Gray	= RS	= RS	Laminate List
Black	= AG	= AG	on pg. 54.
Brite White	= FP	= FP	

Product dimensions shown in approximate inches. *All components available in matching OFG Harmony Casegoods laminate colors – see page 55 for more information.

INTEGRATE • Upper Shelving Units

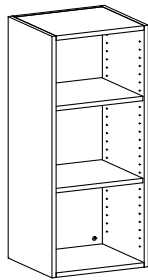
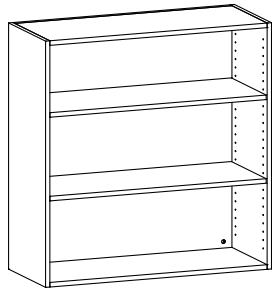

DESCRIPTION	PRODUCT NUMBER	WIDTH	DEPTH	HEIGHT	SHIP WGT
Upper Shelving Unit, Open (Includes 2 Shelves)	I36USO (see options below)	36"	16"	37"	100 lbs
Shelf (for 36" wide Upper Shelves, includes 4 hanging clips) each	I36SHELFUS (see options below)	34.5"	13"		10 lbs
Upper Shelving Unit, Open (Includes 2 Shelves)	I16USO (see options below)	16"	16"	37"	72 lbs
Upper Shelving Unit, Open (Includes 2 Shelves)	I18USO (see options below)	18"	16"	37"	80 lbs
Shelf (for 16" wide Upper Shelves, includes 4 hanging clips) each	I16SHELFUS (see options below)	14.5"	13.5"		6 lbs
Shelf (for 18" wide Upper Shelves, includes 4 hanging clips) each	I18SHELFUS (see options below)	16.5"	13.5"		10 lbs

- Field replaceable components
- Matching and contrasting finishes
- Nylon-capped leveling glides
- 32mm fabrication system assures precision construction and assembly
- Durable, high-pressure laminate
- Freestanding modular components
- Metal hardware & leveling hinges
- Engineered wood substrate (5/8" panels)
- Indoor Air Quality Certified to SCSEC10.3-2014 Conforms to the ANSI/BIFMA Furniture Emissions Standard
- Adjustable shelves

TO ORDER UPPER SHELVES, OPEN:

Select the product number and then add the codes for the desired laminate color.

For example, to order an Integrate Upper Shelves, Open 36" wide (I36USO), in Biltmore Cherry Base Laminate (BT), specify:

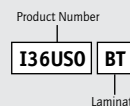

Laminate (Base, Top and Top Trim)

Color	Base/Top	Top Trim	
Biltmore Cherry	= BT*	= CD	*Wood Ticked Laminates
Colombian Walnut	= CI*	= CB	match original smooth
Kensington Maple	= KE*	= CC	Laminates on pg. 54 of this Spec Guide and can be specified on Top Work Surface and Base Components.
Shaker Cherry	= SK*	= CG	
Studio Teak	= SU*	= CM	
Amber Cherry	= AB*	= AB	
Sterling Ash	= SA*	= SA	
Light Oak	= LO*	= LO	
Silver Oak	= SO*	= SO	
Buka Bark	= BK*	= BK	
Harvest Maple	= HM*	= HM	
Rio	= RI*	= RI	
Noble Mahogany	= NM	= NM	
White Twill	= WT	= WT	
Neural Twill	= NT	= NT	
Sarum Twill	= ST	= ST	
Graphite Twill	= GT	= GT	
Earthen Twill	= ET	= ET	See Complete Laminate List on pg. 54.
Fashion Gray	= RS	= RS	
Black	= AG	= AG	
Brite White	= FP	= FP	

TO ORDER EXTRA SHELF (for Upper Shelves, Open 36"):

Using same options as above, specify:



NOTE:

Upper Shelving Units includes 2 Adjustable Shelves.

Product dimensions shown in approximate inches. *All components available in matching OFG Harmony Casegoods laminate colors – see page 55 for more information.

INTEGRATE • Upper Shelving Units • 15" Depth

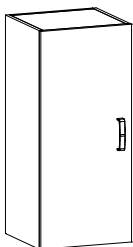
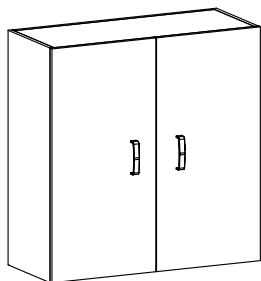

DESCRIPTION	PRODUCT NUMBER	WIDTH	DEPTH	HEIGHT	SHIP WGT
Upper Shelving Unit, 36" x 15" Closed (Includes 2 Shelves)	I36USC (see options below)	36"	15"	37"	144 lbs
Shelf (for 36"W x 15"D Upper Shelves, includes 4 hanging clips each)	I36SHELFUS (see options below)	34.5"	13.5"		10 lbs
Upper Shelving Unit, 16" x 15" Closed (Includes 2 Shelves)	I16USC (see options below)	16"	15"	37"	92 lbs
Upper Shelving Unit, 18" x 15" Closed (Includes 2 Shelves)	I18USC (see options below)	18"	15"	37"	100 lbs
Shelf (for 16"W x 15"D Upper Shelves, includes 4 hanging clips each)	I16SHELFUS (see options below)	14.5"	13.5"		6 lbs
Shelf (for 18"W x 15"D Upper Shelves, includes 4 hanging clips each)	I18SHELFUS (see options below)	16.5"	13.5"		10 lbs

- Non-handed/reconfigurable
- Field replaceable components
- 32mm fabrication system assures precision construction and assembly
- Durable, high-pressure laminate
- Metal hardware
- Engineered wood substrate (5/8" panels)
- Adjustable shelves
- Full overlay doors
- Indoor Air Quality Certified to SCSEC10.3-2014 Conforms to the ANSI/BIFMA Furniture Emissions Standard
- Soft-close hinges

TO ORDER UPPER SHELVES, CLOSED:

Select the product number and then add the codes for the desired door position (single door only), hardware pull, and laminate color.

For example, to order an Integrate Upper Shelves, Closed 16W x 15"D (I16USC), with Single Door Hang on left (L), Brushed Nickel Arch Pull (1), in Biltmore Cherry Base Laminate (BT), specify:

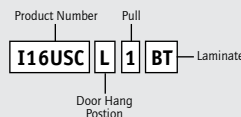

Laminate (Base, Top and Top Trim)

Color	Base/Top	Top Trim	
Biltmore Cherry	= BT*	= CD	*Wood Ticked
Colombian Walnut	= CI*	= CB	Laminates
Kensington Maple	= KE*	= CC	match original
Shaker Cherry	= SK*	= CG	smooth
Studio Teak	= SU*	= CM	Laminates on
Amber Cherry	= AB*	= AB	pg. 54 of this
Sterling Ash	= SA*	= SA	Spec Guide and
Light Oak	= LO*	= LO	can be specified
Silver Oak	= SO*	= SO	on Top Work
Buka Bark	= BK*	= BK	Surface
Harvest Maple	= HM*	= HM	and Base
Rio	= RI*	= RI	Components.
Noble Mahogany	= NM	= NM	
White Twill	= WT	= WT	
Neural Twill	= NT	= NT	
Sarum Twill	= ST	= ST	
Graphite Twill	= GT	= GT	
Earthen Twill	= ET	= ET	
Fashion Gray	= RS	= RS	
Black	= AG	= AG	
Brite White	= FP	= FP	

See Complete Laminate List on pg. 54.

Door Hang



Position
L = Left



R = Right



Pull

- 1 = Brushed Nickel Arch 
- 2 = Brushed Nickel Bar 
- 3 = Brushed Nickel Modern 

TO ORDER EXTRA SHELF (for Upper Shelving, Closed, 36"W):

Using same options as above, specify:



Product dimensions shown in approximate inches. *All components available in matching OFG Harmony Casegoods laminate colors – see page 55 for more information.

NOTE:
Upper Shelving Units include 2 Adjustable Shelves.

INTEGRATE • Upper Shelving Units • 24" Depth

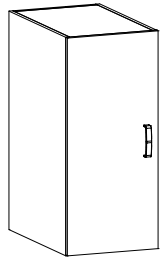
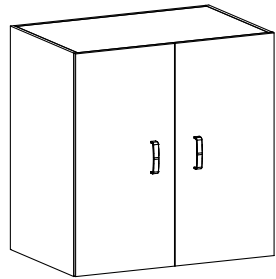

DESCRIPTION	PRODUCT NUMBER	WIDTH	DEPTH	HEIGHT	SHIP WGT
Upper Shelving Unit, 36" x 24" Closed (Includes 2 Shelves)	I3624USC (see options below)	36"	24"	37"	170 lbs
Shelf (for 36"W x 24"D Upper Shelves, includes 4 hanging clips each)	I3624SHELFUS (see options below)	34.5"	23.5"		16 lbs
Upper Shelving Unit, 16" x 24" Closed (Includes 2 Shelves)	I1624USC (see options below)	16"	24"	37"	118 lbs
Upper Shelving Unit, 18" x 24" Closed (Includes 2 Shelves)	I1824USC (see options below)	18"	24"	37"	126 lbs
Shelf (for 16"W x 24"D Upper Shelves, includes 4 hanging clips each)	I1624SHELFUS (see options below)	14.5"	23.5"		11 lbs
Shelf (for 18"W x 24"D Upper Shelves, includes 4 hanging clips each)	I1824SHELFUS (see options below)	16.5"	23.5"		12 lbs

- Non-handed/reconfigurable
- Field replaceable components
- 32mm fabrication system assures precision construction and assembly
- Durable, high-pressure laminate
- Metal hardware
- Engineered wood substrate (5/8" panels)
- Adjustable shelves
- Full overlay doors
- Indoor Air Quality Certified to SCSEC10.3-2014 Conforms to the ANSI/BIFMA Furniture Emissions Standard
- Soft-close hinges

TO ORDER UPPER SHELVING UNIT, CLOSED:

Select the product number and then add the codes for the desired door position (single door only), hardware pull, and laminate & trim color.

For example, to order an Integrate Upper Shelving, 24" Closed (I1624USC), with Single Door Hang on left (L), Brushed Nickel Arch Pull (1), in Biltmore Cherry Base Laminate (BT), specify:

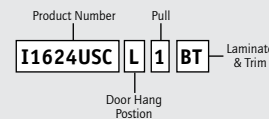

Laminate (Base, Top and Top Trim)

Color	Base/Top	Top Trim	
Biltmore Cherry	= BT*	= CD	*Wood Ticked
Colombian Walnut	= CI*	= CB	Laminates
Kensington Maple	= KE*	= CC	match original
Shaker Cherry	= SK*	= CG	smooth
Studio Teak	= SU*	= CM	Laminates on
Amber Cherry	= AB*	= AB	pg. 54 of this
Sterling Ash	= SA*	= SA	Spec Guide and
Light Oak	= LO*	= LO	can be specified
Silver Oak	= SO*	= SO	on Top Work
Buka Bark	= BK*	= BK	Surface
Harvest Maple	= HM*	= HM	and Base
Rio	= RI*	= RI	Components.
Noble Mahogany	= NM	= NM	
White Twill	= WT	= WT	
Neural Twill	= NT	= NT	
Sarum Twill	= ST	= ST	
Graphite Twill	= GT	= GT	
Earthen Twill	= ET	= ET	See Complete
Fashion Gray	= RS	= RS	Laminate List
Black	= AG	= AG	on pg. 54.
Brite White	= FP	= FP	

Door Hang

Position

L = Left

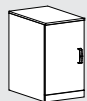

R = Right

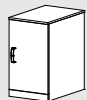

Pull

1 = Brushed Nickel Arch



2 = Brushed Nickel Bar



3 = Brushed Nickel Modern



TO ORDER EXTRA SHELF (for Upper Shelving Closed, 24" Depth (36"W)):

Using same options as above, specify:



NOTE:

Upper Shelving Units include 2 Adjustable Shelves.

Product dimensions shown in approximate inches. *All components available in matching OFG Harmony Casegoods laminate colors – see page 55 for more information.

INTEGRATE • Upper Shelving Units with Frosted Glass Doors or White Marker Board Doors • 15" Depth

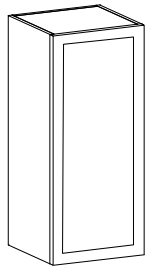
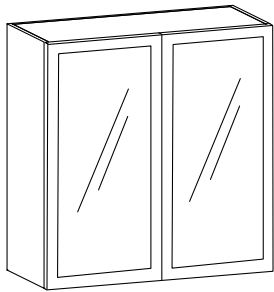

DESCRIPTION	PRODUCT NUMBER	WIDTH	DEPTH	HEIGHT	SHIP WGT
Upper Shelving Unit, 36" x 15" Closed with Frosted Glass Doors (Includes 2 Shelves)	I36USCG (see options below)	36"	15"	36"	160 lbs
Upper Shelving Unit, 36" x 15" Closed with White Marker Board Doors (Includes 2 Shelves)	I36USCMB (see options below)	36"	15"	36"	160 lbs
Shelf (for 36"W x 15"D Upper Shelves, includes 4 hanging clips each)	I36SHELFUS (see options below)	34.5"	13"		10 lbs
Upper Shelving Unit, 18" x 15" Closed with Frosted Glass Door (Includes 2 Shelves)	I18USCG (see options below)	18"	15"	36"	110 lbs
Upper Shelving Unit, 18" x 15" Closed with White Marker Board Door (Includes 2 Shelves)	I18USCMB (see options below)	18"	15"	36"	110 lbs
Shelf (for 18"W x 15"D Upper Shelves, includes 4 hanging clips each)	I18SHELFUS (see options below)	16.5"	13.5"		10 lbs

- Field replaceable components
- 32mm fabrication system assures precision construction and assembly
- Durable, high-pressure laminate
- Metal hardware
- Engineered wood substrate (5/8" panels)
- Adjustable shelves
- Indoor Air Quality Certified to SCSEC10.3-2014 Conforms to the ANSI/BIFMA Furniture Emissions Standard
- Soft-close hinges

TO ORDER UPPER SHELVING, CLOSED, 36"W:

Select the product number and then add the codes for the desired laminate color.

For example, to order an Integrate Upper Shelving Unit, Closed with Frosted Glass Doors, 36" wide (I36USCG), in Biltmore Cherry Base Laminate (BT), specify:

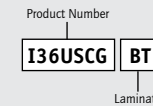

TO ORDER UPPER SHELVING, CLOSED, 18"W:

Select the product number then add codes for desired door position (single door only) and laminate color.

For example, to order an Integrate Upper Shelving Unit, Closed with Frosted Glass Door, 18" wide (I18USCG), with Left Door Hang Position (L), in Biltmore Cherry Base Laminate (BT), specify:

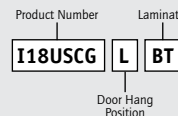

Door Hang

Position

L = Left

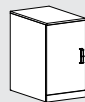

R = Right

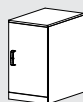

TO ORDER EXTRA SHELF (for Upper Shelving, Closed, 36"W):

Using same options as above, specify:



Laminate (Base, Top and Top Trim)

Color	Base/Top	Top Trim	
Biltmore Cherry	= BT*	= CD	*Wood Ticked Laminates match original smooth Laminates on pg. 54 of this Spec Guide and can be specified on Top Work Surface and Base Components.
Colombian Walnut	= CI*	= CB	
Kensington Maple	= KE*	= CC	
Shaker Cherry	= SK*	= CG	
Studio Teak	= SU*	= CM	
Amber Cherry	= AB*	= AB	
Sterling Ash	= SA*	= SA	
Light Oak	= LO*	= LO	
Silver Oak	= SO*	= SO	
Buka Bark	= BK*	= BK	
Harvest Maple	= HM*	= HM	
Rio	= RI*	= RI	
Noble Mahogany	= NM	= NM	
White Twill	= WT	= WT	
Neural Twill	= NT	= NT	
Sarum Twill	= ST	= ST	
Graphite Twill	= GT	= GT	
Earthen Twill	= ET	= ET	See Complete Laminate List on pg. 54.
Fashion Gray	= RS	= RS	
Black	= AG	= AG	
Brite White	= FP	= FP	

NOTE:

Upper Shelving Units include 2 Adjustable Shelves.

Product dimensions shown in approximate inches. *All components available in matching OFG Harmony Casegoods laminate colors – see page 55 for more information.

INTEGRATE • Upper Shelving Units with Frosted Glass Doors or White Marker Board Doors • 24" Depth

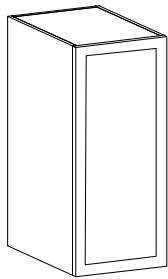
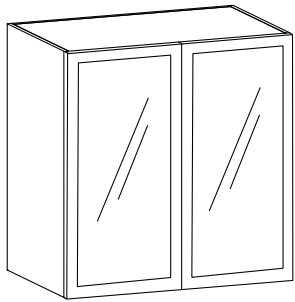

DESCRIPTION	PRODUCT NUMBER	WIDTH	DEPTH	HEIGHT	SHIP WGT
Upper Shelving Unit, 36" x 24" Closed with Frosted Glass Doors (Includes 2 Shelves)	I3624USCG (see options below)	36"	24"	36"	186 lbs
Upper Shelving Unit, 36" x 24" Closed with White Marker Board Doors (Includes 2 Shelves)	I3624USCMB (see options below)	36"	24"	36"	186 lbs
Shelf (for 36"W X 24"D Upper Shelves, includes 4 hanging clips each)	I3624SHELFUS (see options below)	34.5"	23.5"		16 lbs
Upper Shelving Unit, 18" x 24" Closed with Frosted Glass Door (Includes 2 Shelves)	I1824USCG (see options below)	18"	24"	36"	136 lbs
Upper Shelving Unit, 18" x 24" Closed with White Marker Board Door (Includes 2 Shelves)	I1824USCMB (see options below)	18"	24"	36"	136 lbs
Shelf (for 18"W X 24"D Upper Shelves, includes 4 hanging clips each)	I1824SHELFUS (see options below)	16.5"	23.5"		12 lbs

- Field replaceable components
- 32mm fabrication system assures precision construction and assembly
- Durable, high-pressure laminate
- Metal hardware
- Engineered wood substrate (5/8" panels)
- Adjustable shelves
- Indoor Air Quality Certified to SCSEC10.3-2014 Conforms to the ANSI/BIFMA Furniture Emissions Standard
- Soft-close hinges

TO ORDER UPPER SHELVING UNIT, 36" X 24" CLOSED WITH FROSTED GLASS DOORS:

Select the product number and then add the codes for the desired laminate color.

For example, to order an Integrate Upper Shelving Unit, 24 Depth" Closed with Frosted Glass Doors, 36"W X 24"D (I3624USCG), in Biltmore Cherry Base Laminate (BT), specify:

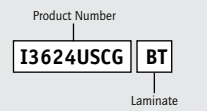

TO ORDER UPPER SHELVING UNIT, 18" X 24" CLOSED WITH FROSTED GLASS DOOR:

Select the product number then add codes for desired door position (single door only) and laminate color.

For example, to order an Integrate Upper Shelving Unit, 24" Closed with Frosted Glass Door, 18"W x 24"D (I1824USCG), with Left Door Hang Position (L), in Biltmore Cherry Base Laminate (BT), specify:

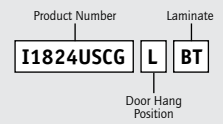

Door Hang

Position

L = Left

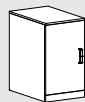

R = Right



TO ORDER EXTRA SHELF (for Upper Shelving Closed, 24" Depth (36"W):

Using same options as above, specify:



Laminate (Base, Top and Top Trim)

Color	Base/Top	Top Trim
Biltmore Cherry	= BT*	= CD
Colombian Walnut	= CI*	= CB
Kensington Maple	= KE*	= CC
Shaker Cherry	= SK*	= CG
Studio Teak	= SU*	= CM
Amber Cherry	= AB*	= AB
Sterling Ash	= SA*	= SA
Light Oak	= LO*	= LO
Silver Oak	= SO*	= SO
Buka Bark	= BK*	= BK
Harvest Maple	= HM*	= HM
Rio	= RI*	= RI
Noble Mahogany	= NM	= NM
White Twill	= WT	= WT
Neural Twill	= NT	= NT
Sarum Twill	= ST	= ST
Graphite Twill	= GT	= GT
Earthen Twill	= ET	= ET
Fashion Gray	= RS	= RS
Black	= AG	= AG
Brite White	= FP	= FP

*Wood Ticked Laminates match original smooth Laminates on pg. 54 of this Spec Guide and can be specified on Top Work Surface and Base Components.

See Complete Laminate List on pg. 54.

NOTE:
Upper Shelving Units include 2 Adjustable Shelves.

Product dimensions shown in approximate inches. *All components available in matching OFG Harmony Casegoods laminate colors – see page 55 for more information.

INTEGRATE • Overheads – Closed Full Back with Solid Doors

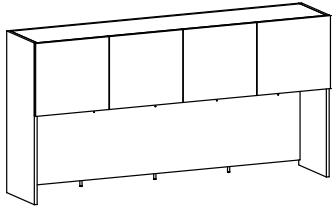

DESCRIPTION	PRODUCT NUMBER	WIDTH	DEPTH	HEIGHT	SHIP WGT
60" Overhead, Closed Full Back, with Solid Doors	I600HCFB (see options below)	60"	15"	36.5"	180 lbs
66" Overhead, Closed Full Back, with Solid Doors	I660HCFB (see options below)	66"	15"	36.5"	198 lbs
72" Overhead, Closed Full Back, with Solid Doors	I720HCFB (see options below)	72"	15"	36.5"	216 lbs

INTEGRATE • Overheads – Closed Full Back, Solid Doors with Paper Management

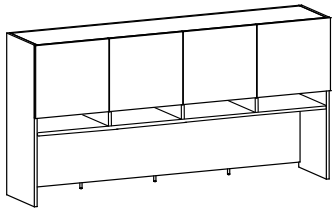

DESCRIPTION	PRODUCT NUMBER	PAPER MGMT	WIDTH	DEPTH	HEIGHT	SHIP WGT
60" Overhead, Closed Full Back, Solid Doors with Paper Management	I600HCFB (see options below)	Y	60"	15"	36.5"	200 lbs
66" Overhead, Closed Full Back, Solid Doors with Paper Management	I660HCFB (see options below)	Y	66"	15"	36.5"	223 lbs
72" Overhead, Closed Full Back, Solid Doors with Paper Management	I720HCFB (see options below)	Y	72"	15"	36.5"	246 lbs

*Refer to page 39 for Paper Management information & details.

TO ORDER OVERHEADS:

Select the product number and then add the code for laminate color.

For example, to order an Integrate 72" Overhead, Closed Full Back, Solid Doors with Paper Management (I720HCFB), with Paper Management (Y), in Black Laminate (AG), specify:

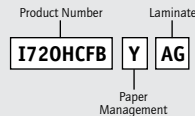

Laminate (Base, Top and Top Trim)

Color	Base/Top	Top Trim	
Biltmore Cherry	= BT*	= CD	*Wood Ticked
Colombian Walnut	= CI*	= CB	Laminates
Kensington Maple	= KE*	= CC	match original
Shaker Cherry	= SK*	= CG	smooth
Studio Teak	= SU*	= CM	Laminates on
Amber Cherry	= AB*	= AB	pg. 54 of this
Sterling Ash	= SA*	= SA	Spec Guide and
Light Oak	= LO*	= LO	can be specified
Silver Oak	= SO*	= SO	on Top Work
Buka Bark	= BK*	= BK	Surface
Harvest Maple	= HM*	= HM	and Base
Rio	= RI*	= RI	Components.
Noble Mahogany	= NM	= NM	
White Twill	= WT	= WT	
Neural Twill	= NT	= NT	
Sarum Twill	= ST	= ST	
Graphite Twill	= GT	= GT	
Earthen Twill	= ET	= ET	See Complete
Fashion Gray	= RS	= RS	Laminate List
Black	= AG	= AG	on pg. 54.
Brite White	= FP	= FP	

ACCESSORIES (ORDER SEPARATELY)

44" LED Task Light

See page 53 for more details & ordering information.

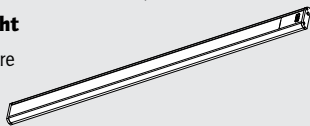

Tackboard

See page 49 for more details & ordering information.

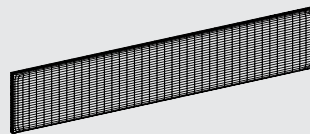

NOTE:

See page 39 for Paper Management information & details.

See page 49 for Tackboard ordering information & details.

See page 53 for 44" LED Task Light ordering information & details.

Product dimensions shown in approximate inches. *All components available in matching OFG Harmony Casegoods laminate colors – see page 55 for more information.

INTEGRATE • Overheads – Closed Full Back, Frosted Glass Doors

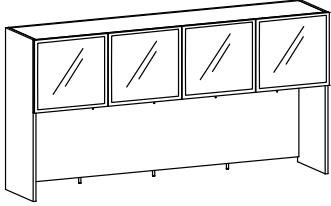

DESCRIPTION	PRODUCT NUMBER	WIDTH	DEPTH	HEIGHT	SHIP WGT
60" Overhead, Closed Full Back, with Frosted Glass Doors	I600HCFBG (see options below)	60"	15"	36.5"	180 lbs
66" Overhead, Closed Full Back, with Frosted Glass Doors	I660HCFBG (see options below)	66"	15"	36.5"	198 lbs
72" Overhead, Closed Full Back, with Frosted Glass Doors	I720HCFBG (see options below)	72"	15"	36.5"	216 lbs

INTEGRATE • Overheads – Closed Full Back, Frosted Glass Doors with Paper Management

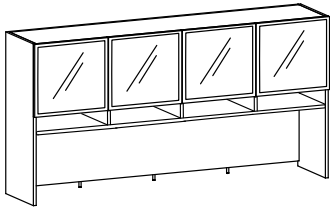

DESCRIPTION	PRODUCT NUMBER	PAPER MGMT	WIDTH	DEPTH	HEIGHT	SHIP WGT
60" Overhead, Closed Full Back, Frosted Glass Doors with Paper Management	I600HCFBG (see options below)	Y	60"	15"	36.5"	200 lbs
66" Overhead, Closed Full Back, Frosted Glass Doors with Paper Management	I660HCFBG (see options below)	Y	66"	15"	36.5"	223 lbs
72" Overhead, Closed Full Back, Frosted Glass Doors with Paper Management	I720HCFBG (see options below)	Y	72"	15"	36.5"	246 lbs

*Refer to page 39 for Paper Management information & details.

- Field replaceable components
- Wire/cable management
- 32mm fabrication system assures precision construction and assembly
- Durable, high-pressure laminate
- Metal hardware
- Engineered wood substrate (1-1/8" work surfaces, 5/8" panels)
- Indoor Air Quality Certified to SCSECT10.3-2014 Conforms to the ANSI/BIFMA Furniture Emissions Standard
- Soft-close hinges

TO ORDER OVERHEADS:

Select the product number and then add the code for laminate color.

For example, to order an Integrate 72" Overhead, Closed Full Back, Glass Doors with Paper Management (I720HCFBG), with Paper Management (Y), in Black Laminate (AG), specify:

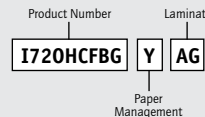

Laminate (Base, Top and Top Trim)

Color	Base/Top	Top Trim	
Biltmore Cherry	= BT*	= CD	*Wood Ticked Laminates
Colombian Walnut	= CI*	= CB	match original smooth
Kensington Maple	= KE*	= CC	Laminates on pg. 54 of this Spec Guide and can be specified on Top Work Surface and Base Components.
Shaker Cherry	= SK*	= CG	
Studio Teak	= SU*	= CM	
Amber Cherry	= AB*	= AB	
Sterling Ash	= SA*	= SA	
Light Oak	= LO*	= LO	
Silver Oak	= SO*	= SO	
Buka Bark	= BK*	= BK	
Harvest Maple	= HM*	= HM	
Rio	= RI*	= RI	
Noble Mahogany	= NM	= NM	
White Twill	= WT	= WT	
Neural Twill	= NT	= NT	
Sarum Twill	= ST	= ST	
Graphite Twill	= GT	= GT	
Earthen Twill	= ET	= ET	See Complete Laminate List on pg. 54.
Fashion Gray	= RS	= RS	
Black	= AG	= AG	
Brite White	= FP	= FP	

ACCESSORIES (ORDER SEPARATELY)

44" LED Task Light

See page 53 for more details & ordering information.

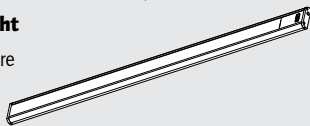

Tackboard

See page 49 for more details & ordering information.

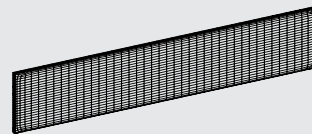

NOTE:

See page 39 for Paper Management information & details.

See page 49 for Tackboard ordering information & details.

See page 53 for 44" LED Task Light ordering information & details.

Product dimensions shown in approximate inches. *All components available in matching OFG Harmony Casegoods laminate colors – see page 55 for more information.

INTEGRATE • Overheads – Closed Full Back, White Marker Board Doors

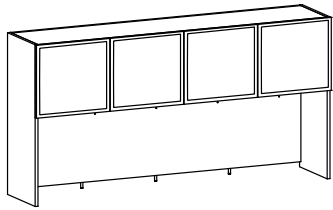

DESCRIPTION	PRODUCT NUMBER	WIDTH	DEPTH	HEIGHT	SHIP WGT
60" Overhead, Closed Full Back, White Marker Board Doors	I600HCFBM <small>(see options below)</small>	60"	15"	36.5"	180 lbs
66" Overhead, Closed Full Back, White Marker Board Doors	I660HCFBM <small>(see options below)</small>	66"	15"	36.5"	198 lbs
72" Overhead, Closed Full Back, White Marker Board Doors	I720HCFBM <small>(see options below)</small>	72"	15"	36.5"	216 lbs

INTEGRATE • Overheads – Closed Full Back, White Marker Board Doors with Paper Management

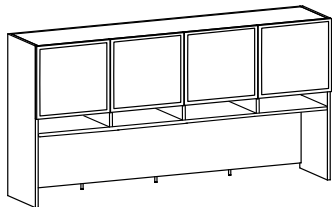

DESCRIPTION	PRODUCT NUMBER	PAPER MGMT	WIDTH	DEPTH	HEIGHT	SHIP WGT
60" Overhead, Closed Full Back, White Marker Board Doors with Paper Management	I600HCFBM <small>(see options below)</small>	Y	60"	15"	36.5"	200 lbs
66" Overhead, Closed Full Back, White Marker Board Doors with Paper Management	I660HCFBM <small>(see options below)</small>	Y	66"	15"	36.5"	223 lbs
72" Overhead, Closed Full Back, White Marker Board Doors with Paper Management	I720HCFBM <small>(see options below)</small>	Y	72"	15"	36.5"	246 lbs

*Refer to page 39 for Paper Management information & details.

- Field replaceable components
- Wire/cable management
- 32mm fabrication system assures precision construction and assembly
- Durable, high-pressure laminate
- Metal hardware
- Engineered wood substrate (1-1/8" work surfaces, 5/8" panels)
- Indoor Air Quality Certified to SCSECT10.3-2014 Conforms to the ANSI/BIFMA Furniture Emissions Standard
- Soft-close hinges

TO ORDER OVERHEADS:

Select the product number and then add the code for laminate color.

For example, to order an Integrate 72" Overhead, Closed Full Back, Glass Doors with Paper Management (I720HCFBG), with Paper Management (Y), in Black Laminate (AG), specify:

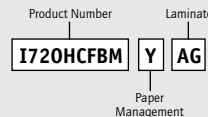

ACCESSORIES (ORDER SEPARATELY)

44" LED Task Light

See page 53 for more details & ordering information.

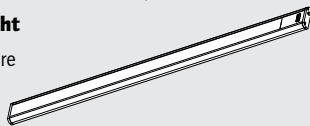

Tackboard

See page 49 for more details & ordering information.

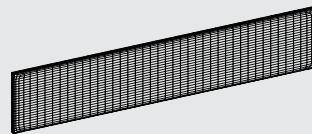

Laminate (Base, Top and Top Trim)

Color	Base/Top	Top Trim	
Biltmore Cherry	= BT*	= CD	*Wood Ticked
Colombian Walnut	= C1*	= CB	Laminates
Kensington Maple	= KE*	= CC	match original
Shaker Cherry	= SK*	= CG	smooth
Studio Teak	= SU*	= CM	Laminates on
Amber Cherry	= AB*	= AB	pg. 54 of this
Sterling Ash	= SA*	= SA	Spec Guide and
Light Oak	= LO*	= LO	can be specified
Silver Oak	= SO*	= SO	on Top Work
Buka Bark	= BK*	= BK	Surface
Harvest Maple	= HM*	= HM	and Base
Rio	= RI*	= RI	Components.
Noble Mahogany	= NM	= NM	
White Twill	= WT	= WT	
Neural Twill	= NT	= NT	
Sarum Twill	= ST	= ST	
Graphite Twill	= GT	= GT	
Earthen Twill	= ET	= ET	See Complete
Fashion Gray	= RS	= RS	Laminate List
Black	= AG	= AG	on pg. 54.
Brite White	= FP	= FP	

NOTE:

See page 39 for Paper Management information & details.

See page 49 for Tackboard ordering information & details.

See page 53 for 44" LED Task Light ordering information & details.

Product dimensions shown in approximate inches. *All components available in matching OFG Harmony Casegoods laminate colors – see page 55 for more information.

INTEGRATE • Paper Management (add-on)

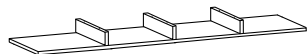
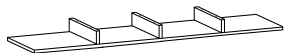
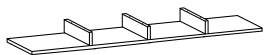

DESCRIPTION	PRODUCT NUMBER	WIDTH	DEPTH	HEIGHT	SHIP WGT
60" Paper Management (mounts under Overhead – can be field installed)	I60PM (see options below)	58.6"	12.1"	4.5"	20 lbs
66" Paper Management (mounts under Overhead – can be field installed)	I66PM (see options below)	64.6"	12.1"	4.5"	25 lbs
72" Paper Management (mounts under Overhead – can be field installed)	I72PM (see options below)	70.6"	12.1"	4.5"	30 lbs

*Paper Management can be ordered separately to install on your existing Integrate Overhead.

*Mounting hardware included.

*Not available for Wall Mount Overheads.

- Field replaceable components
- 32mm fabrication system assures precision construction and assembly
- Durable, high-pressure laminate
- Metal hardware
- Indoor Air Quality Certified to SCSEC10.3-2014 Conforms to the ANSI/BIFMA Furniture Emissions Standard

TO ORDER PAPER MANAGEMENT:

Order Paper Management separately to install on your existing Integrate Overhead.

Select the product number and then add the code for laminate color.

For example, to order an Integrate 72" Paper Management (I72PM), in Black Laminate (AG), specify:

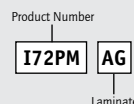

Laminate (Base, Top and Top Trim)

Color	Base/Top	Top Trim	
Biltmore Cherry	= BT*	= CD	*Wood Ticked
Colombian Walnut	= CI*	= CB	Laminates
Kensington Maple	= KE*	= CC	match original
Shaker Cherry	= SK*	= CG	smooth
Studio Teak	= SU*	= CM	Laminates on
Amber Cherry	= AB*	= AB	pg. 54 of this
Sterling Ash	= SA*	= SA	Spec Guide and
Light Oak	= LO*	= LO	can be specified
Silver Oak	= SO*	= SO	on Top Work
Buka Bark	= BK*	= BK	Surface
Harvest Maple	= HM*	= HM	and Base
Rio	= RI*	= RI	Components.
Noble Mahogany	= NM	= NM	
White Twill	= WT	= WT	
Neural Twill	= NT	= NT	
Sarum Twill	= ST	= ST	
Graphite Twill	= GT	= GT	
Earthen Twill	= ET	= ET	
Fashion Gray	= RS	= RS	
Black	= AG	= AG	
Brite White	= FP	= FP	

See Complete Laminate List on pg. 54.

NOTE:

See page 49 for Tackboard ordering information & details.

See page 53 for 44" LED Task Light ordering information & details.

Paper Management not available on Wall Mount Overheads.

Product dimensions shown in approximate inches. *All components available in matching OFG Harmony Casegoods laminate colors – see page 55 for more information.

INTEGRATE • Overheads – Wall Mount, with Solid Doors

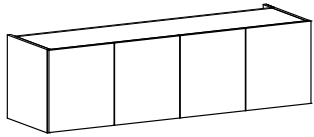

DESCRIPTION	PRODUCT NUMBER	WIDTH	DEPTH	HEIGHT	SHIP WGT
60" Overhead, Wall Mount, with Solid Doors	I600HWM (see options below)	60"	15"	16.5"	150 lbs

*Wall Mount Overhead requires wall reinforcement backing.

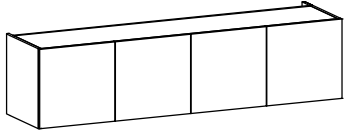

66" Overhead, Wall Mount, with Solid Doors	I660HWM (see options below)	66"	15"	16.5"	169 lbs
---	--------------------------------	-----	-----	-------	---------

*Wall Mount Overhead requires wall reinforcement backing.

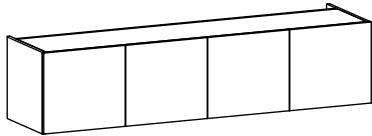

72" Overhead, Wall Mount, with Solid Doors	I720HWM (see options below)	72"	15"	16.5"	188 lbs
---	--------------------------------	-----	-----	-------	---------

*Wall Mount Overhead requires wall reinforcement backing.

NOTE: Paper Management not available on Wall Mount Overheads.

- Field replaceable components
- Wire/cable management
- 32mm fabrication system assures precision construction and assembly
- Durable, high-pressure laminate
- Metal hardware
- Engineered wood substrate (1-1/8" work surfaces, 5/8" panels)
- Nylon-capped leveling glides
- Indoor Air Quality Certified to SCSEC10.3-2014 Conforms to the ANSI/BIFMA Furniture Emissions Standard
- Nylon leveling mechanism
- Soft-close hinges

TO ORDER OVERHEADS:

Select the product number and then add the code for laminate color.

For example, to order an Integrate 72" Overhead, Wall Mount with Solid Doors (I720HWM), in Black Laminate (AG), specify:

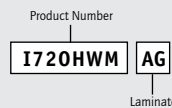

Leveling Mechanism

Aids in level mounting of Overhead, Wall Mount

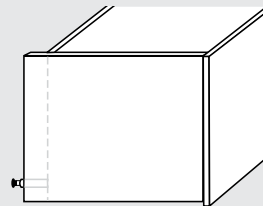

Laminate (Base, Top and Top Trim)

Color	Base/Top	Top Trim	
Biltmore Cherry	= BT*	= CD	*Wood Ticked
Colombian Walnut	= CI*	= CB	Laminates
Kensington Maple	= KE*	= CC	match original
Shaker Cherry	= SK*	= CG	smooth
Studio Teak	= SU*	= CM	Laminates on
Amber Cherry	= AB*	= AB	pg. 54 of this
Sterling Ash	= SA*	= SA	Spec Guide and
Light Oak	= LO*	= LO	can be specified
Silver Oak	= SO*	= SO	on Top Work
Buka Bark	= BK*	= BK	Surface
Harvest Maple	= HM*	= HM	and Base
Rio	= RI*	= RI	Components.
Noble Mahogany	= NM	= NM	
White Twill	= WT	= WT	
Neural Twill	= NT	= NT	
Sarum Twill	= ST	= ST	
Graphite Twill	= GT	= GT	
Earthen Twill	= ET	= ET	See Complete
Fashion Gray	= RS	= RS	Laminate List
Black	= AG	= AG	on pg. 54.
Brite White	= FP	= FP	

ACCESSORIES (ORDER SEPARATELY)

44" LED Task Light

See page 53 for more details & ordering information.

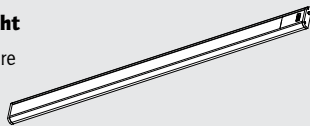

Tackboard

See page 49 for more details & ordering information.

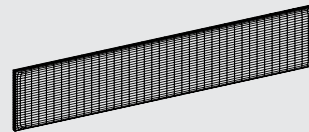

NOTE:

Wall Mount Overhead requires wall reinforcement backing.
See page 53 for 44" LED Task Light ordering information & details.
See page 49 for Tackboard ordering information & details.
Paper Management not available on Wall Mount Overheads.

Product dimensions shown in approximate inches. *All components available in matching OFG Harmony Casegoods laminate colors – see page 55 for more information.

INTEGRATE • Overheads – Wall Mount, with Frosted Glass Doors

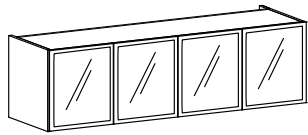

DESCRIPTION	PRODUCT NUMBER	WIDTH	DEPTH	HEIGHT	SHIP WGT
60" Overhead, Wall Mount, with Frosted Glass Doors	I600HWMG (see options below)	60"	15"	16.5"	150 lbs

*Wall Mount Overhead requires wall reinforcement backing.

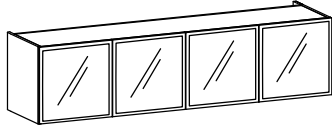

66" Overhead, Wall Mount, with Frosted Glass Doors	I660HWMG (see options below)	66"	15"	16.5"	169 lbs
---	---------------------------------	-----	-----	-------	---------

*Wall Mount Overhead requires wall reinforcement backing.

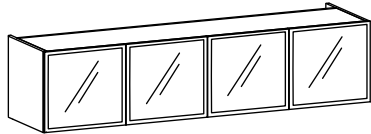

72" Overhead, Wall Mount, with Frosted Glass Doors	I720HWMG (see options below)	72"	15"	16.5"	188 lbs
---	---------------------------------	-----	-----	-------	---------

*Wall Mount Overhead requires wall reinforcement backing.

NOTE: Paper Management not available on Wall Mount Overheads.

- Field replaceable components
- Wire/cable management
- 32mm fabrication system assures precision construction and assembly
- Durable, high-pressure laminate
- Metal hardware
- Engineered wood substrate (1-1/8" work surfaces, 5/8" panels)
- Indoor Air Quality Certified to SCSEC10.3-2014 Conforms to the ANSI/BIFMA Furniture Emissions Standard
- Nylon leveling mechanism
- Soft-close hinges

TO ORDER OVERHEADS:

Select the product number and then add the code for laminate color.

For example, to order an Integrate 72" Overhead, Wall Mount with Glass Doors (I720HWMG), in Black Laminate (AG), specify::

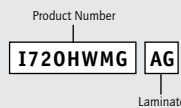

Leveling Mechanism

Aids in level mounting of Overhead, Wall Mount

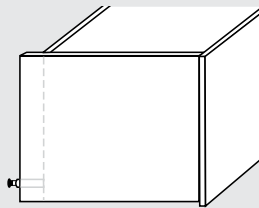

Laminate (Base, Top and Top Trim)

Color	Base/Top	Top Trim	
Biltmore Cherry	= BT*	= CD	*Wood Ticked
Colombian Walnut	= CI*	= CB	Laminates
Kensington Maple	= KE*	= CC	match original
Shaker Cherry	= SK*	= CG	smooth
Studio Teak	= SU*	= CM	Laminates on
Amber Cherry	= AB*	= AB	pg. 54 of this
Sterling Ash	= SA*	= SA	Spec Guide and
Light Oak	= LO*	= LO	can be specified
Silver Oak	= SO*	= SO	on Top Work
Buka Bark	= BK*	= BK	Surface
Harvest Maple	= HM*	= HM	and Base
Rio	= RI*	= RI	Components.
Noble Mahogany	= NM	= NM	
White Twill	= WT	= WT	
Neural Twill	= NT	= NT	
Sarum Twill	= ST	= ST	
Graphite Twill	= GT	= GT	
Earthen Twill	= ET	= ET	See Complete
Fashion Gray	= RS	= RS	Laminate List
Black	= AG	= AG	on pg. 54.
Brite White	= FP	= FP	

ACCESSORIES (ORDER SEPARATELY)

44" LED Task Light

See page 53 for more details & ordering information.

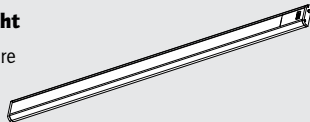

Tackboard

See page 49 for more details & ordering information.

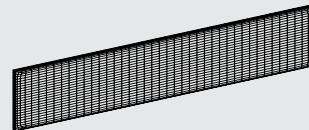

NOTE:

Wall Mount Overhead requires wall reinforcement backing.
See page 53 for 44" LED Task Light ordering information & details.
See page 49 for Tackboard ordering information & details.
Paper Management not available on Wall Mount Overheads.

Product dimensions shown in approximate inches. *All components available in matching OFG Harmony Casegoods laminate colors – see page 55 for more information.

INTEGRATE • Overheads – Wall Mount, with White Marker Board Doors

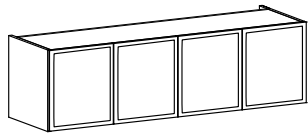

DESCRIPTION	PRODUCT NUMBER	WIDTH	DEPTH	HEIGHT	SHIP WGT
60" Overhead, Wall Mount, with White Marker Board Doors	I600HWMM (see options below)	60"	15"	16.5"	150 lbs

*Wall Mount Overhead requires wall reinforcement backing.

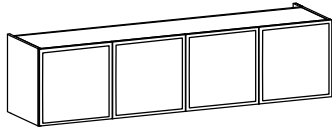

66" Overhead, Wall Mount, with White Marker Board Doors	I660HWMM (see options below)	66"	15"	16.5"	169 lbs
--	---------------------------------	-----	-----	-------	---------

*Wall Mount Overhead requires wall reinforcement backing.

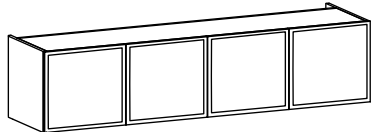

72" Overhead, Wall Mount, with White Marker Board Doors	I720HWMM (see options below)	72"	15"	16.5"	188 lbs
--	---------------------------------	-----	-----	-------	---------

*Wall Mount Overhead requires wall reinforcement backing.

NOTE: Paper Management not available on Wall Mount Overheads.

- Field replaceable components
- Wire/cable management
- 32mm fabrication system assures precision construction and assembly
- Durable, high-pressure laminate
- Metal hardware
- Engineered wood substrate (1-1/8" work surfaces, 5/8" panels)
- Indoor Air Quality Certified to SCSEC10.3-2014 Conforms to the ANSI/BIFMA Furniture Emissions Standard
- Nylon leveling mechanism
- Soft-close hinges

TO ORDER OVERHEADS:

Select the product number and then add the code for laminate color.

For example, to order an Integrate 72" Overhead, Wall Mount with White Marker Board Doors (I720HWMM), in Black Laminate (AG), specify:

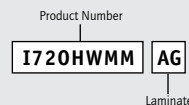

Leveling Mechanism

Aids in level mounting of Overhead, Wall Mount

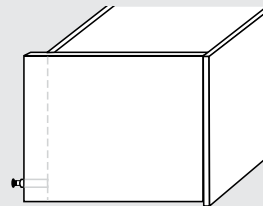

Laminate (Base, Top and Top Trim)

Color	Base/Top	Top Trim	
Biltmore Cherry	= BT*	= CD	*Wood Ticked
Colombian Walnut	= CI*	= CB	Laminates
Kensington Maple	= KE*	= CC	match original
Shaker Cherry	= SK*	= CG	smooth
Studio Teak	= SU*	= CM	Laminates on
Amber Cherry	= AB*	= AB	pg. 54 of this
Sterling Ash	= SA*	= SA	Spec Guide and
Light Oak	= LO*	= LO	can be specified
Silver Oak	= SO*	= SO	on Top Work
Buka Bark	= BK*	= BK	Surface
Harvest Maple	= HM*	= HM	and Base
Rio	= RI*	= RI	Components.
Noble Mahogany	= NM	= NM	
White Twill	= WT	= WT	
Neural Twill	= NT	= NT	
Sarum Twill	= ST	= ST	
Graphite Twill	= GT	= GT	
Earthen Twill	= ET	= ET	See Complete
Fashion Gray	= RS	= RS	Laminate List
Black	= AG	= AG	on pg. 54.
Brite White	= FP	= FP	

ACCESSORIES (ORDER SEPARATELY)

44" LED Task Light

See page 53 for more details & ordering information.

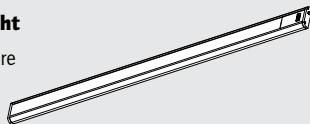

Tackboard

See page 49 for more details & ordering information.

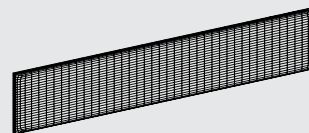

NOTE:

Wall Mount Overhead requires wall reinforcement backing.
See page 53 for 44" LED Task Light ordering information & details.
See page 49 for Tackboard ordering information & details.
Paper Management not available on Wall Mount Overheads.

Product dimensions shown in approximate inches. *All components available in matching OFG Harmony Casegoods laminate colors – see page 55 for more information.

INTEGRATE • Wardrobes

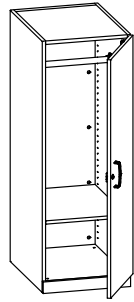

DESCRIPTION	PRODUCT NUMBER	WIDTH	DEPTH	HEIGHT	SHIP WGT
Wardrobe, Compact (includes 1 shelf & closet rod)	I1854WR (see options below)	18"	24"	53"	143 lbs
Wardrobe, Stand-Alone (includes 1 shelf & closet rod)	I1867WR (see options below)	18"	24"	65.5"	176 lbs
Shelf (for 18" wide Wardrobe or Storage Cabinet, includes 4 hanging clips) each	ISHELFWR (see options below)	16.5"	22.5"		6 lbs
Mirror (optional, field installed)	MIR0022 (see options below)	12"		20"	2 lbs

INTEGRATE • Storage Cabinet

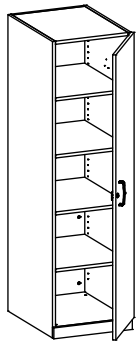

DESCRIPTION	PRODUCT NUMBER	WIDTH	DEPTH	HEIGHT	SHIP WGT
Storage Cabinet, Closed (includes 4 shelves)	I1867SCC (see options below)	18"	24"	65.5"	176 lbs
Shelf (for 18" wide Wardrobe or Storage Cabinet, includes 4 hanging clips) each	ISHELFWR (see options below)	16.5"	22.5"		6 lbs
Mirror (optional, field installed)	MIR0022 (see options below)	12"		20"	2 lbs

TO ORDER WARDROBE OR STORAGE CABINET:

Select the product number and then add the codes for the desired door position, hardware pull & laminate color.

For example, to order an Integrate Wardrobe (I1867WR), with Door Hang on right (R), Brushed Nickel Arch Pull (1), with Biltmore Cherry Laminate (BT), specify:

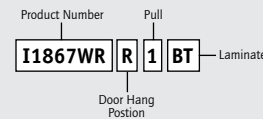

Door Hang

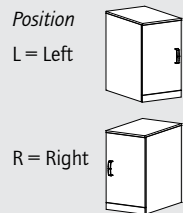

Pull

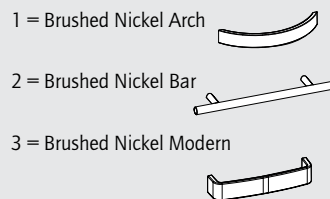

TO ORDER EXTRA SHELF (for Wardrobe or Storage Cabinet):

Using same options as above, specify:



Laminate (Base, Top and Top Trim)

Color	Base/Top	Top Trim	
Biltmore Cherry	= BT*	= CD	*Wood Ticked Laminates
Colombian Walnut	= CI*	= CB	match original smooth
Kensington Maple	= KE*	= CC	Laminates on pg. 54 of this Spec Guide and can be specified on Top Work Surface and Base Components.
Shaker Cherry	= SK*	= CG	
Studio Teak	= SU*	= CM	
Amber Cherry	= AB*	= AB	
Sterling Ash	= SA*	= SA	
Light Oak	= LO*	= LO	
Silver Oak	= SO*	= SO	
Buka Bark	= BK*	= BK	
Harvest Maple	= HM*	= HM	
Rio	= RI*	= RI	
Noble Mahogany	= NM	= NM	
White Twill	= WT	= WT	
Neural Twill	= NT	= NT	
Sarum Twill	= ST	= ST	
Graphite Twill	= GT	= GT	
Earthen Twill	= ET	= ET	See Complete Laminate List on pg. 54.
Fashion Gray	= RS	= RS	
Black	= AG	= AG	
Brite White	= FP	= FP	

NOTE:
Wardrobe includes Coat Rod & Single Adjustable Shelf.
Storage Cabinet includes 4 Adjustable Shelves.

Product dimensions shown in approximate inches. *All components available in matching OFG Harmony Casegoods laminate colors – see page 55 for more information.



INTEGRATE • Tables – Conference

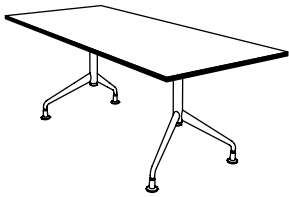

DESCRIPTION	PRODUCT NUMBER	WIDTH	DEPTH	HEIGHT	SHIP WGT
72" Conference Table (rectangular)	I7236CEFS	72"	36"	29"	240 lbs
96" Conference Table (rectangular)	I9642CEFS	96"	42"	29"	273 bs

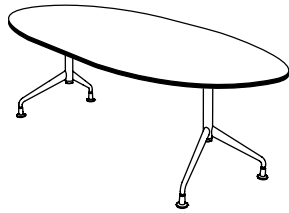

72" Conference Table (oval)	I72360TB	72"	36"	29"	240 lbs
96" Conference Table (oval)	I96420TB	96"	42"	29"	273 bs

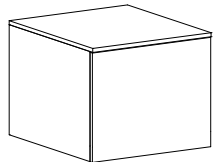

INTEGRATE • End Table

DESCRIPTION	PRODUCT NUMBER	WIDTH	DEPTH	HEIGHT	SHIP WGT
End Table	I22ET	22"	22"	18"	50 bs

- Conference Table Base available in Starlight Silver.
- Available with adjustable nylon glides or casters in black or white
- 72" & 96" tables include stiffener bar

END TABLE

- 32mm fabrication system assures precision construction and assembly
- Durable, high-pressure laminate
- Freestanding modular components
- Nylon-capped leveling glides
- Metal hardware & leveling hinges
- Engineered wood substrate (5/8" panels)
- Indoor Air Quality Certified to SCSEC10.3-2014 Conforms to the ANSI/BIFMA Furniture Emissions Standard

TO ORDER INTEGRATE CONFERENCE TABLES:

Select the product number and then add the codes for laminate top color, edge trim color & casters or glides.

For example, to order an Integrate 72" Conference Table (I7236CEFS), in Black (LB), Starlight Silver Base (34), Biltmore Cherry Top (BT) and Black Trim (AG), with Glides (N) specify:

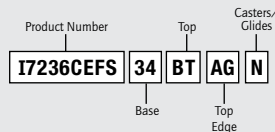

TO ORDER INTEGRATE END TABLE:

Select the product number and then add the codes for laminate base color, top color & top edge color.

For example, to order an Integrate End Table (I22ET), Shaker Cherry Base (SK), Brite White Top (FP) and Black Trim (AG) specify:

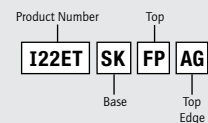

Casters/Glides

- 2 = Casters (2 Locking), Black
- 3 = Casters (2 Locking), White
- N = Glides

Conference Table Base

- 27 = Black
- 34 = Starlight Silver

Laminate (Base, Top and Top Trim)

Color	Base/Top	Top Trim
Biltmore Cherry	= BT*	= CD *Wood Ticked
Colombian Walnut	= CI*	= CB Laminates
Kensington Maple	= KE*	= CC match original
Shaker Cherry	= SK*	= CG smooth
Studio Teak	= SU*	= CM Laminates on
Amber Cherry	= AB*	= AB pg. 54 of this
Sterling Ash	= SA*	= SA Spec Guide and
Light Oak	= LO*	= LO can be specified
Silver Oak	= SO*	= SO on Top Work
Buka Bark	= BK*	= BK Surface
Harvest Maple	= HM*	= HM and Base
Rio	= RI*	= RI Components.
Noble Mahogany	= NM	= NM
White Twill	= WT	= WT
Neural Twill	= NT	= NT
Sarum Twill	= ST	= ST
Graphite Twill	= GT	= GT
Earthen Twill	= ET	= ET
Fashion Gray	= RS	= RS
Black	= AG	= AG
Brite White	= FP	= FP

See Complete Laminate List on pg. 54.

NOTE:

Conference Table Base available in:

- 27 = Black
- 34 = Starlight Silver

Caster/Glides Code:

- 2 = Casters (2 Locking), Black
- 3 = Casters (2 Locking), White
- N = Glides

Product dimensions shown in approximate inches. *All components available in matching OFG Harmony Casegoods laminate colors – see page 55 for more information.

INTEGRATE • Tables – Round

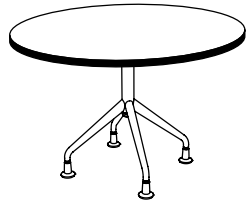

DESCRIPTION	PRODUCT NUMBER	WIDTH	HEIGHT	SHIP WGT
36" Round Table, Freestanding	I36RDTB	36"	29"	112 bs
42" Round Table, Freestanding	I42RDTB	42"	29"	135 lbs
48" Round Table, Freestanding	I48RDTB	48"	29"	161 lbs

INTEGRATE • Tables – Round, X-Base

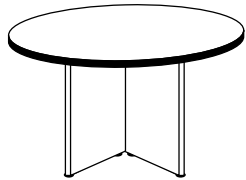

DESCRIPTION	PRODUCT NUMBER	WIDTH	HEIGHT	SHIP WGT
36" Round Table, X-Base Freestanding	I36RDTBX	36"	29"	120 bs
42" Round Table, X-Base Freestanding	I42RDTBX	42"	29"	136 lbs
48" Round Table, X-Base Freestanding	I48RDTBX	48"	29"	152 lbs

ROUND TABLE, X-BASE

- Base available in Starlight Silver.
- Available with adjustable nylon glides or casters in black or white
- 32mm fabrication system assures precision construction and assembly
- Durable, high-pressure laminate
- Freestanding modular components
- Nylon-capped leveling glides
- Metal hardware & leveling hinges
- Engineered wood substrate (1-1/8" work surfaces)
- 3/4" thick base legs
- Indoor Air Quality Certified to SCSEC10.3-2014 Conforms to the ANSI/BIFMA Furniture Emissions Standard

TO ORDER INTEGRATE ROUND TABLE:

Select the product number and then add the codes for laminate base color, top color, trim color and casters or glides.

For example, to order an Integrate 42" Round Table (I42RDTB), in Starlight Silver Base (34), with Biltmore Cherry Top (BT), Black Trim (AG) and Casters in Black (CB), specify:

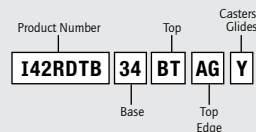

TO ORDER INTEGRATE ROUND TABLE WITH X-BASE:

Select the product number and then add the codes for laminate base color, top color & trim color (3/4" thick Base Legs).

For example, to order an Integrate 42" Round Table with X-Base (I42RDTBX), Biltmore Cherry Base (BT), Biltmore Cherry Top (BT) and Black Trim (AG) specify:

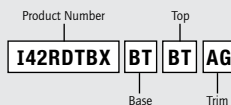

Casters/Glides

- Y = Casters, Black
- 1 = Casters, White
- 2 = Casters (2 Locking), Black
- 3 = Casters (2 Locking), White
- N = Glides

Round Table Base

- 27 = Black
- 34 = Starlight Silver

Laminate (Base, Top and Top Trim)

Color	Base/Top	Top Trim
Biltmore Cherry	= BT*	= CD *Wood Ticked
Colombian Walnut	= CI*	= CB Laminates
Kensington Maple	= KE*	= CC match original smooth
Shaker Cherry	= SK*	= CG Laminates on
Studio Teak	= SU*	= CM Spec Guide and can be specified on Top Work Surface and Base Components.
Amber Cherry	= AB*	= AB
Sterling Ash	= SA*	= SA
Light Oak	= LO*	= LO
Silver Oak	= SO*	= SO
Buka Bark	= BK*	= BK
Harvest Maple	= HM*	= HM
Rio	= RI*	= RI
Noble Mahogany	= NM	= NM
White Twill	= WT	= WT
Neural Twill	= NT	= NT
Sarum Twill	= ST	= ST
Graphite Twill	= GT	= GT
Earthen Twill	= ET	= ET
Fashion Gray	= RS	= RS
Black	= AG	= AG
Brite White	= FP	= FP

See Complete Laminate List on pg. 54.

NOTE:

Round Table Base available in:
27 = Black
34 = Starlight Silver

Caster/Glides Code:

- Y = Casters, Black
- 1 = Casters, White
- 2 = Casters (2 Locking), Black
- 3 = Casters (2 Locking), White
- N = Glides

Product dimensions shown in approximate inches. *All components available in matching OFG Harmony Casegoods laminate colors – see page 55 for more information.

INTEGRATE • Podiums

DESCRIPTION	PRODUCT NUMBER	WIDTH	DEPTH	HEIGHT	SHIP WGT
Podium, Freestanding (Mobile)	I2448FP	24"	16"	48"	145 lbs

DESCRIPTION	PRODUCT NUMBER	WIDTH	DEPTH	HEIGHT	SHIP WGT
Podium, Freestanding (Mobile) Flip-up, Multi Receptacle Extension Box includes: 2 grounded outlets, 2 USB connectors, 1 universal LAN data port, 1 phone port and a reset switch	I2448FHL	24"	16"	48"	145 lbs

Flip-up, Multi Receptacle Extension Box

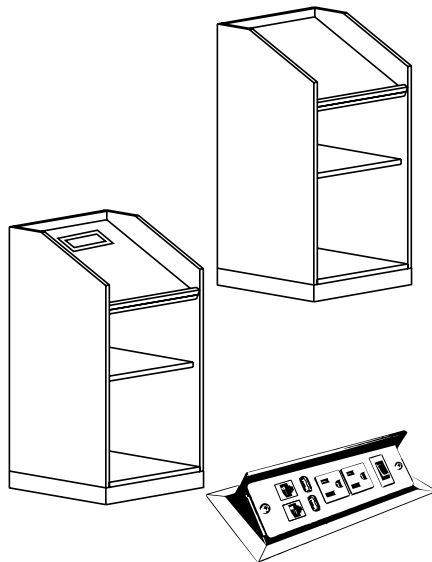

INTEGRATE • Marker Board

DESCRIPTION	PRODUCT NUMBER	WIDTH	DEPTH	HEIGHT	SHIP WGT
Marker Board w/Marker Tray	HMBT480332	48"	.75"	30"	35 lbs

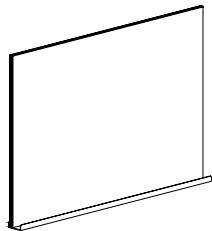

- Mobile Lectern/Podium
- 2 Locking Casters
- Pencil Lip to hold notes and writing instruments
- Adjustable Shelf
- Flip-up, Multi Receptacle Extension Box includes 2, 3-prong grounded electrical outlets, 2 connectors for USB-powered devices, 1 universal LAN data port, 1 phone port and a reset switch (includes 10' power cord)
- Field replaceable components
- 32mm fabrication system assures precision construction and assembly
- Durable, high-pressure laminate
- Engineered wood substrate (5/8" panels)
- Indoor Air Quality Certified to SCSECT10.3-2014 Conforms to the ANSI/BIFMA Furniture Emissions Standard

TO ORDER PODIUM:

Select the product number and then add the code for the desired laminate color.

For example, to order an Integrate Podium (I2448FP), in Black (AG), specify:

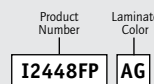

Laminate (Base, Top and Top Trim)

Color	Base/Top	Top Trim	
Biltmore Cherry	= BT*	= CD	*Wood Ticked
Colombian Walnut	= CI*	= CB	Laminates
Kensington Maple	= KE*	= CC	match original
Shaker Cherry	= SK*	= CG	smooth
Studio Teak	= SU*	= CM	Laminates on
Amber Cherry	= AB*	= AB	pg. 54 of this
Sterling Ash	= SA*	= SA	Spec Guide and
Light Oak	= LO*	= LO	can be specified
Silver Oak	= SO*	= SO	on Top Work
Buka Bark	= BK*	= BK	Surface
Harvest Maple	= HM*	= HM	and Base
Rio	= RI*	= RI	Components.
Noble Mahogany	= NM	= NM	
White Twill	= WT	= WT	
Neural Twill	= NT	= NT	
Sarum Twill	= ST	= ST	
Graphite Twill	= GT	= GT	
Earthen Twill	= ET	= ET	See Complete
Fashion Gray	= RS	= RS	Laminate List
Black	= AG	= AG	on pg. 54.
Brite White	= FP	= FP	

Product dimensions shown in approximate inches. *All components available in matching OFG Harmony Casegoods laminate colors – see page 55 for more information.

INTEGRATE • Magazine Rack & Mail Sorter

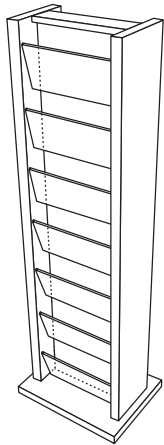

DESCRIPTION	PRODUCT NUMBER	WIDTH	DEPTH	HEIGHT	SHIP WGT
Magazine Rack 2-sided with 7 clear plexiglas slots on each side with rotating base	I5217MAGRACK	17"	17"	52.5"	84 lbs

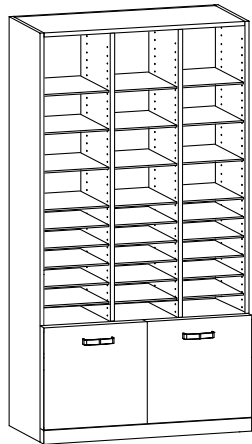

DESCRIPTION	PRODUCT NUMBER	WIDTH	DEPTH	HEIGHT	SHIP WGT
Mail Sorter (27 openings – includes shelves & pins and 24 label holders)	IMSC361666	36"	16"	65.5"	240 lbs

TO ORDER MAGAZINE RACK:

Select the product number and then add the code for the desired base laminate and top & trim color.

For example, to order an Integrate Magazine Rack (I5217MAGRACK), in Biltmore Cherry Base Laminate (BT) and Black Top & Trim (AG), specify:

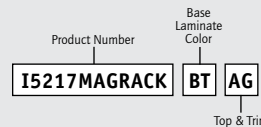

TO ORDER MAIL SORTER:

Select the product number and then add the code for the desired hardware pull & base laminate color.

For example, to order an Integrate Mail Sorter (IMSC361666), with Brushed Nickel Modern Pull (3) in Shaker Cherry (SK), specify:

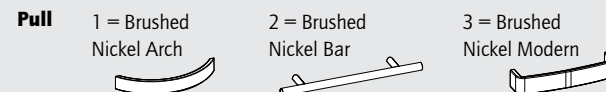
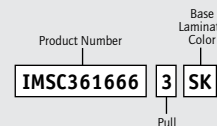

Laminate (Base, Top and Top Trim)

Color	Base/Top	Top Trim	
Biltmore Cherry	= BT*	= CD	*Wood Ticked Laminates
Colombian Walnut	= CI*	= CB	match original smooth
Kensington Maple	= KE*	= CC	Laminates on pg. 54 of this Spec Guide and can be specified on Top Work Surface and Base Components.
Shaker Cherry	= SK*	= CG	
Studio Teak	= SU*	= CM	
Amber Cherry	= AB*	= AB	
Sterling Ash	= SA*	= SA	
Light Oak	= LO*	= LO	
Silver Oak	= SO*	= SO	
Buka Bark	= BK*	= BK	
Harvest Maple	= HM*	= HM	
Rio	= RI*	= RI	
Noble Mahogany	= NM	= NM	
White Twill	= WT	= WT	
Neural Twill	= NT	= NT	
Sarum Twill	= ST	= ST	See Complete Laminate List on pg. 54.
Graphite Twill	= GT	= GT	
Earthen Twill	= ET	= ET	
Fashion Gray	= RS	= RS	
Black	= AG	= AG	
Brite White	= FP	= FP	

MAGAZINE RACK

- 2-sided with 7 clear plexiglas slots on each side (total = 14)
- Slot panels in clear plexiglas only
- Rotating base with nylon-capped leveling glides

MAIL SORTER

- 24 adjustable shelves
- Includes 24 label holders
- Soft-close hinges
- Metal-capped glides

Product dimensions shown in approximate inches. *All components available in matching OFG Harmony Casegoods laminate colors – see page 55 for more information.

INTEGRATE • Work Surfaces & Seat Cushions

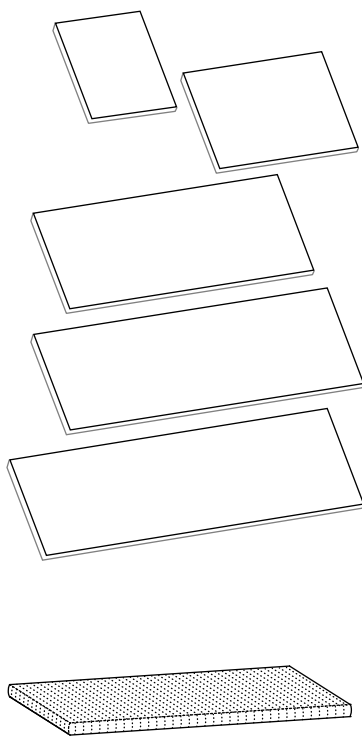

DESCRIPTION	PRODUCT NUMBER	WIDTH	DEPTH	HEIGHT	SHIP WGT
Work Surface, 16 x 24" (for Single Pedestal or single credenza) each	I1624WS (see options below)	16"	24"	1.125"	18 lbs
Work Surface, 18 x 24" (for Single Pedestal or single credenza) each	I1824WS (see options below)	18"	24"	1.125"	20 lbs
Work Surface, 32 x 24" (for Pedestal + Pedestals or credenza base single door unit + another credenza base) each	I3224WS (see options below)	32"	24"	1.125"	25 lbs
Work Surface, 36 x 24" (for Credenza base double door or mixed credenza base single) each	I3624WS (see options below)	36"	24"	1.125"	28 lbs
Work Surface, 48 x 24" (for Pedestals + Pedestal + Pedestal) each	I4824WS (see options below)	48"	24"	1.125"	33 lbs
Work Surface, 54 x 24" (for Single credenza base + Double credenza base + Single credenza base) each	I5424WS (see options below)	54"	24"	1.125"	35 lbs
Work Surface, 60 x 24" (for Single credenza base + Double credenza base + Single credenza base) each	I6024WS (see options below)	60"	24"	1.125"	37 lbs
Work Surface, 68 x 24" (for Single credenza base + Double credenza base + Single credenza base) each	I6824WS (see options below)	68"	24"	1.125"	40 lbs
Work Surface, 72 x 24" (for Credenza base double door or mixed credenza base double) each	I7224WS (see options below)	72"	24"	1.125"	43 lbs

DESCRIPTION	PRODUCT NUMBER	WIDTH	DEPTH	HEIGHT	SHIP WGT
Seat Cushion, 36 x 18.75" (for Low Credenza Base)	I36SC (see options below)	36"	18.75"	1.25"	8 lbs
TEXTILE GRADE #1	TEXTILE GRADE #2	TEXTILE GRADE #3	TEXTILE GRADE #4	TEXTILE GRADE #5	TEXTILE GRADE #6

*Refer to Mayer-Paetz Upholstery Fabrics for Optional Seat Textile Choices (available fabric and grade.)

- Non-handed/reconfigurable
- Field replaceable components
- 32mm fabrication system assures precision construction and assembly
- Durable, high-pressure laminate
- Engineered wood substrate (1-1/8" work surfaces)
- Indoor Air Quality Certified to SCSEC10.3-2014 Conforms to the ANSI/BIFMA Furniture Emissions Standard

SEAT CUSHION

- Refer to Mayer-Paetz Upholstery Fabrics for Optional Seat Textile Choices (available fabric and grade.)
- Non-skid backing

TO ORDER WORK SURFACE:

Select the product number and then add the codes for the desired laminate top color & top trim color.

For example, to order an Integrate Work Surface, 72 x 24" (I7224WS), with Biltmore Cherry Top (BT), and Black Trim (AG), specify:

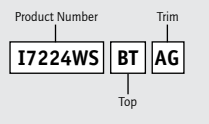

TO ORDER SEAT CUSHION:

Refer to Mayer-Paetz Upholstery Fabrics for Optional Seat Textile Choices (available grade and fabric.)

For example, to order an Integrate Seat Cushion, 36 x 18.75" (I36SC), with Textile Grade #1 (1), in Basic/Pumice Fabric (FAB9231), specify:

Note: COM (Customer's Own Material) Option is available. For more information or assistance, contact your UNICOR/OFG Sales Representative

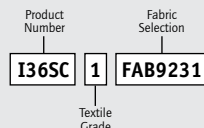

Laminate (Base, Top and Top Trim)

Color	Base/Top	Top Trim	Color	Base/Top	Top Trim
Biltmore Cherry	= BT*	= CD	Rio	= RI*	= RI
Colombian Walnut	= CI*	= CB	Noble Mahogany	= NM	= NM
Kensington Maple	= KE*	= CC	White Twill	= WT	= WT
Shaker Cherry	= SK*	= CG	Neural Twill	= NT	= NT
Studio Teak	= SU*	= CM	Sarum Twill	= ST	= ST
Amber Cherry	= AB*	= AB	Graphite Twill	= GT	= GT
Sterling Ash	= SA*	= SA	Earthen Twill	= ET	= ET
Light Oak	= LO*	= LO	Fashion Gray	= RS	= RS
Silver Oak	= SO*	= SO	Black	= AG	= AG
Buka Bark	= BK*	= BK	Brite White	= FP	= FP
Harvest Maple	= HM*	= HM			

*Wood Ticked Laminates match original smooth Laminates on pg. 54 of this Spec Guide and can be specified on Top Work Surface and Base Components.

See Complete Laminate List on pg. 54.

Product dimensions shown in approximate inches. *All components available in matching OFG Harmony Casegoods laminate colors – see page 55 for more information.

INTEGRATE • Tackboards

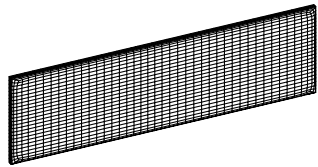

DESCRIPTION			PRODUCT NUMBER		WIDTH	DEPTH	HEIGHT	SHIP WGT
Tackboard (used on 60" Overhead)			I58TK <small>(see options below)</small>		58"	1"	16"	13 lbs
TEXTILE GRADE #1	TEXTILE GRADE #2	TEXTILE GRADE #3	TEXTILE GRADE #4	TEXTILE GRADE #5	TEXTILE GRADE #6			
PANEL GRADE #1	PANEL GRADE #2	PANEL GRADE #3						

*Refer to Mayer-Paetz Upholstery Fabrics for Optional Seat Textile Choices (available fabric and grade.)

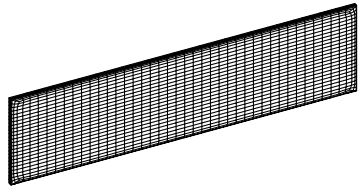

DESCRIPTION			PRODUCT NUMBER		WIDTH	DEPTH	HEIGHT	SHIP WGT
Tackboard (used on 66" Overhead)			I64TK <small>(see options below)</small>		64"	1"	16"	14 lbs
TEXTILE GRADE #1	TEXTILE GRADE #2	TEXTILE GRADE #3	TEXTILE GRADE #4	TEXTILE GRADE #5	TEXTILE GRADE #6			
PANEL GRADE #1	PANEL GRADE #2	PANEL GRADE #3						

*Refer to Mayer-Paetz Upholstery Fabrics for Optional Seat Textile Choices (available fabric and grade.)

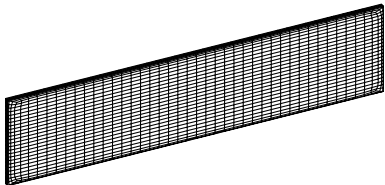

DESCRIPTION			PRODUCT NUMBER		WIDTH	DEPTH	HEIGHT	SHIP WGT
Tackboard (used on 72" Overhead)			I70TK <small>(see options below)</small>		70"	1"	16"	15 lbs
TEXTILE GRADE #1	TEXTILE GRADE #2	TEXTILE GRADE #3	TEXTILE GRADE #4	TEXTILE GRADE #5	TEXTILE GRADE #6			
PANEL GRADE #1	PANEL GRADE #2	PANEL GRADE #3						

*Refer to Mayer-Paetz Upholstery Fabrics for Optional Seat Textile Choices (available fabric and grade.)

DESCRIPTION	PRODUCT NUMBER
Bracket to Wall-Mount Tackboard (set of 4) mounts 1 Tackboard – one size fits all	BKT551

TO ORDER TACKBOARD:

Select the product number and then add the codes for the desired textile – refer to Mayer-Paetz Upholstery Fabrics for Optional Seat Textile Choices (available fabric and grade.)

For example, to order an Integrate Tackboard to use with 60" Overhead (I58TK), with Textile Grade #1 (1), in Basic/Pumice Fabric (FAB9231), specify:

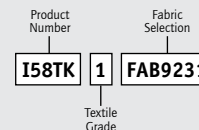

- Refer to Mayer-Paetz Upholstery Fabrics for Optional Seat Textile Choices (available fabric and grade.)
- Crypton fabric cannot be specified for Tackboard textile.
- Optional brackets available for wall mounting Tackboards (one size fits all)

Product dimensions shown in approximate inches. *All components available in matching OFG Harmony Casegoods laminate colors – see page 55 for more information.

RELEVATE • Screens

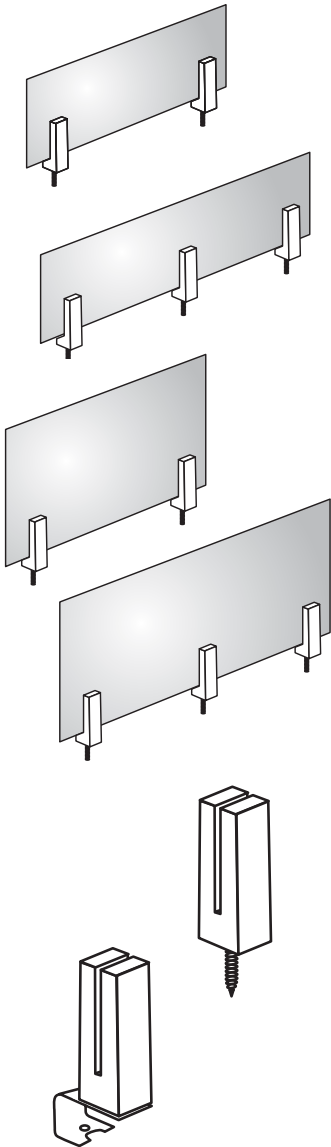

DESCRIPTION	PRODUCT NUMBER	WIDTH	DEPTH	HEIGHT	SHIP WGT
Desktop Acrylic Screen – 12"H (requires 2 Desktop Screen Supports, specified separately)	KDTP2412	21"	.25"	12"	2 lbs
	KDTP3012	27"	.25"	12"	3 lbs
	KDTP3612	33"	.25"	12"	4 lbs
	KDTP4212	39"	.25"	12"	5 lbs
	KDTP4812	45"	.25"	12"	6 lbs
Desktop Acrylic Screen – 12"H (requires 3 Desktop Screen Supports, specified separately)	KDTP6012	57"	.25"	12"	8 lbs
	KDTP6612	63"	.25"	12"	9 lbs
	KDTP7212	69"	.25"	12"	10 lbs
Desktop Acrylic Screen – 18"H (requires 2 Desktop Screen Supports, specified separately)	KDTP2418	21"	.25"	18"	3 lbs
	KDTP3018	27"	.25"	18"	5 lbs
	KDTP3618	33"	.25"	18"	6 lbs
	KDTP4218	39"	.25"	18"	8 lbs
	KDTP4818	45"	.25"	18"	9 lbs
Desktop Acrylic Screen – 18"H (requires 3 Desktop Screen Supports, specified separately)	KDTP6018	57"	.25"	18"	12 lbs
	KDTP6618	63"	.25"	18"	14 lbs
	KDTP7218	69"	.25"	18"	15 lbs

DESCRIPTION	PRODUCT NUMBER	FINISH	WIDTH	DEPTH	HEIGHT	SHIP WGT
Desktop Screen Support – 6"H Surface Mount	KDTPSAL	Starlight Silver	1.5"	1.5"	6"	1 lbs
	KDTPSB	Black	1.5"	1.5"	6"	1 lbs
	KDTPSC	Charcoal	1.5"	1.5"	6"	1 lbs
Desktop Screen Support – 6"H Clamp Mount	KDTPCA	Starlight Silver	1.5"	1.5"	6"	1 lbs
	KDTPCB	Black	1.5"	1.5"	6"	1 lbs
	KDTPCC	Charcoal	1.5"	1.5"	6"	1 lbs

- 1/4" frosted acrylic
- Supports are surface or clamp mounted (field installed)

NOTE:
21–45" wide require 2 desk top screen supports, specified separately.
57–69" wide require 3 desk top screen supports, specified separately.

Product dimensions shown in approximate inches. *All components available in matching OFG Harmony Casegoods laminate colors – see page 55 for more information.

INTEGRATE • Shelves

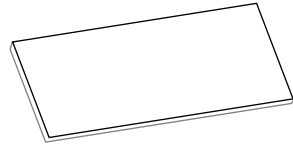

DESCRIPTION	PRODUCT NUMBER	WIDTH	DEPTH	SHIP WGT
Shelf (for 16" wide Credenza Base, includes 4 hanging clips) each	I16SHELF (see options below)	14.5"	22.5"	6 lbs
Shelf (for 36" wide Credenza Base, includes 4 hanging clips) each	I36SHELF (see options below)	34.5"	22.5"	10 lbs
Shelf (for 36" wide Credenza Low Base, includes 4 hanging clips) each	ISHELCB (see options below)	34.5"	17"	10 lbs
Shelf (for 36" wide Bookcase, includes 4 hanging clips) each	ISHELFBK (see options below)	34.5"	15"	10 lbs
Shelf (for 24" deep Side Shelving, includes 4 hanging clips) each	ISHELFSS (see options below)	22.5"	15.5"	6 lbs
Shelf (for 36" wide Upper Shelves, includes 4 hanging clips) each	I36SHELFUS (see options below)	34.5"	13"	10 lbs
Shelf (for 16" wide Upper Shelves, includes 4 hanging clips) each	I16SHELFUS (see options below)	14.5"	13.5"	6 lbs
Shelf (for 18" wide Upper Shelves, Open, includes 4 hanging clips) each	I18SHELFUS (see options below)	16.5"	13.5"	10 lbs
Shelf (for 18" wide Wardrobe or Storage Cabinet, includes 4 hanging clips) each	ISHELFWR (see options below)	16.5"	22.5"	6 lbs

For 24" Deep Upper Shelving Units

Shelf (for 16W x 24" D Upper Shelves, includes 4 hanging clips) each	I1624SHELFUS (see options below)	14.5"	23.5"	11 lbs
Shelf (for 18W x 24" D Upper Shelves, includes 4 hanging clips) each	I1824SHELFUS (see options below)	16.5"	23.5"	12 lbs
Shelf (for 36W x 24" D Upper Shelves, includes 4 hanging clips) each	I3624SHELFUS (see options below)	34.5"	23.5"	16 lbs

For Credenza Base

Shelf (for 36W x 24" D Upper Shelves, includes 4 hanging clips) each	I3624SHELFUS (see options below)	34.5"	23.5"	16 lbs
---	-------------------------------------	-------	-------	--------

- Non-handed/reconfigurable
- Field replaceable components
- 32mm fabrication system assures precision construction and assembly
- Durable, high-pressure laminate
- Engineered wood substrate (5/8" work surfaces)
- Indoor Air Quality Certified to SCSEC10.3-2014 Conforms to the ANSI/BIFMA Furniture Emissions Standard

TO ORDER EXTRA SHELVING:

Select the product number and then add the codes for the desired laminate shelf color.

For example, to order an Integrate Shelf, for 16" wide Credenza Base (I16SHELF), in Brite White (FP), specify:

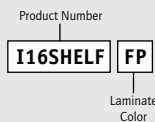

Laminate (Base, Top and Top Trim)

Color	Base/Top	Top Trim	Color	Base/Top	Top Trim
Biltmore Cherry	= BT*	= CD	Rio	= RI*	= RI
Colombian Walnut	= CI*	= CB	Noble Mahogany	= NM	= NM
Kensington Maple	= KE*	= CC	White Twill	= WT	= WT
Shaker Cherry	= SK*	= CG	Neural Twill	= NT	= NT
Studio Teak	= SU*	= CM	Sarum Twill	= ST	= ST
Amber Cherry	= AB*	= AB	Graphite Twill	= GT	= GT
Sterling Ash	= SA*	= SA	Earthen Twill	= ET	= ET
Light Oak	= LO*	= LO	Fashion Gray	= RS	= RS
Silver Oak	= SO*	= SO	Black	= AG	= AG
Buka Bark	= BK*	= BK	Brite White	= FP	= FP
Harvest Maple	= HM*	= HM			

*Wood Ticked Laminates match original smooth Laminates on pg. 54 of this Spec Guide and can be specified on Top Work Surface and Base Components.
See Complete Laminate List on pg. 54.

Product dimensions shown in approximate inches. *All components available in matching OFG Harmony Casegoods laminate colors – see page 55 for more information.

INTEGRATE • Hardware

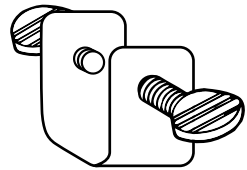

DESCRIPTION	PRODUCT NUMBER	INSIDE DIMENSION	SHIP WGT
Ganging Bracket (2 per order, includes Thumb Screws. To connect ganged units)	BKT969	1.625" (accommodates 2 - .625" panels)	1 lbs

*Pair included in BOM with multiple units of Credenzas, Wardrobes, Laterals and Bookcases – order separately if needed.

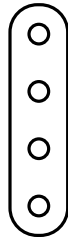

DESCRIPTION	PRODUCT NUMBER	WIDTH	LENGTH	SHIP WGT
Brace (2 per order, includes Mounting Screws. To connect/stabilize units)	BKT1983	.75"	3"	1 lbs

* Pair included in BOM of all Upper Shelving Units – order separately if needed.

- *Ganging Bracket used to connect Credenzas, Wardrobes, Laterals and Bookcases*
- *Brace used to connect and stabilize Upper Shelving Units to Base*

NOTE:

Ganging Bracket pair included in BOM with multiple units of Credenzas, Wardrobes, Laterals and Bookcases.
Brace pair included in BOM of all Upper Shelving Units.

Product dimensions shown in approximate inches. *All components available in matching OFG Harmony Casegoods laminate colors – see page 55 for more information.

INTEGRATE • Accessories

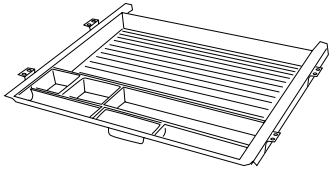

DESCRIPTION	PRODUCT NUMBER	WIDTH	DEPTH	HEIGHT	SHIP WGT
Center Drawer, Black	HWS1170	21"	19"	2"	5 lbs

*See OFG System catalog PDF for other options



DESCRIPTION	PRODUCT NUMBER	WIDTH	DEPTH	HEIGHT	SHIP WGT
44" LED Task Light	TLELED40DMS	44"	2.5"	1"	5 lbs

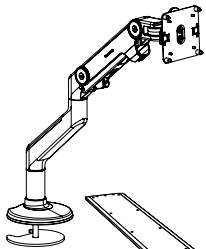

DESCRIPTION	
Monitor Arm	See ErgoTools_M8-Monitor Arm PDF for ordering details & options

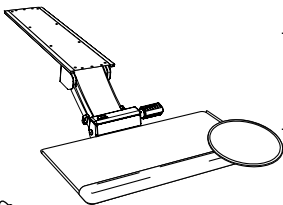

Keyboard and Mouse Pad	See ErgoTools_Keyboard PDF for ordering details & options
-------------------------------	---

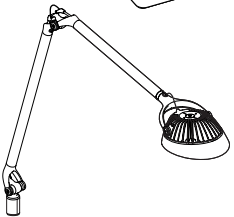

Element Light	See ErgoTools_ElementLights PDF for ordering details & options
----------------------	--

LED TASK LIGHT FEATURES

- Low voltage
- Integral dimmer control
- LEED credit eligibility
- Energy Star rated
- 6' power cord
- UL Listed

TO ORDER:

Consult the specific Ergo Tools PDFs for details and options.

For information or assistance, contact your UNICOR/OFG Sales Representative.

Product dimensions shown in approximate inches. *All components available in matching OFG Harmony Casegoods laminate colors – see page 55 for more information.

INTEGRATE • Laminate Offerings

All components shown in the Integrate product line can be ordered using the laminate selections below. Follow the “How To Order” instructions on specific pages to build your Product Number.

WOOD LAMINATES (Ticked Finish)

Color	Base & Top	Top Trim
Biltmore Cherry	= BT*	= CD
Colombian Walnut	= CI*	= CB
Kensington Maple	= KE*	= CC
Shaker Cherry	= SK*	= CG
Studio Teak	= SU*	= CM

* These Wood Ticked Finish Laminates match Smooth Finish Laminates in this Spec Guide and can be specified on Top Work Surface & Base surfaces.

NEW WOOD LAMINATES (Ticked Finish)

Color	Base & Top	Top Trim
Amber Cherry	= AB*	= AB
Sterling Ash	= SA*	= SA
Light Oak	= LO*	= LO
Silver Oak	= SO*	= SO
Buka Bark	= BK*	= BK
Harvest Maple	= HM*	= HM
Rio	= RI*	= RI

* These Wood Ticked Finish Laminates can be specified on Top Work Surface & Base surfaces.

NEW PATTERN LAMINATES (Flat Smooth Finish)

Color	Base & Top	Top Trim
White Twill	= WT	= WT
Neural Twill	= NT	= NT
Sarum Twill	= ST	= ST
Graphite Twill	= GT	= GT
Earthen Twill	= ET	= ET

SOLID LAMINATES (Flat Smooth Finish)

Color	Base & Top	Top Trim
Fashion Gray	= RS	= RS
Black	= AG	= AG
Brite White	= FP	= FP

LEGACY COLLECTION WOOD LAMINATES (Flat Smooth Finish)

Color	Base & Top	Top Trim
Biltmore Cherry	= CD	= CD
Colombian Walnut	= CB	= CB
Kensington Maple	= CC	= CC
Noble Mahogany	= NM	= NM
Shaker Cherry	= CG	= CG
Silver Alchemy	= CN	= CN
Studio Teak	= CM°	= CM
Yarrow	= CK°	= CK

° NOT AVAILABLE for Top Work Surface.

- Non-handed/reconfigurable
- Field replaceable components
- Matching and contrasting finishes
- Wire/cable management
- Lockable storage components
- Easy access leveling
- 32mm fabrication system assures precision construction and assembly
- Durable, high-pressure laminate
- Freestanding modular components
- Metal hardware & leveling hinges
- Birch plywood drawer construction
- Composite wood substrate (1 1/8" work surfaces, 5/8" panels)
- All file drawers have central locking mechanism
- Indoor Air Quality Certified to SCSECT10.3-2014 Conforms to the ANSI/BIFMA Furniture Emissions Standard

INTEGRATE • Harmony Laminate Option

All components shown in the Integrate product line can be ordered to match existing OFG Harmony Casegoods furniture.

Harmony Casegoods Laminate available:

COLOR (BASE & TOP)	CODE
• Pennsylvania Cherry	BB (91536-58)
• Ginger Root Maple	BE (7288-58)
• Fog	AJ (961-58)
• Mahogany	BC (91818-58)
• Washington Oak	BD (91784-58)
• Vosges Pearwood	BF (1150-58)
COLOR (TRIM)	CODE
• Black	AG

NOTE: Trim on Base Units will always default to Black (AG).

Specify laminate colors as shown in example below.

- Non-handed/reconfigurable
- Field replaceable components
- Matching and contrasting finishes
- Wire/cable management
- Lockable storage components
- Easy access leveling
- 32mm fabrication system assures precision construction and assembly
- Durable, high-pressure laminate
- Freestanding modular components
- Metal hardware & leveling hinges
- Birch plywood drawer construction
- Composite wood substrate (1 1/8" work surfaces, 5/8" panels)
- All file drawers have central locking mechanism
- Indoor Air Quality Certified to SCSEC10.3-2014 Conforms to the ANSI/BIFMA Furniture Emissions Standard

TO ORDER:

Select the product number and then add the codes for the desired position & style of pedestals, hardware pull, laminate base color, top color & trim color.

For example, to order an Integrate 60" Double Pedestal Desk (160DKDP), Two File Drawer Pedestal on left (L1) and Pencil, Box, File Pedestal on right (R2), Brushed Nickel Arch Pull (1), Mahogany Base (BC), Mahogany Top (BC) and Black Trim (AG), specify:

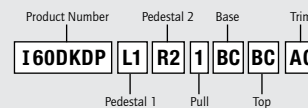

Color	Base/Top	Top Trim
Biltmore Cherry	= BT*	= CD *Wood Ticked Laminates
Colombian Walnut	= CI*	= CB match original smooth
Kensington Maple	= KE*	= CC Laminates on pg. 54 of this Spec Guide and can be specified on Top Work Surface and Base Components.
Shaker Cherry	= SK*	= CG
Studio Teak	= SU*	= CM
Amber Cherry	= AB	= AB
Noble Mahogany	= NM	= NM
Sterling Ash	= SA	= SA
Light Oak	= LO	= LO
Silver Oak	= SO	= SO
Buka Bark	= BK	= BK
Harvest Maple	= HM	= HM
Rio	= RI	= RI
White Twill	= WT	= WT
Neural Twill	= NT	= NT
Sarum Twill	= ST	= ST
Graphite Twill	= GT	= GT
Earthen Twill	= ET	= ET
Fashion Gray	= RS	= RS
Black	= AG	= AG
Brite White	= FP	= FP

Pedestal

Position	Style
L = Left	1 = Two file drawers
R = Right	2 = Pencil, box, file

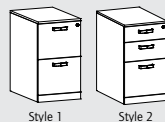

Pull

1 = Brushed Nickel Arch	3 = Brushed Nickel Modern
2 = Brushed Nickel Bar	6 = Black Harmony

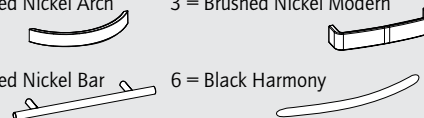

Product dimensions shown in approximate inches. *All components available in matching OFG Harmony Casegoods laminate colors

How To Order

By Internet

We're ready to take your electronic order. See us at:

www.unicor.gov/ofg

By Phone

Use your government credit card and call UNICOR toll free at:

(800) 827-3168

By Fax

Fax your purchase order 24 hours a day to:

(859) 254-9390 Standard Orders

(859) 254-9048 Credit Cards

By Mail

Send your purchase order to:

**UNICOR
Customer Service Center
P.O. Box 13640
Lexington, KY 40577-1670**

Customer Service

For information about products, prices or to request catalogs, call UNICOR Customer Service at (800) 827-3168, Monday–Friday, from 7:45 a.m. to 4:00 p.m. EST or leave a message at other times. To locate your local OFG Sales Representative, go to unicor.gov/OFGSalesReps.aspx



Credit Card Order Form

FAX orders to (859) 254-9048 or call (800) 827-3168. Order online at www.unicor.gov/ofg.

SHIPPING ADDRESS (NO POST OFFICE BOXES PLEASE)

NAME _____

TITLE _____

AGENCY _____

STREET _____

CITY _____ STATE _____ ZIP _____

TELEPHONE () _____ FAX NUMBER () _____

E-MAIL _____

CREDIT CARD # _____ EXPIRATION DATE _____

SIGNATURE _____ DATE _____

FAX NUMBER MUST BE INCLUDED

Please be sure that all information is complete to avoid delaying your order.

PRODUCT NUMBER	DESCRIPTION	COLOR	QUANTITY	UNIT PRICE	TOTAL
Note: For shipments outside the contiguous U.S., freight will be based upon rates at the time of delivery. <i>Thank you for your order.</i>				Subtotal	
				Overseas Shipping	
				TOTAL	