



# **InTELCOM™ Services Ltd**

## **Company Presentation**

***Solutions in Telecommunications & Security***

# InTELCOM Products & Services

- Antennas
- Broadcasting
- RF Products
- Data Solutions
- Milspec and Rugged Solutions
- Getac Rugged Computers
- Fibre Products
- Low Frequency and DC Cable
- Wireless Linking
- RF Transmission Infrastructure
- Security Devices
- Test & Measurement
- Transport Products

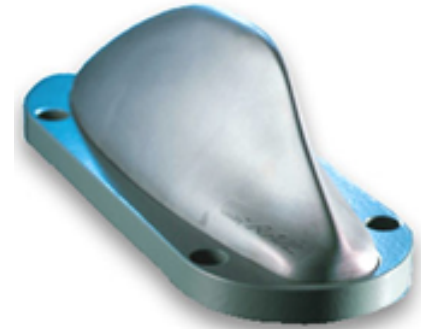

## HUBER+SUHNER Connectors

- Connector Plating Options
  - Gold
  - Silver
  - SUCOPLATE®
  - SUCOPRO
- Waterproof outdoor connectors
- Connectors are compatible with H+S cables and equivalent cables from others.
- Substantial range of cable stripping and connector assembly tools.
- Lightning protection.



# HUBER+SUHNER CABLES

- Coaxial
  - SPUMA RS FR Series
  - Microwave
  - Test Cables
  - SUCOFEED
- Low Power
  - RADOX® MFH-S Multi-core
  - RADOX® 125 2nd Gen Cables
  - Battery Cables
  - EV Solutions
  - Radox® Power & Control Cables
- Fibre Optic
  - Indoor
  - Outdoor
  - Armoured/Rugged

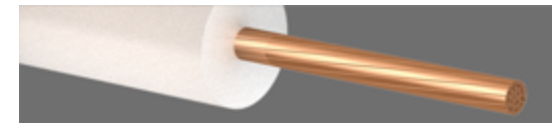
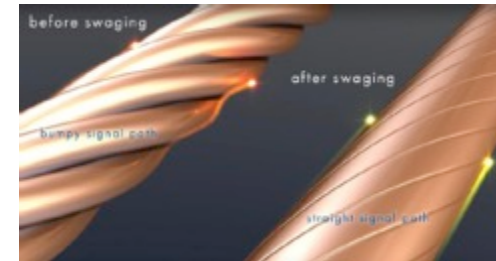

# Cable Assemblies



- Coax Cables
- Data Cables
- Customised options
- Small/Large Volumes
- DC & Signal Mix
- Repairs

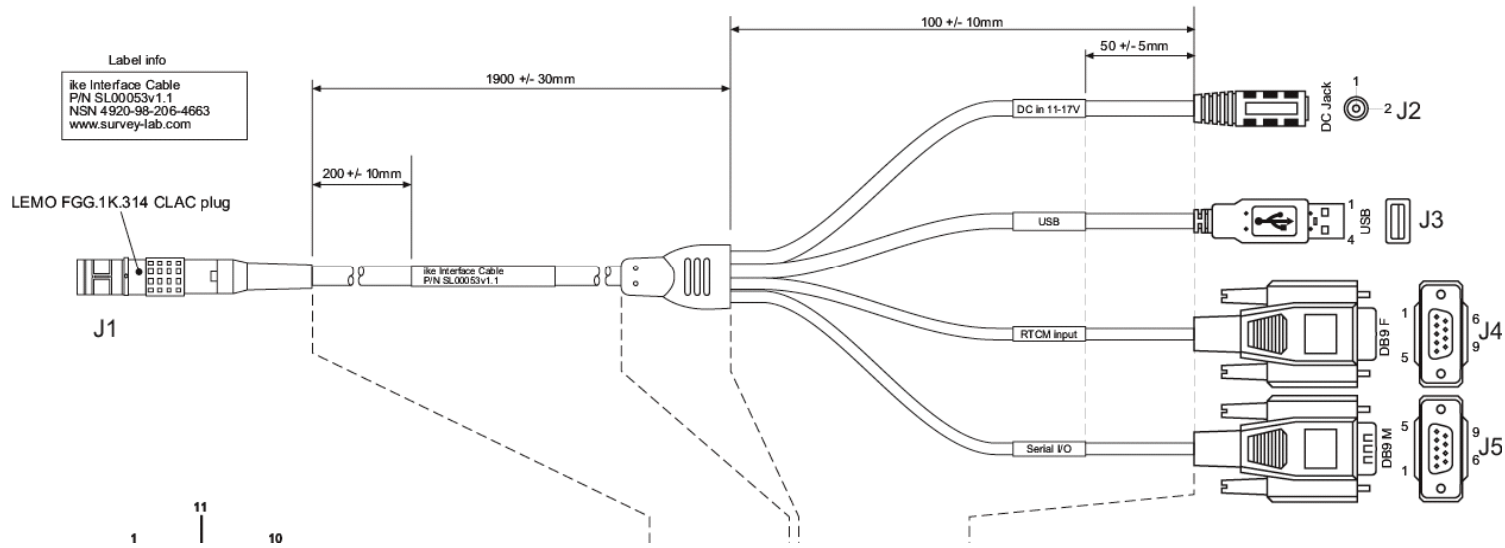

# Installation Materials



- Cable Clamps
  - Calibrated clamps
  - Combination fibre/DC
- Earthing Kits
- Wall Entries
- Waterproofing\*
- Heatshrink
  - Adhesive lined
  - Flame retardant

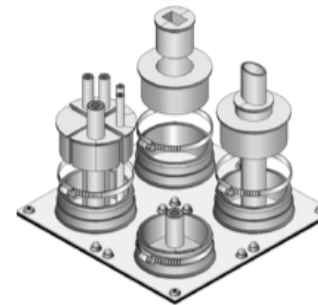

\*Custom Tape Kits  
Made to order



# Antennas (cont'd)



**TRIVAL  
antenne**

- Vehicle Antennas
- Manpack Antennas
- Tactical Antennas
- Base Station
- Marine Antennas
- GPS



## Alaris Holdings Group



- Parabolic
- Directional
- Flat Panel
- Military Antennas
- Vehicle Antennas
- Manpack Antennas



**COBHAM**

- Commercial
- Military
- Satellite
- Security
- 100 MHz to 40 GHz



- Sectoral & Omnidirectional
- Panels, Parabolics & Yagis
- 700 MHz to 5700 MHz



790 - 960	
790 - 896	870 - 960
H92° V10.4°	H87° V10.1°
Fixed Tilt	Fixed Tilt
0°, 2°, 4°, 6°	0°, 2°, 4°, 6°



- Broadband
- Military (Airborne, Ground, Naval)
- RFID
- Indoor & Outdoor
- Subscriber and Base Station

# Antennas



- GPS & GNSS antennas
- IBC / DAS antennas
- mm-wave antennas (60-80GHz)
- Vehicle antennas
- Special Communications Ant
- WLAN / WIFI antennas
  - MIMO



AMP s.r.l. formally **XGeritel**



D: 0,6m ( ≈2ft)  
MOD: GHP06  
FREQ.RANGE: 5 to 26GHz



Waveguide transitions  
and components



Dividers and filters



# Attenuators, Terminations, Frequency Sensitive Components



- Coaxial Attenuators
- Coaxial Terminations
- Directional Couplers
- Power Dividers
- Bias Tees
- Hybrid Couplers
- Isolators and Circulators
- Filters
- Duplexers

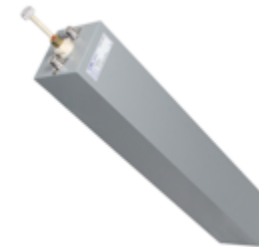

# Test & Measurement



- Precision Test Cables
- Precision Connectors and Adapters
- Precision Terminations and Attenuators
- Phase shifters and filters
- Up to 80 GHz
- New Sucoflex 500 test assemblies



- Handheld Spectrum Analysers to 10 GHz
- Antennas 380 MHz to 35 GHz
- EMC/EMI tests up to 30MHz
- RF Shielding
- Remote Logging

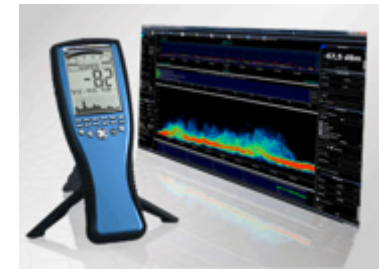

# BTS Antenna Mount



# Wireless Linking Solutions

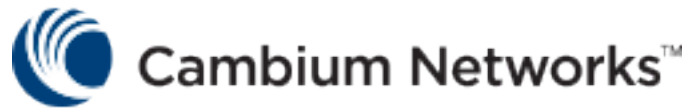

- Point to Point; Point to Multipoint
- Unique Long Reach and NLOS performance
- Licensed & Unlicensed Bands
- 60 GHz cnWave
- ePMP™ Range
- PTP450\*
- PTP550
- PTP670
- PTP700
- Licensed Bands 6 to 38 GHz
- PTP820/850 (All outdoor / Split unit)



- Wi-Fi Coverage (indoor/outdoor/cloud managed)
- cnPilot Cloud Managed Routers
- cnMatrix Enterprise Switches
- cnReach Products for IoT
- cnMaestro software platform for secure, end-to-end network control
- Bridge-in-a-Box
- cnPilot Xirrus



\* Optional  
ATEX/HAZLOC certified models

# Rugged Mobile Computing - Tablets



ZX70 (7") NOTE 1  
Rugged Tablet  
Android 7.1



EX80 (8") NOTE 2  
Rugged Tablet (for Oil & Gas)  
Windows 10



T800 (8.1") NOTE 1  
Rugged Tablet  
Windows 10



UX10 (10") NOTE 1  
Rugged Tablet  
Windows 10



F110 (11.6") NOTE 1  
Rugged Tablet  
Windows 10



K120 (12.5") NOTE 1  
Rugged Tablet  
Windows 10



The Getac Select® Programme is available for low volume customers (<10 units) and provides a range of pre-configured solutions built around industry requirements.

NOTE 1: These models are available in ATEX & IEC versions  
NOTE 2: This model is for extremely hazardous environments



# Rugged Solutions Using Getac



UX10 (10")



T800 (8.1")



F110 (11.6")



Havis Dock



Isolated Supply



# Rugged Mobile Computing - Laptops



Getac



V110 (11.6") Fully Rugged Convertible Tablet/Notebook Windows 10 Pro



S410 (14") Semi-Rugged Notebook Windows 10 Pro



B300 (13.3") Rugged Notebook Windows 10 Pro



B360 (13.3") Rugged Notebook Windows 10 Pro



B360 PRO (13.3") Rugged Notebook Windows 10 Pro



X500 (15.6") & X500 Server Windows 10 Pro

# Security Products etc..

- Defence
- Government
- Industry



RF Spectrum Analysers



Tactical equipment managing target identification and location



Heartbeat Detectors



Spectrum Monitoring



Non-Linear Junction Detector Monitoring Devices



Gunshot Detectors



Crisis Response System



## Cellsense & Proscreen

Cellphones and Recording devices in Secure Facilities

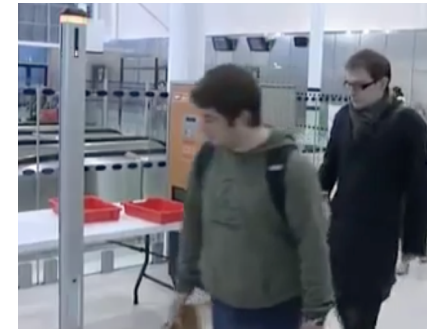

Ballistic Calculators®



Using Analytics to Turn Data Into Actionable Intelligence.





# Drone Detection



## Key Features:

- Electronic fence to stop drones
- No impact on other devices
- Up to 500m in height
- Creates a 'roof' over facility
- Disrupts command and navigation frequencies
- Scalable, to cover any size site
- No damage to the drone
- Defeats drone swarms

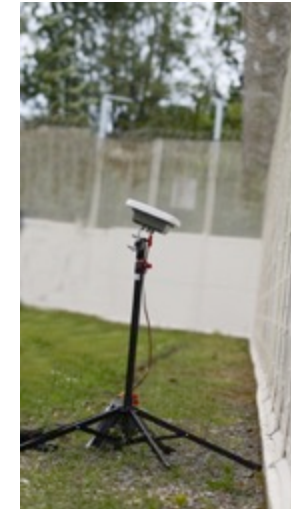

## Protecting -

- Industry
- Public Buildings & Spaces
- Land, Airspace and Privacy



**AARONIA AG**  
WWW.AARONIA.DE

Drone Detection System

Measures Real-Time RF emissions from Drones / UAVs, Radar etc.



IsoLOG 3D Antenna

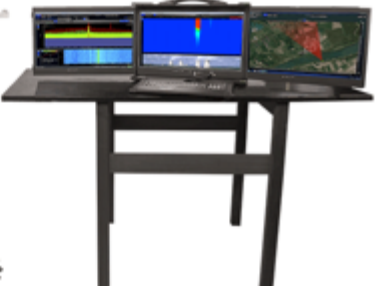

Real-Time Spectrum Analyzer SPECTRAN V5

# Perimeter Monitoring



## Detection Conditions:

- Fog
- Rain and spray
- Snow
- Darkness
- Smoke and hot gasses



## Incident Types:

- Inside AND outside the perimeter
- Slow or fast vehicle detection
- Pedestrian detection
- Critical point protection
- Controlled Zone/Restricted Zone (CZ/RZ) capabilities

# Interconnect Solutions



## Patton

- SmartNode™ VoIP Gateways
- eSBC Demarcation & Security
- Patton Cloud – Management / Provisioning / Integration
- Interoperability
- Signal Conversion & Extension
- Applications in Rail: Surveillance, Control, Ticket Vending, Signage
- Applications in Oil & Gas: Sensor Data, Security, Transparent IP Transport



## Fiberplex

- Secure Digital Communications
- Secure Data Scrubbing – MILSAT
- Hardware Security – SCIF
- Expand existing infrastructure without pulling additional fibre
- Future-proof active WDM solutions
- Mode conversion and signal repeating

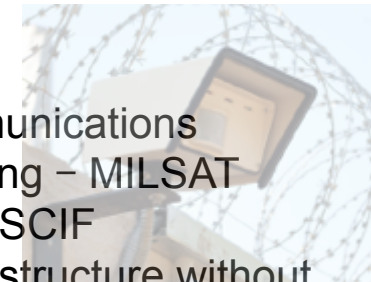

# Fibre Optic + Data Products



- Data Centre Products
- FOTs Cable, Cabinets and Distribution Frames
- Outdoor Termination boxes
- Distribution Frames
- Racks and Software Management
- Connectors and Cables

- Optical Switches
- HD Connectivity

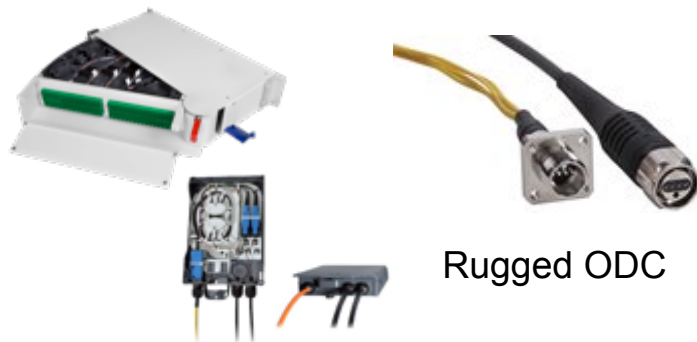

Rugged ODC



Fibre Optic Adapters



Attenuators & SFPs



IBC™ Brand Cleaning Tools



# Transmitters & Studio-to-Transmitter Links



- Studio to Transmitter Links
- 200-960 MHz or 1.3-2.5 GHz
- FM Transmitters 30 W- 5 kW
- FM Amplifiers
- Off-air Receivers

## Hanjin Electronic Ind Co Ltd



**DGPS  
HF  
Navtex  
Transmitters**

**VHF Base Stations**



**Broadcast**



- FM Transmitters
- 300 W to 88 kW
- AM Transmitters
- 1 kW to 50 kW
- MW Transmitters
- 100 kW to 2 MW
- Digital Radio
- Digital TV



**Navigation**



- Non-Directional Beacons
- Differential GPS Systems
- LORAN (LOng RANGE Navigation)
- Antennas

# CRU Data Products



Protecting Your Digital Assets™



- Rugged, removable hard drives & frames
- Standalone networked backup appliances
- Weibetech evidential devices for digital forensics
- Rack mounted enclosures for removable drives
- Rugged metal tower enclosures for hard drives
- TOUGHTECH aluminium HDD enclosures
- Digital cinema removable storage



TOUGHTECH™



CRU RTX™



# Cable Accessories



## RUSLYN

The Ruslyn Cordwheel® is a Mil Spec ergonomic hand reel for the deployment of cables, ropes, hoses and wire.

- Constructed of Impact Copolymer & ABS
- Impact resistant
- UV Stabilised
- RoHS Compliant
- Chemical Resistant
- Positive buoyancy
- Recyclable
- NSN 8130-66-153-3558

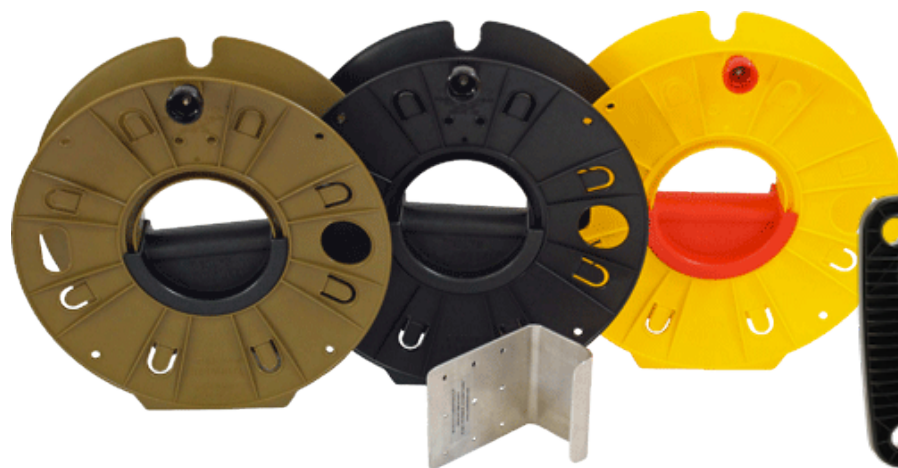

### Packreel®

Designed for use by dismantled personnel for EOD/CIED, engineers, search, special forces, clearance divers and aerospace.

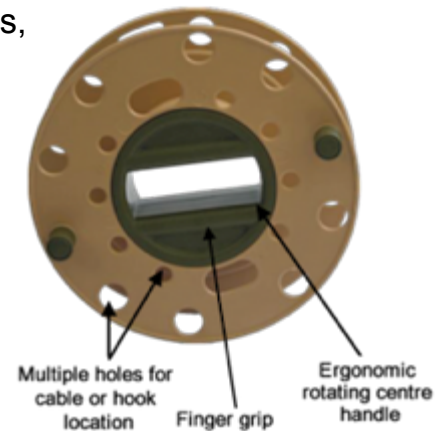

### Hook & Line Reel®

Manufactured from high strength plastic, it is lightweight and easy to operate.



# About InTELCOM Services

- New Zealand Private Company
- Trading under InTELCOM Services since 1987.
- Manufacturer's Representative (Reseller).
- Manufacturer of Cable Assemblies.
- Office/warehouse/workshop of 1000 m<sup>2</sup> located in Lower Hutt.
- Customers include:
  - Telcos
  - Broadcasters
  - Government
  - Defence
  - Radio Equipment Manufacturers
  - Warehouses & Coolstores



# Our Solutions Cover...



Space & Satellite



Warehousing/  
Cool Store



Industry & IoT



Data Centres



Oil & Gas



Broadcasting



Harsh  
Environment



- Antennas
- Cables
- Connectors
- RF Components
- Microwave Radio
- WiFi
- Accessories

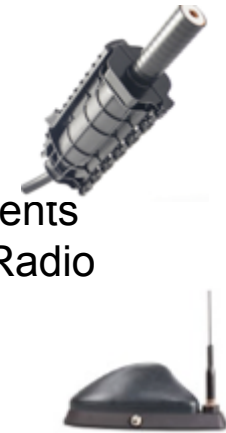

Transport – Rail  
- EV



RF Cable  
Assemblies

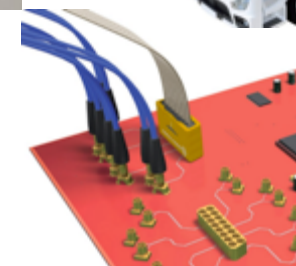

High Speed Digital  
Test Solutions

InTELCOM Services Ltd., 2 Herbert Street, Lower Hutt 5010, New Zealand,  
Ph: (04) 586 1212, Email: [info@intelcomservices.com](mailto:info@intelcomservices.com),  
[www.intelcomservices.com](http://www.intelcomservices.com)



# Our Partners



[sales@intelcomservices.com](mailto:sales@intelcomservices.com)



# InTELCOM Services Ltd

*Just Ask....*

[www.intelcomservices.com](http://www.intelcomservices.com)

InTELCOM House  
2 Herbert Street  
P O Box 38 091  
Lower Hutt 5045  
New Zealand  
[sales@intelcomservices.com](mailto:sales@intelcomservices.com)