



# International Workshop on Green Technologies Empowering Rural Women

## Manual

Small scale biogas plant  
Bamboo weaving  
Solar driers  
**Solar collectors**  
Project examples





# International Workshop on Green Technologies Empowering Rural Women

Jointly organised by:

**WOMENS' ACTION FOR DEVELOPMENT (WAFD)**

and

**INTEGRATED SUSTAINABLE ENERGY AND ECOLOGICAL DEVELOPMENT ASSOCIATION  
(INSEDA)**

sponsored by

**WOMEN IN EUROPE FOR A COMMON FUTURE (WECEF)**

Date: December 06th to 15th, 2013

**Venue: Village Chakchauba, Sewar Block, Dist Bharatpur (Raj State) & WAFD Center,  
New Delhi, India**

## TRAINING TEAM

**Overall training Coordinator-cum-Trainer:**

**Ms. Zareen Myles, Executive Director, WAFD**

**Chief Training Coordinator-cum-Trainer:**

**Engr. Raymond Myles, Secretary General-cum Chief Executive, INSEDA**

## OTHER TRAINING TEAM MEMBERS:

1. Jaswant Singh (INSEDA's Senior Construction Trainer)
2. Sumit Chaudhry (WAFD Trainer)
3. Trishpal (WAFD Trainer)
4. Mukseh Bahuguna (WAFD Construction Training Assistant)



Ministry of Foreign Affairs of the  
Netherlands

The WECEF EWA Programme receives financial support by the Dutch Ministry of Foreign Affairs







**Technologies on which practical training will be provided to WECF trainees by INSEDA/WAFD during 10 day period**

Sl. No.	Technology for Practical Training	Main Building Materials	Other Materials & Accessories	Activities and by whom		Nos
				Participants	INSEDA and WAFD Trainers, technician and local masons/ local women bamboo weavers	
1	Grameen Bandhu Biogas Plant (GBP)	Bamboo strips and Cement and Sand mortar	pipeline, accessories and appliances	Actual building by participants	Under guidance of trainers and technicians/technical assistant	2
2	Solar Polyhouse (SPH)	Wood , Very good quality UV stabilized Polyethylene sheets and Bricks, etc	Cement & Sand mortar and cooler for use in Summer and accessory	Demonstration and practice	To be built by INSEDA trainers, technician/ technical assistant	1
3	Roof Water Harvesting Tank (RWHT)	Bamboo strips and Cement and Sand mortar	Pipeline & relates accessories	Demonstration and practice	To be built by INSEDA trainers, technician/ technical assistant	1
4	Solar Drier	Bamboo and bamboo strips and polyethylene sheets	Binding wire and miscellaneous items	Build by participants under INSEDA trainers	Build under INSEDA trainers, technicians and assistant	3
5	Solar Water Heater	Bamboo and bamboo strips and polyethylene sheets	Binding wire and miscellaneous items and bucket/container	Build by participants	Build under INSEDA trainers, technicians and assistant	3
6	Compost Baskets	Bamboo and bamboo strips and polyethylene sheets	Miscellaneous items	Build by participants	Build under INSEDA trainers, technicians and assistant	6
7	NADEP Compost Unit	Already built using bricks	Waste filling materials	Demonstration and practice in filling	Under the guidance of INSEDA trainers and technical assistant	Already built
8	Organic Agriculture	Different types of Organic crops promoted by WAFD with project farmers	Visit to different farmers' agriculture fields	Demonstration	Farmer volunteers	Seasonal crops in the field
9	Toilet	Cement & Sand mortar, Bamboo poles and strips and toilet seats	Polyethylene sheets, pipes and miscellaneous items	Some practical work by the participants		1

**PRACTICAL PICTORIAL FIELD GUIDE ON**  
**GRAMEEN BANDHU BIOGAS PLANT**



**BY**  
**RAYMOND MYLES**



**DEDICATED**

**TO**

**RURAL WOMEN, LANDLESS AGRICULTURAL  
LABOURERS, RURAL ARTISANS AND RURAL YOUTH  
AND NGOS OF THE DEVELOPING COUNTRIES.**

## **ALL RIGHTS RESERVED**

This publication is the property of Engr. Raymond Myles Secretary General-cum-Chief Executive of INSEDA and INFORSE Regional Coordinator (South Asia), the author of this Guide. Copying either wholly or partly, using manually or electronically or by any other means, and/or transmitting portions or all of this work without prior permission would be a violation under applicable law and statues. Requests for permission to photocopy or reprint any part of this work should be obtained in advance from the author, in writing and sent to his residential or office address given at the bottom of this page.

**Engr. Raymond Myles:** Secretary General-cum-Chief Executive, INSEDA and INFORSE Regional Coordinator (South Asia)

**Residence Address:** **A-2/108, Third Floor, Front Flat, Janakpuri, New Delhi-110018, India**

**Office Address:** House No: C-37, First Floor, Next to Car Life Centre, Jeevan Park, Pankha Road, Uttam Nagar, New Delhi-110059, India

**Phone:** 6450 0730; Tele-fax: +91 11-2554 4905

**Mobile:** (0) 9212014905 and (0) 9899094905

**E-Mail:** [raymyles@bol.net.in](mailto:raymyles@bol.net.in); [ray.myles06@gmail.com](mailto:ray.myles06@gmail.com) and [ray\\_myles05@yahoo.co.in](mailto:ray_myles05@yahoo.co.in)

**INFORSE Website:** <http://www.inforse.org/asia> **and** [www.inforse.org](http://www.inforse.org)

**INSEDA Website:** <http://www.inseda.org> and <http://www.inseda.info>

All Rights Reserved

Engr. Raymond Myles Secretary General-cum-Chief Executive of INSEDA

**Second & Revised Edition**

**January 1, 2008**

## **THE AUTHOR**

### **RAYMOND MYLES**

B. Sc. (Ag. Engg.), Allahabad University (India), M. Sc. (School of Agricultural Engineering), University of Guelph, (Canada) is the founder life member and the founder Secretary General-cum-Chief Executive of the INSEDA (Integrated Sustainable Energy And Ecological Development Association) which is an autonomous National Association promoted by the Network of NGOs, many of whom have been involved in the biogas development programme in India for over a decade. He is the former Executive Director of AFPRO.

The author had been involved in planning, developing, directing & implementation of biogas programme of AFPRO from scratch, since its inception in 1979. He initiated a process oriented approach for the capacity building and strengthen of Indian grass roots NGOs for systematically develop them and gradually establishing their Network for decentralized implementation of biogas programme under the centrally sponsored scheme, known as National Project on Biogas Development (NPBD), Ministry of Non-Conventional Energy Sources (MNES), Government of India.

The author was also responsible for the overall coordination, facilitation, directing and guiding the NGO promoted biogas development programme, under the NPBD of the MNES (now MNER), Govt. of India. Under his overall guidance and coordination, this network had grown from a few organizations in 1980 to over 70 NGOs in 1995, operating over 90 Biogas Extension Centres (BECs), and developed capabilities of building around 10,000 household biogas units, annually. The majority of these NGOs are now associated with INSEDA (established in later part of 1995) and has its registered office and headquarters at New Delhi.

The author was actively involved as one of the team members in the design, development, trial, testing and field evaluation of Deenbandhu biogas plant which was approved by DNES (now MNES) for extension under NPBD. He is the author of 'A Practical Guide to Janata Biogas Plant Technology' and the co-author of 'Manual on Deenbandhu Biogas Plant'. He has also written about 75 papers in biogas technology, RETs/SETs and related fields. He has participated and made presentations at several national, regional and international conferences, seminars, symposiums and workshops.

The author conceptualized the new low cost fixed dome Bamboo Reinforced Cement Mortar (BRCM) Rural Household (RHh) biogas plant (BGP) in 1993 and is the chief designer of this model. The design of which he finalized in 1996 after field testing it by building a few plants with farmers in villages of Bharatpur district of Rajasthan state, in collaboration with WAFD, one of the grassroots member NGOs of INSEDA. Later on he designed five family sizes (1, 2, 3, 4 & 6 m<sup>3</sup> capacities) and christened it as GRAMEEN BANDHU (meaning friend of the rural people). He has also planned the construction methodology, testing, training, field demonstration and implementing strategy for dissemination, large-scale extension and diffusion of Grameen Bandhu model. In 1997 he wrote a "Comprehensive Manual on Grameen Bandhu Biogas Technology". In the same year he also wrote a "Pictorial Field Guide on Grameen Bandhu Model", which is now being upgraded and revised based on experience gained and feedback received.

The author is one of the founder members of the INFORSE (International Network of Sustainable energy) and it's Regional Coordinator for the South Asian Region, which has its International Secretariat in Denmark.



## **PREFACE**

### **(For the second revised "Pictorial Field Guide on Grameen Bandhu Biogas Plant")**

India is one of the pioneer countries in the field of biogas technology, dating back to 1897 when the first biogas plant on human waste was setup in Bombay. The first cattle dung based biogas plant was developed and tested at IARI, New Delhi in 1939, followed by development of the first field worthy family size cattle dung biogas model with floating gas holder at KVIC (Bombay), by Mr. Jasbhai Patel in 1956. The KVIC model became the most popular plant, due to its launching a demonstration programme to popularize this programme in rural areas, starting from 1960 onwards. The Gobar Gas Research Station (GGRS), Ajitmal, District. Etawah, (U.P.) S, however, was the first institution to design a field worthy Fixed Dome biogas plant, named as Janata (people's) model, in the later part of 1970's, which was approved by the then nodal Ministry (the Ministry of Agriculture, Govt. of India) for dissemination and extension of biogas technology.

The NGOs Network played a very important and crucial role in promotion, transfer, popularization and diffusion of Janata Model throughout the country. I have been fortunate to be involved in the planning, developing and implementation of biogas programme of this NGO Network from scratch, since its inception in 1979. I was instrumental in developing and conducting training programmes for different levels of biogas functionaries of Non-Government Organizations (NGOs) for ensuring their effective involvement in the promotion, extension and dissemination of low cost biogas units throughout India. In 1980, I also initiated the process for developing an informal biogas network for the decentralized implementation of biogas development programme by grass-roots NGOs. Subsequently, I prepared a master proposal and secured the financial support of from the interested funding agencies for the capacity building of the individual NGOs as well as, for strengthening both, the NGOs, their biogas NETWORK, for systematically promoting household biogas programme, under the centrally sponsored scheme, known as the National Project On Biogas Development (NPBD) under the Ministry of Non-Conventional Energy Sources (MNES), Government of India. I was responsible for the overall coordination, facilitation, directing and guiding the NGO promoted biogas development programme, under the NPBD of the MNES, Govt. of India.

By the end of 1995, this NGO network had grown from an informal FORUM of a few loosely knitted NGOs in 1980 to a strong and stable NETWORK of over 70 grassroots level NGOs, operating over 90 Biogas Extension Centres (BECs), throughout the length and breadth of the country,. As a result of this, the NGO members of this network which had been operating informally for about 15 years till then, decided to organize themselves into a formal body by the name INSEDA, to give it credibility and its own identity for systematically promoting people centered, renewable energy and ecological development programmes for the benefit of rural people, through its member organizations and other partners. Subsequently, the INSEDA (Integrated Sustainable Energy and Ecological Development Association) was registered as an autonomous national association under Indian Societies Registration Act in December 1995, with registered office and the national headquarters in New Delhi.

Based on the need expressed by the members of the network in the meetings and workshops and the feedback, as well as the encouragement & support provided by the biogas network, led to the conceptualization of the new low cost fixed dome Bamboo Reinforced Cement Mortar (BRCM) Rural Household (RHh) biogas plant (BGP) by myself, in early 1993. However, the first prototype BRCM model plant of 2 m<sup>3</sup> capacity was designed by me in the later part of 1993, which was built in early 1994 for testing its strength, durability and operational performance. The performance of this biogas model was compared with the same capacity Deenbandhu model (which is currently the most popular Indian RHh plant), since early 1994. The observations showed that this new model was as good as the previous three popular Indian models (namely, KVIC, Janata & Deenbandhu) under similar conditions. This new BRCM biogas model which is also a semi-continuous hydraulic digester plant was christened as GRAMEEN BANDHU (friend of the rural people) by me. Later on I also designed four other capacity household plants (thus now there are five sizes of 1, 2, 3, 4 & 6 m<sup>3</sup> capacities GRAMEEN BANDHU model), based on the operating principles of a semi-continuous hydraulic digester biogas plant, for the two different HRTs i.e. 40 and 55 day and two different gas storage capacities (33% & and 50% of the rated daily gas production capacity).

The experience has shown that no rural oriented technologies, developed outside the rural setting can be successful at the field level, even if they are low cost, unless backed by complete & comprehensive packages to ensure decentralize implementation. Therefore, to meet this need, I have designed the construction methodology for the Grameen Bandhu plant (GBP) as well as, day to day practical training programme on fabrication of bamboo shell structures by bamboo weavers (especially rural women in their spare time in their own villages) and construction of this model at site by masons. An effort has been made by me to not only cover almost all the aspects related to this new and simple rural household (RHh) plant in a comprehensive manual on Grameen Bandhu plant (GBP), which is available from INSEDA.

Meanwhile the in response to the need to promotional organizations, I have endeavoured to also prepare a simple pictorial field guide for extension and field agencies to be used by their functionaries for wider popularisation of this technology. A limited copies of this guide was first brought out in the early part of the 1997. This "Practical Pictorial Filed Guide on Grameen Bandhu plant" has been prepared keeping in view the field practitioners so that it could be used as a day-to-day guide in construction of this model by trained technician, master masons and women worker, under the guidance of trained and experience supervisor of the grassroots NGOs and other developmental organisations.

Being a recently developed technology, based on altogether new construction techniques, the readers may find certain gaps & shortcomings in projecting them correctly in this practical guide, which will be rectified after getting further feedback, especially from the field agencies.

In the end, I would like to add that even if this "Field Guide on Grameen Bandhu Plant" is able to meet part of the aspiration and generate interest in the practitioners of biogas technology; my purpose of writing this would be fully rewarded and will give me immense satisfaction for making this small contribution.

RAYMOND M. MYLES,  
Secretary General-cum-Chief Executive,  
INSEDA, New Delhi, India  
(Revised in January 2008)

## ***Section- I***

### **BIOGAS TECHNOLOGY**

#### **1.01 Introduction**

**1.01.1** Nature has a provision of destroying and disposing of wastes and dead plants and animals. Tiny microorganisms called bacteria carry out this decay or decomposition. The Farm Yard Manure (FYM) and compost is also obtained through decomposition of Organic Matter (OM). When a heap of vegetable or animal matter and weeds etc. die or decompose at the bottom of the backwater or shallow lagoons then the bubbles can be noticed rising to the surface of water. Some times these bubbles burn with flame at dusk. This phenomenon was noticed for ages, which puzzled man for a long time. It was only during the last 200 years or so when scientists unlocked this secret, as the decomposition process that takes place under the absence of air (oxygen). This gas, production of which was first noticed in marshy places, was and is still called as 'Marsh Gas'. It is now well known that this gas (Marsh Gas) is a mixture of Methane (CH<sub>4</sub>) and Carbon dioxide (CO<sub>2</sub>) and is commonly called as the 'Biogas'. The technology of scientifically harnessing this gas from any biodegradable material (organic matter) under artificially created conditions is known as biogas technology.

#### **1.02 Decomposition**

**1.02.1** There are two basic type of decomposition or fermentation- **(a) Aerobic** and **(b) Anaerobic**, as briefly described below:

**a). Aerobic decomposition (or fermentation):**

Aerobic means in the presence of Air (Oxygen). Therefore any decomposition or fermentation of organic material takes place in the presence of air (oxygen) is known as aerobic decomposition or fermentation. Aerobic decomposition can be achieved in two ways namely, (i) natural and (ii) artificial.

**b). Anaerobic decomposition (or fermentation):**

Anaerobic means in the absence of Air (Oxygen). Therefore any decomposition or fermentation of organic material takes place in the absence of air (oxygen) is known as anaerobic decomposition or fermentation. Anaerobic decomposition can also be achieved in two ways namely, (i) natural and (ii) artificial

#### **1.03 Digestible property of organic matter**

**1.03.1** When organic raw materials are digested in an airtight container only a certain percentage of the waste is actually converted into Biogas and Digested Manure. Some of it is indigestible to varying degree and either gets accumulated inside the digester or discharged with the effluent. The digestibility and other related properties of the organic matter are usually expressed in the following terms:

**a). Moisture:**

This is the weight of water lost upon drying of organic matter (OM) at 100 °C ± 10 °C (220 °F). This is achieved by drying the organic matter for 48 hours in an oven until no moisture is lost. The moisture content is determined by subtracting the final (dried) weight from the original weight of OM, taken just before putting in the oven.

**b). Total solids (TS):**

The weight of dry matter (DM) or total solids (TS) remaining after drying the organic matter in an oven as described above. The TS is the "Dry Weight" of the OM (*Note:* after the sun drying the weight of OM still contains about 20% moisture). A figure of 10% TS means that 100 gm of sample will contain 10 gm of moisture and 90 gm of dry weight. The Total Solids (TS) consists of Digestible Organic (or Volatile Solids-VS) and the indigestible solid (Ash).

**c). Volatile solids (VS)/ Volatile matter (VM):**

The weight of burned-off organic matter (OM) when "Dry matter-DM" or "Total solids-TS" is heated at a temperature of  $550^{\circ}\text{C} \pm 50^{\circ}\text{C}$  (or  $1000^{\circ}\text{F}$ ) for about 3 hours is known as volatile solids (VS) or volatile matter (VM). Muffle furnace is used for heating the Dry matter or Total solids of the OM at this high temperature after which only ash (inorganic matter) remains. In other words the Volatile solids (VS) is that portion of the Total solids (TS) which volatilizes when it is heated at  $550^{\circ}\text{C} \pm 50^{\circ}\text{C}$  and the inorganic material left after heating of OM at this temperature is known as Fixed solids or Ash. It is the Volatile solids (VS) fraction of the Total solids (TS), which is converted by bacteria (microbes) into biogas.

**d). Fixed Solids (FS) or Ash:**

The weight of matter remaining after the sample is heated at  $550^{\circ}\text{C} \pm 50^{\circ}\text{C}$  is known as Fixed Solids (FS) or ash. Fixed Solids is biologically inert material and is also known as Ash.

**1.04 Biogas production system**

**1.04.1** The biogas (mainly mixture of methane and carbon dioxide) is produced/generated under both, natural and artificial conditions. However for techno-economically-viable production of biogas for wider application the artificial system is the best and most convenient method. The production of biogas is a biological process, which takes place in the absence of air (oxygen), through which the organic material is converted into, essentially Methane ( $\text{CH}_4$ ) and Carbon dioxide ( $\text{CO}_2$ ) and in the process gives excellent organic fertilizer and humus as the second by-product. The one essential requirement in producing biogas is an airtight (air leak-proof) container. Biogas is generated only when the decomposition of biomass takes place under the anaerobic conditions, as the anaerobic bacteria (microbes) that live without oxygen are responsible for the production of this gas through the destruction of organic matter. The airtight container used for the biogas production under artificial condition is known as digester or reactor.

**1.04.2 Composition of biogas**

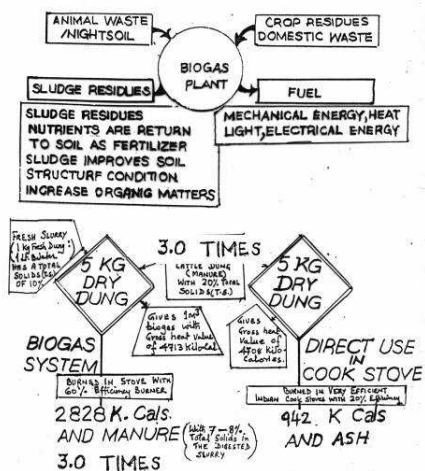
- a).** Biogas is a colourless, odourless, inflammable gas, produced by organic waste and biomass decomposition (fermentation). Biogas can be produced from animal, human and plant wastes, weeds, grasses, vines, leaves, aquatic plants and crop residues.
- b).** The composition of different gases in biogas is given in the table-I below:

**Table-I**

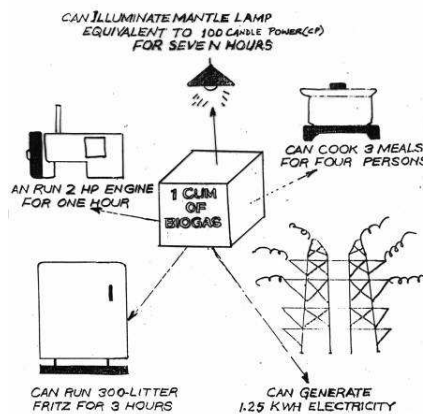
Methane ( $\text{CH}_4$ )	55-70%
Carbon Dioxide ( $\text{CO}_2$ )	30-45%
Hydrogen Sulphide ( $\text{H}_2\text{S}$ )	1-2%
Nitrogen ( $\text{N}_2$ )	0-1%
Hydrogen ( $\text{H}_2$ )	0-1%
Carbon Mono Oxide ( $\text{CO}$ )	Traces
Oxygen ( $\text{O}_2$ )	Traces



**1.04.3** The schematic diagram-1 shows the advantage of using cattle manure (dung) in biogas plant, as compared to its present use as of dung cake or as manure made in traditional way in rural India. The schematic diagram-2 shows the various applications of biogas as a source of renewable, clean and convenient energy.



**Diagram-1**



**Diagram-2**

**1.04.4** Property of biogas

- a). Biogas burns with a blue flame. It has a heat value of 500-700 BTU/ft<sup>3</sup> (4,500-5,000 kcal/m<sup>3</sup>) when its methane content is in the range of 60-70%. The value is directly proportional to the amount of methane contains and this depends upon the nature of raw materials used in the digestion. Since the composition of this gas is different, the burners designed for coal gas, butane or LPG when used, as 'biogas burner' will give much lower efficiency. Therefore specially designed biogas burners are used which give a thermal efficiency of 55-65%.
- b). Biogas is a very stable gas, which is a non-toxic, colourless, tasteless and odourless gas. However, as biogas has a small percentage of Hydrogen Sulphide, the mixture may very slightly smell of rotten egg, which is not often noticeable especially when being burned. When the mixture of methane and air (oxygen) burn a blue flame is emitted, producing large amount of heat energy.
- c). Because of the mixture of Carbon Dioxide in large quantity the biogas becomes a safe fuel in rural homes as will prevent explosion.
- d). A 1 m<sup>3</sup> biogas will generate 4,500-5,500 kcal/m<sup>2</sup> of heat energy, and when burned in specifically designed burners having 60% efficiency, will give out effective heat of 2,700-3,200 kcal/m<sup>2</sup>. 1 kcal is defined as the heat required raising the temperature of 1 kg (litre) of water by 1 °C. Therefore this effective heat (say 3,000 kcal/m<sup>2</sup> is on an average) is sufficient to bring approx. 100 kg (litre) of water from 20 °C to a boil, or light a lamp with brightness equivalent to 60-100 watts for 4-5 hours.

**1.05** Mechanics of extraction of biogas

**1.05.1** The decomposition (fermentation) process for the formation of methane from organic material (biodegradable material) involves a group of organisms belonging to the family- 'Methane Bacteriaceae' and is a complex biological and chemical process. For the understanding of common people and field workers, broadly speaking the biogas production involves two major processes consisting of acid formation (liquefaction) and gas formation (gasification). However scientifically

speaking these two broad processes can further be divide, which gives four stages of anaerobic fermentation inside the digester-they are (i) Hydrolysis, (ii) Acidification, (iii) Hydrogenation and (iv) Methane Formation. However, for all practical purposes one can take the methane production cycle as a three stage activity- namely, (i) Hydrolysis, (ii) Acidification and (iii) Methane formation.

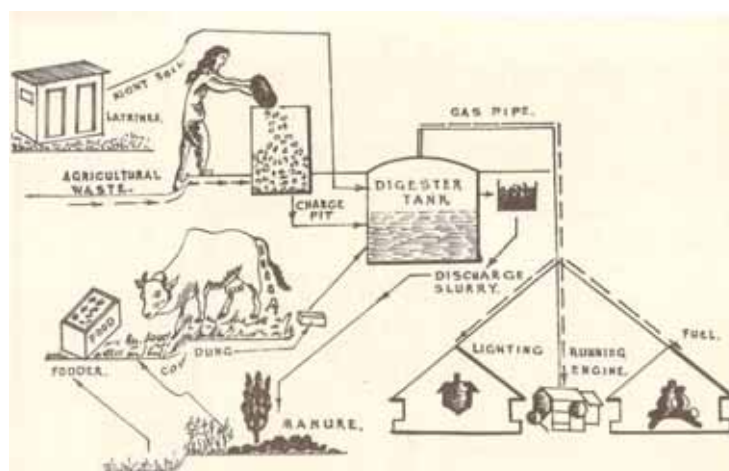
**1.05.2** Two groups of bacteria work on the substrate (feedstock) inside the digester-they are (i) Non-methanogens and (ii) Methanogens. Under normal conditions, the non-methanogenic bacteria (microbes) can grow at a pH range of 5.0-8.5 and a temperature range of 25–42 °C; whereas, methanogenic bacteria can ideally grow at a pH range of 6.5–7.5 and a temperature range of 25-35 °C. These methanogenic bacteria are known as 'Mesophylic Bacteria' and are found to be more flexible and useful in case of simple household digesters, as they can work under a broad range of temperature, as low as 15 °C to as high as 40 °C. However their efficiency goes down considerably if the slurry temperature goes below 20 °C and almost stops functioning at a slurry temperature below 15 °C. Due to this Mesophylic Bacteria can work under all the three temperature zones of India, without having to provide either heating system in the digester or insulation in the plant, thus keeping the cost of family size biogas plants at an affordable level.

**1.05.3** There are other two groups of anaerobic bacteria-they are (i) Psychrophylic Bacteria and (ii) Thermophylic Bacteria. The group of Psychrophylic Bacteria work at low temperature, in the range of 10-15 °C but the work is still going on to find out the viability of this group of bacteria for field applications. The group of Thermophylic Bacteria works at a much higher temperature, in the range of 45-55 °C and is very efficient, however they are more useful in high rate digestions (fermentation), especially where a large quantity of effluent is already being discharged at a higher temperature. As in both the cases the plant design needs to be sophisticated therefore these two groups of Bacteria (Psychrophylic & Thermophylic) are not very useful in the case of simple Indian rural biogas plant.

**1.06 Biogas**

**1.06.1** Biogas is a mixture of a few gases, such as Methane (CH<sub>4</sub>)- 55-70%, Carbon dioxide (CO<sub>2</sub>)- 30-45% and traces of Hydrogen Sulphide (H<sub>2</sub>S), Ammonia (NH<sub>3</sub>) etc formed as a result of anaerobic digestion of bio-degradable (organic) materials.

**1.06.2** The schematic diagram-3 shows efficient recycling of waste biomass (bio-degradable material) for extracting two very useful products, viz., energy (for thermal. mechanical and electrical application) and enriched organic (bio) manure for crop production.



**Diagram-3**

## 1.07 Biogas production

**1.07.1** Other parameters being the same, the overall efficiency of biogas production for a given plant design depends upon three things. They are: (i) the optimum yield from a given substrate for a given HRT (Hydraulic Retention Time) or SDT (Solid Detention Time), (ii) the gas production per unit time (usually in a day-24 hours), and (iii) the daily gas production per unit of digester volume ( $\text{m}^3/\text{m}^3/\text{day}$  or  $\text{Litre}/\text{m}^3/\text{day}$ ). These three are very important criteria for ascertaining overall efficiency of a simple biogas plant, which also results in cutting down the cost, especially in a simple Rural Household (RHh)-i.e. Family Size Biogas Plant.

**a). Gas yield:**

**(i) Total gas yield:-** It is the maximum potential of biogas, which can be given by a particular organic, feed stock (substrate) under anaerobic conditions. This yield is found out by fermenting (digesting) 1 kg of substrate under laboratory conditions and optimum mesophyllic range of temperature till the time the maximum feasible gas releasing capacity of that particular substrate is more or less exhausted.

**(ii) Optimal gas yield:-** It is computed from the gas yield curve for a given Retention Time (Residence Time) which can be taken as a practical figure for design of a digester. For example, a simple rural house hold (RHh) family size BG model operating as a semi-continuous hydraulic digester plant, using cattle manure with 10% TS, will give an average biogas yield of  $0.04 \text{ m}^3$  (or 40 lt.) per kg. of fresh manure (dung) for an HRT of either 30, 40 or 55 days for the three different temperature (ambient) zones in India, respectively.

**b). Gas production rate**

The gas production rate is the quantity of biogas produced per unit time- it is normally expressed in terms of cubic meter per day ( $\text{m}^3/\text{day}$ ) in 24 hours or  $\text{lt.}/\text{day}$  or  $\text{ft}^3/\text{day}$ .

**c). Gas production per unit digester volume**

It is the biogas production in  $\text{m}^3$  per cubic meter effective digester (i.e. fermentation chamber) volume per day (24 hours). It is commonly referred as  $\text{m}^3/\text{cum}/\text{day}$  or  $\text{liter}/\text{cum}/\text{day}$  or  $\text{ft}^3/\text{cu ft}/\text{day}$ . The comparative efficiency of two or more biogas plants are ascertained in terms of their ability to produce maximum possible gas from the least possible volume from their digesters (fermentation chambers)<sup>1</sup> for the same substrate and under similar conditions etc. In case of simple rural household semi-continuous hydraulic digester the cost of the entire biogas unit also needs to be taken into account to ascertain the biogas production efficiency vis-à-vis the capital investment to build (install) the unit. Combination of these two information can also be used as a thumb rule by a layperson to choose an appropriate Biogas Model based on the least investment per unit digester volume out of the various options of plant designs, available to him/her for making selection.

## 1.08 Process description

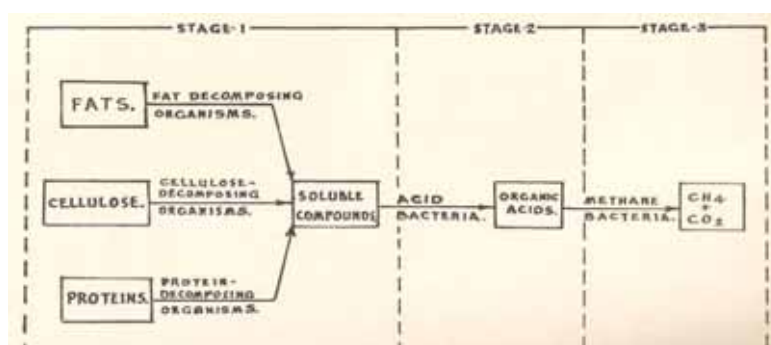
**1.08.1** Biogas generation is a process which is widely occurring in nature and can be described as a biological process, taking place in the absence of oxygen. The biogas generation process is characterized by low nutrient requirement & high degree of waste stabilization process, of which biogas is one of the two useful end products; the other being enriched organic manure in the form of digested slurry. Both, the biogas (mainly comprising methane and carbon dioxide) and the organic

<sup>1</sup> This refers to only the effective digester volume (i.e. the volume of fermentation chamber) of the plant and not the other components of the Main Unit of the Plant (MUP). The Main Unit of the three Indian fixed dome models mentioned in this manual (Janata, Deenbandhu & Grameen Bandhu), comprises of four sub-components, they are (i) fermentation chamber, (ii) gas storage chamber (GSC), free space (FS) above the GSC and the closed roof (of MUP) in the shape of it's dome. It has been seen that people often make the mistake of referring the combined volume of the fermentation chamber and GSC (or sometimes even all these four sub-components) as the volume of Fermentation Chamber, which is not correct. The fermentation chamber is actually the 'effective digester' of the three Indian fixed dome biogas models, namely, Janata, Deenbandhu & Grameen Bandhu plants.

manure (digested/fermented material) can be used directly for the benefit of rural people, former as a clean & convenient fuel and later as manure for the agricultural & horticultural production.

**1.08.2** Even though, theoretically, the biogas Process is be divided into Four Stage Process; however, for all practical purposes, for Simple Rural Household (RHh) Biogas Plants, they can be essentially considered to be a Three Stage Process, as shown in diagram-4 and given below:

- a). **Hydrolyses**
- b). **Acid formation, and**
- c). **Methane generation**



**Diagram-4**

**1.08.3** In the first stage a group of facultative microorganisms that can act both under aerobic and anaerobic conditions acts upon the organic substrate. These bacteria act on complex polymers and enzymatically hydrolyze them converting them into dimmers and subsequently soluble monomer sugars. These monomers become the substrate for the microorganisms in the second stage in which these simple sugars are converted into organic acids. These soluble organic acids-primarily acetic acids-act on the substrate for the final stage of the decomposition process catalyzed by methanogenic bacteria. These bacteria are strictly anaerobic and can produce methane in two ways: - by fermenting acetic acid to methane and carbon dioxide, or by reducing carbon dioxide to methane using hydrogen or formate produced by other bacteria. The production of methane in the third stage reduces the amount of oxygen demanding material remaining. This produces a biologically stable residue, which can be used as organic fertilizer. Bacterial growth occurs during all stages of the fermentation process, the proportion of total substrate utilized to support bacterial growth, however, is low compared to that utilized in aerobic biological processes.

**1.08.4** For all practical purpose the first two phases are often defined as a single stage i.e. hydrolysis & acid formation phase are grouped as acid formation stage. Microorganisms taking part in this stage are termed as "Acid formers". As a group these organisms grow rapidly and are not much dependent on surroundings.

**1.08.5** Product of first stage consisting of two phases serve as the raw materials for third stage where organic acids are utilized as carbon source by methane forming micro-organisms, aree also known as methanogens. Atmospheric oxygen is extremely toxic to methanogens as they are strict anaerobes.

#### **1.08.6 Substrate and microbiology of Stage-I: Polymer breakdown**

- a). Initial substrate for Stage-I including various waste materials is composed primarily of carbohydrates, some lipids, protein and inorganic material. The major carbohydrates are cellulose and other plant fibbers such as hemi-cellulose and lignin. These are found in crop residues and animals wastes and are often not digestible. A broad spectrum of anaerobic bacteria is required to solubalize these materials, including bacteria possessing cellulolytic, lipolytic and proteolytic enzymatic capacity.



- b). Cellulolytic activity is the most critical in reducing complex raw material into simple, soluble, organic compounds. The largest fraction of organic matter (OM) in sewage sludge is cellulose and if crop residues are utilized directly, then the total Dry Matter (DM) or Total Solids (TS) will have even higher proportion of cellulose.
- c). Cellulytic bacteria are generally grouped in three classes depending on the optimum temperature at which they act. The (i) Psychrophilic bacteria have optimum working range of 10°-20° C. The (ii) Mesophilic bacteria have optima in the range of 30°-40° C, as in the rumen of cattle. While the (iii) Thermophilic species of bacteria work optimally at 45°-55° C. All the three groups of bacteria have pH optima in the range of 6.6- 7.6.
- d). Co-operative action of a variety of cellulytic and other hydrolytic bacteria is important in the breakdown of complex carbohydrates such as cellulose.

#### 1.08.7 Substrate and microbiology of Stage-II: Acid production

- a). The monomer components released by the hydrolytic breakdown that occurs during stage-I bacterial action become the substrate for the acid-producing bacteria of stage-II. The end products of stage-II are acetic, propionic and lactic acids as the major products. Methanogenic bacteria are very restrictive in substrate utilization and are probably capable of utilizing only acetic acid. Some species can also produce methane from hydrogen gas and carbon dioxide. Methane can also be produced by the reduction of methanol, another possible by-product of the carbohydrate breakdown. However, acetic acid probably accounts for approximately 70% of the substrate for methane production.
- b). The microbiology of stage-II is not well understood as many bacterial species are involved. The proportion of acids, hydrogen gas (H<sub>2</sub>), carbon dioxide (CO<sub>2</sub>) and simple alcohol produced depends on the flora present as well as environmental conditions.

#### 1.08.8 Substrate and microbiology of Stage-III: Methane production

- a). Apart from the substrate mentioned above methanogenic bacteria can utilize formic acid that however, is not usually present in anaerobic fermentation. Methanogenic bacteria are also dependent on stage-I and stage-II bacteria to provide nutrients in a useful form; e.g., organic nitrogen compounds must be reduced to ammonia to ensure efficient nitrogen utilization by the methanogenic bacteria. These bacteria also require phosphate and other materials to function properly. Methanogenic bacteria being obligate anaerobes, their growth is inhibited by small amounts of oxygen and it is essential that a highly reducing environment be maintained to promote their growth. Not only oxygen, but any highly oxidized material such as nitrites or nitrates can inhibit methanogenic bacteria.
- b). These bacteria are also very sensitive to changes in pH; the optimal pH range for methane production is between 7.0 and 7.2 although gas production is satisfactory between 6.6 and 7.6. When the pH drops below 6.6 there is a significant inhibition of methanogenic bacteria and the acid conditions of a pH of 6.2 are toxic to these bacteria. At this pH, however, acid production continues since the acidogenic bacteria produces acid until the pH drops to in the range of 4.5- 5.0. Under balanced digestion conditions, the biochemical reactions tend to maintain the pH in the proper range automatically. Although the volatile organic acids produced during the first stage of fermentation process tend to depress the pH, this effect is counteracted by the destruction of volatile acids and reformation of bi-carbonate buffer during the second stage.
- c). If imbalance develops, however, the acid formers outpace the methane formers and volatile organic acids build up in the system. If imbalance continues, the buffer capacity may be overcome and the pH may drop drastically. This occurs sometimes during the initial charging of a biogas plant when equilibrium has not been reached between the different classes of bacteria. Under circumstances when acidity develops, buffering with lime or other agents such as ammonium hydroxide may be necessary. Care must be exercised since excess ammonia as well as the ammonium ion can be toxic. The sodium, potassium, calcium,

magnesium and ammonia are stipulatory in low concentrations and inhibitory at higher concentrations.

- d). In the anaerobic process only the gases including methane, carbon dioxide and trace amounts of hydrogen sulphide and ammonia are removed thus the sludge from plant residues and animal waste conserves its nutrients needed for continued production of crops. It is important to note that only 1% of the organic nitrogen is lost in the anaerobic digestion process. Therefore, to minimize the loss of nitrogen due to volatilization in the effluent sludge, the digested slurry should be stored in deep lagoons or tanks that present a minimum of surface area for ammonia to volatilize. The Nitrogen is conserved to the greatest extent if the sludge or digested slurry is injected below the soil surface a few days before crop planting or just prior to cultivation. If the sludge is spread on the soil surface and allowed to dry without interruption by rainfall nearly all the ammoniac nitrogen will be lost by volatilization.

## 1.09 Parameters affecting anaerobic digestion

There are several parameters that affect the anaerobic digestion/gas yields and they can be divided into two- (i) Environmental and (ii) Operational:

### 1.09.1 Environmental parameters

There are a few environmental parameters that limit the reactions if they differ significantly from their optimum levels. However, the parameters of most interest in relation to simple Rural Household Plants are three, namely- (a) temperature, (b) pH and (c) nutrient contents of the raw materials. These three important environmental parameters are described in the subsequent paragraphs.

a). **Temperature:**

- (i) The temperature is one of the important parameters, which affects most small and medium capacities, simple design, family-size biogas installations in India. There are three zones of temperature in which three different sets (groups) of anaerobic bacteria especially methanogens function well they are given below:
- \* **Psychophilic**
  - \* **Mesophilic and Thermophilic bacteria**
- (ii) The optimum temperature range of digester slurry for Psychophilic bacteria is between 10-20° C; for Mesophilic bacteria, the range is between 30-40° C and for Thermophilic bacteria, the optimum range of temperature for digester slurry is between 45-55° C.
- (iii) The Mesophilic bacteria are found to be working in a wider range of temperatures, starting from a lower range of 15° C to a higher range of 40° C. Their efficiency, however starts getting adversely affected as the temperature of digester slurry goes down below 20° C; and goes down considerably at a slurry temperature in between 10-15° C. If the temperature falls and remains below 10°C for a longer period, the mesophilic bacteria almost cease to function. It is for this wide range of working i.e. good tolerance to fluctuation in temperature to some extent, which makes the mesophilic bacteria more useful in case of simple Indian rural household digester biogas plants, which are designed to operate at ambient (atmospheric) temperature.
- (iv) The minimum and maximum range of ambient temperature may also fluctuate considerably between the day and night, during summer and winter season, but would fluctuate less during the rainy season.
- (v) The too much sudden variation of the ambient temperature in a given season can also adversely affect the functioning of anaerobic bacteria, which could also affect the rate of gas production in a given season.

- (vi) In case of most of the rural household plants operating at ambient temperature the biogas production goes up in summer and goes down considerable in winter, especially when it becomes very cold.
- (vii) It is for the above reason; India has been divided into five climatic zones based on the mean atmospheric (ambient) temperature during the winter months, which are given in table-II.

**Table-II**

<b>ZONE*</b>	<b>MEAN TEMPERATURE DURING WINTER MONTHS</b>
<b>I</b>	more than 25° C
<b>II</b>	20-25° C
<b>III</b>	15-20° C
<b>IV</b>	10-15° C
<b>V</b>	less than 10° C

- \* **Note:**
- (1) The Zone-V has not been considered suitable for setting a simple rural household biogas plant designed to operate under ambient temperature.
  - (2) In places/regions, which have cold winters, it is also advisable to prepare the daily input slurry with hot water. In rural areas, the simplest and easiest way to do this would be to put buckets full of water outside in the sun during the day and use this hot water for mixing the dung for preparing the slurry in the evening for feeding in the plant. This method of heating water will be cheaper and would save other energy and once the plant owners get used to this method, it may turn out to be more practical in rural areas. If enough space is available with the plant owner then a semi-permanent or permanent water tank can also be built for both storing and heating the water (using direct solar energy) in the cold winter months.

- (viii) The states/union territories of India have been grouped for the four different zones of temperature ranges vis-à-vis the three corresponding designs HRT for simple rural household digesters. These are given in table-III.

**Table-III**

<b>HRT (HYDRAULIC RETENTION TIME)</b>	<b>TEMPERATURE ZONE</b>	<b>PLACES IN INDIA (STATES/ UTS/ ITS)*</b>
Biogas Plants based on 30 days HRT	<b>ZONE- I</b>	Andaman and Nicobar islands, Andhra Pradesh, Dadar Nagar Haveli, Goa, Tamil Nadu Karnataka, Maharashtra and Pondichery
Biogas Plants based on 40 days HRT	<b>ZONE- II and III</b>	Bihar, Chandigarh, Gujarat, Haryana, Jammu area of J&K State, Madhya Pradesh, Orissa, Punjab, Rajasthan, Plains of Uttar Pradesh.
Biogas Plants based on 55 days HRT	<b>ZONE- IV</b>	Himachal Pradesh, All North Eastern Regions, Sikkim, Kashmir area of J&K State, Hill Districts of Uttar Pradesh and such areas which have severe winter for long period.

\* **Note:** **U.T.**= Union Territory; **I.T.**= Island Territory

- b). **pH:**  
The pH range suitable for biogas production is rather narrow i.e. between 6.6 to 7.5- a pH value below 6.2 (acidic slurry) and above 8.0 (alkaline slurry) becomes toxic to the bacteria. The pH is some times also controlled inside a biogas plant by natural buffering effect of NH<sub>4</sub> and HCO<sup>3</sup> ions. The pH falls with the production of Volatile Fatty Acids (VFAs) but attains more or less constant level once the reaction proceeds.
- c). **Nutrient concentration:**  
Biogas producing raw materials can be divided into two parts i.e. (i) Nitrogen rich and (ii) Nitrogen poor. The Nitrogen concentration is considered with respect to carbon contents of the raw materials and it is often depicted in terms of C to N ratio. The optimum C/N ratio is

in the range of 25:1 to 30:1. In case of fresh cattle manure (dung) the problem of nutrient concentration does not exist as C/N ratio is usually 25:1.

### 1.09.2 Operational factors

These operational factors contributing to biogas production process are- (a) Retention Time (RT) also referred as detention or residence time, (b) slurry concentration; (c) mixing & (d) bacterial wash out.

**a). Retention time (RT):**

**(i)** The retention time (RT) or residence time is the period during which any organic matter is subjected to the anaerobic environment and reaction (or fermentation) time in a biogas digester. Ideally, it should be the period (duration) for which the slurry should be held inside the digester for getting between 75 to 90% of the total recoverable biogas in a simple rural household (RHH) plant. In view of this, the RTs for simple RHH plant designs need to be ascertained and prescribed for each zone, based on field experience of several years. This will help the designers to optimize the design parameters for any simple Hh biogas plant for different mean temperature zones of any country.

**(ii)** When the organic matter is fed in the digester each day in the form of fresh homogenous slurry<sup>2</sup> and approximately between 85 to 95% of the liquid in the form of digested slurry is discharged, the term used is Hydraulic Retention Time (HRT). Whereas, if the organic matter is fed in the solid form [having total solid (TS) content of 20% and above which can not flow freely out of digester] then it is referred as Solid Retention Time (SRT). The designed HRT of a simple semi-continuous hydraulic biogas plant (unheated plant without any temperature controlled device) is directly related to the temperature zone in which it is to be operated, as explained under the sub-title temperature. The Retention Time (RT) has a direct bearing on the size (volume) of digester- the volume of fermentation chamber (effective digester volume) of a biogas plant is equal to retention time multiplied by the quantity (volume) of daily feed.

**b). Slurry concentration:**

The Dry Matter (DM) or Total Solids (TS) content of the feed inputs denotes the slurry concentration. The optimum input for a cattle dung slurry (for a semi-continuous hydraulic digester plant) is between 8 to 12% TS (an average of 10% TS). Any variation from this range of TS may result in lower gas production. Mixing 4 parts of dung with 5 parts of water (4 kg: 5 lt.) form a slurry with TS of 9%, where as 1 part of dung to 1 part of water (1 kg: 1 lt.) would give a slurry concentration of 10% TS. The increase or decrease in total solids (TS) may also affect the daily loading rate of slurry in the plant.

**c). Mixing and stirring:**

Proper mixing of manure to form homogenous slurry before feeding in to the digester is an essential part of operation for giving better efficiency of biogas units. On the other hand proper and regular stirring of digester slurry ensures repeated contact of microbes (bacteria) with substrate (feed stock) and results in the efficient utilization of the contents (organic matter) in the digesters. An important function of stirring is to prevent the formation of scum layer on the upper surface of the digester slurry which if formed, reduces the effective digester volume and restricts the upward flow of gas to the gas storage (collection) chamber/tank. It is also to be kept in mind that while unstirred or irregularly stirred slurry may form scum and reduce efficiency due to lesser and un-uniform contact of bacteria with the feedstock (digester slurry) as well as scum formation on the other hand, if too much and too often stirring is done it can discharge prematurely digested or fresh material mixed with older materials, especially in the case of simple Rural Household BGPs.

<sup>2</sup> Homogenous slurry is slurry prepared by mixing fresh cattle manure with water in the ratio of 1:1 by weight- this would have total solids (TS) of 10%.



**d). Bacterial (microbial) wash out:**

In a simple rural household biogas plant there is every scope for short-circuiting of the material, which means the bacteria that are adhered on the surface of the slurry will go out with the digested slurry (effluent) each day. As the methanogenic bacteria grow very slowly compared to the acid forming bacteria, if too much of bacterial wash out takes place, the digester efficiency can go down considerably. As a result of this the negative effect of low ambient temperature during winter season on biogas production gets too much noticeable in simple rural household digesters. In winter months, in colder regions of the country, the efficiency of methanogenic bacteria goes down due to fall in the slurry temperature inside the digester. Added to this, if too much bacterial wash out also takes place then it affects the plant efficiency considerably. It is because of this reason that some times it is advisable to recycle certain percentage of digested effluent (which has active bacterial mass) back through inlet to increase the overall efficiency of the plant.

### **1.10 Type of digestion in simple household biogas plants (BGPs)**

**1.10.1** The digestion of organic materials in simple household biogas plants can be classified under three broad categories. They are (i) Batch-fed digestion (ii) Semi-continuous digestion and (iii) Semi-batch-fed digestion.

#### **1.10.2 Batch-fed digestion**

In batch-fed digestion process, material to be digested is loaded (with seed material or inoculum) into the digester at the start of the process. The digester is then sealed and the contents left to digest (ferment). At completion of the digestion cycle, the digester is opened and sludge (manure) removed (emptied). The digester is cleaned and once again loaded with fresh organic material, available in the season.

#### **1.10.3 Semi-continuous digestion**

This involves feeding of organic matter in homogenous slurry form inside the digester of the BGP once in a day, normally at a fixed time. Each day digested slurry; equivalent to about 85-95% of the daily input slurry is automatically discharged from the outlet side. The digester is designed in such a way that the fresh material fed comes out after completing a HRT cycle (55, 40 or 30 days), in the form of digested slurry. In a Semi-continuous digestion system, once the process is stabilized in a few days of initial loading of BGP, the biogas production follows a uniform pattern.

#### **1.10.4 Semi-batch fed digestion**

A combination of batch and semi-continuous digestion is known as Semi-batch fed Digestion. Such a digestion process is used where the manure from domestic farm animals is not sufficient to operate a plant and at the same time organic waste like, crop residues, agricultural wastes (paddy & weed straw), water hyacinths and weeds etc, are available during the season. In as Semi-batch fed Digestion the initial loading is done with green or semi-dry or dry biomass (that can not be reduced in to slurry form) mixed with starter and the digester is sealed. This plant also has an inlet pipe for daily feeding of manure slurry from animals. The Semi-batch fed Digester will have much longer digestion cycle of gas production as compared to the batch-fed digester. It is ideally suited for the poor peasants having 1-2 cattle or 3-4 goats to meet the major cooking requirement and at the end of the cycle (6-9 months) will give enriched manure in the form of digested sludge.

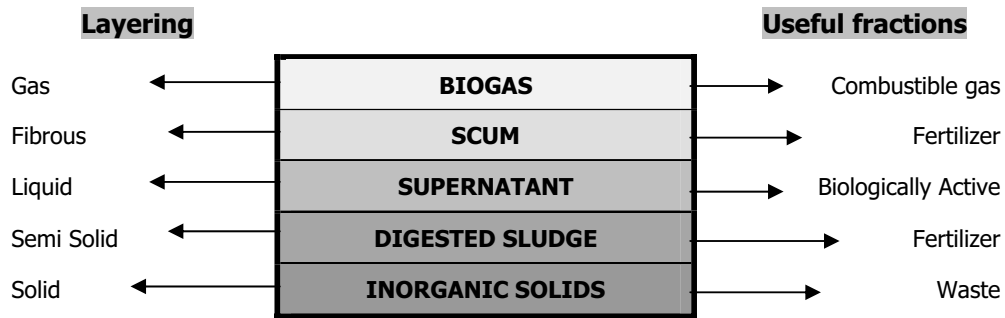
### **1.11 Stratification (layering) of digester due to anaerobic fermentation**

**1.11.1** In the process of digestion of feedstock in a BGP many by-products are formed. They are biogas, scum, supernatant, digested slurry, digested sludge and inorganic solids. If the content of Biogas Digester is not stirred or disturbed for a few hours then these by-products get formed in to different layers inside the digester.

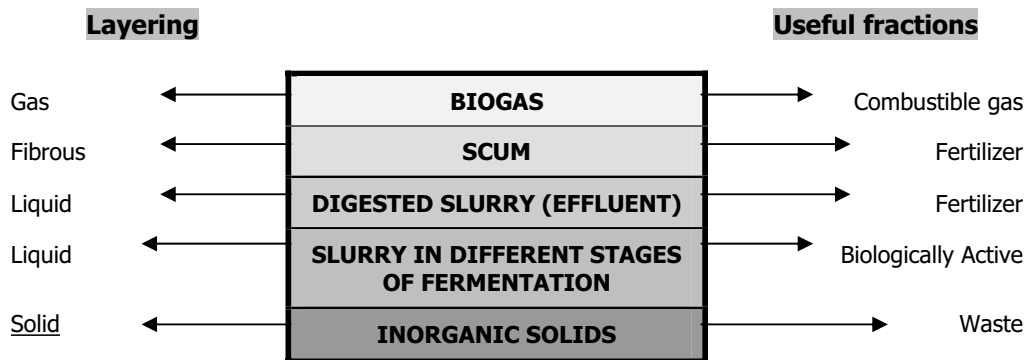
**1.11.2** The heaviest by-product, which is Inorganic Solids will be at the bottom most portion, followed by Digested Sludge, and so on and so forth as shown in the three diagrams– 5, 6 and 7 for three different types of digester.

**a). Biogas:**

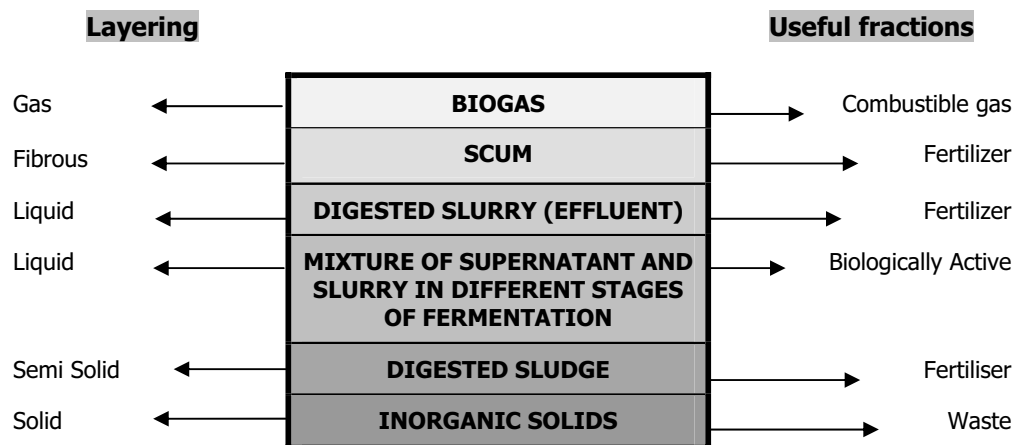
Biogas is a combustible gas produced from the anaerobic digestion of organic matter. Comprising 55-70% Methane, 30-45% Carbon Dioxide, 1-2% of Hydrogen Sulphide and traces other gases.



**Diagram-5: By-products of Batch-fed digester**



**Diagram-6: By-products of Semi-continuous fed digester**



**Diagram-7: By-products of semi-batch fed digester**

**b). Scum:**

Mixture of coarse fibrous and lighter material that separates from the manure slurry and floats on the top most layer of the slurry is called Scum. The accumulation and removal of scum is sometimes a serious problem. In moderate amount scum can't do any harm and can be easily broken by gentle stirring, but in large quantity can lead to slowing down biogas production and even shutting down the BGPs.

**c). Supernatant:**

The spent liquid of the slurry (mixture of manure and water) layering just above the sludge, in case of Batch-fed and Semi Batch-fed Digester, is known as Supernatant. Since supernatant has dissolved solids, the fertilizer value of this liquid (supernatant) is as great as that of effluent (digested slurry). Supernatant is a biologically active by-product; therefore must be sun dried before using it in agricultural fields.

**d). Digested Slurry (Effluent):**

The effluent of digested slurry is in liquid form and has its solid content (total solid-TS) reduced to approximately 10-20% by volume of the original (influent) manure (fresh) slurry, after going through the anaerobic digestion cycle. Out of the three types of digestion processes mentioned above, the digested slurry in effluent-form comes out only in semi-continuous BGP. Digested slurry effluent, either in liquid-form or after sun drying in slurry pits, makes excellent bio-fertilizer for agriculture, horticulture and aquaculture.

**e). Sludge:**

In the batch-fed or semi batch-fed digester where the plant wastes and other solid organic materials are added, the digested material contains less of effluent and more of sludge. The sludge precipitates at the bottom of the digester and is formed mostly of the solids substances of plant wastes. The sludge is usually composted with chemical fertilizers as it may contain higher percentage of parasites and pathogens and hookworm eggs of etc., especially if the semi-batch digesters are either connected to the pigsty or latrines. Depending upon the raw materials used and the conditions of the digestion, the sludge contains many elements essential to the plant life e.g. Nitrogen, Phosphorous, Potassium plus a small quantity of Salts (trace elements), indispensable to the plant growth- the trace elements such as boron, calcium, copper, iron, magnesium, sulphur and zinc etc. The fresh digested sludge, especially if the night soil is used, has high ammonia content and in this state may act like a chemical fertilizer by forcing a large dose of nitrogen than required by the plant and thus increasing the accumulation of toxic nitrogen compounds. For this reason, it is probably best to let the sludge age for about two weeks in open place. The fresher the sludge the more it needs to be diluted with water before application to the crops, otherwise very high concentration of nitrogen may kill the plants.

**f). Inorganic Solids:**

In village situation the floor of the animals shelters are full of dirt, which gets mixed with the manure. Added to this the collected manure is kept on the unlined surface which has plenty of mud and dirt. Due to all this the feedstock for the BGP always has some inorganic solids, which goes inside the digester along with the organic materials. The bacteria cannot digest the inorganic solids, and therefore settles down as a part of the bottom most layers inside the digester. The Inorganic Solids contains mud, ash, sand, gravel and other inorganic materials. The presence of too much inorganic solids in the digester can adversely affect the efficiency of the BGP. Therefore to improve the efficiency and enhance the life of a semi-continuous BGP it is advisable to empty even it in a period of 5-10 years for thoroughly cleaning and washing it from inside and then reloading it with fresh slurry.

## 1.12 **Biogas plant (BGP)**

**1.12.1** Biogas Plant (BGP) is an airtight container that facilitates fermentation of material under anaerobic condition. The other names given to this device are 'Biogas Digester', 'Biogas Reactor', 'Methane Generator' and 'Methane Reactor'. The recycling and treatment of organic wastes (biodegradable material) through Anaerobic Digestion (Fermentation) Technology not only provides biogas as a clean and convenient fuel but also an excellent and enriched bio-manure. Thus the BGP also acts as a miniature Bio-fertilizer Factory hence some people prefer to refer it as 'Biogas Fertilizer Plant' or 'Bio-manure Plant'. The fresh organic material (generally in a homogenous slurry form) is fed into the digester of the plant from one end, known as Inlet Pipe or Inlet Tank. The decomposition (fermentation) takes place inside the digester due to bacterial (microbial) action, which produces biogas and organic fertilizer (manure) rich in humus & other nutrients. There is a provision for storing biogas on the upper portion of the BGP. There are some BGP designs that have Floating Gas-holder and others have Fixed Gas Storage Chamber. On the other end of the digester Outlet Pipe or Outlet Tank is provided for the automatic discharge of the liquid digested manure.

## 1.13 **Classification of biogas plants (BGPs)**

### 1.13.1 **Simple household biogas plants (BGPs)**

- a). A simple Indian household biogas plant can be described as an underground masonry, well shaped fermentation tank connected with inlet and outlet pipe or tanks and covered by an inverted floating or fixed gas storage tank/chamber.
- b). The simple rural household BGPs can be classified under the following broad categories- (i) BGP with Floating Gas Holder, (ii) BGP with Fixed Roof, (iii) BGP with Separate Gas Holder and (iv) Flexible Bag Biogas Plants.

### 1.13.2 **General characteristics of four categories of household biogas plants (BGPs)**

- a). **Biogas plant with floating gas holder:**

This is one of the common designs in India and comes under the category of semi-continuous-fed plant. It has a cylindrical shaped floating biogas holder on top of the well-shaped digester. As the biogas is produced in the digester, it rises vertically and gets accumulated and stored in the biogas holder at a constant pressure of 8-10 cm of water column. The biogas holder is designed to store 50% of the daily gas production. Therefore if the gas is not used regularly then the extra gas will bubble out from the sides of the biogas holder.
- b). **Fixed dome biogas plant with fixed and integrated gas storage chamber:**

The plants based on Fixed Dome concept was developed in India in the middle of 1970, after a team of officers visited China. The Chinese fixed dome plants use seasonal crop wastes as the major feedstock for feeding, therefore, their design is based on principle of 'Semi Batch-fed Digester'. However, the Indian Fixed Dome BGPs designs differ from that of Chinese designs, as the animal manure is the major substrate (feed stock) used in India. Therefore all the Indian fixed dome designs are based on the principle of 'Semi Continuous-fed Digester'. While the Chinese designs have no fixed storage capacity for biogas due to use of variety of crop wastes as feedstock, the Indian household BGP designs have fixed storage capacity, which is 33% of the rated gas production per day. The Indian fixed dome plant designs use the principle of displacement of slurry inside the digester for storage of biogas in the fixed Gas Storage Chamber. Due to this, in Indian fixed dome designs have 'Displacement Chamber(s), either on both the Inlet and outlet sides (like Janata Model) or only one the outlet side (like Deenbandhu or Grameen Bandhu Models).



Therefore in Indian fixed dome design it is essential to keep the combined volume of Inlet & Outlet Displacement Chamber(s) equal to the volume of the fixed Gas Storage Chamber, otherwise the desired quantity of biogas will not be stored in the plant. The pressure developed inside the Chinese fixed dome BGP ranges from a minimum of 0 to a maximum of 150 cm of water column. And the maximum pressure is normally controlled by connecting a simple Manometer on the pipeline near the point of gas utilisation. On the other hand the Indian fixed dome BGPs are designed for pressure inside the plant, varying from a minimum of 0 to a maximum of 90 cm of water column. The Discharge Opening located on the outer wall surface of the Outlet Displacement Chamber and automatically controls the maximum pressure in the Indian design.

c). **Biogas plant with separate gas holder:**

The digester of this plant is closed and sealed from the top. A gas outlet pipe is provided on top, at the centre of the digester to connect one end of the pipeline. The other end of the pipeline is connected to a floating biogas holder, located at some distance to the digester. Thus unlike the fixed dome plant there is no pressure exerted on the digester and the chances of leakage in the Main Unit of the Plant (MUP) are not there or minimised to a very great extent. The advantage of this system is that several digesters, which only function as digestion (fermentation) chambers (units), can be connected with only one large size gas holder, built at one place close to the point of utilisation. However, as this system is expensive therefore, is normally used for connecting a battery of batch-fed digesters to one common biogas holder.

d). **Flexible bag biogas plant:**

The entire Main Unit of the Plant (MUP) including the digester is fabricated out of Rubber, High Strength Plastic, Neoprene or Red Mud Plastic. The Inlet and Outlet is made of heavy duty PVC tubing. A small pipe of the same PVC tubing is fixed on top of the plant as Gas Outlet Pipe. The Flexible Bag Biogas Plant is portable and can be easily erected. Being flexible, it needs to be provided support from outside, up to the slurry level, to maintain the shape as per its design configuration, which is done by placing the bag inside a pit dug at the proposed site. The depth of the pit should as per the height of the digester (fermentation chamber) so that the mark of the initial slurry level is in line with the ground level. The outlet pipe is fixed in such a way that its outlet opening is also in line with the ground level. Some weight has to be added on the top of the bag to build the desired pressure to convey the generated gas to the point of utilization. The advantage of this plant is that the fabrication can be centralized for mass production, at the district or even at the block level. Individuals or agencies having land and some basic infrastructure facilities can take up fabrication of this BGP with small investment, after some training. However, as the cost of good quality plastic and rubber is high which increases the comparative cost of fabricating it. Moreover the useful working life of this plant is much less, compared to other Indian simple Household BGPs, therefore in spite of having good potential, the Flexible Bag Biogas Plant has not been taken up seriously for promotion by the field agencies.

## 1.14. **Functioning of a simple Indian household biogas plant (BGP)**

1.14.1 The fresh organic material (generally in a homogenous slurry form) is fed into the digester of the plant from one end, known as Inlet. Fixed quantity of fresh material fed each day (normally in one lot at a predetermine time) goes down at the bottom of the digester and forms the 'bottom-most active layer', being heavier than the previous day and older material. The decomposition (fermentation) takes place inside the digester due to bacterial (microbial) action, which produces biogas and digested or semi-digested organic material. As the organic material ferments, biogas is formed which rises to the top and gets accumulated (collected) in the Gas-holder (in case of floating gas-holder BGPs) or Gas Storage Chamber (in case of fixed dome BGPs).



bigger than the floating drum BGPs, which takes care of the short-circuiting problems to a satisfactory level, without adding to additional cost of providing a partition wall.

### 1.15.2 Gas holder or gas storage chamber

- a). In the case of floating gas holder BGPs, the Gas holder is a drum like structure, fabricated either of mild steel sheets or ferro-cement (ferro-concrete) or high density plastic (HDP) or fibre glass reinforced plastic (FRP). It fits like a cap on the mouth of digester where it is submerged in the slurry and rests on the ledge, constructed inside the digester for this purpose. The drum collects gas, which is produced from the slurry inside the digester, as it gets decomposed, and rises upwards, being lighter than air. To ensure that there is enough pressure on the stored gas so that it flows on its own to the point of utilisation through pipeline when the gate valve is open, the gas is stored inside the gas holder at a constant pressure of 8-10 cm of water column. This pressure is achieved by making the weight of biogas holder as 80-100 kg/cm<sup>2</sup>. In its up and down movement the drum is guided by a central guide pipe. The gas formed is otherwise sealed from all sides except at the bottom. The scum of the semidried mat formed on the surface of the slurry is broken (disturbed) by rotating the biogas holder, which has scum-breaking arrangement inside it. The gas storage capacity of a family size floating biogas holder BGP is kept as 50% of the rate capacity (daily gas production in 24 hours). This storage capacity comes to approximately 12 hours of biogas produced every day.
- b). In the case of fixed dome designs the biogas holder is commonly known as gas storage chamber (GSC). The GSC is the integral and fixed part of the Main Unit of the Plant (MUP) in the case of fixed dome BGPs. Therefore the GSC of the fixed dome BGP is made of the same building material as that of the MUP. The gas storage capacity of a family size fixed dome BGP is kept as 33% of the rate capacity (daily gas production in 24 hours). This storage capacity comes to approx. 8 hours of biogas produced during the night when it is not in use.

### 1.15.3 Inlet

- a). In the case of floating biogas holder pipe the Inlet is made of cement concrete (CC) pipe. The Inlet Pipe reaches the bottom of the digester well on one side of the partition wall. The top end of this pipe is connected to the Mixing Tank.
- b). In the case of the first approved fixed dome models (Janata Model) the inlet is like a chamber or tank-it is a bell mouth shaped brick masonry construction and its outer wall is slopy. The top end of the outer wall of the inlet chamber has an opening connecting the mixing tank, whereas the bottom portion joins the inlet gate. The top (mouth) of the inlet chamber is kept covered with heavy slab. The Inlet of the other fixed dome models (Deenbandhu and Grameen Bandhu) has Asbestos Cement Concrete (ACC) pipes of appropriate diameters.

### 1.15.4 Outlet

- a). In the case of floating gasholder pipe the Outlet is made of cement concrete (CC) pipe standing at an angle, which reaches the bottom of the digester on the opposite side of the partition wall. In smaller plants (2 & 3 m<sup>3</sup> capacity BGPs), which have no partition walls, the outlet is made of small (approx. 2 ft. length) cement concrete (CC) pipe inserted on top most portion of the digester, submerged in the slurry.
- b). In the two fixed dome (Janata & Deenbandhu models) plants, the Outlet is made in the form of rectangular tank. However, in the case of Grameen Bandhu model the upper portion of the Outlet (known as Outlet Displacement Chamber) is made hemi-spherical in shape, designed to save in the material and labour cost. In all the three-fixed dome models (Janata, Deenbandhu & Grameen Bandhu models), the bottom end of the outlet tank is connected to the outlet gate. There is a small opening provided on the outer wall of the outlet chamber for the automatic discharge of the digested slurry outside the BGP,

equal to approximately 80-90% of the daily feed. The top mouth of the outlet chamber is kept covered with heavy slab.

#### **1.15.5 Mixing tank**

This is a cylindrical tank used for making homogenous slurry by mixing the manure from domestic farm animals with appropriate quantity of water. Thoroughly mixing of slurry before releasing it inside the digester, through the inlet, helps in increasing the efficiency of digestion. Normally a feeder fan is fixed inside the mixing tank for facilitating easy and faster mixing of manure with water for making homogenous slurry.

#### **1.15.6 Gas outlet pipe**

The Gas Outlet Pipe is made of GI pipe and fixed on top of the drum at the centre in case of floating biogas holder BGP and on the crown of the fixed dome BGP. From this pipe the connection to gas pipeline is made for conveying the gas to the point of utilization. A gate valve is fixed on the gas outlet pipe to close and check the flow of biogas from plant to the pipeline.

## **Section- II**

### **BENEFITS OF BIOGAS TECHNOLOGY**

- 2.01** The biogas plants digest, treats and converts biomass or any other biodegradable materials into two useful end products, (a) inflammable gas as fuel and (b) enriched organic manure.
- 2.02** Biogas provides a smokeless, high efficiency fuel for domestic purpose (cooking and lighting), as well as heating and power generation at the village level.
- 2.03** The manure obtained from cattle dung by using biogas plant has a higher nutritive value as compared to that of conventional Farm Yard Manure (FYM) produced from the same dung.
- 2.04** Biogas is a clean fuel and keeps, kitchen, household and the surroundings clean.
- 2.05** Biogas Production Technology is an environmentally sound and Eco-friendly technology and also a Carbon Neutral System. Whatever carbon is produced while burning biogas for energy purpose, at least the same amount (quantity) if not more is offset, directly or indirectly. For example, indirectly by carbon offset due to reduction in deforestation (by replacement of firewood) thus reducing the greenhouse gases to the atmosphere as well as directly through use of biogas digested slurry (bio-manure) for biomass production, which again absorbs carbon from the atmosphere.
- 2.06** Controls environmental pollution and promotes public health through preventing flies and mosquitoes which breed in the fresh dung heaps, staked near the rural house and streets, especially during rainy seasons and prevents, foul odours due to stopping of decomposition in open areas.
- 2.07** Digested slurry if applied directly along with the irrigation water to the crops and tree plantation then less nutrient will be lost from the slurry.
- 2.08** Digested slurry is good for backyard horticulture and kitchen garden, undertaken for supply of nutrition from fresh fruits and vegetables to the rural families as well as, would give additional income to them from the sale of surplus slurry in dried or composted form.
- 2.09** Biogas plants saves time in cooking, cleaning utensils and removing drudgery to women and girl child in the Indian villages.
- 2.10** Biogas is a very safe fuel in village home as it cannot explode easily due to 35-40% CO<sub>2</sub> (Carbon dioxide) in the biogas mixture.
- 2.11** Prevents, eye and lung disease in women and children who are normally in the kitchen when food is cooked on firewood and dung cake in traditional stoves.
- 2.12** Manure prepared from digested biogas slurry has humus apart from all the nutrients and trace elements that enrich, builds and regenerates the soil thus contributing to better and sustainable crop yield.
- 2.13** Application of manure from biogas plant also increases the water holding capacity of the soil, which makes it easily available to plants.
- 2.14** The application of biogas manure changes texture and structure of the soil and makes it porous for better aeration, thus contributing to better crop yields.
- 2.15** Biogas slurry (effluent) can be used for seed treatment, which is found to give better seed germination.
- 2.16** Biogas slurry can be used in the intensive composite pisciculture to give better returns to the farmers.
- 2.17** The dried slurry can be used as feed for poultry and pigs.

## **Section- III**

### **POPULAR DESIGNS OF HOUSEHOLD BIOGAS PLANTS IN INDIA**

#### **3.01 Introduction**

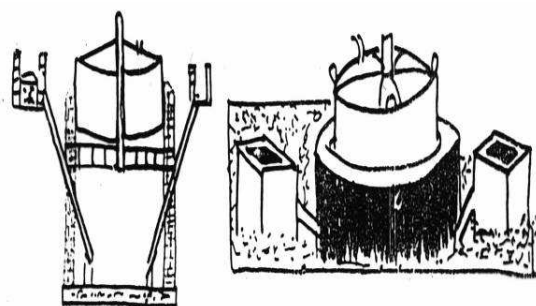
**3.01.1** There are several rural household digesters (biogas plants), which have been designed by different R&D Institutions, in India. However, the Ministry of Non-conventional Sources of Energy (MNES), Government of India has recognized a total of seven models till date for promotion under the National Project of Biogas Development (NPBD). Out of the seven approved models, there are only three models, namely, KVIC, Janata and Deenbandhu, which during the course of time became popular and accepted by rural people at large. In order to ensure correct and foolproof construction of these three models, as per the Indian standard (IS 9478-1986) approved and released by the Bureau of Indian Standards (BIS), well trained technicians & artisans and standard construction manuals should be used for building them.

**3.01.2** Brief description of these three popular Indian models (KVIC, Janata and Deenbandhu) to date, are given below:

#### **3.02 KVIC model BGP**

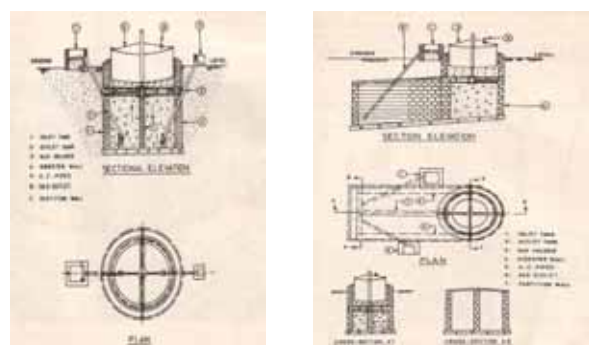
**3.02.1** In 1961-62, the Khadi and Village Industries Commission (KVIC) decided to undertake Gram Laxmi-III model, designed by the Late Dr. Jasbhai Patel, the then Director (Biogas), KVIC in 1956-57, for popularisation. Since then this plant has been associated with KVIC and is now popularly known as KVIC model- refer figure-3 (a) & (b). It is a semi-continuous flow hydraulic digester BGP.

**3.02.2** The KVIC design consists of a deep well shaped underground digesters connected with inlet and outlet pipes at the bottom, just opposite to each other but are separated by a partition wall dividing the digester into two equal parts. The height of the partition walls is  $3/4^{\text{th}}$  of the total height of the digester. A mild steel gas storage drum (gas-holder) is inverted in the digester over the slurry, which goes up and down around a guide with the accumulation & withdrawal of gas. In KVIC model, the cost of steel drum gasholder itself constitutes around 40% of the total cost of the plant. Refer figure-4 (a) & (b).



**Figure-3 (a)**

**Figure-3 (b)**



**Figure-4 (a)**

**Figure-4 (b)**



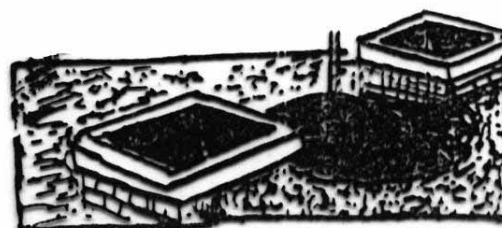
**3.02.3** The gasholders of KVIC model can now be made of Fiber Glass Reinforced Plastic (FRP), Ferrocement and High Density Plastic (HDP), in place of steel gasholder, but till date have not been widely accepted in rural areas.

**3.03 Janata model BGP**

**3.03.1** The Janata model {refer- figure-5 (a) & (b)} is a fixed roof (dome) biogas plant which was developed by GGRS (PRAD), PRI, Lucknow, U.P. in 1978. This is also a semi-continuous flow hydraulic digester BGP.

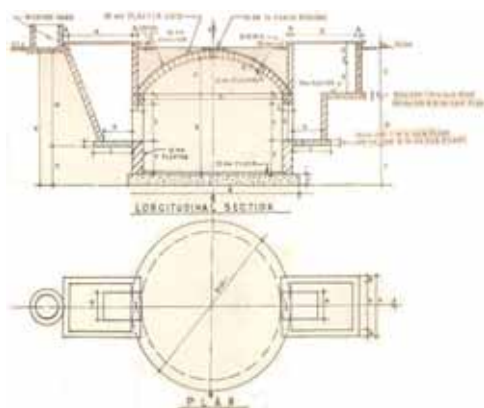


**Figure-5 (a)**

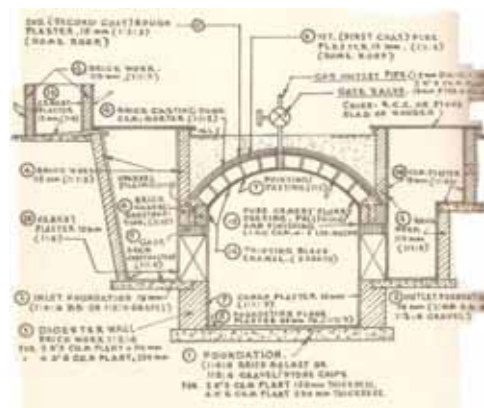


**Figure-5 (b)**

**3.03.2** The main features of Janata BGP are that the digester and gas storage chamber (gas-holder) is integral part of a composite unit made of bricks and cement mortar. The Janata Biogas Plant (JBP) has a cylindrical digester with dome shaped roof. A large 'Inlet Chute' and an 'Outlet Tank' is attached, respectively with the Inlet and Outlet Gate of the Digester. The top end of the Inlet Chute and Outlet Tank is attached respectively to the lower end of 'Inlet Displacement Chamber' (IDC) and to the 'Outlet Displacement Chamber' (ODC) of equal volume (capacities). The upper end of the IDC is connected to the 'Slurry Mixing Tank' with a channel. Whereas, the outlet wall of the ODC has a small opening (known as discharge opening) for directing the digested slurry automatically to the slurry storage pits (or the compost pits) each day when Janata BGP is under regular operation as per the prescribed guidelines-refer- figure-6 (a) & (b). Construction of JBP requires shuttering, form-work and mud mould for making a gas leak-proof dome shaped roof, therefore skilled and properly trained master masons are essential for construction of this model.



**Figure-6 (a)**

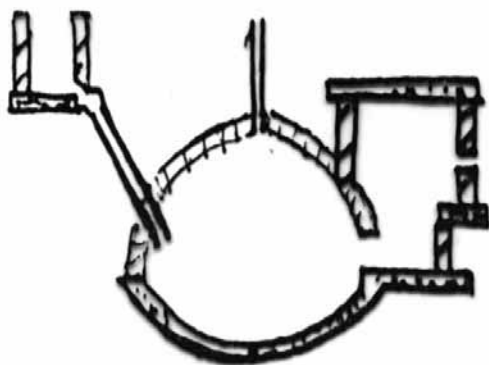


**Figure-6 (b)**

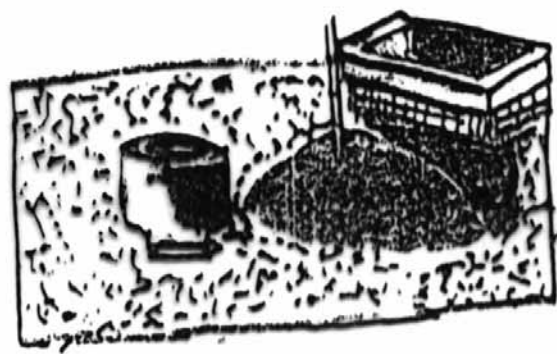
**3.03.3** The JBP costs between 20-30% less than the KVIC model biogas plant.

**3.04** **Deenbandhu model biogas plant**

**3.04.1** The designing and development of this fixed dome (roof) model, was taken up a team of engineers and specialists of AFPRO (of which the author was one of the members), on the recommendation of the NGO network promoting biogas programmes. The objective of Action R&D for the development of this model was to further reduce the cost of rural household (RHh) plants to make biogas technology within the reach of a wider sections of rural society, as the cost of building materials had started going up. The team was successful in designing and fabricating a new low cost fixed dome model BGP which was not only around 20% cheaper than JBP but also more sturdier and simpler to construct, after the master masons were given systematic, brick-by-brick training on the construction techniques of this technology. The reduction in cost was brought about without affecting the strength and efficiency of this new model. This plant was christened as the Deenbandhu (friend of the poor) as the design was a step closer to making this technology within the reach of poorer sections of the community. The Deenbandhu model {figure-7 (a) & (b)} is also a semi-continuous flow hydraulic digester plant.



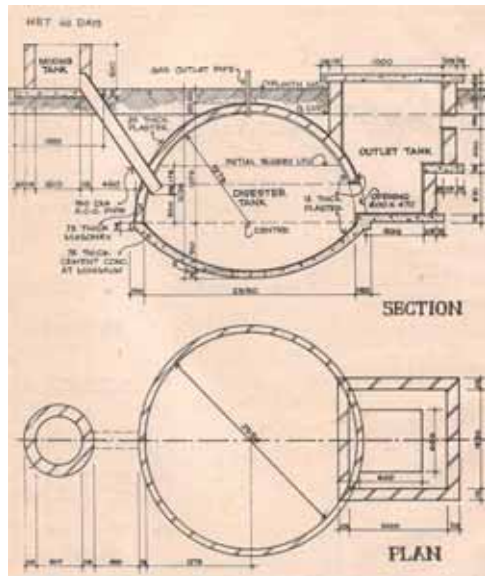
**Figure-7 (a)**



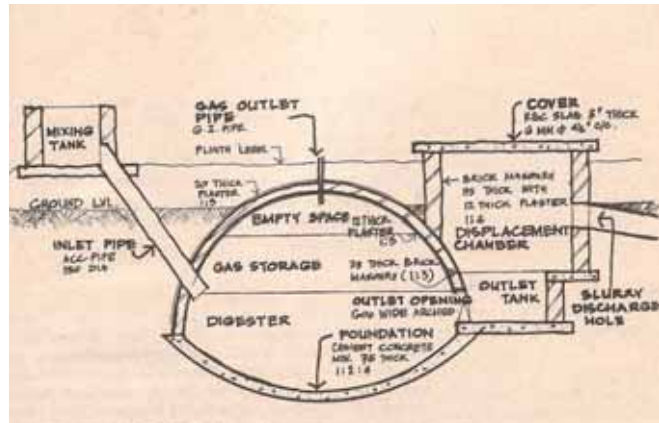
**Figure-7 (b)**

**3.04.2** After intensive trial and testing under controlled conditions as well as, field evaluating it under farmers field conditions, the design and drawings of 1, 2, 3, 4 and 6 m<sup>3</sup> Deenbandhu biogas plants (DBPs) were standardized for promotion as rural household digesters. A manual on Deenbandhu Model was prepared and the design of DBP model was submitted to DNES-Department of Non-Conventional Energy Sources in 1986 (which later became the Ministry of Non Conventional Energy Sources- MNES; and have recently been renamed as the Ministry of New and Renewable Energy- MNRE), Government of India. The DNES approved this model for transfer, promotion and extension under the NPBD from the financial year 1987-88 onwards.

**3.04.3** The Deenbandhu BGP {refer- figure-8 (a) & (b)} is built manly with locally available building materials such as brick, sand, and local skills, in the form of rural master masons. The cement is the only building material that comes from the factory at a distant place but is easily available throughout the country. As the construction of Deenbandhu requires no formwork and shuttering materials, therefore, labour requirement is also reduced. The requirement of cement and bricks are also less as compared to Janata BGP. There is considerable saving in the construction time as compared to Janata BGP due to the simpler and less time-consuming construction techniques.



**Figure-8 (a)**



**Figure-8 (b)**

**3.04.4** The Deenbandhu BGP is the most popular plant in India at present, amongst all the approved designs (models) of MNES, constituting over 75% of the share of annual target of over 100,000 plants constructed each year under NPBD.

## **Section- IV**

### **GRAMEEN BANDHU BIOGAS PLANTS**

#### **4.01 Development of Grameen Bandhu biogas plant**

- 4.01.1** The process leading to the development of Grameen Bandhu biogas plant dates back to the early 1990's, it became clear that the cost of Deenbandhu biogas plant had started going up. It was due to increasing cost of building materials, especially cement and bricks as well as increasing in the wages of master masons and other skilled labourers. As a result of this the over all cost of DBP had also gone up considerably, almost doubled compared to the cost when its design was finalized in 1986. At the same time the Government of India's subsidy for biogas plants were not matching with the cost of building plants due to overall inflation.
- 4.01.2** While on one hand, usefulness of biogas plant had just started being noticed in the villages, on the other hand, the dream of covering the wider sections of rural society was slowly slipping out of the grips of serious and committed extension organisations, especially the grassroots NGOs. This was mainly due to substantial rise in the cost of building materials. Thus the biogas network of NGOs during one of its meetings held in late 1990 recommended that while efforts should be made to reduce the cost of existing biogas models, at the same time attempt be also made to design a new low cost appropriate model. The emphasis should be given to use locally available building materials and local skills without compromising on the quality and strength. Thus the author of this manual initiated Action R&D in 1991 to experiment with different building materials, different methodology of construction of Deenbandhu Plant (DBP) at the Biogas Centres of some of the NGO members of the biogas network who had such facilities. Some of the experiments done were to construct DBP of different sizes using building materials. They were (i) Pre-cast (Pre-fabricated) Cement Concrete (CC) Blocks (or Tiles) to replace Bricks; (ii) Cast DBP with Cement Concrete (CC) at situ by using right size and shape mud mould; (iii) Reinforced Cement Concrete (RCC); and (iv) DBP made of Ceramic Tiles. While all these plants worked well but either they were expensive or cumbersome to construct or both, therefore, did not provide a better option as compared to the existing DBP model made from Bricks; hence, they were not put to further tests under farmers field conditions.
- 4.01.3** In early 1992, after getting enough feed back from the field and his own practical experience and inspiration from the NGO network who were building household biogas plant under NPBD, the author initiated action to make the appropriate design modifications in the existing DBP. The aim of this exercise was to attempt to further reduce the cost, by optimizing design parameters of some of the major components of the existing DBP model.
- 4.01.4** These efforts resulted in redesigning the outlet displacement chamber (ODC) of DBP. Thus the rectangular shaped outlet displacement chamber in the existing DB Biogas plant was replaced with a spherical shaped Outlet Displacement Chamber (ODC). The first prototype of modified DBP with this design (a spherical shaped outlet displacement chamber), using bricks and cement mortar was built in State of U.P. The cost of this new model (modified DBP) came to approximately Rs.500/- less than the existing DBP. The was due to spherical shaped Outlet Displacement Chamber (ODC), resulting in to reduction in surface area as well as a smaller Manhole Opening of 61 cm or 610 mm (2 ft) diameter, requiring much smaller manhole cover for ODC. This modified Deenbandhu model had since been functioning well. However, as it was only a minor success to launch a massive programme for transfer of this model (which also required approval of MNES for getting subsidy under NPBD). Therefore was not promoted seriously, leaving it solely to the discretion of the respective biogas extension NGOs for promotion and extension, in their areas of operation. One of

the grass-roots NGO members of the network got built a few prototype of this model for demonstration, during one of the construction training programmes for rural masons on DBP model. Later on, constructed a few more models of this design on the request of farmers, which are reported to be functioning well.

- 4.01.5** Meanwhile, during this period the author also mooted the concept of the present family of Grameen Bandhu Model, with a view to completely replace the bricks with more environmental friendly civil construction (building) materials. The suggestion for using woven baskets from different types of locally available biomass for building biogas models first came in the middle of 1992, from the Executive Director of a grassroots level women's development organization, the Women's Action for Development (WAFD). The design framework for building fixed dome biogas model using Bamboo Reinforced Cement Mortar (BRCM) was conceived in early 1993 by the author. But the actual experimentation could only be initiated towards the middle of 1993, after collecting all the available information and details on civil construction based on BRCM. Experimentation on small scale were also initiated for using other biomass e.g. pruned mulberry stems and branches, which are readily available in Western UP and presently being used for making baskets by rural poor for livelihood.
- 4.01.6** The experiments for building biogas plants with both bamboo and mulberry cuttings (from pruning) were successful, however, bamboo was preferred as the information on it are more readily available. Moreover it is widely grown world over; and the properties of bamboo as a building (civil construction) material, are well documented. Therefore, to start with the author (chief designer of this new model) decided to use bamboo as the reinforcement material with the cement concrete (mortar), for building this new biogas model.
- 4.01.7** Meanwhile, based on the field visits and several feedbacks during 1993, the author came across a few crucial things related to the implementation of biogas programme of the NGO Network. These aspects, especially the shortcomings needed to be looked into critically, with the objective of improving the ongoing implementation. As well as to also make the future biogas programme, more useful, safer, accident free, ozone friendly; and above all more relevant and meaningful from the point of view of long-term developmental perspective-They are:
- a). The RBC slab of the Outlet displacement chamber (ODC) was deliberately designed by designers to be as the integral part of the DB plant. However, in several cases, the ODC of Deenbandhu model were not covered by RBC slab by plant owners to save on the construction cost to the tune of Rs.200/-. This was a serious thing as it could lead to accident in the village situation, by small animals falling inside the plant through ODC, especially during the dark night if plants were built too close to the narrow Village Street.
  - b). Women masons trained earlier by some grassroots NGOs, could not be involved in the large scale construction of DBP in rural India because of:
    - (i) The socio-cultural reasons to employ trained women masons for plant construction in rural areas of India.
    - (ii) In a few cases the trained women masons were willing to take up construction of Biogas plants but due to family pressure and other constrained could not travel to distance places and stay for longer duration in the field to effectively participate in the construction. They also could not earn a living on regular basis by constructing plants.
    - (iii) It was difficult task for the women master masons to supervise men construction labourers working under them.
    - (iv) Taking up job as masons (mainly far away from their homes) was not likely to reduce drudgery of women masons, as they still had to perform their daily household chores.
- 4.01.8** The analysis of the above two factors {as mentioned in **paragraphs 4.01.7 (a) & 4.01.7 (b)** above} provided ample scope, which inspired the author to once again closely look into the shortcomings in the designs of existing popular Indian fixed dome biogas models (namely,

Deenbandhu and Janata models), if any. The objective was- (a) further optimization in the designs, (b) possibility of improving on the construction techniques; as well as, (c) experimenting with the use of alternate building (civil construction) materials for fabrication/building of simple rural household plants. After closely looking at designs of various popular Indian models, the author decided to concentrate on the Deenbandhu model only, which was still the most popular and cheapest BGP in India. The design of Deenbandhu was more specifically studied from the point of view of overcoming the following existing shortcomings in it, while designing the new low cost biogas plant model.

- a). As the Deenbandhu model had rectangular shaped 'outlet displacement chamber (ODC)', there was further scope to optimize the design by making it spherical (or hemi-spherical) in shape, for saving in building materials and construction time.
- b). The Janata and Deenbandhu models were built completely from bricks, replacing the expensive and energy intensive (non-renewable) steel gasholder required in the case of KVIC model. However, both Janata and Deenbandhu (which was the most popular and cheapest model till date) models required first class bricks for their construction, which were not eco-friendly and environmentally sound proposition. The making of bricks not only involved digging of good quality soil (earth) but also required coal and firewood as fuel (energy) for baking. At the same time, the brick making was not an ecologically sound proposition, and normally required to be transport from distance places to the construction sites of the BGPs. On the other hand, the burning of coal & firewood for baking bricks were also contributing to green house gases in the form of CO<sub>2</sub>. Moreover, production of coal also used non-renewable sources of energy.

**4.01.9** Therefore, the author felt the need to look into the possibility of replacing bricks with environmentally sound and eco-friendly alternate building materials, at the same time ensuring, reduction in energy use, especially the non-renewable sources of energy for building the plants.

**4.01.10** The author was also aware that the development of the proposed new biogas model had to provide the solutions to most of the above mentioned problems in Deenbandhu model, at the same time be environmentally sound and ozone friendly technology. In addition, the new model would have to be equally strong and efficient, use locally available skills and eco-friendly building materials, simpler and cheaper to construction. Further, it could be easily maintained and repaired in the village itself; as well as would promote & generate employment (mainly self-employment) in rural areas, both for landless peasants, artisans and farm women, preferably within a their own villages or within a reasonable distance from their villages.

## **4.02 Grameen Bandhu biogas plant**

**4.02.1** Keeping the above in mind the first prototype model of new biogas plant was conceived by author (designer of the Grameen Bandhu biogas plant) in 1993; and the design for the first prototype was finalized by the author in January 1994, which was built in March 1994. As about 45% of the cost of building this new model goes towards the wages to labourers, therefore the designer/author christened it as Grameen Bandhu (friend of the rural people) plant.

**4.02.2** The Grameen Bandhu plant (GBP), was field tested and found suitable for field demonstration, imparting training on its construction techniques, as well as promotion, transfer and dissemination. Even though, simpler to built, the Grameen Bandhu plant (GBP) is as efficient as the three earlier popular Indian plants, namely (i) KVIC, (ii) Janata and (iii) Deenbandhu model of the same capacity and same HRT, operating under similar conditions. At the same time GBP {figure-9 (a) & (b)} is stronger; and 10 to 15 percent cheaper than the existing least cost most popular Indian BGP- which is the Deenbandhu (DBP) model.

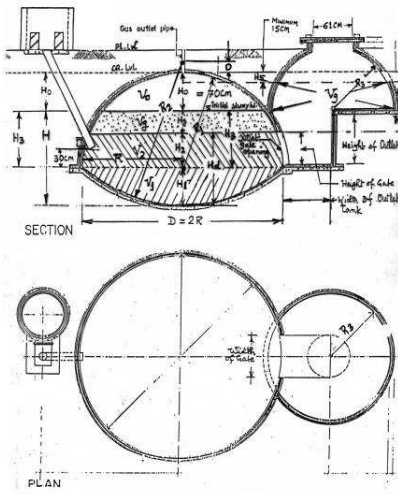


Figure-9 (a)

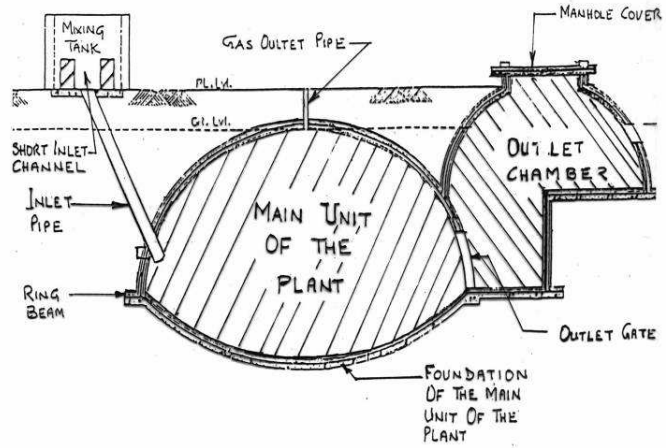


Figure-9 (b)

**4.02.4** This "Practical Pictorial Field Guide on Grameen Bandhu biogas plant" covers in important aspects related to the Grameen Bandhu plant (GBP), which has the maximum potential of being built in India and other South Asian Countries, as well as other developing countries of the world.



## *Section- V*

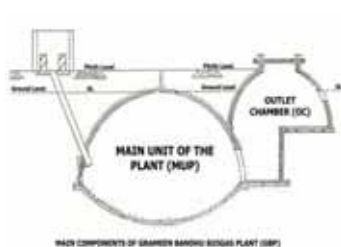
### COMPONENTS OF GRAMEEN BANDHU BIOGAS PLANT (GBP)

**5.01** The Grameen Bandhu (GBP-I) Model is made of two major components and several minor components and sub-components. They are categorized as, (A) Main Unit OF The Plant (MUP), (B) Outlet Chamber (OC) are shown in figure-10 (a), (b) & (c); whereas (C) Other Minor Components are shown in figure-11 (a) & (b). These major and minor components are further divided into sub-components, as given below:

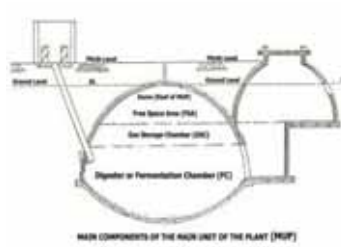
#### **5.02 Main Unit Of the plant (MUP)**

**5.02.1** The Main Unit of the Plant (MUP) is one of the major components of Grameen Bandhu plant (GBP). The MUP has the following six main "Sub-Components":

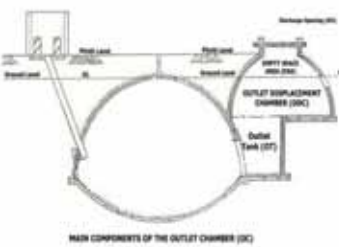
- a). **Digester {or Fermentation Chamber (FC)}**
- b). **Gas Storage Chamber (GSC)**
- c). **Free Space Area (FSA), located just above the GSC**
- d). **Dome (Roof of the plant-entire area located just above the FSA); and**
- e). The following three other sub-components: -
  - [(e)-(i) the **Foundation** of the MUP & (e)-(ii) the **Ring Beam** for MUP (these two have also been considered here as the two **sub-components** of the MUP) and {the **third** is (e)-(iii) the **Gas Outlet Pipe (GOP)**, for better **explanation & understanding** of the **constructional aspects of GBP plant**].



**Figure-10 (a)**



**Figure-10 (b)**



**Figure-10 (c)**

#### **5.03 Outlet Chamber**

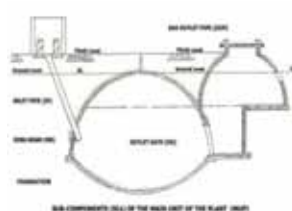
**5.03.1** The Outlet Chamber (OC) is the second major component of Grameen Bandhu plant (GBP). The OC has the following four main "Sub-Components":

- a). **Outlet Tank (OT)**
- b). **Outlet Displacement Chamber (ODC)**
- c). **Empty Space Area (ESA)** above the ODC (though for all practical purpose the ODC includes the Empty Space Area (ESA) above it. However, from the designing point of view, the effective ODC of GBP is considered up to the starting of discharge opening located on its outer wall.
- d). **Discharge Opening (DO)**

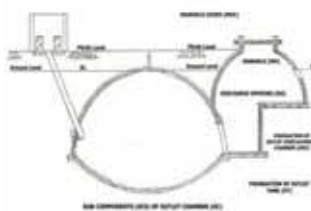
**5.04 Minor components of GBP plant**

**5.04.1** The Minor Components of the Grameen Bandhu plant (GBP)-refer figure-11 (a), (b) & (c) are as follows:

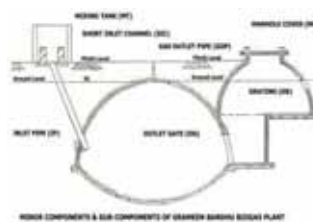
- a). **Inlet pipe (IP)**
- b). **Outlet gate (OG)**
- c). **Mixing tank (MT) or Slurry mixing tank (SMT)**
- d). **Short inlet channel (SIC)**
- e). **Gas outlet pipe (GOP)**
- f). **Grating (made of bamboo sticks)**
- g). **Manhole cover (MHC) for ODC**



**Figure-11 (a)**



**Figure-11 (b)**



**Figure-11 (c)**

**5.05** However, for all practical purpose the components and sub-components can be taken together and can be divided in to eighteen components and sub-components of a Grameen Bandhu plant (GBP), as shown in figure-12, and are briefly described in the subsequent paragraphs:

**5.06 Foundation**

This is a water leak-proof base made of Cement Concrete (CC) at the bottom of the plant pit, having defined diameter and thickness over which the bottom segment (lower segment) of the MUP of the GBP rests. The foundation bears full load of the slurry filled in the digester as well as the weight of the entire plant.

**5.07 Ring beam**

The Ring Beam is cast with BRCM at the junction (meeting point)<sup>3</sup> of the two, inverted bamboo shells, comprising two hemi-spherical surfaces (both segments having exactly the same diameter at their peripheries where they meet each other) of the ellipsoidal shaped MUP of the SBP-I. The function of the Ring Beam is to provide extra strength to MUP at the junction (meeting points) of the Top and Bottom Segments of the MUP. The Ring Beam together with the Foundation of MUP also acts as the load bearing structure of the plant and the load due to the weight of slurry inside the digester; and transfer the total load to the earth, thus provides stability and strength to the entire plant.

<sup>3</sup> The inner side diameter of the Junction of Ring Beam, Top Segment and Bottom Segment of the plant or their diameter at the inner periphery is also the inner diameter of the ellipsoidal shaped Main Unit of the Plant (MUP) of the GPB.

**5.08 Digester (fermentation chamber)**

**5.08.1** In this manual, the term Digester actually refers to the effective digester volume of GBP, which is the volume of the actual Fermentation Chamber and not the combined volume consisting of effective digester (i.e. the rated or designed digester volume) and the Gas Storage Chamber (GSC). This is often the point of confusion in the minds of designers and the field functionaries in respect of Indian semi-continuous fixed dome hydraulic plants. The fermentation chamber (effective digester)<sup>4</sup> of the GBP consists of the entire concave shaped Bottom Segment of the ellipsoidal shaped MUP plus the lower portion of the inverted Top Segment (i.e. up to the Crest of the arch shaped Upper End of the rectangular Outlet Gate Opening)- refer [figure-10 \(b\)](#).

**5.08.2** The combined height of the effective digester (i.e. designed height of fermentation chamber) and the gas storage chamber (GSC) is kept such that, for a given capacity GBP, it will determine (correspond with) the top end of the combined digester volume (fermentation chamber + GSC).

**5.08.3** The Grameen Bandhu plant (GBP) is designed for the effective digester volume (fermentation chamber), of 40 and 55 days HRT, for two different temperature zones in India (refer [Table-II](#)).

**5.09 Gas storage chamber (GSC)**

**5.09.1** In Grameen Bandhu plant (GBP), the Gas Storage Chamber (GSC) is integral part of the MUP and is located just above the imaginary line starting from where the upper portion of the Fermentation Chamber (effective digester volume) ends, as per the designed HRT. In other words, the GSC starts from the top end (crest) of the Outlet Gate opening and extends upwards. The height of the GSC measured upward from the crest of the outlet gate, is determined by the maximum volume of usable biogas to be stored in the GSC under pressure.

**5.09.2** The Indian family size (household digester) plants are designed to store either  $\frac{1}{3}$ <sup>rd</sup> of the daily gas produced (Janata & Deenbandhu model) or to store half of the daily gas produced (KVIC Biogas Plant)<sup>5</sup> in a day of 24 hours. However, in case of Grameen Bandhu plant (GBP) the gas storage chamber (GSC) is designed for two capacities i.e.  $\frac{1}{3}$ <sup>rd</sup> or 8 hours (or 33% of rated gas production capacity) as well as for half (or 12 hours or 50% of the rated gas production capacity). This is to provide choice (option) to the prospective plant owner, to select from two different gas storage capacity of GBP-I model.

**5.09.3** The combined volume of slurry inside the MUP would be equal to the volume of the fermentation chamber plus the volume of GSC, which is equal to the selected HRT of the SBP-I x daily slurry input + GSC Capacity of GBP<sup>6</sup>.

**4** When the slurry (mixture of fresh cattle manure to water ratio of 1:1) is filled up to the level of the crest of the arch shaped upper end of the rectangular outlet gate opening, the volume of slurry would be equal to the volume of fermentation chamber (effective digester volume). This volume is determined by the HRT selected for a GBP. For Example:- for a 2 m<sup>3</sup> capacity plant of 40 days HRT, the volume of fermentation chamber (effective digester) would be equal to [(50 kg fresh cattle manure + 50 litres of water) x 40 days] = 4,000 litres or 4 cum. Whereas for a 2 m<sup>3</sup> capacity plant of 55 days HRT, the volume of fermentation chamber (effective digester) would be equal to [(50 kg fresh cattle manure + 50 litres of water) x 55 days] = 5,500 litres or 5.5 cum and so on.

**5** Normally, the Indian family size (household digester) plants are either designed to accommodate  $\frac{1}{3}$ <sup>rd</sup> of the daily gas produced in a day of 24 hours (i.e. 8 hours or 33% of the rated (design) gas production capacity of the plant) as in the case of the two fixed dome models Janata and Deenbandhu or to store half of the daily gas produced in a day of 24 hours (i.e. 12 hours or 50% of the rated gas production capacity of the plant) as in the case of KVIC biogas plant.

**6** During the initial loading (charging) of GBP the slurry (mixture of fresh cattle manure to water ratio of (1:1) is filled up to the level of the combined height of the effective Digester (i.e. the designed height of Fermentation Chamber) and the Gas Storage Chamber (GSC)}, and the combined volume of slurry would be equal to the volume of fermentation chamber (effective digester volume) plus Gas Storage Chamber (GSC). This is equal to the selected HRT of the GBP x daily slurry input + GSC Capacity of GBP plant. For example: - for a 2 m<sup>3</sup> capacity plant of 40 days HRT and

- 5.09.4** Thus for a correctly designed MUP, the fermentation chamber (effective digester) will hold slurry which is 40 or 55 days old- the number of days will depend upon the selection of HRT of GBP. Whereas the digested slurry that is more than 40 or 55 days old will be lighter (after it has produced optimum biogas due to fermentation) would be held inside the Gas Storage Chamber (GSC). This is to ensure that as far as possible the undigested slurry or partially digested slurry doesn't go out with the fully digested slurry through outlet gate of the plant along with the older digested slurry.
- 5.09.5** When the plant is accumulated with biogas, it displaces equal quantity of digested slurry (after the optimum gas production potential of the slurry is tapped) from the Gas Storage Chamber-GSC (located just above the fermentation chamber) into Outlet Displacement Chamber-ODC.
- 5.10** **Free space area (FSA) {located between GSC & dome of plant}**
- 5.10.1** The Free Space Area (FSA) starts from where the upper portion of the Gas Storage Chamber (GSC) ends. For easy reference and all practical purposes FSA can be taken as a sub-component of the Dome but in this sub-section, it is treated as separate sub-component of the Main Unit of the Plant (MUP) for better understanding.
- 5.10.2** As the Free Space Area (FSA) is also very important from the point of view of designing the SBP-I plant, therefore, it is shown separately in the diagram- refer figure- 10 (b), for better explanation to get clear understanding of its role and importance, as elaborated in this section.
- 5.10.3** While designing the GSC, it is assumed that whatever gas is collected in the Free Space Area (FSA) above the initial slurry level of the GBP, cannot be used. The reason for this is that this biogas would normally be at a slightly higher than zero pressure above the atmospheric pressure for a correctly constructed Grameen Bandhu plant (GBP). This means that the biogas generated initially inside the plant will be stored in the Free Space Area (FSA), just above the slurry level and up to the Dome Ceiling. But the biogas inside the FSA cannot be utilized in the appliances even when the gas outlet pipe is opened at this stage, due to lower pressure than required. After enough biogas is produced to exert a minimum pressure of 100 mm (4") water column on the slurry inside the Combined Digester Volume<sup>7</sup> then the quantity of gas which is above this pressure (100 mm or 4") could be utilized in biogas appliances, is termed as the Usable biogas. The pressure of this biogas inside the MUP of the GBP is ascertained by measuring the total height of the slurry, displaced from the GSC into the ODC.
- 5.10.4** The maximum quantity of usable gas stored in any Grameen Bandhu plant (GBP) could be either be up to 33% or up to 50% of daily gas production, depending upon the choice of GBP model for a particular gas storage capacity. It is important that construction of a GBP is done keeping in view that in a functioning plant; the slurry levels under the following five situations would be at the same height, to ensure maximum storage of biogas in the unit as per the rated (design) capacity of GSC. They are (i) the initial slurry level after filling the plant with fresh slurry mixture, just before the commissioning of the plant, (ii) the level at the time when all the usable gas is utilized, (iii) the level of slurry in the Gas Storage Chamber (GSC), (iv) the level of slurry in the Outlet Displacement Chamber (ODC) and (v) the level of slurry in the Inlet pipe (IP).

---

33.33% Gas Storage Capacity, the combined volume of the Fermentation Chamber and the GSC would be equal to [(50 kg fresh cattle manure + 50 litres of water) x 40 days] + (0.33 x 2 m<sup>3</sup>) = 4,000 lts. + 330 lts. = 4330 lts. = 4.33 cum. Whereas for a 2 m<sup>3</sup> capacity plant of 55 days HRT and 33.33% Gas Storage Capacity, the volume of fermentation chamber (effective digester) would be equal to [(50 kg fresh cattle manure + 50 litres of water) x 55 days] + (0.33 x 2 m<sup>3</sup>) = 5,500 lts + 330 lts. = 5,830 lts. = 5.83 cum and so on.

7 Combined digester volume includes the volume of the Fermentation Chamber plus the Gas Storage Chamber (GSC) of the MUP of GBP.

**5.10.5** During the regular use of gas, the slurry level in the plant reaches the zero level, even then there will still be some biogas left in the Free Space Area (FSA) just above the slurry level up to the dome portion. However, as the biogas pressure at this stage would be just above the zero atmospheric pressure level, therefore, this gas will be only occupying the FSA but cannot be utilized in the appliances.

**5.11** **Dome**

**5.11.1** The "Dome" is spherical shaped roof of the Grameen Bandhu plant (GBP), which is integrated with the Free Space Area (FSA) and the Gas Storage Chamber (GSC). The dome covers the entire upper (top) portion of the plant just above the Free Space Area (FSA). The Top (Highest Point) of Dome is known as Crown of the dome, where the gas outlet pipe (GIP) is fixed.

**5.12** **Gas outlet pipe (GIP)**

The "Gas outlet pipe" (GIP) is made of 100 mm or 10.0 cm (1 inch) diameter and 175 mm or 17.5 cm (7 in.) long galvanized iron (GI) pipe. The bottom end of GIP has treads cut into it for fixing it inside an appropriate size socket. The two opposite ends of this socket have two flat (or round) iron pieces welded to it. These flat iron pieces are embedded inside the "crown" of the dome to ensure that the Socket is properly fixed there at the time of casting and plastering of the "top segment of the MUP". This is to ensure that no biogas leakage takes from the sides of dome where the socket of the GIP is fixed to it. The top end of GIP is also treaded so that the "gate valve" can be fitted to the GIP after the GBP biogas plant is constructed, cured & painted from inside, and ready for initial feeding with feed stock for biogas production. Due to this, if at later stage, for any reasons, the GI pipe of the GIP unit gets damaged then it can be easily taken out by un-screwing it from the fixed socket and replacing it with a new one, without damaging the entire GIP unit. GIP unit is the only sub-component of GBP and is made of metal.

**5.13** **Inlet pipe (IP)**

**5.13.1** The "inlet pipe" (IP) for directing the fresh slurry in the GBP is made from 100 mm (4") diameter AC (Asbestos cement) pipe that is readily available throughout India. The top end of the inlet pipe (IP) is connected to the discharge end of the short inlet channel (SIC); whereas the other end of the IP goes inside the digester (fermentation chamber) at an appropriate angle and rests on a supporting pillar of appropriate height. It is properly fixed (joined) to the digester wall so that it (IP) doesn't move and come out. The main function of inlet pipe is to direct the well-mixed fresh slurry inside the fermentation chamber of the plant.

**5.14** **Outlet chamber (OC)**

**5.14.1** The "Outlet chamber" (OC) is divided into two major sub-components- (i) the Outlet tank (OT) and (ii) the Outlet displacement chamber (ODC). Both these sub-components are joined to each other, described below:

**5.15** **Outlet tank (OT)**

**5.15.1** It is a rectangular shaped structure with two steps, one end of which is connected to the bottom end of outlet gate. The surface of the second step in the "Outlet tank" (OT) is the bottom surface of the "outlet displacement chamber" (ODC) and is in the same line as the top edge of the gas storage chamber (GSC).

**5.15.2** The outlet tank (OT) is made of BRCM by joining four flat rectangular pieces of woven bamboo panels to fabricate (construct) its four sides and casting it with cement mortar in appropriate ratio. At the time of initial feeding (loading) the fresh slurry is filled up to the second step, counted from the bottom. The size of OT is designed big enough, to enable a medium sized person to go inside and come out of the MUP.

## **5.16 Outlet displacement chamber (ODC)**

**5.16.1** The "Outlet displacement chamber" (ODC) of Grameen Bandhu plant (GBP) is hemi-spherical in shape and made of BRCM. The effective volume of ODC is only taken up to the discharge opening provided on the surface of its outer wall. The portion above this discharge opening is only an empty space. The volume of effective ODC has to be the same as the GSC. The "empty space area" (ESA) located above the Discharge Opening (DO) is not of any great importance except for providing symmetry and shape and for making manhole at its centre, on the crown of the ODC. The manhole is always kept covered (closed) with an appropriate size "Manhole cover" (MhC). This is to prevent, either the rainwater, or living things or any other materials falling inside the ODC and therefore, it has been kept as small as possible. A portion of the bottom surface of ODC is connected to the top end of the outlet tank; whereas one part of the bottom end of ODC rests on the outer surface of MUP- this is located just above the GSC portion of the wall of the MUP and the balance portion rests on the foundation of ODC, made on the levelled earth below it. On the top of ODC, a 60 cm or 600 mm (2 ft.) diameter manhole opening is provided to facilitate easy entry or coming out of one medium size person at a time from the digester (MUP) via the rectangular outlet tank (OT). The manhole opening is covered with the pre-fabricated BRCM cover to prevent any living thing (human being, domestic animals etc) accidentally falling inside the plant through the outlet displacement chamber (ODC).

## **5.17 Discharge opening (DO)**

**5.17.1** The outer wall of the outlet displacement chamber (ODC) has small opening called as "Discharge opening" (DO), located at a pre-determined height, to allow the digested slurry equivalent to between 80 to 95% of the daily feed, automatically discharged into, either the slurry drying pits or directly into the compost pits. The height of lower end of the discharge opening (located at surface of the outer wall of ODC) is always kept lower than the highest point on the ceiling of the dome of the MUP [this point is in the centre (crown) of the plant dome where the gas outlet pipe is fixed] to prevent choking (or blocking) of gas outlet pipe, by either the slurry or the foam from the fermented slurry, entering in to it. From the field experience of earlier two popular fixed dome models- Janata and Deenbandhu models- the minimum height of the highest point on the dome ceiling of the MUP of GBP should be kept as 150 mm (6") from the bottom end of the OD, located at the outer surface of the wall of the ODC.

## **5.18 Outlet gate (OG)**

**5.18.1** The "Outlet gate" (OG) is provided at the outlet wall of the digester of the plant. The bottom surface of the opening of the outlet gate is connected to the bottom end of the Outlet Tank (i.e. the first step from the bottom surface of the outlet chamber-OC).

**5.18.2** Main functions of the outlet gate are- (a) to be used as entry and exit for persons (one person at a time) in and out of the MUP; (b) for the outward movement of displaced slurry from gas storage chamber (GSC) in to the outlet displacement chamber (ODC) due to accumulation and pressure of biogas in the GSC; (c) for the inward movement of slurry from ODC into digester at the time of gas utilization; and (d) to be used as an opening for emptying the digester for cleaning or testing of plant leakage in future.

**5.18.3** In addition, if and when required, only to a very, very limited extent, the outlet gate can also be used for stirring the digester slurry by means of a long and slightly bent bamboo pole or stick; however, by and large, it is very difficult to do stirring of slurry from the outlet gate in the case of GBP due to only a small size manhole on top (crown) of the ODC. In view of this, a special provision has been made on the inlet side of GBP for stirring the slurry in an effective manner, as explained under sub-heading-"Mixing tank".

**5.18.4** The size of the Outlet Gate (OG) for the smallest family size GBP model is kept large enough for a medium size adult to go inside and come out of the plant without any inconvenience. For a larger capacity plants, the size of the Outlet Gate (OG) can be increased to a practical size.

**5.19 Mixing tank (MT)/Slurry mixing tank (SMT)**

**5.19.1** The "Mixing tank" (MT) is sometime also referred as "Slurry mixing tank" (SMT) and is fitted with a feeder (mixing) fan inside it. The MT of GBP is made of BRCM and located on the top end of the inlet pipe. Main function of this tank is to prepare a homogenous slurry mixture before it is released into the digester to achieve better efficiency of fermentation of organic materials.

**5.19.2** The outlet opening of the mixing tank (MT) is connected to the inlet pipe (IP) through the short inlet channel (SIP). The lower end of the mixing tank wall has a 75 mm (3") diameter "Inlet slurry opening" (ISO) which opens in the short inlet channel (SIC); whereas, the other end of this channel is connected to the top end of the inlet pipe (IP). Just on the opposite lower end of this 75 mm (3") inlet slurry opening (ISO), a 25 mm (1") diameter opening is provided for removing the dirt, mud, silt and any other finer particles of inorganic materials (mixed with dung as it is normally kept on the dirty and unplastered floor in villages) from mixing tank (MT).

**5.19.3** The Mixing Tank of GBP is placed on one side of the Inlet Pipe (IP) in such a manner that the IP can be conveniently used for stirring the slurry inside the plant, using a right size bamboo pole or stick. In view of this, the most ideal location for placement of mixing tank is at right angle to the line of Inlet Pipe, on one side of the surface of the MUP, to facilitate better stirring of the GBP. Normally, during the mixing and preparation of slurry in the mixing tank, using the "Feeder fan", a 'slurry stopper' (made either of wooden plank or iron plate) closes the 75 mm (3") diameter "Inlet slurry opening" (ISO). As and when the slurry is to be released, the slurry stopper is lifted and the homogeneously mixed fresh slurry goes inside the digester of GBP plant through "Short inlet channel" (SIC) via the inlet pipe (IP).

**5.19.4** In order to make uniform homogenous slurry; it is advisable to fabricate a properly designed feeder fan for the mixing tank.

**5.20 Short inlet channel (SIC)**

The "Short inlet channel" (SIC) connects the outlet opening of the mixing tank with the top end of inlet pipe. Function of SIC is to guide & direct the slurry from the mixing tank to the inlet pipe.

**5.21 Gas outlet pipe (GOP)**

**5.21.1** A small piece of galvanized iron (GI) pipe is fixed at the crown of the plant dome during the construction, and is called as "Gas outlet pipe (GOP). An appropriate size 'Gate valve' is fixed to this pipe for controlling the gas flow and cutting of the gas connection from the plant to the pipeline when not in use.

**5.21.2** The pipeline for conveying the biogas to the point of use is fixed to one end of the gas outlet pipe, which is dealt in detail in Section- VII of this "Pictorial Field Guide".



**5.22 Grating**

**5.22.1** The 'Grating' made by weaving bamboo mats, has been suggested (to the plant owners, which can be provided with minor additional cost) as an additional precautionary measure for protecting any one (especially small animals) falling accidentally inside the plant. The grating is an added feature of the Grameen Bandhu plant (GBP), which is not there in the other two Indian fixed dome models (Janata and Deenbandhu) plants. The Grating is made of 25-mm (1") diameter bamboo sticks and is placed and tightly fixed on top of the second step (from the bottom) of the outlet chamber (OC).

**5.22.1** The size of this grating is made as per the size of the horizontal opening (facing the sky) of the outlet tank (OT). However, grating is optional, as some of the plant owners prefer GBP without it, as there is manhole cover (MhC) which is much easier to covers the manhole of the OC.

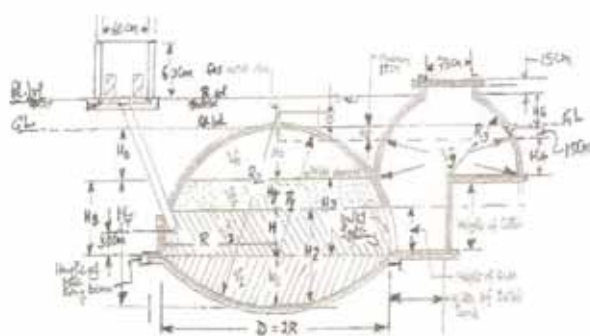
**5.23 Manhole cover (MhC) for ODC**

**5.23.1** In the case of Grameen Bandhu plant (GBP), the ODC is designed in the shape of hemi-spherical structure. Due to this, there is only a small size manhole opening, having a 60 cm or 600 mm (2-ft) diameter, is provided on the top (crown) of ODC of the SBP-I model. Thus an appropriate size of circular slab, known as "Manhole cover" (MhC) to cover (close) the manhole opening of the ODC of GBP, is substantially reduced.

**5.23.1** The Manhole cover (MhC) is made of BRCM which can be easily placed on top of the Manhole, for closing it, and is comparatively much cheaper than making RCC or RBC slabs for closing a large size rectangular opening of the 'outlet displacement chamber' (ODC) in the case of Deenbandhu model biogas plant.

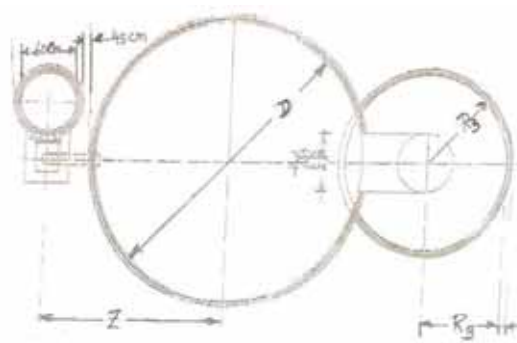
**5.24 Notational dimension sketch of GBP**

**5.24.1** The key notational dimensions of the Grameen Bandhu biogas plant (GBP) is given in figure-12 (a) and 12 (b) used for calculating the various dimensions of the GBP.



**SECTIONAL ELEVATION**

**Figure-12 (a)**

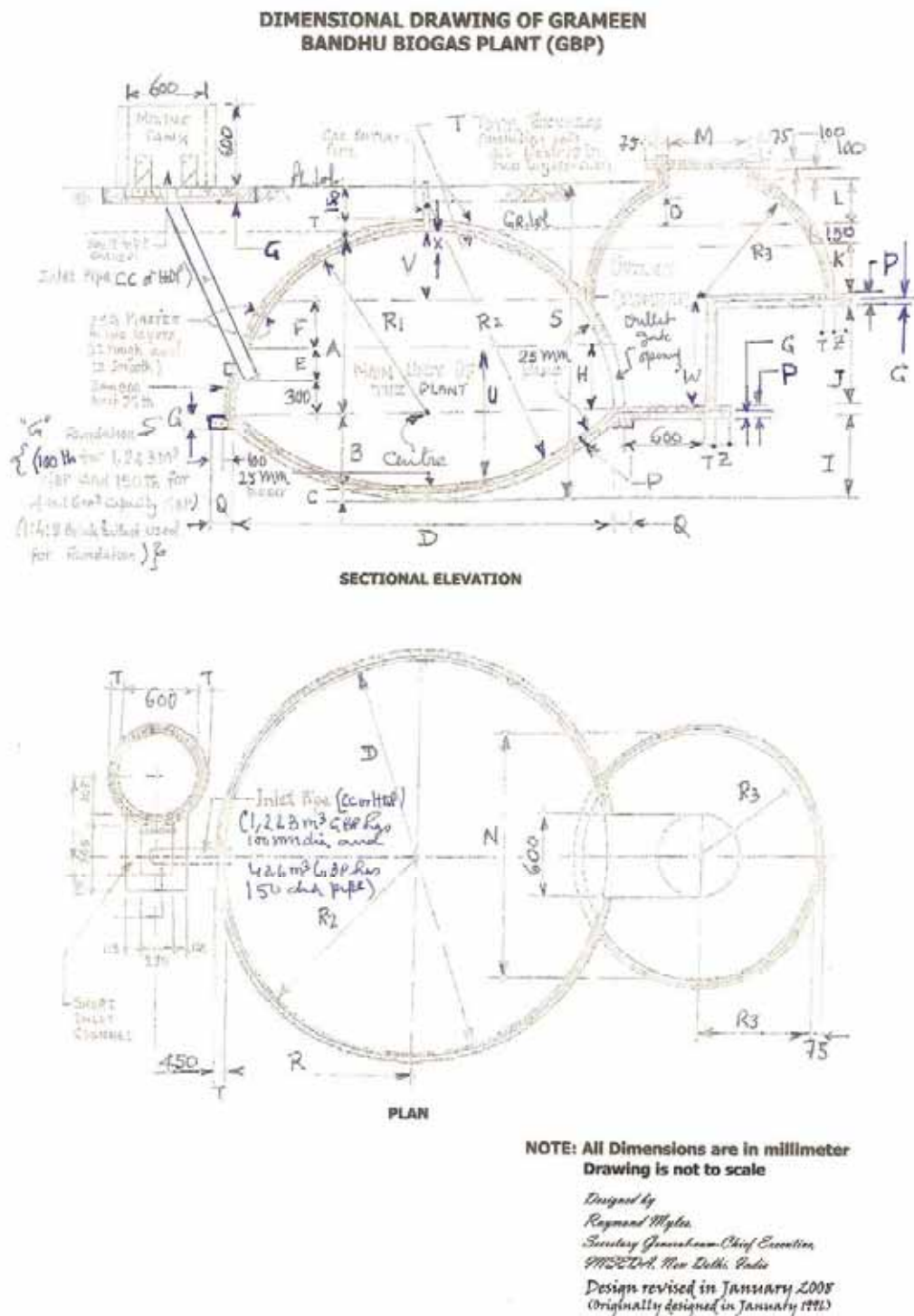


**PLAN**

**Figure-12 (b)**

**5.25 Notational dimension sketch of GBP**

**5.25.1** The notational dimensional drawing of the Grameen Bandhu biogas plant (GBP) is given in figure-13.



**Figure-13 (a)**

**Table- IV**

**Dimensions of Grameen Bandhu Biogas Plant (GBP)**

{Hydraulic Retention Time (HRT)= 40 Days}

(Original calculation on Jan 1, 1996- Revised on Jan 1, 08 based on practical experience)

Notation	1 M <sup>3</sup>	2 M <sup>3</sup>	3 M <sup>3</sup>	4 M <sup>3</sup>	6 M <sup>3</sup>
A	1050	1275	1450	1590	1800
B	420	510	580	636	720
C	100	100	100	150	150
D	2100	2550	2900	3180	3600
E	70	245	350	420	570
F	180	175	200	240	290
G	100	100	100	150	150
H	295	470	575	645	770
I	570	660	730	836	920
J	400	570	700	810	960
K	350	400	430	460	460
L	335	160	95	95	5
M	730	730	730	730	730
N	1400	1540	1800	2000	2400
O	138	148	183	102	268
P	150	150	150	200	200
Q	150	150	150	200	200
R <sub>1</sub>	1050	1275	1450	1590	1800
R <sub>2</sub>	1758	2083	2363	2528	2988
R <sub>3</sub>	700	770	900	1000	1200
S	1845	2160	2405	2681	2975
T	75	75	75	105	105
U	790	1055	1230	1356	1590
V	500	555	600	630	640
W	475	645	775	885	1060
X	390	485	530	546	630
Z	150	150	150	200	200

All dimensions are in millimeters

## ***Section- VI***

### **PICTORIAL DEPICTION OF IMPORTANT STAGES OF CONSTRUCTION OF GRAMEEN BANDHU BIOGAS PLANT(GBP)\***

- 6.01** The Grameen Bandhu plant (GBP) can be best described as the Bamboo Reinforced Cement Mortar (BRCM) plant. The reason for this is that its construction technique falls in between the RCC (Reinforced Cement Concrete) and Ferro-cement. In fact its construction methodology can be said to be more close to that of Ferro-cement. The GBP, being simple, is very easy to built (i.e. fabricated and constructed) under field conditions, even in remotest areas of the region and country. After systematic training of rural artisans (masons and women bamboo weavers) this low cost technology can be easily built (fabrication or pre-fabrication of bamboo structures and construction of plant at the farmers' site) by them. This is due to use of over 90% of locally available building materials and use of local and traditional skills available in rural areas, since centuries.
- 6.02** All the conventional (semi-continuous hydraulic digester) fixed dome Indian biogas plants; e.g. Janata and Deenbandhu models use bricks and cement concrete as the building materials. However, for quite sometime, the need was being felt to not only cut down on the construction cost of existing biogas plants but also utilise eco-friendly building materials in place of bricks for plant construction. Alternatively, to design an altogether new biogas model that would have both the advantages, without compromising on the strength. Keeping this in view, the Grameen Bandhu family of Biogas plants were developed and designed by the author based on his long field experience of working with all the aspects of low cost biogas technology, more specifically the two popular fixed dome Indian household plants, namely, Janata and Deenbandhu models.
- 6.03** A few family size plants of Grameen Bandhu plant (GBP) model are in operation for over one decades now and have been found to be working satisfactorily as a simple semi-continuous hydraulic digester biogas plant.
- 6.04** In this design (GBP model) a large ellipsoidal shaped structure, called as the "Main Unit of the Plant" (MUP) is woven with bamboo strips in two segments and are joined together tightly using binding wires. The "MUP" of the Grameen Bandhu plant (GBP) is made by joining these two bamboo baskets (each of which is actually segment of different spheres of two different diameters) at their open ends to form an ellipsoidal shaped structure. The diameters of these two baskets-like structures at their peripheries (i.e. at their open-ended bases) are the same; therefore, they will perfectly match each other). When joined together at their junction and properly tied using binding wire, the shape of MUP thus formed would look almost like an oval shaped football. However, only the top structure of the entire composite bamboo structure, placed inside the plant pit can be seen from outside, thus from outside the MUP would look like a hemi-spherical basket shaped shell structure.
- 6.05** Joining two fabricated or pre-fabricated woven bamboo shells in the shape of two baskets makes the Main unit of the plant (MUP) of GBP model. One of them, which comprise the bottom segment of the MUP, is shallower and looks like a big dish. The bottom segment (which constitutes the lower portion of the digester or fermentation chamber) also acts as the base of the MUP of GBP model and rests on the surface of the foundation of the appropriate size plant pit, as per the dimensional drawing. The bottom segment once cast becomes an integral part of the foundation of MUP and along with it also acts as the load bearing structure of the unit; as well as carries the weight of slurry inside the plant. Whereas, the 'top segment' is a larger hemi-spherical shaped bamboo shell

structure, which looks like a very big deeper basket, and is placed inverted on top of the dished shaped (looks like a shallow basket) bottom bamboo structure.

- 6.06** The cement mortar in the appropriate ratios, is used for casting (both from outside and inside) the woven bamboo surface of the MUP. Two coats of plasters, each follow this, on the outer and inner cast surfaces, to form a continuous BRCM structure for MUP.
- 6.07** In the same manner other components, sub-components and minor components of GBP model are made of BRCM structures, as described in detail in the GBP manual.
- 6.08** The Grameen Bandhu plant (GBP) being made of Bamboo Reinforced Cement Mortar (BRCM), has substantial advantage especially for building it in remote and other areas where quality bricks, stones etc. are not easily available but bamboo is either available or its cultivation can be easily promoted.
- 6.09** As the bamboo reinforced structures can be either fabricated or pre-fabricated at any place, the rural women, landless peasants, unemployed rural youth and other marginalized sections of rural community etc. can be trained to fabricate these woven structures from bamboo strips. This activity would promote regular income generating activities & opportunity of self-employment on massive scale in rural areas.
- 6.10** The Grameen Bandhu plant (GBP) built using bamboo as the alternate building material is between 10 to 15% cheaper than the Deenbandhu model. The Deenbandhu model is at present the most popular fixed dome Indian BGP in the country, constituting aver 75% of the total target achieved under the Government of India sponsored biogas scheme, the National Project on Biogas Development (NPBD) with current annual target of rural household plant of around over 100,000.
- 6.11** The photographs showing important stages of building (pre-fabrication and on-the-site construction of Grameen Bandhu plant (GBP), with brief description about them given in this Section is only to supplement the 'Construction methodology' described in detail given in the "Comprehensive Manual on Grameen Bandhu biogas technology", to build a GBP. The pictorial depiction of important stages of this model (GBP) is described in this section can act as an effective guide for correctly building this model, only by trained artisans (master masons and master weavers), technicians and supervisors.
- 6.12** The building of Grameen Bandhu plant (GBP) is done by systematic trained (preferably experienced) artisans (male & female), in two phases [i.e. (i) Weaving of Bamboo Structure (preferably by master women weavers in their own villages) and, (ii) Construction of this model at farmers site (by trained master masons), as two separate activities], as described through the "pictorial depiction in this Section of the field guide".

**PICTORIAL DEPICTION OF IMPORTANT STAGES OF BUILDING OF GRAMEEN BANDHU BIOGAS PLANT (GBP)**

**I. Fabrication and pre-fabrication of bamboo structures {(weaving using 0.5 in (12.5 mm or 1.25 cm)} bamboo strips for Grameen Bandhu model biogas plant (photograph nos. 1 to 16)}**



**1 (a)**



**1 (b)**



**1 (c)**

**PHOTOS-1 (a), (b) & (c):** Seasoned Bamboo Poles (2 inch outer diameter and 12 feet length and ¼ thickness), selected after thorough inspection for their suitability for weaving structures for Grameen Bandhu plant (GBP)- (1 (a) selection of appropriate quality and size seasoned bamboo; 1 (b) Purchased bamboo (brought to the site where it will be woven in to different structures for making different components and sub-components of the GBP; and 1 (c) Correct storage of bamboo under the temporary shed till used for weaving



**2 (a)**



**2 (b)**



**2 (c)**

**PHOTO-2 (a), (b) & (c):** Bamboo (after lengthwise, splitting in to 4 strips of 1 in (2.5 cm each), are immersed in water channel or tank and kept there for 12 to 24 hours (at least overnight). Later on these strips are further made in to 0.5 in (1.25 cm) strip. Only 0.5 in (1.25 cm) strip are used for weaving the different sizes of bamboo structure for GBP  
(**Note:** Bamboo strips are to be soaked in the water with organic fungicides (e.g., Neem Oil etc) in the ratio of 1 kg to 100 l. water, for 12 hours (overnight)





**3 (a)**

**3 (b)**

**PHOTO- 3: (a) & (b):** Taking out & making appropriate size bamboo strips as per the requirement with simple hand tools  
*[(Note: The bamboo strips are to be soaked in the water with organic fungicides (like, Neem Oil etc) in the ratio of 200 gram to 100 liter water, for overnight (or at least 12 hours), before using them for weaving bamboo shells for GBP]*



**4 (a)**

**4 (b)**

**4 (c)**

**PHOTO-4: (a), (b) & (c)** Appropriate size inverted dome shaped excavations made in the ground for weaving bamboo shells for casting GBP. Photo-4 (a) Mould for making hemispherical shaped Top Segment of Plant (TSP), Photo-4 (b), Mould for making dish shaped Bottom Segment of Plant (BSP); and . Photo-4 (c) Mould for hemispherical shaped Outlet Displacement Chamber (ODC)



**5 (a)**

**5 (b)**

**5 (c)**

**PHOTO-5: (a), (b) & (c)** Initial weaving in progress, which is normally done on the ground surface for the 3 respective moulds, namely, Top Segment of Plant (TSP), Bottom Segment of Plant (BSP) and Outlet Displacement Chamber (ODC)





**6 (a)**

**6 (b)**

**6 (c)**

**PHOTO-6: (a), (b) & (c)**

Initially woven bamboo strips (on the plain ground surface) placed inside the appropriate size underground for weaving-viz., 6 (a) Top Segment of Plant (TSP), 6 (b) Bottom Segment of Plant (BSP); and 6 (c) Outlet Displacement Chamber (ODC)



**7 (a)**

**7 (b)**

**7 (c)**

**PHOTO-7: (a), (b) & (c)**

Advanced stage of weaving of -7 (a) Top Segment of Plant (TSP), 7 (b) Bottom Segment of Plant (BSP); and 7 (c) Outlet Displacement Chamber (ODC)



**8 (a)**

**8 (b)**

**PHOTO-8: (a) & (b)**

Completed woven bamboo structure for the Top Segment of Plant (TSP)- commonly referred as the Top Segment of the Main Unit of the Plant (MUP), showing two views- 8 (a) TSP in half standing position and 8 (b) TSP kept on the plain ground surface, as it will go inside the plant pit on top of the bottom segment of the plant (BSP) and tied together with binding wire, to form the complete MUP



**9 (a)**

**9 (b)**

**PHOTO-9: (a) & (b)** Completed woven bamboo structure for the Bottom Segment of Plant (BSP)- commonly referred as the Bottom Segment of the Main Unit of the Plant (MUP), showing two views- 9 (a) BSP in tilted position supported by trained rural women weavers and 9 (b) BSP kept in inverted position on the plain ground surface, as it will go inside the plant pit on the surface of the foundation. Later on the top segment of the plant (TSP) would be placed on it and both will be tied together with binding wire, to form the complete MUP



**10 (a)**

**10 (b)**

**PHOTO-10: (a), (b) & (c)** Completed woven bamboo structure for the Outlet Displacement Chamber (ODC)- Showing two views- Photo 10 (a) ODC (weaving is just completed with opening for manhole on its crown inside the UGM) ready to be taken out; Photo-10 (b) ODC kept on ground, with the two structure for TSP & BSP ready inside their respective underground moulds, can be seen at the back (UGMs); and Photo-10 (c) ODC kept on the ground surface in inverted position (with opening for manhole on its crown) as it will go on the ODC foundation.



**11 (a)**



**11 (b)**

**PHOTO-11: (a) & (b)** Completed woven bamboo structures for- Photo-11 (a) Top Segment (TSP) and Bottom Segment (BSP) of the Main Unit of Plant (MSU), Photo-11 (b) TSP is placed on top of BSP as they would be placed inside the plant pit before joining them together tightly using binding wire, before plastering them using cement sand mortar





**12 (a)**



**12 (b)**

**PHOTO-12: (a) & (b)** Completed woven bamboo structures for- Photo-12 (a) Top Segment of Plant (TSP), Bottom Segment of Plant (BSP) and Outlet Displacement Chamber (ODC); Photo-12 (b) TSP is placed on top of BSP and ODC touching BSP as they would be placed for constructing Bamboo Reinforced Cement Mortar (BRCM) with cement & sand mortar



**13 (a)**



**13 (b)**



**13 (c)**

**PHOTO-13: (a), (b) & (c)** Different stages of weaving of bamboo structures for making BRCM Slurry Mixing Tank (SMT)- Photo 13 (a) Initial stage of weaving of bamboo structure for the SMT on the levelled ground without using any underground mould; Photo 13 (b) Advanced stage of weaving for SMT; and Photo 13 (c) Completed woven bamboo structure for Slurry Mixing Tank (SMT).



**14 (a)**



**14 (b)**



**14 (c)**



**14 (d)**



**14 (e)**

**PHOTO-14: (a), (b) & (c)** Other key materials used for weaving and construction of Grameen Bandhu Plant (GBP)- Photo-14 (a) Binding wire used for tying bamboo strips and joining completed woven bamboo structures for the different components & sub-components before making BRCM plant; Photo-14 (b) Brick Ballasts used for making foundations of MUP, ODC and SMT of the GBP; and Photo- 14 (c) Inlet Pipe (IP) made from CC; Photo-14 (d) Cement Sand Mortar; and Photo-14 (e) DPC powder (1/2 Kg 50 Kg cement) for mixing with Cement Sand Mortar for BRCM construction & plastering



**15 (a)**

**15 (b)**

**15 (c)**

**PHOTO-15: (a), (b) & (c)**

Transporting of the woven bamboo structures for the three major components and sub-components (namely BSP, TSP and ODC) by foot within the same village or adjacent village for the construction of Grameen Bandhu Plant (GBP)- Photo-15 (a) bamboo structure for the bottom segment of plant (BSP) by villagers & volunteers, from the weaving site to plant site; Photo-15 (b) Bamboo structures for the top segment of plant (TSP) is being lifted to be carried from the weaving site to the plant site; and Photo-15 (c) Bamboo structure for TSP is being carried by villagers & volunteers to the plant site within the same village for building the GBP



**16 (a)**

**16 (b)**

**PHOTO-16: (a) &, (b)**

Transporting of the woven bamboo structures for the three major components and sub-components (namely BSP, TSP and ODC) by bullock card in the nearby villages for construction of Grameen Bandhu plant (GBP)- Photo- 16 (a) Carrying the bamboo structure from the weaving site on the bullock cart; Photo-16 (b) Bamboo structures are ready to be unloading from the bullock cart at building site of Grameen Bandhu plant (GBP).



**17 (a)**

**17 (b)**

**PHOTO-17: (a) & (b)**

Transporting of the woven bamboo structures for the three major components and sub-components (namely BSP, TSP and ODC) by tractor and trolley in distance villages for the construction of Grameen Bandhu plant (GBP)- Photo- 17 (a) Carrying the bamboo structure from the weaving site on the tractor; and Photo- 17 (b) Unloading the woven structure from the tractor at the site for building the Grameen Bandhu Plant (GBP)



**II. BUILDING OF GRAMEEN BANDHU PLANT (GBP) AT FARMER'S SITE**

- a). **Digging pit, laying of foundation and the fixing of bamboo Shell structures for the MUP- (Photograph No. 18 to 21)**



**18 (a)**



**18 (b)**



**18 (c)**

**PHOTO-18: (a), (b) & (c)** Layout and initial digging of the pit for GBP- Photo- 18 (a) Marking of outline as per the dimensional drawing for digging pit for the plant Photo- 18 (b) Initial digging of the pit as per the marling on the ground surface; and Photo- 18 (c) Using bamboo pole for dividing the diameter of the pit in to two equal parts, as well as using it midpoint, and taking string of appropriate length for the measurement of the radius, dig the bottom curvature of the pit.



**19 (a)**



**19 (b)**



**19 (c)**

**PHOTO-19: (a), (b) & (c)** Final important stages of digging pit for the MUP of the GBP- Photo- 19 (a) Deepening the pit as per the dimensional drawing till the collar for costing the ring beam is reached, and also making the rectangular pit for the outlet tank (OT); Photo- 19 (b) Make the circular collar in the pit as per the dimensional drawing, and then further deepen the pit from this stage onward as per the radius of the pit to perfectly accommodate (shallow disc shaped) woven bamboo structure for the bottom segment of the plant (BSP); and Photo- 19 (c) Dig the shallow circular pit (on top surface of the OT, attached to the MUP pit), for making foundation with the brick ballast and cement.



**20 (a)**

**20 (b)**

**20 (c)**

**PHOTO-20: (a), (b) & (c)**

Laying of foundation of the MUP- Photo- 20 (a) First the pit surface is properly rammed, then brick ballast of average size ranging between 1-2 inch (25 -50 mm or 2.5 to 5 cm) are spread evenly on the bottom; Photo- 20 (b) Using wooden ram, the ramming of BBs is done (while sprinkling water) to make it firm and even; and Photo- 20 (c) Finally cement & sand mortar is spread and further ramming is done (with sprinkling water) to make the foundation firm, compact & even, as per the thickness given in the dimensional drawing, to complete the foundation of MUP including the collar for the ring beam. **(Note:** As brick ballasts are used, the ratio of cement concrete used for casting foundation is 1:4:8 (1 cement: 4 coarse sand: 8 brick ballasts) by volume. Main construction will start only from the next day onwards)



**21 (a)**

**21 (b)**

**21 (c)**

**PHOTO-21: (a), (b) & (c)**

Placement of bamboo shell structures for the BSP & TSP, inside the pit on the surface of the foundation of the MUP- Photo- 21 (a) Placement of dish shaped bamboo shell structure for the BSP of the MUP; Photo- 21 (b) Placement of hemi-spherical shaped bamboo shell structure for the TSP on top of the concave shaped BSP, which also shows the opening for making the outlet gate; and Photo- 21 (c) View of woven bamboo structure for MUP, seen from the opposite side showing the circular opening for inserting for 4 inch (100 mm or 10 cm) diameter inlet pipe (IP) during construction.



**22 (a)**

**22 (b)**

**22 (c)**

**PHOTO-22: (a), (b) & (c)**

Bamboo shell for the MUP's top segment placed perfectly over the shallow dish shaped bottom segment (BSP) of the of MUP, which are tied & fixed together firmly with binding wires, to make the unit in to ellipsoidal shaped structure of MUP- Photo-22 (a) Woven bamboo structure for MUP (just before insertion of gas outlet pipe, also showing the outlet gate opening; 22 (b) A one inch (25 mm) dia & 7 inch (175 mm) long gas outlet pipe (GOP) is being inserted at the crown of TSP and properly tied using binding wire; and Photo-22 (c) Woven bamboo structure during the insertion of 4 inch (100 mm or 10 cm) diameter inlet pipe (IP).



**b). Main construction work on the Grameen Bandhu plant-GBP (Photograph No 23- 32)**



**23 (a)**



**23 (b)**

**PHOTO-23: (a) & (b)**

Application of pure cement slurry on the outer surface of the top segment of the MUP, with brush in 1:5 ratio (1 kg cement: 5 liter water), before starting the first coat of rough plaster- Photo-23 (a) Application of cement slurry is done using biomass brush on the outer surface of the MUP; Photo-23 (b) Advanced stage of rough plaster on the Second coat of smooth plaster being carried on the first coat of rough plaster.



**24 (a)**



**24 (b)**



**24 (c)**

**PHOTO-24: (a), (b) & (c)**

First coat of rough plaster on the outer surface of the woven bamboo structure for the top segment (TS) of the main unit of the plant (MUP), using cement mortar in 1:3 ratio (1 cement: 3 coarse sand) by volume- Photo-24 (a) Advanced stage of rough plaster 24 (b) First rough plaster on the outer surface of MUP is in advanced stage of progress; and 24 (c) Outer surface of MUP is completed with first coat of rough plaster.



**25 (a)**



**25 (b)**



**25 (c)**



**25 (d)**

**PHOTO-25: (a), (b), (c) & (d)**

Different stages of second coat of smooth plaster on both, the Ring Beam and the outer surface of the top segment (TS) of the main unit of the plant (MUP). The ratio of cement mortar used is 1:3 (1 Cement: 1 Coarse Sand+2 Fine Sand) by volume.



**26 (a)**



**26 (b)**



**26 (c)**

**PHOTO-26: (a), (b)& (c)**

Fixing of outlet tank (OT) attached to the outlet gate (OG) and plastering it- 26 (a) Fixing of three flat woven bamboo mats to make it in to a rectangular shape bamboo structure for OT- 26 (b) Fixing of rectangular shape bamboo structure to the OG, which also touches the upper portion of the outer surface of the MUP; and 26 (c) Plastering of bamboo structure from inside to make it in to a rectangular outlet tank (OT), using cement mortar in 1:3 ratio (1 cement: 3 coarse sand) by volume.



**27 (a)**



**27 (b)**



**27 (c)**

**PHOTO-27: (a), (b)& (c)**

Different stages of plasters of the MUP from insider- Starting with the first coat rough plaster, and then followed by second coat smooth plaster on the inner surface of the top segment (TSP) and bottom segment of the MUP. The ratio of cement mortar used is 1:3 (1 Cement: 1 Coarse Sand+2 Fine Sand) by volume.



**28 (a)**



**28 (b)**



**28 (c)**

**PHOTO-28: (a), (b) & (c)**

Building of Outlet Displacement Chamber (ODC) of the GBP- Photo- 28 (a) Laying of foundation of the ODC using 2 inch (50 mm or 5 cm) size brick ballasts (or 1-2 inch (25 mm or 5 cm). Wherever stone chips or pebbles are easily available at lower cost than it can be used (in place of brick ballast) for laying the foundation; and Photo- 28 (b) Plastering the laid foundation with appropriate ratio of cement and sand mixture; Photo- 28(c) Preparing the already placed woven bamboo structure for the ODC for the plastering. The ratio of cement mortar used is 1:3 (1 Cement: 1 Coarse Sand+2 Fine Sand) by volume.





**29 (a)**



**29 (b)**



**29 (c)**

**PHOTO-29: (a), (b) & (c)**

Demonstration to visitors about the constructional aspects of GBP- Photo-29 (a) Final stages of construction of Outlet displacement chamber (ODC); Photo-29 (b) Explaining the functioning of Outlet displacement chamber (ODC); and Photo-29 (c) Explaining about the last stages of construction of GBP to visitors.



**30 (a)**



**30 (b)**

**PHOTO-30: (a) & (b)**

Two main units of the GBP (after curing for approximately 10 days is completed) seen before covering the top with earth- 30 (a) Main unit of the plant (MUP); and 30 (b) Outlet displacement chamber (ODC) of the plant.



**31 (a)**



**31 (b)**



**31 (c)**

**PHOTO-31: (a), (b) & (c)**

Completed GBP (after curing for an average of 7-10 days is completed), seen before covering on the surface of the plant dome with earth- 31 (a) Slurry mixing tank (SMT) is seen on the top; 31 (b) Outlet displacement chamber (ODC) of the GBP is seen, with its discharge opening (DO) located just above the level of ground surface; and 31 (c) View off the entire plant, being covered by earth on its top, except the SMT and top portion of the ODC.



**32 (a)**



**32 (b)**

**PHOTO: 32 (a) & (b)**

Completed GBP seen before covering on the surface of the plant dome with earth- Photo-32 (a) Completed after curing for an average of 7-10 days; and Photo-32 (a) After the pipe line has been connected from the plant to the place of utilization of the biogas.

**III. Utilization of two products of biogas plants (namely biogas and digested slurry (photograph nos. 31 to 37))**



**33 (a)**



**33 (b)**



**33 (c)**

**PHOTO: 33 (a) & (b)**

Use of biogas from Grameen Bandhu plant for cooking and lighting Photo-33 (a) A rural woman using biogas for cooking; and Photo-33 (b) Biogas being used for lighting using biogas mental lamp; Photo-33 (c) Another rural woman using biogas for cooking.



**34 (a)**



**34 (b)**

**PHOTO: 34 (a) & (b)**

Use of biogas from GBP for running dual fuel engine (diesel + biogas) for operating irrigation pumping set- Photo-34 (a) Trial run after converting (using local level improvisation) the existing old diesel engine in to a dual engine for operating a pump for irrigation, by using combination of biogas (70%) and diesel (30%); and Photo-34 (b) Biogas being used in combination of diesel in dual fuel engine for irrigating of farmers field.





**35 (a)**



**35 (b)**

**PHOTO: 35 (a) & (b)**

Use of biogas for running dual fuel engine (diesel + biogas), for simultaneously operating both generating set as well as mechanical power (using shaft and pulley) by a farmer in Bharatpur district (Rajasthan state) - Photo-35 (a) Dual fuel engine (diesel + biogas) is operating a generating set using pulley and shaft for lighting (during the frequent power cut from the main grid in farmers house; and Photo-35 (b) Same farmer simultaneously using biogas from the same GBP and same dual fuel engine for operating chaff cutter and other farm equipments using pulley and shaft.



**36 (a)**



**36 (b)**



**36 (c)**

**PHOTO: 36 (a), (b) & (c)**

Recycling of bovine (cattle or/and buffalo) manure (collected in Indian villages either from buffalo or cattle or both) through Grameen Bandhu plant for clean & convenient energy (in the form of biogas) and in the process also getting enriched manure in the form of digested slurry- Photo-36 (a) Bovine manure collected in Indian villages from domestic farm animals kept next to their houses; Photo-36 (b) The Grameen Bandhu plant is also constructed closer to the bovine yard and the farmers; and Photo-36 (c) Biogas digested slurry going in the pit next to the plant for storage.



**37 (a)**



**37 (b)**



**37 (c)**

**PHOTO: 37(a), (b) & (c)**

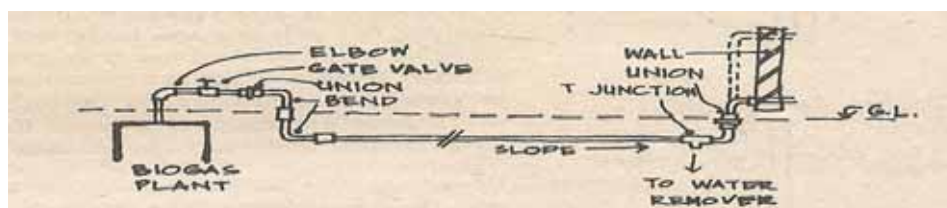
Utilization of digested slurry (after drying or making compost) in agricultural- Photo-37 (a) Use of biogas digested slurry on WAFD's demonstration organic farm; Photo-37 (b) Biogas digested manure used in wheat crop; and .Photo-37 (c) Use of biogas digested slurry in mustard crop, and in between fodder crop is shown for domestic farm animals.

- 6.13** It is only necessary to do cement polishing & finishing on the inside surface of all the components and sub-components of GBP, over the second coat of smooth plaster, using cement paste prepared in ratio of 1:1 (1 kg Cement: 1 lt. Water) by volume.
- [Please Note:** No cement polishing is to be done on the outer surface of MUP, ODC, OT, Mixing Tank (MT), Short Inlet Channel (SIC) and the Manhole Cover of ODC.]
- 6.14** For casting and plastering the BRCM walls of digested slurry (compost) pits, the ratio of cement mortar mixture should be 1: 5 (1 cement: 2 fine sand: 3 coarse sand) by volume, for both, the first coat of rough plaster and second coat of smooth plaster. Use ratio of 1:3 (1 kg cement: 3 lt. water) by weight for cement polishing on the surface of second coat plaster.
- 6.15** The Grameen Bandhu plant (GBP) is filled with manure slurry. If cattle dung is used then the slurry mixture is prepared in the ratio 1:1 (1-kg fresh dung: 1 liter of water). However, if manure from other domestic farm animals are used (or night soil is used) then the ratio will be different, for which the Comprehensive Manual on Grameen Manual may be referred. However, even if the manure from other domestic farm animals (or Night Soil) are used, still the plant needs to be initially loaded (charged) with Bovine (cattle and/or buffalo) manure (dung), the reason for which is explained elsewhere in this Manual. The Initial filling of the GBP Model has to be done up to the second step from bottom of the Outlet Chamber (OC)- This is the level of the base of the Outlet Displacement Chamber (ODC). The filling up to this level is to be completed as soon as possible, say within 3-4 days, using own as well as borrowing fresh bovine dung from neighbours or purchasing from others. For initial loading (charging) [up to the second step in the Outlet Chamber (OC)] of a 2 m<sup>3</sup> Capacity GBP biogas plant of 40 days HRT (Hydraulic Retention Time) and 33.33% capacity Gas Storage Chamber (GSC), about 5 tonnes (5000 liters) slurry, would be required. When fresh bovine (cattle and/or buffalo) dung is used then 5 tonnes (5000 liters) slurry comprise of 2500 kg (2.5 tonnes) of fresh dung plus 2500 liters (2.5 m<sup>3</sup> or tonnes) of water. The exact quantity of fresh dung and fresh slurry for initial loading (charging) of 1, 2, 3, 4 & 6 m<sup>3</sup> capacity Grameen Bandhu Biogas Plant (GBP) is given under table- IV under Section- VIII of this "Practical Guide".
- 6.16** The GBP model biogas plant should be left for 2 to 3 weeks after the initial loading (charging) with fresh slurry is done up to the prescribed level, for proper fermentation of the slurry in the digester. The Gate Valve on the Gas Outlet Pipe should be closed tightly so that there is no possibility of any gas (produced during this period) escaping from it.
- 6.17** When the fermentation starts in full swing, the slurry in the Outlet Chamber (OC) will start rising. As the slurry level reaches just at the lower end of the Discharge Opening (DO) located on the outer wall of the Outlet Displacement Chamber (ODC), open the Gate Valve and test the biogas for burning in the stove. Most probably it will not burn. Release the entire biogas and close the valve again. The reason for gas not burning at this stage is because the biogas generated initially contains much higher percentage of Carbon Dioxide (CO<sub>2</sub>) and lesser percentage of Methane (CH<sub>4</sub>).
- 6.18** Keep on checking the plant every day. As soon as the slurry level in the ODC rises to the level very close to the Discharge Opening-DO (may be in another 1 to 2 days time, from the day of the first testing of biogas for burning in the stove), following the procedure described above for testing. Most probably it will burn with blue flame, otherwise release it again and try the next day, which should surely burn. Now the Grameen Bandhu Plant (GBP) is ready to be used daily, as a normal routine. Now it will start generating biogas closer to its rated capacity- that means if it is a 2 m<sup>3</sup> capacity plant then it will start.
- 6.19** At this stage resume the daily feeding with prescribed quantity of fresh slurry (for a 2 m<sup>3</sup> capacity plant it will be 100 liters slurry- 50 kg fresh dung mixed with 50 liters of water) and use the biogas for cooking and lighting, as per normal requirement.
- 6.20** If the Grameen Bandhu Plant (GBP) is operated following all the instructions as per this manual, it will provide trouble-free service for a long time and it's useful working life will also be enhanced.

## Section- VII

### PIPELINE FOR GRAMEEN BANDHU (GBP) MODEL BIOGAS PLANT

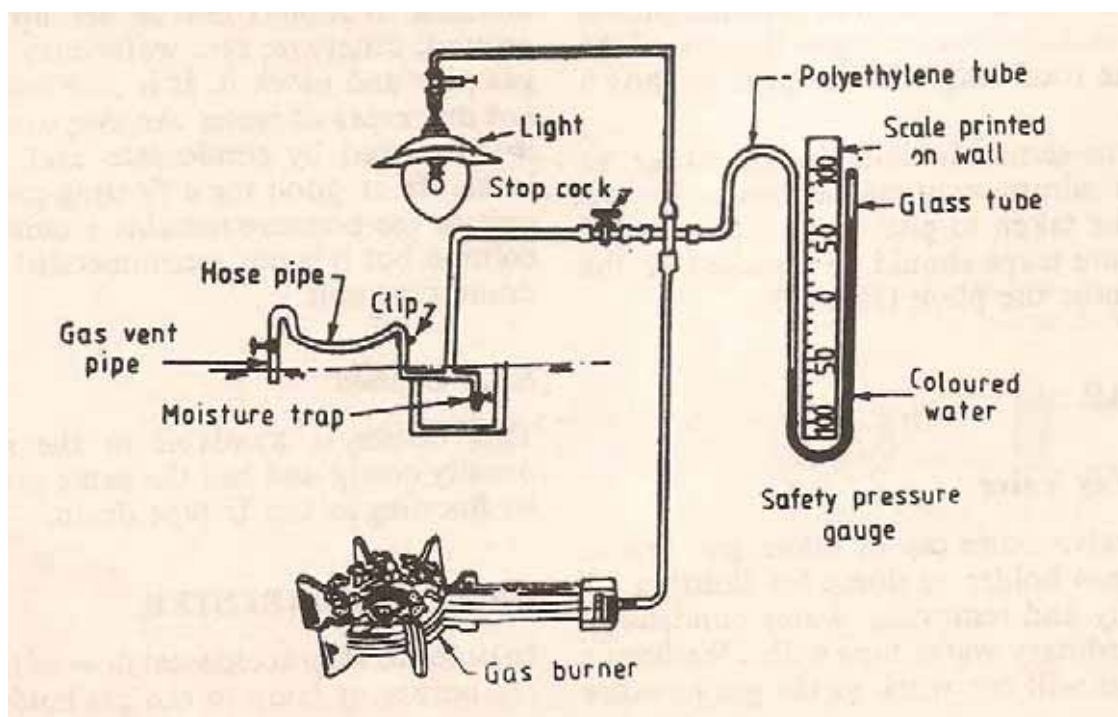
- 7.01 The selection of correct pipe size for conveying the biogas is very important as improper pipe can result in lower efficiency or higher cost to the plant owner. In designing the gas distribution system the parameter that needs to be controlled is the gas pressure. Biogas is available at a gauge pressure of 10 cm (4") of water column in floating gas holder plant eg. KVIC model. While in case of two popular fixed dome Indian models eg. Janata and Deenbandhu, it varies from minimum of 0 to maximum of 110 cm (0 to 10) and 0 to 75 cm water column, respectively. In case of Grameen Bandhu (GBP) model it varies from 0 to 80 cm of water column.
- 7.02 For efficient use in burners and lamps it should be available at the point of use at an optimum pressure of 7 to 8 cm of water column. When biogas flows in a pipe, there is loss in its pressure due to friction. A properly designed pipeline is one which does not cause a pressure drop of more than 2 to 3 cm of water column under any circumstances.
- 7.03 For comparable conditions, the pressure drop tends to increase with the consumption (flow rate) as also the distance of the point of utilisation from the plant. This flow rate can be measured by measuring the gas consumption rate of the burners and lamps used. The biogas consumption normally varies from 0.46 m<sup>3</sup>/Hr (m<sup>3</sup> per hour) for standard burners to 1.88 m<sup>3</sup>/Hr for a large burner. Though ordinarily the length of pipeline could be from 25 to 500 meter, with proper & scientific design and planning, this could go upto any distance, subject to other conditions.
- 7.04 It is a must to employ correct size pipeline for transporting biogas from plants to the points of utilisation, as it is very crucial from the point of view of efficiency of gas utilization and the cost of installation.
- 7.05 The gas distribution pipeline has been designed and recommended pipe sizes for different combinations of flow rates and distances between gas production and utilisation points are given in table-V. These recommendations are made for galvanised iron pipe. In case of large size biogas plants, it is essential to design the pipeline properly and select pipe size accordingly. But for rural house-hold (family size) GBP model biogas plants, the dimensions given in table-V, can be used for selection of right size (dia) pipes.
- 7.06 Laying the gas distribution pipeline:**
- 7.06.1 Like no uniform design can be prepared for suiting all the biogas installations, there is no laid down procedure for laying of gas pipeline for all biogas systems.
- 7.06.2 Pipeline may have to be above or below the ground or it may be partly above and partly below the ground. While a properly laid underground pipeline would require less maintenance, yet it may get corroded faster at some places; whereas in other places corrosion of above ground pipeline may be more rapid.
- 7.06.3 Installing high density polyethylene pipe enables us to overcome the problem of corrosion. However, in this case underground pipe may be preferred over the above ground pipe.



**Figure-14**

**7.07 Important points which have to be kept in mind and adhered to at the time of laying of pipeline for efficient conveyance of biogas:**

- 7.07.1 Pipe and fittings to be used for laying biogas distribution system must be of best quality. From safety point of view, it is important to be pay more attention for in-house connections.
- 7.07.2 All underground pipes should be coated with protective paints to avoid corrosion. Underground pipes should be laid about 30 cm (1 ft) below the ground level.
- 7.07.3 Extra emphasis must be given to the selection of appropriate Valves to be employed.
- 7.07.4 As far as possible only bends (not elbows) should be used for 90 degrees turns in the pipeline. This reduces pressure drop.
- 7.07.5 Only Gate Valves, Plug Valves and Ball Valves should be used for gas pipeline to minimise pressure loss during flow of gas through valves.
- 7.07.6 For connecting the burners with gas pipeline, avoid the use of transparent polyethylene tubes and only neoprene rubber tube should be used.
- 7.07.7 Biogas is saturated with water vapour and slight fall in temperature causes its condensation in the pipeline. Therefore, adequate arrangements to remove the condensate must be made at the time of pipe laying. All the pipes must have some gradient and at all the low points water removers should be installed. Water accumulation in pipe results in pressure drop which causes reduction in flow rate.



**Schematic diagram of pipe lines from biogas plant to the place of gas utilisation with accessories**

**Figure-15**

**7.08 Types of water remover:**

The water remover can be of two basic types:

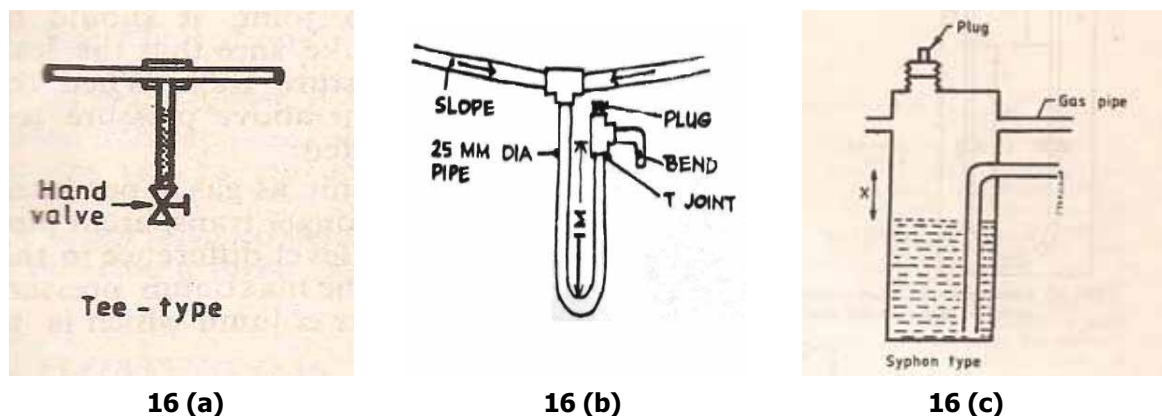


**7.08.1 Manually operated water remover**

- a). A Sketch of this type of water remover is depicted in figure-16 (a). It is a "T Joint" at the lowest point of a certain section of gas pipeline. The vertical branch of the "T Joint" is kept in a perpendicular downward direction and it is connected to 30 cm or 300 mm (1 ft) long piece of pipe. The other end of this pipe is either plugged or fitted with a valve. The condensate from the pipeline will flow into this pipe and will be drained-off manually at an interval of a week or ten days or as guided by experience.

**7.08.2 Automatic water removal siphon**

- a). In this type of water removers the vertical branch of "T Joint" should be atleast of 25 mm (1") dia. It is connected to a "U" shaped assembly, as shown in figure-16 (b). Cylindrical type of water remover is given in figure-16 (c).



**Diffrent types of watre Removers**

**Figure-16**

- b). The height of the free arm of the "U" tube, (marked H) should be atleast 100 cm or 1000 mm (40" or about 3.4 ft) for Grameen Bandhu (GBP) biogas plant as compared to 90 cm for Deenbandhu plants, 110 cm for Janata biogas plants and 20 cm for KVIC biogas plants. The upper end of free arm of "U" should be a little below the gas pipeline. A bend facing downwards is also provided on top of the free arm of "U" for draining out the condensate. The "U" tube will always be kept filled with water which can be ensured by periodic checks. When some condensate flows (water) into the fixed arm of the "U", equal quantity of water from the "U" tube will be discharged through the bend fitted to the free arm.

- 7.09 Whole gas distribution system should be divided in a few sections so that anyone of them can be isolated from rest of the pipeline if it were to be repaired. This can be done by providing UNIONS at points where bends have been employed.
- 7.10 Above ground pipe should be only laid along the walls and not hanging free. It should be hooked all along the walls with the help of clamps at every 2 meters (6.50 ft) or so and no pipe should sag at any point. There should be a continuous slope in the directions of water remover.
- 7.11 Biogas cock in the houses should be kept out of the reach of children.
- 7.12 Entire pipeline should be tested for any leakage at a pressure of 1 kg/cm<sup>2</sup>, At the time of installation.
- 7.13 Burners should be connected in such a way that gas valves are in the front so that to operate the burner the user does not have to take her/his hand over the burner.

- 7.14 Sketch of a sample layout for pipeline from the biogas plant to the house is shown in Figure-\*\*. Normally, atleast one water remover for every 100 meter pipe length should be installed.
- 7.15 Details of in-the-house connections are not shown in the figure as it will vary from house to house. However, all the points mentioned above must be kept in mind while laying pipeline in the house.
- 7.16 The table-VI gives recommended pipe diameter for different flow rates of biogas.

**Table- V**

**Recommended pipe diameters for different flow rates of biogas and distances between the plant and point of gas utilisation**

DISTANCE		25 M	50 M	100 M	150 M	200 M	300 M	400 M	500 M
FLOW RATE		INSIDE DIAMETER OF PIPE							
Ft <sup>3</sup> /Hr	M <sup>3</sup> /Hr	Diameter in Inch	Diameter in Inch	Diameter in Inch	Diameter in Inch	Diameter in Inch	Diameter in Inch	Diameter in Inch	Diameter in Inch
(a)	(b)	(c)	(d)	(e)	(f)	(g)	(h)	(i)	(j)
8 cft/hr	0.23 m <sup>3</sup> /hr	1/2"	1/2"	3/4"	3/4"	3/4"	3/4"	1"	1"
16 cft/hr	0.46 m <sup>3</sup> /hr	1/2"	3/4" for 25m and 1/2" for next 25m	3/4"	1" for 100m and 3/4" for next 50m	1" for 150m and 3/4" for next 50m	1" for 200m and 3/4" for next 100m	1" for 350m and 3/4" for next 50m	1"
24 cft/hr	0.69 m <sup>3</sup> /hr	1/2"	3/4"	3/4"	3/4"	1" for 150m and 3/4" for next 50m	1"	1 1/2" for 200m and 1" for next 150m and 1/2" for next 50m	1 1/2" for 200m and 1" for next 300m
32 cft/hr	0.92 m <sup>3</sup> /hr	1/2"	3/4"	3/4"	1" for 100m and 3/4" for next 50m	1"	1 1/2" for 200m and 1" for next 50m and 3/4" for next 50m	1 1/2" for 200m and 1" for next 200m	1 1/2" for 350m and 1" for next 150m
48 cft/hr	1.38 m <sup>3</sup> /hr	3/4"	3/4"	1" for 75m and 3/4" for next 25m	1"	1"	1 1/2" for 150m and 1" for next 150m	1 1/2" for 300m and 1" for next 100m	1 1/2" for 400m and 1" for next 100m
64 cft/hr	1.84 m <sup>3</sup> /hr	3/4"	1"	1 1/2" for 50m and 1" for next 50m	1 1/2" for 100m and 1" for next 50m	1 1/2" for 150m and 1" for next 50m	1 1/2"	1 1/2"	2" for 150m and 1 1/2" for next 350m

**Note:** The above recommendations are meant for G.I. pipes, where PVC pipes are used then it should be one size (i.e. diameter) smaller under similar conditions.



**SECTION- VIII**

**INITIAL LOADING (CHARGING) OF GRMAEEN BIOGAS PLANT**

8.01 Initial charging (loading) of plant with the fresh dung (manure) slurry if bovine (cattle and/or Buffalo) dung (manure) is used then mixture is prepared in the ratio of 1:1 (i.e. 1 kg fresh dung mixed with 1 litre water) is done upto the level of second step on the outlet chamber (this is also the top surface of Outlet Tank-OT and the bottom surface of Outlet Displacement Chamber-ODC).

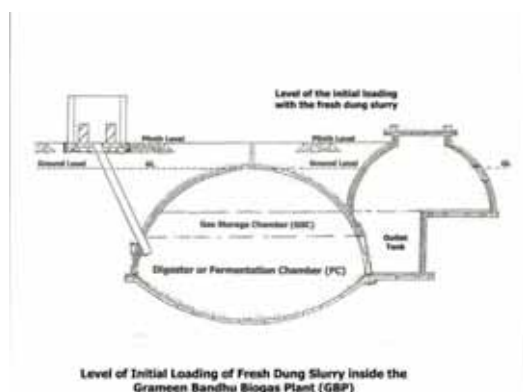


Figure-17 (a)



Figure-17 (b)

8.02 The amount of slurry required for a 40 days HRT plant would be 40 times of the daily input of fresh slurry plus volume of the Gas Storage Chamber-GSC (33% of the designed (rated) gas generation per day + volume of the outlet tank + Volume of inlet pipe upto this level. Refer tables-VI to get approximate total amount of fresh dung (manure) and fresh slurry required for doing the initial filling (loading/charging) of different capacities Grameen Bandhu (GBP) biogas plants of 40 days HRT.

**Table-VI**

**FRESH DUNG FOR INITIAL FEEDING OF GRAMEEN BANDHU BIOGAS PLANT**

Plant Cap	Daily Feed		Vol. of Digester (Ved)	Height of Outlet Tank (H)	Vol. of Gas Storage Chamber (Vgsc)	Vol. of Outlet Displacement Chamber (Vodc)	Vol. of Outlet Tank (Vot)	Slurry Vol. for Initial Loading (T)	Fresh dung for Initial Loading (T)
	Dung (Kgs)	Slurry (Lt.)							
M <sup>3</sup>	(Kgs)	(Lt.)	M <sup>3</sup>	(Mt.)	M <sup>3</sup>	M <sup>3</sup>	M <sup>3</sup>	(T)	(T)
(a)	(b)	(c)	(d)	(e)	(f)	(g)	[h= (0.36 x e)]	l =(d+f+h)	j=(i/2)
1	25	50	2.75	0.475	0.33	0.33	0.36 x 0.475=0.171	3.25	1.63
2	50	100	5.50	0.645	0.66	0.66	0.36 x 0.645=0.232	6.39	3.19
3	75	150	8.25	0.775	0.99	0.99	0.36 x 0.775=0.279	9.52	4.76
4	100	200	11.00	0.885	1.32	1.32	0.36 x 0.885=0.319	12.64	6.32
6	150	300	16.50	1.035	1.98	1.98	0.36 x 1.035=0.373	18.85	9.43

- 8.02 The Initial loading upto the second step on the Outlet Displacement Chamber (ODC) should be completed within 4-5 days, as far as possible using slurry prepared from fresh bovine (cattle and/or buffalo) dung (manure). But if due to practical problems collection of such a huge quantity is not possible then the dung collected each day (as soon as the plant construction starts) needs to be stored at one place on clean surface till the time plant is ready to be charged. Thus the plant owner can easily collect dung from his/her cattle for upto three to four<sup>8</sup> weeks (i.e. 15 days of construction time (including on an average 3 days required for digging of plant pit) plus about 10 days of curing time. Thus the plant can be loaded (charged) using own dung collected each day plus borrowing or purchasing some fresh dung from the neighbouring farmers.
- 8.03 It is always good to do the initial feeding (loading) of the plant with fresh slurry to extract the maximum potential of the biogas from the slurry. If for any reason the plant owner is not able to get the fresh manure to complete the entire initial loading on one day then the maximum quantity of collectable dung with out loss of appreciable potential of nutrient under well protected conditions can be taken as 5 to 6 days. Beyond this period the dung start losing its potential as the microbial bacteria (mainly aerobic microbe) have already started decomposing the dung (manure). However, based on the practical problems faced by the farmers to collect such a huge quantity of manure from his/her farm as well as from his neighbour farms, the field (extension) agencies end up suggesting the plant owner to collect dung (manure) from his/her own farm during the course of building the Gramee Bandhu plant (GBP), yet it has to be recognised that the certain percentage of potential of biogas production would have been lost from this dung fed initially.

---

<sup>8</sup> When using dung (manure) kept for such a long time, especially if it had been exposed to the sun and light then it is advisable to remove the top few centimeters as well as, a few centimeters of bottom layers kept for longer period. As far as possible use only the middle layer of dung for initial loading (charging) of GBP.

## **Section- IX**

### **CARE AND MAINTENANCE OF GRAMEEN BANDHU PLANT (GBP)**

#### **9.01 GENERAL**

**9.01.1** The Grameen Bandhu plant (GBP) is simple to operate & handle by any plant owner or his/her family in rural areas. Being a simple technology based on the principle of fixed dome rural household semi-continuous hydraulic digester BGPs, which are very common in India e.g. Janata & Deenbandhu models, the maintenance and daily care needs to be done in the same way, which can be easily looked after by the rural house wife or even the teen age children by devoting only 15 to 30 minutes each day.

**9.01.2** Some of the simple guidelines and tips for general care and maintenance given below, if followed regularly, will increase working efficiency and the operational life of the Grameen Bandhu plant (GBP) several folds.

- a). The gate valve should be opened only when the gas has to be actually used.
- b). Before opening the valves, one must ensure that all the preparation for cooking have been made, to avoid unnecessary wasteful consumption of biogas.
- c). The air injector should not be closed very tightly on the side of burner. The inflow of the air should be adjusted properly in the injector.
- d). The manhole provided on top of the Outlet Displacement Chamber (ODC) of plant should never be left uncovered.

#### **9.02 Specific care and maintenance**

In addition to above, the daily, weekly, monthly, yearly and five yearly care and maintenance should be done as per the schedule given below:

##### **9.02.1 Daily care and maintenance:**

- a). Add the recommended quantity of feed material in the plant.
- b). Use proper slurry mixture.
- c). Use clean feed material, free from soil, straw green biomass and other floating material.
- d). Clean mixing tank thoroughly before and after use.

##### **9.02.2 Weekly care and maintenance:**

- a). Do gentle stirring of the slurry inside the digester for about 5-10 minutes<sup>9</sup> every week. Use a long bamboo pole with a piece of cloth or jute mat tied properly at its one end so that it can conveniently go inside the 10 cm or 100 mm (4") diameter Inlet pipe and act as a piston<sup>10</sup>. This will also ensure proper & effective stirring of slurry inside digester.

---

9 The Grameen Bandhu plant (GBP) is designed in such a way that proper stirring can be done from the inlet pipe only. Because of the smaller size opening [manhole of 60 cm or 600 mm (2 ft)] on the Outlet Displacement Chamber (ODC) as compared to Janata and Deenbandhu models, as both these models have a very large size rectangular ODC. Using a bamboo pole for stirring is practically impossible in the case of Grameen Bandhu plant (GBP); and precisely for this reason the Mixing Tank in Grameen Bandhu plant (GBP) is kept at a 90° angle to the line of Inlet Pipe, for easy stirring by using a long pole.

10 There is one distinct advantage of using pole with one end of a piece of cloth or a piece of jute mat. It acts like a piston inside the Inlet pipe and gives the effect of an Hydraulic Ram; therefore, with a lesser pressure (which can even be applied by a child of 10 to 12 years age) the entire slurry in the digester as well as in the ODC can be stirred and desired impact of stirring is achieved even in a shorter duration.

- c). Open the tap of the manually operated Moisture Trap to drain off moisture condensed in the pipeline.
- d). The nozzle of the biogas lamps should be properly cleaned.

**9.02.3 Monthly care and maintenance:**

- a). Remove digested slurry from the slurry collection tank to the compost pit.
- b). If compost pits are provided next to the Outlet Displacement Chamber (ODC)- check the level of slurry in it- If filled, divert the slurry to the next compost pit.
- c). Check gate valve, gas outlet pipe and gas pipe fittings for leakage.
- d). Check the biogas pipe pipeline and the moisture trap (water removal system) for any possible leakage.

**9.02.4 Annual care and maintenance**

- a). Check for gas and water leakages from pipeline and appliances.
- b). Repair the worn out accessories include pipes (if polyethylene pipes of cheaper quality, are used, there are chances of developing cracks in them).
- c). Replace damaged or non-working accessories. Open the gate valve and remove all the gas from the plant. After this, check the level of slurry in the Outlet Chamber (OC). If the slurry level is above the second step counted from the bottom in the Outlet Chamber, (above the initial slurry level) remove it up to the second step.

**9.02.5 Five yearly care and maintenance**

- a). Empty the plant completely and clean the sludge and inorganic materials from the bottom of plant.
- b). Give a thorough check to the gas distribution system for possible leakage.
- c). Repaint the ceiling of the Dome, Free Space Area (FSA) and Gas Storage Chamber (GSC) with black enamel paint.
- d). Recharge (reload) the plant with fresh slurry.

## **SECTION- X**

### **DOs, DON'Ts AND GENERAL PRECAUTIONS**

**10.01** Some of the important DOs, DON'Ts and General Precautionary Measures essential for the installation & operation of Grameen Bandhu plant (GBP) are given as under:

#### **10.02** **DOs**

**10.02.1** Select the size of the Grameen Bandhu plant (GBP) depending on the quantity of dung available with the beneficiaries.

**10.02.2** Install the Grameen Bandhu plant (GBP) at a place near the kitchen as well as the cattle shed as far as possible.

**10.02.3** Ensure that the plant is installed in an open space, and gets plenty of sunlight for the whole day, all round the year.

**10.02.4** Ensure that the outer side of the plant is firmly compacted with soil.

**10.02.5** Feed the biogas plant with right proportion of fresh slurry mixture prepared from animal manure and water- for example, when the bovine (cattle and/or buffalo) manure is used as feed stock then add 1 part of cattle dung to 1 part of water by weight for making a homogenous slurry mixture.

**10.02.6** Ensure that the fresh slurry (mixture of dung and water) is free from soil, straw etc.

**10.02.7** For efficient gas utilization, use good quality and approved burners and biogas lamps.

**10.02.8** Only use appropriate appliances.

**10.02.9** Open the gas regulator/cock only at the time of its actual use.

**10.02.10** Adjust flame by turning air regulator till a blue flame is obtained-this will give max. heat.

**10.02.11** Light the match before opening the gas cock.

**10.02.12** Cover the Manhole of Outlet Displacement Chamber (ODC) with BRCM Manhole Cover, to avoid accidental falling of cattle and children inside the plant.

**10.02.13** Check that the Grating (made of bamboo sticks) is properly placed and fixed on the horizontal opening at the level of second step (from bottom end) of Outlet Chamber (OC).

**10.02.14** Purge air from all delivery lines allowing gas to flow for some time prior to first use.

**10.02.15** Adjust the flame by regulator, provided on the biogas burner/stove, till it is blue in colour.

**10.03**     **DON'Ts**

- 10.03.1** Do not install a bigger size of Grameen Bandhu plant (GBP) if sufficient cattle dung or any other feed stock to be used for gas production is/are not available on regular basis?
- 10.03.2** Do not install the Grameen Bandhu plant (GBP) at a long distance from the point of gas utilization to save the cost on pipeline?
- 10.03.3** Do not install a plant under or very close to a tree, especially a big tree?
- 10.03.4** Do not allow soil or sand particles to enter into the digester?
- 10.03.5** Do not allow the scum to form in the digester, otherwise the production of gas might be affected and biogas generation may even stop completely?
- 10.03.6** Do not burn the gas directly from the gas outlet pipe (GOP) even for the testing purpose as it can be dangerous?
- 10.03.7** Do not use burner in the open; otherwise there will be enormous loss of heat?
- 10.03.8** Do not leave the gas regulator (valve) open when the gas is not in use?
- 10.03.9** Do not use the biogas if the flame is yellow?
- 10.03.10** Do not let any water accumulate in the gas pipeline; otherwise the required pressure of gas will not be maintained and the flame will sputter?
- 10.03.11** Do not make digested slurry pit more than 1.0 m (3.0 ft) deep?
- 10.03.12** Do not inhale the biogas as it may be hazardous?
- 10.03.13** Do not add any foreign material in the plant to enhance the gas production?
- 10.03.14** Do not hurry to get biogas after initial loading of slurry, as it may take 10-25 days for gas production in freshly loaded plants?
- 10.03.15** Do not allow building a maximum pressure above 80 cm or 800 mm (800 Kgs/M<sup>2</sup>) of water column to avoid any damage to the Grameen Bandhu plant (GBP)?
- 10.03.16** Do not allow any person to enter the Grameen Bandhu plant (GBP) when it has slurry inside to avoid accidental fall due to slipping which may cause even death?

**10.04 GENERAL PRECAUTIONS AND IMPORTANT THINGS TO REMEMBER**

**10.4.1** Some of the precautionary measures with respect of Grameen Bandhu plant (GBP) are which relate to common constructional and operational aspects etc. are covered in this sub-section.

**10.04.2** For making cement mortar mixture use wooden boxes for correctly measuring the volume of cement, fine sand and coarse sand for making proper ratio of mixture.

**10.04.3** Use the following Cement Mortar, Cement Paste and Cement & Damp Proof Cement Powder (DPC powder) mixtures for construction of different components and sub-components of the Grameen Bandhu plant (GBP):

- a). The Foundations of Ring Beam, MUP, Outlet Chamber-OC (OT+ODC) & MT is to be cast using concrete mixture prepared either in ratio of 1:4:8 (1 cement: 4 coarse sand:8 brick ballast) or 1:3:6 (1 cement:3 coarse sand:6 stone chips) by volume.
- b). For the casting as well as the first coat of rough plaster of the Ring Beam, use cement mortar ratio of 1:3 (1 cement: 3 coarse sand) by volume.
- c). For the second coat of smooth plaster on the Ring Beam, use cement mortar ratio of 1:4 (1 cement: 2 fine sand+2 coarse sand) by volume.
- d). For the casting as well as the first coat of rough plaster on outer surface of MUP, use cement mortar ratio of 1:3 (1 cement: 3 coarse sand) by volume.
- e). For second coat of smooth plaster on the outer surface of MUP, use cement mortar ratio of 1:4 (1 cement: 2 fine sand+2 coarse sand) by volume.
- f). For the casting & first coat of rough plaster on the inner surface of the top segment of MUP, use mortar ratio of 1:3 (1 cement:3 coarse sand) by volume.
- g). For second coat of smooth plaster on the inner surface of the top segment of MUP, use mortar ratio of 1:4 (1 cement: 2 fine sand+2 coarse sand) by volume.
- h). For the casting as well as the first coat of rough plaster on the bottom segment of MUP, use cement mortar ratio of 1:3 (1 cement: 3 coarse sand) by volume.
- i). For second coat of smooth plaster on the bottom segment of MUP, use cement mortar ratio of 1:4 (1 cement: 2 fine sand+2 coarse sand) by volume.
- j). For the casting as well as the first coat of rough plaster both on outer and the inner surface of the rectangular shaped Outlet Tank (OT), use cement mortar ratio of 1:4 (1 cement: 4 coarse sand) by volume.
- k). For the second coat of smooth plaster both on outer and inner surface of the rectangular shaped Outlet Tank (OT), use cement mortar ratio of 1:4 (1 cement: 2 coarse sand+2 fine sand) by volume.
- l). For the casting as well as the first coat of rough plaster both on outer and inner surface of the hemi-spherical shaped Outlet Displacement Chamber (ODC), use cement mortar ratio of 1:4 (1 cement: 4 coarse sand) by volume.
- m). For the second coat of smooth plaster, both on outer and inner surface of the hemi-spherical shaped Outlet Displacement Chamber (ODC), use cement mortar ratio of 1:4 (1 cement: 2 coarse sand+2 fine sand) by volume.
- n). For the casting as well as first coat of rough plaster, both on outer & inner surface of MT, use cement mortar ratio of 1:4 (1 cement: 2 fine sand+2 coarse sand) by volume.

- o).** For the second coat of smooth plaster both on outer & inner surface of MT, use cement mortar ratio of 1:4 (1 cement: 2 fine sand+2 coarse sand) by volume.
- p).** For doing the second coat of smooth plaster for the Main Unit of the Plant (MUP), the Outlet Tank (OT) and the Outlet Displacement Chamber (ODC), add Damp Proof Cement (D.P.C) powder in the cement bag @ 1 kg (DPC) to 50 kg Cement.
- q).** For doing the second coat of smooth plaster for the Mixing Tank (MT), Short Inlet Channel (SIC) and the Manhole Cover (MhC), add Damp Proof Cement (D.P.C) powder in the cement bag at the rate of 1 kg (DPC) to 50 kg Cement.
- r).** For cement polishing and finishing (only on the inside surface, on top of the second coat of smooth plaster for all the components and sub-components of SBP-I)<sup>11</sup>, use cement paste, in the ratio of 1:1 (1kg cement: 1 litres of water).
- s).** For casting and plastering the BRCM walls of digested slurry (or compost) pits, for both, first coat of rough plaster and the second coat of smooth plaster, use cement mortar ratio of 1:5 (1 cement: 2 fine sand+3 coarse sand) by volume.
- t).** For cement polishing and finishing on top of the second coat of smooth plaster (only on the inside surface) of the walls of the digested slurry (or compost) pits, use cement paste, in the ratio of 1:3 (1 kg cement: 3 liters water).
- u).** Before starting construction or plastering of any components and sub-components of SBP-I model biogas plant, use cement water in the ratio of 1:5 (1 Kg Cement: 5 Liters of water) by volume. This cement water has to be poured slowly, using a mug etc.
- v).** Before starting construction or plastering of walls of the digested slurry (or compost) pits, use cement water in the ratio of 1:5 (1 Kg Cemet:5 Liters of water) by volume. This cement water has to be poured slowly, using a mug.

\*\*\*\*\*

11 No cement polishing & finishing to be done on outer surface of, either Main Unit of the Plant (MUP), Outlet Tank (OT), Outlet Displacement Chamber (ODC), Mixing Tank (MT), Short Inlet Channel (SIC) or Manhole Cover (MhC).



**SAMPLE SCHEDULE**  
**FOR**  
**PRACTICAL TRAINING OF RURAL MASONS**  
**ON**  
**STEP-BY-STEP CONSTRUCTION OF GRAMEEN BANDHU PLANT (GBP)**

(BUILDING OF TWO BG UNITS) OF EITHER 1, 2 OR 3 CUM CAPACITY GBP

(DURATION OF TRAINING IS 27 DAYS)

SL. No.	FIELD WORK TO BE DONE ON FIRST GBP MODEL  (Capacity 1 or 2 or 3 M <sup>3</sup> )	CLASS ROOM LECTURES AND PRACTICAL IN WEAVING OF BAMBOO STRUCTURE OF GBP	FIELD WORK TO BE DONE ON THE SECOND GBP MODEL  (Capacity 1 or 2 or 3 M <sup>3</sup> )
<b>1<sup>st</sup> Day</b>	<ul style="list-style-type: none"> <li>- Site selection</li> <li>- Layout of the plant (GBP) 2 or 3 m<sup>3</sup> capacity as per dimensions given in the manual for Pit digging.</li> <li>- Start the work on Pit digging for the first 2 or 3 m<sup>3</sup> capacity GBP plant.</li> </ul>	<p style="text-align: center;"><b><u>INAUGURATION</u></b></p> <ul style="list-style-type: none"> <li>- Introduction to the training programme.</li> <li>- Classroom lecture &amp; slide show on different popular Indian Household plants.</li> <li>- Proper site selection.</li> <li>- Introduction to family of Grameen Bandhu (GBP) model.</li> <li>- Selection of right size of bamboo.</li> <li>- Demonstration and practical on correct method of taking out bamboo strips.</li> <li>- Laying of dimensions on the ground for making moulds for 2 or 3 m<sup>3</sup> GBP plant.</li> </ul>	<ul style="list-style-type: none"> <li>- Site selection</li> <li>- Layout of the plant (GBP model)- 2 or 3 m<sup>3</sup> capacity as per dimensions given in the manual for Pit digging.</li> </ul>
<b>2<sup>nd</sup> Day</b>	<ul style="list-style-type: none"> <li>- Continue with the digging of pit for the first plant</li> </ul>	<ul style="list-style-type: none"> <li>- Using bamboo poles (which were immersed in the water for at least <b>24</b> hours, if too dry) take out the strips (with the traditional hand tools, used by bamboo weavers) from its outer surface.</li> <li>- Continue with pits digging for moulds</li> <li>- Demonstration &amp; Practice session with the correct immersing of bamboo strips in water mixed with Copper Sulphate (<b>CuSo<sub>4</sub></b>), for at least <b>12</b> hours, before using them for weaving the bamboo structures from the next day's onwards.</li> </ul>	<ul style="list-style-type: none"> <li>- Start with the Pit digging for the mould of the second GBP (2 or 3 m<sup>3</sup>) plant.</li> </ul>
<b>3<sup>rd</sup> day</b>	<ul style="list-style-type: none"> <li>- Continue with the digging of pit of the first plant</li> </ul>	<p><b>a). Class room Lectures</b></p> <ul style="list-style-type: none"> <li>- Difference between popular Indian models [floating gas-holder (<b>KVIC</b>) and fixed dome (Janata &amp; Deenbandhu)] models.</li> </ul>	<ul style="list-style-type: none"> <li>- Continue with the pit digging for the second plant.</li> </ul>

		<ul style="list-style-type: none"> <li>- <b>GBP</b> design and its advantages.</li> <li>- Differences between 3-fixed dome models- Janata, Deenbandhu &amp; Grameen Bandhu.</li> </ul> <p><b>b). <u>Practical Demonstrations</u></b></p> <ul style="list-style-type: none"> <li>- Bamboo shells weaving for the two different capacities (2 or 3 m<sup>3</sup>) <b>GBP</b>.</li> </ul>	
<b>4<sup>th</sup> Day</b>	<ul style="list-style-type: none"> <li>- Laying of foundation (for the first <b>GBP</b> model) with either using brick ballast or stone chips and cement mortar</li> </ul>	<p><b>a). <u>Showing of Slides/Photos on different models</u></b></p> <ul style="list-style-type: none"> <li>- Slide show on different popular Indian models.</li> <li>- Showing of slide on the different stages of construction of <b>GBP</b> and detail discussions on the correct laying of foundation.</li> </ul> <p><b>b). <u>Practical Demonstrations</u></b></p> <ul style="list-style-type: none"> <li>- Weaving of bamboo shells for both the <b>GBP</b> (2 or 3 m<sup>3</sup>)</li> <li>- Complete entire shell structure (top &amp; bottom segments) for 2 or 3 m<sup>3</sup> <b>GBP</b>.</li> </ul>	<ul style="list-style-type: none"> <li>- Continue with the digging of pit for the second plant.</li> </ul>
<b>5<sup>th</sup> Day</b>	<ul style="list-style-type: none"> <li>- No construction work</li> </ul>	<p><b>a). <u>Class room Lecture</u></b></p> <ul style="list-style-type: none"> <li>- Comparative merits and demerits of all the popular Indian household biogas models vis-à-vis Grameen Bandhu (<b>GBP</b>) model.</li> <li>-Lecture and discussions on the requirement of building materials for <b>GBP</b>, and proper mixing and preparation of cement mortar.</li> </ul> <p><b>b). <u>Practical Demonstration &amp; Practice</u></b></p> <ul style="list-style-type: none"> <li>- Weaving of bamboo shells for 2 or 3 m<sup>3</sup> capacity plant and completion of weaving of top &amp; bottom shells.</li> </ul>	<ul style="list-style-type: none"> <li>- Laying of foundation for the second plant, with either using brick ballast or stone chips with cement mortar.</li> </ul>
<b>6<sup>th</sup> Day</b>	<ul style="list-style-type: none"> <li>- Placing of bottom (lower) bamboo shell on the curved bottom surface of the foundation. This should correctly sit on the surface of foundation, if the following three major conditions are met:</li> <li>- (i) Pit is done properly, (ii) Foundation is made correctly and (iii) Bottom bamboo shell is woven correctly, there would not be any gap in between the surface of the foundation &amp; bottom surface of bamboo shell.</li> <li>- Place the top shell (which makes upper part of digester, GSC &amp; covered dome of the <b>GBP</b>) on top of the bottom shell and join the two together with binding wire.</li> </ul>	<p><b>a). <u>Class room Lecture</u></b></p> <ul style="list-style-type: none"> <li>- Review the previous day's construction methodology and discussions on the day's construction and fieldwork.</li> <li>- Clarification of doubts.</li> </ul> <p><b>b). <u>Practical Demonstration &amp; Practice</u></b></p> <ul style="list-style-type: none"> <li>- Weaving and making of bamboo structures for other components of the two <b>GBP</b> plants.</li> <li>- Practice session on taking out bamboo strips and weaving.</li> </ul>	<ul style="list-style-type: none"> <li>- No construction work</li> </ul>

<p><b>7<sup>th</sup> Day</b></p>	<ul style="list-style-type: none"> <li>- Fix the gas outlet pipe on the Crown of the dome of top shell.</li> <li>- Fix and properly tie a <b>4" dia. &amp; 6 ft</b> long Asbestos Cement (<b>AC</b>) pipe, inside the opening provided on the upper bamboo shell.</li> <li>- Casting and first coat of rough plastering on the outer surface of the shell for <b>MUP</b>, using correct cement mortar.</li> </ul>	<p><b>a). <u>Class room Lecture cum Discussion</u></b></p> <ul style="list-style-type: none"> <li>- Review of previous day's work.</li> <li>- Discussion on the construction work for the seventh day.</li> <li>- Clarification of doubts.</li> </ul> <p><b>b). <u>Practical &amp; Practice</u></b></p> <ul style="list-style-type: none"> <li>- Practical demonstrations.</li> <li>- Practice on taking out bamboo strips and bamboo weaving.</li> </ul>	<ul style="list-style-type: none"> <li>- Placing the bottom (lower) bamboo shell on the surface of the foundation.</li> <li>- Place the top (upper) bamboo shell of the <b>MUP</b> on top of the bottom shell, and tie both of them properly, all along their periphery, using binding wire in the manner that the entire structure becomes a single ellipsoidal shaped structure.</li> </ul>
<p><b>8<sup>th</sup> Day</b></p>	<ul style="list-style-type: none"> <li>- Plaster on the outer upper surface of the <b>MUP</b> with second coat of smooth plaster (on top of the first coat of rough plaster done on previous day), after mixing <b>DPC</b> powder in cement in the ratio of <b>1: 50 (1 kg: 50 kg Cement)</b> by weight.</li> </ul>	<p><b>a). <u>Class room Lecture cum Discussions</u></b></p> <ul style="list-style-type: none"> <li>- Review of previous day's work and doubt clarification.</li> <li>- Discussions on the construction work for eighth day.</li> </ul> <p><b>b). <u>Practical &amp; Practice</u></b></p> <ul style="list-style-type: none"> <li>- Practical Demonstration.</li> <li>- Practice with taking bamboo strips and weaving.</li> </ul>	<ul style="list-style-type: none"> <li>- Fix Gas Outlet Pipe on the centre (crown) of the dome of the top shell.</li> <li>- Fix and properly tie <b>AC</b> pipe (<b>4" dia. and 6 ft long</b>) inside the opening provided in the upper bamboo shell for the <b>MUP</b>.</li> </ul>
<p><b>9<sup>th</sup> Day</b></p>	<ul style="list-style-type: none"> <li>- Properly wet the plaster done till date.</li> <li>- Casting and first layer of rough plaster inside the inner surface of the upper portion of <b>MUP</b> till the <b>Junction</b> of <b>Top</b> hemispherical segment [comprising of Dome, Free Space Area (<b>FSA</b>), <b>GSC</b> and upper portion of the digester (fermentation chamber)] plus the <b>Bottom</b> concave (dish shaped) segment of the <b>MUP</b>.</li> </ul>	<p><b>a).<u>Class room Lecture cum Discussions</u></b></p> <ul style="list-style-type: none"> <li>- Free</li> </ul> <p><b>b).<u>Practical &amp; Practice</u></b></p> <ul style="list-style-type: none"> <li>- Free</li> </ul>	<ul style="list-style-type: none"> <li>- Casting and first coat of rough plaster on the outer surface of the shell for <b>MUP</b> with appropriate mixture of cement mortar.</li> </ul>
<p><b>10<sup>th</sup> Day</b></p>	<ul style="list-style-type: none"> <li>- Wet the plaster done till date.</li> <li>-Second coat of smooth plaster on the inside upper segment of the <b>MUP</b> using cement mortar mixed with DPC powder in the ratio <b>1:50 (1 kg DPC: 50 kg Cement)</b> by weight.</li> <li>-Polishing &amp; finishing the inner surface of the top segment of <b>MUP</b> with cement paste in the ratio of <b>1:1 (1 kg Cement: 1 lt. Water)</b> by weight.</li> </ul>	<p><b>a).<u>Class room Lecture cum Discussions</u></b></p> <ul style="list-style-type: none"> <li>- Free</li> </ul> <p><b>b). <u>Practical &amp; Practice</u></b></p> <ul style="list-style-type: none"> <li>- Free</li> </ul>	<ul style="list-style-type: none"> <li>- Plaster on the outer surface of the plant with second coat of smooth plaster, on top of the first plaster done on the previous day. The cement should be mixed with in the ratio of <b>1: 50 (1 kg DPC: 50 kg Cement)</b>, by weight, for the second plaster.</li> </ul>
<p><b>11<sup>th</sup> day</b></p>	<ul style="list-style-type: none"> <li>- Wet the plaster done till date.</li> <li>-Scratch off mortar from the bottom ends of the already cast top</li> </ul>	<p><b>a). <u>Class room Lecture cum Discussions</u></b></p> <ul style="list-style-type: none"> <li>- Free</li> </ul> <p><b>b). <u>Practical &amp; Practice</u></b></p>	<ul style="list-style-type: none"> <li>- Wet the plaster done till date.</li> <li>- Casting and first coat of rough plaster inside the upper portion of the <b>MUP</b> till the <b>Junction</b>, of the <b>Top</b></li> </ul>

	<p>segment of the <b>MUP</b> from inside.</p> <ul style="list-style-type: none"> <li>-Casting and first coat of rough plastering of bottom segment (dish shaped) of the <b>MUP</b>.</li> <li>-Casting and first coat of rough plastering of Outlet Tank (<b>OT</b>), from inside.</li> </ul>	<ul style="list-style-type: none"> <li>- Free</li> </ul>	<p>hemispherical segment [this comprises of Dome, Free Space Area (<b>FSA</b>), <b>GSC</b> and upper portion of the digester (fermentation chamber)] plus the <b>Bottom</b> concave (dish shaped) segment of <b>MUP</b>.</p>
<b>12<sup>th</sup> day</b>	<ul style="list-style-type: none"> <li>-Wet the plaster done till date.</li> <li>-Second coat of smooth plastering on the bottom segment of <b>MUP</b>.</li> <li>-Second coat of smooth plastering on inside surface of Outlet Tank.</li> <li>-For the second coat of smooth plastering of bottom segment of <b>MUP</b> and the <b>OT</b>, use <b>DPC</b> powder in cement (<b>1 kg DPC: 50 kg Cement</b>).</li> <li>-Casting of foundation of the Outlet Displacement Chamber (<b>ODC</b>).</li> <li>- Casting of Mixing Tank foundation.</li> </ul>	<p><b>a). <u>Class room Lecture cum Discussions</u></b></p> <ul style="list-style-type: none"> <li>- Free</li> </ul> <p><b>b). <u>Practical &amp; Practice</u></b></p> <ul style="list-style-type: none"> <li>- Free</li> </ul>	<ul style="list-style-type: none"> <li>- Properly wet the plaster done till date.</li> <li>-Second coat of smooth plaster of inside top segment of the <b>MUP</b>, using <b>DPC</b> powder mixed in cement in the ratio <b>1:50 (1 kg DPC: 50 kg Cement)</b> by weight.</li> <li>- Polishing of inner surface of the inside top segment of <b>MUP</b>, using pure cement paste in the ratio <b>1:1 (1 kg Cement: 1 lt. Water)</b>, by weight.</li> </ul>
<b>13<sup>th</sup> Day</b>	<ul style="list-style-type: none"> <li>- Wet the plaster done till date.</li> <li>- Place hemispherical bamboo shell for <b>ODC</b> on top of the foundation made the previous day.</li> <li>-Casting and first coat of rough plaster on outer surface of <b>ODC</b>.</li> <li>-Construction (casting &amp; plastering) of minor components and sub-components, e.g. Mixing Tank (<b>MT</b>), Short Inlet Channel (<b>SIC</b>) &amp; Manhole Cover (<b>MhC</b>) of <b>ODC</b>.</li> </ul>	<p><b>a). <u>Class room Lecture cum Discussions</u></b></p> <ul style="list-style-type: none"> <li>- Free</li> </ul> <p><b>b). <u>Practical &amp; Practice</u></b></p> <ul style="list-style-type: none"> <li>- Free</li> </ul>	<ul style="list-style-type: none"> <li>- Wet the plaster done till date.</li> <li>Scratch off some mortar from the inside bottom ends of the already cast and plastered top segment of <b>MUP</b>.</li> <li>-Casting and first coat of rough plastering of bottom segment (dish shaped) of the <b>MUP</b>.</li> <li>-Casting &amp; first coat of rough plastering of Outlet Tank (<b>OT</b>), from inside.</li> </ul>
<b>14<sup>th</sup> Day</b>	<ul style="list-style-type: none"> <li>- Second coat of smooth plastering on the outer surface of <b>ODC</b>, using <b>DPC</b> powder mixed with cement in the ratio of <b>1: 50 (1 kg DPC: 50 kg Cement)</b> by weight.</li> <li>- Construction (casting &amp; plastering) of other minor components and sub-components of the plant, e.g. Mixing Tank (<b>MT</b>), Short Inlet Channel (<b>SIC</b>) and Manhole Cover (<b>MhC</b>) of <b>ODC</b>.</li> </ul>		<ul style="list-style-type: none"> <li>-Wet the plaster done till date.</li> <li>-Second coat of smooth plastering on the bottom segment of the <b>MUP</b>.</li> <li>-Second coat of smooth plastering on the inside surface of Outlet Tank-<b>OT</b>.</li> <li>-For the second coat of smooth plastering of bottom segment of <b>MUP</b> and the <b>OT</b>, use <b>DPC</b> powder in cement (<b>1 kg DPC: 50 kg Cement</b>).</li> <li>- Polishing of inner surface of the bottom portion of <b>MUP</b> including the Outlet Tank (<b>OT</b>) with pure cement paste in the ratio <b>1:1 (1 kg cement: 1 lt. water)</b> by weight.</li> <li>- Casting of foundation of <b>ODC</b>.</li> </ul>
<b>15<sup>th</sup> Day</b>	<ul style="list-style-type: none"> <li>- Casting and first coat of rough plastering of <b>ODC</b> from inside (including the bottom surface of the bamboo mat), laid on top of the base of foundation of <b>ODC</b>.</li> </ul>	<p><b>a). <u>Class room Lecture cum Discussions</u></b></p> <ul style="list-style-type: none"> <li>- Free</li> </ul> <p><b>b). <u>Practical &amp; Practice</u></b></p>	<ul style="list-style-type: none"> <li>- Properly wet the plaster done till date.</li> <li>- Placement of hemispherical bamboo shell for the <b>ODC</b> on top of the foundation made on the previous day.</li> <li>-Casting and first coat of rough</li> </ul>

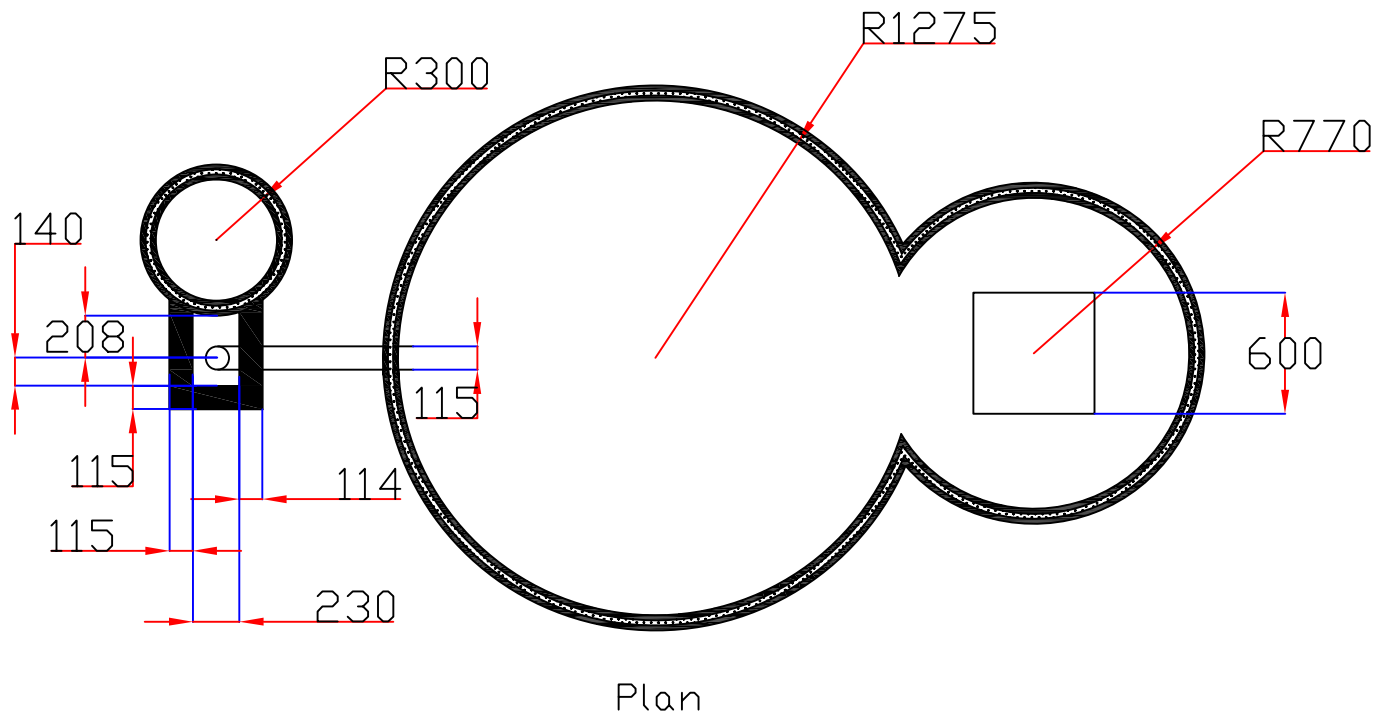
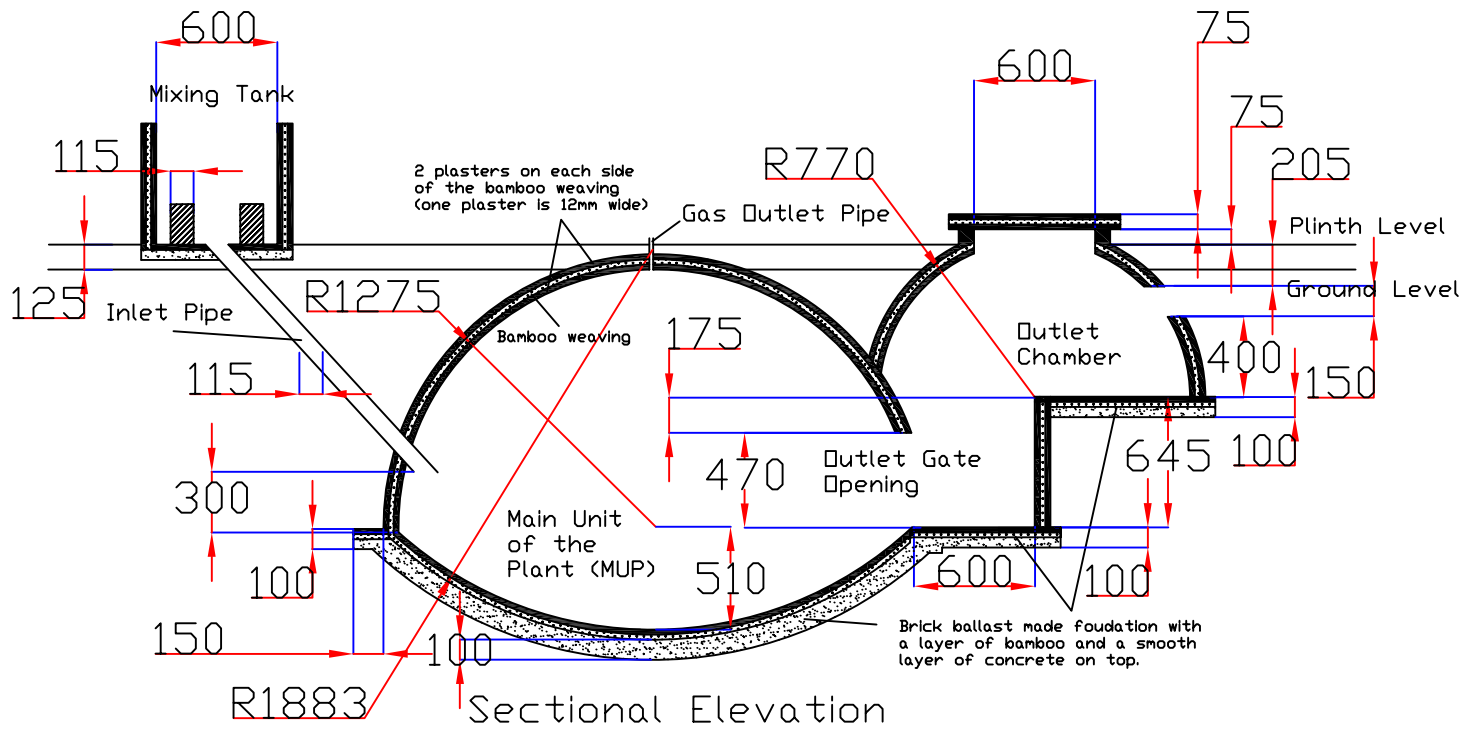
	<ul style="list-style-type: none"> <li>-Construction (casting and plastering) of balance work on the minor components, sub-components of the plant.</li> </ul>	<ul style="list-style-type: none"> <li>- Free</li> </ul>	<ul style="list-style-type: none"> <li>plastering on the outer surface of <b>ODC</b>, from outside.</li> <li>--Construction (casting &amp; plastering) of minor components and sub-components, e.g. Mixing Tank (<b>MT</b>), Short Inlet Channel (<b>SIC</b>) &amp; Manhole Cover (<b>MhC</b>) of <b>ODC</b>.</li> </ul>
<b>16<sup>th</sup> Day</b>	<ul style="list-style-type: none"> <li>- Second coat of smooth plastering on the entire <b>ODC</b> from inside, using <b>DPC</b> powder mixed in cement in the ratio <b>1:50 (1 kg DPC: 50 kg Cement)</b> by weight.</li> <li>- Complete the construction (casting and plastering) of the left over work on the minor components and sub-components.</li> <li>- Polishing and finishing of the inner surface of the <b>ODC</b> from inside and the Minor components, and sub-components with cement paste (<b>1 kg Cement: 1 lt. water</b>).</li> </ul>	<p><u>Lecture cum Discussions</u></p> <ul style="list-style-type: none"> <li>- Classroom lectures, slide show &amp; discussion on the work done till date.</li> </ul>	<ul style="list-style-type: none"> <li>-- Second coat of smooth plastering on the outer surface of <b>ODC</b>, using <b>DPC</b> powder mixed with cement in the ratio of <b>1:50 (1 kg DPC: 50 kg Cement)</b> by weight.</li> <li>-- Construction (casting &amp; plastering) of other minor components and sub-components of the plant such as Mixing Tank (<b>MT</b>), Short Inlet Channel (<b>SIC</b>) and Manhole Cover (<b>MhC</b>) of <b>ODC</b>.</li> </ul>
<b>17<sup>th</sup>Day</b>	<ul style="list-style-type: none"> <li>- Start Curing of entire plant (continue curing for the next <b>10</b> days).</li> <li>- Digging of digester slurry (compost) pits as per the dimensions given in the manual.</li> </ul>	<p><u>Lecture-cum-Discussion</u></p> <ul style="list-style-type: none"> <li>- Free</li> </ul>	<ul style="list-style-type: none"> <li>- Casting and first coat of rough plastering on the inside surface <b>ODC</b> (including the bottom surface of the bamboo mat) laid on top of the foundation of <b>ODC</b>.</li> <li>-- Construction (casting &amp; plastering) of balance work on minor components, sub-components of the plant.</li> </ul>
<b>18<sup>th</sup> Day</b>	<ul style="list-style-type: none"> <li>- Start construction (casting and first coat of rough plastering) of <b>BRCM</b> digester slurry (compost) pit.</li> </ul>	<p><u>Lecture cum Discussions</u></p> <ul style="list-style-type: none"> <li>-Classroom lecture, slide show and discussions on the work done till date.</li> <li>- Clarifications on query raised by Trainees.</li> </ul>	<ul style="list-style-type: none"> <li>--Second coat of smooth plastering on the entire inside surface of <b>ODC</b> from inside, using <b>DPC</b> powder mixed with cement in the ratio of <b>1:50 (1 kg DPC: 50 kg Cement)</b> by weight.</li> <li>- Completing the construction (casting and plastering) of the left over work on the minor components and sub-components, e.g. Mixing Tank (<b>MT</b>), Short Inlet Channel (<b>SIC</b>) and the Manhole Cover (<b>MhC</b>).</li> <li>- Polishing &amp; finishing of inner surface of the bottom segment of <b>ODC</b>, and the inner surface of the Minor Components and Sub-components, using cement paste in the ratio of <b>1:1 (1 kg Cement: 1 lt. water)</b> by weight.</li> </ul>
<b>19<sup>th</sup> Day</b>	<ul style="list-style-type: none"> <li>- Second coat of smooth plastering of digester slurry (compost) pit.</li> <li>-Construction (casting and plastering) of <b>BRCM</b> channels to connect Discharge Opening (<b>DO</b>) on the <b>ODC</b> wall to the digested</li> </ul>	<p><u>Lecture cum Discussions</u></p> <ul style="list-style-type: none"> <li>- Classroom lecture, slide show and discussions on the work done till date.</li> <li>- Clarifications on query raised by Trainees.</li> </ul>	<ul style="list-style-type: none"> <li>- Curing of entire plant (continue for the next <b>10</b> days).</li> <li>- Digging of digester slurry (compost) pits as per the dimensions given in the manual.</li> </ul>

	slurry (compost) pits.		
<b>20<sup>th</sup> Day</b>	--Start curing of digested slurry pits (continue for the next 7 days). --Laying of pipe lines (including water remover) from plant to the place of utilisation of biogas.	- Open house for the farmers and local government functionaries and prospective plant <b>Owners /End Users</b> .	- Start construction (casting and first coat of rough plastering) of <b>BRCM</b> digested slurry (compost) pits.
<b>21<sup>st</sup> Day</b>	- Fitting of biogas stoves and biogas lamps with the first <b>GBP</b> plant.	- Free	--Second coat of smooth plastering of digester slurry (compost) pit. --Construction (casting and plastering) of <b>BRCM</b> channels to connect Discharge Opening ( <b>DO</b> ) on the <b>ODC</b> wall to the digested slurry (compost) pits.
<b>22<sup>nd</sup> Day</b>	- No Work	- Free	- Start curing of digested slurry pits (continue for the next 7 days). - Laying of pipe lines (including water remover) from plant to the place of utilisation of biogas.
<b>23<sup>rd</sup> Day</b>	- No work	- Free	- Fitting of biogas stoves and biogas lamps with the second <b>GBP</b> plant.
<b>24<sup>th</sup> Day</b>	- Do the proper back-filling with mud and properly level the mud by light ramming, using wooden ram. - The height of the filling should be <b>150 mm (6")</b> above the Crown of the Dome of the <b>MUP</b> of the <b>GBP</b> model plant.	- Demonstration on how to test the <b>GBP</b> model, how too empty it, how to measure biogas pressure inside the plant, identifications of faults & trouble-shooting and method of repair/ rectification of faults in <b>GPB</b> model. - Slide show, discussions and clarifications.	- No Work
<b>25<sup>th</sup> Day</b>	- No Work	- Visit to the nearby working plant and discussions at site about the initial charging, gas commissioning, proper feeding, operation & use, daily care & maintenance of biogas burners and lamps, to ensure efficient working of <b>GBP</b> model.	- No Work
<b>26<sup>th</sup> &amp; 27<sup>th</sup> Day</b>	- Stop the curing of the first <b>GBP</b> model. - Leave the plant for drying.	- Explanation about how to do the painting of plant from inside with enamel paint after it is dried up. - Demonstration of how to do initial loading of the plant with fresh slurry (dung) in the ratio <b>1:1 (1 kg dung: 1 lt. water)</b> . --Explanation and demonstration about commissioning of plant and correct utilisation of biogas and digester slurry. - Training along with the <b>End Users</b> , on the proper daily care, maintenance and different applications of biogas, digested slurry and compost. - <b>Summing Up.</b> <b>VALEDICTORY &amp; CLOSING FUNCTION</b>	--Do proper back-filling with mud and properly level the mud by light ramming, using wooden ram. - The height of the filling should be <b>150 mm (6")</b> above the Crown of the Dome of the <b>MUP</b> of the <b>GBP</b> Model Plant.





# Dimensional drawing of a 2 cubic meter Grameen Bandhu Biogas Plant. (40 days HRT)

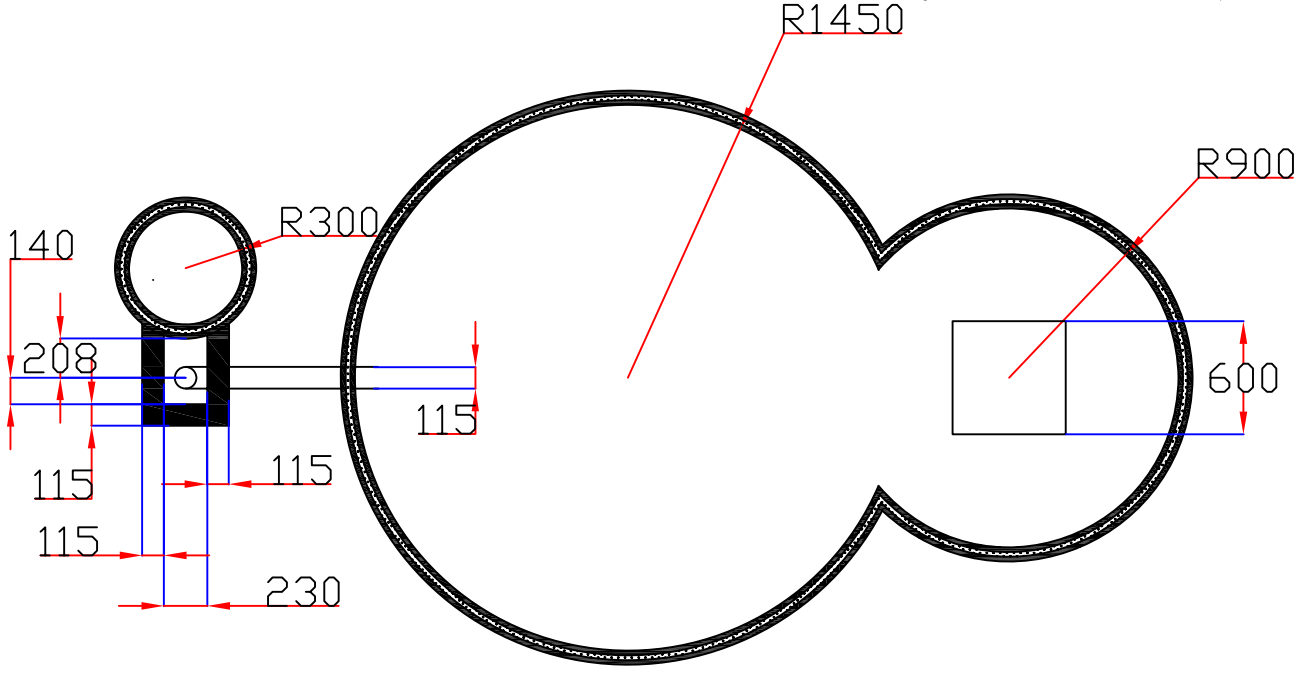
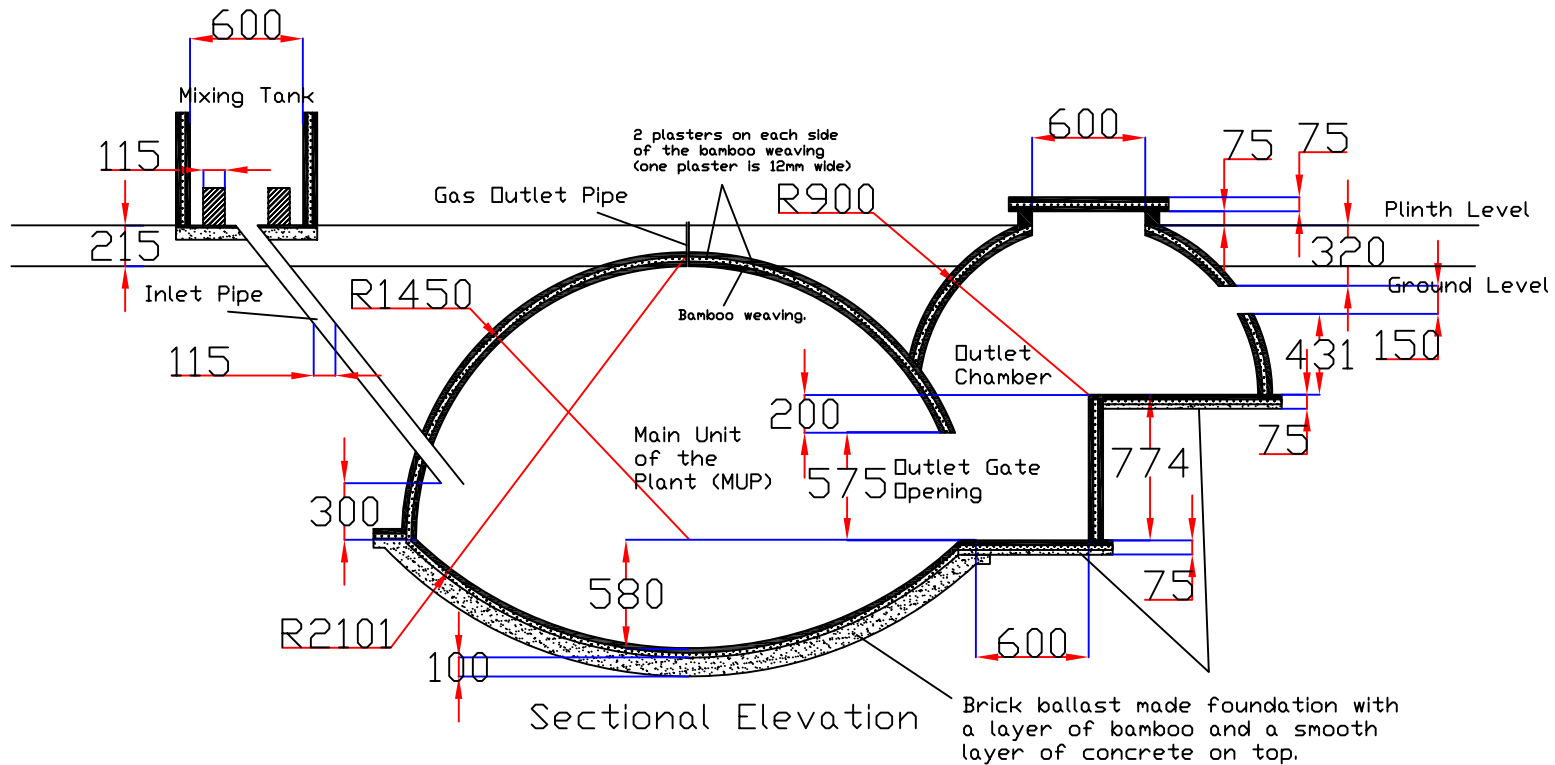


All the dimensions are in mm.  
All the walls are 75mm wide except those which are specified to be 115mm.

Designed and developed by:  
Engr Raymond Myles, Secretary General-  
cum-Chief Executive, INSEDA, New Delhi  
Drawing by : Céline Stein and Victor Oudet  
July 1, 2009

In case of a discrepancy, contact INSEDA, New Delhi

# Dimensional drawing of a 3 cubic meter Grameen Bandhu Biogas Plant. (40 days HRT)

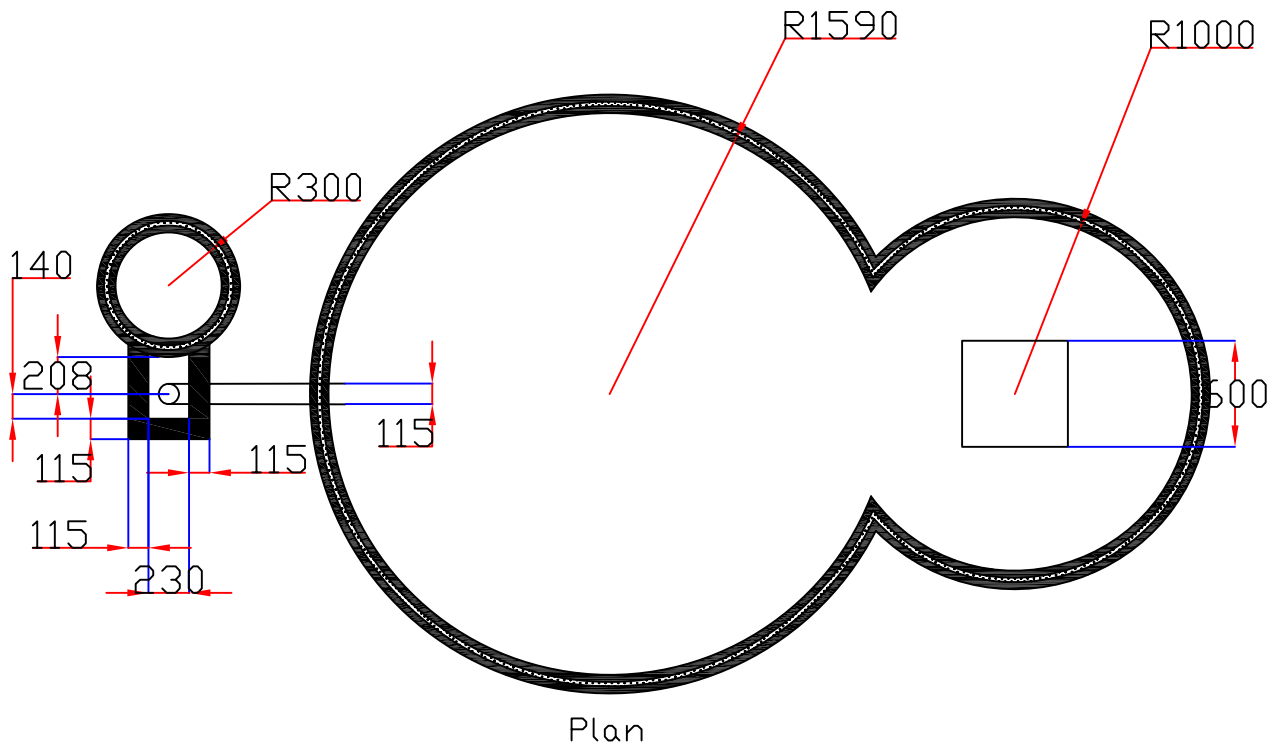
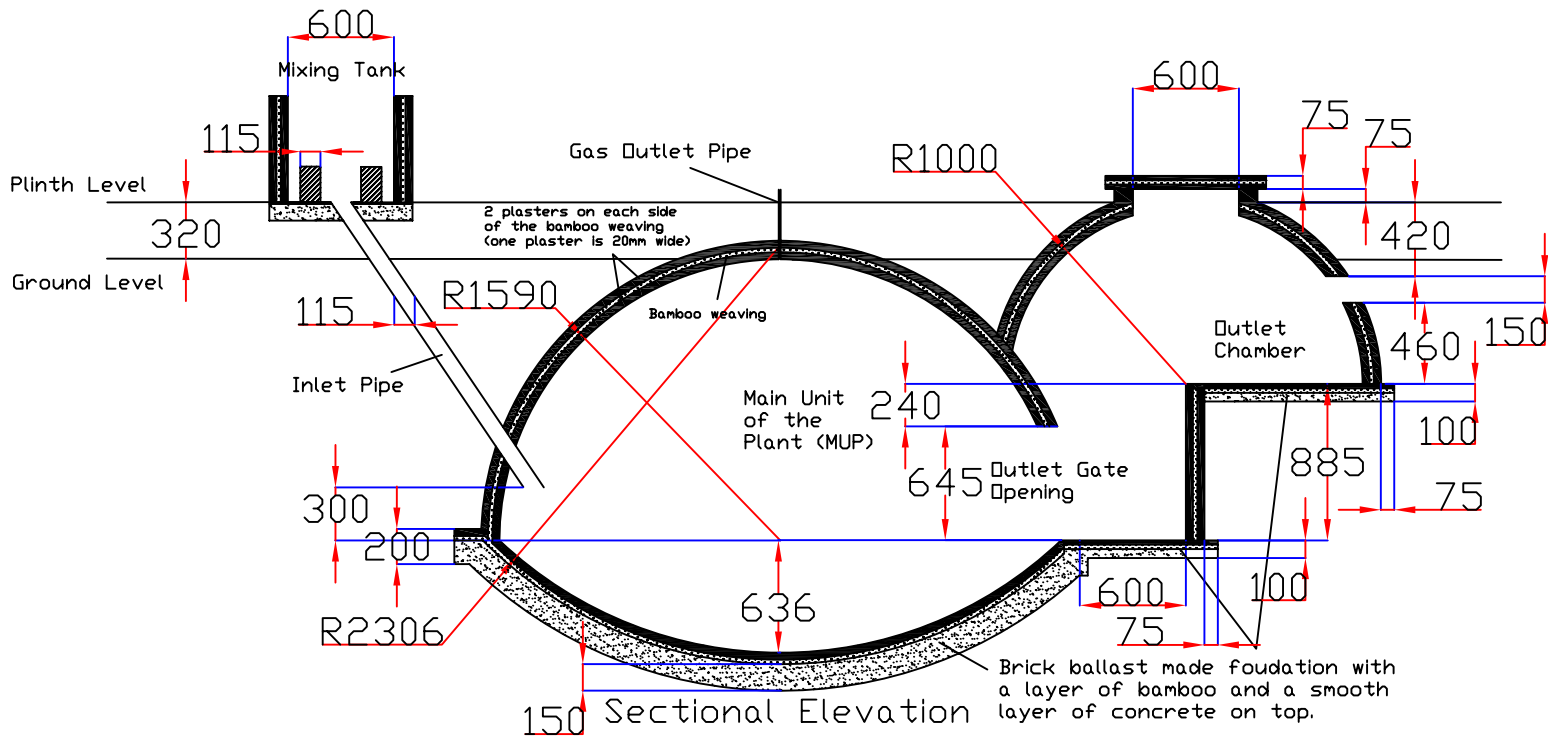


All the dimensions are in mm.  
All the walls are 75mm wide except those which are specified to be 115mm.

Designed and developed by:  
Engr Raymond Myles, Secretary General-cum-Chief Executive, INSEDA, New Delhi  
Drawing by : Céline Stein and Victor Oudet  
July 1, 2009

In case of a discrepancy, contact INSEDA, New Delhi

# Dimensional drawing of a 4 cubic meter Grameen Bandhu Biogas Plant. (40 days HRT)

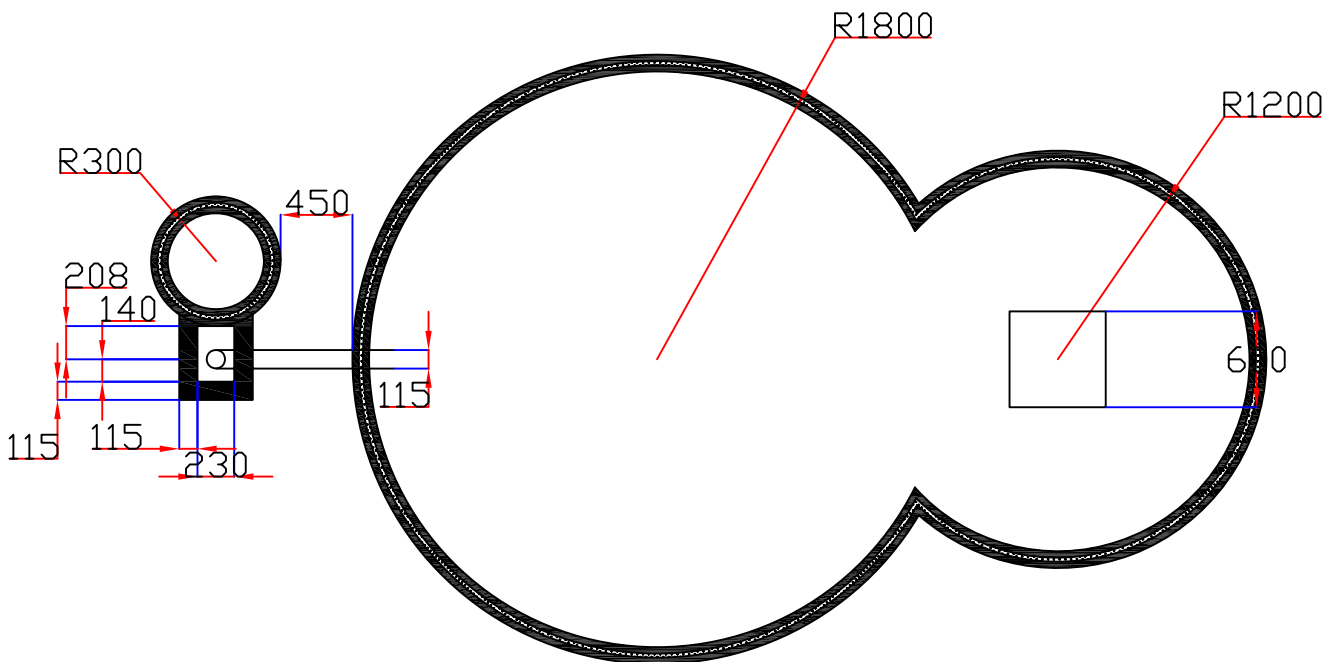
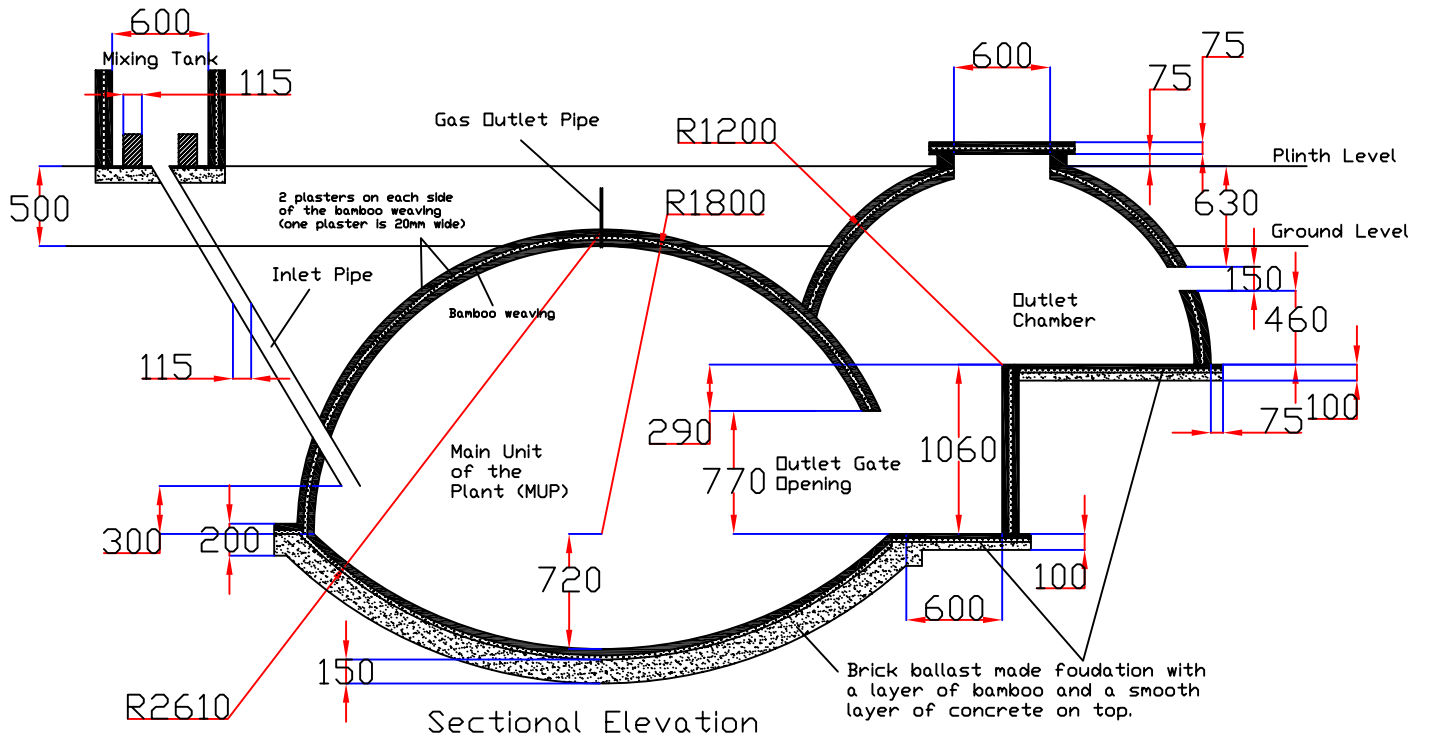


All the dimensions are in mm.  
All the walls are 105mm wide except those which are specified to be 115mm.

In case of a discrepancy, contact INSEDA, New Delhi

*Designed and developed by:*  
Engr Raymond Myles, Secretary General-  
cum-Chief Executive, INSEDA, New Delhi  
*Drawing by :* Céline Stein and Victor Oudet  
*July 1, 2009*

# Dimensional drawing of a 6 cubic meter Grameen Bandhu Biogas Plant. (40 days HRT)

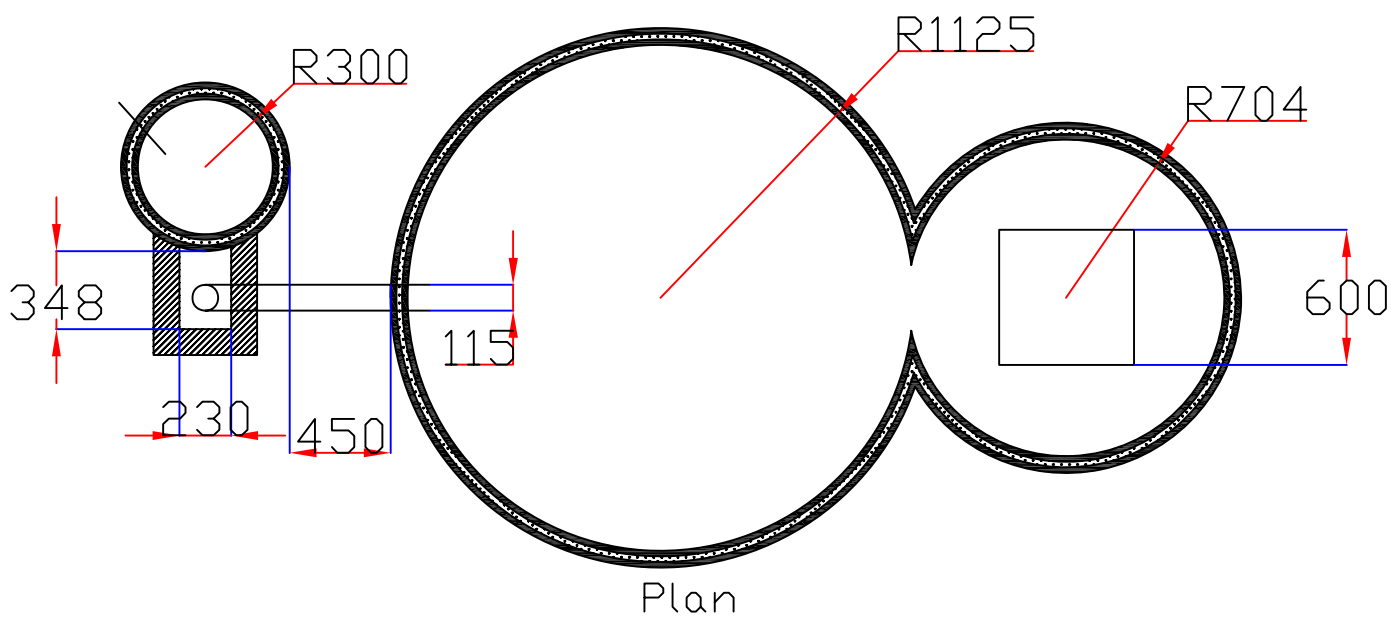
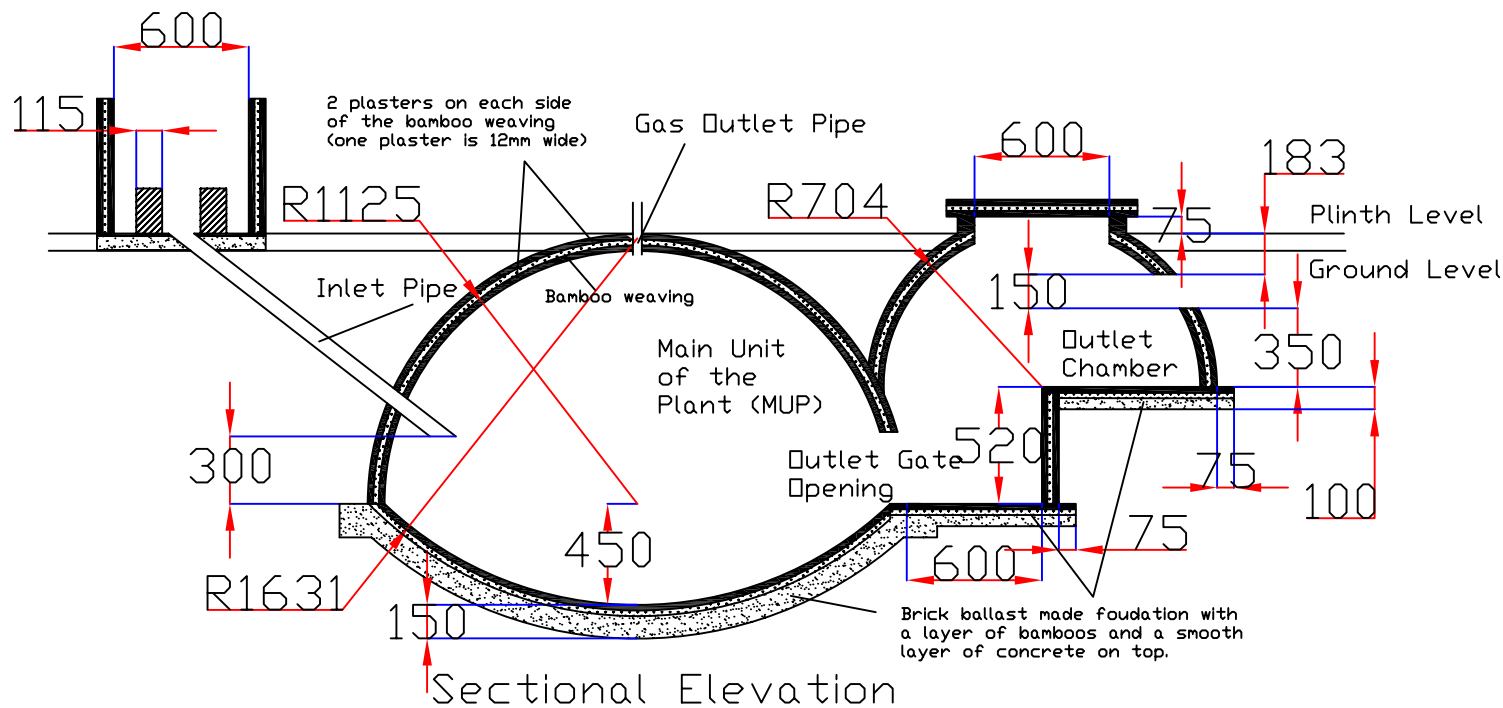


All the dimensions are in mm.  
All the walls are 105mm wide except those which are specified to be 115mm.

**ESTIMATED COST OF BUILDING GRAMEEN BANDHU BIOGAS PLANTS (GBPS) OF 40 Days HRT**

<u>(Estimated cost of GBPs is as per the cost of building materials, labour, masons and transport of materials etc., prevailing on December 01,13 at Bharatpur district, Rajasthan State)</u>													
SL.	Plant Size (Capacity)	Average Rate Per Unit		1 CuM Capacity (40 days HRT)		2 CuM Capacity (40 days HRT)		3 CuM Capacity (40 days HRT)		4 CuM Capacity (40 days HRT)		6 CuM Capacity (40 days HRT)	
		(Rate) Rs.	(Unit) Rs.	(Qty) Rs.	(Cost) Rs.	(Qty) Rs.	(Cost) Rs.	(Qty) Rs.	(Cost) Rs.	(Qty) Rs.	(Cost) Rs.	(Qty) Rs.	(Cost) Rs.
(a)	(b)	(c)	(d)	(e)	(f)	(g)	(h)	(i)	(j)	(k)	(l)	(m)	(n)
<b>(A) Direct Cost of GB Plant</b>													
1	Bamboo 1-2" Dia & 12-Foot Length	65	Per Bamboo Piece	60	3,900.00	100	6,500.00	130	8,450.00	150	9,750.00	200	13,000.00
2	Cement 50 Kg Bag	300	Per Bag of 50 Kg Weight	7	2,100.00	12	3,600.00	16	4,800.00	20	6,000.00	25	7,500.00
3	Stone Pebbles/Chips (1/4 to 1/2" Dia.)	45	Per Cubic Feet	20	900.00	30	1,350.00	40	1,800.00	45	2,025.00	60	2,700.00
4	Coarse Sand (Badarpur)	45	Per Cubic Feet	25	1,125.00	40	1,800.00	50	2,250.00	60	2,700.00	75	3,375.00
5	Fine Sand	45	Per Cubic Feet	25	1,125.00	40	1,800.00	50	2,250.00	60	2,700.00	75	3,375.00
6	AC/HDP Pipe (4" dia x 2 M Length)	200	Per Meter Length	2	400.00	2	400.00	2	400.00	2	400.00	2	400.00
7	GI Pipe (7" length & 1/2" or 3/4" dia)-2 Sockets 1/2" or 3/4" dia welded	150	Per set (1/2" dia for 1 to 3 & 3/4" dia for 4 & 6 CuM)	1	150.00	1	150.00	1	150.00	1.25	187.50	1.25	187.50
8	D.P.C. Powder/Liquid	200	Per Kg/Lit	2	400.00	3	600.00	4	800.00	6	1,200.00	8	1,600.00
9	Binding Wire	100	Per Kg	0.5	50.00	0.75	75.00	1	100.00	1.25	125.00	1.5	150.00
10	Reinforcement (Mild Steel Rods)	200	Per Kg	0	-	0	-	0	-	0	-	0	0.000.00
11	Paint (Black Enamel/Rubber)	150	Per Liter	1	150.00	1.5	225.00	2	300.00	2.5	375.00	3	450.00
12	Labour for Bamboo weaving-(5 Nos)	175	Per Woman Day-(5 Nos)	10	1,750.00	20	3,500.00	25	4,375.00	30	5,250.00	35	6,125.00
13	Labour (Pit digging)-(2 Nos)	300	Per Labour Day-(2 Nos)	3	900.00	4	1,200.00	5	1,500.00	6	1,800.00	8	2,400.00
14	Labour (Plant Construction)-(2 Nos)	300	Per Labour Day-(2 Nos)	7	2,100.00	9	2,700.00	11	3,300.00	14	4,200.00	18	5,400.00
15	Master Mason-(2 Nos)	400	Per Labour Day-(2 Nos)	7	2,800.00	9	3,600.00	11	4,400.00	14	5,600.00	18	7,200.00
16	Feeder/Slurry-Mixing Fan	2000	Fabricated as per order (Cost of minor items not covered in other heads)	1	2,000.00	1	2,000.00	1	2,000.00	1	2,000.00	1	2,000.00
17	Miscellaneous Expenditure				500.00		600.00		800.00		1,000.00		1,500.00
18	Transportation of Material to Site	1600	Per Trolley Trip	2	3,200.00	2	3,200.00	2	3,200.00	3	4,800.00	3	4,800.00
<b>(A)</b>	<b>Total (Average) direct cost of building GBP</b>				<b>23,550.00</b>		<b>33,300.00</b>		<b>40,875.00</b>		<b>48,852.50</b>		<b>68,162.50</b>
(B)	Supervision & Overhead Cost [15% of total direct cost (Row 27)]				3,532.50		4,995.00		6,131.25		7,327.88		10,224.38
<b>I</b>	<b>Total Cost of building GBP</b>				<b>27,082.50</b>		<b>38,295.00</b>		<b>47,006.25</b>		<b>56,180.38</b>		<b>78,386.88</b>
<b>II</b>	<b>Total Cost (Rounded-off to the nearest hundred)</b>				<b>27,000.00</b>		<b>38,300.00</b>		<b>47,000.00</b>		<b>56,000.00</b>		<b>78,300.00</b>
<b>III</b>	<b>AV Estimated Cost of GBP/CuM Biogas Generation Capacity/Day</b>				<b>27,000.00</b>		<b>19,150.00</b>		<b>15,666.67</b>		<b>14,000.00</b>		<b>13,050.00</b>
<b>VI</b>	<b>Total Cost of GBP in Euro (1 Euro = 84 INR) as on December 01, 2013</b>				<b>321.43</b>		<b>455.95</b>		<b>559.52</b>		<b>666.67</b>		<b>932.14</b>

# Dimensional drawing of a 1 cubic meter Grameen Bandhu Biogas Plant, (55 days HRT)

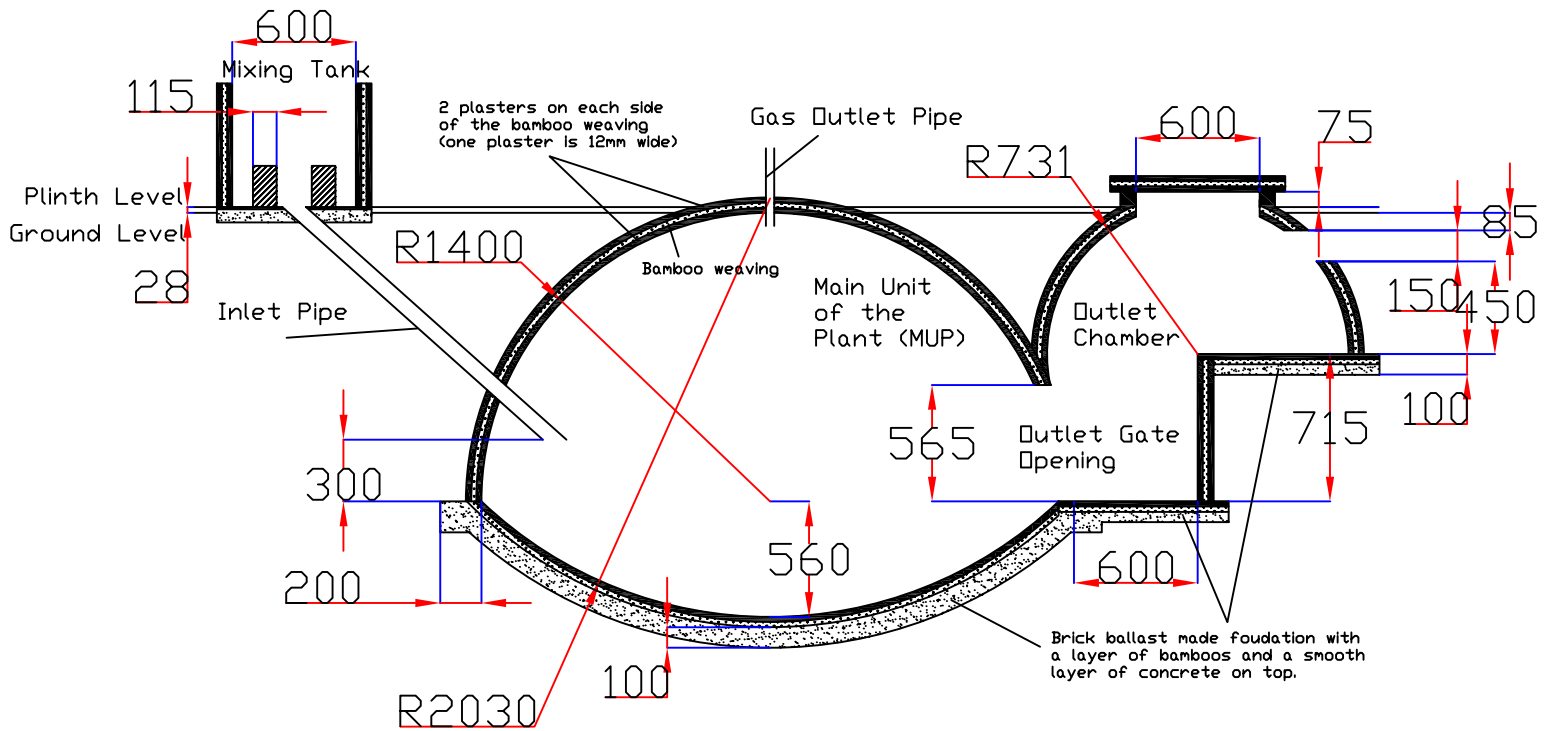


All the dimensions are in mm.  
All the walls are 75mm wide except those which are specified to be 115mm.

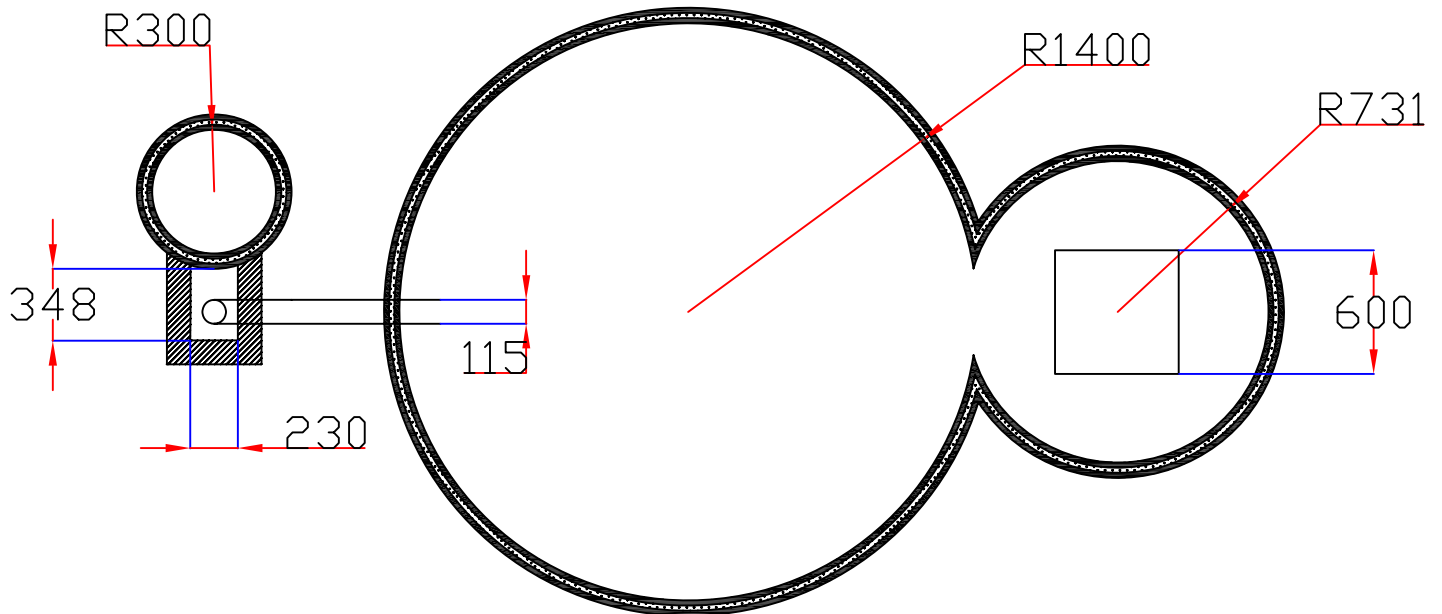
*Designed and developed by:*  
Engr Raymond Myles, Secretary General-  
cum-Chief Executive, INSEDA, New Delhi  
*Drawing by :* Céline Stein and Victor Oudet  
*July 1, 2009*

In case of a discrepancy, contact INSEDA, New Delhi

# Dimensional drawing of a 2 cubic meter Grameen Bandhu Biogas Plant, (55 days HRT)



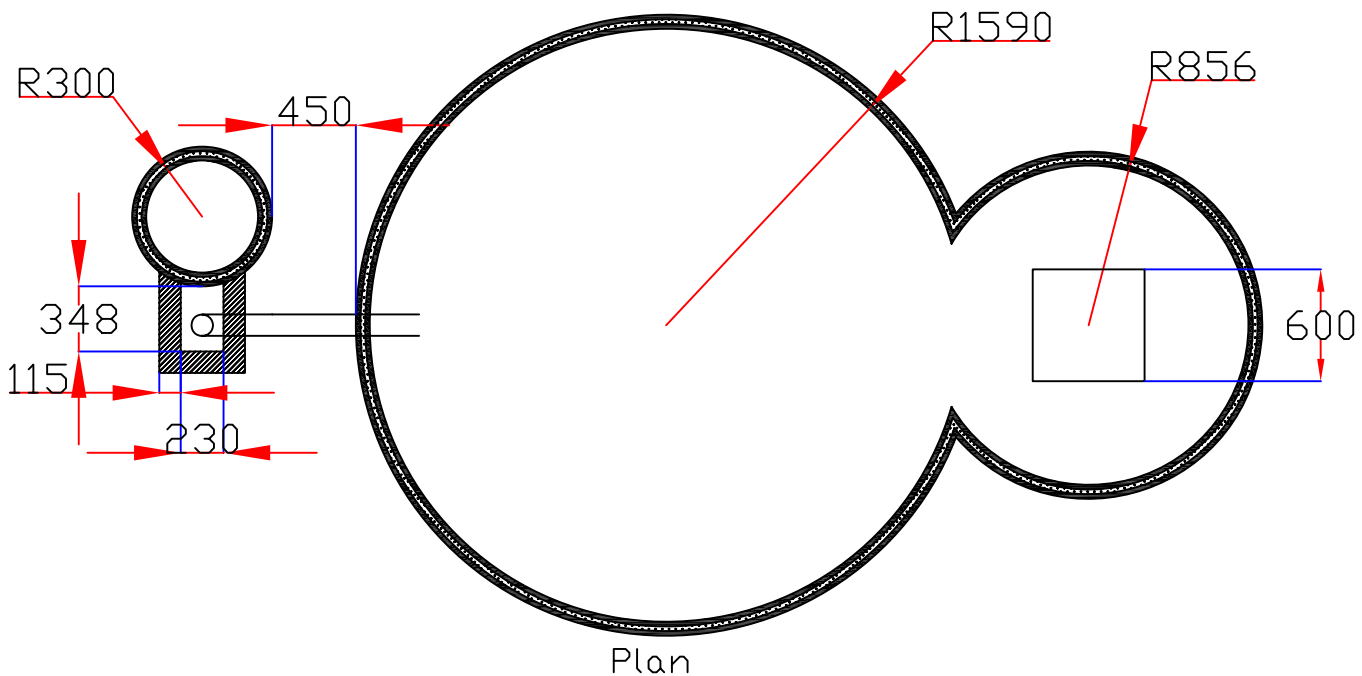
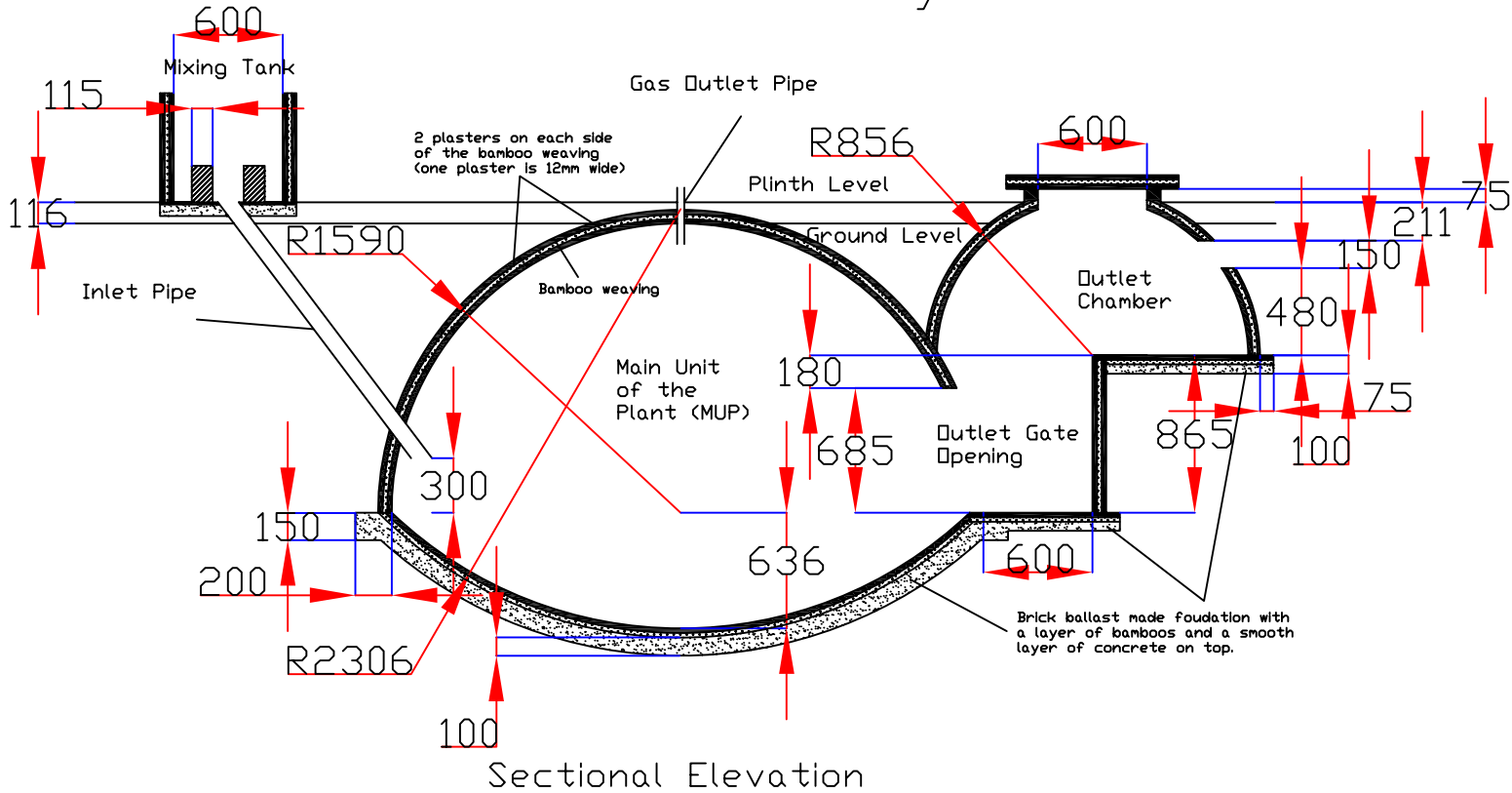
Sectional Elevation



Plan

All the dimensions are in mm.  
All the walls are 75mm wide except those which are specified to be 115mm.

# Dimensional drawing of a 3 cubic meter Grameen Bandhu Biogas Plant. (HRT = 55 days)



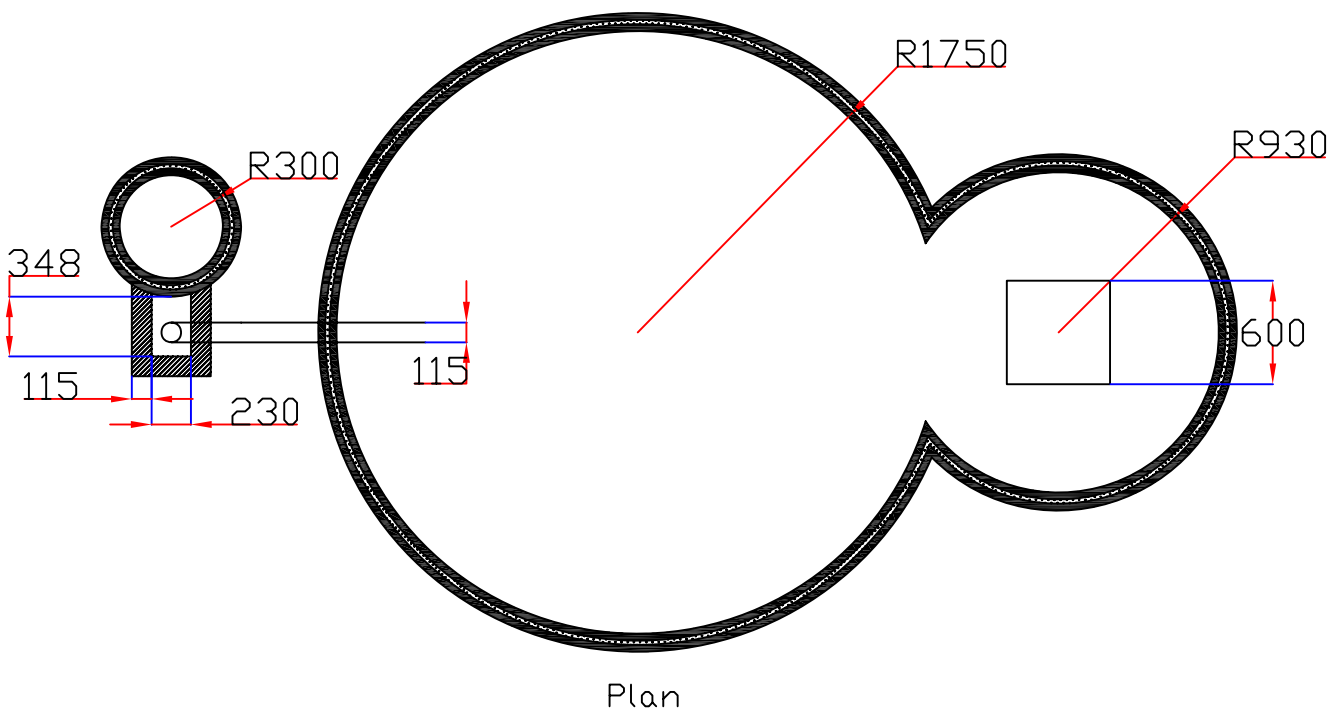
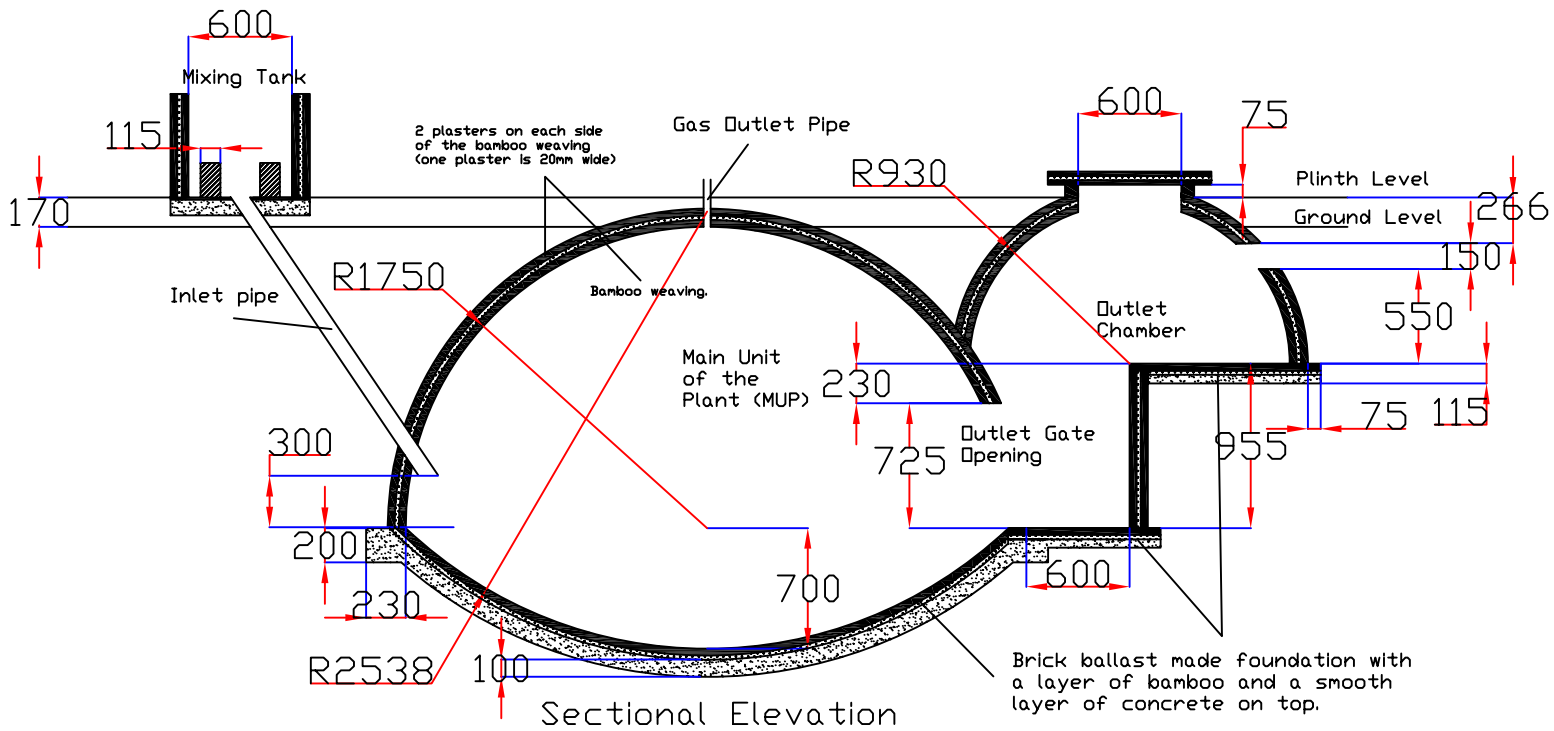
All the dimensions are in mm.  
All the walls are 75mm wide except those which are specified to be 115mm.

Designed and developed by:  
 Engr Raymond Myles, Secretary General-  
 cum-Chief Executive, INSEDA, New Delhi  
 Drawing by : Céline Stein and Victor Oudet  
 July 1, 2009

In case of a discrepancy, contact INSEDA, New Delhi



# Dimensional drawing of a 4 cubic meter Grameen Bandhu Biogas Plant. (HRT = 55 days)

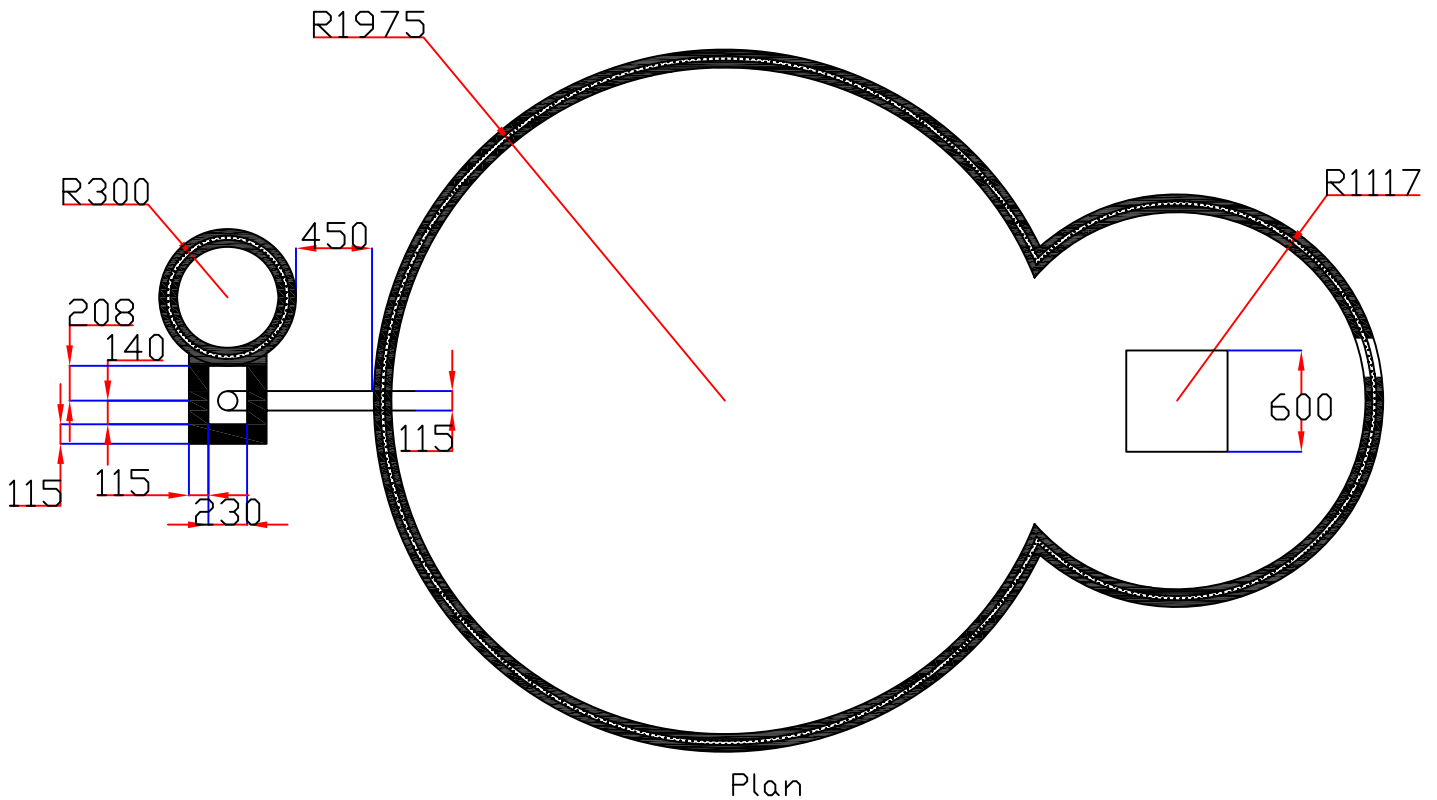
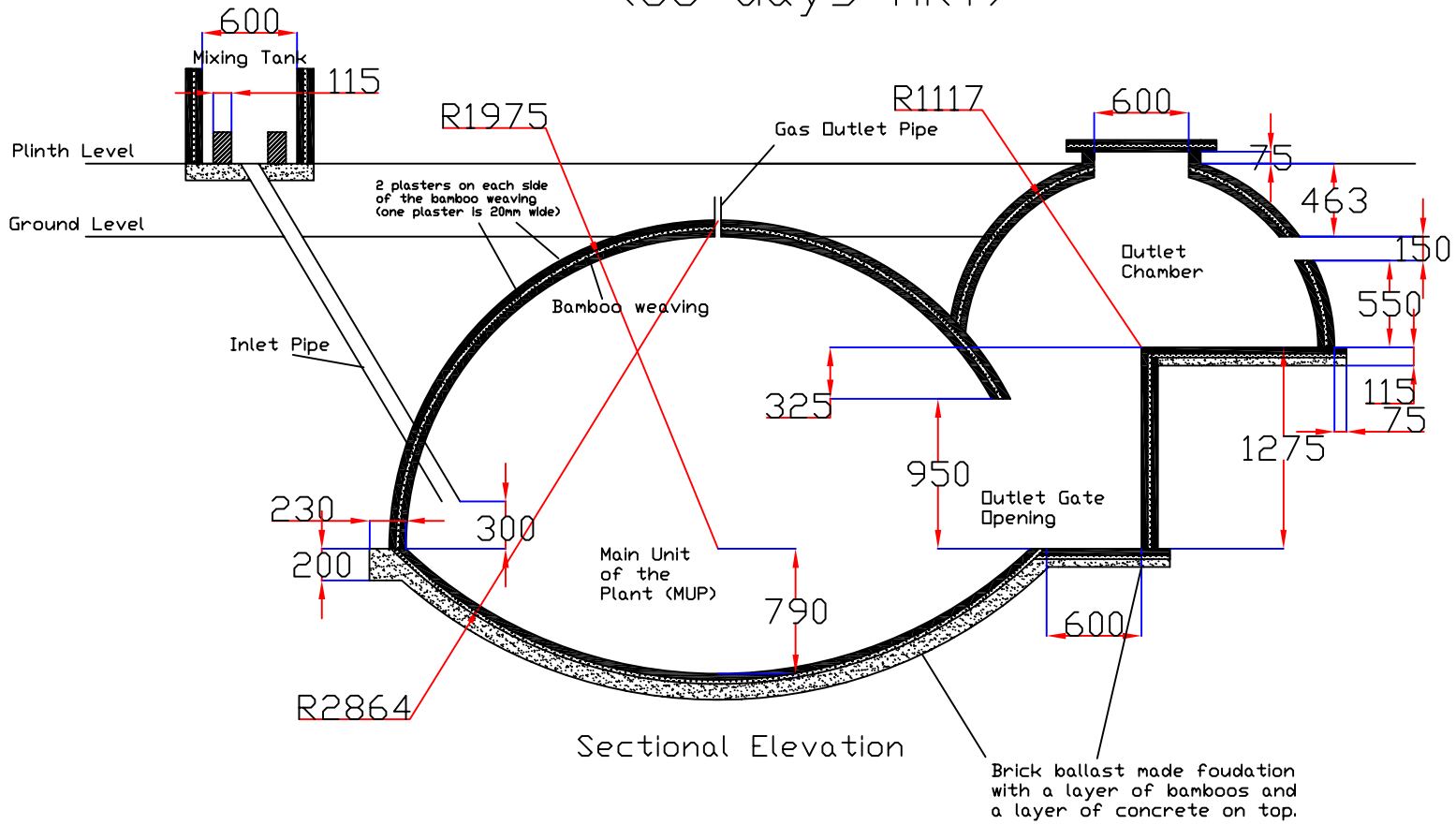


All the dimensions are in mm.  
All the walls are 105mm wide except those which are specified to be 115mm.

In case of a discrepancy, contact INSEDA, New Delhi

Designed and developed by:  
 Engr Raymond Myles, Secretary General-  
 cum-Chief Executive, INSEDA, New Delhi  
 Drawing by : Céline Stein and Victor Oudet  
 July 1, 2009

# Dimensional drawing of a 6 cubic meter Grameen Bandhu Biogas Plant. (55 days HRT)



All the dimensions are in mm.  
All the walls are 105mm wide except those which are specified to be 115mm.

**ESTIMATED COST OF BUILDING GRAMEEN BANDHU BIOGAS PLANTS-GBPS (55 Days HRT)**

(Estimated cost of GBPs is as per the cost of building materials, labour, masons and transport of materials etc., prevailing on December 01,13 at Bharatpur district, Rajasthan State)

SL. No.	Plant Size (Capacity)	Average Rate Per Unit		1 CuM		2 CuM		3 CuM		4 CuM		6 CuM	
		(Rate)	(Unit)	(Qty)	(Cost)	(Qty)	(Cost)	(Qty)	(Cost)	(Qty)	(Cost)	(Qty)	(Cost)
		Rs.	Rs.	(e)	(f)	(g)	(h)	(i)	(j)	(k)	(l)	(m)	(n)
(a)	Material /Labour/Transport etc.	Rs.	Rs.										
1	Bamboo 1-2" Dia & 12-Foot Length	65	Per Bamboo Piece	75	4,875.00	120	7,800.00	150	9,750.00	175	11,375.00	230	14,950.00
2	Cement 50 Kg Bag	300	Per Bag of 50 Kg Weight	10	3,000.00	14	4,200.00	18	5,400.00	23	6,900.00	28	8,400.00
3	Stone Pebbles/Chips (1/4 to 1/2" Dia.)	45	Per Cubic Feet	23	1,035.00	34	1,530.00	43	1,935.00	48	2,160.00	64	2,880.00
4	Coarse Sand	45	Per Cubic Feet	35	1,575.00	45	2,025.00	55	2,475.00	70	3,150.00	85	3,825.00
5	Fine Sand	45	Per Cubic Feet	35	1,575.00	45	2,025.00	55	2,475.00	70	3,150.00	85	3,825.00
6	AC/HDP Pipe (4 " dia x 2 M Length)	200	Per Meter Length	2	400.00	2	400.00	2	400.00	2	400.00	2	400.00
7	GI Pipe (7" length & 1/2" or 3/4" dia)-2 Sockets 1/2" or 3/4" dia welded	150	Per set (1/2" dia for 1 to 3 & 3/4" dia for 4 & 6 CuM)	1	150.00	1	150.00	1	150.00	1.25	187.50	1.25	187.50
8	D.P.C. Powder	200	Per Kg	2	400.00	4	800.00	5	1,000.00	7	1,400.00	9	1,800.00
9	Binding Wire	100	Per Kg	0.75	75.00	1	100.00	1.25	125.00	1.5	150.00	1.75	175.00
10	Reinforcement (Mild Steel Rods)	200	Per Kg	0	-	0	-	0	-	0	-	40	8,000.00
11	Paint (Black Enamel/Rubber)	150	Per Liter	1.5	225.00	2	300.00	2.5	375.00	3	450.00	4	600.00
12	Labour for Bamboo weaving-(5 Nos)	175	Per Woman Day-(5 Nos)	14	2,450.00	24	4,200.00	29	5,075.00	34	5,950.00	39	6,825.00
13	Labour (Pit digging)-(2 Nos)	300	Per Labour Day-(2 Nos)	4	1,200.00	5	1,500.00	6	1,800.00	7	2,100.00	10	3,000.00
14	Labour (Plant Construction)-(2 Nos)	300	Per Labour Day-(2 Nos)	9	2,700.00	12	3,600.00	14	4,200.00	18	5,400.00	23	6,900.00
15	Master Mason-(2 Nos)	400	Per Labour Day-(2 Nos)	9	3,600.00	12	4,800.00	14	5,600.00	18	7,200.00	23	9,200.00
16	Feeder/Slurry Mixing Fan	2000	Fabricated as per order	1	2,000.00	1	2,000.00	1	2,000.00	1	2,000.00	1	2,000.00
17	Miscellaneous Expenditure		(Cost of minor items not covered in other heads)		500.00		600.00		800.00		1,000.00		1,500.00
18	Transportation of Material to Site	1600	Per Trolley Trip	2	3,200.00	2	3,200.00	2	3,200.00	3	4,800.00	3	4,800.00
<b>I</b>	<b>Total (Average) direct cost of Grammeen Bandhu Model BGP</b>				<b>25,760.00</b>		<b>36,030.00</b>		<b>46,760.00</b>		<b>57,772.50</b>		<b>79,267.50</b>
17	Supervision & Overhead Cost [15% of total direct cost {Row (27)}]				3,864.00		5,404.50		7,014.00		8,665.88		11,890.13
<b>II</b>	<b>Total Construction Cost of BGPs</b>				<b>29,624.00</b>		<b>41,434.50</b>		<b>53,774.00</b>		<b>66,438.38</b>		<b>91,157.63</b>
18	Cost of Pipes (30 mt), Accessories (Gate Valve & Water Remover) & Appliances (One Double Burner Stove) and Welding & Fitting Cost				1,500.00		1,500.00		1,500.00		1,500.00		1,500.00
<b>III</b>	<b>Total Cost of Biogas Plant with Accessories and Appliances</b>				<b>31,124.00</b>		<b>42,934.50</b>		<b>55,274.00</b>		<b>67,938.38</b>		<b>92,657.63</b>
<b>IV</b>	<b>Total Cost (Rounded-off to the nearest hundred)</b>				<b>31,000.00</b>		<b>43,000.00</b>		<b>55,300.00</b>		<b>68,000.00</b>		<b>92,700.00</b>
<b>V</b>	<b>AV Estimated Cost of GBP/CuM Biogas Generation Capacity/Day</b>				<b>31,000.00</b>		<b>21,500.00</b>		<b>18,433.33</b>		<b>17,000.00</b>		<b>15,450.00</b>
<b>VI</b>	<b>Total Cost of BGP in Euro (1 Euro = 84 INR) as on Deember 01, 2013</b>				<b>484.38</b>		<b>671.88</b>		<b>864.06</b>		<b>1,062.50</b>		<b>1,448.44</b>

**PHOTOS**  
OF  
**STEP-BY-STEP CONSTRUCTION OF**  
**GRAMEEN BANDHU BIOGAS PLANT**



**BY**  
**RAYMOND MYLES**  
**Secretary General-cum-Chief Executive, INSEDA,**



**PHOTOS OF STEP-BY-STEP WEAVING AND CONSTRUCTION OF GRAMEEN BANDHU BIOGAS PLANT**

**PICTORIAL DEPICTION OF IMPORTANT STAGES OF BUILDING OF GRAMEEN BANDHU BIOGAS PLANT (GBP)**

**I. Fabrication and pre-fabrication of bamboo structures {(weaving using 0.5 in (12.5 mm or 1.25 cm)} bamboo strips for Grameen Bandhu model biogas plant (photograph nos. 1 to 16)}**



**1 (a)**



**1 (b)**



**1 (c)**

**PHOTOS-1 (a), (b) & (c):**

Seasoned Bamboo Poles (2 inch outer diameter and 12 feet length and ¼ thickness), selected after thorough inspection for their suitability for weaving structures for Grameen Bandhu plant (GBP)- (1 (a) selection of appropriate quality and size seasoned bamboo; 1 (b) Purchased bamboo (brought to the site where it will be woven in to different structures for making different components and sub-components of the GBP; and 1 (c) Correct storage of bamboo under the temporary shed till used for weaving



**2 (a)**



**2 (b)**



**2 (c)**

**PHOTO-2 (a), (b) & (c):**

Bamboo (after lengthwise, splitting in to 4 strips of 1 in (2.5 cm each), are immersed in water channel or tank and kept there for 12 to 24 hours (at least overnight). Later on these strips are further made in to 0.5 in (1.25 cm) strip. Only 0.5 in (1.25 cm) strip are used for weaving the different sizes of bamboo structure for GBP  
(*Note: Bamboo strips are to be soaked in the water with organic fungicides (e.g., Neem Oil etc) in the ratio of 1 kg to 100 l. water, for 12 hours (overnight)*)

**PHOTOS OF STEP-BY-STEP WEAVING AND CONSTRUCTION OF GRAMEEN BANDHU BIOGAS PLANT**



**3 (a)**

**3 (b)**

**PHOTO- 3: (a) & (b):**

Taking out & making appropriate size bamboo strips as per the requirement with simple hand tools

*[(Note: The bamboo strips are to be soaked in the water with organic fungicides (like, Neem Oil etc) in the ratio of 200 gram to 100 liter water, for overnight (or at least 12 hours), before using them for weaving bamboo shells for GBP]*



**4 (a)**

**4 (b)**

**4 (c)**

**PHOTO-4: (a), (b) & (c)**

Appropriate size inverted dome shaped excavations made in the ground for weaving bamboo shells for casting GBP. Photo-4 (a) Mould for making hemispherical shaped Top Segment of Plant (TSP), Photo-4 (b), Mould for making dish shaped Bottom Segment Plant (BSP); and . Photo-4 (c) Mould for hemispherical shaped Outlet Displacement Chamber (ODC)



**5 (a)**

**5 (b)**

**5 (c)**

**PHOTO-5: (a), (b) & (c)**

Initial weaving in progress, which is normally done on the ground surface for the 3 respective moulds, namely, Top Segment of Plant (TSP), Bottom Segment of Plant (BSP) and Outlet Displacement Chamber (ODC)

**GRAMEEN BANDHU PHOTOS: By: Raymond Myles, Secretary General-cum-Chief Executive, INSEDA, New Delhi**



**PHOTOS OF STEP-BY-STEP WEAVING AND CONSTRUCTION OF GRAMEEN BANDHU BIOGAS PLANT**



6 (a)

6 (b)

6 (c)

**PHOTO-6: (a), (b) & (c)**

Initially woven bamboo strips (on the plain ground surface) placed inside the appropriate size underground for weaving-viz., 6 (a) Top Segment of Plant (TSP), 6 (b) Bottom Segment of Plant (BSP); and 6 (c) Outlet Displacement Chamber (ODC)



7 (a)

7 (b)

7 (c)

**PHOTO-7: (a), (b) & (c)**

Advanced stage of weaving of -7 (a) Top Segment of Plant (TSP), 7 (b) Bottom Segment of Plant (BSP); and 7 (c) Outlet Displacement Chamber (ODC)



8 (a)

8 (b)

**PHOTO-8: (a) & (b)**

Completed woven bamboo structure for the Top Segment of Plant (TSP)- commonly referred as the Top Segment of the Main Unit of the Plant (MUP), showing two views- 8 (a) TSP in half standing position and 8 (b) TSP kept on the plain ground surface, as it will go inside the plant pit on top of the bottom segment of the plant (BSP) and tied together with binding wire, to form the complete MUP

**GRAMEEN BANDHU PHOTOS: By: Raymond Myles, Secretary General-cum-Chief Executive, INSEDA, New Delhi**



**PHOTOS OF STEP-BY-STEP WEAVING AND CONSTRUCTION OF GRAMEEN BANDHU BIOGAS PLANT**



**9 (a)**

**9 (b)**

**PHOTO-9: (a) & (b)**

Completed woven bamboo structure for the Bottom Segment of Plant (BSP)- commonly referred as the Bottom Segment of the Main Unit of the Plant (MUP), showing two views- 9 (a) BSP in tilted position supported by trained rural women weavers and 9 (b) BSP kept in inverted position on the plain ground surface, as it will go inside the plant pit on the surface of the foundation. Later on the top segment of the plant (TSP) would be placed on it and both will be tied together with binding wire, to form the complete MUP.



**10 (a)**

**10 (b)**

**PHOTO-10: (a), (b) & (c)**

Completed woven bamboo structure for the Outlet Displacement Chamber (ODC)- Showing two views- Photo 10 (a) ODC (weaving is just completed with opening for manhole on its crown inside the UGM) ready to be taken out; Photo-10 (b) ODC kept on ground, with the two structures for TSP & BSP ready inside their respective underground moulds, can be seen at the back (UGMs); and Photo-10 (c) ODC kept on the ground surface in inverted position (with opening for manhole on its crown) as it will go on the ODC foundation.



**11 (a)**

**11 (b)**

**PHOTO-11: (a) & (b)**

Completed woven bamboo structures for- Photo-11 (a) Top Segment (TSP) and Bottom Segment (BSP) of the Main Unit of Plant (MSU), Photo-11 (b) TSP is placed on top of BSP as they would be placed inside the plant pit before joining them together tightly using binding wire, before plastering them using cement sand mortar.

**PHOTOS OF STEP-BY-STEP WEAVING AND CONSTRUCTION OF GRAMEEN BANDHU BIOGAS PLANT**



**12 (a)**



**12 (b)**

**PHOTO-12: (a) & (b)** Completed woven bamboo structures for- Photo-12 (a) Top Segment of Plant (TSP), Bottom Segment of Plant (BSP) and Outlet Displacement Chamber (ODC); Photo-12 (b) TSP is placed on top of BSP and ODC touching BSP as they would be placed for constructing Bamboo Reinforced Cement Mortar (BRCM) with cement & sand mortar



**13 (a)**



**13 (b)**



**13 (c)**

**PHOTO-13: (a), (b) & (c)** Different stages of weaving of bamboo structures for making BRCM Slurry Mixing Tank (SMT)- Photo 13 (a) Initial stage of weaving of bamboo structure for the SMT on the levelled ground without using any underground mould; Photo 13 (b) Advanced stage of weaving for SMT; and Photo 13 (c) Completed woven bamboo structure for Slurry Mixing Tank (SMT).



**14 (a)**



**14 (b)**



**14 (c)**



**14 (d)**



**14 (e)**

**PHOTO-14: (a), (b) & (c)** Other key materials used for weaving and construction of Grameen Bandhu Plant (GBP)- Photo-14 (a) Binding wire used for tying bamboo strips and joining completed woven bamboo structures for the different components & sub-components before making BRCM plant; Photo-14 (b) Brick Ballasts used for making foundations of MUP, ODC and SMT of the GBP; and Photo- 14 (c) Inlet Pipe (IP) made from CC; Photo-14 (d) Cement Sand Mortar; and Photo-14 (e) DPC powder (1/2 Kg 50 Kg cement) for mixing with Cement Sand Mortar for BRCM construction & plastering

**GRAMEEN BANDHU PHOTOS: By: Raymond Myles, Secretary General-cum-Chief Executive, INSEDA, New Delhi**



**PHOTOS OF STEP-BY-STEP WEAVING AND CONSTRUCTION OF GRAMEEN BANDHU BIOGAS PLANT**



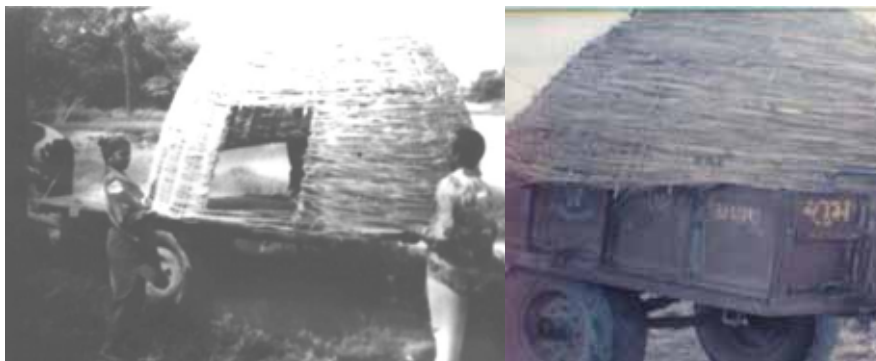
**15 (a)**

**15 (b)**

**15 (c)**

**PHOTO-15: (a), (b) & (c)**

Transporting of the woven bamboo structures for the three major components and sub-components (namely BSP, TSP and ODC) by foot within the same village or adjacent village for the construction of Grameen Bandhu Plant (GBP)- Photo-15 (a) bamboo structure for the bottom segment of plant (BSP) by villagers & volunteers, from the weaving site to plant site; Photo-15 (b) Bamboo structures for the top segment of plant (TSP) is being lifted to be carried from the weaving site to the plant site; and Photo-15 (c) Bamboo structure for TSP is being carried by villagers & volunteers to the plant site within the same village for building the GBP



**16 (a)**

**16 (b)**

**PHOTO-16: (a) & (b)**

Transporting of the woven bamboo structures for the three major components and sub-components (namely BSP, TSP and ODC) by bullock cart in the nearby villages for construction of Grameen Bandhu plant (GBP)- Photo- 16 (a) Carrying the bamboo structure from the weaving site on the bullock cart; Photo-16 (b) Bamboo structures are ready to be unloading from the bullock cart at building site of Grameen Bandhu plant (GBP).



**17 (a)**

**17 (b)**

**PHOTO-17: (a) & (b)**

Transporting of the woven bamboo structures for the three major components and sub-components (namely BSP, TSP and ODC) by tractor and trolley in distance villages for the construction of Grameen Bandhu plant (GBP)- Photo- 17 (a) Carrying the bamboo structure from the weaving site on the tractor; and Photo- 17 (b) Unloading the woven structure from the tractor at the site for building the Grameen Bandhu Plant (GBP)

## PHOTOS OF STEP-BY-STEP WEAVING AND CONSTRUCTION OF GRAMEEN BANDHU BIOGAS PLANT

### II. BUILDING OF GRAMEEN BANDHU PLANT (GBP) AT FARMER'S SITE

- a). Digging pit, laying of foundation and the fixing of bamboo Shell structures for the MUP- (Photograph No. 18 to 21)



**18 (a)**



**18 (b)**



**18 (c)**

**PHOTO-18: (a), (b) & (c)**

Layout and initial digging of the pit for GBP- Photo- 18 (a) Marking of outline as per the dimensional drawing for digging pit for the plant Photo- 18 (b) Initial digging of the pit as per the marling on the ground surface; and Photo- 18 (c) Using bamboo pole for dividing the diameter of the pit in to two equal parts, as well as using it midpoint, and taking string of appropriate length for the measurement of the radius, dig the bottom curvature of the pit.



**19 (a)**



**19 (b)**



**19 (c)**

**PHOTO-19: (a), (b) & (c)**

Final important stages of digging pit for the MUP of the GBP- Photo- 19 (a) Deepening the pit as per the dimensional drawing till the collar for costing the ring beam is reached, and also making the rectangular pit for the outlet tank (OT); Photo- 19 (b) Make the circular collar in the pit as per the dimensional drawing, and then further deepen the pit from this stage onward as per the radius of the pit to perfectly accommodate (shallow disc shaped) woven bamboo structure for the bottom segment of the plant (BSP); and Photo- 19 (c) Dig the shallow circular pit (on top surface of the OT, attached to the MUP pit), for making foundation with the brick ballast and cement.



**PHOTOS OF STEP-BY-STEP WEAVING AND CONSTRUCTION OF GRAMEEN BANDHU BIOGAS PLANT**



**20 (a)**



**20 (b)**



**20 (c)**

**PHOTO-20: (a), (b) & (c)**

Laying of foundation of the MUP- Photo- 20 (a) First the pit surface is properly rammed, then brick ballast of average size ranging between 1-2 inch (25 -50 mm or 2.5 to 5 cm) are spread evenly on the bottom; Photo- 20 (b) Using wooden ram, the ramming of BBs is done (while sprinkling water) to make it firm and even; and Photo- 20 (c) Finally cement & sand mortar is spread and further ramming is done (with sprinkling water) to make the foundation firm, compact & even, as per the thickness given in the dimensional drawing, to complete the foundation of MUP including the collar for the ring beam. **(Note:** As brick ballasts are used, the ratio of cement concrete used for casting foundation is 1:4:8 (1 cement: 4 coarse sand: 8 brick ballasts) by volume. Main construction will start only from the next day onwards)



**21 (a)**



**21 (b)**



**21 (c)**

**PHOTO-21: (a), (b) & (c)**

Placement of bamboo shell structures for the BSP & TSP, inside the pit on the surface of the foundation of the MUP- Photo- 21 (a) Placement of dish shaped bamboo shell structure for the BSP of the MUP; Photo- 21 (b) Placement of hemi-spherical shaped bamboo shell structure for the TSP on top of the concave shaped BSP, which also shows the opening for making the outlet gate; and Photo- 21 (c) View of woven bamboo structure for MUP, seen from the opposite side showing the circular opening for inserting for 4 inch (100 mm or 10 cm) diameter inlet pipe (IP) during construction.



**22 (a)**



**22 (b)**



**22 (c)**

**PHOTO-22: (a), (b) & (c)**

Bamboo shell for the MUP's top segment placed perfectly over the shallow dish shaped bottom segment (BSP) of the of MUP, which are tied & fixed together firmly with binding wires, to make the unit in to ellipsoidal shaped structure of MUP- Photo-22 (a) Woven bamboo structure for MUP (just before insertion of gas outlet pipe, also showing the outlet gate opening; 22 (b) A one inch (25 mm) dia & 7 inch (175 mm) long gas outlet pipe (GOP) is being inserted at the crown of TSP and properly tied using binding wire; and Photo-22 (c) Woven bamboo structure during the insertion of 4 inch (100 mm or 10 cm) diameter inlet pipe (IP).

**PHOTOS OF STEP-BY-STEP WEAVING AND CONSTRUCTION OF GRAMEEN BANDHU BIOGAS PLANT**

**b). Main construction work on the Grameen Bandhu plant-GBP (Photograph No 23- 32)**



**23 (a)**



**23 (b)**

**PHOTO-23: (a) & (b)**

Application of pure cement slurry on the outer surface of the top segment of the MUP, with brush in 1:5 ratio (1 kg cement: 5 liter water), before starting the first coat of rough plaster- Photo-23 (a) Application of cement slurry is done using biomass brush on the outer surface of the MUP; Photo-23 (b) Advanced stage of rough plaster on the Second coat of smooth plaster being carried on the first coat of rough plaster.



**24 (a)**



**24 (b)**



**24 (c)**

**PHOTO-24: (a), (b) & (c)**

First coat of rough plaster on the outer surface of the woven bamboo structure for the top segment (TS) of the main unit of the plant (MUP), using cement mortar in 1:3 ratio (1 cement: 3 coarse sand) by volume- Photo-24 (a) Advanced stage of rough plaster 24 (b) First rough plaster on the outer surface of MUP is in advanced stage of progress; and 24 (c) Outer surface of MUP is completed with first coat of rough plaster.



**25 (a)**



**25 (b)**



**25 (c)**



**25 (d)**

**PHOTO-25: (a), (b), (c) & (d)**

Different stages of second coat of smooth plaster on both, the Ring Beam and the outer surface of the top segment (TS) of the main unit of the plant (MUP). The ratio of cement mortar used is 1:3 (1 Cement: 1 Coarse Sand+2 Fine Sand) by volume.



**PHOTOS OF STEP-BY-STEP WEAVING AND CONSTRUCTION OF GRAMEEN BANDHU BIOGAS PLANT**



26 (a)



26 (b)



26 (c)

**PHOTO-26: (a), (b) & (c)**

Fixing of outlet tank (OT) attached to the outlet gate (OG) and plastering it- 26 (a) Fixing of three flat woven bamboo mats to make it in to a rectangular shape bamboo structure for OT- 26 (b) Fixing of rectangular shape bamboo structure to the OG, which also touches the upper portion of the outer surface of the MUP; and 26 (c) Plastering of bamboo structure from inside to make it in to a rectangular outlet tank (OT), using cement mortar in 1:3 ratio (1 cement: 3 coarse sand) by volume.



27 (a)



27 (b)



27 (c)

**PHOTO-27: (a), (b) & (c)**

Different stages of plasters of the MUP from insider- Starting with the first coat rough plaster, and then followed by second coat smooth plaster on the inner surface of the top segment (TSP) and bottom segment of the MUP. The ratio of cement mortar used is 1:3 (1 Cement: 1 Coarse Sand+2 Fine Sand) by volume.



28 (a)



28 (b)



28 (c)

**PHOTO-28: (a), (b) & (c)**

Building of Outlet Displacement Chamber (ODC) of the GBP- Photo- 28 (a) Laying of foundation of the ODC using 2 inch (50 mm or 5 cm) size brick ballasts (or 1-2 inch (25 mm or 5 cm). Wherever stone chips or pebbles are easily available at lower cost than it can be used (in place of brick ballast) for laying the foundation; and Photo- 28 (b) Plastering the laid foundation with appropriate ratio of cement and sand mixture; Photo- 28(c) Preparing the already placed woven bamboo structure for the ODC for the plastering. The ratio of cement mortar used is 1:3 (1 Cement: 1 Coarse Sand+2 Fine Sand) by volume.



**PHOTOS OF STEP-BY-STEP WEAVING AND CONSTRUCTION OF GRAMEEN BANDHU BIOGAS PLANT**



29 (a)



29 (b)



29 (c)

**PHOTO-29: (a), (b) & (c)**

Demonstration to visitors about the constructional aspects of GBP- Photo-29 (a) Final stages of construction of Outlet displacement chamber (ODC); Photo-29 (b) Explaining the functioning of Outlet displacement chamber (ODC); and Photo-29 (c) Explaining about the last stages of construction of GBP to visitors.



30 (a)



30 (b)

**PHOTO-30: (a) & (b)**

Two main units of the GBP (after curing for approximately 10 days is completed) seen before covering the top with earth- 30 (a) Main unit of the plant (MUP); and 30 (b) Outlet displacement chamber (ODC) of the plant.



31 (a)



31 (b)



31 (c)

**PHOTO-31: (a), (b) & (c)**

Completed GBP (after curing for an average of 7-10 days is completed), seen before covering on the surface of the plant dome with earth- 31 (a) Slurry mixing tank (SMT) is seen on the top; 31 (b) Outlet displacement chamber (ODC) of the GBP is seen, with its discharge opening (DO) located just above the level of ground surface; and 31 (c) View of the entire plant, being covered by earth on its top, except the SMT and top portion of the ODC.

**PHOTOS OF STEP-BY-STEP WEAVING AND CONSTRUCTION OF GRAMEEN BANDHU BIOGAS PLANT**



**32 (a)**



**32 (b)**

**PHOTO: 32 (a) & (b)**

Completed GBP seen before covering on the surface of the plant dome with earth- Photo-32 (a) Completed after curing for an average of 7-10 days; and Photo-32 (a) After the pipe line has been connected from the plant to the place of utilization of the biogas.

**III. Utilization of two products of biogas plants (namely biogas and digested slurry (photograph nos. 31 to 37))**



**33 (a)**



**33 (b)**



**33 (c)**

**PHOTO: 33 (a) & (b)**

Use of biogas from Grameen Bandhu plant for cooking and lighting Photo-33 (a) A rural woman using biogas for cooking; and Photo-33 (b) Biogas being used for lighting using biogas mental lamp; Photo-33 (c) Another rural woman using biogas for cooking.



**34 (a)**



**34 (b)**

**PHOTO: 34 (a) & (b)**

Use of biogas from GBP for running dual fuel engine (diesel + biogas) for operating irrigation pumping set- Photo-34 (a) Trial run after converting (using local level improvisation) the existing old diesel engine in to a dual engine for operating a pump for irrigation, by using combination of biogas (70%) and diesel (30%); and Photo-34 (b) Biogas being used in combination of diesel in dual fuel engine for irrigating of farmers field.

**GRAMEEN BANDHU PHOTOS: By: Raymond Myles, Secretary General-cum-Chief Executive, INSEDA, New Delhi**



**PHOTOS OF STEP-BY-STEP WEAVING AND CONSTRUCTION OF GRAMEEN BANDHU BIOGAS PLANT**



**35 (a)**



**35 (b)**

**PHOTO: 35 (a) & (b)**

Use of biogas for running dual fuel engine (diesel + biogas), for simultaneously operating both generating set as well as mechanical power (using shaft and pulley) by a farmer in Bharatpur district (Rajasthan state) - Photo-35 (a) Dual fuel engine (diesel + biogas) is operating a generating set using pulley and shaft for lighting (during the frequent power cut from the main grid in farmers house; and Photo-35 (b) Same farmer simultaneously using biogas from the same GBP and same dual fuel engine for operating chaff cutter and other farm equipments using pulley and shaft.



**36 (a)**



**36 (b)**



**36 (c)**

**PHOTO: 36 (a), (b) & (c)**

Recycling of bovine (cattle or/and buffalo) manure (collected in Indian villages either from buffalo or cattle or both) through Grameen Bandhu plant for clean & convenient energy (in the form of biogas) and in the process also getting enriched manure in the form of digested slurry- Photo-36 (a) Bovine manure collected in Indian villages from domestic farm animals kept next to their houses; Photo-36 (b) The Grameen Bandhu plant is also constructed closer to the bovine yard and the farmers; and Photo-36 (c) Biogas digested slurry going in the pit next to the plant for storage.



**37 (a)**



**37 (b)**



**37 (c)**

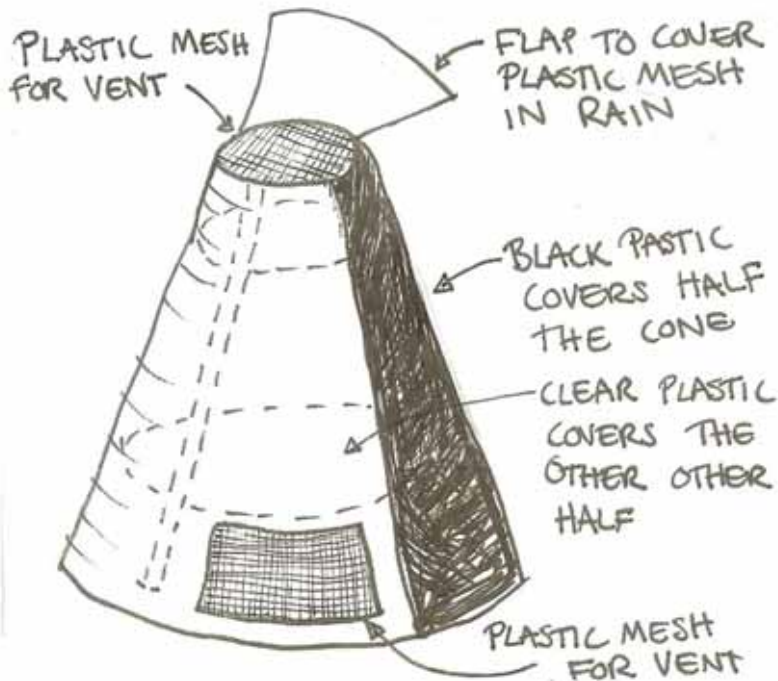
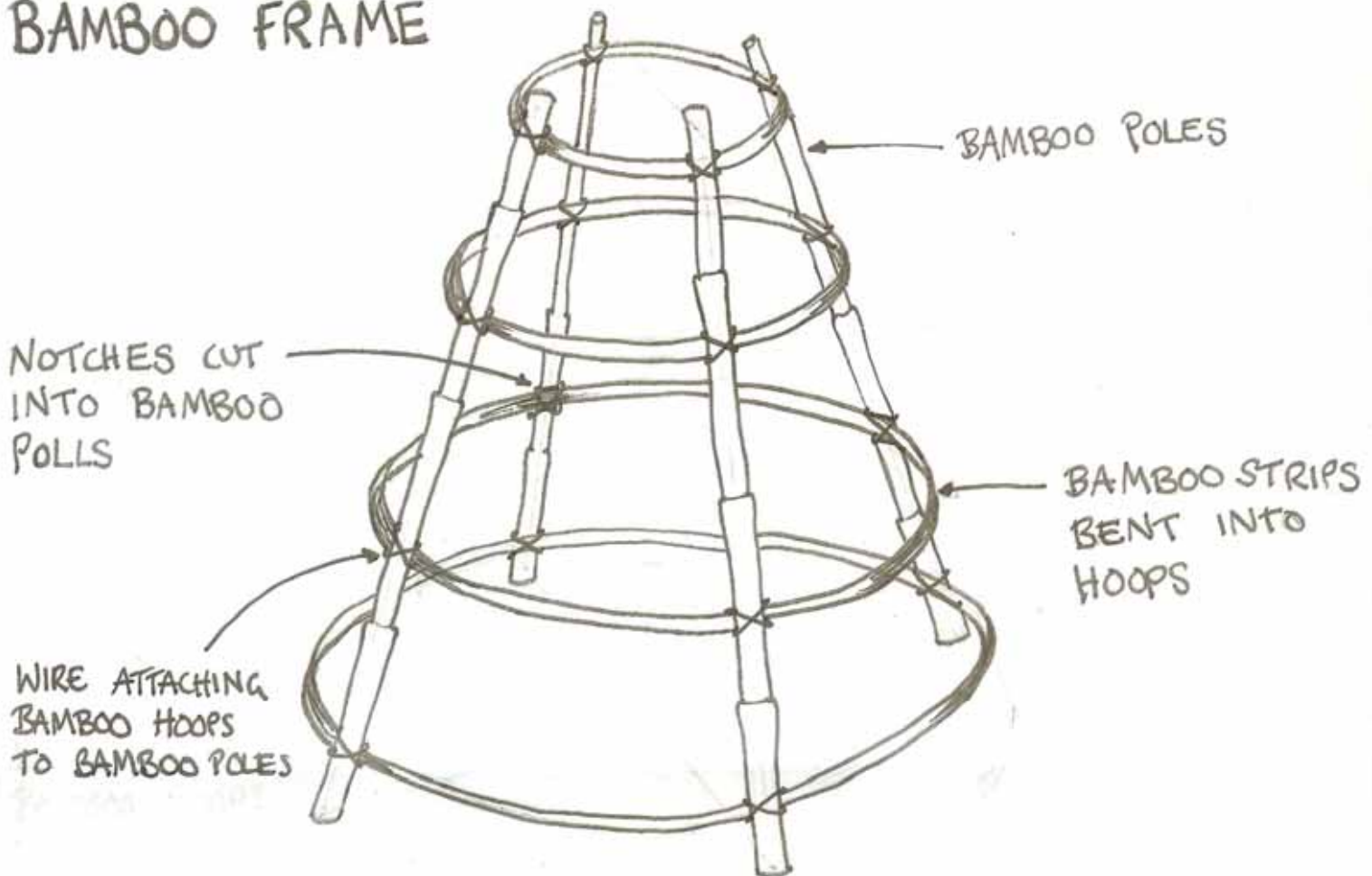
**PHOTO: 37(a), (b) & (c)**

Utilization of digested slurry (after drying or making compost) in agricultural- Photo-37 (a) Use of biogas digested slurry on WAFD's demonstration organic farm; Photo-37 (b) Biogas digested manure used in wheat crop; and .Photo-37 (c) Use of biogas digested slurry in mustard crop, and in between fodder crop is shown for domestic farm animals.

**GRAMEEN BANDHU PHOTOS: By: Raymond Myles, Secretary General-cum-Chief Executive, INSEDA, New Delhi**

# BAMBOO SOLAR DRYERS

## BAMBOO FRAME



## PLASTIC COVER

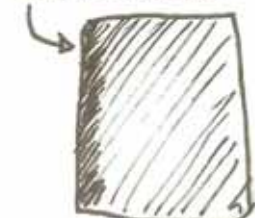


SHELVES ARE MADE FROM BAMBOO STRIP(S) TO STACK THE FRUIT ON TO DRY

BAMBOO FRAME



BLACK COVER



BUCKET OF WATER



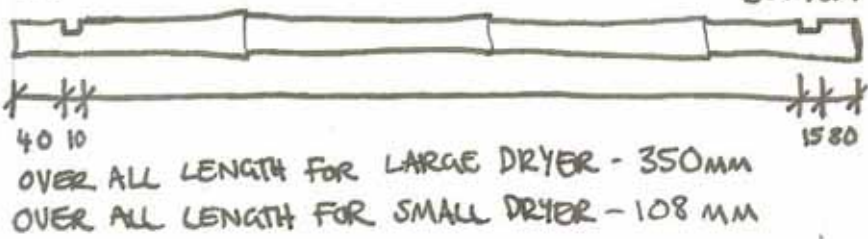
## SOLAR WATER HEATER

BUCKET PLACED UNDER BLACK COVER IN SOLAR DRYER TO HEAT FOR WASHING



# BAMBOO SOLAR DRYERS

MATERIAL - ALL MEASUREMENTS ARE IN MM.  
TOP BOTTOM



X 4 BAMBOO POLES

WITH NOTCHES CUT OUT AT THE TOP AND BOTTOM.

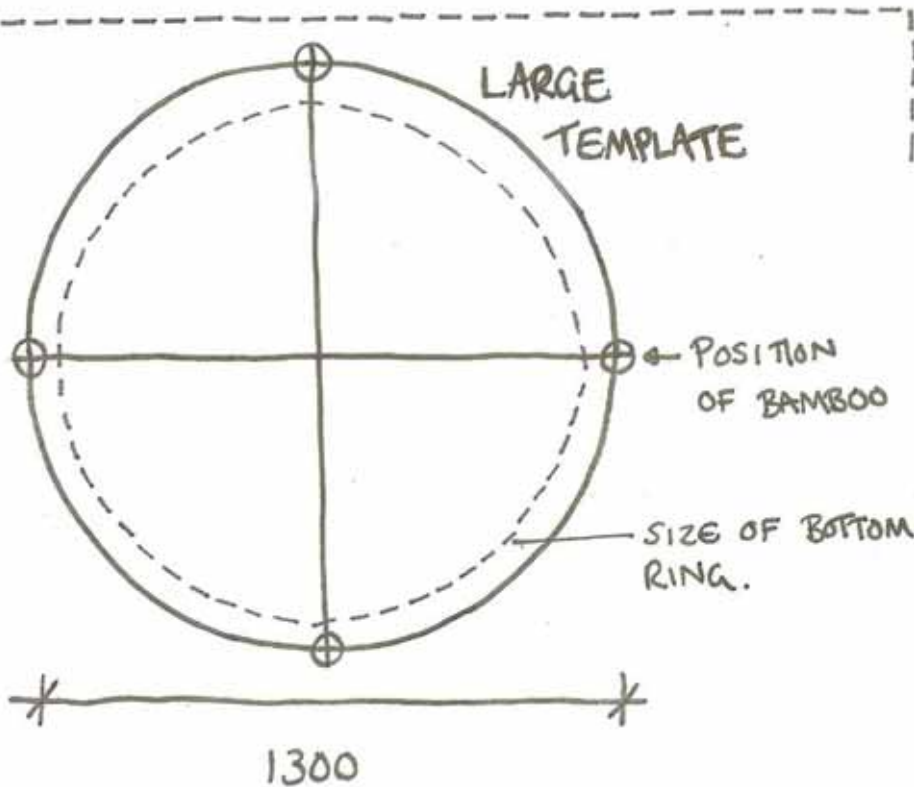


MAKE AS REQUIRED BAMBOO STRIPS

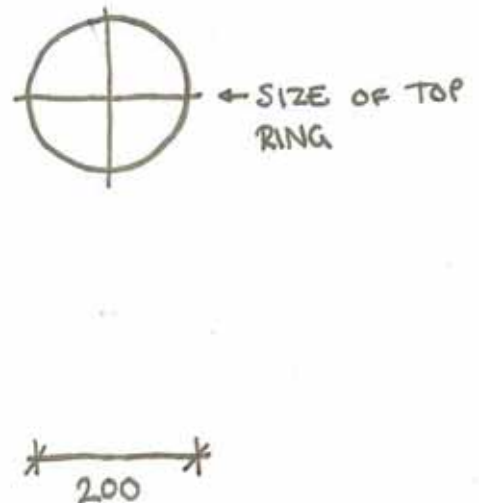
CHOPPER + MALLET ARE USED TO BREAK THE BAMBOO DOWN INTO STRIPS.



WIRE + PLYERS ARE USED TO ATTACH THE BAMBOO TOGETHER.



SMALL TEMPLATE



DRAW OUT TEMPLATES ON THE GROUND TO ACT AS A GUIDE FOR POSITIONING POLES + MAKING BAMBOO RINGS

MATERIAL FOR COVER

BLACK PLASTIC



CLEAR PLASTIC



PLASTIC MESH







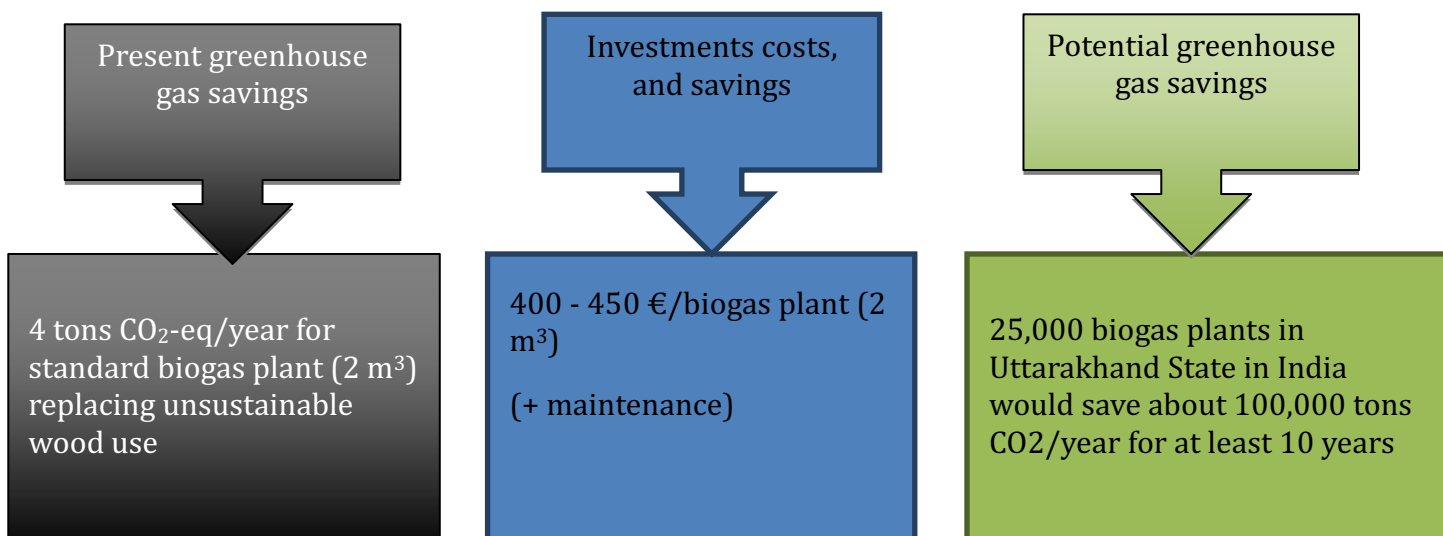
## APPROPRIATE RENEWABLE ENERGY ETC. USING BAMBOO AND WOOD WITHIN THE ECO VILLAGE DEVELOPMENT (EVD)

By Raymond Myles, Secretary General, INSEDA and Zareen Myles, Executive Director, WAFD

### Summary

The “Renewable energy based sustainable EVD” project is a joint effort of WAFD (Women’s Action For Development) and INSEDA (Integrated Sustainable Energy and Ecological Development Association) to demonstrate how several such actions at the grassroots level can effectively mitigate the negative effects of climate change. This project is based in six villages of Rani Chauri area of Tehri Garhwal district of Uttarakhand state. The project villages are situated at a height of 5,000-7,000 feet above sea level, in the Sub Himalayan mountainous region of India, and it demonstrates a prime example of promoting green community living using innovative low carbon strategies and commonly found resources in uncommon ways.

This case study briefly discusses the processes and strategies for promoting and implementing, by mainly utilizing eco-friendly bamboo building material, and renewable energy based sustainable eco-village development (EVD) actions. It demonstrates how a large number of such local people-centered, solutions can effectively contribute to low cost, affordable solutions for climate change mitigation. It also illustrates how this process assisted by the capacity building of ‘end users’, make these interventions sustainable and enduring even after the withdrawal of the external agencies (NGO partners) at the conclusion of the project period by the external agencies. Bottom-up approaches to climate mitigation and adaptation, like the organization of receptive communities into eco-villages, helps them evolve their own responses to climate change challenges.



## ***I. Introduction***

1. While policies and strategies to deal with climate change issues are being given some urgency in global, regional and national forums, the negative impacts of these changes are already being felt amongst the most vulnerable populations of the world. To address this issue effectively at the grass-roots level, the approaches followed by WAFD (Women's Action For Development)-and INSEDA (Integrated Sustainable Energy and Ecological Development Association) was to take villages as the smallest units for integrated development, by implementing renewable based, environmentally benign and eco-friendly low-cost affordable actions. The rationale of WAFD and INSEDA's for choosing village as the smallest unit for interventions (especially in India) is that they are usually at the fringes of policy-making and are also the first to be impacted by climate change effects.

Village communities are also ideal for illustrating the concept of contextually appropriate, small scale innovations for climate change mitigation and adaptation, which can be easily replicated in other villages with appropriate modifications. The key to success for these projects is the participation of families living in these villages. This also involves their active participation to ensure that they are trained, their capacity is built and skills up-graded so that they can be actively involved in the implementation of development activities meant for their benefit.

2. This project has been developed and built upon by the 8 years of experience that WAFD and INSEDA gained in implementing a joint program of eco-village development (EVD) in the state of Rajasthan in India. These EVD projects were undertaken in 12 selected villages of the Bharatpur district in Rajasthan. After learning extensively from these projects, both the NGOs also launched similar programs in the ecologically fragile, Himalayan sub-region of India in January 2011. Thus now we are having a total of about 10 years of experience in EVD programs. The first program on EVD, which lasted over a period of 8 years in 12 villages in Bharatpur was funded by the Finnish Ministry for International Cooperation (FMIC), Finland through the Students Union of the University of Jyväskylä, Finland

### **Socio-Economic impact:**

Biogas and other cooking solutions reduces need to collect firewood and gives a cleaner cooking environment as well as good fertilizer. Solar drying enables better treatment of harvests. Water collection increases resilience to drought

### **Environment impacts:**

Cooking solutions replace use of wood, which reduces overuse of forests and other trees, and thus contribute to reduce CO<sub>2</sub>-emissions. Use of biogas sludge for fertiliser enriches soil

### **How this case can contribute to climate mitigation**

This case is important to improve livelihood, but it also contributes to climate mitigation. It does so in its present form, but it could do it much more, if up-scaled to national or regional level, together with other, similar initiatives. In the below table focus is on biogas, but also solar cooking, solar drying and other solutions used in the EVD project contributes to reduced greenhouse gas emissions.

Present greenhouse gas savings	A 2 m <sup>3</sup> capacity house hold biogas plant (rated to generate 2 cu.m. biogas per day, when fed with 50 kg fresh cattle manure daily) saves 4 ton of CO <sup>2</sup> -equivalent/year from avoided use of unsustainable wood, avoided LPG, avoided use of cow dung cake for cooking, and avoided uncontrolled methane emissions
Potential greenhouse gas savings	If all people with animals enough and space for biogas in the Uttarakhand state would get a biogas plant, a total of 25,000 biogas plants would be built, then savings would be 100,000 ton of CO <sup>2</sup> -equivalents/year, given that alternative is unsustainable use of biomass
Investments costs	400 - 450 €/ biogas plant (2 m <sup>3</sup> capacity) (+ maintenance)
Savings	Typically one biogas plant saves 2 tons of wood or 400 kg LPG per year. For (If 25,000 household biogas plants of 2 cu.m. capacity are installed in Uttarakhand savings would be 50,000 tons wood or 10,000 tons LPG/year)
Resources needed for large-scale dissemination	At the present cost it would require about 800,000,000 INR (Approx. 11,000,000 €) for the cost of 25,000 units of Grameen Bandhu biogas plants plus additional cost towards capacity building, administration and post- installation-cum-follow-up services for at least 3 years.  External funding required is 30-50% of this, ca. 4-6 mill. €, which would save 1 mill. ton of CO <sub>2</sub> -eq over 10 years (given replacement of unsustainable biomass use), equal to 4-6 €/ton

## ***II. EVD project in villages surrounding Rani Chauri in Tehri Garhwal Dist. of Uttarakhand***

The EVD project in the Rani Chauri area of New Tehri district (after the old Tehri Garhwal district headquarters had been submerged after the construction of the Tehri Dam and all the offices shifted to the New Tehri district HQs), was prepared jointly by WAFD, INSEDA and ASDA (a Helsinki based NGO) as a two year pilot project. This was based on intensive participatory exercises with local people from the proposed target villages, and was sanctioned by the Finnish Ministry for International Cooperation (FMIC), Finland to be implemented w.e.f., January 2011. After the project was sanctioned by FMIC, WAFD & INSEDA conducted a

systematic baseline survey of the target villages using two designed formats, one for the village level survey and second for the household survey in the target villages. The baseline survey was used to create a digitized database. The detail surveys confirmed some of the important inputs given by the local people during the participatory planning of the pilot project of 2 years duration, followed by the planning, formulation and implementation of the main project of 3 years duration. The target villages are situated at a height of 5,000 to 6000 ft. (1,500 to 2,000 mt.), above sea level, in two adjacent blocks (namely, Chamba and Narendra Nagar) of the New Tehri district of Uttarakhand State in the sub Himalayan region of India.

### ***III. Background & Reason for undertaking SEVD project in Rani Chauri (Tehri Garhwal)***

1. Due to the construction of the Tehri Dam (which had submerged the old Tehri Township completely), people in the target villages (located only 20 KMs from the dam) mentioned that:
  - a). Weather pattern had changed and rains had become erratic as well as unpredictable either too much or too little.
  - b). The natural habitat of the wild animals and birds were destroyed, as a result of the submergence of many villages and forest lands in the lake, on the up-stream side of the Tehri dam. These displaced wild animals and birds then moved towards these villages and attack and destroy the standing crops of the villagers for their survival.
  - c). Climate change has been responsible for the low yield from the traditional crops grown by them,
  - d). Males from these village have gone to urban centers within the Uttarakhand as well as to other states for jobs.
  - e). Women, children and older people are left in the villages, and the burden of agriculture, livestock rearing and looking after all the work of the house etc., is left to be performed by the women,
2. Women walk long distances to collect the firewood, fodder for animals and fetching of water.
3. The livelihood of the women is affected as there is no regular income generating activities.
4. The women get low prices for their agricultural produce, as they lack the skills and resources to preserve and process the agricultural and horticultural produce for value-addition so as to increase the shelf-life, to get better market price.
5. In view of this, WAFD and INSEDA have undertaken this project for the sustainable development of the villagers through the integration of “Scientific organic farming, rain water storage, low cost renewable energy and income generating activities by “Promoting People Centered, Renewable Energy Based Eco-Village Development (EVD) For (i) Energy, (ii) Water and (iii) Food Security and (iv) Generating Sustainable Livelihood for Local Community”.
6. In addition to above, to also demonstrate the “Local Solutions for Climate Change Mitigation”, which can be taken up by the local people, especially the women. These solutions show and teach them how to have a sustainable life style, through low carbon, on-farm and off-

farm income generation within their own villages. This is possible by using the upgraded skills they learn through the capacity building activities of the EVD project.

#### ***IV. Overall Objective of the SEVD project***

1. The overall goal of this renewable energy based Eco-village development (EVD) in the existing project (in Tehri Garhwal district in Uttarakhand state) is the same as in our earlier project in Bharatpur in Rajasthan state. These are:

- a). To promote people-centered, renewable energy based sustainable village development in 6 selected villages in the Himalayan sub-region of India by integrating renewable energy as well as environmentally benign and eco-friendly low-cost affordable technologies,
- b). To focus on those technologies which are simple and affordable help in improving their lives as well as augment the livelihood.
- c). To train the target families, through capacity building activities, for future actions for combating the negative impact of climate change, through mitigation and adaptation innovations that can be easily undertake with their existing resources.

2. The WAFD (an NGO operating at the grassroots level) and INSEDA (a socio-technical NGO operating at the national level) had been working as partners in the field of promotion of appropriate rural technology for the past about 18 years. Together, they have been involved in the implementation, transfer, demonstration and promotion of socially relevant technologies which could fit in to the local social and cultural environment, rather than following a purely technical oriented approach. Thus they have drawn heavily on the long and practical field experience of its other grassroots partner NGOs in understanding the local people and local situations in developing and transfer a technology.

3. Recognizing bamboo as one of the most eco-friendly and environmentally benign material, for the last 18 years, INSEDA has been working in the design, development, testing, promotion of different rural technologies in partnership and close collaboration with WAFD (Women's Action for Development) in villages of Bharatpur district in Rajasthan state, and now in the villages surrounding Rani Chauri in Chamba block of New Tehri Garhwal district in Uttarakhand state. Bamboo is presently brought from neighbouring district/state, but if large scale implementation of this technology is taken up then it can also be grown in this district/state.

4. The main objective of working with bamboo as the building material in these two project areas which have different agro-climatic conditions (where WAFD was already operating) was to design and develop eco-friendly green technologies to provide clean cooking energy, rain water harvesting from the roof top of the rural houses and storage, compost units for organic agriculture, solar drying and water heating, solar poly house for vegetable cultivation and nursery raising etc. At the same time such bamboo based technologies would be comparatively stronger and affordable, user friendly and provide employment to local artisan and rural women in the project area, during their construction/building, after providing them appropriate training. The people would be able to use these to enhance their existing income, remove drudgery, improve their nutrition as well as quality of life.



## ***V. Technologies implemented in rural areas in Rajasthan state Uttarakhand state within the Eco-village development (EVD) project***

1. Biogas plants: These are made from bamboo reinforced cement mortar (BRCM), which provides clean cooking energy for the house thus saving traditional forms of material used for cooking such as firewood, cow dung cakes, LPG gas etc. It also provides excellent organic manure as a by-product to be used in kitchen gardens/fields. A 2 cum BRCM biogas plant built in Rani Chauri area of the project (fed daily with 50 kg cattle manure mixed with 50 liter of water) produces sufficient gas for cooking for a family size of 6-8 persons, costs INR 32,000-35,000 (400 -450 €). One 2 cu. m. Grameen Bandhu biogas plant would save approximately 4 tons of CO<sub>2</sub> equivalent/ year. [Could you add how large a family it provides gas for, and the climate effect: saved greenhouse gases. The data on saved greenhouse gases must be available from the case on carbon credit for gold standard, which also deal with biogas.



*Pictures: Bamboo basket as reinforcement for cement dome for biogas, biogas plants under construction, finished biogas plant covered with soil*

2. Solar Dryer: These easily portable low cost solar dryers are made from bamboo and polyethylene for harnessing energy from sun to dry fruits, vegetables, spices & herbs in a clean hygienic way and needs no traditional source of energy. It also saves time and is easy to use. The cost of this bamboo solar dryer is INR 1,500 to 1,600 (19-21 €).

4. Roof Top Rain Water Harvesting Unit (RWHU): The RWHUs also use eco-friendly and environmentally benign bamboo as the main building material for building bamboo reinforced cement mortar (BRCM) storage tanks for the RWHUs for harvesting (collecting) and storing rain water from the roofs during rainy seasons, thus reducing women's drudgery of carrying water from long distances. Depending on the roof area of houses, the RWHU built using BRCM tank of 1,000 liters capacity cost INR 8,000-10,000 (100- 130 €), and

the 5,000 liters capacity RWHU is built for INR 30,000-35,000 for an individual rural family (400-470 €).



*Pictures: Constructing solar dryer solar dryer in use, example of dried material*

3. Solar water heater: It is easily portable low cost solar water heaters /dryers are made from bamboo and polyethylene for harnessing energy from sun to heat water for a household cost of this bamboo solar water heater is INR 1,500- 1,800 (20-24 €). It is used for taking bath or pre-heating water for cooking.



*Pictures: Bamboo reinforcement under construction, finished water tank with tap*

5. Composting baskets: Almost all rural areas have a problem of unsanitary conditions due to organic waste being thrown on the street corners or on open dumps. Those farmer families who don't have required number of domestic farm animals to have enough dung for a biogas plants, or don't have enough resources to install even a smallest capacity plant, normally dump their animal dung in pits or heaps above ground to make manure in an unscientific manner. For

such families WAFD/INSEDA is promoting simple compost baskets. These portable compost basket units are fabricated by woven bamboo strips. These are used for making excellent organic manure from any biodegradable waste from the kitchen gardens & agricultural fields. The cost of each woven bamboo basket (1 meter diameter and 1 meter height), which produces enough organic manure for 1 Nali (220 sq.yd.) cost comes to INR 1,400-1,600 (18-21 €). (Note: 22 Nali = 4,840 sq. yd. = 1 Acre)



*Picture: Composting basket in use*

6. Solar Poly Green House (SPGH) -The SPGH are fabricated using very good quality, UV stabilized polyethylene. The comparatively low cost poly house (SPGH) is either used for raising nursery of high value vegetables and fruit trees before planting in the field or by the individual families for growing vegetables year round for own consumption for better nutrition or for selling. The SPGH of 2 mt. width, 15 mt. length & 2.5 mt. height cost INR 30,000-35,000 (400-460 €).



*Pictures: Polyester greenhouse from outside, inside the greenhouse*

## ***VI. Sustainability and Replication of the SEVD (Sustainable Energy based Eco-village Development) Project***

1. Two NGOs (WAFD and INSEDA), have been jointly implementing renewable energy based sustainable “Eco-village Development-EVD” projects in a few selected villages in India since 2002, to use them as model “Demonstration-cum-Training Villages”, for the capacity building of NGOs and development organisations who would be interested in replicating them in their areas of operations, with appropriated modifications.

2. Even after the funding from the FMIC has ceased, both WAFD and INSEDA have continued their interventions in Bharatpur district. These activities involve mostly local women volunteers from those villages to disseminate their learning to other women in their villages; and to motivate at least 1-2 of those 12 villages to implement most of the components of EVD project using their own and other local resources for carrying out mobilization, motivation, awareness, meetings and training to women volunteers in Bharatpur, to spread the concept and project component of EVD in other villages. Thus, this project has exemplified the concept of sustainable and enduring multi-stakeholder learning.

3. The same approach is being followed by WAFD and INSEDA in the villages around Rani Chauri area in the Tehri Garhwal district of Uttarakhand.

## ***VII. Analysis of the SEVD (Sustainable Energy based Eco-village Development) Project***

In order to address the issues of climate change and sustainability and its effects on the day to day lives of the poor at the grass roots (in the villages’ communities) the model which WAFD and INSEDA have adopted that of “Eco Village Development” is one of the successful approaches for the following reasons:

a). This model targets the village which is the smallest unit for interventions because in India the villages communities are ideal for illustrating the concept of appropriate small scale innovations for climate change adaptation and which can be easily replicated in other places with appropriate modifications.

b). The focus on developing capacities of the women leaders and giving them training as well as upgrading their existing skill base, has shown that even after stopping of funding these women can carry the program forward on their own. Our experience in Bharatpur shows that these women leaders can motivate other women in their own villages as well as in surrounding villages to implement and adopt some of these components of EVD. The most common is the adoption of organic farming and kitchen gardening. These activities give immediate results as they can see the changes in their land, and they can get vegetables not only for their own families but can sell the extra produce to earn some money.

c). The key to success of this model is that it is easily replicable as it is simple, using simple durable technologies, which uses locally available material which is environmentally friendly. It

also fulfills felt needs such as clean cheap energy for cooking, storing rainwater so as to use it, drying of fruits and vegetables for future use etc.

ci). [it would be good to add a paragraph discussion the impact on climate mitigation and adaptation, where rainwater harvesting is an adaptation measure, adapting to more erratic rainfall, while biogas is a mitigation measure, reducing need for unsustainable firewood use and fossil fuels, while also limiting uncontrolled methane emissions. Also add how some other solutions contribute to climate mitigation (which is reducing of greenhouse gases) and some contribute to adaptation, and some just contribute to development (as the greenhouses).

cii). To address the issues related to climate change and sustainability effectively at the grass-roots level, one of the approaches could be to take villages as the smallest units for integrated development, by implementing renewable based, environmentally benign and eco-friendly low-cost affordable actions. WAFD and INSEDA's rationale for choosing villages as the smallest units for interventions (especially in India) is that they are usually at the fringes of policy-making and are also the first to be impacted by climate change effects. Village communities are also ideal for illustrating the concept of contextually appropriate, small-scale innovations for climate change mitigation and adaptation, which can be easily replicated in other villages with appropriate modifications.

c). The key to success for these projects is the participation of families specially women living in these villages. This involves their active participation to ensure that their capacity is built and skills up-graded so that they can be actively involved in the implementation of development activities meant to benefit them. This is so that they continue to implement what they have learned on a sustainable basis, even after the withdrawal of the external development agencies.



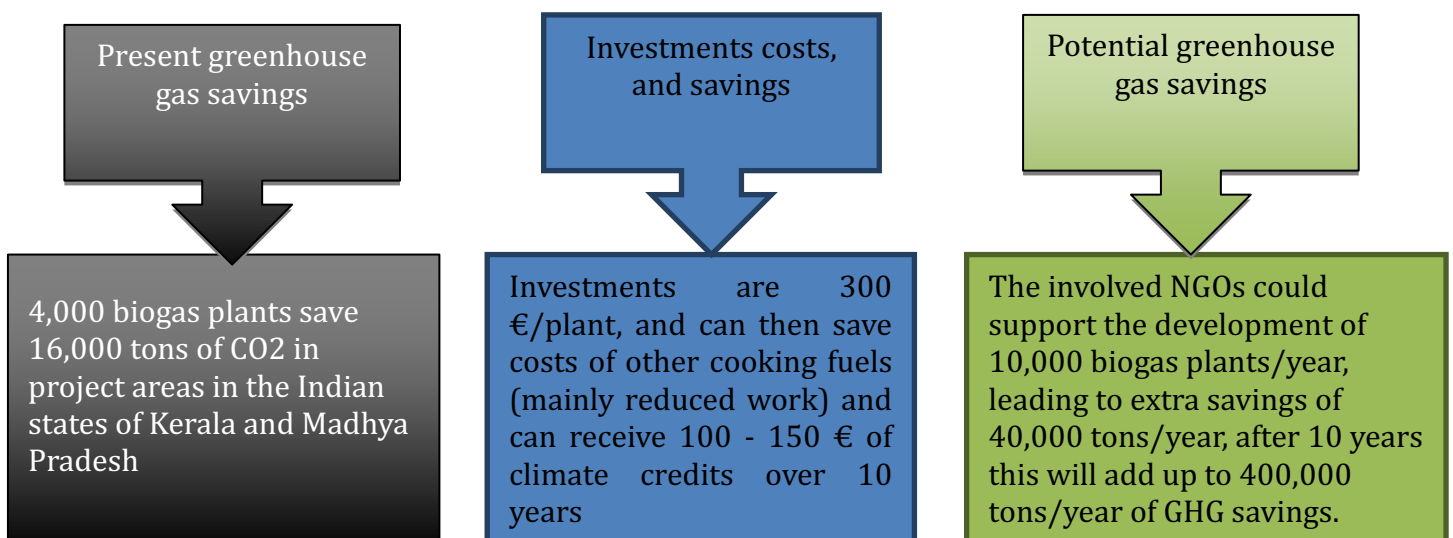


**CARBON CREDIT  
UNDER THE GOLD  
STANDARD FOR  
HOUSEHOLD BIOGAS  
PLANTS OF INSEDA  
MEMBERS AND  
PARTNERS**

Raymond Myles, INSEDA, India

***Summary:***

INSEDA’s Gold Standard VER project was aimed at mitigating greenhouse gases (GHGs) by implementing household bio-digesters and increasing the functionality rate of the biogas plants by bundling household anaerobic biogas plant installed in the rural areas of Kerala and Madhya Pradesh. Biogas generated from the bio-digesters helped in replacing firewood used for domestic cooking purposes, thus improving the quality of air in the cooking space and also reducing the drudgery of women. This project perfectly illustrates the immense benefits to be gained for participants in the Gold Standard VER (Voluntary Emission Reduction) process and the potential for sustainable, nationally appropriate mitigation activities. However, the present process of the lengthy registration, and verification & certification processes has serious shortcomings, particularly for the project developers. The extensive reliance on external agencies for the detailed documentation for every step is prohibitively expensive; problematic-given a rural setting; and time consuming for small project developers. The absence of funding or a financial safety net (for instance, the lack of a provision allowing advance payments from buyers to ease monetary pressures on participants) can impede the smooth functioning of the process. It is recommended that, in keeping with the constraints of grassroots compulsions and finances, Gold Standard process should be reformed and simplified and a funding process should be put in place. Without addressing these concerns, the most valuable mitigation projects (which are in rural areas) will end up being excluded from this process. It is also recommended that there is a need for appropriate capacity building of NGOs and other grassroots stakeholders involved in the carbon credit project.



## ***1.Introduction***

The Integrated Sustainable Energy and Ecological Development Association (INSEDA) is the national organization formed by the Indian grass-roots NGOs in 1995 involved in the promotion of renewable energy, sustainable energy based eco-villages development (EVD) programmes for over 18 years. However, INSEDA's special emphasis and focus has been on the implementation of biogas technology development and promotion in rural areas of India. For over the past over 6 years INSEDA has been involved in the development of carbon credit project for small scale household biogas plants under the Gold Standard Voluntary Emission Reduction (VER). The participants involved under this VER project are INSEDA and its member and partner NGOs from two Indian states, namely, Kerala and Madhya Pradesh (MP).

This project has been developed under the Gold Standard VER. Like a Certified Emission Reduction (CER), a VER (Voluntary Emission Reduction) is also a tradable commodity and refers to reduction of one tonne of greenhouse gas (GHG). The difference between a CER and a VER is that while CERs are generated according to standards and requirements of the Kyoto Protocol and UNFCCC, VERs are independently verified by a third party according to criteria that confirms that the emission reductions are real, measurable and credible.

A Gold Standard (GS) project ensures that the project is sustainable, flexible and transparent through a participatory approach with initial and main local stakeholder meetings.

## ***2.Description of the case, its development and the background situation***

### **a). Purpose of the project activity:**

(i) The purpose of this on-going project is to contribute towards sustainable development through the effective utilisation of gas from household biogas plants (which were built in a decentralised manner by NGO members and partners of INSEDA) and switch over from biomass like firewood to clean renewable energy generated from utilizing animal wastes and other organic wastes in the rural areas of Kerala and Madhya Pradesh.

(ii) The project activity is generation and utilisation of clean and environmental friendly gas from the household (family size) bio-digesters (plants) from domestic farm animals and other locally available organic wastes. This will improve hygienic conditions in the rural areas and would also lead to reduction in greenhouse gas (GHS) emission by displacing conventionally used firewood for cooking, and thus contributing to the mitigation of Climate Change. In addition, these household biogas plants (bio-digesters) would also remove drudgery of rural women in the collection of fire wood and cooking, reduction of indoor pollution as well as,

### **Socio-Economic impact:**

The replacement of traditional fuel with gas from bio-digesters from domestic farm animals and other wastes remove drudgery of rural women in the collection of fire wood and cooking, reduction of indoor pollution The residues (slurry) is a valuable nutrient and soil enricher

**Environment impacts:** Reduces greenhouse gas (GHS) emissions by displacing unsustainable firewood for cooking, reduces uncontrolled methane emissions and eliminates black carbon from households.

positively contribute to the overall empowerment of women and adolescent girls in rural India. The residues (biogas digested manure in the slurry-form) discharged after giving the environment-friendly and non-polluting gas from the bio digesters would be used as enriched organic fertilizer, increasing water holding capacity of the soil and improve the soil conditions for the crop production.



**b). Description of the Project:**

(i) The biogas project activity is located in rural areas of Kerala and Madhya Pradesh. Consumption of firewood for household purposes in the rural areas is the main cause of deforestation in the project areas of Kerala and Madhya Pradesh. The project has around 4,000 household biogas plants in various districts of two states of Kerala and Madhya Pradesh. In each of 4,000 households a biogas plant unit is installed, protecting the trees, thus reducing the release of greenhouse gases (GHS) to the atmosphere, and positively contributing towards the mitigation of climate change. The biogas unit is of different sizes (1, 2, 3, 4 & 6 cum capacity), depending on the number of persons in the household and the availability of dung from their domestic farm animals. Biogas is generated in the bio-digesters (plants), in which bovine (cattle & buffalo) dung (manure) and other organic waste is fed and allowed to be digested under anaerobic (in the absence of air) condition for a prescribed number of days. The biogas thus generated is composed of a mixture of 55-60% Methane (CH<sub>4</sub>) and 35-40% Carbon dioxide (CO<sub>2</sub>) plus traces of other gases and is utilized for household purposes, mainly for cooking (using stove with specially designed burners) and to some extent for lighting (especially designed lamps with mantle).

(ii) Apart from the initial and main stakeholders' consultations, the project cycle for a Gold Standard (GS) project is not very much different from a regular CDM project. It is essential, however, that the project is sustainable, is without negative environmental impacts and complies with the UNFCCC additionality requirements.

**c). Project contribution to the Sustainable Development:**

This biogas project has the goal of dissemination of biogas technology to improve socio-economic condition of the rural people and reduce GHG emissions. In addition, the project is also contributing to the improvement of living standard of the rural people. Brief advantages of the project are given below:

(i) Environmental wellbeing:

- Utilizing biogas as an energy resource contributes to clean environment.
- Transformation of organic wastes in to high quality enriched bio-manure/fertilizer.

- Improvement of hygienic conditions through reduction of pathogens by utilizing the animal and other organic wastes in the bio digesters.
- Contribution to the global environment improvement by reducing deforestation and improving biodiversity.
- It will also lead to improvement in soil condition by providing high quality manure.

(ii) Social-Economic wellbeing:

- This project is providing employment opportunities for the local people during construction and maintenance of the biogas plants.
- It would lead to improve the economic level of the local community.
- It is also reducing cooking time, thus providing women to take up other activities.
- It is increase overall health situation by reducing smoke and soot in the kitchen, thus eliminating health hazards from indoor air pollution.

(iii) Technology wellbeing:

- Better and field tested biogas plants, mainly the most popular India fixed model approved by the Ministry of New and Renewable Sources (MNRE) thus improving biogas yield.

d). Steps involved in Gold Standard Cycle for Validation and first Verification

- INSEDA started the dialogue with its members and partners for developing biogas carbon credit project in the middle of 2007.
- Started collection of data on the biogas built by INSEDA members and partners, using a standard form and compiling them and creating database in late 2007.
- Organised and participated in initial meeting with the local stakeholders in early 2008
- Initiated development of Project Design Document (PDD) and Passport and submitted to Gold Standard Foundation (GSF) for pre-feasibility assessment in February 2009
- Meanwhile also initiated baseline survey in MP and Kerala using independent external organisation to authenticate the information submitted by INSEDA members and partners to ensure that they were correct
- Received positive pre-feasibility assessment from GSF in September 2009
- After receiving the positive pre-feasibility assessment report from GSF and after completion of baseline survey, revised the PDD and the Passport
- Proceeded with the main stakeholder consultation in MP and Kerala in October 2009. INSEDA also sent letters to invite several international agencies as well as the representative of GSF to participate in both the stakeholder consultations/meetings. In the stakeholder meeting shared the revised PDD and the Passport.
- Prepared a report after the meeting for the consultation with the Local stakeholder

- Identified the DOE accredited by UNFCCC and signed agreement in March 2010 for carrying out validation of the INSEDA biogas project
- Process of validation was started by DOE with the visit of the validator to the two project states (MP and Kerala) in May 2010
- PDD and the Passport was finalized along with local stakeholder consultation report
- Final PDD and Passport was uploaded on the INSEDA website in September 2010
- Organised a meeting the stake holders in MP and Kerala in October 2010 to share the final PDD and Passport with them. INSEDA also sent invitation letters to several international agencies and representative of GSF to participate in these two meetings.
- At the same time, during the period from May 2010 to May 2011 answered various queries raised by the validator, as well as collected and sent additional supporting documents to fully satisfy validator to finalize the validation report
- Successful completion of the validation process and report was up loaded on the website of the Gold Standard Foundation (GSF) in June 2011 for their internal review.
- After review of validation report, some queries were raised by the GSF in the middle of August which were satisfactorily answered by the end of August 2011
- Received formal letter of communication from the Gold Standard Foundation (GSF) on September 15, 2011, informing that our project- "GS 666: Installation of Biogas Plant by INSEDA Members and NGO Partners" is officially registered with the Gold Standard w.e.f. September 2009 for 10 years period.
- Based on the formal undertaking by INSEDA to GSF the project was uploaded on GS website changing the project status on the registry.
- Meanwhile, INSEDA appointed the same DOE (which had done the project validation) on July 26, 2011 for undertaking the verification based on field visit of certain percentage of biogas plants in MP and Kerala.
- The DOE visited the sites of biogas plants in MP during February 2012 and in Kerala in April 2012, to undertake verification of certain percentage of plants covered under the project for allotment of VER prepare their report for the issuance of VER credits to INSEDA
- Based on the on-site verification in MP & Kerala, and clarification of various points as well as submission of monitoring report and other documents, DOE finalised the verification report in July 25, 2012 for submission to GSF for issuance of VER credits to INSEDA.
- The DOE's verification report supported by monitoring report and other documents were uploaded on the website of GSF by the end of July 2012 for internal review. The Gold Standard communication received was that the INSEDA project status had changed to 'Registered, verification process complete, ready issuance of VER by GS'.
- After internal review period of four weeks, GSF sent many queries by the end of August 2012, to be responded by INSEDA. It took another two months to fully satisfy all the queries raised by the GSF.
- Finally, GSF issued VER credits to INSEDA for a period of two years, Sept 2009 to September 2011, in the second week of November 2012.



- Based on the VER credits, our buyers paid the appropriate fees to GSF after which the VER issuance was credited to INSEDA.
- The buyers transferred the money for the entire VER due to us in the INSEDA bank account during the third week of November 2012.
- On its part, the INSEDA transferred the amount due to each stakeholder as per the percentage share agreed. The members and partners of INSEDA (whose names were registered in the PDD) were also given the shares their respective plant owners and were listed in the project documents.

e). **Second verification for issuance of next one year VER by GSF to INSEDA**

- Since November 2012 INSEDA started verification process for getting issuance of VER credits for the next one year period, starting from Sept 2012.
- The verification by the DOE was completed on September 16, 2013, and the verification report with supporting documents was uploaded on the website of GSF on September 18, 2013 for minimum internal review period of three weeks.
- After the review period INSEDA received few queries and clarifications from GSF, which we have answered during October and November 2013.
- Now we are awaiting the registry of the next set of VERs by the GSF to INSEDA for the 1 year period i.e. Sept 2011 to Aug 2012.
- Once the VERs are registered by the GSF, we will ask our buyers to disburse the next payment to INSEDA, as per the agreement.
- Soon after that INSEDA will initiate process for the third verification, which is already due for the for the period September 2013 to August 2014.

### ***3. Analysis***

Carbon Credit projects can be very relevant for the socio-economic benefit of the rural people in India and South Asia and other developing countries, but as mentioned, in the present form it faces many problems and barriers. At present the CDM, Gold Standard and other registering bodies of the carbon credit projects, use the mechanism which are not only too cumbersome, but also time consuming, as it takes as much as 3-5 years. Presently, it is very heavily loaded in favour of highly paid external consultants, as it involves detail documentations, baseline survey and other regular field surveys, validation, verification and monitoring etc. Because of all these the transaction cost becomes too high and the main project developer has to be on the mercy of these high-fi external consultants, not knowing till the end (which could take up to 3-5 years or more durations) whether the carbon credit project will be approved for registry or not? For any reasons the project falls through at any of the stages, the project developer has to pay heavily, and if a small developer is involved, it can lose, both money and become bankrupt, as well as lose credibility with the other stakeholders. In this process the real stakeholders (project developer/holder and the local NGOs with meagre resources as well as the poor end users) suffer, and mistrust is generated amongst them due to these delays.

It is very clear that the whole process of registering the carbon credit projects has been designed by the registration agencies that it is time consuming and resource guzzling for the stakeholders, like the project developers, the members, partners and the end users. After clearing each step successfully one wonders if it was worth going through it, and whether the next step will be cleared or not? The majority of NGO groups/NGOs network working in the developmental programmes/projects operate on meagre resources and try to reach the normally unreachable target groups in difficult situations. Their concern is to deliver the best to the target groups in as much cost effective manner as possible, as their resources, both in term of manpower and financial are very limited. At the same time, NGOs also have to maintain their credibility with the local people, as they have to continue working with them regardless of external support, as that is what they have choose to do. Therefore, in spite of good work, they could never do fool-proof documentation of the entire process. On the other hand, the carbon credit projects are heavily loaded in favour of over documentation, perhaps not required so much for registration, but more to protect the registration agencies themselves and their reputation. Because of too much dependent on such approach, many very good grassroots projects which have very strong social dimensions perhaps will never get registered as Gold Standard projects, as the people managing and working for such groups are very far from the grassroots realities.

For the household biogas plants, which is highly decentralised programme, and so much relevant to be considered for carbon credit, only those who have long practical experience of implementing such projects can understand the many socio-economic benefits which it provides to the rural communities, without even studying such elaborate documents like, PDD, Passport and other reports based on new studies by highly paid external experts.

From the step-by-step process of validation, verification for the GS registration for INSEDA biogas project, described above, it becomes clear that there is a need for capacity building of NGOs and other grassroots stakeholders involved in the carbon credit projects, to fully understand the requirements of the certification agencies which needs to be followed strictly. Most NGOs operating at the state level and the small stakeholders don't have the expertise and resources to send their functionaries for capacity building for preparing the carbon credit projects and later on to complete the entire process leading up to registration. Moreover, the capacity building of NGOs and the other smaller stakeholders should be ably backed by good socio-technical organisation with expertise and experience in both theoretical and field level practical knowledge as well as financial resources to act as development oriented consultants for developing bundled carbon credit projects by combining a number of small scale decentralised units/systems. The job of socio-technical organisation acting as project consultant would also be required to do hand-holding as well as guide and assist NGOs and other stakeholders at important stages of the process and facilitate preparation of monitoring reports and answer all the queries of DOE and international registration agencies satisfactorily to ensure that the project fulfils all the requirements of the registration and issuance of VER/CER credits.

The average greenhouse gas (GHG) reduction per house biogas plant of 2 m<sup>3</sup> capacity (if properly fed with cattle manure, and properly operated by its owner) would be 4 ton per year. Under the INSEDA biogas gas carbon credit project, over 4,000 household biogas plants, 1, 2, 3, 4 & 6 m<sup>3</sup> capacity (mainly 2 & 3 m<sup>3</sup> capacity) were included from the two states, namely Madhya Pradesh (MP) and Kerala. These biogas plants generates over 20,000 VERs annually. If the support were available then on an average of 10,000 house hold plants/year can be built by the NGO members and partners of INSEDA in these two states of India.

#### ***4. Conclusion and Recommendations***

When looking back, why we got involved in the carbon credit project for household biogas plant of INSEDA members and partners under the Gold Standard, and continued going through the cumbersome process for registering the project, the reasons were several. Some of them being, INSEDA's external consultants, were so good in marketing the idea of carbon credit that they sold us the moon in terms of this project, and also we were able to find a very credible and trusted buyer, the First Climate, as buyers. The First Climate signed the agreement with INSEDA in May 2008 to buy the VER generated from our bundled household biogas project, and ever since have been providing moral support. The FC also agreed to take care of some of the cost on validation, verification and registration etc., as well as provided INSEDA with some advance funds at the very advanced stage of verification and issuance of VERs. Their top executive even visited the project sites in MP, which is one of INSEDA biogas project states, to understand the project and realities at the grassroots level, meeting and talking with the local poor owners of the biogas plants about the direct and indirect benefits as well as made movie for awareness building of people in the western countries and for promotional aspects. Another reason for continuation with the process and not giving up in the middle was because of the faith and expectations of our grassroots members and partners in INSEDA, who along with INSEDA had spent meagre resources for collection of data, field level information, documentation and in the development of this biogas project and in organising various stakeholders meetings as well as their own commitments to their end users, mainly the rural biogas plant owners. Therefore, in spite of five years of long wait we continued in the entire process and took it to the logical end.

In view of the above, we would like to recommend that the entire process of registration should be completely revamped, to cut down the roles of high cost external consultants, reduction in the transaction costs as well as reduction of project registration time by at least one fourth of the present duration. There is also a need for providing some kind of "Development Fund" or "Revolving Bridge Fund", in the form of grant from the donor groups, which could be used for capacity building and sustain the NGO project holders and members and partner grassroots NGOs till the project is registered.

The registering agencies should reviewed to ascertain what pro-active role they can play and become NGO friendly and provide hand holding role, especially in the case of socially relevant carbon credit projects for highly decentralized applications.

Based on over five years of process oriented involvement in developing its own carbon credit project, INSEDA now has in-house expertise and practical field experience to develop carbon credit project for registration by the international certification agencies, both CER and VER, using step-by-step process oriented approach. INSEDA can act either as socio-technical organisation for the capacity building of NGOs or provide consultancy to NGOs in develop carbon credit projects or act as partner organisation in any joint development of carbon credit project, starting from inception till the registration and issuance of VER/CER credits.

**wafd**



women's action for development

## About WAFD

Women's Action For Development (WAFD) was registered under the Societies Registration Act XXI of 1860 (Registration No. 9670 dated September 18, 1978) as an endeavour of committed socially responsible people.

WAFD's vision, mission and philosophy are based on the belief that women are central to any sustainable development efforts. Women have to be recognised as the primary stakeholders in their own development and growth. The role of WAFD becomes that of a facilitator to equip the women for creative action through participatory implementation, management and maintenance, so that ultimately they can take over these projects.



*One of our leaders with a compost unit and a roofwater tank*



# The Ranichauri Ecosystem

Situated at an altitude of 6500 ft. above sea level, Ranichauri is a small village in the Tehri region of the Tehri-Garhwal district of Uttarakhand. The Ranichauri ecosystem comprises of around 20 villages, and is situated 6 km from Chamba.

Ranichauri acts as a mini-marketplace and a transit hub for Chamba. Ranichauri enjoys a certain 'pull' from Chamba as villagers make 3-4 trips a month on an average, for their festive or recreational purchase needs. Chamba, being a major marketplace, also acts as a major transit junction for Hrishikesh, New Tehri and the Himalayas.

Between the villages, there is immense social connect. There is a high degree of familiarity between the villagers and social gatherings, celebrations etc. are attended by families from different villages.

Walking is the primary mode of travel and the mountainous terrain is frequented rather always on foot, with heavy luggage at times.

WAFD is currently active in 4 villages in all - Jagdhar, Dargi, Savli and Maun (including the Guriyali and Salamkhet divisions).



*The ecosystem with Chamba at the top left, Ranichauri on the right and Savli at bottom left*

## Stories from Ranichauri

For the year 2012 - 2013, this section will cover two of our women leaders - one, our first change agent in the area, and the other, one of the newest additions to the WAFD family.

**Anita** is a resident of village Savli just bordering the central marketplace of Ranichauri, Anita was the first woman volunteer to join WAFD's vision in the area. Anita attended the very first meeting at Ranichauri and was sent to Bharatpur to get acquainted with WAFD's methodologies, principles and work ethics. Back from Bharatpur, Anita started the first self-help group (SHG) in Ranichauri with 25 members, each contributing ₹ 50 per month.

Anita recalls one of her first experiences with the SHG by asserting how SHGs help mobilise the villagers. "Vimla and I went to Dargi, helped them open their bank accounts and also educated them about the benefits of organic farming". Since then, Anita has been monumental in the formation of the other SHGs in the 6 villages WAFD has been present in.

Being the most experienced WAFD member in Ranichauri, Anita clearly understands the business implications of the various programmes. "Bee-keeping has been the only business generating programme", she states, "but some of the bees escaped". When asked about the acceptance of other programmes, Anita has a detailed



*Anita with her solar driers*



picture to paint. “We started with word of mouth. I was associated with Pant Nagar University and was taught agriculture, farming and business basics. But what do we do with that knowledge when we can’t implement it anywhere? Enter WAFD, I found a whole new opportunity in my own backyard. I understood that time, money, resources and communication was necessary to make my fellow villagers understand the benefits of the things I had learnt. Through the SHGs, we were able to ease the process as things were otherwise difficult.”

So what benefits have come out of the programmes? The reply is short and as direct as possible, “See for yourself”, and the pause turned into, “people have become less interfering in women’s lives. SHGs have managed to bring people together to a great extent. We not only carry out programmes, but also conduct social and cultural gatherings. Kirtan mandlis are a regular affair, we organise trips, we raise funds etc. We do all this so that this village doesn’t stay behind, and at the same time, all other villages move ahead – that’s all that we want”.

**Anusuya** is one of the newest additions to the WAFD family at Ranichauri. Always greeting her guests with hot tea, delicious snacks and sweets, the generally talkative Anusuya holds herself and WAFD with a lot of respect. “I got to know about WAFD through word of mouth. The amount I’ve learnt after joining WAFD is immense and



*Anusuya with her mist harvester in the background*

I'm truly grateful to them", says Anusuya whose husband is the principal at a school in Chamba and a part-time priest at a local temple, and has two sons – one a B.Ed. and M.A., and the other a Ph.D. – both from Pant Nagar University.

In her short association with WAFD, Anusuya volunteered for two of the newer programmes – the polyhouse and mist harvesting.

Anusuya's polyhouse measures 250 sq. ft. and had malta and dhaniya (coriander) saplings ready to grow. A high density mist harvester also awaits the mist on her terrace. "Please come again, consider this your home", is her standard goodbye line, always delivered with a smile.



*Anusuya at her polyhouse*





**Clockwise from Left:** A roofwater tank, composting unit, solar water heater in action, red chillies drying in a solar drier, a wooden solar drier, and, a bamboo solar drier





**Clockwise from Top Left:** A polyhouse in Savli, biogas-fuelled stove, pickle jars, and, a high density mist harvester



# INSEDA

**Integrated Sustainable Energy and Ecological Development Association**



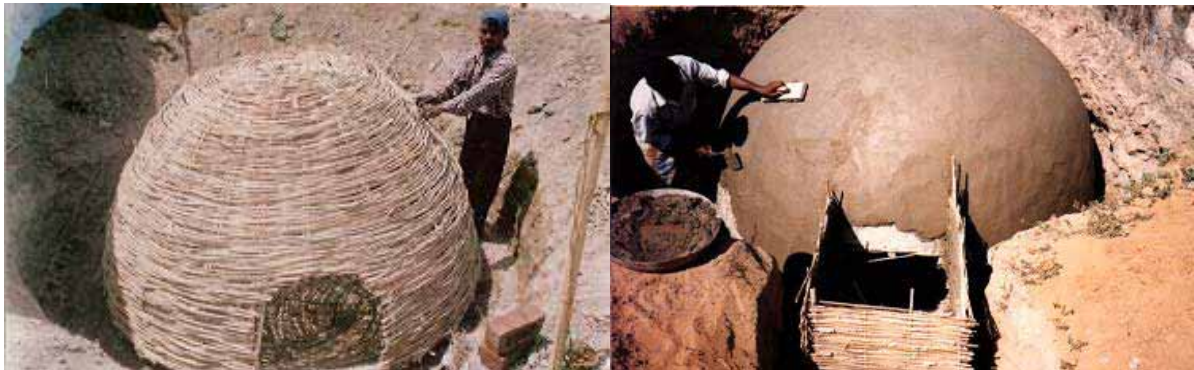




# INTEGRATED SUSTAINABLE ENERGY AND ECOLOGICAL DEVELOPMENT ASSOCIATION

## 1. INSEDA

The Integrated Sustainable Energy and Ecological Development Association (INSEDA) is the national India organization formed by the grassroots NGOs who had been involved in the promotion of renewable energy programmes with special focus on the implementation of biogas development in rural areas of the country, since 1980. INSEDA is a membership organization, at present having about 50 Indian NGOs as its members. The member organizations had been operating as an informal network for more than 15 years before establishing INSEDA as a formal body. INSEDA was registered as a society on December 11, 1995, under the societies registration act XXI of 1860, Delhi. The INSEDA also has FCRA Number from the Ministry of Home Affairs (MOHA), Government of India to receive foreign funds for implementing developmental projects/programmes in India. The area of operation of INSEDA is the entire country.



## 2. AIM

INSEDA is a National Socio-Technical Development Association (NASTDAN) of NGOs established with the aim of facilitating process oriented, people centred, sustainable human development (SHD) in partnership with local NGOs (non-government development organisations)/ VDOs (voluntary development organisations) through the promotion and implementation of environmentally benign renewable energy and ecological & natural resources development programmes, focusing on the poor, weaker, marginalised and other vulnerable & deprived sections as well as women-folks of the rural communities.

## 3. ORGANISATIONAL MEMBERS

The main focus of INSEDA is the development and promotion of sustainable rural energy. INSEDA at present has over 50 member NGOs, spread throughout the country, operating in almost all the major states of India. All the members have deeper commitments to the promotion of low cost affordable renewal energy technologies (RETs) as well as environmentally friendly ecological development programmes. This common interest, shared vision and goal bind the member NGOs together. All the INSEDA members have fairly well developed infrastructure at the grassroots level to implement developmental projects/programmes.



#### 4. ROLE AND SERVICES PROVIDED BY INSEDA AND ITS OPERATIONAL STRATEGY

INSEDA plays pro-active role and provides services and guidance to its members and other partner NGOs, using participatory process, for qualitative and quantitative growth of the target groups, treating them as the primary stakeholders. The role and services provided by INSEDA and operational strategy to realise its vision and goals are:

- To provide services and guidance to members and other partner NGOs and facilitating their involvement for promoting and implementing sustainable development projects/programmes, through active target group's participation and by facilitating establishment of micro level people's institutions (MLPIs).
- To facilitate as well as undertake capacity building programmes for the target groups/communities with a view to strengthen local skills, knowledge, initiatives and enterprises for participatory implementation of appropriate projects to re-generate and conserve micro-environment within their own micro-eco systems.
- To provide services and guidance to member NGOs and other partner NGOs, in technical, socio-technical aspects for the implementation of appropriate projects for sustainable human development.
- To provide services in information collection & dissemination; preparation of appropriate projects; and appraisal, monitoring & evaluation support services.



- To provide expertise to NGOs in the capacity building related to sustainable energy & food production, eco-development and natural resources development, utilisation, maintenance and management.
- To act as trainer of trainers in the field of renewable energy and ecological development for NGOs.
- To promote and transfer appropriate renewable energy technologies (RETs) for meeting domestic fuel needs and energy conservation as well as RE based power generation in a decentralised manner.
- To promote issue based, thematic and single technology based networking of grassroots NGOs. Also network with other national, regional & international groups/agencies involved in similar programmes.
- To act as "APEX Body" as well as to take-up the responsibility for joint-implementation, over all coordination & management of the network and package projects/programmes promoted by INSEDA by involving its member NGOs. In such projects INSEDA plays the role of a Nodal Agency for channelling funds from donor/funding agencies, look after the capacity building of network project members and monitoring the project to realise the overall goal in an effective manner.
- To facilitate or directly conduct different types of studies (case, technical, socio-technical & scientific studies) related to renewable energy and Environmental issues/ aspects; as well as prepare different types of campaign, promotional & communication and training materials, teaching aids alone or jointly with member agencies.
- To promote and directly implement and manage innovative and pathfinder projects related to renewable energy, ecological and natural resource development, for pilot study, demonstration and field evaluation before they could be taken up and replicated by NGOs and micro level people's institutions (MLPIs).



- To promote national and inter-regional as well as South-South (S-S) and South-North-South (S-N-S) cooperation and network among organisations that are working in the fields of energy, ecology and environment development.
- To undertake appropriate technology transfer in other developing countries; as well as, from other countries to India, using INforSE (International Network on Sustainable Energy), and other such networks and organisations as a medium/ channel.
- To act as Regional/International Coordinator as well as to host the Regional/Global Secretariat of the international/global networks/organisations for the effective promotion of renewable energy and environmental & ecological development activities/ programmes through member NGOs.
- To facilitate and assist in developing appropriate linkages for setting up of sustainable marketing channels for eco-friendly agricultural (both on farm & off farm) products, renewable energy gadgets and other environmentally sound products, which are produced and/or processed by its members and their target communities.
- To promote, facilitate and assist its members and other NGOs to undertake sustainable energy based decentralised Power Generation, especially in rural areas of the country.
- To promote, facilitate and assist its members and other NGOs to undertake joint implementation of collaborative projects/programmes for establishing of community oriented, pilot demonstration- "Eco-village Development (EVD) models" based on sustainable energy.



- To promote, facilitate and if required jointly plan and undertake implementation of "Action and Adaptive R&D project/programmes" related to renewable energy and environmental and ecological development, in collaboration/partnership with its members NGOs, R&D institutions and universities.

#### 6. INSEDA'S NATIONAL SECRETARIAT-CUM-MAILING ADDRESS

Integrated Sustainable Energy and Ecological Development Association (INSEDA)

C-37, First Floor, Jeewan Park, Pankha Road,  
Uttam Nagar, New Delhi-110059, India

Phone: + (91) (11) 2564 4038; Telefax: + (91) (11) 4502 5711

Mobile: + (91) 9212014905 and + (91) 9899094905

Organisational E-Mail: [rmyles@inseda.org](mailto:rmyles@inseda.org)

INSEDA's Website: <http://www.inseda.org>

#### 7. CHIEF FUNCTIONARY AND CONTACT PERSON

RAYMOND MYLES,

Secretary General-cum-Chief Executive

TELEPHONE, FAX & E-MAIL: - Tel: (011)-2564 4038

Telefax: (+91)-(11)-4502 5711

Mobile (Cell): (0)-9212014905, (0)9899094905

E-Mail: [ray.myles@gmail.com](mailto:ray.myles@gmail.com)

#### 8. INSEDA as Host for Regional Secretariat of INFORSE

The Regional Secretariat for the INforSE South Asian Region (**IN-SAR**) is hosted by INSEDA at its **National Secretariat Office: C-37, First Floor, Jeewan Park, Pankha Road, New Delhi- 110059, India**. INFORSE SA Website: [inforse.southasia.org](http://inforse.southasia.org)

Even though, **IN-SAR** includes all the 7 SAARC Countries, but at present it is active in Bangladesh, Nepal, India & Sri Lanka. All these four countries five have National Focal Points (**NFPs**) for promoting INFORSE aims and objectives.

***Raymond Myles, Regional Coordinator (RC) for INFORSE South Asian Region (IN-SAR).***