

Table of contents

Introduction	2
SVT F-150 Lightning specific features	4
Engine/Transmission	6
Drivetrain	8
Options, color and trim	9
Maintenance	10
Child Seat Installation	13
Tire Information	15
A word about warranty coverage	18

All rights reserved. Reproduction by any means, electronic or mechanical including photocopying, recording or by any information storage and retrieval system or translation in whole or part is not permitted without written authorization from Ford Motor Company. Ford may change the contents without notice and without incurring obligation.

Introduction

INTRODUCTION

Welcome to the Ford Special Vehicle Team family and thank you for purchasing the Ford SVT F-150 Lightning. We trust that our tremendous dedication to the automotive enthusiast's total ownership experience will provide you with many miles of exhilarating, safe, and comfortable driving in your new SVT F-150 Lightning.

SVT strives for balance between powertrain and chassis, cornering prowess and long-distance comfort, always working to build vehicles in which no one system overwhelms or overshadows any other. In the SVT F-150 Lightning, that philosophy is carried forward through a sophisticated powertrain as well as significant interior, exterior, suspension, and braking system components.

This supplement complements your F-150 Owner's Guide and provides information specific to SVT and the SVT F-150 Lightning. By referring to the pages listed in this supplement, you can identify those features, recommendations, and specifications unique to your new SVT F-150 Lightning.

If you have any questions, please call us at the Ford Special Vehicle Team hotline from 8:30 a.m. to 6:00 p.m. EST at 1-800-FORD-SVT (1-800-367-3788).

SVT HISTORY

The Ford Special Vehicle Team (SVT) was established in 1991. SVT was commissioned to create factory-produced driver's cars and trucks; vehicles that possess a balance between engine and chassis, roadholding and a supple ride, refinement and performance capability. These qualities are the core of the SVT product development philosophy.

To support SVT, Ford Motor Company created a dedicated product development group, Ford Special Vehicle Engineering (SVE). In October 2001, Special Vehicle Engineering (SVE) was renamed Special Vehicle Team/Engineering (SVT/Engineering). The nucleus of Ford SVT is a small, cross-functional group of engineers, product planners, and marketing people who meet on a weekly basis to ensure SVT vehicles and their mission remain focused. SVT draws heavily on the talents and knowledge of other driving enthusiasts at Ford who work in the key disciplines of design, product development, manufacturing, and marketing. The heart of the SVT philosophy is a deep commitment to skillful and enthusiastic driving. The ultimate goal of everyone at SVT is to create vehicles that speak to the needs and desires of the knowledgeable driving enthusiast.

Every SVT vehicle produced has been designed and developed with four key virtues in mind: Performance, Substance, Exclusivity, and Value. These hallmarks have driven the SVT Mustang Cobra since 1993, the original SVT Lightning from 1993 to 1995, the SVT Contour introduced in early 1997 as a 1998 model, and the 1999–2003 SVT F-150 Lightning.

SVT OWNERSHIP BENEFITS

- **SVT Authorized Dealer:** A group of approximately 600 specially trained and certified SVT dealers who are dedicated to a culture within their dealership that is friendly to the knowledgeable driving enthusiast.
- **SVT Premium Service:** Owners and lessees of 2003 model year SVT vehicles will be provided with a complimentary loaner vehicle when their 2003 SVT vehicle is in for service (includes warranty work and routine maintenance, other than oil changes). The dealership will also wash and vacuum the customer's vehicle, unless requested otherwise.
- **SVT Owner's Association One Year Membership:** The SVT Owner's Association is a club designed to enhance the experience of owning an SVT vehicle through events and learning activities, as well as the camaraderie of spending time with other SVT enthusiasts. Your new vehicle purchase or lease entitles you to a **free** one year membership.
- **Team Ford Racing One Year Membership:** Team Ford Racing provides inside access to news about Ford racing teams and drivers, exclusive race-day hospitality programs, access to test sessions and other benefits.
- **Certificate of Authenticity:** In recognition of your vehicle's exclusivity, the certificate documents your vehicle's date of production, vehicle identification number, final assembly plant and production sequence number. Certificates are printed 60 to 90 days after production is complete, and will be mailed to you automatically.
- **SVT Info Center:** Have a question or want information about your SVT vehicle, or any of our new products? Please call the SVT Info Center at 1-800-FORD-SVT. We'll handle your request or get you in touch with someone who can.
- **SVT Website:** The official SVT site, www.svt.ford.com, will provide you with frequently updated information on products, events and many other areas of interest for SVT owners.
- **Official SVT Merchandise:** Let the world know you are an SVT fan, and look sharp at the same time. We have completely updated the SVT apparel lineup for 2003, with higher quality, brand name merchandise. Visit www.fordcollection.com.

SVT F-150 Lightning specific features

F-150 LIGHTNING SPECIFIC FEATURES

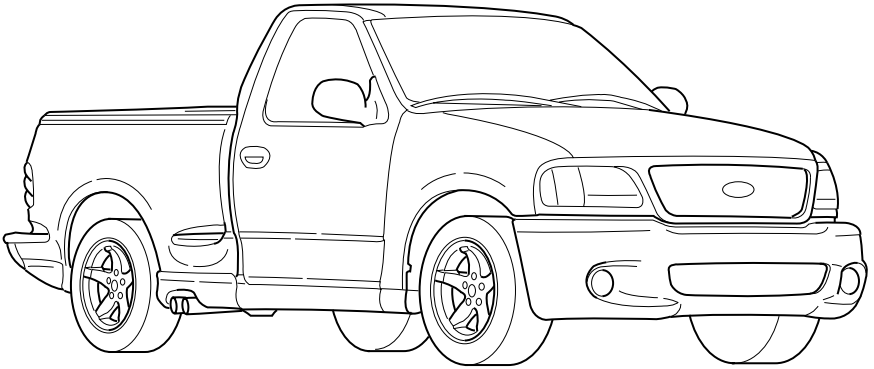

- 5.4L 2V Triton Supercharged Intercooled V8 engine
- Modified 4R100 4-speed automatic transmission with OD lockout
- Limited-slip differential
- Auxiliary transmission fluid cooler
- Eaton supercharger
- Engine super cooling system
- Heavy duty battery
- Unique front fascia with integrated, round fog lamps
- Unique upper and lower grilles
- Unique front lower air deflectors
- Unique cab rocker and lower box moldings
- Unique wheels, tires and locking lug nuts
- 4-wheel ABS/4-wheel disc brakes
- Bilstein monotube front and rear shock absorbers
- Unique headlamps, tail lamps and side marker lamps
- Unique high-mount stop lamp/cargo lamp
- Outside rear view mirrors with integral turn signal

SVT F-150 Lightning specific features

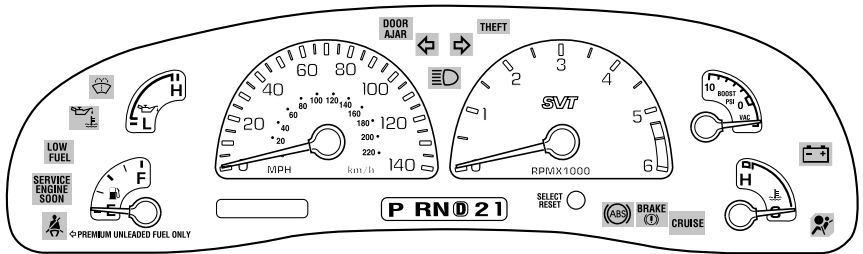

- Unique electro-luminescent instrument cluster with SVT signature white-faced gauges, including vacuum/boost gauge
- Unique 60/40 leather/cloth seats
- Standard 6-way power driver's seat
- Accentuated seat back and cushion lateral bolstering
- 4-spoke leather-wrapped steering wheel
- Leather-wrapped door trim inserts
- Premium In-Dash Six CD Sound System
- Dark tinted sliding rear window
- Sun visors with illuminated mirrors
- Key pad entry
- Satin chrome interior door release handles
- Premium carpet and floor mats

Engine/Transmission

5.4L SUPERCHARGED V8 ENGINE

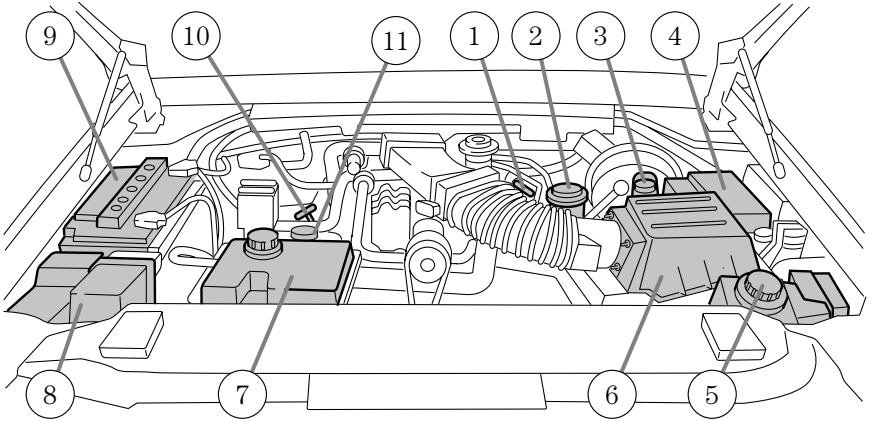

1. Engine oil dipstick
2. Power steering fluid reservoir
3. Brake fluid reservoir
4. Power distribution box
5. Engine coolant reservoir
6. Air filter assembly
7. Intercooler coolant reservoir
8. Windshield washer fluid reservoir
9. Battery
10. Transmission fluid dipstick
11. Engine oil filler cap

Engine/Transmission

ENGINE

Configuration	Supercharged longitudinally mounted, 90-degree V8, single overhead cam, cast iron cylinder block and cast aluminum cylinder heads
Bore x Stroke	90.2 x 105.8 mm (3.55 x 4.17 in)
Displacement	5409 cc (330.1 cid)
Compression ratio	8.4:1
Horsepower (SAE net)	284 kW @ 4750 rpm (380 HP @ 4750 rpm)
Torque	610 Nm @ 3250 rpm (450 lb.-ft. @ 3250 rpm)
Redline	5250 rpm (fuel shut-off at 5500 rpm)
Specific output	52.5 kW/L (70.2 HP/L)
Valvetrain	Single overhead cam, silent-design chain drive, roller finger followers with hydraulic lash adjustment, ovate-wire valve springs, two valves per cylinder
Fuel system	Sequential electronic fuel injection
Ignition system	Coil-on-plug electronic ignition
Mass air sensor	90 mm (3.54 in) diameter, high flow capacity
Throttle body	Twin 57 mm (2.24 in) diameter bore-simultaneously open
Supercharger	Eaton-Model 112, Generation IV, 55 kPa (8 psi) mechanical boost
Exhaust manifolds	Cast-high silicon, molybdenum iron
Exhaust system	Dual-stainless steel

Drivetrain

DRIVETRAIN

Rear axle	9.75 in limited-slip differential with 3.73:1 final drive ratio	
Driveshaft	Aluminum with hardened yoke	
Transmission	Modified 4R100 4-speed automatic with OD lockout	
Gear ratios	<i>Gear</i>	<i>Ratio</i>
	1st	2.71
	2nd	1.53
	3rd	1.00
	4th (OD)	0.71
	Reverse	2.176

OPTIONS, COLOR AND TRIM

- Tonneau cover

Exterior:

- Black Clearcoat
- Oxford White
- Sonic Blue Clearcoat
- Bright Red Clearcoat
- Dark Shadow Gray Clearcoat

Interior:

- Medium Graphite Leather/Cloth

Maintenance

MOTORCRAFT PART NUMBERS

Component	5.4L Supercharged V8 engine
Air filter element	FA-1682
Fuel filter	FG-986B
Battery	BXT-65-650
Oil filter	FL-820S
PCV valve	EV-233
Spark plugs ¹	AGSF-12FM1

¹ Refer to Vehicle Emissions Control Information (VECI) decal for spark plug gap information.

REFILL CAPACITIES

Fluid	Ford Part Name	Capacity
Brake fluid	Motorcraft High Performance DOT 3 Motor Vehicle Brake Fluid	Fill to line on reservoir
Engine oil (includes filter change)	Motorcraft SAE 5W-20 Premium Synthetic Blend Motor Oil	5.7L (6.0 quarts)
Engine coolant ¹	Motorcraft Premium Engine Coolant (green-colored) or	24.1L (25.5 quarts)
Intercooler coolant ¹	Motorcraft Premium Gold Engine Coolant (yellow-colored)	4.0L (4.2 quarts)
Power steering fluid	Motorcraft MERCON® ATF	Fill to line on reservoir
Rear axle lubricant ²	Motorcraft SAE 75W-140 High Performance Rear Axle Lubricant	3.3-3.8L (7.5-8.0 pints)
Fuel tank	N/A	94.6L (25.0 gallons)

Fluid	Ford Part Name	Capacity
Transmission fluid ³	Motorcraft MERCON® ATF	16.1L (17.0 quarts) ⁴
Windshield washer fluid	Motorcraft Premium Windshield Washer Concentrate	4.0L (4.25 quarts)

¹Add the coolant type originally equipped in your vehicle.

²Fill 6 mm to 14 mm (1/4 inch to 9/16 inch) below bottom of fill hole.

Add 118 ml (4 oz.) of Additive Friction Modifier XL-3 or equivalent meeting Ford specification EST-M2C118-A for complete refill of Traction-Lok axles.

Your vehicle's rear axle is filled with a synthetic rear axle lubricant and is considered lubricated for life. These lubricants do not need to be checked or changed unless a leak is suspected, service is required or the axle assembly has been submerged in water. The axle lubricant should be changed any time the rear axle has been submerged in water.

³Ensure the correct automatic transmission fluid is used. Transmission fluid requirements are indicated on the dipstick or on the dipstick handle. Check the container to verify the fluid being added is of the correct type. Refer to your scheduled maintenance guide to determine the correct service interval.

Some transmission fluids may be labeled as dual usage, such as MERCON® and MERCON® V. These dual usage fluids are not to be used in an automatic transmission that requires use of the MERCON® type fluid. However, these dual usage fluids may be used in transmissions that require the MERCON® V type fluid.

MERCON® and MERCON® V type fluids are not interchangeable. DO NOT mix MERCON® and MERCON® V. Use of a transmission fluid that indicates dual usage (MERCON® and MERCON® V) in an automatic transmission application requiring MERCON® may cause transmission damage. Use of any fluid other than the recommended fluid may cause transmission damage.

⁴Approximate dry fill capacity including transmission fluid cooling system, actual refill capacities will vary based on vehicle application and transmission fluid cooling system (i.e. coolers size, cooling lines, auxiliary cooler capacities). The amount of transmission fluid and fluid level should be set by the indication on the dipstick's normal operating range.

Maintenance

OCTANE RECOMMENDATIONS

Your vehicle is designed to use “Premium” unleaded gasoline with an (R+M)/2 octane rating of 91 or higher for optimum performance.

The use of gasolines with lower octane ratings may degrade performance. We do not recommend the use of gasolines labeled as “Premium” in high altitude areas that are sold with octane ratings of less than 91.

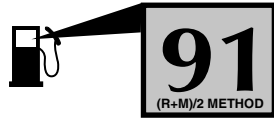

If your engine knocks under any driving conditions while you are using fuel with the recommended octane rating, see your dealer or a qualified service technician to prevent any engine damage.

WHEELS AND TIRES

Tires	295/45 ZR 18 BSW tires
Wheels	SVT-Signature style, 18 in x 9.5 in aluminum 5-spoke wheels

TIRE ROTATION

Because your vehicle’s tires perform different jobs, they often wear differently. To make sure your tires wear evenly and last longer, rotate them as indicated in the scheduled maintenance guide. If you notice that the tires wear unevenly, have them checked.

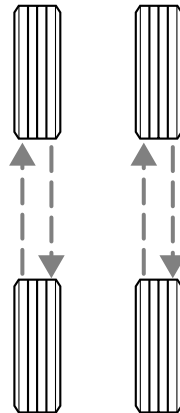

SPARE TIRE AND WHEEL

Your vehicle is equipped a 235/70R-16 spare tire on a steel wheel rim. This is for temporary use only. Replace this spare tire with a repaired road tire as soon as possible.

Child Seat Installation

ATTACHING SAFETY SEATS WITH LATCH (LOWER ANCHORS AND TETHERS FOR CHILDREN) ATTACHMENTS FOR CHILD SEAT ANCHORS (IF EQUIPPED)

Some child safety seats have two rigid or webbing mounted attachments that connect to two anchors at certain seating positions in your vehicle. This type of child seat eliminates the need to use seat belts to attach the child seat. For forward-facing child seats, the tether strap must also be attached to the proper tether anchor. See *Attaching safety seats with tether straps* in this chapter.

Your vehicle may be equipped with LATCH anchors for child seat installation at the following seating positions:

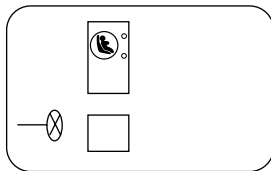

Connectors on the LATCH child seat and the child seat instructions may use the symbol shown here. Your vehicle seat may have plain buttons, instead of this symbol, to indicate the location of the LATCH lower anchors.



The lower anchors for child seat installation are located at the rear section of the seat between the cushion and seat back. The LATCH anchors are below the locator buttons (if provided) on the seat back.

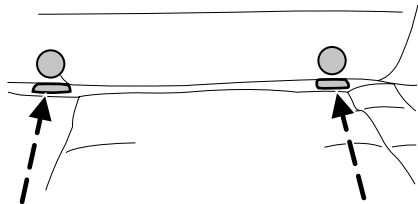

Place the passenger seat back in its upright position. Slide the passenger seat rearward to its rearmost position. Place the passenger seat back in its rearmost recline position.

Follow the child seat manufacturer's instructions to properly install a child seat with LATCH attachments.

Once child seat is attached, rotate the passenger seat back forward to its most allowable upright locked position.

Child Seat Installation



Attach LATCH lower attachments of the child seat only to the anchors shown.

If you install a child seat with rigid LATCH attachments, do not tighten the tether strap enough to lift the child seat off the vehicle seat cushion when the child is seated in it. Keep the tether strap just snug without lifting the front of the child seat. Keeping the child seat just touching the vehicle seat gives the best protection in a severe crash.

Each time you use the safety seat, check that the seat is properly attached to the lower anchors and tether anchor. Try to tilt the child seat from side to side. Also try to tug the seat forward. Check to see if the anchors hold the seat in place.



If the safety seat is not anchored properly, the risk of a child being injured in a crash greatly increases.

IMPORTANT TIRE INFORMATION

Your SVT vehicle is equipped with unique wheels and tires designed to enhance performance and appearance. To continue providing this performance, extra care must be taken when operating and maintaining your vehicle.

TIRES

Your SVT vehicle is equipped with low profile, high performance tires that are designed to optimize handling, steering and braking to provide the performance you expect in a SVT vehicle. These tires are not optimized for off-road or winter performance, and their ride, noise and wear characteristics are different than other tires. Also, because of their lower profile, the tires are more susceptible to damage due to potholes and rough or unpaved roads. To ensure that your tires perform as designed, it is important that you maintain your tires properly:

- Always maintain your tire pressures according to the tire information placard in the doorjamb or inside the fuel filler door, using an accurate gauge.
- Tire pressures are specified “cold” and should be checked after the vehicle has been parked for at least 3 hours. Do not reduce pressure of warm tires.
- Check your tire pressure often to maintain it properly. Tire pressure can diminish over time and fluctuate with temperature.
- Do not overload your vehicle. Maximum vehicle and axle weights are listed on the tire information placard.
- Extra caution should be taken when operating the vehicle near its maximum load, including assuring proper tire pressure and reducing speeds.
- Extra caution should be taken when operating on rough roads to avoid impacts that could cause tire damage.
- In the event that you encounter an abnormally harsh impact, inspect your tires for damage.
- Inspect your tires for damage on a regular basis. If a tire is damaged, replace it immediately.
- Proper suspension alignment is critical for maximum performance and optimal tire wear. If you notice uneven tire wear, have your alignment checked.
- Rotate tires as recommended in your Owner’s Guide or SVT Owner’s Guide Supplement.

Tire Information

- When replacing tires, the only way to assure original performance is to use the original equipment tire. If a different tire is used, it should be the same size, speed rating and load rating.

WHEELS

Your SVT vehicle is equipped with unique wheels matched to the tires. These wheels are more susceptible to damage due to their diameter, width and low profile tires. To avoid damage to your wheels:

- Maintain proper tire pressure (see “Tires” previously listed).
- Extra caution should be taken when using automatic car washes. Although your vehicle is capable of being washed in an automatic car wash, equipment may vary and wheel damage is possible.
- When installing wheels, always torque lug nuts to specification with a torque wrench.
- Inspect your wheels for damage on a regular basis. If a wheel is damaged, replace it immediately.
- In the event that you encounter an abnormally harsh impact, inspect the outer diameter of your wheels, both inside and out, for damage

OPERATING AT HIGH SPEEDS

Your SVT vehicle is capable of high speeds and is equipped with tires rated for the vehicles maximum speed. Remember to drive safely, obey all traffic laws and only operate your SVT vehicle at high speeds at locations equipped and designed to do so safely. Before operating your vehicle at high speeds:

- Assure correct tire pressures (see “Tires” previously listed).
- Inspect wheels and tires for wear and damage. Replace any damaged wheels or tires.
- Do not operate your vehicle at high speeds with more than two passengers or while carrying cargo.

WINTER DRIVING

The original equipment tires on your SVT vehicle are designed for maximum performance in dry and wet conditions. They are not designed for winter use on ice or snow and cannot be used with snow chains. If you be operating your vehicle in these conditions, winter or all-season tires must be used. Contact the Ford SVT Hotline at 1-800-FORD-SVT for information on SVT recommended winter tires for your vehicle. When using winter or all-season tires:

Tire Information

- Always use winter tires on all 4 wheels and use 4 of the same size, brand and model.
- Be aware that winter or all-season tires will not perform as well as the original equipment tire in dry and wet conditions. Expect handling, steering and braking to be degraded.
- Do not use a winter tire with less than a “T” rating, and even with clear, dry driving conditions do not operate your vehicle above posted speed limits while using winter tires. Never perform high-speed driving with winter tires.

A word about warranty coverage

A WORD ABOUT WARRANTY COVERAGE

The F-150 Lightning carries the same warranty coverage as other Ford F-150 models. This information is covered in its entirety in the Ford Motor Company Warranty Guide.

The F-150 Lightning or any SVT can be serviced under warranty at any Ford-Lincoln-Mercury dealer nationwide.

SVT does not recommend modifying or racing our vehicles, as they are designed and built to be driven as delivered from the factory. The Ford Motor Company Warranty Guide discusses the installation of aftermarket parts and their effect on warranty coverage as follows:

Repairs are not reimbursable under warranty when:

- “The repairs are required because of abuse, misuse, racing, fire, negligence, accident, modification or a natural disaster.”
- “The repairs are required due to installation of a non-Ford part.”