

# SUNPOWER®

## GUIDE, INSTALLATION, INVISIMOUNT®

Document Number: 508988 RevK

*JUNE 2019*

REV.	DCN#	DESCRIPTION	DATE	AUTHOR
A		Initial Release	04/01/14	J. Lentz
B	DCR-001081	Updates post beta installations.	08/06/14	J. Lentz
C	DCR-001464	Updates post limited launch.	12/29/14	J. Lentz
D	DCR-002158	Updates since limited launch, including end clamp grounding.	06/25/15	J. Lentz
E	DCR-002238	Updates including graphics, rail length optimization; UOM adjustments, remove array width limitation.	08/01/15	J. Lentz
F	DCR-002590	Updates post beta and LA County feedback.	03/11/16	J. Lentz
G	DCR-002725	Updates including R2R grounding clip, AC and DC rail clips, and Equinox parallels.	05/10/16	J. Lentz
H	DCR-003085	Updates including R2R grounding clip, R2R spacer, rail-mounted J-box, roof transition flashing; new end clamp design; removal of all AC-related content.	02/05/17	J. Lentz
I	DCR-003630	Enphase E- and X- impact language; new attachments; new rail bolts.	12/20/18	J. Lentz
J	DCR-003669	Enphase w A-Series impacts: span table, rail placement, and L-foot language; shortened document title.	03/23/19	J. Lentz
K	DCR-003691	Added Appendix E: Install Front Skirt; no other changes.	06/11/19	J. Lentz

### SUNPOWER CORPORATION

77 Rio Robles  
San Jose, California 95134  
1-855-977-7867

[www.sunpowercorp.com](http://www.sunpowercorp.com)

# SUNPOWER®



## InvisiMount® INSTALLATION GUIDE

©SunPower Corporation

All Rights Reserved

June 2019

- 1.0 Overview and Scope ..... 4
  - 1.1 Safety and Warnings..... 4
    - 1.1.1 Site Safety ..... 5
    - 1.1.2 General Warnings..... 5
  - 1.2 Installer Responsibilities ..... 5
  - 1.3 Tools, Components, and Torque Values ..... 7
    - 1.1.1 Tools ..... 7
    - 1.1.2 Components and Torque Values..... 8
- 2.0 Listings, Compatibility, and Classification ..... 12
  - 2.1 Fire Classification ..... 13
- 3.0 System Ground Path ..... 13
- 4.0 Installation Outline ..... 16
- 5.0 Install System ..... 16
  - 5.1 Module Spacing ..... 17
  - 5.2 Attachment Span and Rail Cantilever..... 17
  - 5.3 Join Rails ..... 18
  - 5.4 Install Flashings, Roof Attachments, and Rails..... 19
  - 5.5 Attach Ground Wire ..... 22
  - 5.6 Install Modules ..... 25
    - 5.6.1 Install R2R Grounding Clip ..... 30
  - 5.7 Standalone Modules..... 32
- Appendix A: Install Rail-Mounted Junction Box..... 33
- Appendix B: Install Rooftop Transition Flashing ..... 35
- Appendix C: Rail Clips ..... 41
- Appendix D: Module Removal..... 42

# 1.0 Overview and Scope

This guide describes how to install the SunPower InvisiMount® Residential Mounting System (“the system”) on a rooftop. Do not attempt any aspect of the installation until you have thoroughly read this *entire* guide. Failure to follow these instructions can result in personal injury or equipment damage or failure, and may void the system warranty.

The system includes the following standard components:

- rails
- splices and splice screws
- end clamps
- mid clamps
- ground lug assemblies (rail nut, fender washer, ground lug, and M6 bolt)
- row-to-row (R2R) spacers
- row-to-row (R2R) grounding clips

Depending on the roof type and attachment type, the following components are required and can be sourced from SunPower as well:

- L-feet
- flashings
- roof attachment

---

## 1.1 Safety and Warnings



**IMPORTANT SAFETY INSTRUCTIONS – SAVE THESE INSTRUCTIONS!**

All personnel must adhere to the following safety procedures when working on the system, including inspection, installation, operation, service work, repair, and testing. Failure to comply with these precautions or with specific warnings elsewhere in this guide may violate safety standards of design, warranty, manufacture, and intended use of the equipment. SunPower assumes no liability for failure to comply with these requirements.



**Warning!** The installation, adjustment, or repair of a solar system involves the risk of contact with potentially lethal voltages and currents.

Follow all applicable laws, including state and federal Occupational Safety and Health Administration (OSHA) standards when working on any construction project. Always reference the National Fire Protection Agency (NFPA) 70E, Handbook for Electrical Safety in the Workplace when performing electrical work.

Perform the installation in accordance with all applicable codes. In addition, reference NEC Articles 250 and 690—as well as applicable IEC standards—for proper compliance when wiring and grounding the system. All state and federal guidelines and regulations must be followed as well.

---

### 1.1.1 Site Safety

- These installation instructions are for use by qualified personnel only.
- System access is intended for authorized personnel only.
- Only authorized persons may shut down the system or open any system enclosure.
- To reduce the risk of fire, connect only to a circuit that has dedicated overcurrent protection not exceeding the maximum value stated in the product's Listing (20 A) in accordance with the NEC, ANSI/NFPA 70. **Maximum output (branch circuit) overcurrent protection: 20 A.**
- The metal components of the module can reach temperatures of approximately 176°F (80°C). Use appropriate safety procedures when handling modules.

---

### 1.1.2 General Warnings

- Do not attempt installation during conditions involving rain, snow, ice, or high winds.
- Do not attempt to install or service the system if you are not a qualified, trained electrician or technician familiar with power electronic equipment.
- Always wear rubber insulating gloves rated for the appropriate voltage level, and suitable eye and head protection when working near live electrical equipment.
- Always have a fully charged, operational cell phone available for calling emergency personnel.
- Never attempt to service any portion of the solar electric system.

Changes or modifications not expressly approved by the party responsible for compliance could void the user's authority to operate the equipment.

**Note:** Always perform all electrical installations in accordance with any local codes and the National Electrical Code (NEC).

---

## 1.2 Installer Responsibilities

**Warning!** If installing InvisiMount on a metal roof, you must first ensure that the InvisiMount system is bonded to the roof in compliance with grounding methods as required by the authority having jurisdiction (AHJ).

Installers are solely responsible for specific aspects of the system they are installing:

- Selection and verification of design parameters, including wind and snow load and all related aspects.
- Validating of third-party roof attachment design and interoperability, including any stipulations for rail overhang (cantilever) beyond the last roof attachment (standoff) at the end of a row.
- Validating the strength of the InvisiMount system relative to the design parameters.  
**Note:** SunPower span tables are only valid when used with SunPower-provided attachments.
- Code compliance and permitting.
- Vetting InvisiMount system compatibility with the installation site and structures.
- Verifying the roof integrity prior to installation.
- Selecting the correct attachment and flashing type for the particular roof.
- Care of the roof during the installation.

---

## 1.3 Tools, Components, and Torque Values

---

### 1.1.1 Tools

All applicable PPE (personal protective equipment) is always required. In addition, the following tools are required to install the system:





Tool	Task
<b>1/2" socket</b>	Attaching ground lugs.
<b>10 mm and 15 mm deep sockets</b>	Attaching L-foot nuts, mid clamps, end clamps, splices, and ground lugs, and splice screws.
<b>Caulk gun</b>	Installing rooftop transition flashing.
<b>CHANNELLOCK® pliers (or equivalent)</b>	Tightening fittings on rail-mounted j-box and rooftop transition flashing.
<b>Claw hammer</b>	Installing rooftop transition flashing.
<b>Cordless drill with step bit and hole saw</b>	Installing fasteners and drilling holes in rooftop transition flashing and rail-mounted j-box.
<b>Metal saw</b>	Cutting rails.
<b>Roofing bar</b>	Installing rooftop transition flashing.
<b>Rubber mallet</b>	Removing end clamp.
<b>Square-drive screwdriver</b>	Removing and installing rail-mounted j-box cover.
<b>Torque wrench</b>	Verifying fastener torque.
<b>Utility knife</b>	Installing rooftop transition flashing.



## 1.1.2 Components and Torque Values

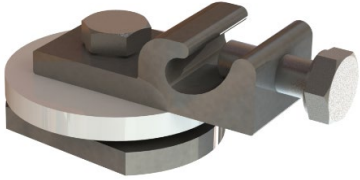

**Important!** SunPower requires that you use a torque wrench—not an *impact driver*—to enforce consistent fastener tightness, thereby ensuring safe, high-quality installations.

Term		Definition	Tool and Torque
Rail clip		Attaches to rails and helps to support wires above the lower edge of the rails.	N/A
EGC		Equipment grounding conductor for row-to-row and system grounding.	As per NEC
End clamp		Module-to-rail fastener that fits over the end of a rail, clamps to secure each of the endmost modules in a given row, and bonds modules to the rail.	<ul style="list-style-type: none"> <li>• 10 mm deep socket</li> <li>• 85 +5/-0 in-lb (9.6 N-m)</li> </ul>
Flashing		Thin sections of material that are installed between the roof substrate and any rooftop penetration in order to prevent water from penetrating the roof.  <b>Note:</b> Shown with L-foot—a separate component.	N/A

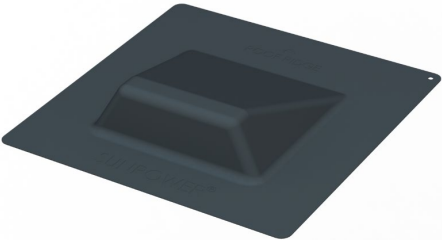

Term		Definition	Tool and Torque
<b>Ground lug assembly</b>		<p>An assembly that fits securely into the top rail channel and accommodates the equipment grounding conductor (EGC). Its machined rail nut penetrates the rail anodization to provide a bond between components.</p>	<p>For M6 bolt:</p> <ul style="list-style-type: none"> <li>• 10 mm deep socket</li> <li>• 85 +5/-0 in-lb (9.6 N-m)</li> </ul> <p>For lug screw:</p> <ul style="list-style-type: none"> <li>• 1/2" socket</li> <li>• 35 +5/-0 in-lb (4 N-m)</li> </ul> <p><b>Note:</b> Refer to Section 5.5.</p>
<b>L-foot</b>		<p>L-shaped bracket that provides interface between the roof attachment and the rail; typically made of stainless steel or aluminum.</p>	<p>Refer to the roof attachment manufacturer guidance (included with the attachment box). If using a roof attachment other than L-feet, refer to that attachment manufacturer guidance.</p>
<b>Mid clamp</b>		<p>Module-to-rail fastener that attaches in the top rail channel; secures module frames; and bonds modules to the rail throughout a row.</p>	<ul style="list-style-type: none"> <li>• 10 mm deep socket</li> <li>• 85 +5/-0 in-lb (9.6 N-m)</li> </ul>
<b>Rail</b>		<p>Extruded aluminum component that attaches to the L-feet and supports clamped modules. Each rail section is 10.76' (129.13" or 3.28 m) long.</p>	<p>For the nuts that fit onto the bolts which slide into the side channel:</p> <ul style="list-style-type: none"> <li>• 15 mm deep socket</li> <li>• 375 +20/-0 in-lb (42 +2/-0 N-m)</li> </ul>

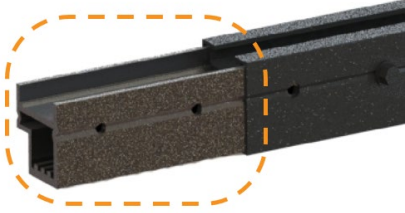
Term		Definition	Tool and Torque
<b>Rail-mounted J-box</b>		Junctions array circuits on the roof; attaches to the rail with no tools.	For cover screws: <ul style="list-style-type: none"> <li>• #2 square-drive screwdriver</li> <li>• 16 in-lb (1.8 N-m)</li> </ul>
<b>Rooftop transition flashing (optional)</b>		Installs on the rooftop and enables the array wiring to transition to the building wiring.	<ul style="list-style-type: none"> <li>• Utility knife</li> <li>• Roofing bar</li> <li>• Caulk gun</li> <li>• Claw hammer</li> <li>• Drill with step bit and hole saw bit</li> <li>• Two CHANNELLOCK® tongue &amp; groove pliers (or equivalent)</li> </ul>
<b>Row-to-row (R2R) grounding clip</b>		Attaches between module <b>rows</b> and enables the ground path to continue from one row to the adjacent row.	<ul style="list-style-type: none"> <li>• 10 mm deep socket</li> <li>• 85 +5/-0 in-lb (9.6 N-m)</li> </ul>
<b>Row-to-row (R2R) spacer</b>		Plastic spacer that snaps into the exterior module frame and uniformly enforces the distance between rows of adjacent modules.	N/A

Term		Definition	Tool and Torque
<b>Splice</b>		Extruded aluminum connector that, along with splice screws, joins two rails.	Refer to <b>splice screw</b>
<b>Splice screw</b>		Black oxide coated stainless steel fastener that, in conjunction with a splice, attaches two sections of rail together.	<ul style="list-style-type: none"> <li>• 10 mm deep socket</li> <li>• 40 +5/-0 in-lb (4.5 N-m)</li> </ul> <p><b>Note:</b> Refer to Section 5.3.</p>

## 2.0 Listings, Compatibility, and Classification

The SunPower InvisiMount Residential Mounting System is UL 2703 Listed. The InvisiMount Listing **includes** the following SunPower InvisiMount-compatible modules, **which are the only modules that are compatible with the InvisiMount system:**

DC Modules	AC Modules	
<ul style="list-style-type: none"> <li>• SPR-X22-370</li> <li>• SPR-X22-360</li> <li>• SPR-X21-350-BLK</li> <li>• SPR-X21-335-BLK</li> <li>• SPR-X21-345</li> <li>• SPR-E20-327</li> <li>• SPR-E19-320</li> </ul>	<ul style="list-style-type: none"> <li>• SPR-X22-370-E-AC</li> <li>• SPR-X22-360-E-AC</li> <li>• SPR-X21-350-BLK-E-AC</li> <li>• SPR-X21-335-BLK-E-AC</li> <li>• SPR-X20-327-BLK-E-AC</li> <li>• SPR-X21-345-E-AC</li> <li>• SPR-X21-335-E-AC</li> <li>• SPR-X20-327-E-AC</li> <li>• SPR-E20-327-E-AC</li> <li>• SPR-E19-320-E-AC</li> </ul>	<ul style="list-style-type: none"> <li>• SPR-A425-G-AC</li> <li>• SPR-A415-G-AC</li> <li>• SPR-A400-G-AC</li> <li>• SPR-A390-G-AC</li> </ul>

Grounding from the module to the rail is accomplished through both the mid clamp and end clamp. The Listing also includes the following components, which have been evaluated for both mounting and bonding in accordance with UL 2703:

- end clamp
- mid clamp
- rail
- splice and splice screw
- ground lug assembly
- L-foot
- row-to-row (R2R) grounding clip
- row-to-row (R2R) spacer

---

## 2.1 Fire Classification

- The maximum distance between the roof deck and the bottom of the module frame is 3" (7.6 cm).
- In order to maintain the system classification, this assembly must be mounted over a fire resistant roof covering for the application.
- The system achieves a Class A fire rating when installed with modules having a Type 2 fire classification; or for modules specifically fire tested with the InvisiMount system.
- The system achieves a Class A fire rating when installed in the manner specified in these instructions.
- The system was evaluated for use on roofs having a pitch  $\geq 2$ "/foot (greater than or equal to 2:12).

## 3.0 System Ground Path

The InvisiMount system features:

- Integrated module-to-rail as well as adjacent-module bonding (achieved through the mid clamp and end clamp).
- Integrated rail-to-rail bonding (achieved through the self-drilling splice screws and the splice).
- System bonding achieved through the equipment ground conductor (EGC).

For arrays where the installer chooses to use row-to-row (R2R) grounding clips (refer to Section 5.6.1) instead of additional ground lugs and copper wire, system bonding is achieved through the R2R clips.

The following two diagrams illustrate the key grounding and bonding aspects of the InvisiMount system with and without the R2R grounding clip:

- the system ground path
- each component
- each bonding point
- the applicable NEC and UL references

## SunPower InvisiMount™ Ground Path and Compliance

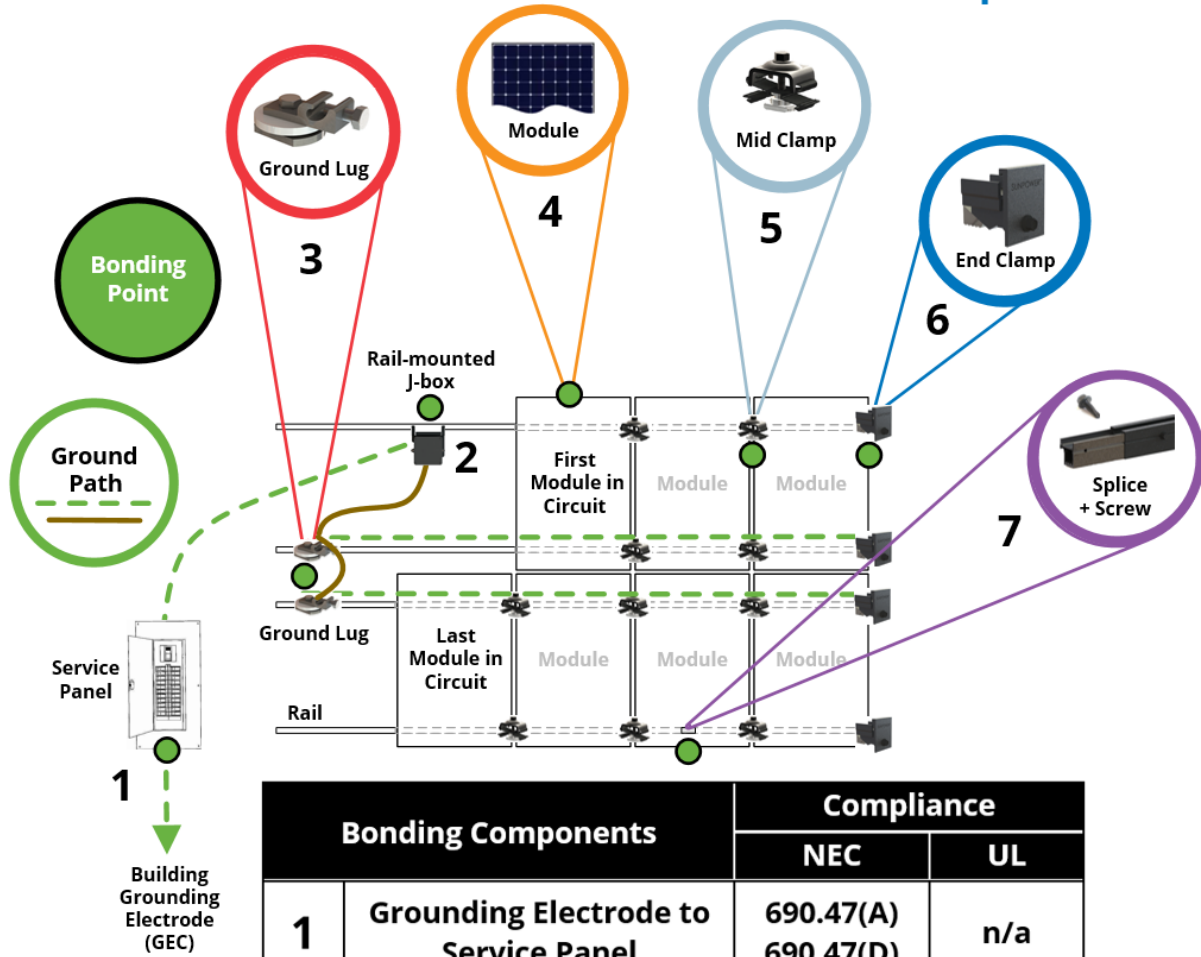

Bonding Components		Compliance	
		NEC	UL
1	Grounding Electrode to Service Panel	690.47(A) 690.47(D)	n/a
2	Service Panel to Ground Wire	690.43(C)	1741
3	Ground Wire to Ground Lug to Rail	690.43(C)	2703
4	Module Frame	n/a	1703
5	Rail to Mid Clamp to Module Frame	690.43(A) 690.43(C) 690.43(D)	2703
6	Module Frame to End Clamp to Rail	690.43(A) 690.43(C) 690.43(D)	2703
7	Rail to Splice	690.43(A) 690.43(C) 690.43(D)	2703

## SunPower InvisiMount™ with R2R Grounding Clip Ground Path and Compliance

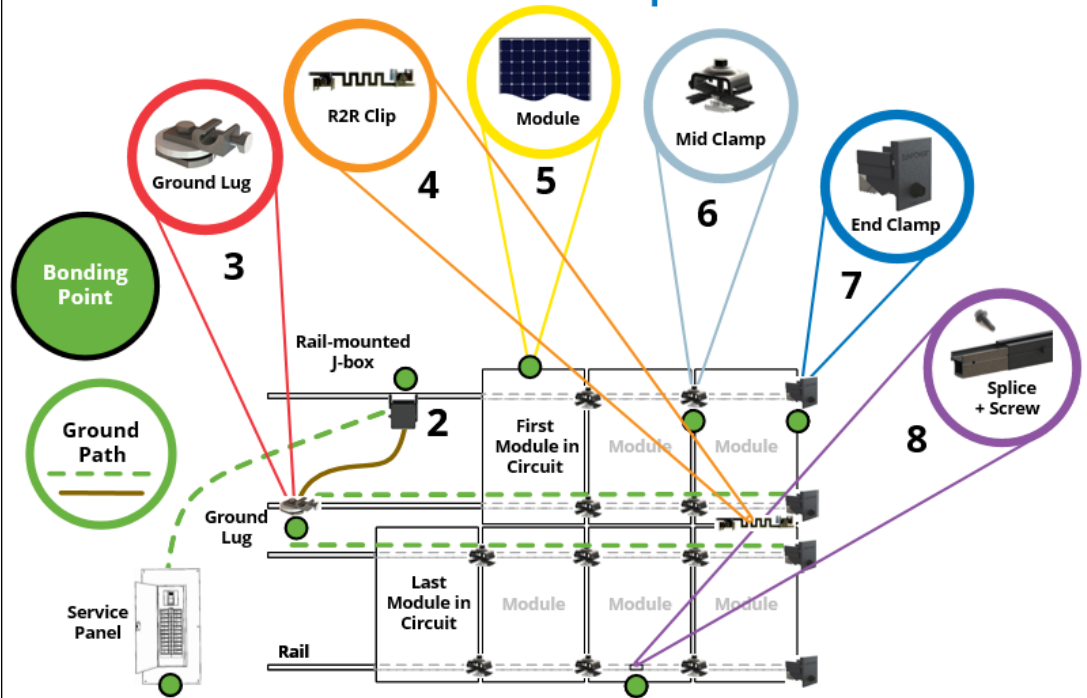

Bonding Components		Compliance	
		NEC	UL
1	Grounding Electrode to Service Panel	690.47(A) 690.47(D)	n/a
2	Service Panel to Ground Wire	690.43(C)	1741
3	Ground Wire to Ground Lug to Rail	690.43(C)	2703
4	Module Frame to Module Frame	690.43(C)	2703
5	Module Frame	n/a	1703
6	Rail to Mid Clamp to Module Frame	690.43(A) 690.43(C) 690.43(D)	2703
7	Module Frame to End Clamp to Rail	690.43(A) 690.43(C) 690.43(D)	2703
8	Rail to Splice	690.43(A) 690.43(C) 690.43(D)	2703

## 4.0 Installation Outline

1. Mark the array layout on the roof surface.
2. Install flashings (if part of your chosen attachment solution) and roof attachments.
3. Join and install rails.
4. Attach ground wire.
5. Install modules.

## 5.0 Install System

These instructions describe attaching the rails parallel to the peak (“E-W”). The rail length accommodates SunPower modules as follows:

Size	Orientation	Number of Modules per Rail Section
96 cell	Portrait	3
	Landscape	2
72 cell	Portrait	4
	Landscape	2
66 cell	Portrait	3
	Landscape	1.8

Your array should be fully designed and all required permitting obtained before you begin. The SunPower Design Tool—or the SunPower Span Tables—determine the actual span between attachments for a given system.

Designers can access the Tool by logging into the Partner Portal and then clicking the *Design Tool* link. The Tool yields all the racking-specific structural calculations that can then be provided to the AHJ and that are typically part of the permitting process. **Ensure that you bring the PDF file from the Design Tool output to the site!**

It is acceptable to attach either to the rafters or to the roof deck. SunPower recommends the following attachments:

- For comp shingle roofs: InvisiMount Comp Shingle Attachment with Pegasus (531766)
- For tile roofs:
  - InvisiMount Flat Tile Attachment with Pegasus Tile Replacement (532911)
  - InvisiMount S-Tile Attachment with Pegasus Tile Replacement (532910)
  - InvisiMount W-Tile Attachment with Pegasus Tile Replacement (532912)

Instructions for installing the attachments are included with their packaging.



---

## 5.1 Module Spacing

The spacing between the modules shall be as follows:

- Intra-row spacing (side to side in a typical row): spacing is governed and enforced when the mid clamps are installed, and is 0.8" (20 mm).
- Row-to-row spacing (between an upper and a lower row in a typical array); spacing is governed and enforced when the row-row (R2R) spacers are installed, and is 0.8" (20 mm).

---

## 5.2 Attachment Span and Rail Cantilever

The maximum distance (span) between roof attachments (L-feet or other attachment type) is 8' (2.4 m).

The maximum rail overhang distance (cantilever) is 24" (61 cm). Refer to the InvisiMount Span Tables for allowable span and cantilever relative to your design requirements.

**Note:** A spliced rail does not require any special allowance for span nor cantilever.

## 5.3 Join Rails

Depending on the roof slope, you may instead decide to join rails on the ground before transporting them to the rooftop. The rails and the splices have pre-drilled holes for the splice screws. You install *one* screw in each end of the splice (one screw per rail, furthest from its end) (Fig. 1).

**Important!** The splice is an integral part of the ground path. There must be no interference between the splice screws and the L-feet. Therefore, ensure that the splice screws will not interfere with your eventual attachment of the rail to the L-foot (refer to Fig. 5 and Fig. 6).

1. Fit a splice halfway into a rail end, align the splice hole with the rail hole, secure the components so that they will not move, and then drive a splice screw through the aligned hole *stopping 1/3 turn after the screw face has contacted the rail face* (Fig. 2). This method provides 40 +5/-0 in-lb (4.5 N-m) of torque. Use a torque wrench to verify and (if necessary) apply final torque to each screw.

Splice screws are single use. If a screw becomes dull or prevents smooth, consistent penetration of the splice, use a new screw in the original hole. If a screw breaks, use the other hole that is provided—*do not reuse the original hole*. Ensure that you deburr the new hole.

2. Fit the second rail all the way onto the splice protruding from the first rail, align the respective holes, and install the second screw.

The rail holes and splice holes *must be* aligned; the rail ends are *not* required to be in contact with each other. The maximum distance between a spliced rail pair is 1/4" (6.4 mm).

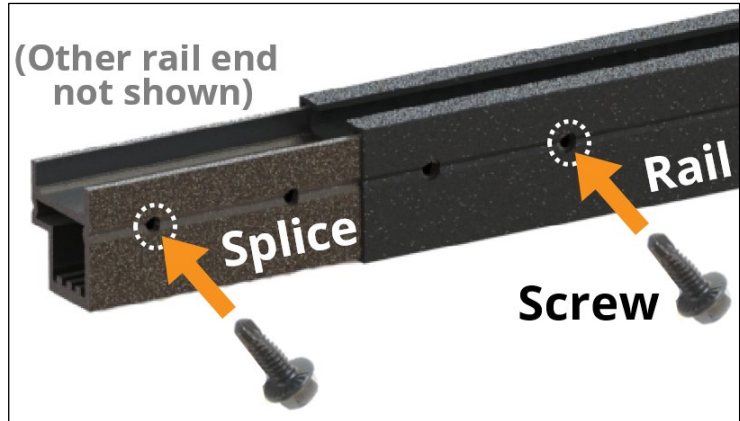

Fig. 1

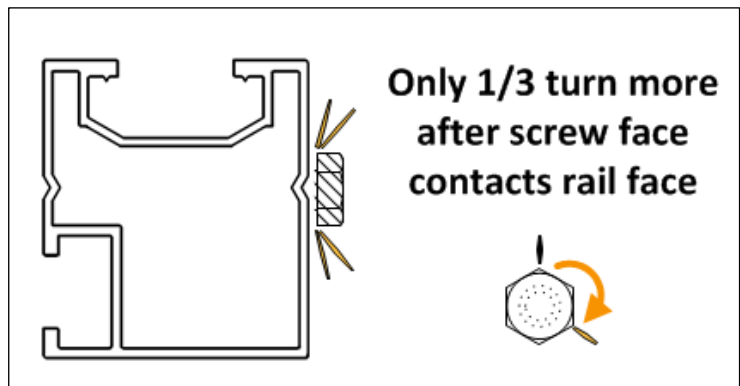

Fig. 2

## 5.4 Install Flashings, Roof Attachments, and Rails

1. Define the installation zone and array layout on the rooftop and mark it for penetrations as necessary.
2. Referring both to the flashing (if appropriate for the roof type) and to the attachment manufacturer guidance:
  - a. Install the flashings and the roof attachments.
  - b. Attach an L-foot to each of the roof attachments according to the method described by the attachment manufacturer guidance. *Leave the hardware finger-tight for the moment.*
3. Position the rails on the roof, adjacent to the L-feet.  
For aesthetic purposes, SunPower recommends that you install the rails with their side channel *facing* the roof peak (Fig. 3 and Fig. 4), but you may install rails with their side channel facing the eave instead.

**Important!** To ensure precise alignment with the finished array's footprint (perimeter), cut rails only *after* you have adjusted them to an even height and fully secured them to the attachments.

**Important!** For your roof attachment strategy, remember that a spliced rail is the same as a solid rail in that **a spliced rail does not require any special allowance in terms of overhang or attachments.**

4. Position the rail adjacent to and "below" (relative to the peak) the L-feet for the given row (Fig. 4).



Fig. 3

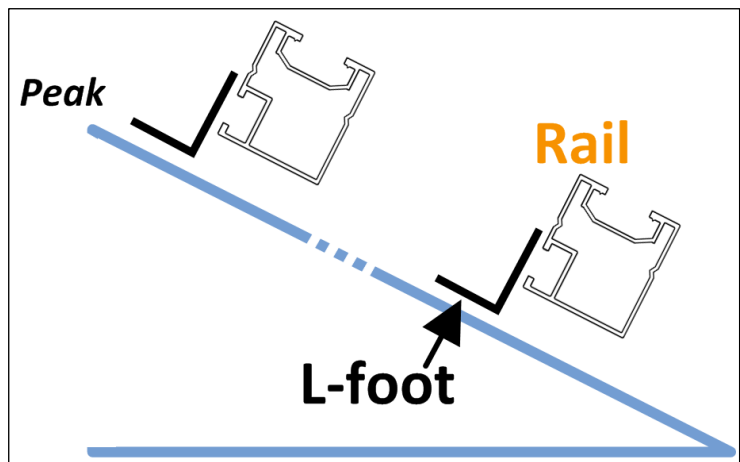

Fig. 4

**Note:** L-feet are shown “facing” the peak (Fig. 4 and Fig. 5), but may be installed facing the eave instead.

L-feet (or any other attachment type) must be positioned such that the L-foot-to-rail bolt is a minimum of 2" (5 cm) from the end of a rail (Fig. 5); and a minimum of 2" (5 cm) from any rail joint (Fig. 6).

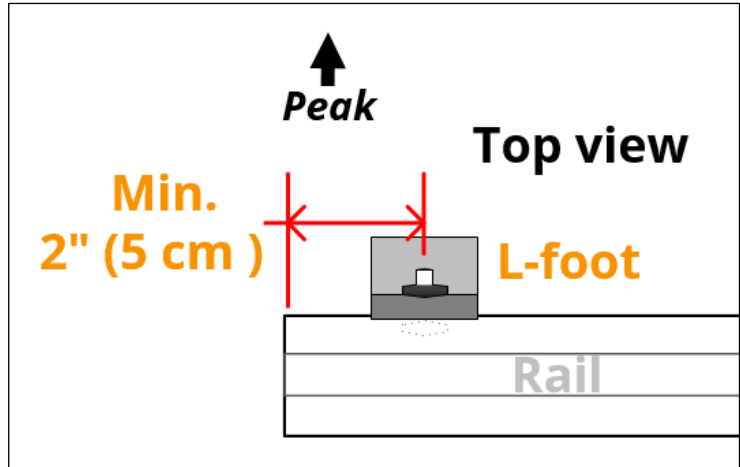

Fig. 5

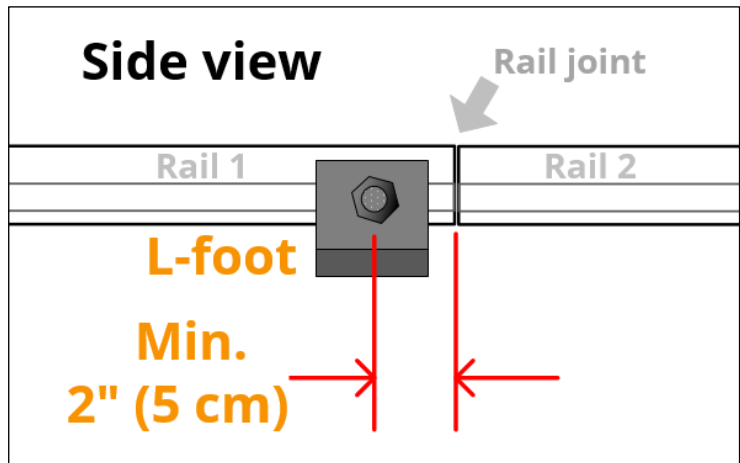

Fig. 6

- Attach the rail to each L-foot by inserting the T-head of the rail bolt into the side channel and then turning it to the right 90° (until you feel it seat) (Fig. 7), then fitting the bolt ends through the slots on the L-feet.
- Temporarily* finger-tighten an M10 nut on each of the bolts. (You apply torque to these nuts in Step 9.)



**Best Practice:** Position each bolt at the midpoint of the vertical slot in its L-foot (Fig. 8). This will provide the greatest vertical adjustment flexibility.

- To ensure that the installed modules will appear as an even plane, SunPower recommends that you use a string line and level (or other method) to ensure that the top surface of the rails is even (Fig. 9).
- After you are satisfied that the rails are level, tighten each L-foot nut to 375 +20/-0 in-lb (42 +2/-0 N-m).
- Tighten all of the L-foot-to-roof-attachment hardware according to the attachment manufacturer guidance. (If you are not using L-feet, tighten the attachment hardware according to the attachment manufacturer guidance.)

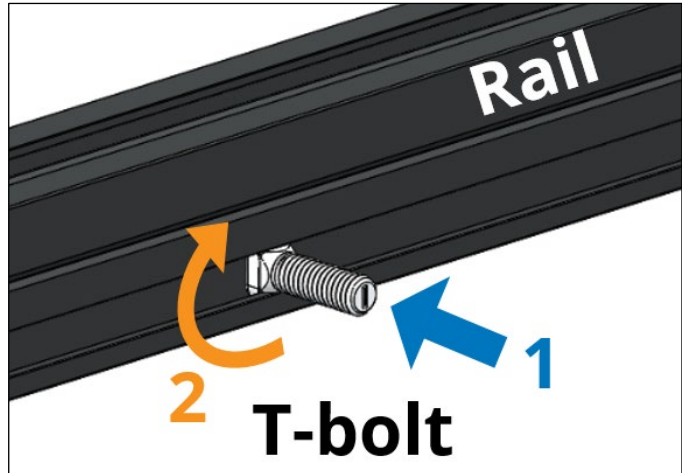

Fig. 7

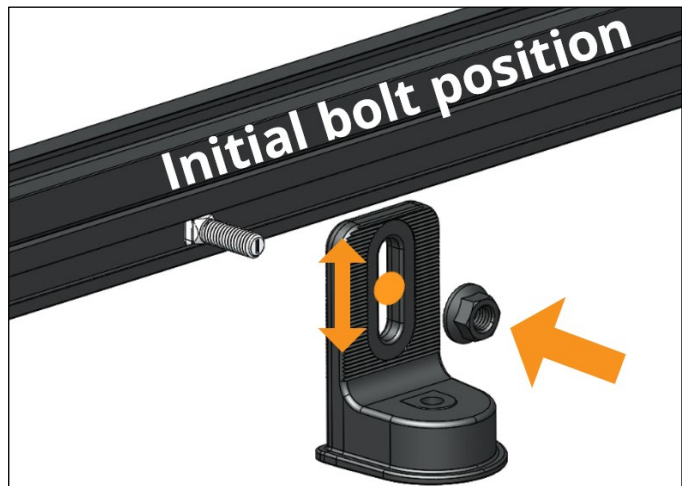

Fig. 8

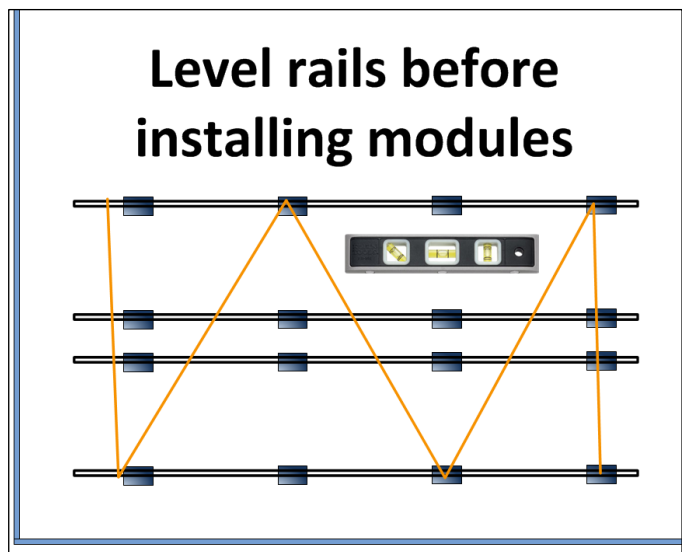

Fig. 9

## 5.5 Attach Ground Wire

For arrays with two or more rows, in order to achieve row-to-row grounding, you must install either:

- one ground wire, one ground lug assembly, and an R2R grounding clip (Fig. 10 and Section 5.6.1)

**Note:** An R2R grounding clip is required between each row pair—e.g. a three-row array would require two R2R clips.

**or**

- two ground wires and two ground lug assemblies (Fig. 11)

If your array has a standalone module (refer to Section 5.7), you must install a ground lug assembly on one of its rails as well.

**Important!** Ensure that you install the system such that the copper ground wire will never contact any aluminum! (Refer to Fig. 16.)

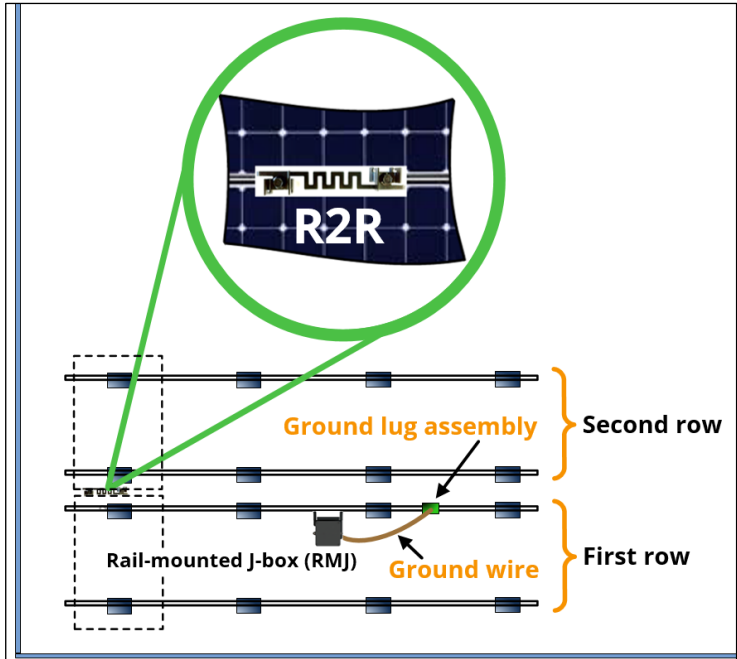

Fig. 10

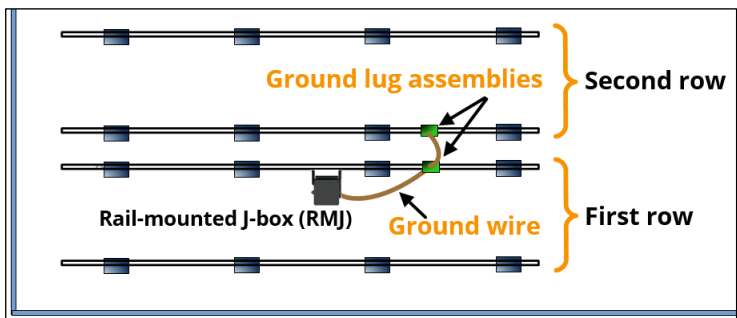

Fig. 11

1. Slide the lug's rail nut (Fig. 12) into the end of the top channel of a rail and position it where you want to attach the ground wire (you can disassemble the ground lug first if necessary).



Fig. 12

2. Position the washer directly over the rail nut (Fig. 13), and then use the M6 bolt to attach the lug to the rail nut by first orienting the lug parallel to the array (Fig. 14), finger-tightening the M6 bolt, and then using a 10 mm deep socket to apply an additional 5/6 of a turn *only* (Fig. 15). Doing so provides 85 +5/-0 in-lb (9.6 N-m) of torque. **After tightening in this manner, verify the value with a torque wrench.**

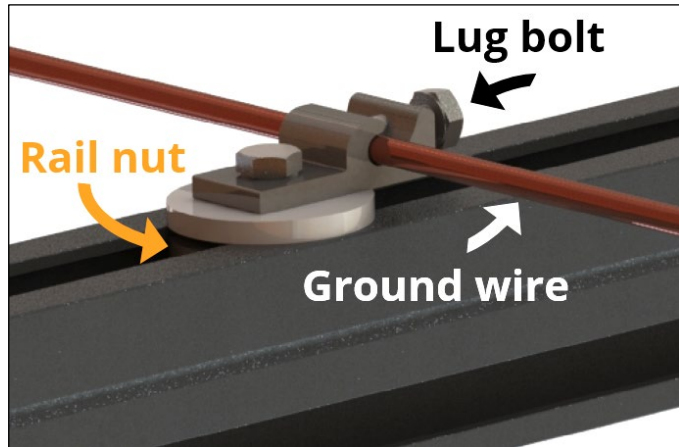

Fig. 13

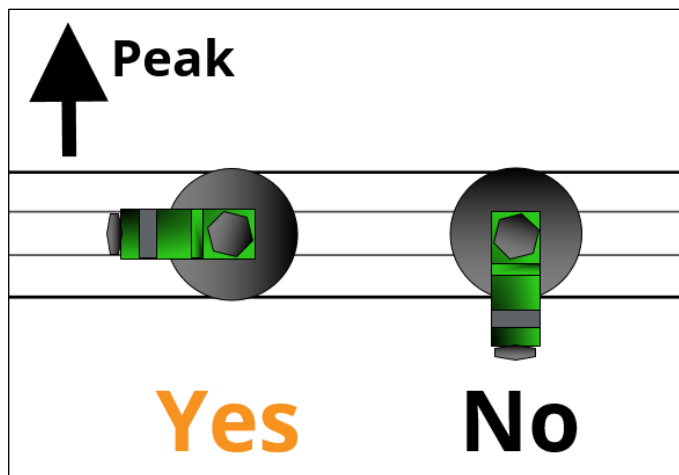

Fig. 14

3. Attach the copper ground wire to the lug as per NEC. Tighten the lug bolt (refer to Fig. 13) to 35 in-lbs (4 N-m).

As you add modules, reposition the ground wire as necessary such that it will remain below the module frames but above the rails *and will never contact the module frames or the rails!*

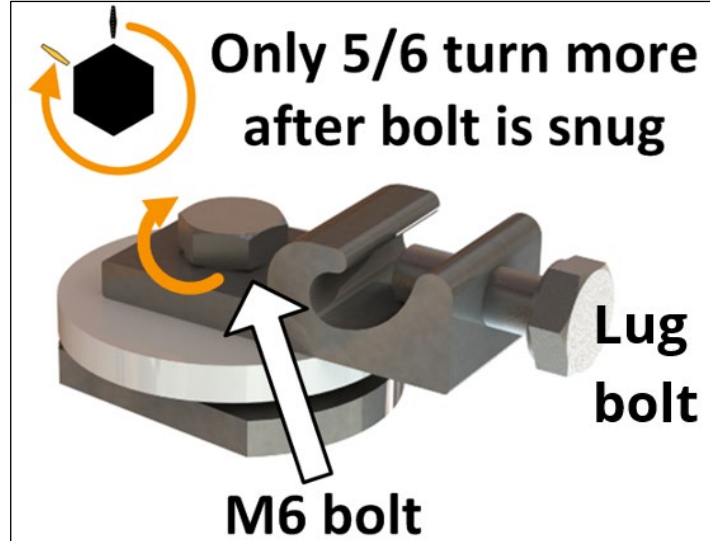

Fig. 15

4. Following standard construction practices and the NEC, connect the array ground wire to the building's ground.

**Warning!** The ground wire must never be any closer to any other metal than 1/4" (0.6 cm) (Fig. 16).

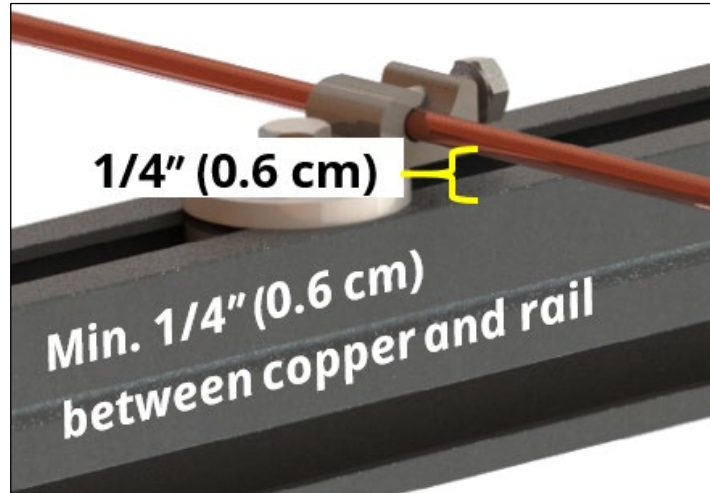

Fig. 16



## 5.6 Install Modules

**Important!** If you are installing the rail-mounted J-box (Appendix A), do so now before installing modules. If your wire management strategy includes the rail clips (Appendix C), it is easiest to install them before you install modules.

**Always check the SunPower Span Tables before committing to rail placement.** Rails may be positioned in the green (non-crosshatch) regions only, as follows:

Size	Tolerances
<b>96 cell</b> (Fig. 17 and Fig. 18)	<ul style="list-style-type: none"> <li><b>Short side:</b> Minimum of 2" (5 cm) but not more than 15" (38 cm) from any module corner.</li> <li><b>Long side:</b> Minimum of 2" (5 cm) but not more than 16" (40 cm) from any module corner.</li> </ul>
<b>72 cell</b> (Fig. 19 and Fig. 20)	<ul style="list-style-type: none"> <li><b>Short side:</b> Minimum of 2" (5 cm) but not more than 10" (25 cm) from any module corner.</li> <li><b>Long side:</b> Minimum of 2" (5 cm) but not more than 16" (40 cm) from any module corner.</li> </ul>
<b>66 cell</b> (Fig. 21 and Fig. 22)	<ul style="list-style-type: none"> <li><b>Short side:</b> Minimum of 2" (5 cm) but not more than 13" (33 cm) from any module corner.</li> <li><b>Long side:</b> Minimum of 11" (28 cm) but not more than 28" (71 cm) from any module corner.</li> </ul>

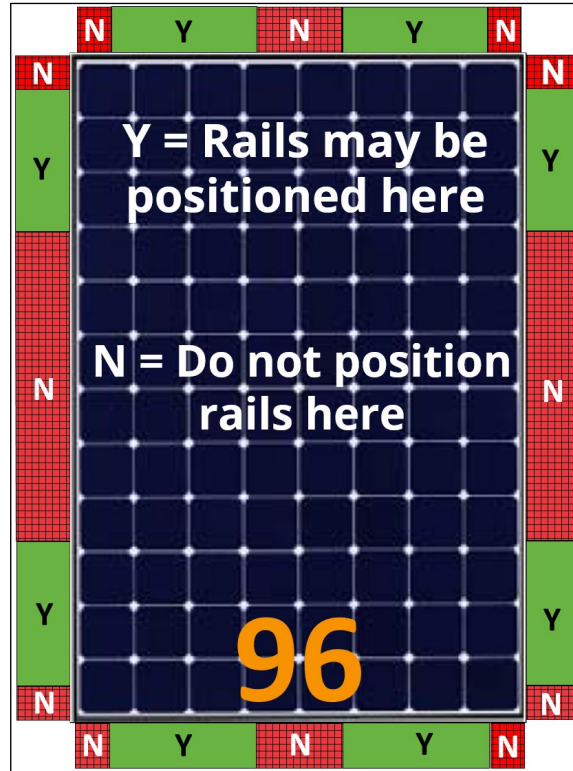

Fig. 17

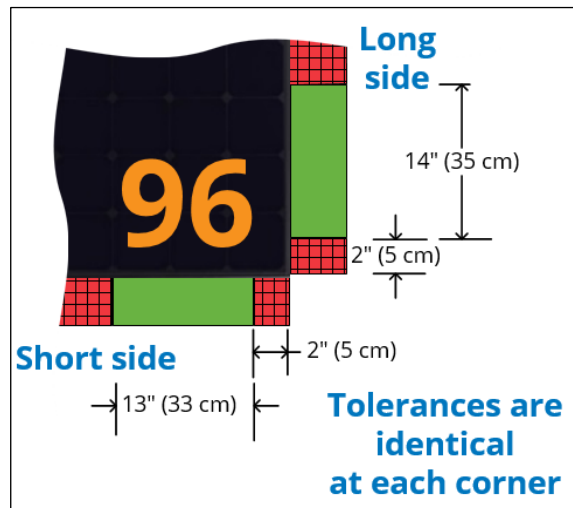

Fig. 18

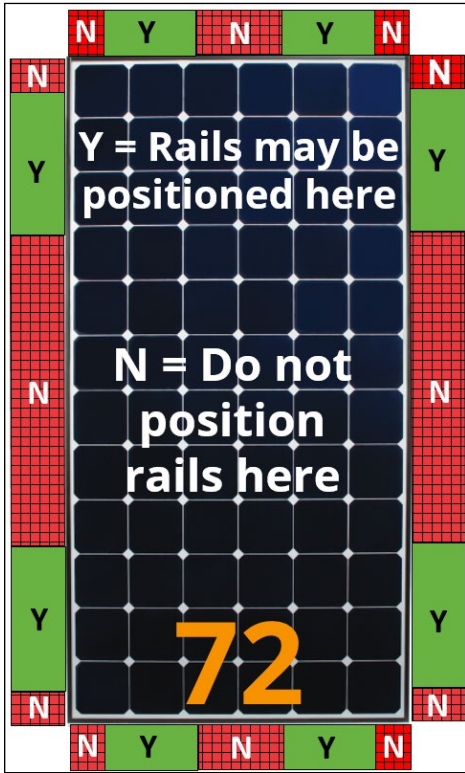

Fig. 19

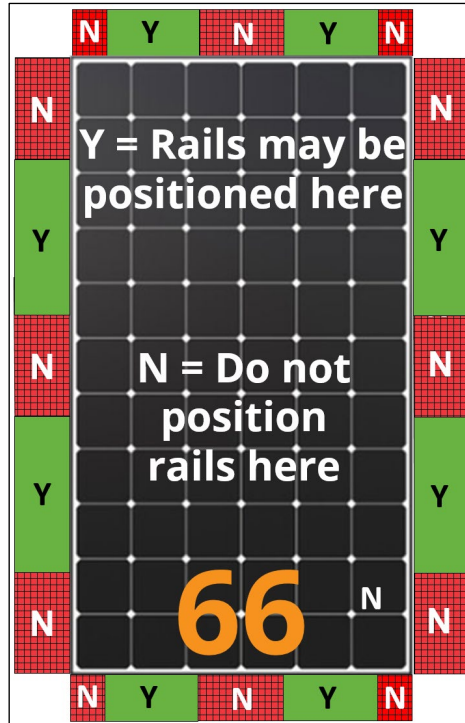

Fig. 21

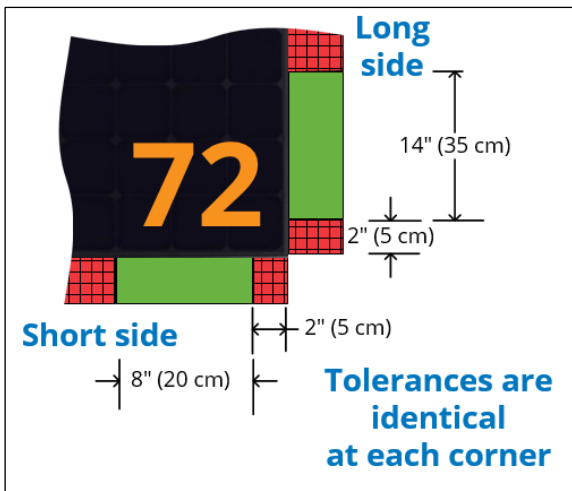

Fig. 20

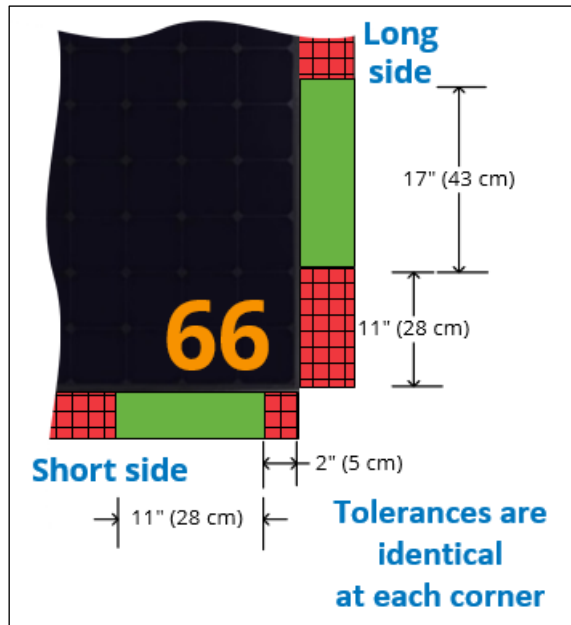

Fig. 22

**Warning!** Do not step on, stand on, or walk on the modules or the module frames, and **do not place anything on them**—even for a moment.

1. Position the first module of the row atop and at the end of the rails.
2. With the SunPower logo upward, insert an end clamp into each of the rail ends by holding the clamp with your thumb and middle finger, and pressing on the bolt head with your index finger as you slide the clamp as far into the rail as possible (Fig. 23). If the clamp does not slide in easily, push on the bolt head.

3. Fit the top lip of the end clamp cover up and over the bottom edge of the module frame (Fig. 24). Do this for both end clamps.

Verify correct module position and full end clamp engagement, and then tighten each end clamp bolt to  $85 +5/-0$  in-lb (9.6 N-m) with a 10 mm socket.

**Note:** If you need to remove an end clamp, first loosen its bolt two turns and then tap on its bolt head to free its engagement mechanism.

4. Fit one mid clamp down into the top channel of each of the row's two rails, rotate it 90° (Fig. 25), and slide it toward the first module. Leave the two mid clamps loose for now.
5. Position the second module next to the first module.
6. For each of the two mid clamps: fit one side (two teeth) of each clamp over the respective adjacent frame edge of each of the two modules (the first and second modules) (Fig. 26; second module not shown).

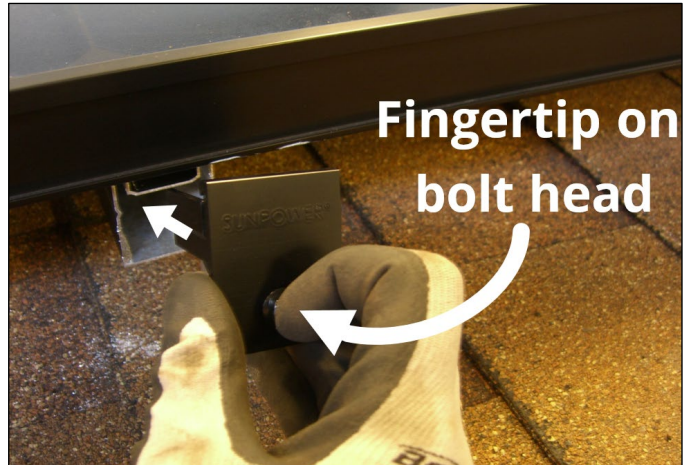

Fig. 23

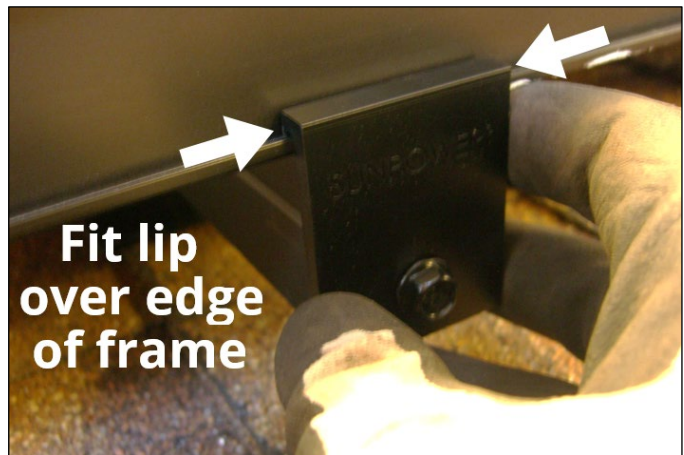

Fig. 24



Fig. 25



7. Tighten each of the two mid clamps to  $85 +5/-0$  in-lb (9.6 N-m).

**Important!** Each mid clamp's four teeth must solidly engage the module frames to ensure continuity of the module-rail ground path (Fig. 26).

8. Repeat Steps 4–7 until you have installed all except for the last module in the row.
9. For the last module in the row, position it on the rails in the desired location, and then mark a cut line on each of the rails at the module edge (Fig. 27).
10. Remove the module to ensure it is not damaged in the cutting process, and then cut the rails along the lines you marked.

**Important!** The maximum distance the module is permitted to overhang the rail is  $1/4"$  (0.6 cm) (Fig. 28).

11. Place the module in position again and then add its two mid clamps (which also secure the second-to-last module in the row), tightening them as you did in Step 7.
12. Add and tighten the last module's two end clamps as you did in Steps 2–3.

**If you're installing a second row**, you must add two row-to-row (R2R) spacers to the upper edge of *each* of the completed first row's modules.

**Note:** These instructions assume that any second row you add will be "above" the first row (between the peak and the first row).

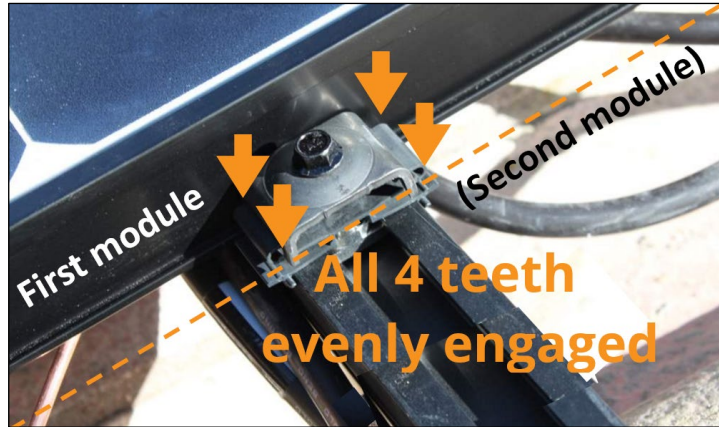

Fig. 26



Fig. 27



Fig. 28

13. For each of the modules in the first row, fit two R2R spacers in its upper frame edge, one each approximately 8" (20 cm) from each upper frame corner (Fig. 29 and Fig. 30).

**Note:** When installing the R2R grounding clip to achieve row-to-row grounding (Section 5.6.1), it is acceptable to shift the position of the spacer nearest the grounding clip *just enough* to correctly install the R2R clip—but you must still install **two** spacers on the module that engages the R2R clip.

14. Repeat Steps 1–12 to fully install the second row, allowing the second row's modules to gently rest evenly on the spacers.

**Note:** The spacers provide no structural support for the modules. *Leave the spacers in place after module installation.*

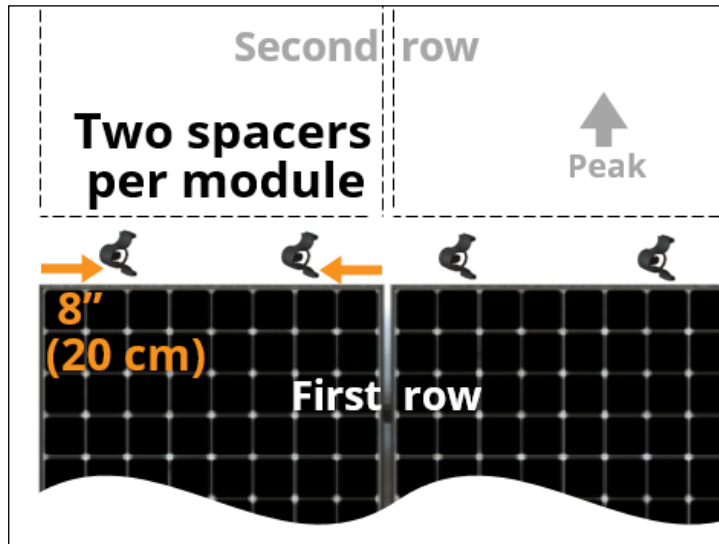

Fig. 29



Fig. 30

## 5.6.1 Install R2R Grounding Clip

**Note:** Refer to Section 5.5.

The R2R grounding clip can be installed even **after you have built the array**. The R2R spacers enforce the correct spacing to enable easy installation of the R2R grounding clip even after the array is complete.

The row-to-row (R2R) grounding clip provides a grounding path between adjacent rows of modules that are not mounted on the same rail pair.

The R2R grounding clip is not applicable for arrays that consist of a single row.

You must still connect one ground lug to one of the rails in the first row, and run the copper ground wire to it so that its electrical bond will transfer to the other rows through the R2R clip (refer to Fig. 10).

1. The R2R clip has two threaded bosses with bolts (Fig. 31). Fit the R2R clip (with bolt heads up) between one row-end module in the first row and the adjacent module in the second row; 8" (20 cm) from the end of the row (Fig. 32 and Fig. 33).

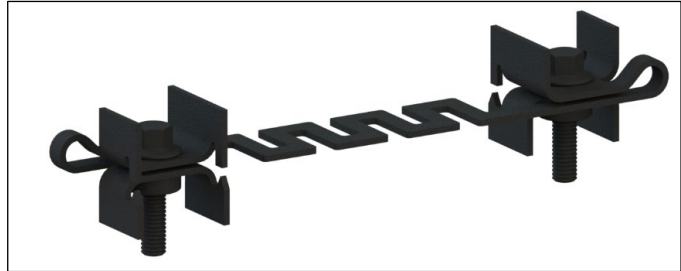

Fig. 31

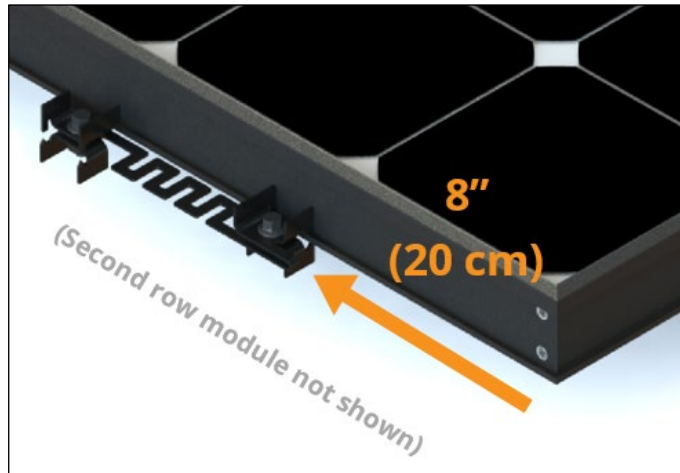

Fig. 32

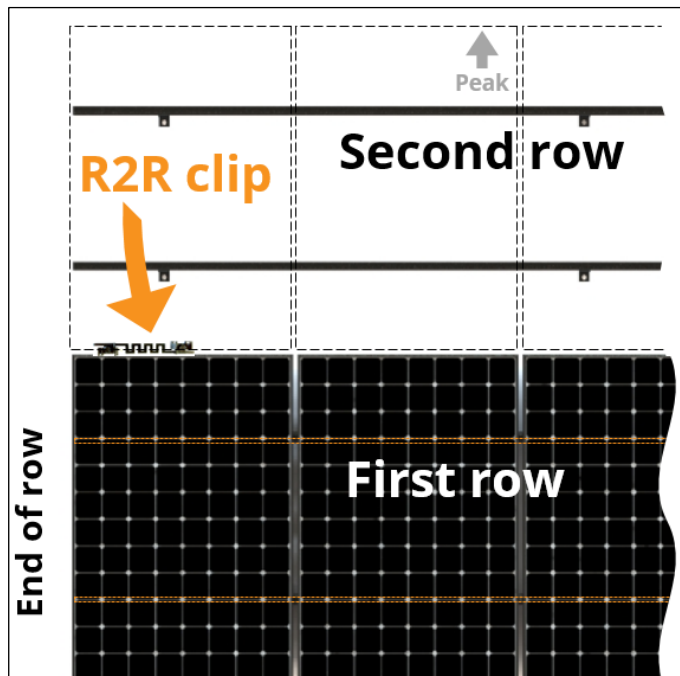

Fig. 33

2. Ensure that the both jaws of the clip fit over the respective module frames fully (Fig. 34).
3. Tighten the first-row bolt (the outer one, nearest the module corner) to  $85 +5/-0$  in-lb (9.6 N-m), so that the clip firmly clamps onto the module frame.
4. Tighten the second-row bolt (the inner bolt) on the R2R clip to as described in Step 3.

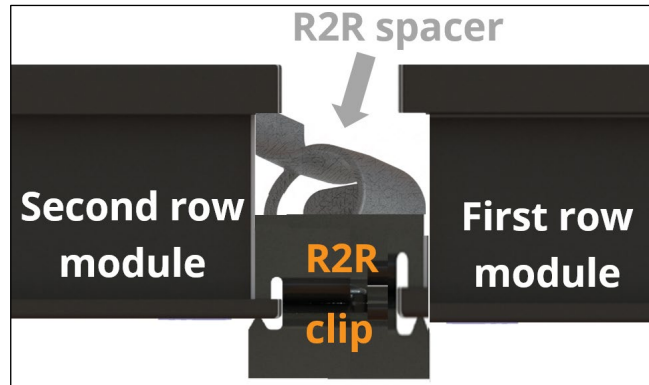

Fig. 34

## 5.6.2 Standalone Modules

Any module in an array that will not include mid clamps as part of its mounting hardware is considered a “standalone module.” Typically a standalone module arises when an array has a module “missing” in order to accommodate a rooftop feature or obstruction, or when an array forms a “pyramid” shape and the topmost (or bottommost) row contains only a single module.

You must ground a standalone module as if it were its own row, and you must do so in one of the following two ways:

- Attach a ground lug assembly to one of its rails (Fig. 35), and route the copper ground wire to it.

**OR**

- Install another R2R grounding clip (Fig. 36; refer to Section 5.6.1).

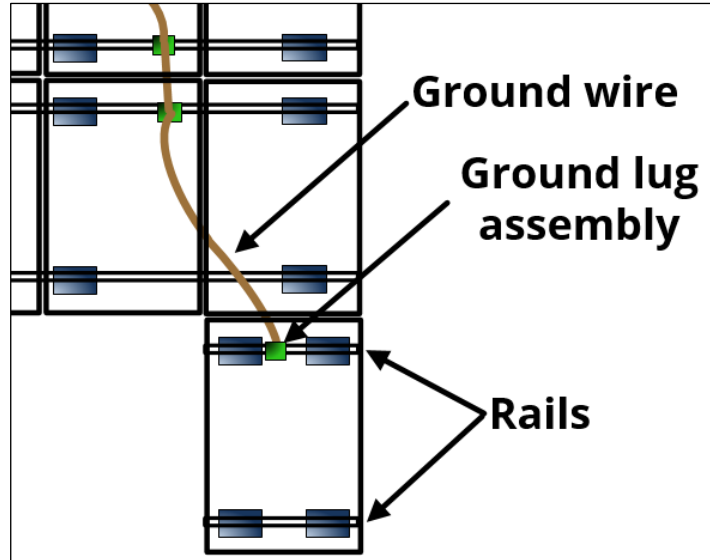

Fig. 35

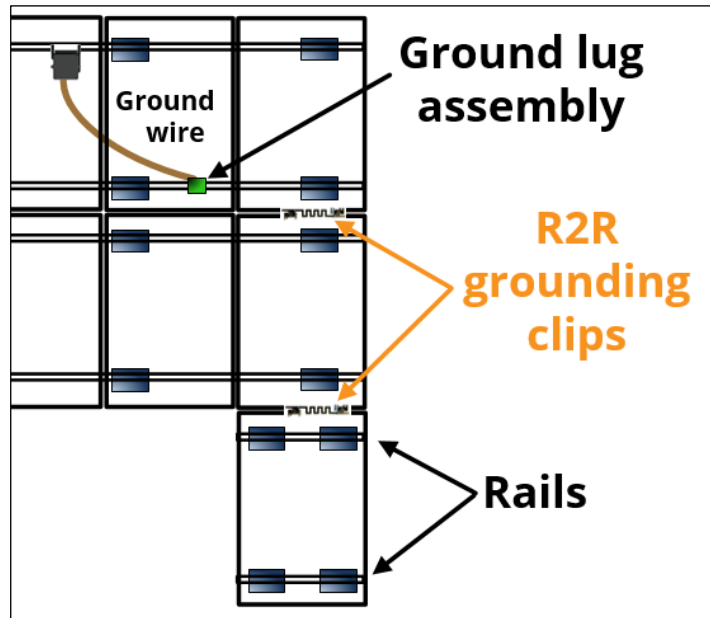

Fig. 36



# Appendix A: Install Rail-Mounted Junction Box

If you decide to use the rail-mounted J-box (RMJ), install it *before* you install modules.

**Important!** Only glands and fittings that have gaskets and that are suitable for wet locations may be used.

1. Determine the location for the RMJ. You can mount the RMJ “above” or “below” the rail (Fig. A1).

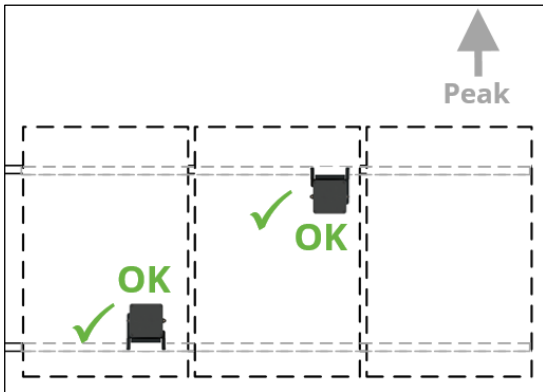

Fig. A1

2. According to your wire management strategy, determine, mark, and drill out the necessary entry locations on the sides of RMJ (do not drill the cover).

3. Drill a weep hole (min. 1/8"; max. 1/4") in the RMJ at its lowest point.

**Note:** SunPower provides one Heyco 3/4" cable gland; the maximum conduit size is 1".

4. Install glands or conduit fittings in the RMJ. If you're using a provided cable gland, torque its locknut to 40 +5/-0 in-lb (4.5 N-m).

**Important!** Do not mount conduit or glands to the box cover.

5. Fit the RMJ lip into the top channel of the rail (Fig. A2), and then tilt the RMJ downward until both of its tabs click around and fully engage the rail (Fig. A3).



Fig. A2



Fig. A3

6. Manually squeeze each tab upward to verify full engagement (Fig. A4)



Fig. A4

7. Remove the RMJ cover and insert the cable ends. For the provided glands, torque sealing nuts to 70 in-lb (7.9 N-m).
8. Complete the installation of any conduit and wiring.
9. Fit the cover on the RMJ and use the #2 square-drive screwdriver to torque each of the four cover screws to 16 in-lbs (1.8 N-m).

# Appendix B: Install Rooftop Transition Flashing

Decide on the position of the installed flashing with respect to your array. Install the flashing only at a location that is both between the rafters and *within* the array perimeter, such that it will be *underneath and fully concealed* by the array when the array is complete.

1. After you have selected the location for the flashing, position the flashing on the roof as follows:
  - With its ROOF RIDGE arrow toward the peak.
  - Such that its lower alignment marks are positioned at or a maximum 1" (2.5 cm) above the bottom edge of the second of the two affected shingle courses at your chosen location (Fig. B1).
  - Such that the left and right edges of the flashing are perpendicular to the shingle courses.



Fig. B1

2. Keeping the flashing in position, trace its perimeter onto the shingles, and mark the flashing's alignment marks on the shingles as well.
3. Remove the flashing and use a straight edge to trace the lines between the alignment marks onto the shingles (Fig. B2).

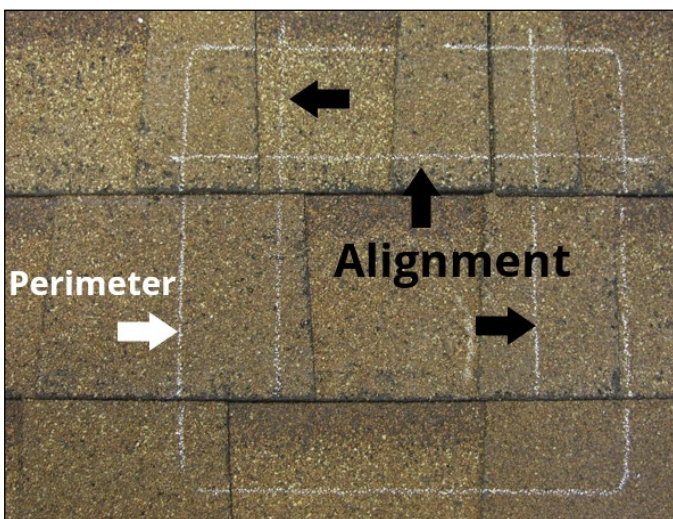

Fig. B2



- Using a roofing bar, gently separate the two courses of affected shingles from underlying layers in the marked region, while leaving the shingles in place.
- Cut and remove one layer of shingle material in the crosshatched area (Fig. B3 and Fig. B4).

**Important!** DO NOT REMOVE ANY SHINGLE MATERIAL FROM ANY COURSES THAT EXTEND BELOW THE BOTTOM OF THE FLASHING, *EVEN IF THAT MATERIAL IS INSIDE THE BOX*. DO NOT CUT THROUGH THE ROOF MOISTURE BARRIER EXCEPT FOR THE TRANSITION HOLE INTO THE ATTIC OR BUILDING SPACE.



Fig. B3

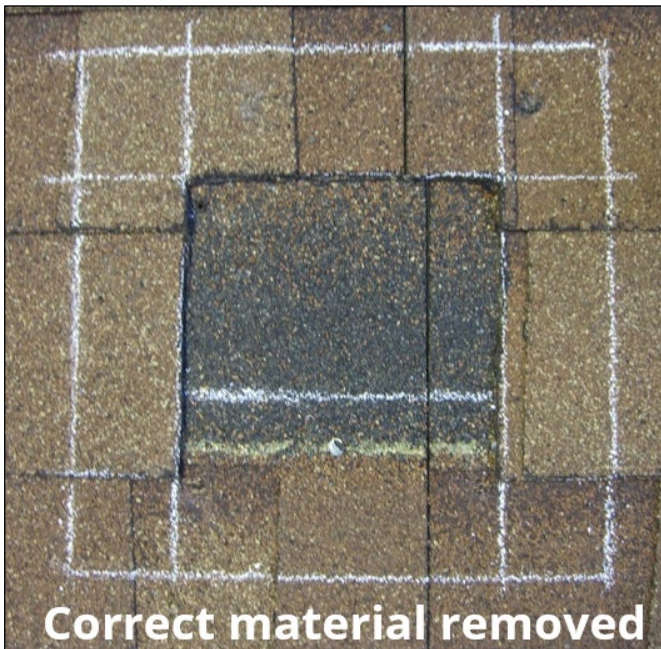

Fig. B4

- To test fit, slide the flashing up under the shingle course that will align with the lower edge of the flashing (the "middle" course of the three affected courses). If roof nails are in the way, remove them with a roofing bar and seal the remaining holes with appropriate sealant for the particular roof type.
- Remove the flashing.
- Through the roof surface from which you removed material, drill a single pass-through hole no larger than 5 cm (2"), centered E-W, and no less than 4" (10 cm) from the lower edge of the flashing (Fig. B5).

**Important!** The bottom point of the hole must be a minimum of 4" (10 cm) from the bottom edge of the flashing.

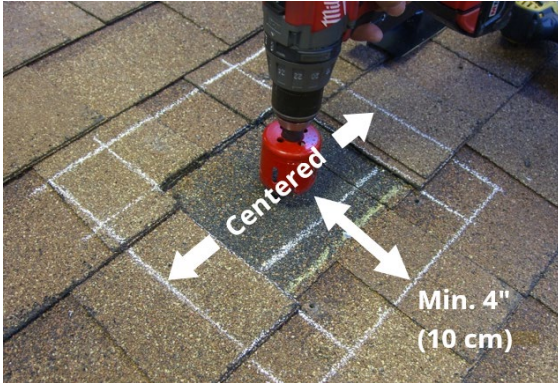

Fig. B5

- The flashing comes with three hole locations each marked with a white dot. Allowing for the size of your chosen gland, drill the flashing with a step drill tip (or knockout tool) centered on one of the dots (Fig. B6).

**Important!** Use only liquid-tight glands with gaskets appropriate for your chosen wire type.

**Note:** Use only the three provided drill locations, and do not drill more holes than necessary.

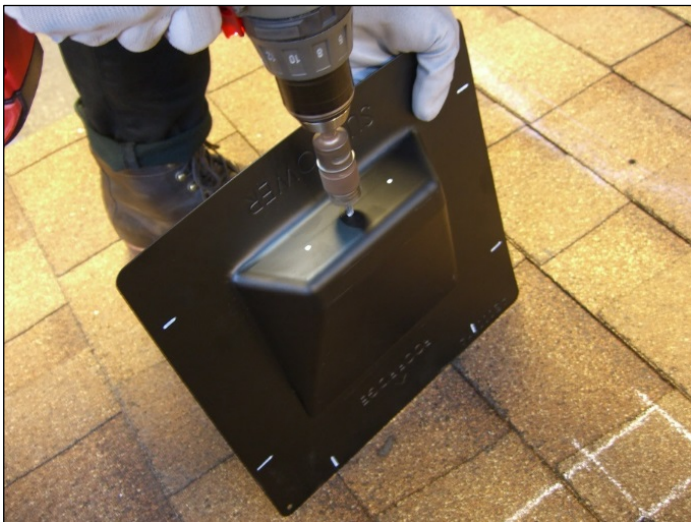

Fig. B6



10. Install and torque the gland and back nut as per the manufacturer guidance (Fig. B7 and Fig. B8).

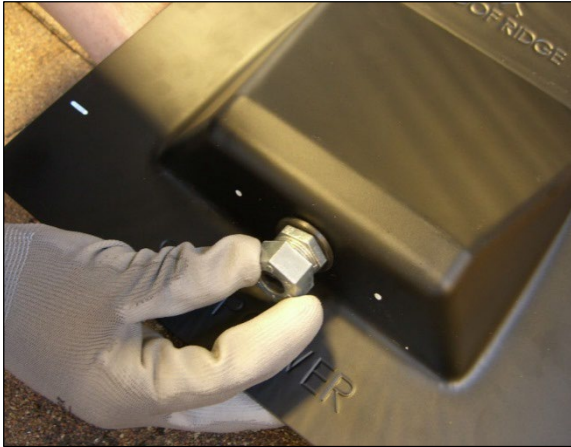

Fig. B7

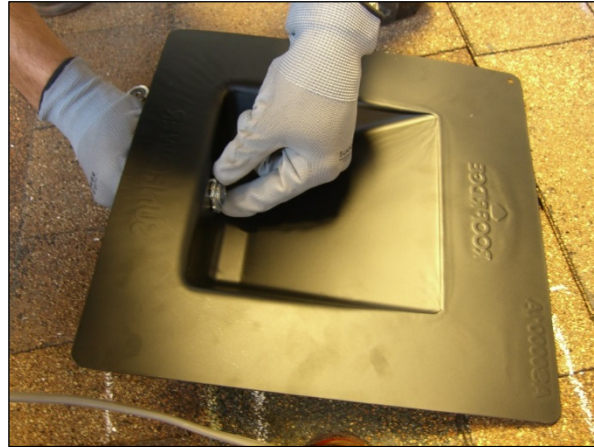

Fig. B8

**Important!** UF-B wire is used in this example because it is Listed for exterior and interior use. SunPower recommends that you refer to the applicable NEC edition for your region (some regions adopt editions later than others)—as well as consult with your AHJ—before choosing a wiring strategy.

11. Route and prepare a length of UF-B wire from the service panel entrance to the rooftop. Allow several extra feet for final installation.

12. Insert the cut end of the wire through the roof cutout, leaving sufficient length beyond the roof transition.

13. From the underside of the flashing, thread the UF-B wire through the gland, and then carefully slide the flashing into position (Fig. B9).



Fig. B9



Fig. B10

14. Ensuring that you leave enough extra wire length, tighten the gland around the wire per the gland manufacturer specification (Fig. B10).

**Important!** Do not loosen the seal at the base of the gland!

15. Remove the flashing and turn it over, taking care to not disturb the gland.

16. Apply a single 1/2" continuous bead of sealant to the *underside* of the flashing, approximately 1" (2.5 cm) from its perimeter (Fig. B11). Use only 100% silicone roof sealant, such as Henry 884 Tropi-Cool® or equivalent. Ensure that the sealant has not exceeded its shelf life and has not exceeded the recommended maximum time-to-use period after opening, as defined in the manufacturer guidance.

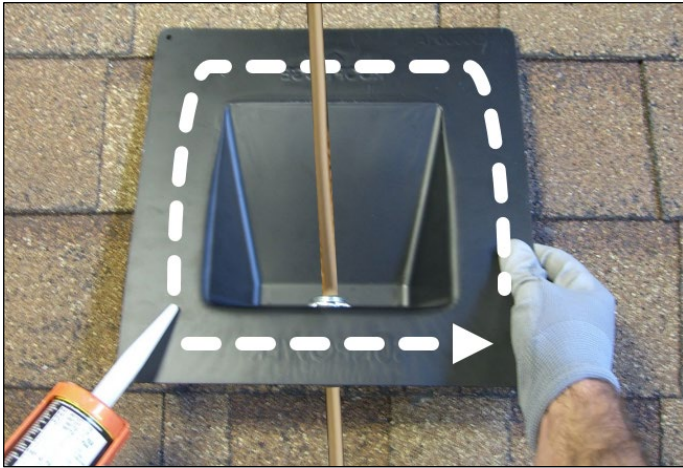

Fig. B11

17. Conforming to the exact outline you made previously, fit the flashing back into position while sliding the excess wire down into the attic space (Fig. B12).

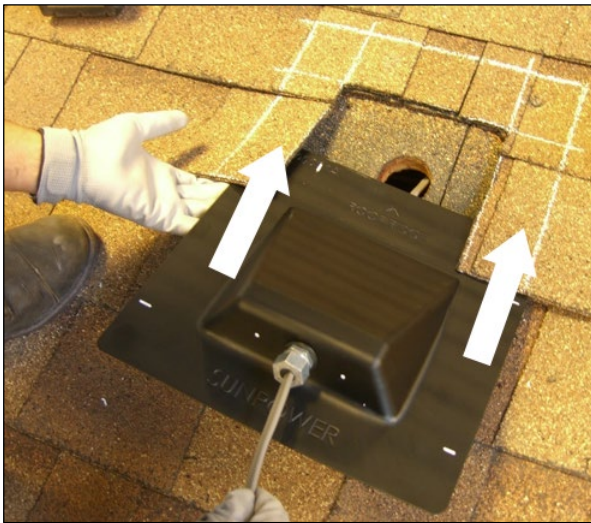

Fig. B12



Fig. B13

18. Lift the middle course of shingles and secure the flashing with one sheet metal screw (#9-15 1-1/2"); or nail (#12 ring shank 1-1/4"); on *each* side of the flashing; 1" (2.5 cm) from the flashing edge.

19. Apply a liberal cap of sealant on the head of each screw (or nail) (Fig. B13).

20. Lift the two courses of shingles and apply a horseshoe-shaped bead of sealant on the top surface of the flashing (as you did on the bottom of the flashing in Step 16) (Fig. B14).





Fig. B14

21. Press down firmly on the shingles over the flashing outline to properly bond the assembly to the roof surface.
22. Similar to Step 9, drill the flashing for conduit entry.
23. Install and torque all conduit fittings as per manufacturer guidance.
24. Mount conduit as per your array design. Conduit must be rated for the appropriate exposure. Exterior conduit and fittings must be rated liquid tight, and installed in an appropriate liquid-tight manner, including gaskets on all sealing faces where needed. A coupling can be used to connect interior and exterior raceways through the flashing.

For the flashing side of the conduit run, secure the conduit within 12" (30 cm) of either side (attic side or roof side) of the flashing.



## Appendix C: Rail Clips

Rail clips provide optional additional means of wire management. Use them as necessary to help keep all wiring off of the roof surface. The maximum number of wires that each rail clip is permitted to carry is **one**. Space rail clips no more than 24" (61 cm) apart.

In addition, *always prevent wires from drooping below the lower edge of the rails.*

1. Place the wire into the wire channel of the clip (Fig. C1), position the clip beneath the rail, and then fit the lower lip into the side channel of the rail (Fig. C2).



Fig. C1

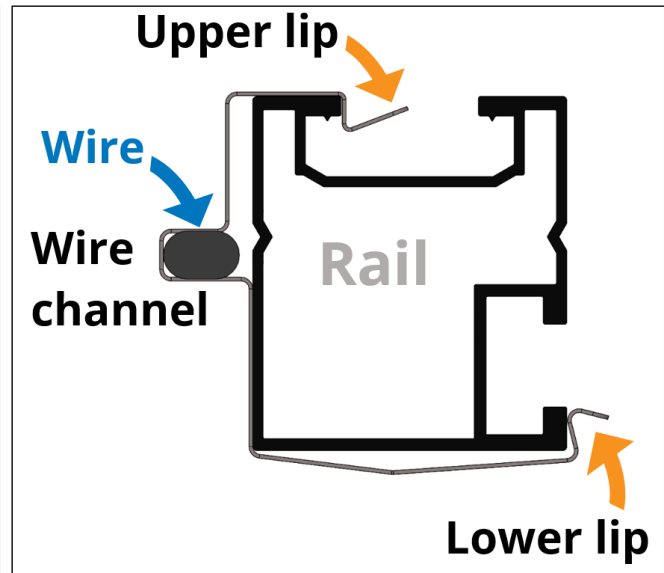

Fig. C2

2.  *Holding the wire in position within the clip, rotate the clip under and around toward the top of the rail (Fig. C3), gently pushing the upper lip over the top of the rail until it snaps into the top channel of the rail (Fig. C4). You should hear the upper lip click into the channel.*

To remove clips, simply press down on the lower lip to release it from the rail.

# Appendix D: Module Removal

**Important!** If you have to remove a module from an array, note that *leaving any module in the array when it is physically secured only by two end clamps is expressly prohibited.*

To remove a module from an existing array:

1. Turn off the DC disconnect at the inverter.
2. Using a clamp-on multimeter, verify that current flow has stopped on all DC source circuit conductors. If fuses are installed at the combiner, remove the fuses to isolate the circuit with the target module from parallel-connected sources.
3. Using a clamp-on current meter, test each individual circuit conductor AND each equipment ground conductor on the rooftop before opening any module connectors (before disconnecting any module leads).
4. If the current is zero amps, it is safe to proceed to Step 8. If there is any current present (greater than 0 amps), double-check that the circuit is in fact disconnected from the inverter and proceed to Step 5.
5. If the circuit has been disconnected from the inverter and current is still present, **DO NOT INTERRUPT THE CIRCUIT!** (Do not unplug any module leads or open any breakers, for example.) It is likely that a short circuit or a ground fault is present—or both.
6. Troubleshoot and correct the short circuit, the ground fault, or both.
7. After verifying that the circuit is disconnected from the inverter and that there are no short circuits or ground faults present, use the clamp-on meter to retest each individual circuit conductor AND each equipment ground conductor. Verify that the current for each is zero before proceeding.
8. Disconnect (unplug) the target module's two electrical leads from the modules that are adjacent to the target module.
9. Remove the adjacent modules and mid clamps, ideally from the side of the row that contains fewer modules between the target module and the end of the row (Fig. D1 and Fig. D2). If there is any other grounding or wire management hardware present, remove it as well.
10. Remove the target module.
  - If the target module will be out of the array solely for the purposes of replacing it with another module immediately, ensure that you remain aware of the adjacent module's temporary partial securement, and execute the swap efficiently, reusing all of the mid clamps and end clamps.
  - If the target module will be out of the array for an extended period, carefully attach two mid clamps to the now-exposed edge of each adjacent module (Fig. D1, Fig. D2, and Fig. D3) according to Section 5.6 of this guide (note that two of the teeth on these mid clamps will instead directly engage the top of the rail—*this is acceptable for module removal and replacement*). The mid clamps will keep the modules bonded to the rail, which is bonded to the equipment grounding conductor (EGC) and in turn the grounding electrode conductor (GEC).
11. After replacing or servicing the target module, reassemble the row according to the instructions in this guide.

**Important!** When reinstalling a removed module, shift its original location slightly (min. 1/16") relative to its original installed position and in the direction perpendicular to the rail before retightening the mid clamps and end clamps.

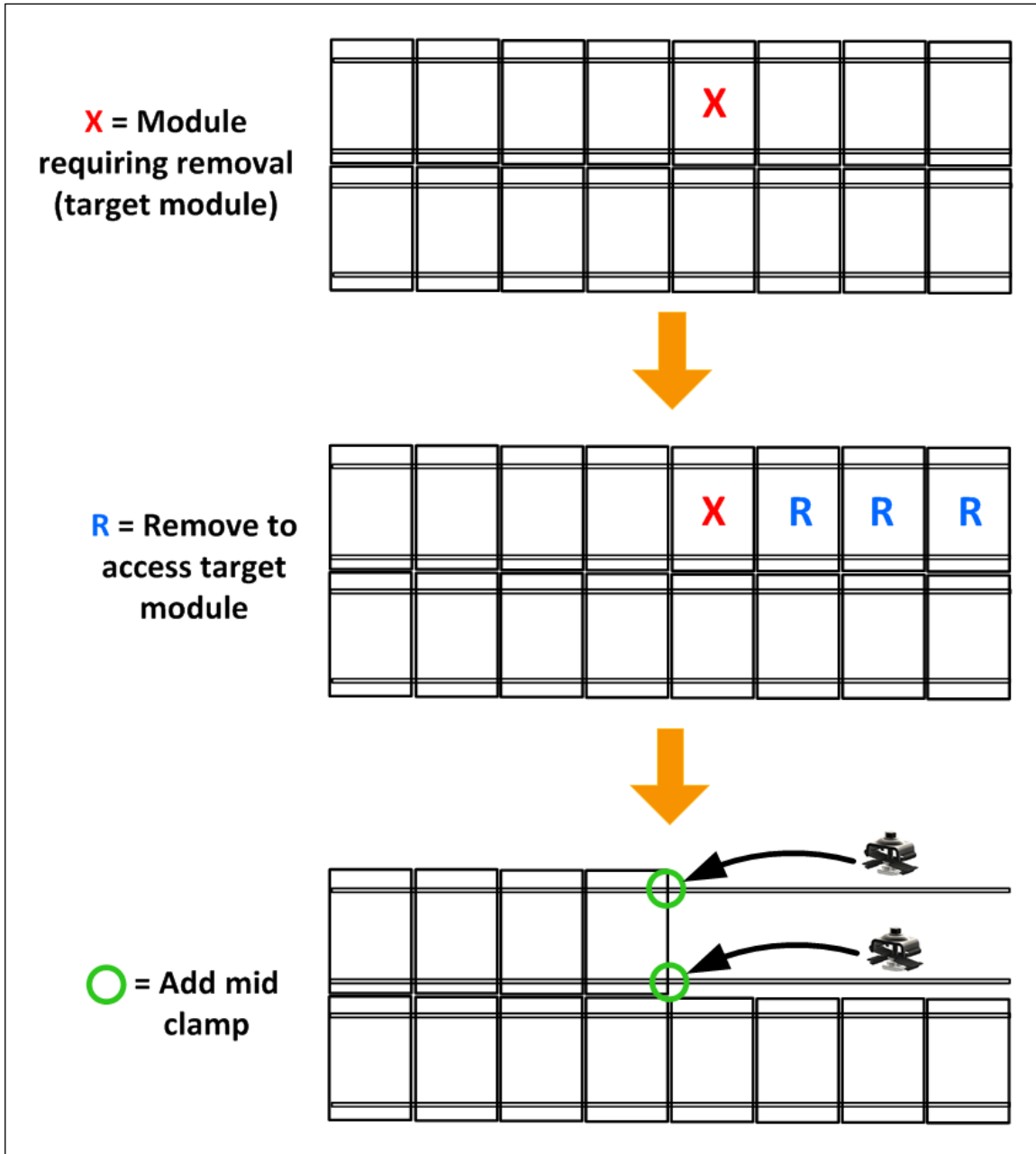

Fig. D1

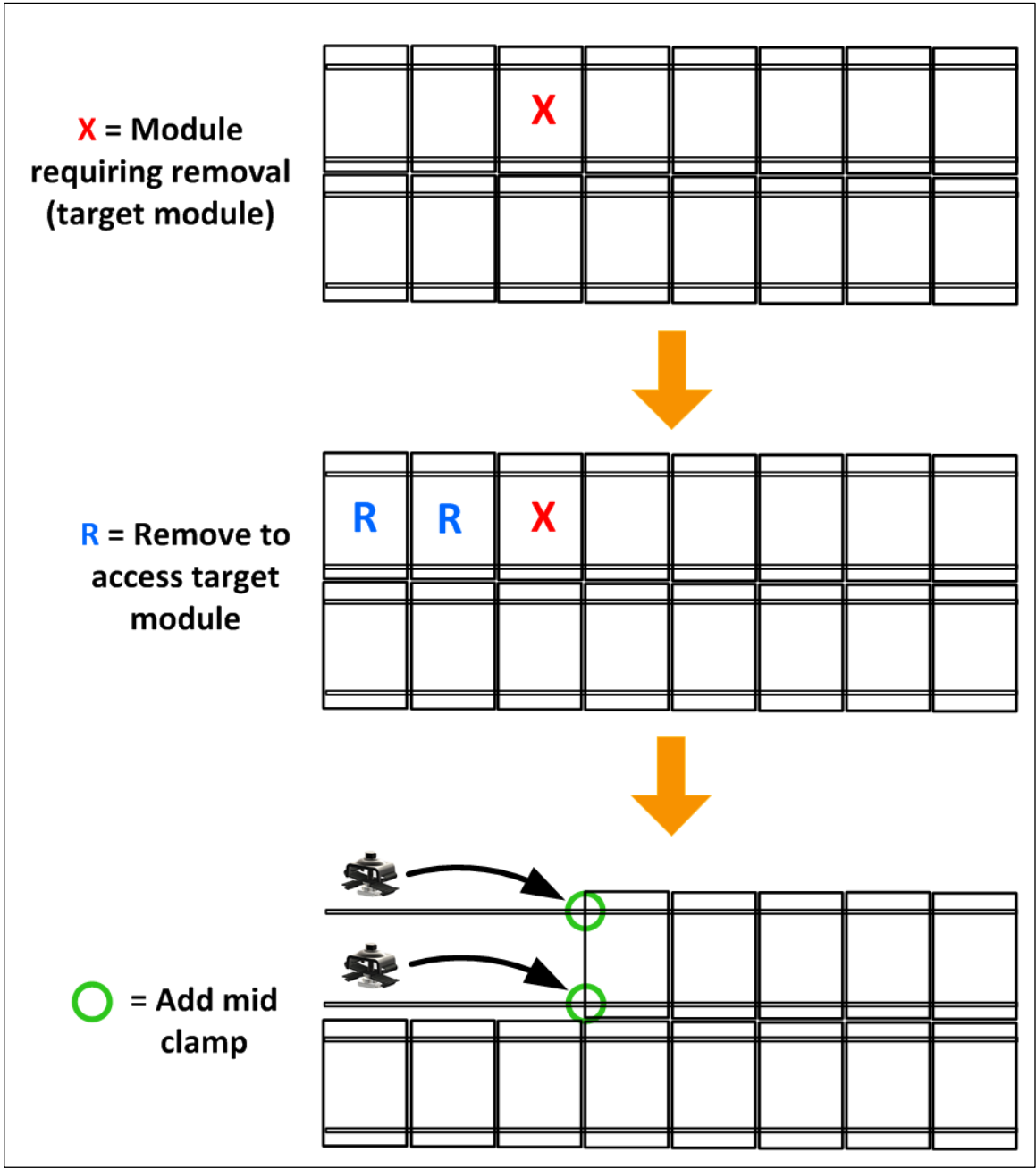

Fig. D2

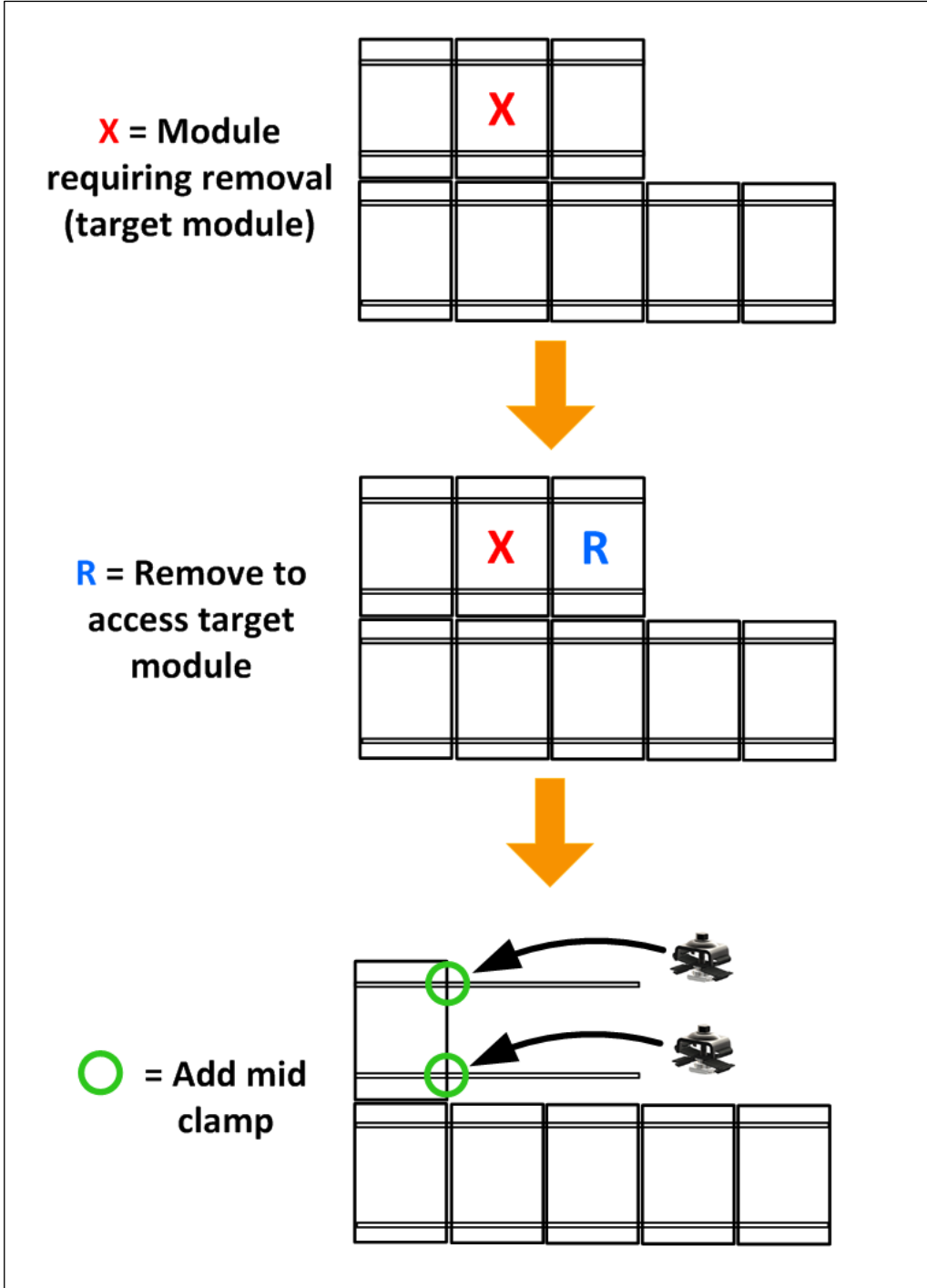

Fig. D3

# Appendix E: Install Front Skirt

***Important!***

- Handle the skirt carefully so that it is not scratched or deformed.
- The skirt is not a wireway—*do not use it for wire management!*
- The skirt is not a rodent guard.
- The skirt may only be attached to the *front* edge of the array—*not the sides*.

## Overview

The skirt section is the same length as the InvisiMount® rail: one skirt section fits three modules in portrait, or two modules in landscape. The skirt sections are the same independent of module type. However, because of minor frame profile differences, there are two different skirt *clip* types: one for A-Series AC modules (for example, *SPR-A400-G-AC*), and one for E-Series and X-Series AC modules (for example, *SPR-X22-370-E-AC*).

For quick differentiation, the A-Series clip is all all black, while the E/X clip has a silver base. Before beginning, ensure that you have the correct clip type for your array:

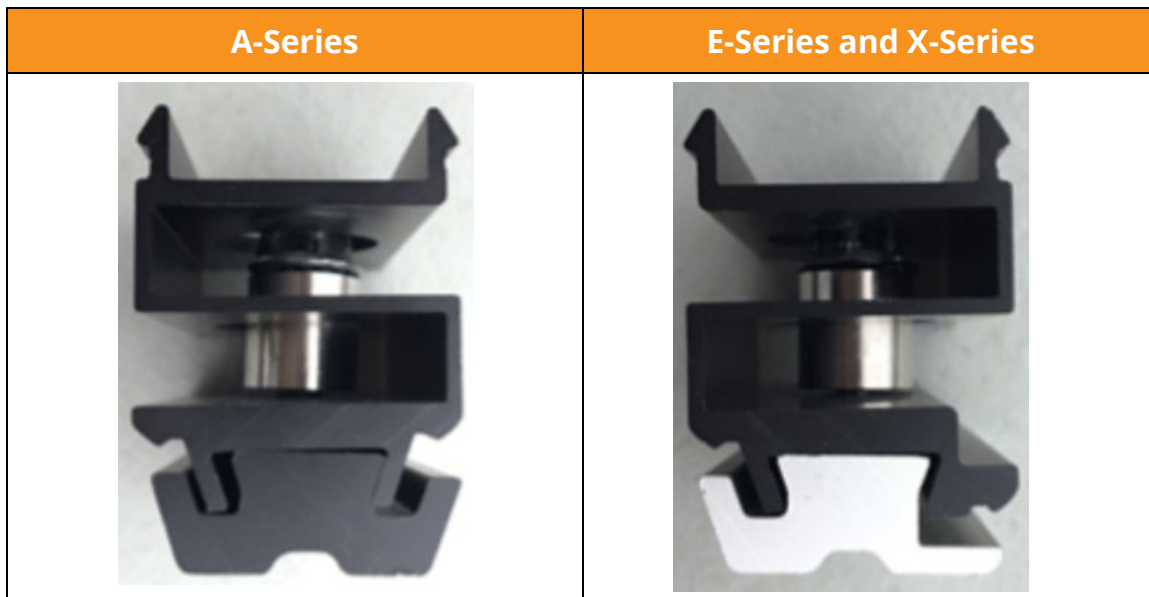

## Kit Details

Each skirt kit contains:

- 36 skirt clips (E/X or A)
- 6 skirt sections (each 3280 mm – the same length as an InvisiMount rail)
- 6 skirt end caps
- 14 end cap screws
- 6 row-to-row (R2R) grounding clips

## Tools and Materials

- Tape measure
- 10 mm socket with driver
- Torque wrench
- Circular saw or miter saw with metal cutting blade
- Phillips screwdriver
- Utility knife
- Touch-up paint pen
- Speed square
- Front skirt clips
- End caps
- End cap screws
- Row-to-row (R2R) rounding clips

## Installation

You may begin skirt installation only **after** the modules in the “first” row of the array (the row nearest the eave) are fully secured. Either side of the A-Series clip (all black) can engage the module frame, but the E/X clip (silver base) only engages one way:

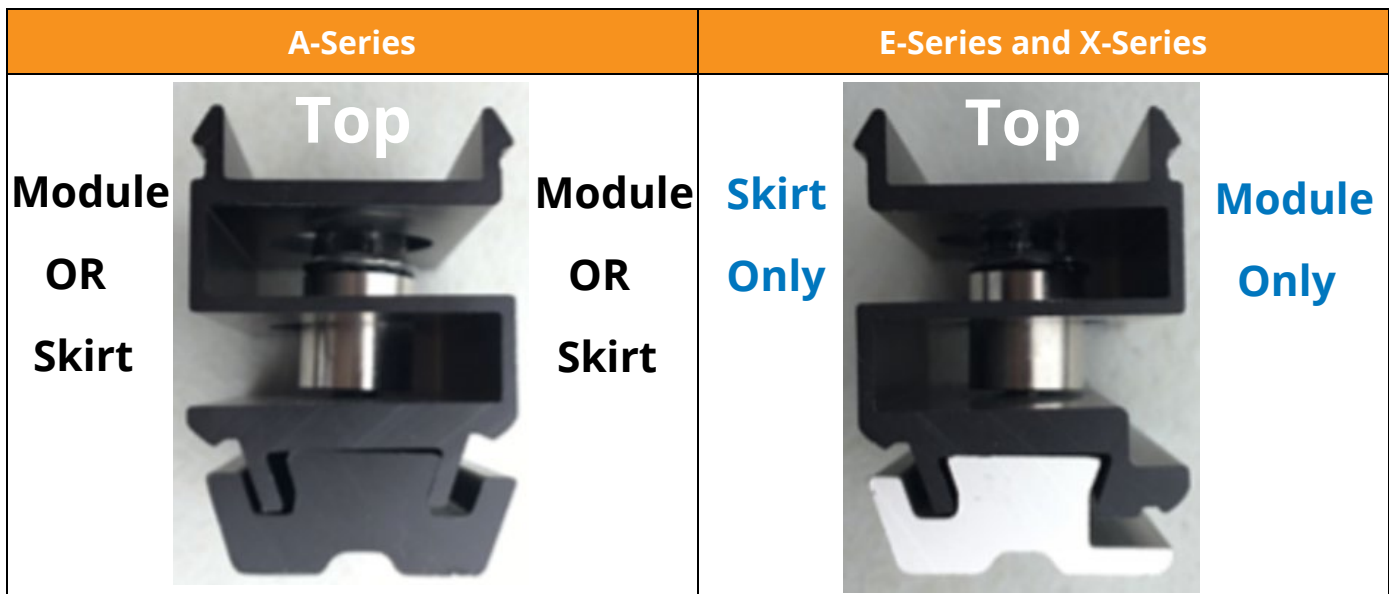



12. Install skirt clips on the lower side (the side nearest the eave) of the first row of modules (Fig. E1). Space them evenly:

- Two on the short side of the module for portrait installations.
- Three on the long side of the module for landscape installations.
- Snap each clip into the module frame by fitting the upper edge of the clip into the upper module frame lip (Fig. E2), and then tilting the clip down until it clicks onto the lower frame lip (Fig. E3).

*Do not tighten the bolts yet.*

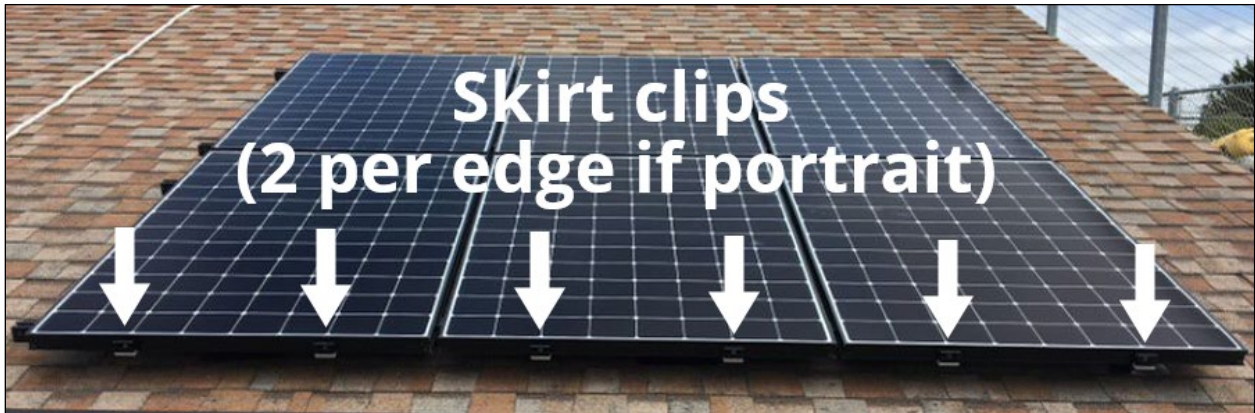

Fig. E1



Fig. E2

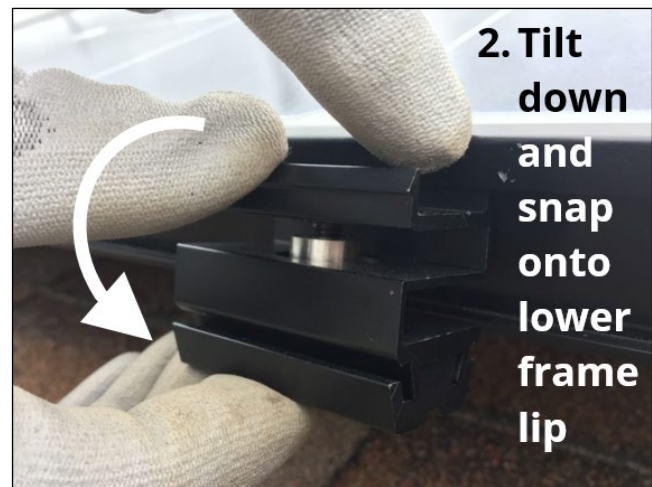

Fig. E3

13. If the array has more than three columns of portrait modules (or more than two columns of landscape modules), measure the width of the full row, determine how many skirt sections you need, and then cut what will be the final skirt section:

- Measure and mark the skirt.
- Score it using a utility knife and speed square.
- Cut the skirt.
- Deburr as necessary.

e. Use the paint pen to touch up the newly cut edge of the skirt.

**There is no splice for skirt sections.**

**Important!** Do not attempt to cut the skirt on the roof. Only cut the skirt on a stable surface using either a miter saw or a circular saw.

**SunPower Pro Tip:** Cut the skirt with the inner face upward, to help ensure a clean edge on the front. Carefully protect the outer face when cutting.

14. After all of the skirt clips are in position, carefully rest the skirt on the top edge of the clips, precisely align the skirt end with the row end, and then tilt the skirt downward onto the clips until it snaps into place (Fig. E4):

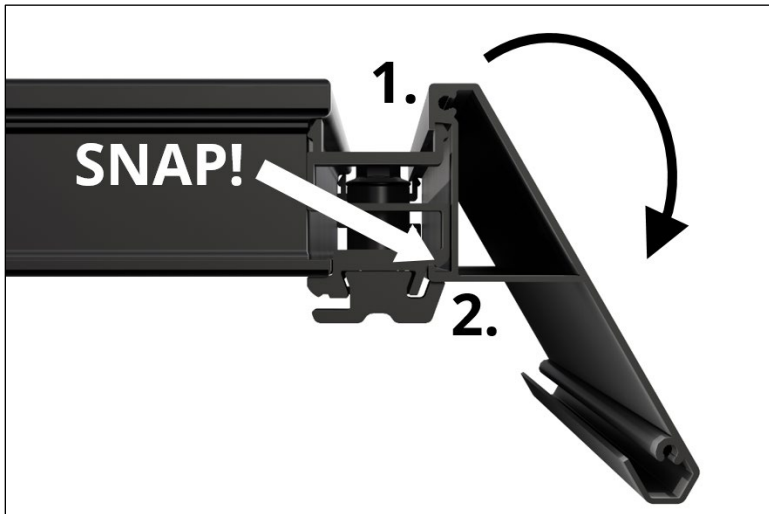

Fig. E4

15. Install a row-to-row (R2R) grounding clip for *each* skirt section (Fig. E5), capturing the module frame and the interior of the skirt. (Refer to Section 5.6.1 of the full *InvisiMount Installation Guide* #508988 for complete R2R clip instructions.)



Fig. E5

**Important!** In addition to its role grounding two adjacent rows together (installed between module rows), the R2R grounding clip is **also** used for grounding the skirt (installed between exposed module edge and skirt). Therefore, one R2R grounding clip is required for **each** skirt *section* you attach to the array!

**Note:** Because of access, at the row end where you will attach the R2R clip that grounds the given skirt section, install the clip *before* you install the skirt end cap.

16. Use a torque wrench and 10 mm socket to torque each clip bolt and R2R grounding clip to 85 ±5 in-lb.

17. Attach the skirt end caps using the provided screws (Fig. E6):



Fig. E6

18. Use the paint pen to touch up any scuffs or scrapes on the skirt (Fig. E7):



Fig. E7

SUNPOWER, the SUNPOWER logo, Equinox, and InvisiMount are registered trademarks of SunPower Corporation.

© 2019 SunPower Corporation. All rights reserved. Specifications included in this document are subject to change without notice.