

IOT Based Smart Irrigation System using Cisco Packet Tracer

Sanskruti Raut^{1*}, Sumitra N. Motade²

^{1,2}School of Electronics and Communication Engineering, MIT World Peace University, Pune, India

*Corresponding Author: sanskrutiraut14@gmail.com, Tel.: +919082507080

DOI: <https://doi.org/10.26438/ijcse/v9i2.1216> | Available online at: www.ijcseonline.org

Received: 03/Feb/2021, Accepted: 04/Feb/2021, Published: 28/Feb/2021

Abstract— Irrigation system is a method used to supply water to the plants as uniformly as possible. In the Internet of Things (IoT), technology devices or sensors are connected via the internet and can be remotely operated and monitored by the user. In this research paper, the implementation is done by performing the simulation for a smart irrigation system with the help of the Cisco packet tracer simulation software with new version Cisco Packet Tracer 7.3.0 (64-bit). This technology can be implemented for developing a smart irrigation system, which consists of devices like a lawn sprinkler, temperature monitor, Humidity monitor, etc., to automate the watering system and remotely monitor the environmental conditions for better growth of the plants. All the devices are connected to the home gateway and can be remotely operated and monitored using a Tablet/PC/Smartphone. Simulation results show that the smart devices such as a sprinkler system and other essential devices for monitoring environmental conditions are connected to the home portal and can be successfully monitored, which helps the farmers/homeowners to grow and maintain plants with ease.

Keywords— Internet of Things, Cisco Packet Tracer, Smart Irrigation System

I. INTRODUCTION

The term IoT means ‘Internet of Things’, which was coined by Kevin Ashton in 1999 [1]. It is a budding technology that plays a major role in today’s life to interconnect devices and the internet in a network, which in turn enables them to send and receive data [2].

There are many problems faced by the farmers or the homeowners having a lawn space for gardening and the maintenance of the plants due to the changing environmental conditions. IoT technology can help the farmers/homeowners to maintain a proper irrigation system that can be automated and remotely operated from any part of the world.

In today’s busy world, if the homeowners are not present in the house to take care of the plants, this technology can help them to easily monitor the devices and thus helps to overcome the disadvantage of manual monitoring.

In this work, Smart Irrigation system consists of smart devices that automate the irrigation system that allows the homeowners to automate the lawn sprinkler/ watering system according to the level of the water shown by the water level monitor, which results in turning the water drain on or off accordingly. Smart Irrigation system provides various automating activities such as controlling the humidity levels of the plants. The humidity sensor monitors the level and turns the humidifier on or off after it reaches a certain level set according to the requirements of the owner.

The other aspects include the monitoring of environmental conditions by various sensors that are crucial for strong and verdant growth of plants, which includes Temperature monitor, Pressure monitor, Carbon dioxide detector, Carbon monoxide detector, Wind detector, and Humiture monitor. The smart devices are connected to the home gateway and can be remotely operated and monitored by using a Tablet/PC/Smartphone. It also has a motion detector alarm for animals. It uses a microcontroller to operate and alarms the owner if motion is detected near the irrigation field.

The simulation results show that smart devices are connected to the home gateway and can be remotely operated, monitored, and automated according to the requirements.

Cisco Packet Tracer is a visual simulation tool developed by Cisco that gives users the chance to make network topologies and imitates modern computer networks. It allows you to simulate routers and switches by using a simulated command-line interface.

The rest of the paper is organized as follows, Section I contains the introduction of IoT and its implementation for Smart Irrigation System, Section II contain the related work of the projects, Section III contains the methodology of the Smart irrigation system, Section IV describes results and discussion and Section V concludes research work with future directions.

II. RELATED WORK

As mentioned in the reference paper [3], a greenhouse monitoring system is developed based on IoT using the

packet tracer simulation software. It uses the statistical data from the sensors and the information stored in a cloud. In Paper [4], an automated system for irrigation is developed by analyzing the moisture level of the ground. This system makes use of two microcontrollers, Raspberry pi and Arduino respectively. The system represented in [5] represents a smart home system using cisco packet tracer that uses the IoT technology to automate various activities of the house. The theme in [6] aims for a high-level monitoring and controlling of the data for agriculture monitoring system which monitors the real-time data from the crop-field using Raspberry pi and cloud-based IoT systems. As mentioned in this paper [7], The use of automation systems in wireless technology has several advantages that wired systems cannot provide. The wireless systems reduce the installation costs since the hardware requirement is low and no cabling is necessary. Wireless systems are scalable and expandable. Internet connectivity is another factor that plays crucial role in order to control devices from all around the world. As proposed in this paper [8], for controlling the sensors, a Microcontroller (MCU-PT) and Home Gateway is used which provides programming environment for controlling devices that are connected to the home gateway.

III. METHODOLOGY

The design of the Smart Irrigation system has been done by using the Cisco Packet Tracer simulation software. Cisco Packet Tracer is an innovative and powerful network simulator that can be used for building a network with routers, switches, wireless, and much more. It allows to experiment with network behavior, device configuration, and building models. Smart Irrigation system design includes a tablet and home gateway used to connect to various devices like temperature monitor, lawn sprinkler, water level monitor, and other sensors. Home gateway is used to connect all the smart devices, and Tablet is used to communicate with the smart devices.

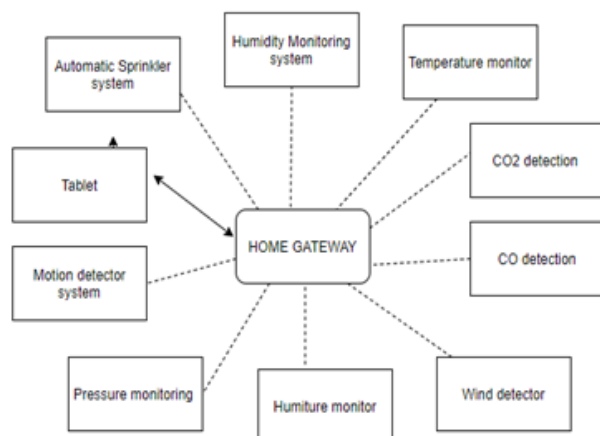

Figure 1. Block Diagram of Smart Irrigation System

Fig 1 shows the block diagram of the Smart Irrigation system, which is implemented using the Cisco Packet Tracer. The block diagram contains an Automatic sprinkler

system, humidity monitoring system, Temperature monitor, Pressure monitoring, Motion detector system, Humiture monitor, Wind detector, Carbon monoxide detector, and Carbon dioxide detector. All these smart IoT systems and devices are connected to the internet by using a home gateway and can be controlled using a Tablet. Table 1 shows the devices used and their function.

Table 1. Devices used

| Sr. No. | Device | Function |
|---------|--------------------------|--|
| 1 | Server | Server is used to interconnect the home system to a cellular network |
| 2 | Cable Modem | It is used to provide internet connection |
| 3 | Cloud | Cloud is used to store data |
| 4 | Home gateway | Provides internet access and local connection to the IoT network |
| 5 | Switch | Switches allow different devices on a network to communicate |
| 6 | Lawn Sprinkler | A sprinkler for Lawn |
| 7 | Water level monitor | Used for water level detection |
| 8 | Water Drain | Drains out water at a rate of 0.5cm per hour |
| 9 | Light indicator | It is used to give light indication if the system is on |
| 10 | Temperature monitor | Temperature monitor is a device that gathers data concerning temperature from the environment and converts it to a readable form of data |
| 11 | Pressure monitor | Atmospheric pressure detection |
| 12 | Humiture monitor | Humidity and Temperature monitor. Displays current humiture, which is $(\text{temperature} + \text{humidity})/2$ to the closest integer |
| 13 | Humidity monitor | Detects and displays humidity level |
| 14 | Humidifier | It is used to increase the humidity |
| 15 | MCU board | Microcontroller board for interconnecting devices |
| 16 | Alarm | It is triggered when motion is detected |
| 17 | Motion sensor | It is used for detecting motion |
| 18 | Carbon monoxide detector | Detects level of carbon monoxide |
| 19 | Carbon dioxide detector | Detects level of carbon dioxide |
| 20 | Wind detector | Detects wind in the environment |

A. Home Gateway

To connect to the network, either a home gateway is required or a registration server. After connecting to the PC or a tablet to the home gateway, the devices can be turned on and off using the features of the home gateway. Fig 2 shows the physical configuration of the home gateway.

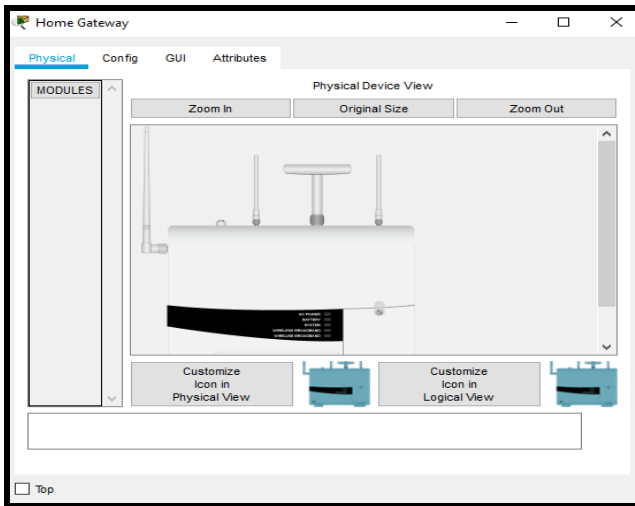

Figure 2. Physical configuration of home gateway

The home gateway provides internet access and wireless connectivity to the network and acts as a local connection to the IoT smart devices. The device has an internet port, four LAN ports, and multiple antennae. After connecting the home gateway to the existing network, the network settings are need to be set that are configurable by clicking on the config tab. The IP addressing information can be seen under the internet settings tab after connecting the device to the existing network. The wireless settings need to be configured by entering the home gateway SSID and selecting WPA2-PSK PSK passphrase and a password for authentication and validation of the wireless network. The next step is to connect the IoT smart devices to the home gateway.

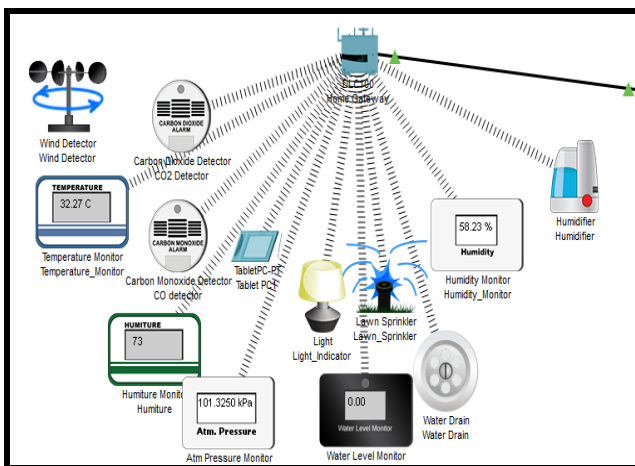

Figure 3. Connection of devices to home gateway

Fig 3 shows the connection of the home gateway with the devices. To configure and register the smart IoT devices with a home gateway, the following steps should be done. Select the device, and in the I/O config, select wireless adapter from the network adapter dropdown list. Select Config to verify that the device has established a wireless connection to the correct SSID. Then, Select Config/Settings and select the home gateway as the IoT server registration device.

B. Automatic Sprinkler System

The automatic sprinkler system consists of a lawn sprinkler, water level monitor, water drain, and a light indicator. The water level monitor is used for water level detection. The user can set the parameters for the water level monitor according to requirements. If the level of the water goes up to the minimum required level, it turns the lawn sprinkler off and turns the water drain on automatically. Similarly, it turns the Sprinkler on if the level of water is less than the required level. The light indication is provided when the irrigation system is on to alert the users. This feature of the Automatic lawn sprinkler system eliminates the disadvantages of manual monitoring of the irrigation system. The lawn sprinkler and other devices in the system can be controlled manually too.

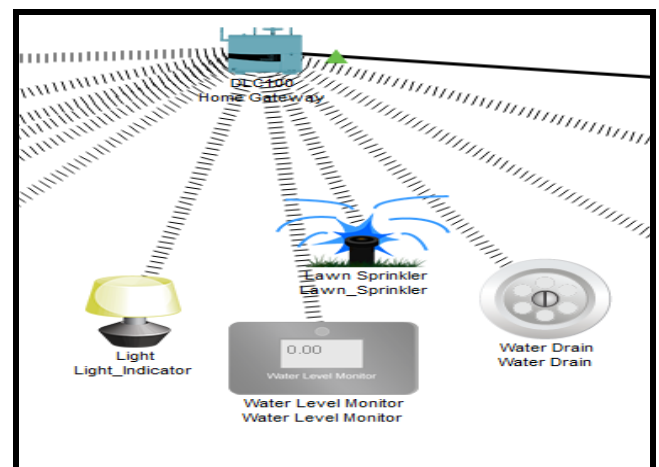

Figure 4. Automatic Sprinkler System

C. Humidity Monitoring System

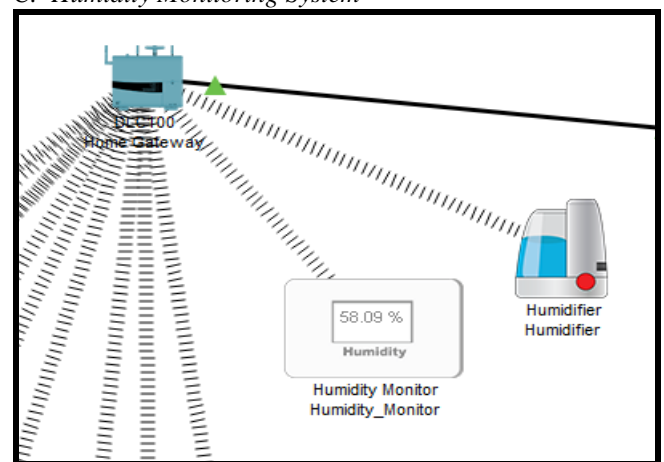

Figure 5. Humidity monitoring system

Humidity monitoring is a crucial aspect of irrigation. Smart monitoring of humidity levels can increase the chances of good produce and smart irrigation. Fig 5. Shows the Humidity monitoring system, which is one of the aspects of a smart irrigation system. In this system, a humidity sensor is used. Humidity sensors are used to sense the humidity in the environment. This sensor is registered to the home gateway. After the network configurations, the

values of the humidity sensor can be viewed on the Tablet. Further, to make it more convenient, a humidifier is used. A humidifier is a device used for increasing the level of moisture in the environment. The users can set the conditions accordingly.

| Actions | Enabled | Name | Condition | Actions |
|---|---------|-------------------------|---|---------|
| Set Lawn_Sprinkler Status to true Set Light_Indicator Status to On Set Water Drain Status to false | Yes | Turn on Lawn Sprinkler | Water Level Monitor Water Level < 3.0 cm | |
| Set Lawn_Sprinkler Status to false Set Light_Indicator Status to Off Set Water Drain Status to true | Yes | Turn off Lawn Sprinkler | Water Level Monitor Water Level >= 5.0 cm | |
| Set Humidifier Status to true | Yes | Turn on Humidifier | Humidity_Monitor Humidity <= 50 % | |
| Set Humidifier Status to false | Yes | Turn off Humidifier | Humidity_Monitor Humidity <= 30 % | |

Figure 6. Shows the conditions set for the automatic water sprinkler system and humidity monitoring system.

D. Other Monitoring Devices

The germination time of the seeds and plants may shorten due to frequent changes in the atmospheric pressure. This System has an Atmospheric Pressure level indicator for proper monitoring of atmospheric pressure levels and taking adequate measures that may help to increase the growth of plants and cause more massive and rapid root growth. Another aspect is the Humidity monitor, which helps in monitoring both temperature and humidity levels. The temperature monitor senses the temperature levels in the atmosphere. The Wind detector detects wind in the environment. The carbon monoxide and carbon dioxide detect the carbon monoxide and carbon dioxide levels, respectively.

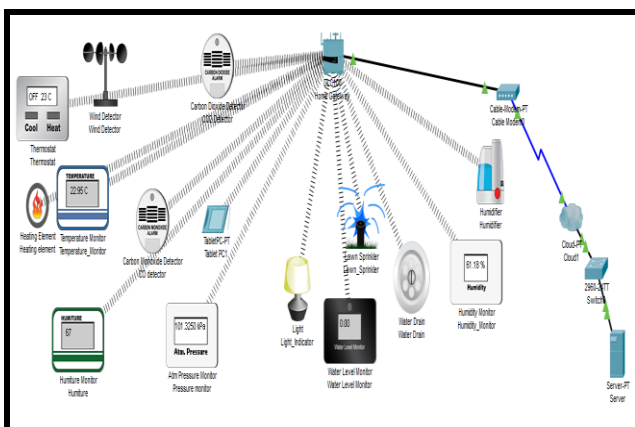

Figure 7. Overall Network

IV. RESULTS AND DISCUSSION

After registration of the devices with the home gateway, to control the IoT devices remotely using a tablet. The registered IoT devices can be viewed on the tablet. The devices can be manually operated as well as the values can be viewed and monitored in real-time.

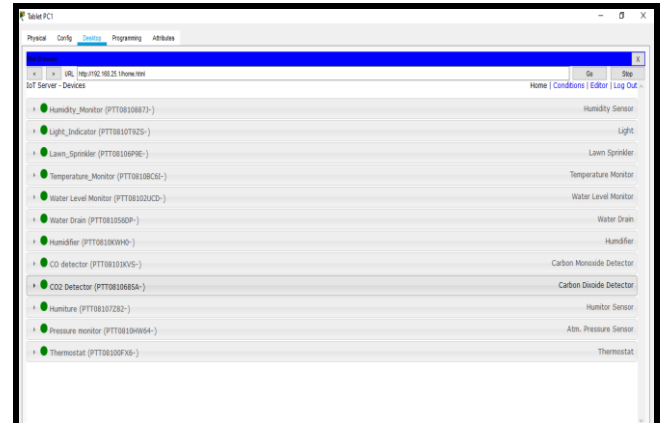

Figure 8. IoT devices displayed on the Tablet

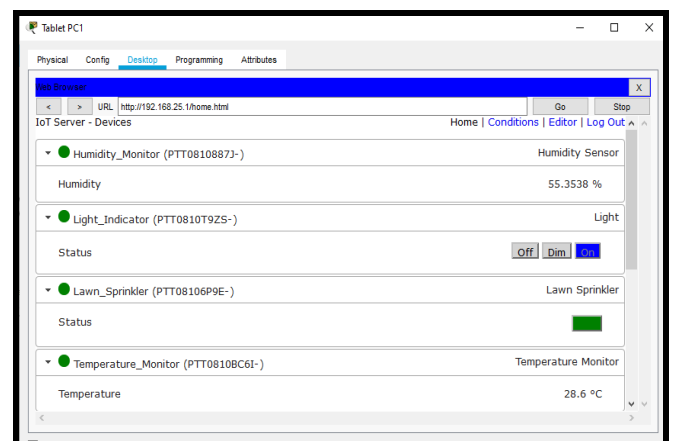

Figure 9. The numerical values of the sensors

Fig 9. shows the numerical values of the sensors that are displayed on the Tablet. It shows the status of the IoT devices registered with the home gateway. These devices can be manually as well as automatically monitored.

V. CONCLUSION AND FUTURE SCOPE

A smart irrigation system is implemented using the Cisco packet tracer. A home gateway to register the devices and control them using a tablet. All the IoT devices connected to the home gateway can be monitored manually as well as remotely by the user. The results prove that there is an opportunity of applying this model in real life. The implementation of the automatic irrigation system can be used to reduce the use of water. The system can be manually monitored, it can increase the energy efficiency and savings. It also makes it convenient for the user to access all the devices through the smartphone. In the field of IoT, ensuring security should be a priority. Since the IoT devices are interconnected to each other, the network should be secured. In this system, an authentication gateway is designed that requires password to check authenticity of the home user for security purpose. To extend this system to be more robust and efficient in the future, modifications can be made to make the system more secure. If abnormalities in the system are detected, the system should send an SMS or an Email to alert the user.

REFERENCES

- [1] Egemen Hopalı, Özalp Vayvay, "Internet of Things (IoT) and its Challenges for Usability in Developing Countries" International Journal of Innovation Engineering and Science Research, **Vol. 2 , Issue. 1 January 2018**
- [2] Ghaliya Alfarsi, Ragad M Tawafak, Abir Alsidiri, Jasiya Jabbar, Sohail Iqbal Malik, Maryam Alsinani, "Using Cisco Packet Tracer to simulate Smart Home", **Vol. 8 , Issue 12, December 2019**
- [3] Sahana B, D. K. Sravani , Dhanyashree R Prasad "Smart Green House Monitoring based on IOT", IJERT, **Vol.8, Issue.14, August 2020.**
- [4] Sneha Angal, "Raspberry pi and Arduino Based Automated Irrigation System", International Journal of Science and Research (IJSR), **Vol. 5 Issue. 7, July 2016.**
- [5] Isa Shemsi, "Implementing smart home using cisco packet tracer", IJERT, **Vol.4, Issue.7, January 2018.**
- [6] R. N. Rao and B. Sridhar, "IoT based smart crop-field monitoring and automation irrigation system," *2018 2nd International Conference on Inventive Systems and Control (ICISC)*, Coimbatore, **pp. 478-483, 2018**, doi: 10.1109/ICISC.2018.8399118.
- [7] Vaishnavi S. Gunge, Pratibha S. Yalagi," Smart Home Automation: A Literature Review", International Journal of Computer Applications
- [8] Abdulrazaq, A., A. Aboaba, G. M. Yelmis, M. Peter, S. Buba and A. Jubril. "Application of smart technology in monitoring and control of home appliances." *Arid Zone Journal of Engineering, Technology and Environment* **13: 523-534, 2017.**

AUTHORS PROFILE

Miss. Sanskruti Raut currently pursuing Bachelor of Technology in Department of Electronics and Communication from Maharashtra Institute of Technology, World Peace University, Pune in 2020.



Mrs S N Motade pursued Bachelor of Engineering from S.G.S.CoE&T Nanded in year 2002 and Master of Technology from Dr. Babasaheb Ambedkar Technological University, Lonere in year 2009. She has completed Ph.D. from Savitribai Phule Pune University Pune and currently working as Assistant Professor in School of Electronics and Communication, MIT World Peace University, Pune in 2020. She is a life member of IETE & ISTE since 2005. She has published more than 10 research papers in reputed international journals including Thomson Reuters (SCI & Web of Science) and conferences including IEEE and it's also available online. Her main research work focuses on Wireless Communication, Signal Processing, and IoT. She has 16 years of teaching experience.