



United States
Department of
Agriculture

**Natural
Resources
Conservation
Service**

National
Engineering
Handbook

Irrigation Guide

Issued September 1997

The United States Department of Agriculture (USDA) prohibits discrimination in its programs on the basis of race, color, national origin, sex, religion, age, disability, political beliefs, and marital or familial status. (Not all prohibited bases apply to all programs.) Persons with disabilities who require alternative means for communication of program information (Braille, large print, audiotape, etc.) should contact USDA's TARGET Center at (202) 720-2600 (voice and TDD).

To file a complaint, write the Secretary of Agriculture, U.S. Department of Agriculture, Washington, DC 20250, or call 1-800-245-6340 (voice) or (202) 720-1127 (TDD). USDA is an equal employment opportunity employer.

Preface

Irrigation is vital to produce acceptable quality and yield of crops on arid climate croplands. Supplemental irrigation is also vital to produce acceptable quality and yield of crops on croplands in semi-arid and subhumid climates during seasonal droughty periods. The complete management of irrigation water by the user is a necessary activity in our existence as a society. Competition for a limited water supply for other uses by the public require the irrigation water user to provide much closer control than ever before. The importance of irrigated crops is extremely vital to the public's subsistence.

Today's management of irrigation water requires using the best information and techniques that current technology can provide in the planning, design, evaluation, and management of irrigation systems. Support for many of the values included in this chapter come from field research, established design processes, and many system designs and evaluations over many years. Field evaluations must always be used to further refine the planning, design, evaluation, and management process. This design guide in the Natural Resources Conservation Service (NRCS), National Engineering Handbook series provides that current technology.

Irrigation Guide, Part 652, is a guide. It describes the basics and process for planning, designing, evaluating, and managing irrigation systems. It provides the process for states to supplement the guide with local soils, crops, and irrigation water requirement information needed to plan, design, evaluate, and manage irrigation systems.

Irrigation Guide, Part 652, is a new handbook to the family of references in the NRCS, National Engineering Handbook series. It is written for NRCS employees who provide technical assistance to the water user with concerns for both water quantity and quality. Other technical personnel for Federal, State, private, and local agencies will also find the guide useful as a basic reference when providing technical assistance relating to planning, designing, evaluating, and managing irrigation systems. College and university instructors will also find the guide useful as a classroom reference.

In addition to the irrigation Guide (part 652), chapters in the National Engineering Handbook irrigation section (now part 623) describe:

- Soil-plant relationships and soil water properties that affect movement, retention, and release of water in soil
- Irrigation water requirements
- Planning farm irrigation systems
- Measurement of irrigation water
- Design of pumping plants
- Design criteria and design procedures for surface, sprinkler, and micro irrigation methods and the variety of systems for each method that can be adaptable to meet local crop, water, and site conditions and irrigation concerns

Acknowledgments

Part 652, Irrigation Guide, is an addition to the National Engineering Handbook series. The document was initially prepared by **Elwin A. Ross**, irrigation engineer, NRCS, Engineering Division, Washington, DC, (retired) with primary input and review from **Leland A. Hardy**, irrigation engineer, Midwest National Technical Center, NRCS, Lincoln, Nebraska, (retired).

Principal NRCS staff who contributed to the development and review of this publication were:

John Brenner, irrigation engineer, North Platt, Nebraska

Jerry Walker, irrigation engineer, Temple, Texas

Carl Gustafson, state conservation engineer, Amherst, Massachusetts

David Nelson, assistant state conservation engineer, Amherst, Massachusetts

John Dalton, agricultural engineer, Bozeman, Montana (retired)

Jim Suit, state conservation engineer, Bozeman, Montana

State conservation engineers coordinated a multidiscipline (representing soils, agronomy, water quality, and water management) review in all states.

William J. Carmack, national water management engineer, (retired),

Ronald L. Marlow, water management engineer, NRCS, Washington, DC,

and **Thomas L. Spofford**, irrigation engineer, NRCS, National Water and Climate Center, Portland, Oregon provided leadership and coordination.

Editing and publication production assistance were provided by the Technical Publishing Team, NRCS, National Cartography and Geospatial Center, Fort Worth, Texas. Final technical review was provided by Elwin A. Ross and Leland A. Hardy.

Irrigation Guide

Contents:	Chapter 1	Introduction
	Chapter 2	Soils
	Chapter 3	Crops
	Chapter 4	Water Requirements
	Chapter 5	Selecting an Irrigation Method
	Chapter 6	Irrigation System Design
	Chapter 7	Farm Distribution Components
	Chapter 8	Project and Farm Irrigation Water Requirements
	Chapter 9	Irrigation Water Management
	Chapter 10	Conservation Management Systems and Irrigation Planning
	Chapter 11	Economic Evaluations
	Chapter 12	Energy Use and Conservation
	Chapter 13	Quality of Water Supply
	Chapter 14	Environmental Concerns
	Chapter 15	Resource Planning and Evaluation Tools and Worksheets
	Chapter 16	Special Use Tables, Charts, and Conversions
	Chapter 17	Glossary and References
	Index	

Irrigation Guide

Contents:	Chapter 1	Introduction
	Chapter 2	Soils
	Chapter 3	Crops
	Chapter 4	Water Requirements
	Chapter 5	Selecting an Irrigation Method
	Chapter 6	Irrigation System Design
	Chapter 7	Farm Distribution Components
	Chapter 8	Project and Farm Irrigation Water Requirements
	Chapter 9	Irrigation Water Management
	Chapter 10	Conservation Management Systems and Irrigation Planning
	Chapter 11	Economic Evaluations
	Chapter 12	Energy Use and Conservation
	Chapter 13	Quality of Water Supply
	Chapter 14	Environmental Concerns
	Chapter 15	Resource Planning and Evaluation Tools and Worksheets
	Chapter 16	Special Use Tables, Charts, and Conversions
	Chapter 17	Glossary and References
	Index	

Chapter 1

Introduction

Contents:	652.0100 Purpose and objective	1-1
	652.0101 Water and energy conservation	1-1
	652.0102 Soil conservation, water quality, and pollution abatement	1-2
	652.0103 Using the guide	1-3
	(a) Using irrigation procedures	1-3
	(b) Using worksheets	1-3
	652.0104 Irrigation guide outline	1-4
	(a) General	1-4
	(b) Soil-water-plant data	1-4
	(c) Irrigation and distribution systems	1-4
	(d) Irrigation planning and management	1-5
	(e) Special tools	1-5
	652.0105 Use of computers	1-6
	652.0106 State supplement	1-6

652.0100 Purpose and objective

The Irrigation Guide provides technical information and procedures that can be used for successful planning, design, and management of irrigation systems. It is a guide only and does not imply or set Natural Resources Conservation Service (NRCS) policy.

Irrigation systems should apply the amount of water needed by the crop in a timely manner without waste or damage to soil, water, air, plant, and animal resources. This includes, but is not limited to, offsite water and air quality and desired impacts on plant and animal (including fish and wildlife) diversity. Other beneficial uses of irrigation water are frost protection, crop quality, crop cooling, chemigation, desirable saline and sodic balance maintenance, and leaching of undesirable soil chemicals.

The Irrigation Guide includes current information and technical data on irrigation systems and hardware, automation, new techniques, soils, climate, water supplies, crops, tillage practices, and farming conditions. Included are irrigation related technical data for soils and irrigation water requirements for crops. In some instances statements are based on field experiences of the primary authors.

The objective of this guide is to assist NRCS employees in providing sound technical assistance for the maintenance of soil productivity, conservation of water and energy, and maintenance or improvement of the standard of living and the environment. Basic data used will help ensure the planned irrigation system is capable of supplying the amount of water needed by plants for planned production and quality during the growing season. Procedures for optimizing use of limited water supplies are also included.

Planning for an irrigation system should take into account physical conditions of the site, producer resources, cropping pattern, market availability, water quantity and quality, and effects on local environment. Economics should provide the basis for sound conservation irrigation decisions, but may not be the ultimate consideration. This is because many other factors may influence final decisions.

652.0101 Water and energy conservation

Conservation irrigation is an integral part of a complete farm management program of soil, water, air, plant, and animal resources. It is a principal consideration in the NRCS Conservation Management System approach to conservation planning on irrigated cropland, hayland, and pastureland. Irrigation must be complemented with adequate management of nutrients and pesticides, tillage and residue, and water. Proper water management results in conservation of water quantities, maintenance of onsite and offsite water quality, soil chemical management (salinity, acidity, applied fertilizers, and other toxic elements), and irrigation related erosion control.

For the farm manager, benefits must justify the costs of purchasing and operating the irrigation system and the time required to adequately operate, manage, and maintain the irrigation system while leaving a reasonable return on investment. For the groundskeeper, park or landscape superintendent, nursery grower, or homeowner, irrigation must maintain the desired growth of grass, ornamentals, flowers, and garden crops while minimizing costs, labor, inefficient water use, and nutrient and chemical losses.

Escalating costs of energy used for pumping makes every acre-inch of excess water a concern to many irrigators. Improving and maintaining pumping plants, irrigation equipment, irrigation application efficiencies, and following an irrigation scheduling program can lead to significant reductions in pumping costs.

Escalating costs of farm equipment, fuel, seed, fertilizer, pesticide, and irrigation equipment also make every irrigation and field operation a financial concern to the farmer. Field operations should be limited to those necessary to grow a satisfactory crop. Conservation irrigation typically reduces:

- Overall on-farm energy use
- Soil compaction, which affects root development and water movement
- Water quantities used
- Opportunity for ground water and surface water pollution

Applying water too soon or in excess of crop needs results in inefficient irrigation application. Too often irrigation decisionmakers subscribe to "when in doubt irrigate," rather than scheduling irrigations based on soil moisture monitoring and measured crop need.

Another factor leading to inefficient water use is the use-it-or-lose-it perception. Some irrigators and irrigation districts feel they must divert and use all the water allocated to them whether they need it or not. This can result in less than desired crop yield and product quality. It also increases leaching of nutrients, toxic elements, and salts below the root zone and increases the potential for erosion.

The direct cost of water to irrigators, when the water is supplied by irrigation companies or irrigation districts, varies between \$5 and \$600 per acre per year. In many areas, however, water is relatively low in cost. Low cost water can lead to inefficient use if an irrigator uses a convenient application time rather than providing the labor to fully manage the water.

652.0102 Soil conservation, water quality, and pollution abatement

Irrigation induced soil erosion is a problem on specific soils in certain areas. Soil erosion can take the form of wind erosion when smooth and bare ground occurs between harvest and new crop growth periods. Soil erosion by water can result from high application rates in the outer part of center pivot systems, excessive furrow or border inflows, and uncontrolled tailwater or runoff. The use of surface irrigation on moderately steep to steep topography or leakage in the delivery system can also cause soil erosion by water.

Soil erosion can produce sediment loads in irrigation ditches, drains, tailwater collection systems, roadside ditches, streams, and reservoirs. Sometimes it takes careful study of a site to realize that erosion is taking place. Soil erosion on irrigated fields generally can be controlled by careful planning, proper design, and adequate water, soil, and residue management. Offsite sediment damages are often a result of soil erosion from cropland, tailwater ditches, and surface water drains.

Pollution of ground and surface water by agricultural chemicals in irrigation water runoff or deep percolation is an increasing problem. Higher amounts of fertilizers are being used today than in the past. Chemigation can improve the application of chemicals through sprinkler systems, but can also create potential environmental problems through spills and improper or careless application. Leached chemicals, including salts in irrigation water, can degrade ground and surface water qualities. All of these problems can be minimized by proper planning, design, system operation, and water management.

Inefficient irrigation can have offsite benefits. Wetland habitat can be created from conveyance system leakage and application of excess irrigation water. However, excess irrigation water may contain undesirable or toxic organic or inorganic chemicals. In some parts of the United States, local, State, and Federal regulations are such that no irrigation runoff or subsurface drainage effluent from irrigation practices shall enter public water. In these areas irrigation runoff must be contained onsite, reused, or disposed of safely.

652.0103 Using the guide

The Irrigation Guide is prepared for local use; however, it is recognized that this guide may not directly apply to all areas. This guide contains sound water and irrigation system management concepts. It is a dynamic document available in computer electronic files or looseleaf form. As new, revised, or area-specific information becomes available, the guide can and should be updated. Irrigation is a rapidly evolving science and industry. Frequent revisions and additions are expected.

(a) Using irrigation procedures

The best available procedures and data should always be used, whether they are included in this irrigation guide or available elsewhere, for example, from Agricultural Research Service, Universities, Cooperative Extension Service, Bureau of Reclamation, or private industry.

Not all tables, charts, and procedures available in other readily available references are duplicated in the guide. Also, areas of the guide that describe procedures may not include all the processes and material needed to carry out the procedure. For instance, to perform a side roll sprinkler system design requires the use of National Engineering Handbook, Section 15, Chapter 11. However, most references referred to in the guide are available for field office use.

A personal library or reference folder(s) containing specific data and examples is recommended for technicians performing procedures. This library can be used until computer software programs are available and can then be used as a reference when the procedure is accomplished. Such a library or reference folder(s) can contain the following types of material:

- Irrigation guide tables, charts, references, procedures, materials, and forms, including examples.
- Tables for local climate, soils, crops, and plant water requirements.
- Available tables and figures from the National Engineering Handbook, Part 623, Irrigation.
- Information or aids from other sources for planning, design, management, and system evaluation.
- Previous jobs that have been designed, documented and approved.

(b) Using worksheets

The use of worksheets in this guide is optional. They should only be used if they are advantageous in saving planning time and providing documentation. Only those parts of the worksheets that apply to the particular job should be used. Blank master worksheets are included in chapter 15 of this guide.

652.0104 Irrigation guide outline

(a) General

Chapter 1, Introduction—This chapter introduces the irrigation guide, its purpose and contents. It also discusses water and energy conservation needs and opportunities, soil conservation, water quality, and pollution abatement concerns and opportunities.

(b) Soil-water-plant data

Chapter 2, Soils—This chapter describes soil basics: soil surveys, physical soil characteristics, and the relation of soil characteristics to different irrigation methods and systems. Several soil properties directly influence the design, management, and operation of an irrigation system.

Basic soil-water irrigation related parameters included in chapter 2 are variables and are to be used as a guide only. The parameters include:

- Estimated available water capacity by horizons or 1 foot (0.3 meter) increments
- Water intake characteristics for furrow and border (basins) irrigation
- Intake rates or maximum application rates for sprinkle irrigation
- Up-flux or upward water movement in soil

Specific local soils and their characteristics pertaining to irrigation are included in the state supplement section.

Chapter 3, Crops—This chapter describes the crop characteristics pertaining to irrigation; i.e., growth characteristics, rooting depth, and moisture extraction patterns, Management Allowable Depletion (MAD) levels, and effects of temperature, sodicity, and salinity. Management, including critical irrigation and moisture stress periods for plants and other special irrigation considerations, is included as a primary irrigation tool.

Crops respond to irrigation when rainfall does not maintain favorable soil moisture levels. When rainfall events are spaced too far apart for optimum plant-water conditions, plant biomass, yields, and quality are affected. Knowledge of actual crop rooting depths, water requirements at different growth stages, critical moisture stress periods, crop temperature modification effect, seed germination, and pesticide control are all necessary in determining when and how much water to apply.

Chapter 4, Water Requirements—This chapter describes methods for determining crop evapotranspiration (ET_c) and net irrigation water requirement. Water budget and balance analysis use are also described. Estimated evapotranspiration values for peak daily, monthly, and seasonal periods for locally grown crops are included in the state supplement section.

(c) Irrigation and distribution systems

Chapter 5, Selecting an Irrigation Method (Surface, Sprinkle, Micro, or Subsurface)—This chapter includes factors that affect irrigation method selection and system adaptation. The factors are largely functions of crop selection and rotation, soils, topography, climate zone, tillage practices, labor availability (including skills), economics, water availability in quantity and quality, type of delivery schedule, and the irrigation decisionmaker's personal preference.

Chapter 6, Irrigation System Design—Criteria and references for the implementation of the more commonly used irrigation methods and applicable systems are included in this chapter.

Chapter 7, Farm Distribution Components—This chapter describes alternatives and various components of the farm distribution system. Water measurement should be a part of any distribution system as it is the key to proper water management.

(d) Irrigation planning and management

Chapter 8, Project and Farm Irrigation Water Requirements—Procedures for determining large scale water requirements are described in this chapter. It also includes the application of water budget analyses to group and project level water requirement versus availability.

Chapter 9, Irrigation Water Management—Good irrigation water management should be practiced with all irrigation application systems. New techniques for irrigation scheduling and system automation are available and are a part of the information in this chapter. Field and climatic data should be accurately collected and an analysis of irrigation need, timing, and application amount made available to the irrigator promptly. Procedures for establishing soil intake characteristics and evaluation of existing irrigation are described.

Chapter 10, Conservation Management Systems and Irrigation Planning—This chapter contains the basic steps for planning ecosystem-based resource management systems including irrigation system planning. The planning process as it pertains to irrigated cropland is described.

Chapter 11, Economic Evaluations—This chapter includes the criteria that can be used in evaluating pumping plant operating costs. It also describes the procedures for making economical pipe size determinations and other economic factors and processes that can be used in planning.

Chapter 12, Energy Use and Conservation—This chapter reviews alternative energy sources and costs used in pumping and gives examples of irrigation system comparison and tillage and residue management that relate to overall on-farm energy requirements. Improving water management almost always decreases water and energy use except where inadequate irrigation has occurred and more water is needed to meet yield and quality objectives.

Chapter 13, Quality of Water Supply—Quality of water to be used for irrigation of crops is briefly described in this chapter. To meet crop yield and quality objectives, a reliable supply of high quality water is desired. However, with proper management, applying

saline water on salt tolerant crops, liquid waste from agricultural related processing and products, treated municipal sewage effluent, and other low quality water should be considered as an irrigation water source.

Chapter 14, Environmental Concerns—A direct relationship can be established between downstream water quality and irrigation. This relationship is presented in chapter 14. Improper selection of an irrigation method and system for a given site or the mismanagement of any system can result in poor water distribution uniformity, soil erosion, excessive runoff, and excessive deep percolation. Runoff can carry agricultural chemicals and plant nutrients in solution or attached to soil particles (e.g., phosphates). Excess irrigation water moving below the plant root zone (deep percolation) can carry soluble salts, nutrients (nitrates), pesticides, and other toxic elements that may occur in the soil profile. Excess irrigation water and whatever it contains in solution generally ends up either as ground water recharge or returns to downstream surface water.

(e) Special tools

Chapter 15, Resource Planning and Evaluation Tools and Worksheets—Included in this chapter are aids, tools, and processes that can facilitate irrigation system planning, design, and evaluations. Example Irrigation Water Management or Irrigation Water Conservation Plans are also included. Master blank worksheets are included to help the technician or water user.

Chapter 16, Special Use Tables, Charts, and Conversions—This chapter contains special use tables, charts, and conversion factors that are useful in the planning, design, and evaluation processes. English units are used along with metric conversions as they reasonably apply. A complete metric conversion table relating to irrigation is included.

Chapter 17, Glossary and References—This chapter contains a list and definition of the more commonly used irrigation terms. Many terms are local, and some duplication is necessary. References available and used in irrigation system planning, design, management, and evaluation are included.

652.0105 Use of computers

Only state approved computer software is available to the field office for official use. These programs help to facilitate planning, design, and evaluation of irrigation systems and related components. The technician or engineer is fully responsible for plan or design integrity, adequate documentation, and obtaining necessary reviews and engineering approval.

Information contained in this guide describes availability and use of computer software for performing certain tasks. Additions or revisions to the guide including instructions or references to user manuals will be made as new software becomes available.

652.0106 State supplement

WA652.0106 Introduction

(a) General Information

The Washington supplement to the National Engineering Handbook (NEH), Part 652, Irrigation Guide, has been adapted from the original Washington Irrigation Guide and has been prepared to cover all areas of Washington state. One set of guidelines is considered adequate for the entire state, with the exception of water requirements for crops. This information can be obtained from the attachment to Chapter 4, Water Requirements. Another planning tool for locations and crops not shown in the Chapter 4 attachment is the Irrigation Water Requirements (IWR) software. This software is explained and examples shown.

The state supplements were developed to assist engineers, technicians, and others working with Washington irrigators to provide general planning criteria on various methods of irrigation commonly used in the state. When the irrigation system is installed and operated in accordance with basic data, the irrigator is assured first of all, that the system will be capable of supplying the amounts of water needed by plants for optimum production and, secondly, that with proper seasonal adjustments, irrigation water can be applied efficiently.

The irrigation planner must be aware that every irrigation system should minimize erosion. Polymer is very useful for this. Alternatives include a tailwater recovery system with polymer or polymer alone for areas where waste water is recycled to lower irrigators. Tailwater systems and polymer is discussed further in the Washington Field

Office Technical Guide (FOTG) and NEH652, Chapter 7.

Recommendations relating to economic evaluation of irrigation systems are included in NEH 652, Chapter 11. The economics of irrigation is usually an individual field or farm determination.

A map of the annual precipitation in Washington can be found on the Washington state NRCS web page. This is located under the FOTG, Section 1, Maps, and Climatic data. The link to the NRCS is listed below: <http://efotg.nrcs.usda.gov/treemenuFS.aspx?Fips=53025&MenuName=menuWA.zip>

(b) Irrigation Specifications

Commonly used methods of water application are given in Parts WA652.0505 and WA652.0605 of this guide. The specific methods adapted for each soil group, each crop, and each slope group are listed. Applicable specifications are also given.

The sprinkler irrigation specifications have not been shown in the irrigation design sheets because of the numerous sprinkler types available and their varied requirements. However, the suitability of sprinkler irrigation for use in each soil group, crop, and slope group is shown in the irrigation design sheets. Sprinkler criteria and installation guidance is given in Chapter 6 and Part WA652.0605 for drip (trickle) irrigation and subsurface drip irrigation (SDI),

(c) Control of Erosion

This guide contains the maximum slope recommendations for each crop and method along with companion practices such as terraces and contouring for the various soils

under normal conditions to prevent excessive water erosion whether by irrigation or by rainfall. The guide also designates irrigation water application rates, stream sizes, length of run, and time of irrigation to minimize erosion.

The conservation treatment of irrigated land for wind and water erosion is listed in the Field Office Technical Guide, Section I-A.

(d) Conservation Treatment Specifications

Section IV of the Field Office Technical Guide contains specifications for conservation treatment practices. Standards and specifications for such irrigation component practices including: land leveling; underground irrigation pipeline; canal and ditch lining; farm irrigation structures; and tailwater recovery systems. Others are also found in Section IV of the Field Office Technical Guide.

(e) Procedure Guide for Irrigation Land Development

(1) Criteria for irrigation systems

The design of all irrigation systems shall follow the criteria in Part WA652.0605 and conform to the requirements outlined in the applicable Washington standards and specifications.

(2) Basic information

The following basic information must be considered when planning and designing an irrigation system:

(i) A water quality analysis

SDI systems will need a water quality analysis, including problems with sand or grit, prior to system design.

A water quality analysis is provided by the irrigator. For information on a water quality analysis, refer to Agriculture Handbook No. 60, "Diagnosis and Improvement of Saline and Alkali Soils," Chapter 5, Quality of Irrigation Water, and/or "Determining Water Quality for Irrigation," C 396, Revised November 1975, issued by the Washington Cooperative Extension Service. Usual salinity limits of water are based on electrical conductivity (millimhos per centimeter) as follows:

- < 0.75 mmhos - Safe water
- 0.75-2.25 mmhos - Safe where drainage is adequate
- > 2.25 mmhos - Very limited use on high salt tolerance crops in large quantities and very good subsoil drainage.

Note: Convert millimhos to micromhos by multiplying by 1,000:

$$0.75 \text{ mmhos} \times 1,000 = 750 \text{ micromhos}$$

For detailed information, refer to Chapter 13, "Quality of Water Supply".

(ii) Quantity of water available

Water right information shall be obtained from the Washington Department of Ecology for the authorized place of use.

(iii) Topographic or grid map

(iv) Soils information from Part WA652.0204

Soils not listed in the guide--The soil scientist will make the following determinations in the field:

- Effective soil depth, texture, permeability, slope, erosion, and fertility potential.
- Intake rate with the effective rooting depth and water holding capacity.

Preparation of soils report--The soil scientist will then prepare a soils report and submit it to the state soil scientist for review. Upon the concurrence of the state soil scientist that the soil is suitable for irrigation, all field locations will be advised to list this information in the appropriate place in Part WA652.0204.

(3) Guidelines

In developing an overall irrigation system plan, the following guidelines should be observed and included:

(i) Conservation cropping system--This will be developed in accordance with the Washington Standard and Specifications for Conservation Cropping System - 328. This may be listed on the irrigation development plan or in the case file with adequate cross references.

(ii) Amount of land to be developed for irrigation using surface irrigation methods--This will depend on the planned cropping system, the intensity of irrigation desired by the irrigator, and the amount of irrigation water available.

To determine the maximum irrigated acres, use the procedure outlined in Part WA652.0605. This indicates the crop acres that can be completely irrigated throughout

the growing season with no limitation of crop production due to moisture.

In some cases, the irrigator may desire or need to adjust the system operation to something less than maximum as far as pumping time and water use are concerned. Factors including high energy costs, restrictions on water use, type of cropping system, and other items may dictate this choice. Usually irrigations will be limited to several pre-selected times during critical crop-growing periods. There may be other instances where the irrigator will use the same irrigation frequency, except he will use the maximum water available and adjust the irrigated acres accordingly.

If supplemental irrigation is planned, the amount of irrigated acres will usually be determined by the irrigation intensity desired. For example, in western Washington where average annual rainfall is over 35 inches, the amount of irrigated acreage is usually based on providing 1 or 2 net applications from 2 to 4 inches. The primary purpose is to provide supplemental moisture during a dry period that usually occurs each summer at a critical stage of crop growth.

(iii) Lands subject to flood scour and/or deposition more frequently than once every 10 years --These lands should *not* be developed for irrigation.

(iv) Fields planned for land leveling--These fields shall meet the requirements of Washington Standard and Specifications for Irrigation Land Leveling - 464.

(v) Irrigation Water Management --The IWM plan will be a part of the irrigation system design. This plan shall meet the requirements

of Washington Standard and Specification for
Irrigation Water Management - 449.

(vi) Tailwater recovery pits--These will be
part of the irrigation plan if required under the
conditions listed in the Washington Standard
and Specifications for Irrigation System,
Tailwater Recovery - 447.

Chapter 2

Soils

Contents:	652.0200	Introduction	2-1
	652.0201	General	2-1
		(a) Soil survey	2-1
		(b) Soil survey data base	2-2
		(c) Soil limitations for irrigation	2-2
	652.0202	Physical soil characteristics	2-4
		(a) Soil properties and qualities	2-4
		(b) Soil-water holding capacity	2-4
		(c) Soil intake characteristics	2-17
		(d) Organic matter	2-28
		(e) Soil depth	2-28
		(f) Slope	2-29
		(g) Water tables	2-29
		(h) Soil erodibility	2-29
		(i) Chemical properties	2-31
		(j) Saline and sodic soil effects	2-31
		(k) Soil reaction/acidity	2-32
	652.0203	Explanation of tables and data bases	2-34
	652.0204	State supplement	2-34
		(a) Soil surveys	2-34
		(b) Soil properties	2-34

Tables	Table 2-1	Available water capacity (AWC) by texture	2-5
	Table 2-2	Correction of available water capacity for rock fragment content	2-6
	Table 2-3	Available water capacity adjustment factors	2-7
	Table 2-4	Available water capacity adjustments because of salinity	2-10

Table 2-5	General terms, symbols, and size of soil separates for basic soil texture classes	2-11
Table 2-6	Soil intake ranges by surface texture	2-17
Table 2-7	Maximum net application amounts with zero potential runoff for center pivot systems	2-21
Table 2-8	Maximum sprinkler application rate—periodic move and fixed set sprinkler (for alfalfa-grass, grass, or clean tilled with residue > 4,000 lb/ac)	2-22
Table 2-9	Soil intake family adjustment factors	2-23
Table 2-10a	Amount of surface storage needed for no runoff—Silty clay	2-25
Table 2-10b	Amount of surface storage needed for no runoff—Silty clay loam	2-25
Table 2-10c	Amount of surface storage needed for no runoff—Silt loam	2-26
Table 2-10d	Amount of surface storage needed for no runoff—Loam	2-26
Table 2-10e	Amount of surface storage needed for no runoff—Fine sandy loam	2-26
Table 2-10f	Amount of surface storage needed for no runoff—Loamy fine sand	2-26
Table 2-10g	Amount of surface storage needed for no runoff—Fine sand	2-27
Table 2-11	Estimated effective basin surface storage	2-28
Table 2-12	Surface storage available for rough and cloddy bare ground	2-28
Table 2-13	Surface storage available with residue	2-28
Table 2-14	Soil erodibility hazard (S K values) for surface irrigation	2-30
Table 2-15	Soil properties and design values for irrigation	2-34

Figures	Figure 2-1	Typical water release curves for sand, loam, and clay	2-9
	Figure 2-2	Examples of soil structure	2-13
	Figure 2-3	Intake families for border and basin irrigation design	2-18
	Figure 2-4	Intake families for furrow irrigation design	2-19
	Figure 2-5a	Nomenclature—dike spacing and height; furrow width and ridge height and spacing	2-27
	Figure 2-5b	Dike spacing, height, and surface storage capacity	2-27
	Figure 2-6	Water table contribution to irrigation requirement, as a function of soil type (texture) and water table depth	2-29
	Figure 2-7	Example soil-water retention curves for clay loam soil at varying levels of soil salinity— EC_e	2-31
	Figure 2-8	Threshold values of sodium adsorption ratio of topsoil and electrical conductivity of infiltrating water associated with the likelihood of substantial losses in permeability	2-32
	Figure 2-9	Effect of pH on nutrient availability in soils	2-33
Exhibits	Exhibit 2-1	Soil properties, limits, and restrictive features for irrigation	2-3
	Exhibit 2-2	Process to determine total volume of water held in a soil	2-16

652.0200 Introduction

Plant response to irrigation is influenced by the physical condition, fertility, and biological status of the soil. Soil condition, texture, structure, depth, organic matter, bulk density, salinity, sodicity, acidity, drainage, topography, fertility, and chemical characteristics all determine the extent to which a plant root system grows into and uses available moisture and nutrients in the soil. Many of these factors directly influence the soil's ability to store, infiltrate, or upflux water delivered by precipitation or irrigation (including water table control). The irrigation system(s) used should match all or most of these conditions.

Many conditions influence the value of these factors. The estimated values for available water capacity and intake are shown as rather broad ranges. Working with ranges is a different concept than used in previous irrigation guides. In the field, ranges are normal because of many factors. The values in local soils data bases need to be refined to fit closer to actual field conditions. The actual value may vary from site to site on the same soil, season to season, and even throughout the season. It varies throughout the season depending on the type of farm and tillage equipment, number of tillage operations, residue management, type of crop, water quality, and even water temperature.

Soils to be irrigated must have adequate surface and subsurface drainage. Internal drainage within the crop root zone can be either natural or from an installed subsurface drainage system.

This guide describes ways to interpret site conditions for planning and design decisions. Where necessary, actual field tests should be run to determine specific planning and design values for a specific field. Evaluation results can also be used to fine tune individual irrigation system operations and management. When a particular soil is encountered frequently in an area, efforts should be made to gather field data to verify the site conditions or to use in refining values in the guide. These field derived values should be added as support for data presented in the guide.

652.0201 General

Soil consists of mineral and organic materials, covering much of the Earth's surface. It contains living matter, air, and water, and can support vegetation. People have altered the soil in many places. Soil is one of the resources of major concern to USDA and the Natural Resources Conservation Service. The soil functions as a storehouse for plant nutrients, as habitat for soil organisms and plant roots, and as a reservoir for water to meet evapotranspiration (ET) demands of plants. It contains and supplies water, oxygen, nutrients, and mechanical support for plant growth.

Soil is a basic irrigation resource that determines how irrigation water should be managed. The amount of water the soil can hold for plant use is determined by its physical and chemical properties. This amount determines the length of time that a plant can be sustained adequately between irrigation or rainfall events, the frequency of irrigation, and the amount and rate to be applied. Along with plant ET, it also determines the irrigation system capacity system needed for desired crop yield and product quality.

(a) Soil survey

NRCS is responsible for leadership of the National Cooperative Soil Survey. Partners include other Federal, State, and local agencies and institutions. Soil survey data and interpretations have information that can be used for planning, design, and management decisions for irrigation.

Soil map units represent an area on the landscape and consist of one or more soils for which the unit is named. Single fields are rarely a single map unit or a single soil. Many soil map units include contrasting soil inclusions considered too minor to be a separate map unit. Because of variations in soil properties that exist in map units, additional onsite soils investigations are often needed.

Soil properties within a profile can be modified by land grading, deep plowing, subsoiling, or other deep tillage practices. Shallow tillage practices can affect water infiltration and soil permeability rates. These property changes may not be reflected in the map unit description. Personnel doing irrigation planning are expected to obtain accurate onsite soil information to make recommendations. Adjacent farms may need different recommendations for the same soil series because different equipment, tillage practices, and number of tillage operations are used.

(b) Soil survey data base

Soil survey data are available from the local National Soil Information System (NASIS) Map Unit Interpretation Record (MUIR) soil data base on the Field Office Computing System (FOCS). Irrigation related software applications access this data base through a soil characteristics editor to create point data located within a field or operating unit. Where maximum and minimum ranges of soil attribute data are contained in the data base (for example, percent rock or available water capacity), the editor can be used to select or input the appropriate value. If a soil profile has been examined in the field, then data for the profile are entered instead of using the data base. Soil data points created in this way can be used to create summary soil reports, or the data can be used directly either manually or in irrigation related software applications.

(c) Soil limitations for irrigation

Exhibit 2-1 displays soil limitations when determining the potential irrigability of a soil. It displays specific limits and restrictive features for various soil properties; however, it does not necessarily mean the soil should not be irrigated. A restriction indicates there are limitations for selection of crops or irrigation method and will require a high level of management. Some restrictions may require such an excessive high level of management that it may not be feasible to irrigate that soil. Likewise, a deep well drained loamy soil with minor restrictions can become nonirrigable due to poor water management decisions and cultural practices.

Exhibit 2-1 Soil properties, limits, and restrictive features for irrigation^{1/}

Property	Limits	Restrictive features
USDA surface texture	COS, S, FS, VFS, LCOS, LS, LFS, LVFS	High intake for surface irrigation systems.
USDA surface texture	SIC, C, CS	Low intake for level basin and center pivot irrigation systems.
Slope surface	>3%	Water runoff.
Weight percent of stone particles >3" (weighted avg. to 40" depth)	>25%	Large stones, reduced plant root zone AWC.
Ponding	+	Soil air is removed.
Depth to high water table during growing season	<3 ft	Restricted plant root zone.
Available water capacity (weighted avg. to 40" depth)	<.05 in/in	Limited soil water storage for plant growth.
Wind erodibility group	1, 2, 3	Soil blowing damages young plants, reduces crop yield and quality.
Permeability, 0-60"	<.02 in/hr	Water percolates slowly.
Depth to bedrock	<40 in	Restricted plant root zone.
Depth to cemented pan	<40 in	Restricted plant root zone.
Erosion factor of surface, k	>.35	Erodes easily.
Flooding	Occasionally, frequently	Soil air is removed, plants damaged.
Salinity, 0-40"	>1 dS/m	Excess calcium and magnesium ions.
Sodicity, 0-40" SAR	>13	Excess sodium ions.
Calcium carbonate equivalent (% in thickest layer, 10-60" depth)	>40	Excess lime.
Sulfidic materials, Great Group	Sulfaquents, sulfihemists	Excess sulfur.
Soil reaction, pH, at any depth 0-60"	<5.0 or >8.0	Too acid or too alkaline.

1/ Part 620, NRCS, National Soil Survey Handbook, 1993.

652.0202 Physical soil characteristics

(a) Soil properties and qualities

Soil properties and qualities are important in design, operation, and management of irrigation systems. These properties include water holding capacity, soil intake characteristics, permeability, soil condition, organic matter, slope, water table depth, soil erodibility, chemical properties, salinity, sodicity, and soil reaction (pH).

(b) Soil-water holding capacity

The potential for a soil to hold water is important in designing and managing an irrigation system. Total water held by a soil is called water holding capacity. However, not all soil-water is available for extraction by plant roots. The volume of water available to plants that a soil can store is referred to as available water capacity.

(1) Available Water Capacity (AWC)

This is the traditional term used to express the amount of water held in the soil available for use by most plants. It is dependent on crop rooting depth and several soil characteristics. Units of measure are expressed in various terms:

- Volume unit as inches of water per inch or per foot of soil depth
- Gravimetric percent by weight
- Percent on a volume basis

In fine textured soils and soils affected by salinity, sodicity, or other chemicals, a considerable volume of soil water may not be available for plant use.

(2) Soil-water potential

Soil-water potential is a more correct way to define water available to plants. It is the amount of work required per unit quantity of water to transport water in soil. In the soil, water moves continuously in the direction of decreasing potential energy or from higher water content to lower water content. The concept of soil-water potential replaces arbitrary gravitational, capillary, and hygroscopic terms. Total water potential

consists of several components. It is the sum of matric, solute, gravitational, and pressure potential. Refer to the National Engineering Handbook (NEH), Section 15, Chapter 1, Soil-Plant-Water Relationships for a detailed explanation of this concept.

The soil-water potential concept will become more integrated into field procedures as new procedures evolve. For practical reasons, the terms and concepts of field capacity and permanent wilting point are maintained. Units of bars and atmospheres are generally used to express suction, tension, stress, or potential of soil water.

(i) Field capacity—This is the amount of water a well-drained soil holds after *free* water has drained because of gravity. For coarse textured soil, drainage occurs soon after irrigation because of relatively large pores and low soil particle surface tension. In fine textured soil, drainage takes much longer because of smaller pores and their horizontal shape. Major soil properties that affect field capacity are texture, structure, bulk density, and strata within the profile that restrict water movement. Generally, fine textured soil holds more water than coarse textured soil. Some soils, such as some volcanic and organic soils, are unique in that they can retain significant volumes of water at tensions less than one-tenth bar, thereby giving them a larger available water capacity.

An approximation of field capacity soil-water content level can be identified in the laboratory. It is the water retained in a soil when subjected to a tension of one-tenth atmosphere (bar) for sandy soils and one-third atmosphere for other finer textured soils.

Field capacity water content level can be estimated in the field immediately following a rain or irrigation, after free water has drained through the soil profile. Some judgment is necessary to determine when free water has drained and field capacity has been reached. Free water in coarse textured soils (sandy) can drain in a few hours. Medium textured (loamy) soils take approximately 24 hours, while fine textured (clayey) soils may take several days.

(ii) Permanent wilting point—This is the soil-water content at which most plants cannot obtain sufficient water to prevent permanent tissue damage. The lower limit to the available water capacity has been reached for a given plant when it has so ex-

hausted the soil moisture around its roots as to have irrecoverable tissue damage, thus yield and biomass are severely and permanently affected. The water content in the soil is then said to be the permanent wilting percentage for the plant concerned.

Experimental evidence shows that this water content point does not correspond to a unique tension of 15 atmospheres for all plants and soils. The quantity of water a plant can extract at tensions greater than this figure appears to vary considerably with plant species, root distribution, and soil characteristics. Some plants show temporary plant moisture stress during hot daytime periods and yet have adequate soil moisture. In the laboratory, permanent wilting point is determined at 15 atmospheres tension. Unless plant specific data are known, any water remaining in a soil at greater than 15 atmosphere tension is considered unavailable for plant use.

Major soil characteristics affecting the available water capacity are texture, structure, bulk density, salinity, sodicity, mineralogy, soil chemistry, and organic matter content. Of these, texture is the predominant factor in mineral soils. Because of the particle configuration in certain volcanic ash soils, these soils can contain very high water content at field capacity levels. This provides a high available water capacity value. Table 2-1 displays average available water capacity based on soil texture. Table 2-2 provides adjustments to the available water capacity based on percent rock fragments. Generally, rock fragments reduce available water capacity.

The available water capacity value shown on the Soil Interpretation Record (SOI-5) accounts for the estimated volume of coarse fragments for the specific soil series. However, any additional coarse fragments found upon field checking must be accounted for. Coarse fragments of volcanic material, such as pumice and cinders, can contain water within the fragments themselves, but this water may not be available for plant use because of the restricted root penetration and limited capillary water movement. A process to adjust the available water capacity based on additional field information is displayed in table 2-3.

Table 2-1 Available water capacity (AWC) by texture

Texture symbol	Texture	AWC range (in/in)	AWC range (in/ft)	Est. typical AWC (in/ft)
COS	Coarse sand	.01 – .03	.1 – .4	.25
S	Sand	.01 – .03	.1 – .4	.25
FS	Fine Sand	.05 – .07	.6 – .8	.75
VFS	Very fine sand	.05 – .07	.6 – .8	.75
LCOS	Loamy coarse sand	.06 – .08	.7 – 1.0	.85
LS	Loamy sand	.06 – .08	.7 – 1.0	.85
LFS	Loamy fine sand	.09 – .11	1.1 – 1.3	1.25
LVFS	Loamy very fine sand	.10 – .12	1.0 – 1.4	1.25
COSL	Coarse sandy loam	.10 – .12	1.2 – 1.4	1.3
SL	Sandy loam	.11 – .13	1.3 – 1.6	1.45
FSL	Fine Sandy Loam	.13 – .15	1.6 – 1.8	1.7
VFSL	Very fine sandy loam	.15 – .17	1.8 – 2.0	1.9
L	Loam	.16 – .18	1.9 – 2.2	2.0
SIL	Silt loam	.19 – .21	2.3 – 2.5	2.4
SI	Silt	.16 – .18	1.9 – 2.2	2.0
SCL	Sandy clay loam	.14 – .16	1.7 – 1.9	1.8
CL	Clay loam	.19 – .21	2.3 – 2.5	2.4
SICL	Silty clay loam	.19 – .21	2.3 – 2.5	2.4
SC	Sandy clay	.15 – .17	1.8 – 2.0	1.9
SIC	Silty clay	.15 – .17	1.8 – 2.0	1.9
C	Clay	.14 – .16	1.7 – 1.9	1.8

Table 2-2 Correction of available water capacity for rock fragment content ^{1/}

Soil	----- % coarse fragments (by volume) -----								
	0	10	20	30	40	50	60	65	70
	----- % passing #10 sieve (by weight) -----								
	100	85	70	55	45	35	25	20	20
----- Available water capacity (in/in) -----									
Clay	.14-.16	.12-.14	.11-.12	.09-.10	.08-.09	.06-.07	.05-.06	.04-.05	.03-.04
Silty clay	.15-.17	.13-.15	.11-.13	.10-.11	.08-.10	.07-.08	.06-.07	.05-.06	.04-.05
Sandy clay	.15-.17	.13-.15	.12-.14	.10-.11	.08-.09	.07-.08	.06-.07	.04-.05	.04
Silty clay loam	.19-.21	.17-.19	.15-.17	.13-.15	.11-.13	.09-.11	.08-.09	.06-.07	.06
Clay loam	.19-.21	.17-.19	.15-.17	.13-.15	.11-.13	.09-.11	.08-.09	.06-.07	.06
Sandy clay loam	.14-.16	.12-.14	.11-.13	.10-.11	.08-.10	.07-.08	.06-.07	.05-.06	.04-.05
Silt loam	.19-.21	.17-.19	.15-.17	.13-.15	.11-.13	.09-.11	.08-.09	.06-.07	.06
Loam	.16-.18	.14-.16	.13-.14	.11-.13	.10-.11	.08-.09	.07-.08	.05-.06	.05
Very fine sandy loam	.15-.17	.13-.15	.12-.14	.10-.12	.09-.10	.07-.09	.07-.08	.05-.06	.04-.05
Fine sandy loam	.13-.15	.12-.14	.10-.12	.09-.11	.08-.09	.06-.08	.06-.07	.04-.05	.04-.05
Sandy loam	.11-.13	.10-.12	.09-.10	.07-.09	.07-.08	.05-.07	.05-.06	.04-.05	.03-.04
Loamy very fine sand	.10-.12	.09-.11	.08-.10	.07-.08	.06-.07	.05-.06	.04-.05	.03-.04	.03-.04
Loamy fine sand	.09-.11	.08-.10	.07-.09	.06-.07	.05-.07	.04-.06	.04-.05	.03-.04	.03
Loamy sand	.06-.08	.05-.07	.05-.06	.04-.06	.04-.05	.03-.04	.03-.04	.02-.03	.02
Fine sand	.05-.07	.04-.06	.04-.06	.03-.05	.03-.04	.03-.04	.02-.03	.02-.03	.01-.02

^{1/} Use this chart only when NASIS or more site specific information is not available. Compiled by NRCS, National Soil Survey Laboratory, Lincoln, Nebraska.

Table 2-3 Available water capacity adjustment factors ^{1/}

Modifying factor (%)	" + " Increased AWC	" - " Decreased AWC
Rock content		Rocks decrease soil and pore space volume
Sodicity		Sodium salts disperse clays, decreases soil aggregation and destroys structure increasing soil density.
Salinity		Increased salt concentration makes it more difficult for the plant to take in water by osmosis. The tension required to extract water from the soil is increased.
Organic matter (0 to +10%)	In general, OM increases aggregation and improves soil structure, decreases soil density, and increases AWC. In sandy soils, OM provides fine particles, which effectively reduces average particle size.	
Soil structure (-10% to +10%)	Granular, blocky, columnar and Prismatic (low density)	Single grain (sand - large sized pores release large proportion of gravitational water). Massive or platy (usually high density).
Compaction (-20% to 0)		Compaction increases soil density, reduces pore space and decreases permeability.
Restrictive layers (0 to +10%)	Restrictive layers in the subsoil can effectively increase AWC of upper layers after an irrigation or rain. Water, held up by the restrictive layer, has the potential to be all or partially used by the plants.	Restrictive layers can restrict root development and water movement lower in the soil profile.

See footnote at end of table.

Table 2-3 Available water capacity adjustment factors ^{1/}—Continued

Modifying factor (%)	" + " Increased AWC	" - " Decreased AWC
Soil condition—the soil's physical condition related to tillage, micro-organism activity, erosion. (-10% to +10%)	Good soil condition results in decreased soil density, increased soil micro-organism activity, increased pore space.	Poor soil condition results in increased soil density, a more massive soil structure, decreased pore space, decreased soil micro-organism activity.
Depth within the soil come profile (-5% per foot)		In general, with increased depth, soils become more consolidated or dense, are affected by mineralization, have less structure and organic matter.
Vegetative cover (0 to +5%)	Root penetration improves soil structure and condition, and decreases soil density.	

^{1/} Density can make AWC differences of -50% to +30% compared to average densities. Dense soils have low available water capacity because of the decreased pore space.

Different soils hold water and release it differently. When soil-water content is high, very little effort is required by plant roots to extract moisture. As each unit of moisture is extracted, the next unit requires more energy. This relationship is referred to as a soil moisture release characteristic. Figure 2-1 shows water release curves for typical sand, loam, and clay soils. The tension in the plant root must be greater than that in the soil at any water content to extract the soil water. Typically with most field crops, crop yield is not affected if adequate soil water is available to the plant at less than 5 atmospheres for medium to fine textured soils.

At soil-water tensions of more than about 5 atmospheres, plant yield or biomass is reduced in medium to fine textured soils.

Salts in the soil-water solution decrease the amount of water available for plant uptake. Maintaining a higher soil-water content with more frequent irrigations relieves the effect of salt on plant moisture stress. Table 2-4 displays AWC values adjusting for effect of salinity versus texture. EC_e is defined as the electrical conductivity of the soil-water extract corrected to 77 °F (25 °C). Units are expressed in millimhos per centimeter (mmho/cm) or deci Siemen per meter (dS/m). 1 mmho/cm = 1dS/m. See section 652.0202(i) for additional information.

Tension levels for field capacity and wilting point in table 2-4 are assumed.

AWC is the major soil factor in irrigation scheduling. Only a partial depletion of the AWC should be allowed. For most field crops and loamy soils, 50 percent is allowed to be depleted to limit undue plant moisture stress. For most vegetables, 30 percent depletion is desirable. As an example, data from figure 2-1 provides the following approximate potential (tension) levels for three general soil types:

Soil	Tension at 50% depletion	Tension at 30% depletion	Depletion at 5 bars tension
clay	4.5 bars	2.5 bars	55%
loam	2 bars	1.2 bars	70%
sand	< 1 bars	< 1 bars	84%

Allowed soil-water depletion is a management decision based on the type of crop grown, stage of crop growth, total AWC of the soil profile, rainfall patterns, and the availability of the pumped or delivered water. It is referred to as the Management Allowed Depletion, or MAD level. See Chapter 3, Crops, for MAD levels for optimum yield and quality of most crops. The conventional concepts of total soil volume AWC and MAD do not apply to microirrigation where root volumes and wetted volumes are restricted.

NEH, Section 15, Chapter 1, Soil-Plant-Water Relationships provides an excellent and thorough description of soil-water relationships; therefore, the information included here is quite limited.

Figure 2-1 Typical water release curves for sand, loam, and clay

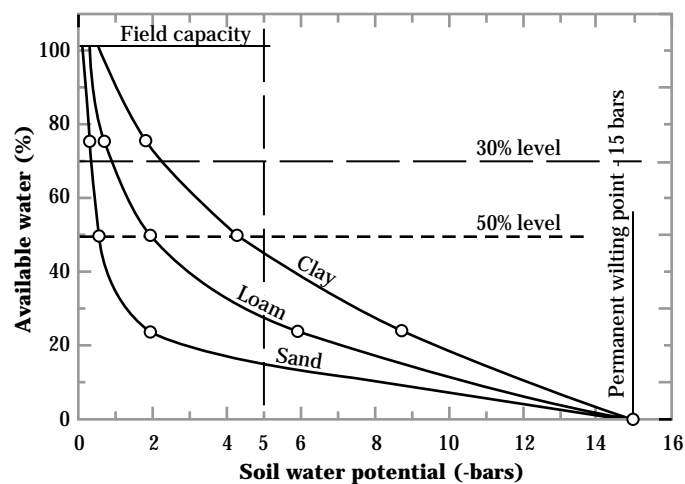

Texture	Tension level (atmospheres or bars)	
	@ field capacity	@ Perm. wilting point
Course	0.1	15.0
Medium & fine	0.33	15.0

Table 2-4 Available water capacity adjustments because of salinity ^{1/}

Soil texture	Electrical conductivity (IC _e x 10 ³)							
	0	2	4	6	8	10	12	14
	----- Available water capacity (inch/inch) ^{2/} -----							
clay	.14-.16	.13-.15	.12-.14	.11-.13	.10-.12	.09-.11	.07-.08	.04-.05
silty clay	.15-.17	.14-.16	.13-.15	.12-.14	.11-.12	.09-.11	.07-.08	.05-.06
sandy clay	.15-.17	.14-.16	.13-.15	.12-.14	.11-.12	.09-.11	.07-.08	.05-.06
silty clay loam	.19-.21	.18-.20	.17-.18	.15-.17	.14-.15	.12-.13	.09-.10	.06-.07
clay loam	.19-.21	.18-.20	.17-.18	.15-.17	.14-.15	.12-.13	.09-.10	.06-.07
sandy clay loam	.14-.16	.13-.15	.12-.14	.11-.12	.09-.11	.08-.09	.06-.07	.03-.04
silt loam	.19-.21	.18-.20	.17-.18	.15-.17	.14-.15	.12-.13	.09-.10	.06-.07
loam	.16-.18	.15-.17	.14-.16	.13-.15	.12-.13	.10-.11	.08-.09	.05-.06
very fine sandy loam	.15-.17	.14-.16	.13-.15	.12-.14	.11-.12	.09-.11	.07-.08	.05-.06
fine sandy loam	.13-.15	.12-.14	.11-.13	.11-.12	.09-.11	.08-.09	.06-.07	.04-.05
sandy loam	.11-.13	.10-.12	.10-.11	.09-.11	.08-.09	.07-.08	.05-.06	.03-.04
loamy very fine sand	.10-.12	.10-.11	.09-.11	.08-.09	.07-.08	.06-.07	.04-.05	.02-.03
loamy fine sand	.09-.11	.09-.10	.08-.10	.07-.09	.06-.08	.06-.07	.04-.05	.03-.04
loamy sand	.06-.08	.06-.08	.05-.07	.05-.06	.04-.06	.04-.05	.03-.04	.02-.03
fine sand	.05-.07	.05-.07	.04-.06	.04-.06	.04-.05	.03-.04	.02-.03	.02

1/ Compiled by NRCS National Soil Survey Laboratory, Lincoln, Nebraska.

2/ 15 mmhos conductivity results in 75 to 95 percent reduction in available water capacity.

(3) Soil texture

Soil texture refers to the weight proportion of the soil separates (sand, silt, and clay) for the less than 2 mm fraction, as determined from a laboratory particle size distribution analysis. It defines the fineness or coarseness of a soil. Particle sizes larger than 2 mm are classed as rock or coarse fragments and are not used to define texture. Table 2-5 shows terms and symbols used in describing soil textures.

Fine textured soils generally hold more water than coarse textured soils. Medium textured soils actually have more available water for plant use than some clay soils. Water in clay soils can be held at a greater tension that reduces its availability to plants.

Figure 1-2, of NEH, Part 623, Chapter 1, Soil-Plant-Water Relationship, displays what is commonly referred to as the USDA textural triangle. It describes the proportions of sand, silt, and clay in the basic textural classes. Texture determines the amount of surface area on soil particles within the soil mass. Clay and humus both exist in colloidal state and have an extremely large surface area per unit weight. They carry surface electrical charges to which ions and water are attracted.

The USDA Soils Manual includes the following general definitions of soil textural classes in terms of field experience. These definitions are also specifically used in estimating soil-water content by the *feel and appearance method*. See Chapter 9, Irrigation Water Management and Chapter 15, Irrigation Water Management Plan.

Sand—Sand is loose and single-grained. The individual grains can be readily seen and felt. Squeezed in the hand when dry, sand falls apart when pressure is released. Squeezed when moist, it forms a cast, but crumbles when touched.

Sandy loam—A sandy loam is soil containing a high percentage of sand, but having enough silt and clay to make it somewhat coherent. The individual sand grains can be readily seen and felt. Squeezed when dry, a sandy loam forms a cast that falls apart readily. If squeezed when moist, a cast can be formed that bears careful handling without breaking.

Table 2-5 General terms, symbols, and size of soil separates for basic soil texture classes (USDA, SCS 1993)

Texture	Soil	Symbol	
Sandy soils:			
Coarse	Sands		
	Coarse Sand	COS	
	Sand	S	
	Fine sand	FS	
	Very fine sand	VFS	
	Loamy sands		
	Loamy coarse sand	LCOS	
	Loamy sand	LS	
	Loamy fine sand	LFS	
	Loamy very fine sand	LVFS	
Loamy soils:			
Moderately coarse	Coarse sandy loam	COSL	
	Sandy loam	SL	
	Fine sandy loam	FSL	
Medium	Very fine sandy loam	VFSL	
	Loam	L	
	Silt loam	SIL	
	Silt	SI	
Moderately fine	Clay loam	CL	
	Sandy clay loam	SCL	
	Silty clay loam	SICL	
Clayey soils:			
Fine	Sandy clay	SC	
	Silty clay	SIC	
	Clay	C	
Size of soil separates:			
Texture	Size (mm)	Texture	Size (mm)
GR	> 2.0	FS	0.25 – 0.10
VCOS	2.01.0	VFS	0.10 – 0.05
COS	1.0 – 0.5	SI	0.05 – 0.002
MS	0.5 – 0.25	C	< 0.002

Loam—A loam is soil having a relatively even mixture of different grades of sand, silt, and clay. It is friable with a somewhat gritty feel, but is fairly smooth and slightly plastic. Squeezed when dry, it forms a cast that bears careful handling, and the cast formed by squeezing the moist soil can be handled freely without breaking.

Silt loam—A silt loam is soil having a moderate amount of fine sand with a small amount of clay. Over half of the particles are silt size particles. When dry, a silt loam appears cloddy, but the lumps can be readily broken. When pulverized, it feels soft and floury. When wet, the soil runs together readily and puddles. Either dry or moist, silt loam forms a cast that can be handled freely without breaking. When moist and squeezed between thumb and finger, it does not ribbon, but has a broken appearance.

Clay loam—A clay loam is moderately fine-textured soil that generally breaks into clods or lumps that are hard when dry. When the moist soil is pinched between the thumb and finger, it forms a thin ribbon that breaks readily, barely sustaining its own weight. The moist soil is plastic and forms a cast that bears much handling. When kneaded in the hand, clay loam does not crumble readily, but works into a heavy compact mass.

Clay—A clay is fine-textured soil that usually forms very hard lumps or clods when dry and is very sticky and plastic when wet. When moist soil is pinched between thumb and finger, it forms a long flexible ribbon. Some clays that are very high in colloids are friable and lack plasticity at all moisture levels.

Organic—Organic soils vary in organic matter content from 20 to 95 percent. They generally are classified on the degree of decomposition of the organic deposits. The terms muck, peat, and mucky peat are commonly used. Muck is well-decomposed organic material. Peat is raw, undecomposed, very fibrous organic material in which the original fibers constitute all the material.

(4) Soil structure

Soil structure is the arrangement and organization of soil particles into natural units of aggregation. These units are separated from one another by weakness planes that persist through cycles of wetting and drying and cycles of freezing and thawing. Structure influences air and water movement, root development, and nutrient supply.

Structure type refers to the particular kind of grouping that predominates in a soil horizon. Single-grained and massive soils are structureless. In single-grained soils, such as loose sand, water percolates rapidly. Water moves very slowly through most clay soils. A more favorable water relationship occurs in soils that have prismatic, blocky and granular structure. Platy structure in fine and medium soils impedes the downward movement of water. See figure 2-2. Structure can be improved with cultural practices, such as conservation tillage, improving internal drainage, liming or adding sulfur to soil, using grasses in crop rotation, incorporating crop residue, and adding organic material or soil amendments. Structure can be destroyed by heavy tillage equipment or excess operations.

Texture, root activity, percent clay, percent organic matter, microbial activity, and the freeze-thaw cycle all play a part in aggregate formation and stability. Some aggregates are quite stable upon wetting, and others disperse readily. Soil aggregation helps maintain stability when wet, resist dispersion caused by the impact from sprinkler droplets, maintain soil intake rate, and resist surface water and wind erosion. Irrigation water containing sodium can cause dispersing of soil aggregates. See discussion of SAR in Section 652.0202(i). Clay mineralogy has a major influence on soil aggregation and shrink-swell characteristics. See NEH, part 623, chapter 1, for additional discussion.

Figure 2-2 Examples of soil structure

Platy—The units are flat and plate-like. They are generally oriented horizontal. (Soil Survey Manual, fig. 3-26, p. 159)



Prismatic—The individual units are bounded by flat to rounded vertical faces. Units are distinctly longer vertically, and the faces are typically casts or molds of adjoining units. Vertices are angular or subrounded; the tops of the prisms are somewhat indistinct and normally flat. (Soil Survey Manual, fig. 3-27, p. 159)



Figure 2-2 Examples of soil structure—Continued

Columnar—The units are similar to prisms and are bounded by flat or slightly rounded vertical faces. The tops of columns, in contrast to those of prisms, are very distinct and normally rounded. (Soil Survey Manual, fig. 3-28, p. 160)



Blocky—The units are block like or polyhedral. They are bounded by flat or slightly rounded surfaces that are casts of the faces of surrounding peds. Typically, blocky structure units are nearly equi-dimensional, but grade to prisms and plates. The structure is further described as angular blocky (with sharp corners) and subangular blocky (with rounded corners). (Soil Survey Manual, fig. 3-29, p. 161)

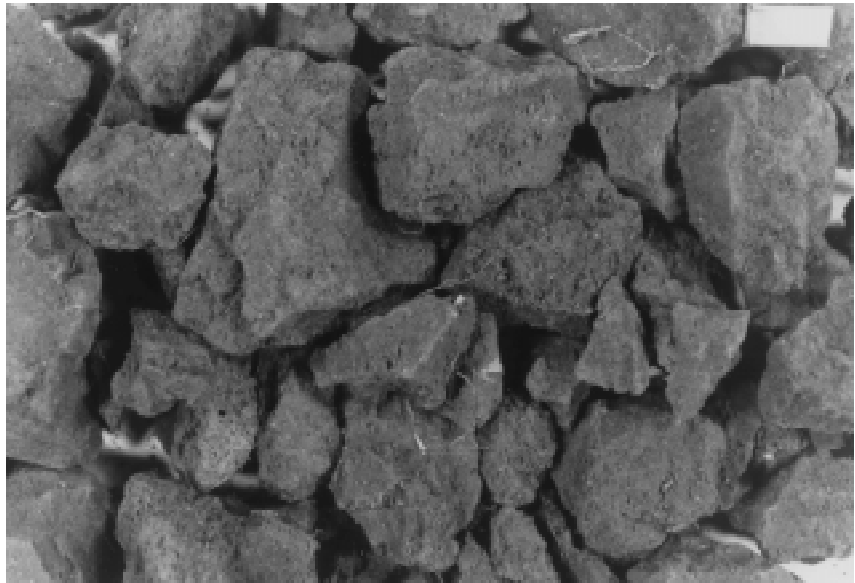

Figure 2-2 Examples of soil structure—Continued

Granular—The units are approximately spherical or polyhedral and are bounded by curves or irregular faces. (Soil Survey Manual, fig. 3-30, p. 161)



(5) Soil bulk density

Refers to the weight of a unit volume of dry soil, which includes the volume of solids and pore space. Units are expressed as the weight at oven-dry and volume at field capacity water content, expressed as grams per cubic centimeter (g/cc) or pounds per cubic foot (lb/ft³). Soil is composed of soil particles, organic matter, water, and air.

(6) Soil pore space

Bulk density is used to convert water measurements from a weight basis to a volume basis that can be used for irrigation related calculations. Many tools are available to measure bulk density in the field as well as in the laboratory. They are described in Chapter 9, Irrigation Water Management. Exhibit 2-2 displays the process to determine the total volume of water held in a soil.

Pore space allows the movement of water, air, and roots. Dense soils have low available water capacity because of decreased pore space. Density can make AWC differences of -50 percent to +30 percent compared to average densities. Sandy soils generally have bulk densities greater than clayey soils. Sandy soils

have less total pore space than silt and clay soils.

Gravitational water flows through sandy soils much faster because the pores are much larger. Clayey soils hold more water than sandy soils because clay soils have a larger volume of small, flat-shaped pore spaces that hold more capillary water. Clay soil particles are flattened or platelike in shape, thus, soil-water tension is also higher for a given volume of water. When the percent clay in a soil increases over about 40 percent, AWC is reduced even though total soil-water content may be greater. Permeability and drainability of soil are directly related to the volume and size and shape of pore space.

Uniform plant root development and water movement in soil occur when soil profile bulk density is uniform, a condition that seldom exists in the field. Generally, soil compaction occurs in all soils where tillage implements and wheel traffic are used. Compaction decreases pore space, decreasing root development, oxygen content, and water movement and availability. Other factors affecting soil bulk density include freeze/thaw process, plant root growth and decay, worm-holes, and organic matter.

Exhibit 2-2 Process to determine total volume of water held in a soil

<p>Let: D_b = bulk density D_p = particle density (specific gravity) W_s = weight of soil solids (oven dry) W_w = weight of soil water V_s = volume of solids V_p = volume of pores (both air & water) V_w = volume of water $V_s + V_p$ = total soil volume</p> $D_b = \frac{W_s}{V_s + V_p} \quad D_p = \frac{W_s}{V_s} \quad D_b \times V_s = D_p (V_s + V_p)$ $\frac{V_s}{V_s + V_p} = \frac{D_b}{D_p} \quad \% \text{ Solids} = \frac{V_s}{V_s + V_p} \times 100 = \frac{D_b}{D_p} \times 100$ $\% \text{ pore space} = 100 - \left(\frac{D_b}{D_p} \times 100 \right) \quad \% \text{ water} = \frac{W_w}{W_s} \times 100$ $\% \text{ volume of water} = \frac{V_w}{V_s + V_p} \times 100 = \frac{W_w}{W_s} \times D_b \times 100$ $\text{Volume of water (in/ft)} = \frac{\% \text{ volume of water} \times 12 \text{ in/ft}}{100}$	<p>Schematic:</p>
---	--------------------------

(c) Soil intake characteristics

Soil intake/water infiltration is the process of water entering the soil at the soil/air interface. NEH, Part 623, Chapter 1, Soil-Plant-Water Relationship provides detailed discussion of the water infiltration process.

Infiltration rates change during the time water is applied, typically becoming slower with elapsed time. They typically decrease as the irrigation season progresses because of cultivation and harvest equipment. This is especially true if operations are done at higher soil-water content levels. Preferential flow paths, such as cracks and wormholes, influence infiltration and permeability. Infiltration rates are also affected by water quality; for example, suspended sediment, temperature, sodicity, and SAR, affect water surface tension.

Soil intake characteristics affect design, operation, and management of surface irrigation systems.

(1) Surface irrigation systems

The water infiltration capability of a soil is referred to as soil intake characteristic. For surface irrigation systems, intake characteristic is expressed by the equation:

$$F = aT_o^b + c$$

where:

- F = Cumulative intake for an opportunity time period (inches)
- a = Intercept along the cumulative intake axis
- T_o = Opportunity time (minutes)
- b = Slope of cumulative intake vs. time curve
- c = Constant (commonly 0.275)

(See NEH, Part 623, Chapter 4, Border Irrigation, and Chapter 5, Furrow Irrigation.)

Soil intake characteristics directly influence length of run, required inflow rate, and time of set that provide a uniform and efficient irrigation without excessive deep percolation and runoff. Table 2-6 displays estimated soil infiltration characteristics for border, furrow and fixed set or periodic move sprinkler irrigation systems based on surface soil texture.

For surface systems, water is considered ponded where it is 2 to 8 inches deep. Water infiltration for borders and basins is vertically downward. For furrows, infiltration is vertically downward, horizontal, and upward into furrow ridges. More field testing has been done for borders than for furrows; therefore, intake estimates for borders are more readily available. These intake characteristics can be converted for use with furrows, but the intake process differences must be accounted for in the conversion.

Figure 2-3 displays intake groupings used for designing border and basin and contour surface irrigation systems. Figure 2-4 displays intake groupings used for designing furrow irrigation systems. Furrow intake characteristics differ from border and basin intake characteristics because of the direction of water movement near the soil surface and the percent of soil surface covered by water.

Table 2-6 Soil intake ranges by surface texture ^{1/}

Soil texture	Intake characteristics		
	Sprinkle	Furrow	Border & basin
C, SIC	.1 - .2	.1 - .5	.1 - .3
SC, SICL	.1 - .4	.2 - .8	.25 - .75
CL, SCL	.1 - .5	.2 - 1.0	.3 - 1.0
SIL, L	.5 - .7	.3 - 1.2	.5 - 1.5
VFSL, FSL	.3 - 1.0	.4 - 1.9	1.0 - 3.0
SL, LVFS	.3 - 1.25	.5 - 2.4	1.5 - 4.0
LFS, LS	.4 - 1.5	.6 - 3.0	2.0 - 4.0
FS, S	.5 +	1.0 +	3.0 +
CS	1.0 +	4.0 +	4.0 +

^{1/} These are estimates based on soil texture. They should be used only where local data are not available.

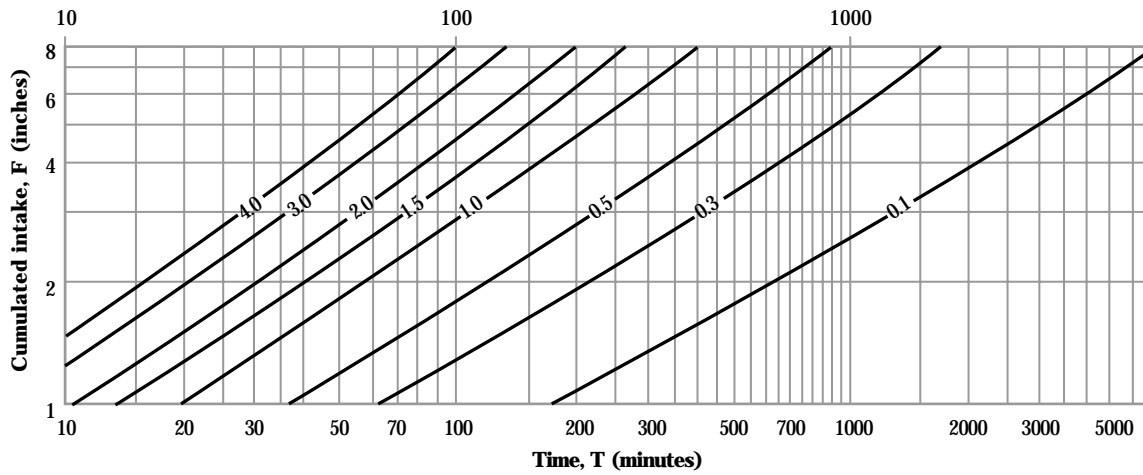
Figure 2-3 Intake families for border and basin irrigation design

$$F = aT_o^b + c$$

F = cumulative intake for an opportunity time T period (inches)

a = intercept along the cumulative intake axis

T_o = opportunity time (minutes)

b = slope of cumulative intake vs. time curve

c = constant (commonly 0.275)

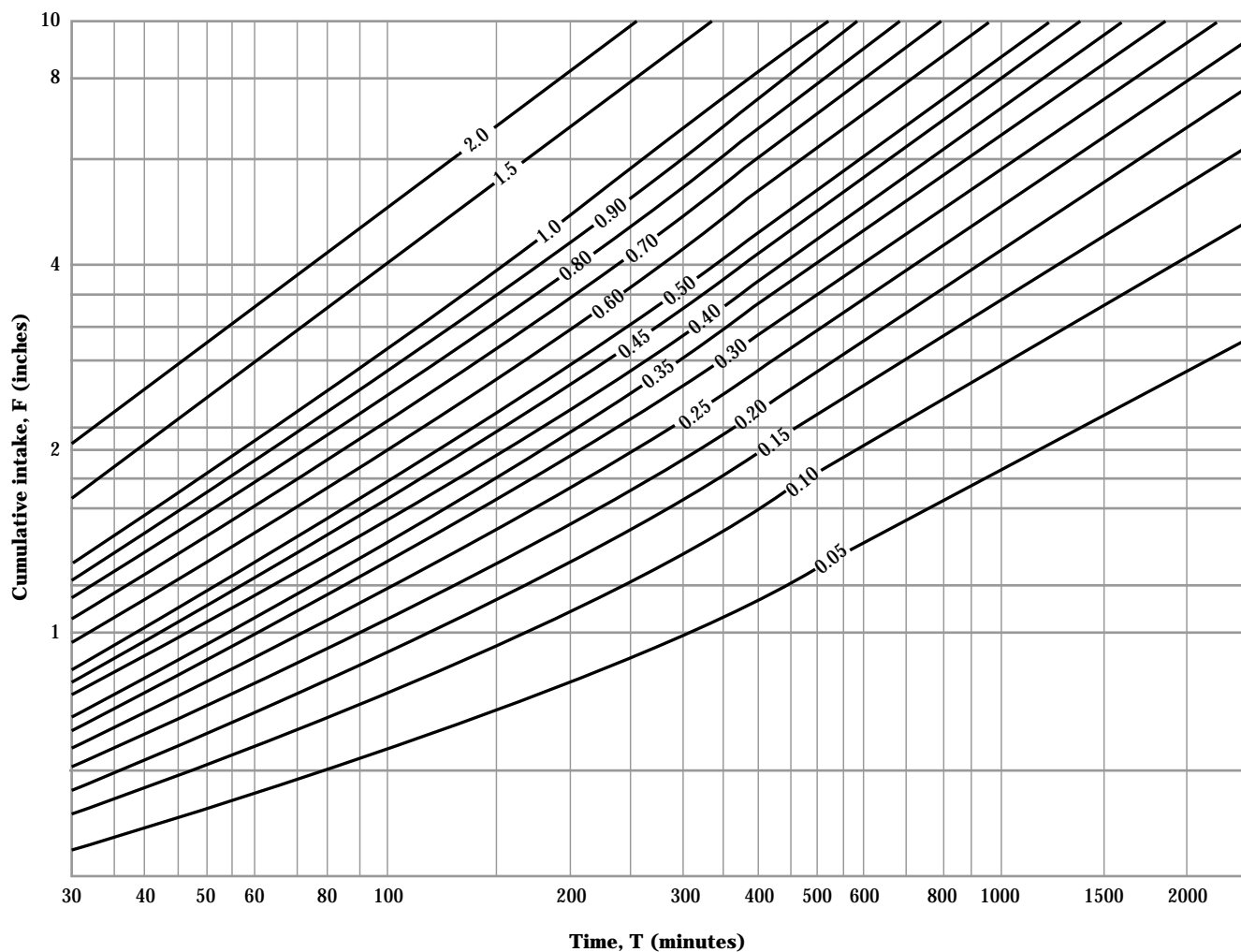
Figure 2-4 Intake families for furrow irrigation design ^{1/}

$$F = aT_0^b + c$$

F = cumulative intake for an opportunity time T period (inches)

a = intercept along the cumulative intake axis

T₀ = opportunity time (minutes)

b = slope of cumulative intake-vs. time curve

c = constant ^{2/} (commonly 0.275)

^{1/} Source: NEH, Section 15, Chapter 5, Furrow Irrigation.

^{2/} Constant can be adjusted based on local information.

(2) Sprinkler irrigation systems

For sprinkle irrigation, infiltration is referred to as either an intake rate or maximum application rate, expressed as inches per hour (in/hr). Application rates and timing vary according to type of sprinkler or spray head. With impact heads, water on the ground surface is at a single point only with each head rotation. With spray heads, water is on the ground surface continuously, but at very shallow depth. Soil surface storage is important where water is applied in short time periods; i.e., the outer end of low pressure center pivot laterals.

Caution should be used when comparing average sprinkler application rates with published soil infiltration values. Some of the problems include:

- Low angle nozzles apply proportionally more water in the area nearest the nozzle.
- Peak instantaneous application rates under continuously self-moving sprinkler laterals can be very high. However, when expressed as an average hourly rate over the total irrigated area, these rates may appear quite low. For example: A 1-inch irrigation application being made at the outer end of a quarter mile long Low Pressure In Canopy center pivot lateral can apply water at instantaneous rates exceeding 50 inches per hour for 2 to 10 minutes, but the average hourly rate is considerably less. In medium and fine textured soils, the amount infiltrated during the application period can be very low.

Adequate soil surface storage is required to limit translocation of water within the field and perhaps field runoff during the infiltration process. Sprinkler systems should be designed with application rates that do not exceed the soil intake rate unless soil surface storage or other considerations are made.

Water droplet impact on a bare soil surface from sprinkler systems can cause dispersion of some soils. The bigger the droplets, the more the potential dispersion and microcompaction of soil particles. Bigger droplets are generally a result of inadequate operating pressure or long distances from the nozzle to the point of impact. This action forms a dense and less permeable thin surface layer that can reduce the infiltration

rate significantly. This condition is most likely to occur on soils that are

- sodic,
- poorly graded,
- bare,
- contain low organic matter,
- have little or no surface residue, and
- have limited vegetation canopy.

Table 2-7 displays the estimated maximum net application amounts and rates for center pivot systems. The table displays the sprinkler intake group and the amount of soil surface storage needed to apply an allowable irrigation amount. All systems are considered to be 1,320 feet in length. The following systems are compared in the table:

- High pressure impact heads with a peak rate of 1.0 in/hr.
- Medium pressure impact heads with a peak rate of 1.5 in/hr.
- Low pressure impact heads with a peak rate of 2.5 in/hr.
- Low pressure spray, two direction system with peak rate of 3.5 in/hr.
- Low pressure spray, one direction system with peak rate of 6.0 in/hr.

Values for various slopes for the maximum allowable net application amount without additional storage created by special practices, are:

Field slope (%)	Approximate soil surface storage (in)
0 - 1	0.5
1 - 3	0.3
3 - 5	0.1
> 5	0.0

The infiltration process is different when using sprinkler and border (or furrow) irrigation. With border irrigation, a small head or depth of water (pressure) is placed on the soil surface. With sprinkler and microirrigation, the soil surface remains mostly unsaturated. The association with sprinkle application rate and border intake family is through surface texture.

Table 2-7 Maximum net application amounts with zero potential runoff for center pivot systems

Border intake group	Typical application rate ^{1/} (in/hr)	Pressure & sprinkler type	Maximum allowable net application amount			
			----- surface storage -----			
			0.0 ^{2/} (in)	0.1 (in)	0.3 (in)	0.5 (in)
A (0.1)	1.0	High-impact	0.2	0.4	0.8	1.1
	1.5	Medium-impact	0.2	0.3	0.7	0.9
	2.5	Low-impact	0.1	0.3	0.6	0.8
	3.5	Low-spray	0.1	0.3	0.5	0.7
	6.0	2 direction Low-spray	0.1	0.3	0.5	0.7
B (0.3)	1.0	1 direction High-impact	0.8	1.2	1.3	2.2
	1.5	Medium-impact	0.5	0.7	1.2	1.7
	2.5	Low-impact	0.2	0.5	0.8	1.2
	3.5	Low-spray	0.2	0.3	0.7	1.0
	6.0	2 direction Low-spray	0.1	0.3	0.5	0.8
C (0.5)	1.0	1 direction High-impact	2.0	2.5	3.3	4.0
	1.5	Medium-impact	1.0	1.4	1.9	2.5
	2.5	Low-impact	0.4	0.7	1.2	1.6
	3.5	Low-spray	0.3	0.5	0.9	1.3
	6.0	2 direction Low-spray	0.1	0.3	0.7	0.9
D (1.0)	1.0	1 direction High-impact	4.0	4.0	4.0	4.0
	1.5	Medium-impact	4.0	4.0	4.0	4.0
	2.5	Low-impact	1.4	1.9	2.6	3.2
	3.5	Low-spray	0.6	1.1	1.7	2.2
	6.0	2 direction Low-spray	0.3	0.6	0.9	1.3
E (1.5 +)	No general restrictions within practical design criteria. Local experience may dictate specific restrictions.					

1/ If higher rates are used, the application amounts should be appropriately reduced. The rates shown are not necessarily the maximum allowable application rate.

2/ Estimated soil surface storage (without additional storage created by special practices, such as pitting, damming, diking, and contour furrows).

Table 2-8 displays estimated maximum sprinkler application rates for fixed set or periodic move sprinkler systems. It is recognized that border intake families or groups do not relate to the infiltration process using sprinkle irrigation. However, many field technicians are familiar with soils identified by these groups, so they are used for familiarity.

Table 2-9 gives information that can be used to refine infiltration values. Field measurements and local experience should be used to support or change published values.

Table 2-8 Maximum sprinkler application rate—periodic move and fixed set sprinkler (for alfalfa-grass, grass, or clean tilled with residue > 4,000 lb/ac)

Sprinkler intake group	Design slope (%)	----- Net sprinkler application (in) -----								
		≤1.0	1.5	2.0	2.5	3.0	3.5	4.0	4.5	5.0
A	0.4 or less	0.70	0.25	0.15	0.15					
	0.75 to 1.25	0.45	0.20	0.15	0.10					
	2.0	0.35	0.20	0.15	0.10					
	3.0	0.30	0.20	0.15	0.10					
	5.0 to 8.0	0.25	0.15	0.15	0.10					
B	0.40 or less	1.70	0.70	0.50	0.40	0.35	0.30	0.30	0.30	0.25
	0.75 to 1.25	1.20	0.60	0.45	0.40	0.35	0.30	0.30	0.30	0.25
	2.0	1.00	0.60	0.45	0.40	0.35	0.30	0.30	0.25	0.25
	3.0	0.80	0.55	0.45	0.40	0.35	0.30	0.30	0.25	0.25
	5.0 to 8.0	0.70	0.50	0.40	0.35	0.30	0.30	0.30	0.25	0.25
C	0.40 or less	2.75	1.15	0.85	0.75	0.65	0.60	0.55	0.50	0.50
	0.75 to 1.25	2.05	1.05	0.85	0.70	0.65	0.60	0.55	0.50	0.50
	2.0	1.65	1.00	0.80	0.70	0.60	0.55	0.55	0.50	0.50
	3.0	1.40	0.95	0.75	0.65	0.60	0.55	0.55	0.50	0.50
	5.0 to 8.0	1.15	0.85	0.75	0.65	0.60	0.55	0.50	0.50	0.45
D	0.40 or less	5.40	2.40	1.85	1.60	1.45	1.35	1.25	1.20	1.15
	0.75 to 1.25	4.00	2.25	1.80	1.55	1.40	1.30	1.25	1.20	1.15
	2.0	3.30	2.10	1.75	1.55	1.40	1.30	1.25	1.20	1.15
	3.0	2.90	2.00	1.70	1.50	1.40	1.30	1.20	1.15	1.10
	5.0 to 8.0	2.40	1.85	1.60	1.40	1.35	1.25	1.20	1.15	1.10
E	All slopes	No restrictions within practical design criteria								

Cover adjustment for clean tilled crops

- with 3,000 to 4,000 lb/ac, use 90% of above
- with 2,000 to 3,000 lb/ac, use 80% of above
- with 1,000 to 2,000 lb/ac, use 70% of above
- with less than 1,000 lb/ac, use 60% of above

Includes the following reduction of intake for surface storage:

0.75 to 1.25 = 0.4 in
 2.0 = 0.3 in
 3.0 = 0.2 in
 5.0 to 8.0 = 0.0 in

Note: Sprinkler intake groups are based on major soil texture groups, as follows:

A—Border intake family - 0.1
 B—Border intake family - 0.3
 C—Border intake family - 0.5
 D—Border intake family - 1.0
 E—Border intake family - 1.5 +

Table 2-9 Soil intake family adjustment factors

Texture	Fine textured soils generally have slower intake rates than coarse textured soils.
Structure	The arrangement of soil particles into aggregates affects intake as follows: <ul style="list-style-type: none"> • Single grain or granular structure = most rapid intake • Blocky or prismatic structure = moderate intake • Massive or platy structure = slowest intake
Bulk density	Dense soils have grains tightly packed together. The effect of density on intake can be -50% to +30% from the typical.

Modifying factors:

Modifying factor (%)	" + " Increased intake rate	" - " Decreased intake rate
Initial water content -20% to +20%	Low initial water content.	High initial water content.
Organic content -10% to +10%	High organic content improves soil structure and promotes good condition.	Low organic content provides for a more massive soil structure.
Compaction -50% to 0		Compaction results in higher density with less pore space to hold water.
Hardpan -50% to 0		Hardpan (a very dense layer).
Gravel or coarse sand layer, near surface -30% to 0		The soil layer above an abrupt boundary of coarse material must be saturated before water will move into the coarse material below.
Salinity and sodicity -20% to +10%	Calcium salts can flocculate the surface soil.	Sodium salts can disperse and puddle the soil.
Surface crusting -20% to 0		Surface sealing.
Sediments in the irrigation water -20% to 0 ^{1/}		Colloidal clays and fine sediment can accumulate on the soil surface.
Cracking -40% to +40%	Cracking increases initial intake. Intake rate can be high until cracks close because of added moisture causing soil particles to swell.	On highly expansive soils, intake rate can be very slow after cracks close because the soil particles swell.

See footnote at end of table.

Table 2-9 Soil intake family adjustment factors—Continued

Modifying factor (%)	" + " Increased intake rate	" - " Decreased intake rate
Vegetative cover -20% to +20%	Root penetration promotes improved soil structure and lower soil density. Worm activity increases providing macropores for water to follow.	Bare soil tends to puddle under sprinkler systems using large droplet sizes increasing soil density at the soil surface.
Soil condition (physical condition of the soil related to micro-organism activity and erosion) -10% to +10%	Good soil condition reduces soil density.	Poor soil condition increases soil density, restricts root development, and restricts worm activity.
Ripping, subsoiling 0 to +20%	Ripping when soil is dry can break up hardpans, shatter dense soils, and in general improve the soil condition below plow depth. The effect is temporary unless the cause of increased density is eliminated.	
Soil erosion -20% to 0		Erosion exposes subsurface layers that are lower in organic content, have poor structure, can have increased salinity or sodicity, and generally have higher density.

1/ This estimate may need local adjustment.

Center pivot systems, because of their configuration, have higher application rates in the outer fourth of the circle. The longer the pivot lateral, the higher the application rate in the outer portion. To maintain their usefulness on medium or fine textured and sloping soils, surface storage is essential to prevent translocation of applied water. Surface storage can be provided by:

- Soil surface roughness or cloddiness developed from tillage equipment
- In-furrow chiseling or ripping
- Crop residue on the soil surface
- Basin tillage
- Permanent vegetation
- Any combination of these

Surface storage must be available throughout the irrigation season. Tables 2-10a through 2-10g display the surface storage needed for various sprinkler intake groups for continuous/self-moving sprinkler systems. These tables are based on surface soil texture.

Figures 2-5a and 2-5b provide a process to estimate surface storage for reservoir tillage (constructing in-row dikes or dams and small reservoirs) of varying spacing, widths, and heights. Figure 2-5a provides dike nomenclature.

Figure 2-5b provides the maximum capacity of applied depth of irrigation water as a function of dike height and bottom width of reservoir. This figure was developed for furrow slope of 1 percent only.

Table 2-10a Amount of surface storage needed for no runoff—Silty clay (sprinkler intake rate group = 0.1 - 0.2 in/hr)

Application sprinkler rate (in/hr)	----- Total amount of application ----- ----- (inches) -----					
	0.5	1	1.5	2	2.5	3
1	0.0	0.4	0.7	1.1	1.6	2.0
2	0.1	0.5	0.9	1.4	1.8	2.2
3	0.1	0.5	1.0	1.4	1.9	2.4
4	0.1	0.6	1.0	1.5	2.0	2.4
5	0.1	0.6	1.1	1.5	2.0	2.5
6	0.2	0.6	1.1	1.5	2.0	2.5
10	0.2	0.6	1.1	1.6	2.1	2.6
25	0.2	0.7	1.2	1.7	2.1	2.6
50	0.2	0.7	1.2	1.7	2.2	2.7
100	0.2	0.7	1.2	1.7	2.2	2.7
200	0.2	0.7	1.2	1.7	2.2	2.7

Table 2-10b Amount of surface storage needed for no runoff—Silty clay loam (sprinkler intake rate group = 0.1 - 0.4 in/hr)

Application sprinkler rate (in/hr)	----- Total amount of application ----- ----- (inches) -----					
	0.5	1	1.5	2	2.5	3
1	0.0	0.0	0.3	0.6	0.9	1.2
2	0.0	0.3	0.7	1.0	1.4	1.8
3	0.0	0.4	0.8	1.2	1.6	2.0
4	0.1	0.5	0.9	1.3	1.7	2.2
5	0.1	0.5	0.9	1.4	1.8	2.2
6	0.1	0.5	1.0	1.4	1.9	2.3
10	0.1	0.6	1.0	1.5	2.0	2.4
25	0.2	0.7	1.1	1.6	2.1	2.6
50	0.2	0.7	1.2	1.7	2.1	2.6
100	0.2	0.7	1.2	1.7	2.2	2.7
200	0.2	0.7	1.2	1.7	2.2	2.7

Table 2-10c Amount of surface storage needed for no runoff—Silt loam (sprinkler intake rate group = 0.1 - 0.6 in/hr)

Application sprinkler rate (in/hr)	----- Total amount of application ----- ----- (inches) -----					
	0.5	1	1.5	2	2.5	3
1	0.0	0.0	0.0	0.0	0.2	0.4
2	0.0	0.1	0.4	0.7	1.0	1.4
3	0.0	0.3	0.6	1.0	1.3	1.7
4	0.0	0.1	0.7	1.1	1.5	1.9
5	0.0	0.1	0.8	1.2	1.6	2.0
6	0.1	0.5	0.9	1.3	1.7	2.1
10	0.1	0.5	1.0	1.4	1.9	2.3
25	0.2	0.6	1.1	1.6	2.0	2.5
50	0.2	0.7	1.2	1.6	2.1	2.6
100	0.2	0.7	1.2	1.7	2.2	2.7
200	0.2	0.7	1.2	1.7	2.2	2.7

Table 2-10e Amount of surface storage needed for no runoff—Fine sandy loam (sprinkler intake rate group = 0.3 - 1.0 in/hr)

Application sprinkler rate (in/hr)	----- Total amount of application ----- ----- (inches) -----					
	0.5	1	1.5	2	2.5	3
1	0.0	0.0	0.0	0.0	0.0	0.0
2	0.0	0.0	0.0	0.0	0.1	0.3
3	0.0	0.0	0.2	0.5	0.7	1.0
4	0.0	0.1	0.4	0.7	1.0	1.3
5	0.0	0.2	0.5	0.9	1.2	1.6
6	0.0	0.3	0.6	1.0	1.3	1.7
10	0.1	0.4	0.8	1.2	1.6	2.0
25	0.1	0.6	1.0	1.5	1.9	2.4
50	0.2	0.6	1.1	1.6	2.1	2.5
100	0.2	0.7	1.2	1.6	2.1	2.6
200	0.2	0.7	1.2	1.7	2.2	2.7

Table 2-10d Amount of surface storage needed for no runoff—Loam (sprinkler intake rate group = 0.2 - 0.7 in/hr)

Application sprinkler rate (in/hr)	----- Total amount of application ----- ----- (inches) -----					
	0.5	1	1.5	2	2.5	3
1	0.0	0.0	0.0	0.0	0.0	0.0
2	0.0	0.0	0.0	0.0	0.0	0.0
3	0.0	0.0	0.0	0.0	0.2	0.4
4	0.0	0.0	0.1	0.4	0.6	0.8
5	0.0	0.1	0.3	0.6	0.9	1.2
6	0.0	0.2	0.4	0.7	1.0	1.4
10	0.0	0.3	0.7	1.1	1.4	1.8
25	0.1	0.5	1.0	1.4	1.8	2.3
50	0.2	0.6	1.1	1.5	2.0	2.5
100	0.2	0.7	1.1	1.6	2.1	2.6
200	0.2	0.7	1.2	1.7	2.2	2.6

Table 2-10f Amount of surface storage needed for no runoff—Loamy fine sand (sprinkler intake rate group = 0.4 - 1.5 in/hr)

Application sprinkler rate (in/hr)	----- Total amount of application ----- ----- (inches) -----					
	0.5	1	1.5	2	2.5	3
1	0.0	0.0	0.0	0.0	0.0	0.0
2	0.0	0.0	0.0	0.0	0.0	0.0
3	0.0	0.0	0.0	0.0	0.0	0.0
4	0.0	0.0	0.0	0.0	0.2	0.4
5	0.0	0.0	0.1	0.3	0.5	0.8
6	0.0	0.0	0.3	0.5	0.8	1.0
10	0.0	0.3	0.6	0.9	1.3	1.6
25	0.1	0.5	0.9	1.3	1.8	2.2
50	0.2	0.6	1.1	1.5	2.0	2.4
100	0.2	0.7	1.1	1.6	2.1	2.6
200	0.2	0.7	1.2	1.7	2.1	2.6

Table 2-10g Amount of surface storage needed for no runoff—Fine sand (sprinkler intake rate group = 0.5 in/hr +)

Application sprinkler rate (in/hr)	----- Total amount of application ----- (inches)					
	0.5	1	1.5	2	2.5	3
1	0.0	0.0	0.0	0.0	0.0	0.0
2	0.0	0.0	0.0	0.0	0.0	0.0
3	0.0	0.0	0.0	0.0	0.0	0.0
4	0.0	0.0	0.0	0.0	0.0	0.0
5	0.0	0.0	0.0	0.0	0.0	0.0
6	0.0	0.0	0.0	0.1	0.2	0.4
10	0.0	0.1	0.4	0.6	0.9	1.2
25	0.1	1.4	0.8	1.2	1.6	2.0
50	0.1	0.6	1.0	1.4	1.9	2.3
100	0.2	0.6	1.1	1.6	2.0	2.5
200	0.2	0.7	1.2	1.6	2.1	2.6

Figure 2-5a Nomenclature—dike spacing and height; furrow width and ridge height and spacing

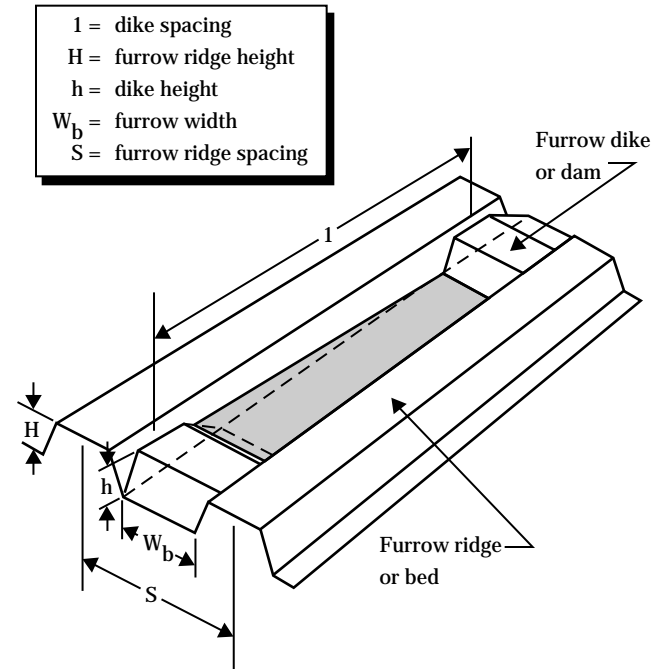

Figure 2-5b Dike spacing, height, and surface storage capacity (maximum capacity of applied depth of irrigation water as a function of dike height and bottom width of reservoir for field slope of 1%; for slopes other than 1%, divide storage volume by actual percent slope)

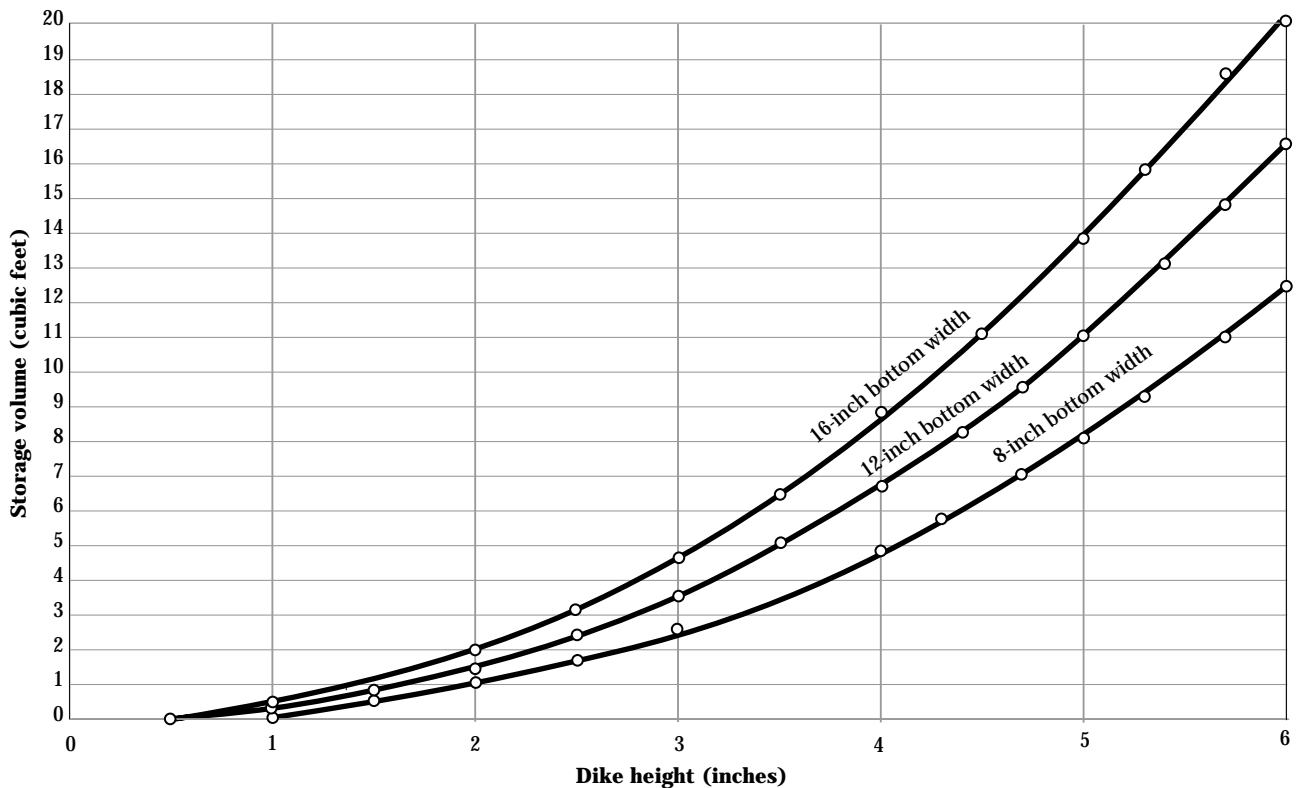

Table 2–11 displays estimates of effective surface storage for various tillage operations for basin storage on level or nearly level slopes. These estimates are based on averages from many field measurements. Tables 2–12 and 2–13 can be used to estimate effective surface storage with cloddy bare ground and residue only on level or nearly level slopes.

Table 2–11 Estimated effective basin surface storage

Tillage operation	Effective storage depth (in)
Basin tillage	1.2
Reservoir (dammer-diker)	0.75
Subsoiler	0.16
Field cultivator	0.12

Table 2–12 Surface storage available for rough and cloddy bare ground

Slope (%)	Surface storage (in)
0.5	0.5
2.0	0.3
4.0	0.1
4.5	0

Table 2–13 Surface storage available with residue

Residue (%)	Surface storage (in)
0	0.0
10	.01
20	.03
30	.07
40	.12
50	.18
60	.24
70	.35

(d) Organic matter

Soil organic matter is the organic fraction of the soil. It includes plant and animal residue at various stages of decomposition and cells and tissues of soil organisms. Organic matter directly influences soil structure, soil condition, soil bulk density, water infiltration, plant growth and root development, permeability, available water capacity, biological activity, oxygen availability, nutrient availability, and farmability, as well as many other factors that make the soil a healthy natural resource for plant growth. Organic matter has a high cation adsorption capacity, and its decomposition releases nitrogen, phosphorous, and sulfur. Site specific organic matter values should always be used for planning and managing irrigation systems. Published values often are from sites that were managed quite differently.

(e) Soil depth

Depth is the dimension from the soil surface to bedrock, hardpan, water table; to a specified soil depth; or to a root growth restrictive layer. The deeper the soil and plant roots, the more soil-water storage is available for plant use. Crop rooting depth and the resulting total AWC control the length of time plants can go between irrigations or effective rainfall events before reaching moisture stress. Equipment compaction layers or natural occurring impervious layers restrict the downward movement of water and root penetration. Providing artificial drainage of poorly drained soils increases soil depth for potential root development. Adequate soil drainage must be present for sustained growth of most plants.

An abrupt change in soil texture with depth can restrict downward water movement. For example, a coarse sand underlying a medium or fine textured soil requires saturation at the interface before substantial water will move into the coarser soil below. When a coarse textured soil abruptly changes to a medium or fine textured soil with depth, a temporary perched water table develops above the slower permeable soil. Stratified soils or shallow soils over hardpans or bedrock can also hold excess gravitational water at the interface. The excess water can move upward because of the increased soil particle surface tension (suction) as the soil water in the upper profile is used by plants. Thus, an otherwise shallow soil with low total AWC can have characteristics of a deeper soil.

(f) Slope

Slope (field) gradient is the inclination of the soil surface from the horizontal, expressed as a percentage. For example, a 1.5 percent slope is a 1.5-foot rise or fall in 100 feet horizontal distance. In planning irrigation systems, slope is important in determining the type of irrigation system best suited to the site. It is also important in determining optimum and maximum application rates (or streamflow rates) for applying water.

Erosion potential from excessive surface irrigation flows increases as the slope and slope length increase. Potential runoff from sprinkler systems also increases as the slope increases, thus raising the opportunity for erosion to occur.

(g) Water tables

Water tables can be a barrier for root development because of restricted oxygen availability. Through planned water table control and management, shallow ground water can supply all or part of the seasonal crop water needs. The water must be high quality, salt free, and held at or near a constant elevation. The water table level should be controlled to provide water according to crop needs. Figure 2-6 displays approximate water table contribution, based on soil texture and depth to water table. Some stratified soils respond poorly to water table control because of the restrictions to water movement. The NRCS computer model DRAINMOD can be used to analyze water tables and subsurface water movement. Documentation for the program includes definitions of factors.

(h) Soil erodibility

The erodibility of a soil should be considered in the planning stage of any irrigation system. The rate and method at which water is applied should be controlled so that it will not cause excessive runoff and erosion.

Factors influencing soil erosion, such as stream size for surface systems, surface storage because of residue, microbasins, and vegetative cover, are not related to soil properties. Table 2-14 shows soil erodibility

hazard for surface irrigation. It is based on soil structure, permeability, percent organic matter, percent silt and very fine sand, and field slope. Three classes indicate degree of erosion hazard on irrigated cropland for planning surface irrigation. For erosion factor K, see section II of the Field Office Technical Guide.

Figure 2-6 Water table contribution to irrigation requirement, as a function of soil type (texture) and water table depth

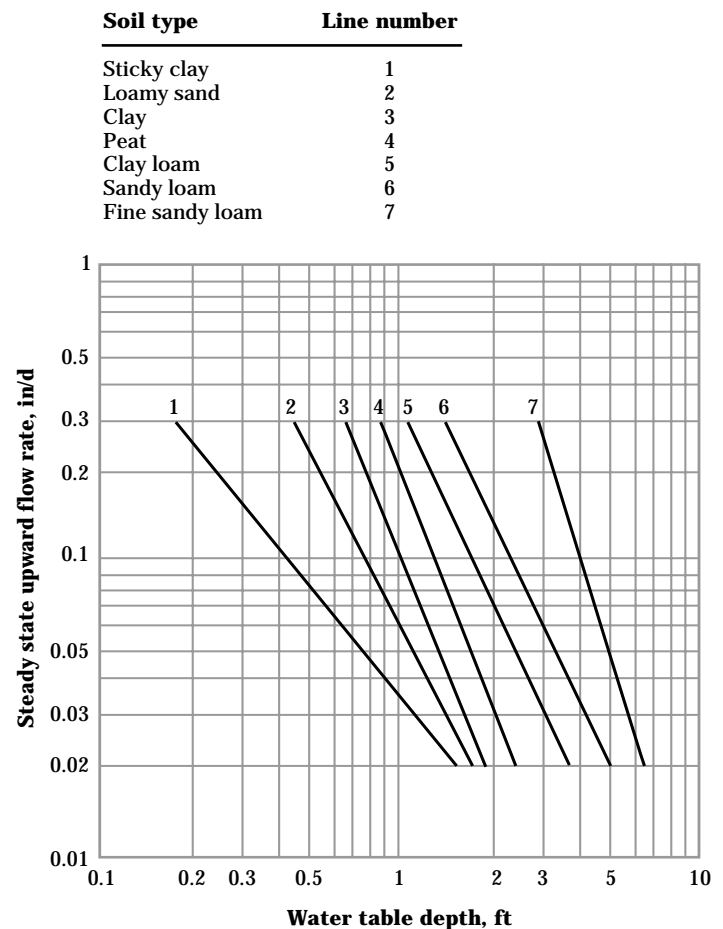

Table 2-14 Soil erodibility hazard (S K values) for surface irrigation

Slope (%)	USLE "K" values											
	.10	.15	.17	.20	.24	.28	.32	.37	.43	.49	.55	.64
0.1	.01	.02	.02	.02	.02	.03	.03	.04	.04	.05	.06	.06
0.2	.02	.03	.03	.04	.05	.06	.06	.07	.09	.10	.11	.13
Slight												
0.3	.03	.05	.05	.06	.07	.08	.10	.11	.13	.15	.17	.19
0.4	.04	.06	.07	.08	.10	.11	.13	.15	.17	.20	.22	.26
0.5	.05	.08	.09	.10	.12	.14	.16	.19	.22	.25	.28	.32
1.0	.10	.15	.17	.20	.24	.28	.32	.37	.43	.49	.55	.64
1.5	.15	.23	.26	.30	.36	.42	.48	.56	.65	.74	.83	.96
Moderate												
2.0	.20	.30	.34	.40	.48	.56	.64	.74	.86	.98	1.10	1.28
3.0	.30	.45	.51	.60	.72	.84	.96	1.12	1.29	1.47	1.65	1.92
4.0	.40	.60	.68	.80	.96	1.12	1.28	1.48	1.72	1.96		
5.0	.50	.75	.85	1.00	1.20	1.40	1.60					
6.0	.60	.90	1.02	1.20	1.44	1.68						
7.0	.70	1.05	1.19	1.40	1.68							
Severe												
8.0	.80	1.20	1.36	1.60								
9.0	.90	1.35	1.53									
10.0	1.0	1.50										

Hazard class S K value

Slight < 0.2
 Moderate 0.2 - 1.0
 Severe > 1.0

Where:

S = Slope in direction of irrigation

K = USLE Soil Erodibility

(i) Chemical properties

Soil is formed primarily from the decomposition of rocks. Exposure of the rock surface to water, oxygen, organic matter, and carbon dioxide brings about chemical alterations on the rock material. Oxidation, reduction, hydration, hydrolysis, and carbonation contribute to rock disintegration and creation of new chemical compounds and solutions. The chemical and mineralogical composition of the soil vary with respect to depth or horizon. Weathering intensity decreases with depth from the surface. The longer the weathering has proceeded, the thicker the weathered layer and the greater the difference from the original material. In mineral soils, organic matter content generally decreases with depth.

The colloidal fraction (diameter less than 0.001 mm) of the soil plays an important part in the chemistry of the soil. Microbiological activity is greatest near the surface where oxygen, organic matter content, and temperature are the highest.

Cation Exchange Capacity (CEC) is the total amount of cations held in a soil in such a way that they can be removed by exchanging with another cation in the natural soil solution, expressed in milliequivalents per 100 grams of oven-dry soil (meq/100 gm). The cation exchange capacity is a measure of the ability of a soil to retain cations, some of which are plant nutrients. It is affected primarily by the kind and amount of clay and organic matter. Soils that have low CEC hold fewer cations and may require more frequent applications of fertilizers than soils with high CEC. See NASIS MUR data base or SCS-SOI-5 for CEC estimates for specific soil series.

(j) Saline and sodic soil effects

Salt affected soils are generally classified as follows, using electrical conductivity of the soil-water extract, EC_e , as the basis:

Salinity	EC_e
Very Slight	0 – 4 dS/m
Slight	4 – 8 dS/m
Moderate	8 – 16 dS/m
Strong	> 16 dS/m

EC_e is the electrical conductivity of soil-water extract corrected to 77 °F (25 °C), usually expressed in units of mmho per centimeter or deci-Siemens per meter.

$$1 \text{ mmho/cm} = 1 \text{ dS/m}$$

As water is evaporated from the soil surface or used by plants, salts and sodic ions within the soil-water solution are left behind either on the ground surface or within the soil profile. Accumulated saline salts can be reduced by leaching with excess water through the soil profile. This may need to be done regularly to maintain a proper salt balance for desirable plant growth. Figure 2-7 displays the effect of soil salinity on AWC on a clay loam soil.

A detailed description of soil and water salinity and sodicity is given in the American Society of Civil Engineers Report No. 71, Agricultural Salinity Assessment and Management (ASCE 1990), and in the National Engineering Handbook, Part 623, Chapter 2, Irrigation Water Requirements (USDA 1993).

Sodium Adsorption Ratio (SAR), is the standard measure of the sodicity of a soil or quality of the irrigation water. It replaces the previously used exchangeable sodium percentage (ESP).

Figure 2-7 Example soil-water retention curves for clay loam soil at varying levels of soil salinity— EC_e

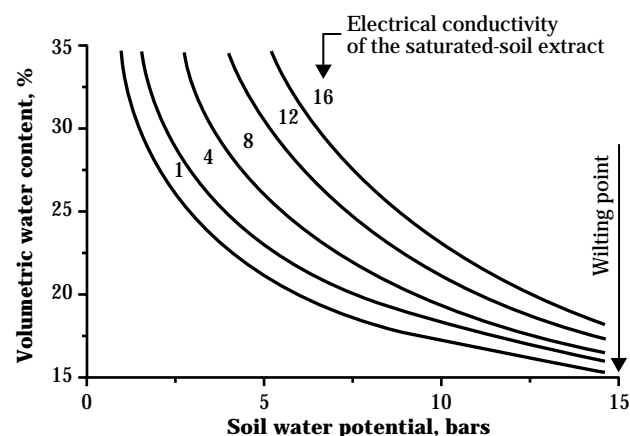

SAR is calculated from the concentration of sodium, calcium, and magnesium ions in the soil-water extract or irrigation water. See Chapter 3, Crops, and Chapter 13, Quality of Water Supply, for discussion of plant effects and quality of irrigation water. Sodium salts decrease the ability of the soil to infiltrate water because of soil structure dispersion or deflocculation. Figure 2-8 displays losses in permeability because of SAR and electrical conductivity of irrigation water.

(k) Soil reaction/acidity

Soil reaction is the degree of acidity of a soil, expressed as a pH value. Soil reaction is significant in crop production and in soil management because of the effect on solubility and availability of nutrients. A change in the degree of reaction may increase the solubility of other nutrients. This affects the amount of nutrients in the soil solution available for plant use, which significantly affects plant growth and crop yield. Figure 2-9 graphically displays the effect of pH on nutrient availability in soils.

Figure 2-8 Threshold values of sodium adsorption ratio of topsoil and electrical conductivity of infiltrating water associated with the likelihood of substantial losses in permeability

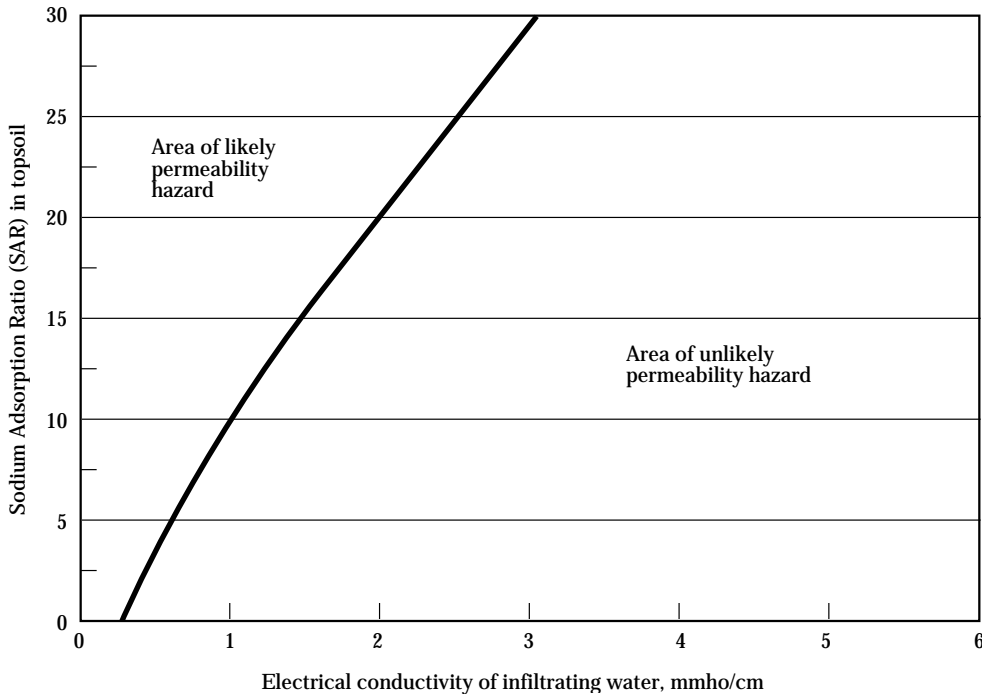
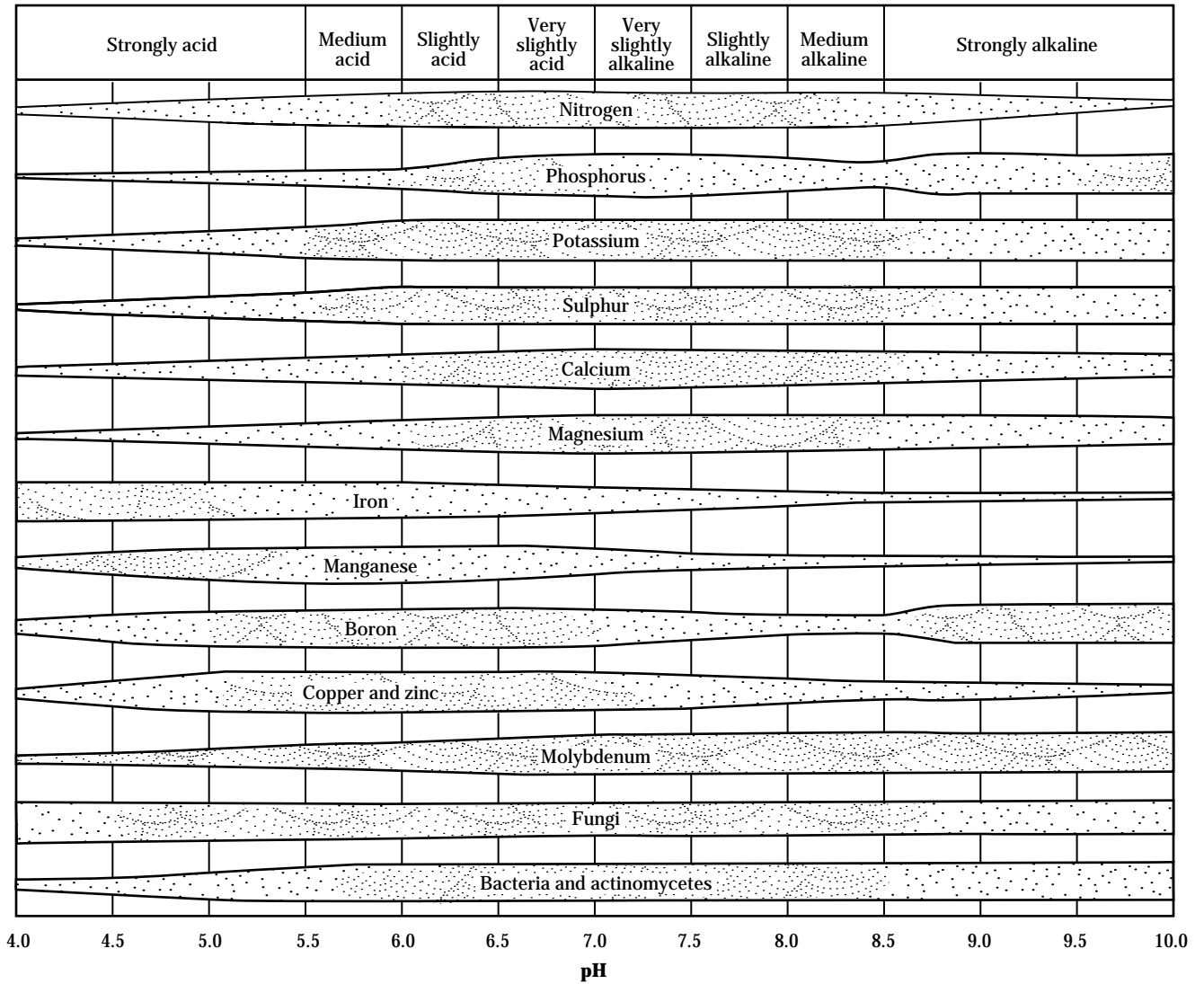

Figure 2-9 Effect of pH on nutrient availability in soils (the wider the bar, the more available is the nutrient)

Nutrient availability in soils: The wider the bar, the more available is the nutrient.



652.0203 Explanation of tables and data bases

Washington State soil survey database is available at several internet sites. NRCS employees should use [my.nrcs](https://my.nrcs.usda.gov).

<https://my.nrcs.usda.gov/default.aspx>

After logging in:

- Go to **field tools**.
- From this tab look under the Resources Information section for the ► **Soil Survey** link. This will take you to the NRCS soil survey web site.
- At this point select the ⇨ Online Surveys.
- Go to the state desired.
- A table listing Soil Survey Reports including online maps, legends, tables and reports by county will be produced.
- Chose your county and for the example shown in Table WA2-1, go to Reports.
- Each of the soils in the county are listed on this Reports table. Select the soil(s) you are interested in by clicking anywhere on the line. You can select more than one soil by using the Shift key to get a group or the Ctrl key to choose more than one soil on the list.
- After choosing the soil(s) you are interested in, go to Report Descriptions, and use the arrow to see the reports available. Choose one and hit the Generate Report button. The example is the Physical Soil Properties.
- The report is now sent to adobe acrobat reader and you can print or save the file for later use.

- Other counties, properties, and soils are listed. This is very user friendly site. It is easy to operate and pull up the soils information for your location(s).

For public use, the soils reports are on the USDA web site. The location of the web site is located at:

<http://soils.usda.gov/survey/>

At this site, the user follows the steps listed previously beginning at the select ⇨ Online Surveys.

652.0204 State supplement

(a) Soil Surveys

Soil information and field interpretations are also available in Section II of the Field Office Technical Guide. This is located online as listed in Section 652.203.

Limited printed copies are available in the local field offices.

(b) Soil Properties

Table WA2-1, on the following page, displays soil properties and design values for irrigation, by soil series, for an irrigated soil in Washington. Values displayed are interpreted data taken from Section II of the FOTG, or represent actual field data, or laboratory test results. Soils specifically having field or display laboratory test data are also indicated. This table was generated from the online soils report listed in Section 652.203.

Table WA2-1 Soil Properties**Physical Soil Properties**

Grant County, Washington

[Entries under "Erosion Factors—T" apply to the entire profile. Entries under "Wind Erodibility Group" and "Wind Erodibility Index" apply only to the surface layer. Absence of an entry indicates that data were not estimated.]

Map symbol and soil name	Depth	Sand	Silt	Clay	Moist bulk density	Saturated hydraulic conductivity	Available water capacity	Linear extensibility	Organic matter	Erosion factors			Wind erodibility group	Wind erodibility index
										Kw	Kf	T		
	in	Pct	Pct	Pct	g/cc	micro/msec	in/in	Pct	Pct					
115: Royal	0-10	—	—	5-10	1.20-1.40	14.00-42.00	0.13-0.16	0.0-2.9	0.5-1.0	43	43	5	3	86
	10-16	—	—	5-10	1.30-1.50	14.00-42.00	0.12-0.16	0.0-2.9	0.0-0.5	49	49			
	16-60	—	—	3-10	1.40-1.80	14.00-42.00	0.10-0.14	0.0-2.9	0.0-0.5	43	43			

(c) Example

The following is an example of how to use the soil survey data to determine water-holding capacities for crops with root depths of 24, 36, and 60 inches. Typical root depths for most crops can be found in the NIG 652.0301 (d) Table 3-4.

Use the Physical Soil Properties table above to determine the depth and average 'available water capacity' (AWC) for each layer. Next multiply by the depth in each layer times the AWC. Add the totals for each layer to get the total for the rooting depth.

Depth (in)	Available Water Capacity-average in/in	Root Depth 24"	Root Depth 36"	Root Depth 60"
0-10	0.15	10*0.15=1.5	10*0.15=1.5	10*0.15=1.5
10-16	0.14	6*0.14=0.8	6*0.14=0.8	6*0.14=0.8
16-60	0.12	8*0.12=0.96	20*0.12=2.4	44*0.12=5.28
	Total	3.3"	4.7"	7.6"

The total values are based on the amount of water available for crop use from field capacity to permanent wilting point. These totals will be reduced using crop management allowable deficiencies (MAD) values to give the readily available water, or allowable depletion, from the soil profile. MAD values are shown in NIG 652.0301 (c) Table 3-3 and will be discussed later.

Chapter 3

Crops

Contents:	652.0300 Purpose and objective	3-1
	(a) Soil condition	3-1
	(b) Nutrient management	3-1
	(c) Soil, water, pest, nutrient, and crop residue management	3-1
	652.0301 Crop growth characteristics	3-2
	(a) Response to water, crop yield, and quality	3-2
	(b) Critical growth periods	3-2
	(c) Irrigation related management	3-7
	(d) Rooting depth and moisture extraction patterns	3-8
	652.0302 Crop and irrigation system water requirements	3-12
	(a) Crop evapotranspiration	3-12
	(b) Irrigation frequency	3-12
	(c) Net irrigation requirement	3-12
	(d) Gross irrigation requirement	3-13
	652.0303 Reduced irrigation and restricted water supply	3-14
	652.0304 Adapted irrigation systems	3-15
	652.0305 Temperature—effects and management	3-16
	(a) High temperatures	3-16
	(b) Low temperatures	3-16
	652.0306 Salinity and sodicity effects	3-17
	(a) General	3-17
	(b) Measuring salinity and sodicity concentration	3-17
	(c) Effects of salinity on yields	3-17
	(d) Effect of salinity and sodicity on AWC	3-17
	(e) Management practices for salinity and sodicity control	3-18
	(f) Toxic elements	3-18
	652.0307 Crop data bases	3-19
	652.0308 State supplement	3-20

Tables			
Table 3-1	Critical periods for plant moisture stress		3-3
Table 3-2	Adapted irrigation methods		3-6
Table 3-3	Recommended Management Allowable Depletion (MAD) for crop growth stages (% of AWC) growing in loamy soils		3-7
Table 3-4	Depths to which the roots of mature crops will extract available soil water from a deep, uniform, well drained soil under average unrestricted conditions		3-8
Table 3-5	Irrigation system vs. crops grown		3-15
Figures			
Figure 3-1	Root distribution systems—deep homogenous soils with good water management and no soil restrictions		3-9
Figure 3-2	Typical water extraction pattern in uniform soil profile		3-10
Figure 3-3	Effect of root development on soils with depth limitations		3-11

652.0300 Purpose and objective

The purpose of irrigation is to supplement natural precipitation so that moisture requirements of crops being grown are met. Crop response to irrigation varies with soils, fertility, type of plants, stage of growth, and local climate. Where crop stress caused by moisture shortage is prevented by proper and timely irrigation, other factors can become inhibitors to desirable yield and quality.

Knowledge of how plants respond to, and use, soil water throughout their growing season is essential to successfully design and manage an irrigation system. Continuous plant uptake of soil nutrients has a potential for improving ground water quality. Profitable crop production is generally the objective of agriculture. With proper management, soils (or water) affected by salinity or sodicity can sustain plant growth in perpetuity. Irrigation provides the insurance for high quality and desirable quantity crops at reduced risk in semi-arid, subhumid, and humid areas. It is a necessity in arid regions. The effect of irrigation both onsite and offsite on soil, water, air, plant, and animal resources along with human considerations needs to be considered.

(a) Soil condition

For desirable crop growth, good soil condition is key to optimum soil aeration, water infiltration, permeability, and uniform root development. It also helps reduce runoff and potential soil erosion. Good soil condition can be maintained or improved by eliminating excess tillage operations, avoiding field operations while soil-water content is high, using organic material or crop residue, and using grass and legumes in rotation. To reduce opportunity of soil compaction on irrigated pastures, livestock should be excluded during and after irrigation until adequate soil surface dry-out occurs.

(b) Nutrient management

A healthy plant uses water more efficiently than a plant that lacks nutrients and trace elements. Total water use by a healthy plant is greater than that for a plant deprived of nutrients. However, the yield per unit of water is much greater for healthy plants.

Soil fertility is maintained with proper nutrient management by maintaining proper soil reaction (pH level) and by using an appropriate cropping system. Liming may be needed on acid soil. On saline soils, leaching of excess salts is generally needed. On sodic soils, both soil amendments and leaching may be needed. Soil tests, field observations, planned yield and quality, and field experience help determine the type and amount of fertilizers and other elements to use. Using excess fertilizer or poor application timing can result in movement of chemicals below the root zone into the ground water or off the field.

(c) Soil, water, pest, nutrient, and crop residue management

Optimum production requires the operator to control weeds and insects, use high quality seed of adapted varieties, apply fertilizer according to plant needs, and practice good soil and water management during all parts of the growing season. Crops grown should be selected to fit the soil, water, climate, irrigation system, farm equipment, and market availability. Plant population can generally be increased when practicing good soil, water, pesticide, nutrient, and crop residue management.

652.0301 Crop growth characteristics

(a) Response to water, crop yield, and quality

Water is only one component needed to achieve desired crop yield and quality. A practical definition for water *use efficiency* is the amount of yield per unit of area per unit of water, e.g., 6 bushels of wheat per acre per acre-inch of applied water. Such yield water use comparison units can provide a basis for comparison when improvements are made.

Maintaining soil water within a desirable depletion range (preferably less than 5 bars tension) generally provides the expected yield and quality. The effect on yield and quality depends on how severe and during which period of crop growth water deficit occurs. Applying excess irrigation water over and above that necessary to grow a successful crop will not increase yields and generally reduces yields.

Other factors, such as the lack of available nutrients, trace elements, and uncontrolled pest activity, may limit crop yield. Excess irrigation water can leach essential plant nutrients and some pesticides and their metabolites below the root zone. This is especially true with nitrates, which are quite mobile in water. Excess irrigation water percolating below the root zone can pollute ground water.

(b) Critical growth periods

Plants must have ample moisture throughout the growing season for optimum production and the most efficient use of water. This is most important during critical periods of growth and development. Most crops are sensitive to water stress during one or more critical growth periods in their growing season. Moisture stress during a critical period can cause an irreversible loss of yield or product quality. Critical periods must be considered with caution because they depend on plant species as well as variety. Some crops can be moderately stressed during noncritical periods with no adverse effect on yields. Other plants require mild stress to set and develop fruit for optimum harvest time (weather or market).

The need for an irrigation should be determined by an onsite examination of the soil for water content or by any irrigation scheduling method for which basic data have been established. Using only plant appearance as the moisture deficit symptom can lead to misinterpretation, which generally results in reduction of yield and product quality. When the plant appears to be dry, it may already be in a moisture stress condition. Some plants temporarily wilt to conserve moisture during otherwise high evapotranspiration periods of the day. Dry appearance may also be caused by other problems (lack of nutrients, insect activity, disease, lack of essential trace elements). Critical water periods for most crops and other irrigation considerations are displayed in table 3-1. Irrigation scheduling techniques are described in more detail in Chapter 9, Irrigation Water Management.

Table 3-1 Critical periods for plant moisture stress

Crop	Critical period	Comments
Alfalfa hay	At seedling stage for new seedlings, just after cutting for hay, and at start of flowering stage for seed production.	Any moisture stress during growth period reduces yield. Soil moisture is generally reduced immediately before and during cutting, drying, and hay collecting.
Beans, dry	Flowering through pod formation.	Sensitive to over-irrigation.
Beans, green	Blossom through harvest.	
Broccoli	During head formation and enlargement.	
Cabbage	During head formation and enlargement.	
Cauliflower	During entire growing season.	
Cane berries	Blossom through harvest.	
Citrus	During entire growing season.	Blossom and next season fruit set occurs during harvest of the previous crop.
Corn, grain	From tasseling through silk stage and until kernels become firm.	Needs adequate moisture from germination to dent stage for maximum production. Depletion of 80% or more of AWC may be allowed during final ripening period.
Corn, silage	From tasseling through silk stage and until kernels become firm.	Needs adequate moisture from germination to dent stage for maximum production.
Corn, sweet	From tasseling through silk stage until kernels become firm.	
Cotton	First blossom through boll maturing stage.	Any moisture stress, even temporary, ceases blossom formation and boll set for at least 15 days after moisture again becomes available.
Cranberries	Blossom through fruit sizing.	
Fruit trees	During the initiation and early development period of flower buds, the flowering and fruit setting period (maybe the previous year), the fruit growing and enlarging period, and the pre-harvest period.	Stone fruits are especially sensitive to moisture stress during last 2 weeks before harvest.
Grain (small)	During boot, bloom, milk stage, early head development and early ripening stages.	Critical period for malting barley is at soft dough stage to maintain a quality kernel.

Table 3-1 Critical periods for plant moisture stress—Continued

Crop	Critical period	Comments
Grapes	All growth periods especially during fruit filling.	See vine crops.
Peanuts	Full season.	
Lettuce	Head enlargement to harvest.	Water shortage results in a sour and strong lettuce. Crop quality at harvest is controlled by water availability to the plant, MAD 15 – 20% is recommended.
Melons	Blossom through harvest.	
Milo	Secondary rooting and tillering to boot stage, heading, flowering, and grain formation through filling.	
Onions, dry	During bulb formation.	Maintain MAD 30 – 35% of AWC. Let soil dry near harvest.
Onions, green	Blossom through harvest.	Strong and hot onions can result from moisture stress.
Nut trees	During flower initiation period, fruit set, and midseason growth.	Pre-harvest period is not key because nuts form during midseason period.
Pasture	During establishment and boot stage to head formation.	Maintain MAD less than 50%. Moisture stress immediately after grazing encourages fast regrowth.
Peas, dry	At start of flowering and when pods are swelling.	
Peas, green	Blossom through harvest.	
Peppers	At flowering stage and when peppers are in fast enlarging stage.	
Potato	Flowering and tuber formation to harvest.	Sensitive to irrigation scheduling. Restrict MAD to 30 – 35% of AWC. Low quality tubers result if allowed to go into moisture stress during tuber development and growth.
Radish	During period of root enlargement.	Hot radishes can be the result of moisture stress.
Sunflower	Flowering to seed development.	

Table 3-1 Critical periods for plant moisture stress—Continued

Crop	Critical period	Comments
Sorghum grain	Secondary rooting and tilling to boot stage, heading, flowering, and grain formation through filling.	
Soybeans	Flowering and fruiting stage.	
Strawberries	Fruit development through harvest.	
Sugar beets	At time of plant emergence, following thinning, and about 1 month after emergence.	Frequent light applications during early growth period. Temporary leaf wilt on hot days is common even with adequate soil water content. Excessive fall irrigation lowers sugar content, but soil moisture needs to be adequate for easy beet lifting.
Sugarcane	During period of maximum vegetative growth.	
Tobacco	Knee high to blossoming.	
Tomatoes	When flowers are forming, fruit is setting, and fruits are rapidly enlarging.	
Turnips	When size of edible root increases rapidly up to harvest.	Strong tasting turnips can be the result of moisture stress.
Vine crops	Blossom through harvest.	
Watermelon	Blossom to harvest.	

Table 3-2 Adapted irrigation methods

Crop	Management depth (ft)	Adapted irrigation methods					Sprinkler	Micro-	Subirr.
		level		Surface	graded				
		border	furrow	border	furrow	corrug.			
Alfalfa	5	x	x	x	x	x			
Beans, dry	3	x	x	x	x	x			
Beans, green	3				x	x	x		
Cane berries	3	x	x	x	x	x	x		
Citrus	3	x		x		x	x		
Corn, grain	4		x		x	x		x	
Corn, silage	4		x		x	x		x	
Corn, sweet	3		x		x	x		x	
Cotton	3		x		x	x	x		
Grain, small	4	x	x	x	x	x		x	
Cranberries	2	x				x			
Grass, seed	3	x	x	x	x	x			
Grass, silage	3	x	x	x	x	x			
Milo (sorghum)	3	x			x	x		x	
Nursery stock	0-3	x	x	x	x	x	x	x	
Orchard	5	x	x	x	x	x	x	x	
Pasture	3	x		x		x		x	
Peanuts	3		x		x	x		x	
Peas	3	x	x	x	x	x			
Potatoes	3		x		x	x	x		
Safflower	5	x	x	x	x	x			
Sugar beets	5		x		x	x			
Sunflower	5	x	x	x	x	x			
Tobacco	3					x	x		
Tomatoes	2		x		x	x	x	x	
Turf, sod	2	x		x		x			
Turf	2	x		x		x	x		
Vegetables	1/	x	x	x	x	x	x		
Vegetables	2/	x	x	x	x	x	x	x	
Vegetables	3/	x	x	x	x	x	x	x	
Vegetables	4/	x	x	x	x	x	x	x	

1/ 1-foot depth—Lettuce, onions, spinach.

2/ 2-foot depth—Cabbage, brussel sprouts, broccoli, cauliflower.

3/ 3-foot depth—Turnips, parsnips, carrots, beets, green beans.

4/ 4-foot depth—Squash, cucumber, melons.

(c) Irrigation related management

Determining when to irrigate a specific crop requires the selection of a Management Allowable Depletion (MAD) of the available soil water. MAD is defined as the percentage of the available soil water that can be depleted between irrigations without serious plant moisture stress. MAD is expressed as:

- a percentage of the total Available Water Content (AWC) the soil will hold in the root zone,
- a soil-water deficit (SWD) in inches, or
- an allowable soil-water tension level.

Different crops tolerate different soil-water depletion levels at different stages of growth without going into moisture stress. Some crops have critical growth periods during only one stage of growth, while others have critical periods during several stages of growth.

MAD should be evaluated according to crop needs, and, if needed, adjusted during the growing season. Values of MAD, during the growing season are typically 25 to 40 percent for high value, shallow rooted crops; 50 percent for deep rooted crops; and 60 to 65 percent for low value deep rooted crops.

Recommended MAD values by soil texture for deep rooted crops are:

- Fine texture (clayey) soils 40%
- Medium texture (loamy) soils 50%
- Coarse texture (sandy) soils 60%

Table 3-2 displays adapted irrigation methods for various crops, and table 3-3 lists recommended MAD levels by crop development stages for a few crops.

Caution: Medium to fine textured soils can reduce MAD values given in this table.

Table 3-3 Recommended Management Allowable Depletion (MAD) for crop growth stages (% of AWC) growing in loamy soils ^{1/2/}

Crop	Crop growth stage			
	Estab- lishment	Vege- tative	Flowering yield formation	Ripening maturity
Alfalfa hay	50	50	50	50
Alfalfa seed	50	60	50	80
Beans, green	40	40	40	40
Beans, dry	40	40	40	40
Citrus	50	50	50	50
Corn, grain	50	50	50	50
Corn, seed	50	50	50	50
Corn, sweet	50	40	40	40
Cotton	50	50	50	50
Cranberries	40	50	40	40
Garlic	30	30	30	30
Grains, small	50	50	40 ^{3/}	60
Grapes	40	40	40	50
Grass pasture/hay	40	50	50	50
Grass seed	50	50	50	50
Lettuce	40	50	40	20
Milo	50	50	50	50
Mint	40	40	40	50
Nursery stock	50	50	50	50
Onions	40	30	30	30
Orchard, fruit	50	50	50	50
Peas	50	50	50	50
Peanuts	40	50	50	50
Potatoes	35	35	35	50 ^{4/}
Safflower	50	50	50	50
Sorghum, grain	50	50	50	50
Spinach	25	25	25	25
Sugar beets	50	50	50	50
Sunflower	50	50	50	50
Tobacco	40	40	40	50
Vegetables				
1 to 2 ft root depth	35	30	30	35
3 to 4 ft root depth	35	40	40	40

For medium to fine textured soils:

1/ (Most restrictive MAD) Some crops are typically not grown on these soils.

2/ Check soil moisture for crop stress point approximately one-third of the depth of the crop root zone.

3/ From boot stage through flowering.

4/ At vine kill.

(d) Rooting depth and moisture extraction patterns

The soil is a storehouse for plant nutrients, an environment for biological activity, an anchorage for plants, and a reservoir for water to sustain plant growth. The amount of water a soil can hold available for plant use is determined by its physical properties. It also determines the frequency of irrigation and the capacity of the irrigation system needed to ensure continuous crop growth and development.

The type of root system a plant has is fixed by genetic factors. Some plants have tap roots that penetrate deeply into the soil, while others develop many shallow lateral roots. The depth of the soil reservoir that holds water available to a plant is determined by that plant's rooting characteristics and soil characteristics including compaction layers and water management. The distribution of the plant roots determines its moisture extraction pattern. Figure 3-1 shows typical root distribution for several field and vegetable crops. Typical rooting depths for various crops grown on a deep, well drained soil with good water and soil management are listed in table 3-4.

For annual crops, rooting depths vary by stage of growth and should be considered in determining the amount of water to be replaced each irrigation. All plants have very shallow roots early in their development period; therefore, only light and frequent irrigations are needed. Because roots will not grow into a dry soil, soil moisture outside the actual root development area is needed for the plant to develop a full root system in the soil profile. Excess moisture in this area will also limit root development.

For most plants, the concentration of moisture absorbing roots is greatest in the upper part of the root zone (usually in the top quarter). Extraction is most rapid in the zone of greatest root concentration and where the most favorable conditions of aeration, biological activity, temperature, and nutrient availability occur. Water also evaporates from the upper few inches of the soil; therefore, water is diminished most rapidly from the upper part of the soil. This creates a high soil-water potential gradient.

Table 3-4 Depths to which the roots of mature crops will extract available soil water from a deep, uniform, well drained soil under average unrestricted conditions (depths shown are for 80% of the roots)

Crop	Depth (ft)	Crop	Depth (ft)
Alfalfa	5	Peas	2 - 3
Asparagus	5	Peppers	1 - 2
Bananas	5	Potatoes, Irish	2 - 3
Beans, dry	2 - 3	Potatoes, sweet	2 - 3
Beans, green	2 - 3	Pumpkins	3 - 4
Beets, table	2 - 3	Radishes	1
Broccoli	2	Safflower	4
Berries, blue	4 - 5	Sorghum	4
Berries, cane	4 - 5	Spinach	1 - 2
Brussel sprouts	2	Squash	3 - 4
Cabbage	2	Strawberries	1 - 2
Cantaloupes	3	Sudan grass	3 - 4
Carrots	2	Sugar beets	4 - 5
Cauliflower	2	Sugarcane	4 - 5
Celery	1 - 2	Sunflower	4 - 5
Chard	1 - 2	Tobacco	3 - 4
Clover, Ladino	2 - 3	Tomato	3
Cranberries	1	Turnips	2 - 3
Corn, sweet	2 - 3	Watermelon	3 - 4
Corn, grain	3 - 4	Wheat	4
Corn seed	3 - 4		
Corn, silage	3 - 4		
Cotton	4 - 5	Trees	
Cucumber	1 - 2	Fruit	4 - 5
Eggplant	2	Citrus	3 - 4
Garlic	1 - 2	Nut	4 - 5
Grains & flax	3 - 4		
Grapes	5	Shrubs & misc. trees for windbreaks	
Grass pasture/hay	2 - 4	< 10 ft tall	2 - 3+
Grass seed	3 - 4	10 - 25 ft tall	3 - 4+
Lettuce	1 - 2	> 25 ft tall	5+
Melons	2 - 3		
Milo	2 - 4	Other	
Mustard	2	Turf (sod & lawn)	1 - 2
Onions	1 - 2	Nursery stock	1 - 3
Parsnips	2 - 3	Nursery stock	pots
Peanuts	2 - 3		

Figure 3-1 Root distribution systems—deep homogenous soils with good water management and no soil restrictions

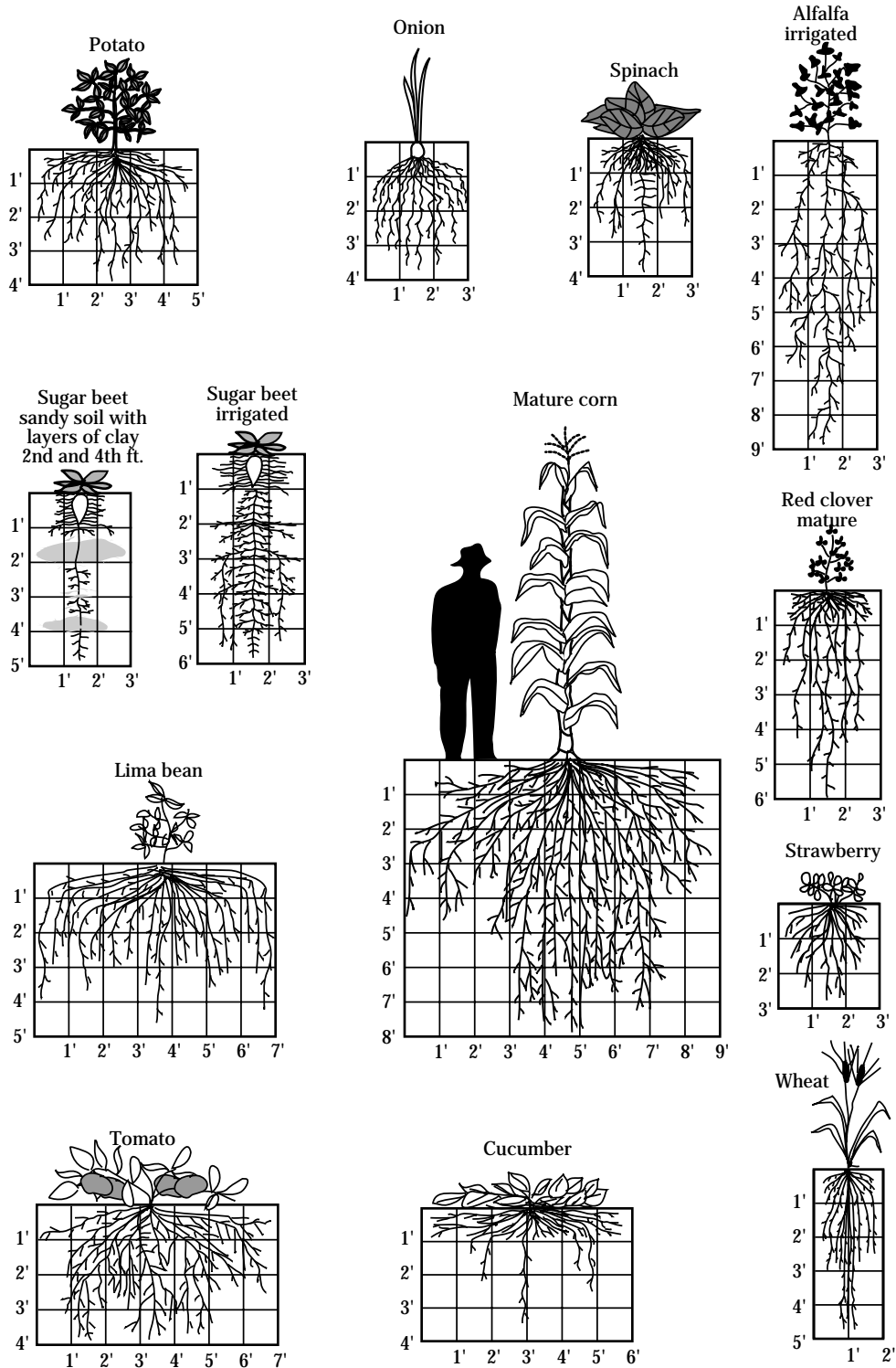

In uniform soils that are at field capacity, plants use water rapidly from the upper part of the root zone and more slowly from the lower parts. Figure 3–2 shows the typical water extraction pattern in a uniform soil. About 70 percent of available soil water comes from the upper half of a uniform soil profile. Any layer or area within the root zone that has a very low AWC or increased bulk density affects root development and may be the controlling factor for frequency of irrigations.

Figure 3–3 illustrates the effect on root development of some limitations in a soil profile. Variations and inclusions are in most soil map units, thus uniformity should not be assumed. Field investigation is required to confirm or determine onsite soil characteristics including surface texture, depth, slope, and potential and actual plant root zone depths.

Soil texture, structure, and condition help determine the available supply of water in the soil for plant use and root development. Unlike texture, structure and condition of the surface soil can be changed with management.

Figure 3–2 Typical water extraction pattern in uniform soil profile

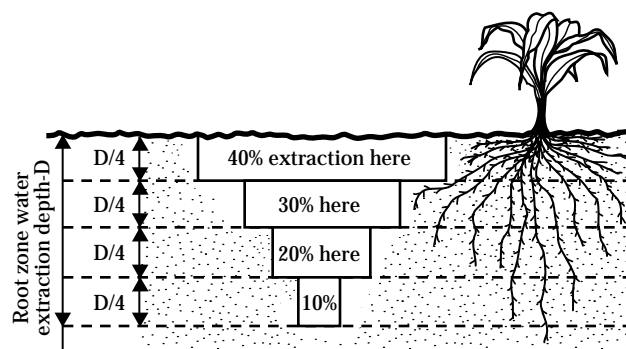

Note: Approximately 70 percent of water used by plants is removed from the upper half of the plant root zone. Optimum crop yields result when soil-water tensions in this area are kept below 5 atmospheres. Very thin tillage pans can restrict root development in an otherwise homogenous soil. **Never assume a plant root zone.** Observe root development of present or former crops.

Numerous soil factors may limit the plant's genetic capabilities for root development. The most important factors are:

- soil density and pore size or configuration,
- depth to restrictive layers and tillage pans,
- soil-water status,
- soil condition,
- soil aeration,
- organic matter,
- nutrient availability,
- textural or structural stratification,
- water table,
- salt concentrations, and
- soil-borne organisms that damage or destroy plant roots.

Root penetration can be extremely limited into dry soil, a water table, bedrock, high salt concentration zones, equipment and tillage compaction layers, dense fine texture soils, and hardpans. When root development is restricted, it reduces plant available soil-water storage and greatly alters irrigation practices necessary for the desired crop production and water conservation.

Root penetration is seriously affected by high soil densities that can result from tillage and farm equipment. Severe compacted layers can result from heavy farm equipment, tillage during higher soil moisture level periods, and from the total number of operations during the crop growing season. In many medium to fine textured soils, a compacted layer at a uniform tillage depth causes roots to be confined to the upper 6 to 10 inches. Roots seek the path of least resistance, thus do not penetrate a compacted dense layer except through cracks. Every tillage operation causes some compaction. Even very thin tillage pans restrict root development and can confine roots to a shallow depth, thereby limiting the depth for water extraction. This is probably most common with row crops where many field operations occur and with hayland when soils are at high moisture levels during harvest.

Compaction layers can be fractured by subsoiling when the soil is dry. However, unless the cause of compaction (typically tillage equipment itself), the number of operations, and the method and timing of the equipment's use are changed, compaction layers will again develop. Only those field operations essential to successfully growing a crop should be used. Extra field operations require extra energy (tractor fuel), labor, and cost because of the additional wear and tear on equipment. The lightest equipment with the fewest operations necessary to do the job should be used.

For site specific planning and design, never assume a plant root zone depth. Use a shovel or auger to observe actual root development pattern and depth with cultural practices and management used. The previous crops or even weeds will generally show root development pattern restrictions. See NEH Part 623, (Section 15), Chapter 1, Soil-Plant-Water Relationship, and Chapter 2, Irrigation Water Requirements, for additional information.

Figure 3-3 Effect of root development on soils with depth limitations

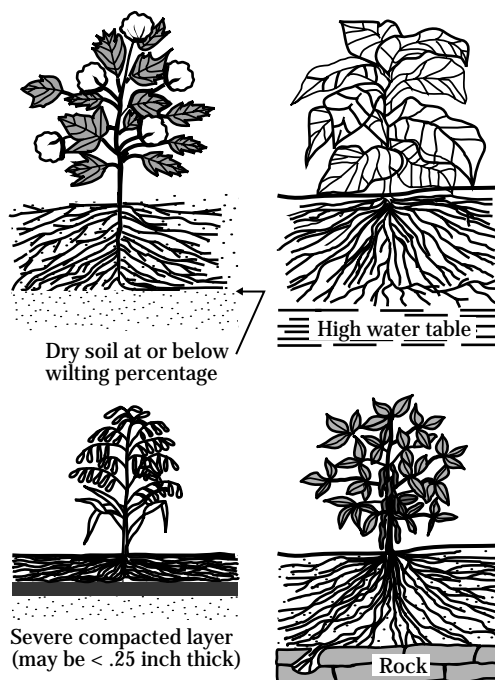

652.0302 Crop and irrigation system water requirements

(a) Crop evapotranspiration

Plants need water for growth and cooling. Small apertures (stomata) on the upper and lower surfaces of the leaves allow for the intake of carbon dioxide required for photosynthesis and plant growth. Water vapor is lost to the atmosphere from the plant leaves by a process called transpiration. Direct water evaporation also occurs from the plant leaves and from the soil surface. The total water used by the specific crop, which includes direct evaporation from plant leaves and the soil surface and transpiration, is called crop evapotranspiration (ET_c). Processes to determine local crop evapotranspiration are described in NEH, Part 623, Chapter 2, Irrigation Water Requirements, and in Chapter 4, Water Requirements, of this guide.

(b) Irrigation frequency

How much and how often irrigation water must be applied depends on the soil AWC in the actual plant root zone, the crop grown and stage of growth, the rate of evapotranspiration of the crop, the planned soil Management Allowable Depletion (MAD) level, and effective rainfall. More simply put; it depends on the crop, soil, and climate.

Never assume a plant root zone for management purposes. Check actual root development pattern and depth. See section 652.0301(d).

Once a MAD is selected, determining when to irrigate simply requires estimation or measurement of when the soil moisture reaches that level. Coarse textured and shallow soils must be irrigated more frequently than fine textured deep soils because fine textured deep soils store more available water. The moisture use rate varies with the crop and soil. It increases as the crop area canopy increases, as humidity decreases and as the days become longer and warmer.

Frequency can be estimated by dividing the MAD by the estimated or measured evapotranspiration of the crop as follows:

$$\text{Irrigation frequency (days)} = \frac{\text{MAD (inches)}}{\text{Crop ET rate (in/day)}}$$

A much higher quality product is produced if the MAD level is kept less than 35 percent in some crops, such as potatoes, pecans, vegetables, and melons. This is also true for mint.

Several methods are available for irrigation scheduling (determining when to irrigate and how much to apply). They are described in Chapter 9, Irrigation Water Management.

(c) Net irrigation requirement

The net amount of water to be replaced at each irrigation is the amount the soil can hold between field capacity and the moisture level selected when irrigation is needed (MAD). Maintaining the same soil moisture level throughout the growing season is not practical and probably not desirable. Ideally, an irrigation is started just before the selected MAD level is reached or when the soil will hold the irrigation application plus expected rainfall. The net amount of water required depends on soil AWC in the plant root zone and the ability of a particular crop to tolerate moisture stress. If the MAD level selected is 40 percent of AWC in the root zone (Soil-water Deficit = 40%), it is necessary to add that amount of water to bring the root zone up to field capacity. For example if the total soil AWC in the root zone is 8 inches and MAD = 40%:

$$\begin{aligned} \text{Net irrigation} &= 40\% \times 8 \text{ in} \\ &= 3.2 \text{ in} \end{aligned}$$

In semihumid and humid areas, good water managers do not bring the soil to field capacity with each irrigation, but leave room for storage of expected rainfall. When rainfall does not occur, the irrigation frequency must be shortened to keep the soil moisture within the MAD limit. It is a management decision to let MAD exceed the ability of an irrigation system to apply water. For example, if a center pivot sprinkler system applies a net of 1 inch per cycle, let MAD be equal to 1 inch plus expected rainfall. MAD for a surface irrigation system will be typically greater as heavier applications are required for best uniformity across the field.

(d) Gross irrigation requirement

The gross amount of water to be applied at each irrigation is the amount that must be applied to assure enough water enters the soil and is stored within the plant root zone to meet crop needs. No irrigation system that fully meets the season crop evapotranspiration needs is 100 percent efficient. Not all water applied during the irrigation enters and is held in the plant root zone. Also, all irrigation systems have a distribution uniformity less than 100 percent. Applying too much water too soon (poor irrigation water management) causes the greatest overuse of water. Irrigation systems and management techniques are available that reduce the avoidable losses. They are described in chapters 5, 6, 7, 8, and 9 of this guide.

Unavoidable losses are caused by:

- Unequal distribution of water being applied over the field.
- Deep percolation below the plant root zone in parts of the field.
- Translocation or surface runoff in parts of the field.
- Evaporation from the soil surface; flowing and ponded water.
- Evaporation of water intercepted by the plant canopy under sprinkler systems.
- Evaporation and wind drift from sprinklers or spray heads.
- Nonuniform soils.

For a given irrigation method and system, irrigation efficiency varies with the skill used in planning, designing, installing, and operating the system. Local climatic and physical site conditions (soils, topography) must be assessed. To assure that the net amount of soil water is replaced and retained in the root zone during each irrigation, a larger amount of water must be applied to offset the expected losses. The gross amount to be applied is determined by the equation shown at the bottom of this page.

For more information on irrigation and system requirements, see Chapter 4, Water Requirements; NEH Part 623, Chapter 2, Irrigation Water Requirements; and the West National Technical Center publication, Farm Irrigation Rating Index (FIRI), A method for planning, evaluating and improving irrigation management.

$$\begin{aligned} \text{Gross irrigation amount (in)} &= \frac{\text{Net amount to be replaced (in)}}{\text{Overall irrigation efficiency of system including management (\%)}} \\ &= \frac{\text{Management Allowable Depletion (MAD)}}{\text{Overall irrigation efficiency}} \end{aligned}$$

652.0303 Reduced irrigation and restricted water supply

Several opportunities are available to the irrigator in semiarid, subhumid, and humid areas for reduced irrigation water application:

- Maximizing effective rainfall.
- Deficit or partial season irrigation.
- Selection of crops with low water requirements during normal high water use periods; i.e., small grains, (or accept the risk of drought periods).
- Selection of drought resistant crops and varieties that provide yields based on water availability, i.e., alfalfa hay, grass pasture (accept the reduced yields caused by drought periods).
- Irrigate just before critical growth period(s) of the crop to minimize critical plant moisture stress during those periods.
- Use state-of-art irrigation scheduling techniques that use local area climate and onsite rainfall data, and field-by-field soil moisture status monitoring.
- Use tillage practices that allow maximum surface storage and infiltration of rainfall events, reducing runoff and soil surface evaporation.
- Follow an intensive crop residue management and mulch program and minimize tillage to reduce soil surface evaporation.
- Reduce irrigated acreage to that which can be adequately irrigated with the available water supply.

Risk is less when growing crops on deep, high AWC, loamy soils and in climatic areas that have adequate rainfall for the crop. The risk is greater when growing crops on low AWC soils even in areas that have adequate rainfall during the growing season. When growing high value crops, an irrigation system and adequate water supply are highly desirable for insurance against potential crop loss. A detailed economic analysis should be completed to provide estimates of optimum net benefits. The analysis should include cost of water, pumping costs, reduced yields caused by reduced crop water use, and reduced tillage operation costs. Subsequent management decisions should be based on this analysis. See chapter 11 for additional discussion.

In some areas irrigation water delivery systems, including management, limit on-farm water management improvements. *Rotational* delivery systems have the lowest on-farm water management potential, while *on demand* delivery systems have the highest.

Improving both management and the irrigation system can reduce the amount of water applied and more effectively use existing water supplies. Improving water management, including irrigation scheduling and adequate water measurement, is always the first recommended increment of change. Improving existing irrigation systems is the next. Unless the existing irrigation system is unsuitable for the site, crop grown, or water supply, converting to another irrigation method seldom produces benefits equal to improvements in water management. See Chapter 5, Selecting an Irrigation Method, for additional information on selecting and applying the best method or system for the site.

652.0304 Adapted irrigation systems

All crops can be efficiently irrigated by more than one irrigation method and system. Crops grown and their cultural requirements aid in determining the irrigation method and system used. Crops can be placed in broad categories as follows:

Category 1. Row or bedded crops:

sugar beets, sugarcane, potatoes, pineapple, cotton, soybeans, corn, sorghum, milo, vegetables, vegetable and flower seed, melons, tomatoes, and strawberries.

Category 2. Close-growing crops (sown, drilled, or sodded):

small grain, alfalfa, pasture, and turf.

Category 3. Water flooded crops:

rice and taro.

Category 4. Permanent crops:

orchards of fruit and nuts, citrus groves, grapes, cane berries, blueberries, cranberries, bananas and papaya plantations, hops, and trees and shrubs for windbreaks, wildlife, landscape, and ornamentals.

A comparison of irrigation system versus crops that can be reasonably grown with that system is displayed in table 3-5.

See Chapter 5, Selecting an Irrigation Method, Chapter 6, Irrigation System Design, and chapters 3, 4, 5, 7, and 11 of the National Engineering Handbook, Part 623 (section 15) for more information on adapted irrigation systems.

Table 3-5 Irrigation system vs. crops grown

Irrigation system	--- Crop category ---			
	1	2	3	4
Surface				
Basins, borders		x	x	x
Furrows, corrugations	x	x		x
Contour levee - rice		x	x	
Sprinkler				
Side (wheel) roll lateral	x	x		
Hand move lateral	x	x		x
Fixed (solid) set		x		x
Center pivot, linear move	x	x		
Big guns - traveling, stationary	x	x		
Micro				
Point source				x
Line source	x			x
Basin bubbler				x
Mini sprinklers & spray heads				x
Subirrigation	x	x	x	x

652.0305 Temperature— effects and management

Crop yield and quality can be negatively affected by temperature extremes, both cold and hot. Application of water in a timely manner can provide some degree of protection. Water can also be applied to cool plants to maintain product quality, to delay bud development, and to provide frost protection of buds, flowers, and young fruit.

(a) High temperatures

Extremely high temperatures can

- put plants into a temporary plant moisture stress,
- hasten untimely fruit development and ripening,
- cause moisture stress in ripening fruit,
- sunburn berries and other fruit,
- overheat bare soils during seed germination (i.e., lettuce), and
- overheat standing water in basin irrigation.

Water used for temperature modification as a crop and soil coolant is typically applied with a sprinkler/spray system.

(b) Low temperatures

When temperatures drop below the critical temperature, damage can occur to both annual and perennial plants. If ambient air temperature and humidity are severely low, permanent damage to fruit, citrus, and nut trees can occur. When it drops below freezing, the developing buds and flowers on fruit and berry plants can be damaged. Temporary freeze back of new growth in grasses and legumes can occur, and healthy annual plants can be killed or damaged beyond recovery.

Water can be applied to provide frost protection to about 25 °F. Sprinkler/spray systems that apply water overhead onto the plant canopy are typically used. This allows a protective layer of ice to build up on the leaves, blossoms, and buds. Frost protection involves heat release caused by changing water to ice. The process must be understood to determine the application rate and timing of water for adequate frost protection. Some limited success has been attained with under-tree spray systems and surface flooding systems.

See NEH, Part 623 (Section 15), Chapter 2, Irrigation Water Requirements, for further information.

652.0306 Salinity and sodicity effects

(a) General

In arid areas nearly all irrigation water and soils contain salts, some of which are toxic to plants and animals. When water is removed from the soil profile by plant transpiration and soil surface evaporation, salts remain in the soil profile and on the soil surface. If the soil-water solute is high in sodium, the soil becomes sodic. All other ionic concentrations in solution (i.e., calcium, magnesium, potassium) cause salinity. These conditions are particularly common where most of the crop water requirement comes from irrigation. The problem eventually becomes serious if

- irrigation or natural precipitation is not sufficient to leach the accumulating salts,
- water and soil management are less than adequate,
- soil and water amendments are inadequate, or
- the soil is poorly drained.

Salinity and sodicity problems can also develop as a result of saline seeps, use of poor quality irrigation water including flooding by brackish water near the ocean, or by using drainage water from upslope irrigation. As salt concentrations increase above a threshold level, the growth rate, mature size of crops, and product quality progressively decrease.

Principal objectives of water management are to maintain soil tilth, soil-water content, and salinity and sodicity levels suitable for optimum plant growth. A natural occurring internal drainage or an installed drainage system within the usable soil profile is essential. See Chapter 13, Quality of Water Supply, for additional information.

(b) Measuring salinity and sodicity concentration

A method has been developed to measure and quantify salinity and sodicity levels in soils. Thus, the salinity of a soil can be determined by measuring the electrical conductivity, EC_e , of the soil-water extract expressed in millimhos per centimeter or decisiemens per meter,

corrected to a standard temperature of 77 °F (25 °C).
1 mmho/cm = 1 dS/m.

Salt molecules in solution produce electrically-charged particles called ions. Ions can conduct an electrical current. The greater the concentration of ions in a solution, the greater the electrical conductivity of the solution.

To measure sodicity in soil, the Sodium Adsorption Ratio (SAR) is used. It is a measure of the ratio of sodium to calcium plus magnesium present.

$$SAR = \frac{Na}{\left(\frac{Ca + Mg}{2}\right)^{\frac{1}{2}}}$$

(c) Effects of salinity on yields

Crop yields and quality are reduced when salinity levels exceed a certain threshold. See NEH, Part 623, Irrigation, Chapter 1, Soil-Plant-Water Relationships (table 1-8), and Chapter 2, Irrigation Water Requirements. The information presented provides two essential parameters for expressing salt tolerance:

- The salinity threshold level above which reduced yield will occur
- The percent yield reduction per unit salinity increase beyond the threshold level

(d) Effect of salinity and sodicity on AWC

Plants extract water from the soil by exerting an adsorptive force or tension greater than the attraction of the soil matrix for water. As the soil dries, remaining water in the soil profile is held more tightly by soil particles. Salts also attract water. The combination of drying soils and elevated salt concentrations results in less water at a given tension being available for plant uptake. The reduction in water available to the crop as salinity increases is evident in figure 2-7, chapter 2, which shows the volumetric water content versus soil-water potential for a clay loam soil at various degrees of soil salinity, EC_e . Table 2-4 provides a process to estimate AWC based on texture and EC_e of 0 to 15 mmho/cm.

If the salt content of the soil cannot be maintained or reduced to a point compatible with the optimum yield of a crop, a more salt-tolerant crop should be grown or the operator must accept reduced yields. Most often, salinity or sodicity is not maintained below plant thresholds because less than adequate soil and water management practices are followed.

(e) Management practices for salinity and sodicity control

The major objective of salinity management is to keep soil salinity and sodicity below thresholds for seed germination, seedling establishment, crop growth, and quality while minimizing the salt loading effects of drainage outflow. Procedures that require relatively minor changes in management are:

- Improved irrigation water management
- Improved crop residue management
- Adding soil and water amendments
- Selection of more salt-tolerant crops
- Leaching with additional irrigation water
- Preplant irrigations
- Changing of seed placement on the furrow bed

Maintaining a higher soil-water content decreases soil-water tension; thereby, increasing water available to plants. Alternatives that require significant adjustments are:

- Changing the water supply
- Changing irrigation methods
- Land leveling for improvements to surface drainage and irrigation water distribution
- Modifying the soil profile
- Providing for internal drainage

ASCE Report No. 71, *Agricultural Salinity Assessment and Management* (1990) gives specific recommendations regarding salinity and sodicity assessment and management.

Irrigated agriculture cannot be sustained without adequate leaching and internal drainage to control buildup of calcium, sodium, and other toxic ions in the soil profile. Where subsurface drainage systems are installed to improve downward water movement and removal of the required leaching volume, soluble salts plus other agricultural chemicals and fertilizers move with the drainage water. They have the potential to move to streams, wetlands, estuaries, and lakes.

Where possible, leaching events should be planned when soil nitrate levels are low. The leaching requirement for salinity control can be minimized with good irrigation water management and with adequately designed, installed, and operated irrigation water delivery and application systems.

Drainage outflow with high salt concentrations can be disposed of through use of evaporation ponds (the salts remain), or often water can be directly reused as an irrigation water supply for applications where saline water is acceptable, such as irrigation of salt-tolerant plants or for industrial uses. In some areas drainage outflow with high salt concentration may not be allowed to be released to public waters without a point-discharge permit, or it must be desalted. In most high salt content water reuse operations, the salt moves and precipitates out at another spot. It does not go away.

When irrigating with high salt content water, internal soil drainage and leaching are required to maintain an acceptable salt balance for the plants being grown. The salt concentration in drainage outflow can be quite high, and concern for safe disposal still exists. Some saline and sodic tolerant crops require high quality water for germination and establishment. Once the crop is established, poorer quality water can be used. Generally, water containing different saline-sodic concentrations should not be mixed.

(f) Toxic elements

Toxicity problems can be the same or different from those of salinity and sodicity because they can occur between the plant and the soil and may not be caused by osmotic potential or water stress. Toxicity normally results when certain ions are present in the soil or absorbed with soil-water, move with the plant transpiration stream, and accumulate in the leaves at concentrations that cause plant damage. It also can result from water sprayed directly on leaf surfaces. The extent of the damage depends on the specific ion concentration, crop sensitivity, crop growth stage, and crop water use rate and time.

The usual toxic ions in irrigation water include chloride, sodium, and boron. Excessive chlorine in domestic water systems and salts from water softeners in home systems can also be a problem. Not all crops are

sensitive to these ions, but some crops are very sensitive. Chemical analysis of plant tissue, soil-water extract, and irrigation water is most commonly used to identify toxicity problems.

The affect of toxic elements (i.e., selenium) on waterfowl from drainage outflow has also been observed in several areas. Toxic elements that occur naturally in the soil (i.e., selenium and boron) in high concentrations or were used as pesticide control in past years (i.e., arsenic and mercury) are of great concern. Irrigation water that deep percolates below the plant root zone can potentially carry these dissolved toxic elements downslope into the ground water and can eventually flow into wetlands, estuaries, streams, and lakes.

See NEH Part 623, Chapter 2, Irrigation Water Requirements, for further information on management of soil salinity and sodicity and on assessment of boron and other toxic elements.

652.0307 Crop data bases

The Field Office Computer System (FOCS) includes a plant data base that is site specific and can be used directly by applications for planning and designing irrigation systems.

652.0308 State supplement

652.0203 Explanation of tables and data bases

Washington State soil survey database is available at several internet sites. NRCS employees should use [my.nrcs](https://my.nrcs.usda.gov).

<https://my.nrcs.usda.gov/default.aspx>

After logging in:

- Go to **field tools**.
- From this tab look under the Resources Information section for the **► Soil Survey** link. This will take you to the NRCS soil survey web site.
- At this point select the **⇒ Online Surveys**.
- Go to the state desired.
- A table listing Soil Survey Reports including online maps, legends, tables and reports by county will be produced.
- Chose your county and for the example shown in Table WA2-1, go to Reports.
- Each of the soils in the county are listed on this Reports table. Select the soil(s) you are interested in by clicking anywhere on the line. You can select more than one soil by using the Shift key to get a group or the Ctrl key to choose more than one soil on the list.
- After choosing the soil(s) you are interested in, go to Report Descriptions, and use the arrow to see the reports available. Choose one and hit the Generate Report button. The example is the Physical Soil Properties.
- The report is now sent to adobe acrobat reader and you can print or save the file for later use.

- Other counties, properties, and soils are listed. This is very user friendly site. It is easy to operate and pull up the soils information for your location(s).

For public use, the soils reports are on the USDA web site. The location of the web site is located at:

<http://soils.usda.gov/survey/>

At this site, the user follows the steps listed previously beginning at the select **⇒ Online Surveys**.

652.0204 State supplement

(a) Soil Surveys

Soil information and field interpretations are also available in Section II of the Field Office Technical Guide. This is located online as listed in Section 652.203.

Limited printed copies are available in the local field offices.

(b) Soil Properties

Table WA2-1, on the following page, displays soil properties and design values for irrigation, by soil series, for an irrigated soil in Washington. Values displayed are interpreted data taken from Section II of the FOTG, or represent actual field data, or laboratory test results. Soils specifically having field or display laboratory test data are also indicated. This table was generated from the online soils report listed in Section 652.203.

Table WA2-1 Soil Properties**Physical Soil Properties**

Grant County, Washington

[Entries under "Erosion Factors—T" apply to the entire profile. Entries under "Wind Erodibility Group" and "Wind Erodibility Index" apply only to the surface layer. Absence of an entry indicates that data were not estimated.]

Map symbol and soil name	Depth	Sand	Silt	Clay	Moist bulk density	Saturated hydraulic conductivity	Available water capacity	Linear extensibility	Organic matter	Erosion factors			Wind erodibility group	Wind erodibility index
										Kw	Kt	T		
	in	Pct	Pct	Pct	g/cc	micro m/sec	in/in	Pct	Pct					
115: Royal	0-10	—	—	5-10	1.20-1.40	14.00-42.00	0.13-0.16	0.0-2.9	0.5-1.0	43	43	5	3	66
	10-16	—	—	5-10	1.30-1.50	14.00-42.00	0.12-0.16	0.0-2.9	0.0-0.5	49	49			
	16-60	—	—	3-10	1.40-1.80	14.00-42.00	0.10-0.14	0.0-2.9	0.0-0.5	43	43			

(c) Example

The following is an example of how to use the soil survey data to determine water-holding capacities for crops with root depths of 24, 36, and 60 inches. Typical root depths for most crops can be found in the NIG 652.0301 (d) Table 3-4.

Use the Physical Soil Properties table above to determine the depth and average 'available water capacity' (AWC) for each layer. Next multiply by the depth in each layer times the AWC. Add the totals for each layer to get the total for the rooting depth.

Depth (in)	Available Water Capacity-average in/in	Root Depth 24"	Root Depth 36"	Root Depth 60"
0-10	0.15	10*0.15=1.5	10*0.15=1.5	10*0.15=1.5
10-16	0.14	6*0.14=0.8	6*0.14=0.8	6*0.14=0.8
16-60	0.12	8*0.12=0.96	20*0.12=2.4	44*0.12=5.28
	Total	3.3"	4.7"	7.6"

The total values are based on the amount of water available for crop use from field capacity to permanent wilting point. These totals will be reduced using crop management allowable deficiencies (MAD) values to give the readily available water, or allowable depletion, from the soil profile. MAD values are shown in NIG 652.0301 (c) Table 3-3 and will be discussed later.

652.0308 State Supplement

(a) Irrigating with limited water supplies

Irrigation managers can do something other than purchase additional equipment or reduce irrigated acreage to accommodate limited water supplies. Well-timed irrigations may help managers irrigate more acres without lowering crop yields.

By making the best use of water, irrigation managers can free-up both water and equipment for use on other crops or other land. Seed-producing crops respond more to irrigations during one particular stage of development than during other stages. Some of those crops include corn, barley, sunflowers, wheat and beans. Yields of storage and forage crops--sugarbeets, potatoes, alfalfa and grasses--are more directly related to climatic demand and cumulative water use during the season than to stress during any particular growth stage.

Sugarbeets are quite drought tolerant. They can withstand extended periods without rainfall or irrigation water by using water stored in the soil. Limited water can even increase the efficiency of sucrose production. Sucrose yield per unit of water use can be increased above that where maximum water use is allowed, simply by cutting off irrigations three to four weeks before harvest operations. Sugarbeets are only moderately sensitive to plant stress, except during the early growth stages. Afternoon leaf wilting during hot, dry, windy conditions has negligible effects on total sugar production. Water can be used more efficiently on sugarbeets by applying one, last major irrigation to recharge the entire soil profile at the onset of the major stress period. Sugarbeets adapt to limited irrigations by using deeply stored soil

water and quickly recovering, when water is made available following major stress periods. Normal irrigations of sugarbeets could be reduced after the middle of July. Sucrose yield is likely to be reduced very little when such a practice is used and a final heavy irrigation is applied in early August.

Corn is very sensitive to drought stress, especially during the flowering and reproductive stages. Stress during the early vegetative stage is not nearly as serious as stress during flowering, pollination and early seed filling. Grain corn is most sensitive to drought stress between the 12-leaf and blister kernel stages; this period includes flowering, pollination and initial seed filling. Stress during any part of the cropping season limits grain corn production. To maximize water use efficiency in grain corn, it is best to limit irrigations during the vegetative stage. The period from emergence to 12-leaf was least sensitive to stress.

Barley responds to drought stress much like corn and other cereal crops. Yield is likely to be reduced very little when drought stress occurs during the vegetative period. However, a major disadvantage of early drought stress is the tendency for plants to tiller more than usual. Although the increased tillering is desirable, often the tillers never produce grain-yielding heads. Barley is most sensitive to stress during jointing, booting and heading. Considering drought stress before, during and after heading, yield is reduced the most by drought before heading. Flowering and pollination appear to be the most sensitive periods.

Several studies have been conducted with spring wheat and winter wheat to evaluate the effect of limited irrigations on crop quality and production. Stress was most critical during and after heading. This response is similar to that for

barley. There is little or no measurable benefit from irrigating spring grains before the boot stage, unless moisture stress is evident. Stress is likely to occur when the plants appear wilted and the leaves curl. The period between grain filling and maturity is critical. Yield is reduced the most when stress starts during soft dough or during or following heading. Stress during the maturing process results in about a 10 percent lower yield. Moderate stress during the early vegetative period has essentially no effect on yield. Irrigation managers can use water most efficiently on spring-planted grains by reducing early-season irrigations and minimizing crop stress during flowering, pollination and seed filling.

Drought stress on winter wheat production during early spring regrowth results in heading approximately seven to 10 days prematurely. The consequence of early heading is early maturity and a shortened growth period; thus, yield is reduced. Early stress results in development of more heads than usual. However, many of the heads fail to produce grain. Winter wheat is most sensitive to drought stress during shooting and booting. It is essential to avoid even slight water stress at jointing. Withholding water to increase tillering may lead to premature heading and grain maturity.

High-quality potato yields can be achieved only by maintaining a uniformly high level of available water throughout the crop season. Short four-to-five day stress periods do not lower yields significantly or deteriorate the quality of potatoes compared to unstressed crops. Potato production is directly related to crop water use between emergence and defoliation. Potatoes are not susceptible to severe yield reductions from short periods of

moderate stress during any single period of production.

Alfalfa forage yield is directly related to available water and actual plant water use. Alfalfa is not nearly as sensitive to plant water stress at different times of the season as are most of the grain-producing crops. Forage increases of one-sixth to one-fifth ton per acre per year for each inch of applied water have been obtained. Maximum water use by alfalfa is not likely to exceed 24 inches between late April and the latter part of August. Most alfalfa varieties, when subjected to plant water stress, will go into dormancy, thus dramatically reducing both water use and production. When irrigation reduces stress, the crop resumes growth. Alfalfa is much less sensitive to plant water stress, regardless of when it occurs during the growing season.

Essentially two types of response occur when irrigated crops are subjected to drought stress. Determinate crops, which are grown primarily for the harvest of mature seed and depend on day length and season length, are most sensitive to drought stress during the seed formation period. This period includes heading, flowering and pollination. Crops most affected by stress during this period include small grains, other cereal crops and oilseed crops. Drought stress that occurs between seed development and maturity also limits yield, but to a lesser degree. These same crops are relatively insensitive to drought stress during the early vegetative period.

Indeterminate crops, such as tuber and root crops that are grown primarily for the harvest of storage organisms, are relatively insensitive to moderate drought stress for short intervals throughout the entire crop growing season. Crops like potatoes, sugar beets, alfalfa and

pasture, quickly recover from short stress periods and little reduction in yield occurs.

Irrigation managers confronted with limited irrigation water should consider making the most efficient use of water by their crops. For seed crops, this means cutting back on early-season irrigations and ensuring minimum stress conditions between seed development and maturity. For root, tuber and forage crops, irrigation managers should minimize the number of early-season irrigations and eliminate late-season irrigations.

This is provided in part and is located at:

<http://www.montana.edu/wwwpb/ag/baudr298.html>

For additional information or to receive a regular email distribution of agronomy notes such as the one above, Jim Bauder can be contacted by email at "jbauder@montana.edu" or by calling 406-994-5685 at Montana State University.

This note is part of the Agronomy Notes series, a weekly news release and fact sheet series prepared by: James W. Bauder, Soil and Water Specialist Montana State University, Plant, Soils, and Env Sci Bozeman, MT 59717, ph. (406) 994-5685, fax 406/994-3933 jbauder@montanai.edu

(b) Use of Water Supply Forecasts

Purpose of forecasts

Snow surveys and water supply forecasts provide the information from which advance estimates of available surface waters, to meet the demands of the irrigated areas, are made. The primary use of water supply forecasts in

agriculture is to adjust demand to the available water supply.

Although water supply forecasts are provided for over 600 points in the Western United States, it is quite likely that a forecast is not available for the exact point a user needs for planning purposes. "Forecast localization" techniques can be used to relate a standard forecast point to a nearby delivery point. Data for irrigation diversions and ditches are often available from irrigation districts, canal companies, or water masters.

Additional information, including commonly asked questions and definitions, can be found at the following website:

<http://www.wcc.nrcs.usda.gov/factpub/fcstguid.htm>

The NRCS National Irrigation website is also a good source of information:

<http://www.wcc.nrcs.usda.gov/nrcsirrig/>

Water supply forecasts are very well suited to areas with and without stored water supply. These allow farmers to plan when and how to use the projected quantity of water that will be available for their use. It is then a matter of determining whether:

- The irrigated acreage should be cut back
- To extend the limited water supply over all the acreage, there by reducing the number of irrigations and reducing yields (planned deficit irrigation)
- To postpone the seeding of more land
- To irrigate best or highest productive fields
- To improve delivery system and/or
- To supplement supply with wells

Planning principles

Generally, more efficient use of stored water is achieved by using an adequate supply of water on a limited acreage than by spreading a short water supply over all available acreage.

If water supply is expected to be less than normal:

- Perennial hay crops should be allotted a reasonable amount of water early in the season to produce a good first cutting.
- Priority in the use of water should go to the best fields and especially those most efficiently irrigated.
- The farmer must decide, in line with economic benefits and management problems, the proportion of acreage in high water-using and more profitable crops in relation to low water-using crops and fallow.
- Special attention should be given to improving the efficiency of the irrigation system and the distribution system as well.
- Consideration should be given to seasonal needs and growth characteristics of plants in relation to water availability.
- Livestock numbers may need to be reduced in anticipation of feed shortages.

If water supply is expected to exceed the normal demand.

- Over-irrigation and waste should be avoided.
- More heavy water using crops may be planted.

- Leaching of salts from the soil may be accomplished.
- Water can remain in storage for use in succeeding years. Cooperative agreements for carry over storage should be worked out among the water users.
- Apply deep, late season irrigations to utilize the storage capacity of the soil.

Forecast Data

In the water supply forecast bulletins published by the Natural Resources Conservation Service, the stream flow forecast is stated in terms of the number of acre feet that will flow past an established stream gaging station during a designated interval, such as April 1 to July 30. This is followed by a statement that gives the forecast in terms of the percent of normal. The various state and federal agencies in the western states have designated the 30 year average as the base period or normal. Every ten years, the average is updated.

Low flow forecasts are made which predict levels and date of the levels of the stream in relation to water rights on that stream. This indicates how long water will last and adequacy of late season supply, if any is available.

Water requirements versus available supply

The estimated monthly normal consumptive use and net irrigation water requirement charts were developed for each crop in the areas served by this guide. The data includes effective precipitation, crop use, length of growing season, etc.

The following example illustrates how this data may be used with cooperators in conjunction with water supply forecasts. Assume that a

farm contains 160 irrigated acres. The estimated irrigation water requirements by months for crops grown in the area are shown. Losses in water transmission and application may add 50 percent or more to these irrigation requirements, depending upon the efficiencies

of the irrigation methods and farm distribution systems. The estimated water requirements for the various crops in the particular climatic area may be as follows:

Crop	Puyallup	Yakima	Spokane
	Net Irrigation Water Required (Inches)	Net Irrigation Water Required (Inches)	Net Irrigation Water Required (Inches)
Alfalfa Hay	14.27	35.31	26.62
Pasture	17.62	37.28	28.21
Spring Grain	8.47	23.06	23.40
Silage Corn	12.24	28.20	21.19

An example of normal crop planting on this farm in **Yakima** is as follows:

Crop	Acres	Net	Total Net Requirements (Ac-Ft)	Field Efficiency (%)	Gross Field Application (Ac-Ft)	Gross* Farm Application (Ac-Ft)
		Irrigation Water Required (Inches)				
Alfalfa Hay	60	35.31	176.5	85	207.7	218.1
Pasture	40	37.28	124.3	65	191.2	200.7
Spring Grain	40	28.20	94.0	65	144.6	151.8
Silage Corn	20	23.06	38.4	50	76.9	80.7
Totals	160				620.4	651.3

*The on farm transmission system water losses were estimated at 5%. The actual farm transmission losses may vary.

If the forecast and records of the irrigation company indicate that 651 acre feet can be delivered as required throughout the growing season, adequate water is assured for all crops. If a lesser amount of water is predicted, the farmer will have to make some adjustments as to the most economical acreage to apply the available water.

Reference should be made to cost and return information for various crops to help determine highest returns. Use information developed locally or in similar areas, and revised to fit particular situations.

Assume that the allotment of water will be 430 (67%) acre feet that can be delivered to the farm throughout the growing season instead of the 651 acre feet normally required. If five percent

loss in the farm distribution system is estimated, the amount of irrigation water available for the various crop fields will be 408 acre feet. The farmer has several alternatives in determining

the cropping pattern and must select those that will fit the particular situation. Examples of these alternatives follow:

Fully irrigate normal acreage of alfalfa hay and the irrigated pasture. Any extra water can be used to supplement the spring grain to the extent water is available:

Crop	Acres	Gross Total Net Requirements (Ac-Ft)	Field Application (%)	Field Application (Ac-Ft)
Alfalfa Hay	60	176.5	85	207.7
Pasture	40	124.3	65	191.2
Spring Grain	40	5.9	65	9.1
Silage Corn	Idle	0		0
Totals - 100 full irrigation; supplement on 40 ac Spring Grain				408

Another alternative is to fully irrigate the normal acreage of spring grain, pasture, and irrigate alfalfa hay for the first two cuttings only:

Crop	Acres	Net Irrigation Water Required (Inches)	Total Net Requirements (Ac-Ft)	Field Efficiency (%)	Gross Field Application (Ac-Ft)
Alfalfa Hay	60	22.06*	110.3	85	129.8
Pasture	40	37.28	124.3	65	191.2
Spring Grain	40	17.00*	56.7	65	87.2
Silage Corn	Idle				0
Totals	140				408.2

* The part season water requirement for alfalfa hay is the accumulated net irrigation water requirement from Appendix A, Jan thru July. The water for the spring grain is supplemental and is used to the extent available.

Assume, as is quite often the case, that the irrigation water will be available only during the early months of the growing season due to a lack of suitable storage. For these conditions, an alternative use of the irrigation water would be as follows:

Irrigate alfalfa hay for the first two cuttings; irrigate the pasture during April through July, and use the balance of the water on spring grain.

Crop	Acres	Net Irrigation Water Required (Inches)	Total Net Requirements (Ac-Ft)	Field Efficiency (%)	Gross Field Application (Ac-Ft)
Alfalfa Hay	60	22.06*	110.3	85	129.8
Pasture	40	23.27*	77.6	65	119.3
Spring Grain	60	20.66*	103.3	65	158.9
Totals	160				408.0

* The part season water requirement for the Alfalfa Hay and Pasture is the accumulated net irrigation water requirement from Appendix A, Jan thru July, Spring Grain is supplemental used as long as available.

Changes in field efficiency through system improvements can also increase the area that water can be applied on or increase the amount of water applied to the entire field to ensure a better quality crop or yield.

(c) Crop Nutrient Content

A tool on the web has been developed by NRCS to approximate the amount of nitrogen, phosphorus, and potassium that is removed by the harvest of agricultural crops.

This site can be found at:

http://npk.nrcs.usda.gov/nutrient_body.html

(d) Salinity

The Agriculture Research Service has developed a web site for salt, boron and chloride tolerance in crops. This site is:

<http://www.usssl.ars.usda.gov/databases.htm>

(e) Example Management Allowable Depletion (MAD) and Irrigation Frequency

Following is an example of how to select a Management Allowable Depletion (MAD) and use it to calculate net irrigation water requirement and irrigation frequency.

Given: The operator is growing potatoes on a sandy loam soil. The crop ET rate is .34 in/day.

Find: Select an appropriate MAD value and determine the net irrigation requirement and the irrigation frequency.

Solution:

Step 1. Using procedures mentioned in Chapter 2, the available water capacity is estimated at 3.36 in at 24”.

Table 3-4 shows typical rooting depths. For the purpose of this example, a rooting depth of 2 feet is selected. (In an actual situation never assume a plant root zone for management purposes, rather check actual root development pattern and depth.) From Table 3-3 select a MAD of 35%. Net irrigation can be calculated the following way:

$$\text{Net Irrigation} = \text{Available water capacity (AWC)} \times \text{Root Depth} \times \frac{\text{MAD}\%}{100}$$

$$\text{Net Irrigation} = 3.3\text{in} \times \frac{35\%}{100} = 1.15 \text{ inches}$$

Step 2. The Irrigation frequency can be calculated as follows:

$$\text{Irrigation frequency} = \frac{\text{MAD}}{\text{Crop ET rate}} = \frac{1.15 \text{ inches}}{0.34 \text{ in / day}} = 3.4 \text{ days}$$

Chapter 4

Water Requirements

Contents:	652.0400	General	4-1
	652.0401	Methods for determining crop evapotranspiration	4-1
		(a) Direct measurement of crop evapotranspiration	4-1
		(b) Estimated crop evapotranspiration— ET_c	4-1
	652.0402	Crop evapotranspiration	4-3
		(a) Daily crop ET rate for system design	4-3
	652.0403	Net irrigation water requirement	4-3
	652.0404	Management allowable soil-water depletion	4-7
	652.0405	Auxiliary water requirements (other needs)	4-7
	652.0406	Water table contribution	4-8
	652.0407	Water requirements for soil-water budget/balance analysis	4-8
		(a) Example soil-water budget	4-9
	652.0408	State supplement	4-10

Tables	Table 4-1	Example tabular display—crop evapotranspiration using FAO Blaney-Criddle equation	4-5
	Table 4-2	Example soil-water budget	4-10

Figures	Figure 4-1	Example monthly crop evapotranspiration, arid climate in normal year	4-6
	Figure 4-2	Example monthly crop evapotranspiration, subhumid climate in normal year	4-6

652.0400 General

Determination of irrigation water requirements requires a measurement or estimate of the rate of crop water use. Daily and weekly crop water use estimates are needed to schedule irrigation applications and determine minimum system capacities. Seasonal or annual water use is required to size irrigation reservoirs and diversion facilities and to establish water rights. Therefore, a procedure to determine both short- and long-term rates of water use is necessary. Chapter 2, Irrigation Water Requirements, NEH, Part 623, describes the processes needed to determine crop evapotranspiration and irrigation water requirements for a crop, field, farm, and project.

Crop evapotranspiration (ET_c), sometimes called crop consumptive use, is the amount of water that plants use in transpiration and building cell tissue plus water evaporated from an adjacent soil surface. Crop evapotranspiration is influenced by several major factors: plant temperature, ambient air temperature, solar radiation (sunshine duration/intensity), wind speed/movement, relative humidity/vapor pressure, and soil-water availability. Daily, weekly, monthly, and seasonal local crop water use requirements must be known. These data are essential for planning, designing, and operating irrigation systems and for making irrigation management decisions, such as determining when and how much to irrigate.

Seasonal water requirements, in addition to crop water needs, may also include water used for preplant irrigation, agricultural waste application, leaching for salt control, temperature control (for frost protection, bud delay, and cooling for product quality), chemigation, facilitation of crop harvest, seed germination, and dust control.

652.0401 Methods for determining crop evapotranspiration**(a) Direct measurement of crop evapotranspiration**

Direct measurement methods for ET_c include:

- aerodynamic method
- detailed soil moisture monitoring
- lysimetry
- plant porometers
- regional inflow-outflow measurements

All these methods require localized and detailed measurements of plant water use. Detailed soil moisture monitoring in controlled and self-contained devices (lysimeters) is probably the most commonly used. Little long-term historical data outside of a few ARS and university research stations are available. Use of lysimetry is discussed in more detail in Chapter 2, Irrigation Water Requirements, NEH, Part 623. The use of soil moisture monitoring devices to monitor crop ET is described in NEH, Part 623, Chapter 1, Plant-Soil-Water Relationships.

(b) Estimated crop evapotranspiration— ET_c

More than 20 methods have been developed to estimate the rate of crop ET based on local climate factors. The simplest methods are equations that generally use only mean air temperature. The more complex methods are described as energy equations. They require real time measurements of solar radiation, ambient air temperature, wind speed/movement, and relative humidity/vapor pressure. These equations have been adjusted for reference crop ET with lysimeter data. Selection of the method used for determining local crop ET depends on:

- Location, type, reliability, timeliness, and duration of climatic data;
- Natural pattern of evapotranspiration during the year; and
- Intended use intensity of crop evapotranspiration estimates.

Although any crop can be used as the reference crop, clipped grass is the reference crop of choice. Some earlier reference crop research, mainly in the West, used 2-year-old alfalfa (ET_p). With grass reference crop (ET_o) known, ET estimates for any crop at any stage of growth can be calculated by multiplying ET_o by the appropriate crop growth stage coefficient (k_c), usually displayed as a curve or table. The resulting value is called crop evapotranspiration (ET_c). The following methods and equations used to estimate reference crop evapotranspiration, ET_o , are described in detail in Part 623, Chapter 2, Irrigation Water Requirements (1990). The reference crop used is clipped grass. Crop coefficients are based on local or regional growth characteristics. The following methods are recommended by the Natural Resources Conservation Service (NRCS).

(1) Temperature method

- FAO Modified Blaney-Criddle (FAO Paper 24)
- Modified Blaney-Criddle (SCS Technical Release No. 21). This method is being maintained for historical and in some cases legal significance. See appendix A, NEH, Part 623, Chapter 2, Irrigation Water Requirements.

(2) Energy method

- Penman-Monteith method

(3) Radiation method

- FAO Radiation method (FAO Paper 24)

(4) Evaporation pan method

The FAO Modified Blaney-Criddle, Penman-Monteith, and FAO Radiation equations represent the most accurate equations for these specific methods. They are most accurately transferable over a wide range of climate conditions. These methods and equations are also widely accepted in the irrigation profession today (ASCE 1990).

The intended use, reliability, and availability of local climatic data may be the deciding factor as to which equation or method is used. For irrigation scheduling on a daily basis, an *energy* method, such as the Penman-Monteith equation, is probably the most accurate method available today, but complete and reliable local real time climatic data must be available. For irrigation scheduling information on a 10+ day average basis, use of a *radiation* method, such as FAO Radiation, or use of a local evaporation pan, may be quite satisfactory.

For estimation of monthly and seasonal crop water needs, a *temperature* based method generally proves to be quite satisfactory. The FAO Modified Blaney-Criddle equation uses long-term mean temperature data with input of estimates of relative humidity, wind movement, and sunlight duration. This method also includes an adjustment for elevation. The FAO Radiation method uses locally measured solar radiation and air temperature.

652.0402 Crop evapotranspiration

Monthly and seasonal crop ET data for (state) was developed using the _____ equation(s). Crop planting and harvest dates were determined by using local long-term mean temperature data and verified with university extension and local growers. The process provides:

- Estimated crop ET and net irrigation requirements by month and by season
- Amount of effective rainfall
- Estimated planting and harvest dates for all local crops

Note: The following crop ET and related tables and maps can be included to replace or simplify crop ET calculations. These maps and tables would be locally developed, as needed.

- Crop evapotranspiration tables, curves, and maps
- Climatic zone maps with peak month ET
- Precipitation maps
- Wind speed maps
- Relative humidity tables or maps
- Net solar radiation tables or maps

(a) Daily crop ET rate for system design

Estimates of daily or weekly crop ET rates are necessary to adequately size distribution systems. They are used to determine the minimum capacity requirements of canals, pipelines, water control structures, and irrigation application systems. Daily ET rates also influence the administration of wells, streams, and reservoirs from which irrigation water is diverted or pumped. To provide the required flows, daily (or several day averages) crop ET rate for the peak month must be used.

Estimated daily crop ET is not the average daily use for longer time periods. Daily crop ET is best estimated using real time day-specific information and the appropriate ET equation.

652.0403 Net irrigation water requirement

The net irrigation water requirement is defined as the water required by irrigation to satisfy crop evapotranspiration and auxiliary water needs that are not provided by water stored in the soil profile or precipitation. The net irrigation water requirement is defined as (all values are depths, in inches):

$$F_n = ET_c + A_w - P_e - GW - \Delta SW$$

where:

- F_n = net irrigation requirement for period considered
- ET_c = crop evapotranspiration for period considered
- A_w = auxiliary water—leaching, temperature modification, crop quality
- P_e = effective precipitation during period considered
- GW = ground water contribution
- ΔSW = change in soil-water content for period considered

Effective precipitation is defined as that portion of precipitation falling during the crop growing period that infiltrates the soil surface and is available for plant consumptive use. It does not include precipitation that is lost below the crop root zone (deep percolation), surface runoff, or soil surface evaporation.

Along with meeting the seasonal irrigation water requirement, irrigation systems must be able to supply enough water during shorter periods. The water supply rate generally is expressed in acre inches per hour or acre inches per day and can be easily converted to cubic feet per second or gallons per minute (1 ft³/s = 1 ac-in/hr = 450 gpm). The simplified equation can be used:

$$QT = DA$$

where:

- Q = flow rate, acre-inch per hour
- T = time, hours
- D = depth, inches (water applied or crop ET)
- A = area, acres

Table 4-1 Example tabular display—crop evapotranspiration using FAO Blaney-Criddle equationOwner John Irrigator Location Redmond Latitude 44°16' Elevation ^{1/} 2500 ftCrop Pasture Crop curve number used 17 Planting date Apr 17 Harvest date Oct 24

Item	April	May	June	July	Aug	Sep	Oct	Total
Mean temp (°F)	44.2	50.8	58.8	64.3	64.0	56.3	48.3	
Mean precip (in)	0.53	0.66	0.80	0.46	0.52	0.39	0.58	3.94
Effective precip—R _e (in)	0.37	0.44	0.59	0.34	0.38	0.24	0.35	2.71
Ratio sun/cloud	.70	.70	.90	.90	.90	.70	.70	
Rel hum (%)	20-50	20-50	20-50	20-50	20-50	20-50	20-50	
Ave wind (mph)	4-10	4-10	4-10	4-10	4-10	4-10	4-10	
Crop ET (in/mo)	0.76	3.55	6.41	7.47	6.43	3.27	1.23	29.12
Net irrig req—NIR (in/mo)	0.39	3.11	5.82	7.13	6.05	3.03	0.88	26.41

^{1/} Crop ET is corrected downwards 10% per 1,000 meters above sea level.

Figure 4-1 Example monthly crop evapotranspiration, arid climate in normal year

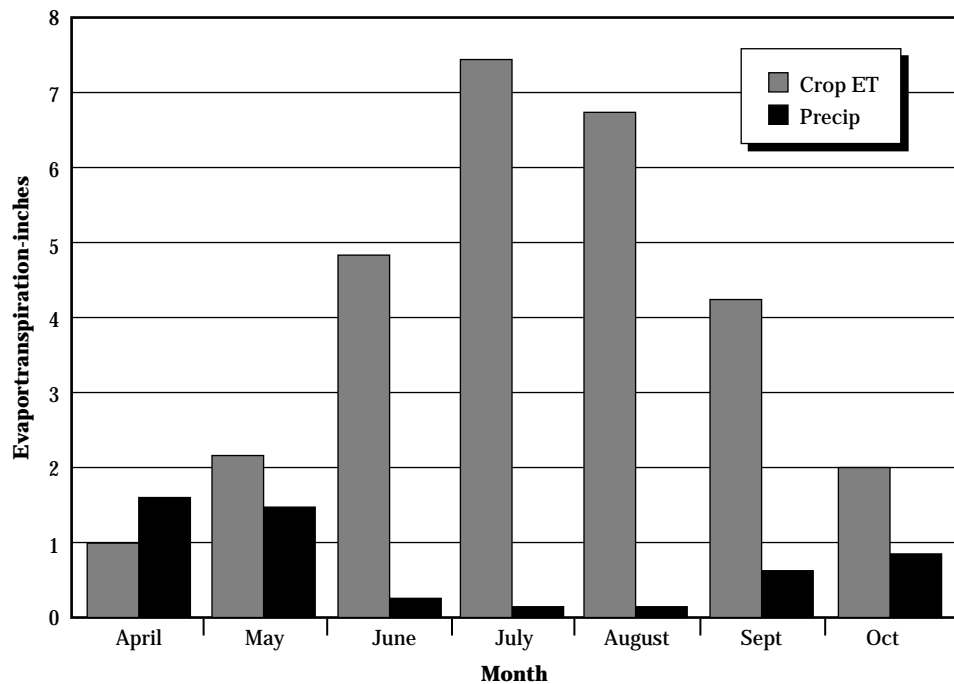
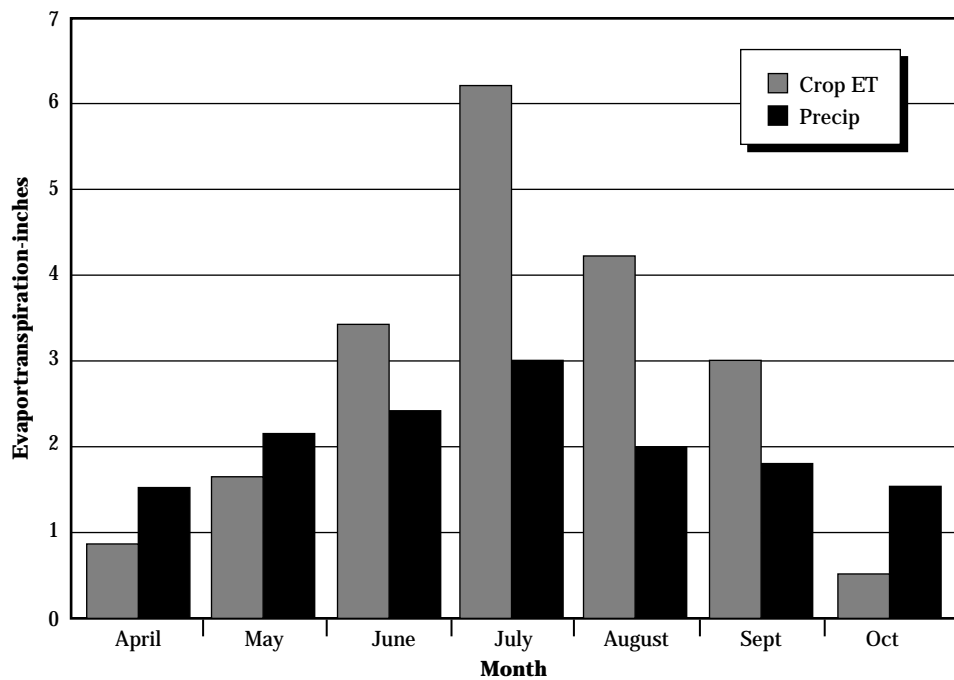

Figure 4-2 Example monthly crop evapotranspiration, subhumid climate in normal year



652.0404 Management allowable soil-water depletion

Management Allowable Depletion (MAD) is generally defined for each local crop. It is a grower's management decision based on yield and product quality objectives whether or not to fine tune generalized MAD values. MAD is the greatest amount of water to be removed by plants before irrigation so that undesirable crop water stress does not occur. Historically, an allowable depletion of between 30 and 60 percent of the soil Available Water Capacity (AWC) has been used for management purposes. See Chapter 3, Crops, for summary of recommended MAD levels for various crops. Estimated irrigation frequency, in days, is based on the MAD level for the AWC in the total crop root zone and the estimated crop ET.

Irrigation frequency, in days, can be determined by:

$$\frac{\text{MAD} \times \text{Total AWC for crop root zone in inches}}{\text{Daily ET}_c \text{ rate in inches/day}}$$

652.0405 Auxiliary water requirements (other needs)

In addition to crop evapotranspiration water requirements, irrigation systems can also meet special needs of crops and soils. These other uses need to be considered when determining the seasonal water requirements and minimum system capacities. Auxiliary uses include the following and are described in more detail in NEH, Part 623, Chapter 2, Irrigation Water Requirements:

- Leaching requirement for salinity and sodicity management
- Frost protection (fruits, citrus, berries, vegetables)
- Bud delay
- Crop and soil cooling
- Wind erosion and dust control
- Chemigation
- Plant disease control
- Seed germination

652.0406 Water table contribution

Upward flow of water from a water table can be used to meet part of or all the seasonal crop water requirement. Reasonable estimates need to be made of the water supplied by a water table. See figure 2-6 in chapter 2 of this guide. Methods to predict upward soil-water flow rates (upflux) from a water table are given in NEH Part 623, Chapter 2, Irrigation Water Requirements, and in the water table management software program DRAINMOD. Soil parameters required for these procedures are quite variable and may require field data to evaluate specific sites.

652.0407 Water requirements for soil-water budget/balance analysis

The components of a soil-water budget/balance analysis must include all water going *in* and all water going *out* of an area for the period of consideration. The basic purpose for such an analysis is to determine the location of all water applied. Generally a soil-water budget analysis is determined for a period involving a month, an irrigation season, a year, or maybe even for an average over several years. Availability of climatic data may also dictate the time period for the analysis. For example, if long-term mean temperature is the only reliable data available, determining monthly and seasonal water requirements may be the most accurate analysis that can be done. This would dictate a reasonably accurate analysis period of a month or longer.

If complete and reliable daily climatic data (temperature, solar radiation, wind movement, and relative humidity) are available nearby, then a daily soil-water accounting or balance can be developed because accurate daily water requirements can be estimated. The soil-water budget/balance analysis process is a tool that can be used for determining gross water applied and contributions of irrigation water and precipitation to downstream surface water and ground water. The soil-water budget/balance can be displayed in equation form as follows (sum may be positive if soil water is stored in the plant root zone):

$$F_g = ET_c + A_w + D_p + RO + SDL - P - GW - \Delta SW$$

where:

- F_g = Gross irrigation water applied during the period considered
- ET_c = Crop evapotranspiration during the period considered
- A_w = Water applied for auxiliary purposes during the period considered
- D_p = Deep percolation below the root zone from irrigation and precipitation
- RO = Surface runoff that leaves the site from irrigation and precipitation

- SDL = Spray, drift losses, and canopy intercept evaporation from sprinkler irrigation system during the period considered
- P = Total precipitation during the period considered
- GW = Ground water contribution to the crop root zone during the period
- Δ SW = Change in soil-water content within the crop root zone during the period

Note: Only those factors that apply to the site under consideration need to be used. Typically all factors would not be used for an analysis of one site.

Generally the soil-water budget analysis can be thought of as supporting a planning process where the soil-water balance analysis can be thought of as supporting an operational process. With appropriate soil-water content monitoring, accurate estimated daily crop ET and measurement of system inflow and surface outflow, a reliable daily soil-water balance can be developed. These daily values can be summarized for any desirable longer period that data are available.

The period of reliable climatic data is key to the soil-water budget/balance analysis. For development of a soil-water balance, only immediate past events are evaluated. It is not an irrigation scheduling tool. For example, a soil-water balance is an analysis process of what water went where for the last year, last month, last week, last event, or from some specific date up to the present time. Each rainfall and irrigation event versus daily crop ET and soil-water content change can be evaluated. It requires appropriate and current monitoring of soil-water content, irrigation water applied, onsite rainfall measurement, runoff, and full climatic data for daily crop ET determination.

For development of a soil-water budget, historic climate data along with estimated or measured soil-water content, irrigation flows, and losses would be used. The time period for an analysis for an average condition is whatever is necessary to provide reliable data. As an example, a site with fairly consistent climate from year to year, but with a rather short number of years record, might provide satisfactory results. Whereas a site with wide ranging climate from year to year might require a much longer period of record. An analysis showing the average for the last 5 years, or for a specific year of importance, could use climate data for that specific period only.

Table 4–2 displays a simple and basic soil-water budget using assumed and estimated values. The input data can be refined to whatever degree is necessary with field observations or measurements, or both. In this table, a water surplus of 1.7 inches for the season is indicated, and the water will go into deep percolation below the root zone.

A soil-water budget can be developed for planning purposes or as an evaluation tool. As the example shows, the consultant can use any level of accuracy desired or necessary.

(a) Example soil-water budget

A simplified soil-water budget would be displayed using the following assumptions:

- Crop is grain corn.
- Mature rooting depth = 48 inches.
- Total AWC = 8.0 inches.
- MAD = 50%.
- Soil profile is at field capacity at start of season.
- Sprinkler irrigation system with gross application for each irrigation = 6.0 inches.
- Application efficiency of 67% providing a net application = 4.0 inches.
- DU = 100% with no surface runoff.
- Precipitation infiltration for all season = 70% of total.
- No contribution from a shallow water table.

All crop ET, irrigation, and precipitation units are in inches.

Additional and more detailed examples of a soil-water budget and a soil-water balance are in Chapter 8, Project and Farm Irrigation Water Requirements.

Table 4-2 Example soil-water budget

Month	Crop ET	Soil water used	Precipitation total	Precipitation effect ^{1/}	Irrigations no.	net water applied	--- Water def. (-)	-- surplus (+)
May	2.3	2.3	3.0	2.1	0	0	0.2	
June	4.8	5.0	2.0	1.4	1	4.0		0.4
July	8.1	8.1	0	0	2	8.0	0.1	
Aug	6.6	6.7	0	0	2	8.0		1.3
Sept	2.0	2.0	1.5	1.0	0	0	1.0	
Total	23.8	24.1		4.5	5	20		1.7 ^{2/}

^{1/} Assuming all effective precipitation infiltrated into the soil.

^{2/} Typically lost to deep percolation. The total is in inches.

652.0408 State supplement

652.0408 State supplement

Water Requirements

The monthly and annual crop water use in Washington will be determined by using the Appendix A to the National Irrigation Guide. This attachment is the 1985 Washington Irrigation Guide, Appendix B, crop water use tables. This attachment is being used since it is accepted and reasonable for crop water use rates. New and more accurate crop water use amounts for Washington will be updated with a new software program (Irrigation Water Requirements - PM) within 2 years of this writing.

Using the appendix attached to obtain the monthly water use rates, the daily application rate can be obtained for any month. This daily use rate can be used to determine the peak daily water requirement for design flows. The daily use rate for any of the other months can also be calculated using the equation below with the attached monthly water use tables. It also helps to determine the frequency and number of irrigations per month during the irrigation season.

The daily use rate calculation is based on the monthly use rate and the net irrigation application. The equation below can be used in order to calculate this use rate.

$$U_p = 0.034 * (U_m)^{1.09} * (I)^{-0.09}$$

U_p – Daily peak consumptive use rate as in/day

U_m – Monthly peak consumptive use rate as in/month

I – Net irrigation application in inches

Table WA 4-1 is included at the end of this supplement showing the daily peak use rates

based on the monthly use rate and net inches of application.

For example in Prosser, WA, for grain corn the Appendix A, attachment shows the peak month is July at 9.99 inches of water use. Using a net irrigation application of 1", the daily peak is:

$$U_p = 0.034 * (9.99)^{1.09} * (1)^{-0.09}$$

$$U_p = 0.42 \text{ inches per day}$$

This is the peak daily use rate (0.42 in/day) since July is the peak month. Use this rate to design the system, where full irrigation is planned. Other months can be used with the equation above to calculate the seasonal water use rates and the frequency of irrigation for each month and the season.

Using the monthly use rates and dividing the number of days in the month gives an average use rate. This average could be the peak if the frequency of irrigation occurred once during the month. Where systems today are being designed to apply just what is used by the crop each day, the peak use rate method is more accurate to ensure the crop will have adequate water. Frequency and application rates are covered further in Section 652.0907 State Supplement, Chapter 9.

Irrigation Water Requirements (IWR)

An option for crops or locations that are not included in the Appendix A, attached is to use the Irrigation Water Requirement (IWR) program loaded on NRCS field office machines. This software uses one of several methods to calculate crop water use. It can use data from weather stations that have as little as temperature and precipitation data. If more data is available it will calculate more accurate water use information. With the IWR program, the crop water use amounts could be 10-20%

different than the Appendix A, attachment, so this method should only be used as a planning tool.

Weather stations from around the state are loaded into the IWR program in NRCS computers. Typical crop water used can then be calculated for any of the weather stations in the county selected. A help button is included within the program for further guidance.

The following bullets detail how to run the Irrigation Water Requirements (IWR) program to calculate the crop water requirements using NRCS computers. The program can also be loaded from the Water and Climate Center web site listed below and the program will operate the same on other computers as shown below.

To start the example:

- Go to the Start button, across the Engineering Applications menu to IWR and click on the Irrigation Water Requirements program. This will open the program. There is also a User Manual and some other files that contain current program update information in this directory for your viewing pleasure.
- Once in the IWR program, start by going to a New Job.
- Enter the job name, which will become the file name if you save it.
- Enter your location and your initials, and then click on the Get New Climate button.
- This will list all of the counties for Washington. Select your county - a list of climatic stations is provided, choose the one you would like data for.
- For the example, Benton County and Prosser 4NW was selected. When you have chosen the one you are working on - hit the OK button.
- Now you get to adjust the elevation and/or the precipitation ratios for your site. The elevation listed is for the weather station. The effective precipitation ratios are the 80% and 50% rainfall amounts for that location. You can adjust these if you have more current data on the effective precipitation and/or elevation for your location.
- Next select your crop from the Get Crop Name by hitting the Add New Crop button. The crops listed are the ones common to your area. There are other crops available and the IWR manual contains information on how select them or to change your humidity/wind conditions.
- After you select a crop, the program wants to know planting dates, harvest dates, and carry over water amounts. The planting and harvest dates can be entered if you know them or you can have them calculated from the weather data based on the planting and harvest temperatures shown. In the carryover used section the amount of water irrigated per application and the carryover moisture amounts in the soil profile before and after the season can be entered.
- With the crop and growth period established, the program does a preliminary run with your data. If this data is correct there are a number of different sheets available to show your data. For the example listed below Table WA4-1 is the crop water summary. There many types are graphs and charts also available depending on what you need. If you have edits or would like to change something go to OK and you are routed back to the IWR input window.
- The user guide can provide more details on the program.
- You can save your file and load it for later or add new crops to your current location

using the Save Job and Get Prev Job buttons.

Example

The following is an example of the IWR program.

- Location: Prosser
- Elevation 800 ft
- Crop: Corn, Grain
- Compute start and end date using a start temperature of 50° and the harvest temperature of 32°.
- The program calculated the following:
 - Plant Date 4/9
 - Harvest Date 10/8

Using the above information and the IWR program with the guidance at the beginning of the section, a summary similar to Figure WA4-1 can be produced. The peak daily evapotranspiration is shown by month for system design.

This program is available in the Common Computing Environment (CCE) and Windows 95 format. This is free and includes the operation manual. A copy of the IWR software it is available from the following location.

<http://www.wcc.nrcs.usda.gov/nrcsirrig/irrig-mgt-models.html>

Locations of other Crop Water Use reference material:

- FAO 56 – Crop evapotranspiration
- USDA - NRCS Part 623 EFH Chapter 2, Irrigation Water Requirements
- WSU Cooperative Extension – Public Area Weather data

Software for computation of Crop Water Use:

- FAO 56 Crop evapotranspiration – spreadsheet
- USDA – NRCS Part 623 EFH Chapter 2, IWR program
- WSU Cooperative Extension – Washington Irrigation Forecast software

Figure WA4-1 - IWR Example

Irrigation Water Requirements Crop Data Summary

Job: example	Crop: Corn, Grain
Location: Prosser	County: Benton, WA
By: Idn	Date: 11/09/04
Weather Station: PROSSER 4 NE	Sta No: WA6768
Latitude: 4615 Longitude: 11945	Elevation: 800 feet above sea level
Computation Method: Blaney Criddle (TR21)	Net irrigation application: 1 inches
Crop Curve: Blaney Criddle Annual Crop	Estimated carryover moisture used at season: Begin: 0.5 inches End: 0.5 inches
Begin Growth: 4/9 End Growth: 10/8	

Month	Total Monthly ET (3) inches	Dry Year 80% Chance (1)		Normal Year 50% Chance (1)		Average Daily ETc inches	Peak Daily ETPk inches
		Effective Precipitation inches	Net Irrigation Requirements inches (2)	Effective Precipitation inches	Net Irrigation Requirements inches (2)		
January	0.00	0.00	0.00	0.00	0.00	0.00	
February	0.00	0.00	0.00	0.00	0.00	0.00	
March	0.00	0.00	0.00	0.00	0.00	0.00	
April	0.81	0.13	0.18	0.19	0.13	0.04	
May	2.64	0.21	2.43	0.31	2.33	0.09	0.10
June	4.95	0.21	4.74	0.30	4.65	0.17	0.19
July	7.49	0.08	7.41	0.12	7.38	0.24	0.31
August	6.68	0.14	6.55	0.20	6.48	0.22	0.27
September	3.76	0.18	3.58	0.26	3.50	0.12	0.14
October	0.70	0.05	0.15	0.07	0.12	0.09	
November	0.00	0.00	0.00	0.00	0.00	0.00	
December	0.00	0.00	0.00	0.00	0.00	0.00	
TOTAL	27.04	1.00	25.04	1.45	24.59		

(1) For 80 percent occurrence, growing season effective precipitation will be equaled or exceeded 8 out of 10 years. For 50 percent chance occurrence, effective precipitation will be equaled or exceeded 1 out of 2 years.

(2) Net irrigation requirements is adjusted for carryover moisture used at the beginning of the season and carryover moisture used at the end of the growing season.

(3) ET (Evapotranspiration) is adjusted upwards 10% per 1000 meters above sea level.

Date: 11/9/2004

Table WA 4-1

Daily Consumptive Use Rate (Up) as Related to Estimated Actual Monthly Use (Um)

Monthly Peak CU Rate 'Um' (inches)	Net Irrigation Application - 'I' (inches)										
	1	1.5	2	2.5	3	3.5	4	4.5	5	5.5	6
	Daily Peak Consumptive Use Rate 'Up' (inches per day)										
3	0.11	0.11	0.11	0.10	0.10	0.10	0.10	0.10	0.10	0.10	0.10
3.5	0.13	0.13	0.13	0.12	0.12	0.12	0.12	0.12	0.12	0.11	0.11
4	0.15	0.15	0.14	0.14	0.14	0.14	0.14	0.13	0.13	0.13	0.13
4.5	0.18	0.17	0.16	0.16	0.16	0.16	0.15	0.15	0.15	0.15	0.15
5	0.20	0.19	0.18	0.18	0.18	0.18	0.17	0.17	0.17	0.17	0.17
5.5	0.22	0.21	0.20	0.20	0.20	0.19	0.19	0.19	0.19	0.19	0.19
6	0.24	0.23	0.23	0.22	0.22	0.21	0.21	0.21	0.21	0.21	0.20
6.5	0.26	0.25	0.25	0.24	0.24	0.23	0.23	0.23	0.23	0.22	0.22
7	0.28	0.27	0.27	0.26	0.26	0.25	0.25	0.25	0.25	0.24	0.24
7.5	0.31	0.29	0.29	0.28	0.28	0.27	0.27	0.27	0.26	0.26	0.26
8	0.33	0.32	0.31	0.30	0.30	0.29	0.29	0.29	0.28	0.28	0.28
8.5	0.35	0.34	0.33	0.32	0.32	0.31	0.31	0.31	0.30	0.30	0.30
9	0.37	0.36	0.35	0.34	0.34	0.33	0.33	0.33	0.32	0.32	0.32
9.5	0.40	0.38	0.37	0.36	0.36	0.35	0.35	0.35	0.34	0.34	0.34
10	0.42	0.40	0.39	0.39	0.38	0.37	0.37	0.37	0.36	0.36	0.36
10.5	0.44	0.43	0.41	0.41	0.40	0.39	0.39	0.39	0.38	0.38	0.38
11	0.46	0.45	0.44	0.43	0.42	0.41	0.41	0.41	0.40	0.40	0.39
11.5	0.49	0.47	0.46	0.45	0.44	0.44	0.43	0.43	0.42	0.42	0.41
12	0.51	0.49	0.48	0.47	0.46	0.46	0.45	0.45	0.44	0.44	0.43
12.5	0.53	0.51	0.50	0.49	0.48	0.48	0.47	0.47	0.46	0.46	0.45
13	0.56	0.54	0.52	0.51	0.50	0.50	0.49	0.49	0.48	0.48	0.47
13.5	0.58	0.56	0.55	0.53	0.53	0.52	0.51	0.51	0.50	0.50	0.49
14	0.60	0.58	0.57	0.56	0.55	0.54	0.53	0.53	0.52	0.52	0.51
14.5	0.63	0.60	0.59	0.58	0.57	0.56	0.55	0.55	0.54	0.54	0.53
15	0.65	0.63	0.61	0.60	0.59	0.58	0.57	0.57	0.56	0.56	0.55

Chapter 5

Selecting an Irrigation Method

Contents:	652.0500	General	5-1
	652.0501	Methods and systems to apply irrigation water	5-2
	652.0502	Site conditions	5-3
	652.0503	Selection of irrigation method and system	5-4
	652.0504	Adaptability and limitations of irrigation methods and systems	5-6
	652.0505	State supplement	5-13

Tables	Table 5-1	Site conditions to consider in selecting an irrigation method and system	5-3
	Table 5-2	Typical life and annual maintenance cost percentage for irrigation system components	5-5
	Table 5-3	Factors affecting the selection of surface irrigation systems	5-7
	Table 5-4	Factors affecting the selection of periodic move, fixed, or solid set sprinkler irrigation systems	5-8
	Table 5-5	Factors affecting the selection of continuous/self moving sprinkler irrigation systems	5-9
	Table 5-6	Factors affecting the selection of micro irrigation systems	5-10
	Table 5-7	Factors affecting the selection of subirrigation systems	5-11
	Table 5-8	Slope limitations for surface irrigation systems	5-12
	Table 5-9	Slope limitations for sprinkler irrigation systems	5-12

The irrigation system must be able to supply net water requirements plus expected losses of deep percolation, runoff, wind drift, and evaporation. It must account for the efficiency of the irrigation decisionmaker to schedule the right amount of water at the right time and the ability of an irrigation system to uniformly apply that water across a field. Net and gross water application and system capacity are related by an estimated or measured application efficiency:

$$F_g = \frac{F_n}{E_a} \quad C_g = \frac{C_n}{E_a}$$

where:

- F_g = gross application, inches
- F_n = net application, inches
- E_a = application efficiency, expressed as decimal
- C_g = gross system capacity, gallons per minute
- C_n = net system capacity, gallons per minute

The designer must also account for system down time, i.e., moving of sprinklers, break downs, and water used on another field or by another irrigator, such as in a rotation delivery schedule. For sprinkler systems, it is common to use 22 hours per day or 6 days per week for actual water application time.

The most conservative method of designing irrigation system capacity is to provide enough capacity to meet the maximum expected or peak evapotranspiration rate of the crop. This normally is the peak daily rate, but can be any selected period. In the most conservative case, rainfall and stored soil moisture are not considered. This design procedure relies on determining the distribution of crop ET during the year for the principle irrigated crops. The crop ET for the peak day, week, and month also varies from year to year. A frequency or risk analysis can be provided whereby system capacity and related cost reduction may be realized. Where effective rainfall and maximum available soil-water storage are used, further reduction of system capacity and water supply may be realized.

See NEH, Part 623, Chapter 2, Irrigation Water Requirements, for further information on determining net irrigation requirement.

Table 4–1 displays an example calculation and tabular method of presenting monthly crop ET, effective precipitation (R_e), and net irrigation requirement (NIR) for pasture grass using FAO Blaney-Criddle equation. When determining crop ET from TR-21 (Modified Blaney-Criddle), crop ET was calculated and displayed using **normal** and **dry** years. **Normal** year (50% chance occurrence) precipitation would be equaled or exceeded in 1 out of 2 years. **Dry** year (80% chance of occurrence) precipitation would be equaled or exceeded 8 out of 20 years.

This process carried through the many computer software programs that were developed and became available in many states. However, computer software programs that have been developed when using FAO Blaney-Criddle equation, do not contain the **normal** and **dry** years calculation process. The **normal** and **dry** year concept for determining crop ET can still be used; however, basic input data of precipitation must be adjusted. Long-term mean data are typically displayed in NOAA climate data publications, and a frequency analysis must be obtained or provided to determine **dry** year precipitation. This concept can also apply to determination of crop ET during **wet** years.

Figure 4–1 displays monthly crop ET and monthly effective precipitation for an arid climate condition where effective precipitation during growing season is minimal. Figure 4–2 shows monthly crop ET and effective precipitation for a subhumid climate condition where effective precipitation can meet crop ET during the early and latter part of the growing season.

Note: Where precipitation exceeds crop evapotranspiration, an opportunity exists for leaching of nutrients and pesticides. This may occur if soil moisture is at field capacity so that precipitation will provide the excess soil water available for leaching. These displays are then basic water budgets in graphic form.

652.0500 General

Irrigation application method and system selection should result in optimum use of available water. The selection should be based on a full awareness of management considerations, such as water source and cost, water quantity and quality, irrigation effects on the environment, energy availability and cost, farm equipment, product marketability, and capital for irrigation system installation, operation, and maintenance. The purpose of this chapter is to provide necessary planning considerations for selecting an irrigation method and system. Most widely used irrigation methods and systems with their adaptability and limitations are described. Also see National Engineering Handbook (NEH), part 623 (section 15), chapters 3, 4, 5, 6, 7, 8, 9, and 11.

In some areas, operators are accustomed to a particular irrigation method and system of applying water. They continue to install and use this common system even though another system may be more suitable, apply water more efficiently with better distribution uniformity, be more economical to install and operate, and have fewer negative impacts on ground and surface water.

The consultant and irrigation decisionmaker should compare applicable methods and systems on common grounds. These can include:

- Gross irrigation water needs
- Energy requirements
- Effects on quantity and quality of ground water and downstream surface water
- Installation and annual operating costs
- Labor skills needed

Generally more than one irrigation method and system can be installed and efficiently operated on a specific site. The owner's or operator's desire, rather than economics and water application uniformity, may be key to the selection. To get acceptable irrigation efficiencies (minimize losses), management skills required of the operator and flexibility of available labor must be considered. Local regulations may provide the motivation to select and manage a specific irrigation system that would provide the least negative effect on ground and surface water. Whatever basis is used for the decision, the consultant and owner or

operator both need to be aware of the applicability, capability, and limitations of all irrigation methods and systems that could be used on a specific site.

Political, legal, and regulatory issues are of primary importance. Included are such issues as land reform, water rights, containment of runoff and drainage water, taxation, financial incentives from governments, zoning and site application, and construction permits. These issues must be fully understood at the beginning of the selection process.

The Natural Resources Conservation Service (NRCS) Field Office Technical Guide, section V, displays the conservation effects of irrigation methods and systems and their related components. These should be referenced during the planning and design process. They will provide insight as to the effects of surface irrigation on ground and surface water quantity and quality, and on wildlife.

652.0501 Methods and systems to apply irrigation water

The four basic irrigation methods, along with the many systems to apply irrigation water, include: surface, sprinkle, micro, and subirrigation:

Surface—Water is applied by gravity across the soil surface by flooding or small channels (i.e., basins, borders, paddies, furrows, rills, corrugations)

Sprinkle—Water is applied at the point of use by a system of nozzles (impact and gear driven sprinkler or spray heads) with water delivered to the sprinkler heads by surface and buried pipelines, or by both. Sprinkler irrigation laterals are classed as fixed set, periodic move, or continuous or self move. Sprinkler irrigation systems include solid set, handmove laterals, sideroll (wheel) laterals, center pivot, linear move (lateral move), and stationary and traveling gun types. Low Energy Precision Application (LEPA) and Low Pressure In Canopy (LPIC) systems are included with sprinkler systems because they use center pivots and linear move irrigation systems.

Micro—Water is applied to the point of use through low pressure, low volume discharge devices (i.e., drip emitters, line source emitters, micro spray and sprinkler heads, bubblers) supplied by small diameter surface or buried pipelines.

Subirrigation—Water is made available to the crop root system by upward capillary flow through the soil profile from a controlled water table.

Each irrigation method and irrigation system has specific site applicability, capability, and limitations.

Broad factors that should be considered are:

- Crops to be grown
- Topography or physical site conditions
- Water supply
- Climate
- Energy available
- Chemigation
- Operation and management skills
- Environmental concerns
- Soils
- Farming equipment
- Costs

652.0502 Site conditions

Table 5-1 displays the site and other local conditions that must be considered in selecting an irrigation method and system. Other factors to consider include:

Farm, land, and field—Field size(s) and shape, obstructions, topography, flood hazard, water table, and access for operation and maintenance.

Energy and pumping plant—Type, availability, reliability, parts and service availability, and pumping efficiency.

Environmental effects—On quantity and quality of surface and ground water for water removal and for return flows, on local air quality, on local and regional wildlife and fish.

Local laws—Laws regarding tailwater runoff reuse, reuse pits, and quality of tailwater (runoff).

Type and amount of effluent—Animal, municipal, and industrial waste.

Water rights, allocations, and priority.

Availability of funds for improvements.

Sociological factors (i.e., grandpa and dad did it that way)—Available technical ability and language skills of laborers.

Time and skill level of management personnel.

Table 5-1 Site conditions to consider in selecting an irrigation method and system

Crop	Soil	Water	Climate
Crops grown & rotation	AWC	Quality	Wind
Water requirement	Infiltration rate	salts, toxic elements	Rainfall
Height	Depth	sediment	Frost conditions
Cultural practices	to water table	organic materials	Humidity
Pests	to impervious layer	fish, aquatic creatures	Temperature extremes
Tolerance to spray	Drainage	Quantity	Rainfall frequency
Toxicity limitations	surface	Reliability	Evaporation from:
Allowable MAD level	subsurface	Source	plant leaves and stems
Climate Control	Condition	stream	soil surface
frost protection	Uniformity	reservoir	Solar radiation
cooling	Stoniness	well	
Diseases & Control	Slope (s)	delivery point	
Crop quality	Surface texture	Delivery schedule	
Planned yield	Profile textures	frequency	
	Structure	duration	
	Fertility	rate	
	Temporal properties		

652.0503 Selection of irrigation method and system

With the current demand for other uses of high quality water, the irrigation decisionmaker must provide good irrigation water management; including maximizing beneficial water use, providing good distribution uniformity, minimizing water losses, and using an appropriate irrigation scheduling method. For example, it has been demonstrated that micro systems can be economically used on high value annual and perennial crops. However, high quality water from a suitably treated or filtered source is required to minimize emitter plugging, especially when using buried laterals having line-source emitters. Any properly designed, installed, and managed irrigation method and system, that is suitable to the site, has the potential to apply the proper amount of water uniformly across the field. However, one or more systems can be less costly and easier to manage.

Local regulatory standards and criteria for irrigation efficiency, maximum water duty, or maximum water losses may strongly recommend the selection of one or two specific irrigation systems so that water is applied without excessive negative impacts on local water quantity and quality. The fact that the best planned, designed, and installed system can still be grossly mismanaged must also be recognized. Availability of irrigation equipment replacement parts, repair service, skilled labor for system operation, and irrigation water availability and timing must be considered. Minimizing total annual operating energy requirements should be a basic part of the decisionmaking process.

Two irrigation methods (i.e., sprinkle and surface) and systems for the same field can be efficiently used with different crops and even a single crop for one season. For example, with an annual crop such as corn on high intake soils, early season shallow irrigations can be provided to the shallow rooted corn plants by handmove or sideroll (wheel) sprinkler laterals. After the corn gets too tall for the moving of laterals and the water infiltration rate is slowed by tillage equipment compaction, furrow irrigation can then be used for the remainder of the season. Compared to a full irrigation season using furrows, less water is applied and fewer

plant nutrients and pesticides are lost to deep percolation below the root zone. In cranberry bogs, sprinklers can be used for irrigation, frost control, and chemical application, or bogs can be flooded for irrigation and frost control. Lettuce, carrots, onions, and other such crops can be germinated with portable fixed set sprinkler laterals with furrows used to apply water the balance of the growing season.

Where ample water is available during the early part of the growing season, but becomes deficient during the peak water use period, a surface flood system (i.e. borders) can be used in the spring and a sprinkler system used during peak water use. Several benefits can be realized with both irrigation methods:

- Reduced energy use compared to pumping the full flow for the full season
- Maximized water use efficiency during the peak water use period

This scenario works well where surface water with gravity flow is available to the field and both a good surface flood system and sprinkler system are available or can be economically installed.

Sprinkler irrigation systems are adaptable for use on most crops and on nearly all irrigable soils. Particular care is needed in the design and operation of a sprinkler system with low application rates (0.15 to .25 in/hr) and on soils (generally fine textured) with low infiltration rates. Principal concerns with low application rates are time of set, increased system cost, acceptable distribution uniformity, wind drift, evaporation, and system operational requirements.

For example, with an application rate of 0.15 inch per hour, *time of set* would have to be nearly 30 hours to apply a net irrigation application of 3 inches. It is recommended that sprinkler systems apply water at a rate greater than 0.15 inch per hour for improved wind resistance. In areas of high temperature, wind, or both, minimum application rate and volume should be higher because of potential losses from evaporation and wind drift. For frost control, where evaporation and wind drift potential are low, an application rate of 0.10 to 0.15 inch per hour is common. See NEH, Part 623 (Section 15), Chapter 11, Sprinkle Irrigation.

Most irrigation application methods and systems can be automated to some degree. More easily automated are micro systems, center pivot sprinkler systems, solid set sprinkler systems, level furrow and basin systems, graded border systems, subsurface systems, and graded furrow systems using automated ditch turnouts, cutback, cablegation, and surge techniques.

Table 5-2 displays estimated typical life and annual maintenance for irrigation system components. Also, see chapter 11 of this guide for additional information on developing and comparing typical capital and operating costs for selected irrigation systems.

Table 5-2 Typical life and annual maintenance cost percentage for irrigation system components

System and components	Life (yr)	Annual maint. (% of cost)	System and components	Life (yr)	Annual maint. (% of cost)
Sprinkler systems	10 - 15	2 - 6	Surface & subsurface systems	15	5
Handmove	15 +	2	Related components		
Side or wheel roll	15 +	2	Pipelines		
End tow	10 +	3	buried thermoplastic	25 +	1
Side move w/drag lines	15 +	4	buried steel	25	1
Stationary gun type	15 +	2	surface aluminum	20 +	2
Center pivot—standard	15 +	5	surface thermoplastic	5 +	4
Linear move	15 +	6	buried nonreinforced concrete	25 +	1
Cable tow	10 +	6	buried galv. steel	25 +	1
Hose pull	15 +	6	buried corrugated metal	25 +	1
Traveling gun type	10 +	6	buried reinforced PMP	25 +	1
Fixed or solid set			gated pipe, rigid, surface	10 +	2
permanent	20 +	1	surge valves	10 +	6
portable	15 +	2			
Sprinkler gear driven, impact & spray heads	5 - 10	6	Pumps		
Valves	10 - 25	3	pump only	15 +	3
			w/electric motors	10 +	3
Micro systems ^{1/}	1 - 20	2 - 10	w/internal combustion engine	10 +	6
Drip	5 - 10	3			
Spray	5 - 10	3	Wells	25 +	1
Bubbler	15 +	2	Linings		
Semi-rigid, buried	10 - 20	2	nonreinforced concrete	15 +	5
Semi-rigid, surface	10	2	flexible membrane	10	5
Flexible, thin wall, buried	10	2	reinforced concrete	20 +	1
Flexible, thin wall, surface	1 - 5	10			
Emitters & heads	5 - 10	6	Land grading, leveling	<u>2/</u>	
Filters, injectors, valves	10 +	7	Reservoirs	<u>3/</u>	

1/ With no disturbance from tillage and harvest equipment.

2/ Indefinite with adequate maintenance.

3/ Indefinite with adequate maintenance of structures, watershed.

652.0504 Adaptability and limitations of irrigation methods and systems

Tables 5-3 through 5-7 display factors that affect the adaptation and operation of various irrigation methods and systems. In these tables, the + indicates positive effects or provides good reasons for preference of selection, the - indicates negative effects or provides possible reasons for not choosing this alternative (another method or system should be considered), and the 0 indicates neutral effect or should provide no influence on selection.

Tables 5-8 and 5-9 give recommended slope limitations for surface and sprinkler irrigation systems.

Table 5-3 Factors affecting the selection of surface irrigation systems

Item	----- Level 1/-----		----- Graded -----				----- Contour -----		
	border basin	furrow	border reg	furrow mod 2/	furrow	corrug	levee	furrow	ditch
Crop									
Field—close growing	0	0	0	-	-	0	0	-	0
Field—row	0	0	-	0	+	-	0	-	-
Vegetable—fresh	-	0	-	0	+	-	-	0	-
Vegetable—seed	-	0	-	0	+	-	-	0	-
Orchards, berries, grapes	0	0	0	0	0	-	-	0	-
Alfalfa hay	0	-	0	-	-	0	0	-	0
Corn	-	0	-	0	+	-	-	0	-
Cotton	-	0	-	0	+	-	-	0	-
Potatoes, sugar beets	-	0	-	0	+	-	-	0	-
Land & soil									
Low AWC	0	0	0	0	0	0	0	0	-
Low infiltration rate	+	+	0	0	0	0	+	0	0
Mod. infiltration rate	0	0	0	0	0	0	0	0	0
High infiltration rate	-	-	-	-	+	-	-	-	-
Variable infiltration rate	-	-	-	-	0	-	-	-	-
High salinity or sodicity	+	+	0	-	+	-	-	-	0
Highly erodible	-	-	-	-	-	-	-	-	-
Undulating topography	-	-	-	-	-	-	-	-	-
Steep topography	-	-	-	-	-	-	-	-	-
Odd shaped fields	+	+	-	-	-	-	0	0	0
Obstructions 3/	-	-	-	-	-	-	-	-	-
Stony, cobbly	-	-	-	-	-	-	-	-	-
Water supply									
Low cont. flow rate	-	-	-	0	0	0	-	0	0
High intermit. flow rate	+	+	+	-	-	-	-	-	0
High salinity	+	+	0	-	0	0	0	-	0
High sediment content	0	0	0	0	0	0	0	0	0
Delivery schedule									
continuous	-	-	0	0	0	0	0	0	0
rotation	0	0	0	0	0	0	0	0	0
arranged, flexible	0	0	0	0	0	0	0	0	0
demand	+	+	0	0	0	0	0	0	0
Climate									
Humid & subhumid	-	-	-	-	-	-	-	-	-
Arid & semiarid	0	0	0	0	0	0	0	0	0
Windy	0	0	0	0	0	0	0	0	0
High temp - humid	0	0	0	0	0	0	0	0	0
High temp - arid	0	0	0	0	0	0	0	0	0
Social/Institutional									
Easy to manage	0	+	-	-	-	-	-	-	-
Automation potential	+	+	0	-	+	-	0	0	-

1/ When used in humid and subhumid areas, protected outlets may be needed for surface runoff due to precipitation.

2/ Modified furrow irrigation includes cutback, surge, cablegation, and tailwater reuse.

3/ Obstructions may include roads, buildings, and rock piles.

Table 5-4 Factors affecting the selection of periodic move, fixed, or solid set sprinkler irrigation systems

Item	---- Periodic move ----			--- Solid set or fixed ---		
	sideroll	hand	gun	perm	port	gun
Crop						
Field—close growing	0	0	0	0	0	0
Field—row	0	0	0	-	0	-
Vegetable—fresh	0	0	0	0	0	0
Vegetable—seed	-	-	-	-	-	-
Orchards, berries, grapes	-	0	-	+	+	-
Alfalfa hay	0	0	0	-	-	-
Corn	-	-	0	-	-	0
Cotton	-	-	-	-	-	-
Potatoes, sugar beets	0	0	0	-	0	-
Land & soil						
Low AWC	0	0	0	+	+	+
Low infiltration rate	0	0	-	0	0	-
Mod. infiltration rate	0	0	0	0	0	0
High infiltration rate	0	0	0	+	+	+
Variable infiltration rate	+	+	+	+	+	+
High salinity or sodicity	-	-	-	-	-	-
Highly erodible	+	+	-	+	+	-
Steep & undulating topog	-	+	-	0	0	-
Odd shaped fields	-	0	+	+	+	+
Obstructions ^{1/}	-	0	0	-	0	0
Stony, cobbly	0	0	0	0	0	0
Water supply						
Low cont. flow	+	+	+	+	+	+
High intermit. flow	-	-	-	-	-	-
High salinity or sodicity	-	-	-	-	-	-
High sed. content	-	-	-	-	-	-
Delivery schedule						
continuous	+	+	+	+	+	+
rotation	-	-	-	-	-	-
arranged, flexible	0	0	0	0	0	0
demand	0	0	0	0	0	0
Climate						
High rainfall	+	+	+	+	+	+
Low rainfall—arid	0	0	0	0	0	0
Windy	-	-	-	-	-	-
High temp—humid	+	+	+	+	+	+
High temp—arid	-	-	-	-	-	-
Social/institutional						
Automation potential	-	-	-	+	+	0
Easy to manage	0	0	0	+	+	+

1/ Obstructions may include roads, buildings, rock piles, trees, above and below ground utilities, and oil pipelines.

Table 5-5 Factors affecting the selection of continuous/self moving ^{1/} sprinkler irrigation systems

Item	---- LEPA ^{2/} ----		---- LPIC ^{3/} ----		-- Center pivot --		---- Linear ----		gun
	center pivot	linear	center pivot	linear	high press	low press	high press	low press	
Crop									
Field—close growing	-	-	-	-	0	0	0	0	0
Field—row	0	0	0	0	0	0	0	0	0
Vegetable—fresh	0	0	0	0	0	0	0	0	0
Vegetable—seed	0	0	0	0	-	-	-	-	-
Orchard, berries, grapes	-	-	-	-	-	-	-	-	-
Alfalfa hay	-	-	-	-	0	+	0	+	0
Corn	0	0	0	0	0	0	0	0	0
Cotton	0	0	0	0	-	-	-	-	-
Potatoes, sugar beets	0	0	0	0	0	0	0	0	0
Land & soil									
Low AWC	+	+	+	+	+	+	+	+	0
Low infiltration rate	0	0	-	-	-	-	-	-	-
Mod. infiltration rate	0	0	0	0	-	-	0	0	0
High infiltration rate	+	+	+	+	+	+	+	+	+
Variable infiltration rate	+	+	+	+	+	+	+	+	+
High salinity and sodicity	0	0	0	0	0	0	0	0	0
Highly erodible	0	0	0	0	-	-	-	-	-
Steep & undulating topog	-	-	-	-	-	-	-	-	+
Odd shaped fields	-	-	-	-	-	-	-	-	+
Obstructions ^{4/}	-	-	-	-	-	-	-	-	+
Stony, cobbly	0	0	0	0	0	0	0	0	0
Water supply									
Low cont. flow rate	+	+	+	+	+	+	+	+	+
High intermit. flow rate	-	-	-	-	-	-	-	-	-
High salinity	-	-	-	-	-	-	-	-	-
High sed. content	-	-	-	-	-	-	-	-	-
Delivery schedule									
continuous	+	+	+	+	+	+	+	+	+
rotation	-	-	-	-	-	-	-	-	-
arranged, flexible	0	0	0	0	0	0	0	0	0
demand	0	0	0	0	0	0	0	0	0
Climate									
Humid & subhumid	+	+	+	+	+	+	+	+	+
Arid & semiarid	0	0	0	0	0	0	0	0	0
Windy	+	+	+	+	-	-	0	0	-
High temp—humid	+	+	+	+	+	+	+	+	+
High temp—arid	0	0	0	0	0	0	0	0	0
Social/institutional									
Automation potential	+	-	+	-	+	0	-	-	-
Easy to manage	0	0	0	0	0	0	0	0	0

1/ Continuous/self moving describes a sprinkler system that is self moving in continuous or start-stop operations.

2/ LEPA—Low Energy Precision Application system (in-canopy with good soil and water management).

3/ LPIC—Low Pressure In Canopy system.

4/ Obstructions may include roads, buildings, rock piles, trees, and aboveground utilities.

Table 5-6 Factors affecting the selection of micro irrigation systems ^{1/}

Item	Point source drip emitter	Line source cont. tube	Micro spray/ sprinkler	Basin bubbler
Crop				
Field—close growing	–	–	–	–
Field—row	–	0	–	–
Vegetable—fresh	–	+	–	–
Vegetable—seed	–	0	–	–
Orchards, berries, grapes	+	–	+	+
Alfalfa hay	–	–	–	–
Corn	–	0	–	–
Cotton	–	+	–	–
Potatoes, sugar beets	–	0	–	–
Land & soil				
Low AWC	+	+	+	+
Low infiltration rate	0	0	0	0
Mod. infiltration rate	0	0	0	0
High infiltration rate	+	+	+	0
Variable infiltration rate	+	+	+	+
High salinity and sodicity	0	+	+	0
Highly erodible	+	+	+	0
Steep & undulating topog	+	–	+	–
Odd shaped fields	+	+	+	+
Obstructions ^{2/}	+	+	+	+
Stony, cobbly	+	+	+	+
Water supply				
Low cont. flow rate	+	+	+	+
High intermit. flow rate	–	–	–	–
High salinity	–	–	–	–
High sed. content	–	–	–	–
Delivery schedule				
continuous	+	+	+	+
rotation	–	–	–	–
arranged, flexible	0	0	0	0
demand	0	0	0	0
Climate				
Humid & subhumid	0	0	0	0
Arid & semiarid	0	0	0	0
Windy	+	+	–	0
High temp—humid	0	0	0	0
High temp—arid	0	0	0	0
Social/institutional				
Easy to manage	–	–	–	–
Automation potential	+	+	+	+

1/ Not suitable unless water supply is non-saline, low SAR, and very high quality.

2/ Obstructions may include roads, buildings, rock piles, trees, and below-ground utilities.

Table 5-7 Factors affecting the selection of subirrigation systems ^{1/}

Item	Water table control	Item	Water table control
Crop		Water supply	
Field—close growing	0	Low cont. flow rate	+
Field—row	0	High intermit flow rate	-
Vegetable—fresh	0	High salinity	-
Vegetable—seed	0	High sed. content	-
Orchards, berries, grapes	0		
Alfalfa hay	-	Delivery schedule	
Corn	0	continuous	+
Cotton	-	rotation	-
Potatoes, sugar beets	0	arranged, flexible	-
		demand	0
Land & soil		Climate	
Low AWC	0	High rainfall	+
Low permeability	0	Low rainfall—arid	-
Mod. permeability	+	Windy	+
High permeability	0	High temp—humid	+
Variable infiltration rate	0	High temp—arid	+
High salinity and sodicity	-		
Highly erodible	0	Social & institutional	
Undulating topography	-	Easy to manage	0
Odd shaped fields	0	Automation potential	0
Obstructions ^{2/}	0		
Stony, cobbly	-		

1/ Not suitable unless water supply is nonsaline, low SAR, and very high quality.

2/ Obstructions may include roads, buildings, rock piles, trees, and belowground utilities.

Table 5-8 Slope limitations for surface irrigation systems (after grading)

Type	Maximum slope(%) (arid & semiarid areas)		Maximum slope(%) (humid areas)	
	non-sod	sod	non-sod	sod
Level				
basin/border	----- Flat -----			
furrow	----- Flat -----			
Graded				
border	2.0	4.0	0.5	2.0
furrow	3.0		0.5	
corrugation	4.0	8.0		
contour levee	0.1			
contour ditch	4.0	15.0		
contour furrow	Irrigated cross slope			

Table 5-9 Slope limitations for sprinkler irrigation systems

Type	Maximum slope (%) ^{1/}	Comments
Periodic move/set		
portable handmove	20 +/-	Laterals should be laid cross slope to minimize and control pressure variation. Consider using pressure or flow control regulators in the mainline, lateral, or individual sprinkler/spray heads, when pressure differential causes an increase of > 20 % of design operating pressure.
sideroll - wheel mounted	10	
gun type	20 +/-	
end tow	5 - 10	
Fixed (solid) set		
permanent laterals	no limit	
portable laterals	no limit	
gun type	no limit	
Continuous move		
center pivot	15	
linear move	15	
gun type	20 +/-	
LEPA		
center pivot	1.0	
linear	1.0	
LPIC		
center pivot	2.5	
linear	2.5	

^{1/} Regardless of type of sprinkler irrigation system used, runoff and resulting soil erosion becomes more hazardous on steeper slopes. Proper conservation measures should be used; i.e., conservation tillage, crop residue use, filter strips, pitting, damming-diking, terraces, or permanent vegetation.

652.0505 State supplement

652.0505 State supplement

Irrigation Methods

To determine suitable irrigation methods sound planning must consider:

- Cost and ease of installation
- Maintenance required
- Labor and skill required for operation
- Ease with which it can be fitted into the farm enterprise

The following is a listing of web sites with irrigation system descriptions, methods, limitations and research papers.

The NRCS Water and Climate Center;
www.wcc.nrcs.usda.gov



**SOIL and WATER MANAGEMENT
RESEARCH UNIT**

**Conservation & Production Research
Laboratory**

<http://www.cprl.ars.usda.gov/wmru.htm>

The Irrigation Training and Research Center (ITRC) was established in 1989 at Cal Poly Foundation, San Luis Obispo, as a center of excellence, building on a history of contributions to the irrigation industry.

<http://www.itrc.org>

The California Agricultural Technology Institute (CATI) is a non-profit educational institution dedicated to improving California agriculture. CATI is located at California State University, Fresno, in the center of the great San Joaquin Valley, in the heart of California agriculture.

<http://www.cati.csufresno.edu/>

The Irrigation Association (IA) has a number of training sessions on the different types of irrigation methods. As the irrigation industry's organization, IA represents professionals who channel their expertise toward the common goal of efficient irrigation. Conservation, the quality and quantity of water, is our mission. Since 1949, IA has led the advances in water-use efficiencies for irrigated agriculture, landscape, and golf course applications.

<http://www.irrigation.org/>

UDSA ARS Irrigation and Drainage main index location has a number of sites and articles on system selection. The web site is:

http://www.ars.usda.gov/id/res_main.htm

This site has a number of papers on irrigation. The listed paper - *Irrigation System Selection*, has descriptions for systems, capabilities, limitations, labor, energy, and economic factors



An educational and irrigation scheduling resource for water managers.

<http://www.waterright.org/site2/publications/880105.asp>

North Dakota State University, Extension Service has a number of papers available. One very helpful paper is *Selecting A Sprinkler Irrigation System*, and can be found at:

<http://www.ext.nodak.edu/extpubs/ageng/irrigate/ae91w.htm>

Chapter 6

Irrigation System Design

Contents:	652.0600	General irrigation objective	6-1
		(a) System capacity requirements	6-1
		(b) Limiting factors	6-1
		(c) System design	6-2
	652.0601	Surface irrigation	6-2
		(a) General	6-2
		(b) Level basins, borders	6-5
		(c) Contour levee (rice lands)	6-7
		(d) Level furrows	6-8
		(e) Graded borders	6-8
		(f) Graded furrow characteristics	6-10
		(g) Contour ditch	6-22
		(h) Furrow erosion control	6-25
	652.0602	Sprinkle irrigation systems	6-27
		(a) General	6-27
		(b) Periodic move sprinkler irrigation systems	6-28
		(c) Fixed-solid set sprinkler irrigation systems	6-42
		(d) Continuous (self) move sprinkler irrigation systems	6-43
		(e) Traveling gun sprinkler irrigation system	6-54
		(f) Traveling boom sprinkler irrigation systems	6-58
	652.0603	Micro irrigation systems	6-59
		(a) General	6-59
		(b) Types of micro irrigation systems	6-59
		(c) Advantages of micro irrigation systems	6-65
		(d) Limitations of micro irrigation systems	6-65
		(e) System components	6-66
		(f) Planning and design considerations	6-67
		(g) Design procedures	6-75
		(h) Windbreaks	6-79
		(i) Irrigating stream side (riparian) trees and shrubs	6-80
	652.0604	Subirrigation systems	6-81
		(a) General	6-81
		(b) Irrigation system components	6-82
		(c) Planning and design considerations	6-82
		(d) Design procedures	6-83

652.0605 State supplement 6-85

Tables		
Table 6-1	Gross irrigation application, in inches	6-4
Table 6-2	Recommended design efficiencies for contour ditch irrigation systems	6-23
Table 6-3	Contour ditch irrigation—length of run, maximum length of run, and average irrigation time	6-24
Table 6-4	Application efficiencies for various sprinkler systems	6-28
Table 6-5	Typical operating pressures and wetted diameter patterns	6-47
Table 6-6	Typical discharges and wetted diameters for gun type sprinklers with 24° angles of trajectory and tapered nozzles operating when there is no wind	6-55
Table 6-7	Friction loss in flexible irrigation hose used on traveling gun type sprinkle system	6-56
Table 6-8	Guidelines for sizing traveling gun type sprinkler hoses	6-56
Table 6-9	Maximum travel lane spacing for traveling gun type sprinkler as a function of wetted diameter and wind speed	6-57
Table 6-10	Gross depth of water applied for continuous moving large gun type sprinkler heads	6-57
Table 6-11	Physical, chemical and biological factors causing plugging of emitters	6-68
Table 6-12	Plugging potential from irrigation water used in micro irrigation systems	6-69
Table 6-13	Typical composition and classification of water used in micro irrigation systems	6-69
Table 6-14	Particle size equivalents	6-72
Table 6-15	Filters used for micro irrigation systems	6-72
Table 6-16	Diameter and area of soil wetted by a single emitter with no restrictive horizons	6-73

Table 6-17	Recommended maximum pressure variation for typical emitters	6-77
-------------------	---	------

Figures	Figure 6-1	Surface irrigation stage definitions	6-3
	Figure 6-2	Typical furrow and bed arrangement for row crops	6-12
	Figure 6-3	Surge irrigation versus conventional continuous flow furrow irrigation	6-16
	Figure 6-4	Butterfly type surge valves	6-17
	Figure 6-5	General arrangement of controls, pipe, and outlets	6-19
	Figure 6-6	Typical layout for a tailwater recovery and reuse facility	6-20
	Figure 6-7	Side roll or handmove sprinkler system layout	6-29
	Figure 6-8	Effective portion of applied water	6-32
	Figure 6-9	Solid set sprinkler system layout	6-43
	Figure 6-10	Typical soil intake and sprinkler application rate curves	6-46
	Figure 6-11	Application area along a quarter-mile-long pivot system lateral	6-47
	Figure 6-12	Typical field layout of linear systems	6-53
	Figure 6-13	Traveling gun type sprinkler system layout	6-54
	Figure 6-14	Typical orchard micro system layout	6-60
	Figure 6-15	Emitter devices	6-61
	Figure 6-16	Surface and subsurface line source emitter devices	6-62
	Figure 6-17	Basin bubbler system	6-63
	Figure 6-18	Various mini spray and sprinkler heads	6-64
	Figure 6-19	Micro system components	6-67
	Figure 6-20	Turbulent fountain screen	6-71

Figure 6-21	Alternative emitter layout	6-76
Figure 6-22	Typical small system hookup	6-78
Figure 6-23	Typical windbreak layout	6-79
Figure 6-24	Typical water table management system	6-82
Figure 6-25	Water table contribution to irrigation requirements as a function of water table depth and soil type	6-84

Example	Example 6-1 Typical field data for a side roll (wheel line) lateral system	6-35
----------------	---	------

Exhibit	Exhibit 6-1 Sprinkler irrigation system planning/design worksheet	6-37
----------------	--	------

652.0600 General irrigation objective

Irrigation systems should have the capability to apply the amount of water needed by the crop in addition to precipitation. Irrigation applications should occur in a uniform and timely manner while minimizing losses and damage to soil, water, air, plant, and animal resources. Some irrigation systems also include water supply and delivery. Any irrigation system design requires adjustment in the field. Designs must be tailored to the skills and willingness of the irrigation decisionmaker to properly manage the system and make the adjustments.

To properly design and manage irrigation water, flow rates must be known. Therefore, water measurement is essential for farm and field delivery. Measurement of irrigation water is described in chapter 8 of this guide.

(a) System capacity requirements

The irrigation system must be able to deliver and apply the amount of water needed to meet the crop-water requirement. Along with meeting the seasonal water requirements, systems must supply enough water to prevent daily crop-water stress by satisfying the difference between evapotranspiration demands and available soil moisture supplied by rainfall or previous irrigations.

The irrigation decisionmaker must decide what water supply rate(s) will be used for designing system capacity. In arid and semiarid areas with high value crops, at least 90 to 95 percent probability of peak daily plant evapotranspiration may be required. With medium value crops, 80 percent may be adequate; and with low value crops, 50 percent may be sufficient.

If the soil can only store and provide water for a few days, meeting peak daily evapotranspiration rates may be desirable. With medium textured soils in semi-humid and humid climatic areas, values less than peak daily rates may be sufficient, such as average daily rate for the peak month. Potential prolonged drought periods in any climatic area and high value crops may

justify the higher cost of providing system capacity to meet peak daily crop use rates. National Engineering Handbook (NEH), Part 623 (Section 15), Chapter 2, Irrigation Water Requirements, provides a good description and examples for determining farm and project water requirements.

A system capacity greater than crop water use may be needed for other uses, such as frost protection. For example, where a sprinkler irrigation system is used for frost protection of orchards, large blocks must be continuously sprinkled during critical cold temperatures. This may require lower application rates than irrigation application would require, but larger areas are probably sprinkled at one time, thus requiring larger pumping plants and larger diameter distribution lines.

Typically as water costs increase, farm managers invest in better irrigation systems and management. They use techniques that have the potential to minimize water use by more uniform water application across the field and better control of the amount needed and applied by each irrigation. Changing or improving irrigation methods and systems may reduce total operating costs. However, even the most suitable irrigation system for a specific site can be mismanaged.

(b) Limiting factors

Limiting factors to adequately operate an irrigation system on a specific site include soils, crop, water, climatic conditions, and labor. See tables 5-3 through 5-7 in Chapter 5, Selection of Irrigation Systems, for negative, neutral, or positive factors affecting selection consideration. Other limitations to consider are:

Surface systems—High sediment laden irrigation water generally reduces intake rates, which on coarse textured soils may increase advance rates thereby improving distribution uniformity for the field. On medium and fine textured soils, a reduced intake rate may be undesirable.

Graded furrow systems—On furrow slopes greater than 1 percent and on highly erodible soils, erosion rates can be severe unless protective measures are provided.

Level basin and graded border systems—Larger heads of water are required to meet minimum flow depth requirements in a level basin or border (typically 5 to 7 cubic feet per second) and maintain reasonable field sizes. High uniformity can be attained with level basins on medium and low intake rate soils.

Low pressure continuous/self move center pivot and linear systems—Requires intense water, soil, and plant management for low intake soils, and at least a moderate amount of management on low to medium intake soils.

Micro—Water quality must be high except for basin bubbler systems, which use plastic tubing of 3/8 inch diameter and larger. Chemicals must be used to prevent algae growth in most systems.

(c) System design

An irrigation guide is valuable by giving general guidance for planning, design, layout, and operation of an irrigation system. Only application methods for which rational design methods exist are described. Wild flooding, border ditches, and nongraded furrows are not included. Presently, the only practical way to improve on the efficiency of these systems is by trial and error with adjustments being made during an irrigation.

Rational methods of design have their own limits. The data that goes into any irrigation system design includes two principal factors—soil intake rate and net application per irrigation. In some areas timing and availability of water can be a consideration for surface systems; additional principal factors are flow rate and erosion resistance. These factors are highly variable and can change with soil condition, from one field to another, for each crop stage of growth, from crop to crop, and from the first part of the season to the last part. The physical layout of a system can be installed according to data from the guide. Operational adjustments then must be made for differing field and crop conditions.

Design standards for irrigation practices are contained in the NRCS National Handbook of Conservation Practices, and Section IV of the Field Office Technical Guide.

652.0601 Surface irrigation

(a) General

The surface irrigation method is the application of irrigation water to the soil surface by gravity. Application systems vary. It is necessary to understand that a volume balance of water in a surface irrigation system must exist at all times. All water introduced at the head end of the system must be accounted for in surface flow or storage, infiltration, runoff, and a very small amount lost to evaporation during the time of irrigation. The amount lost to evaporation is generally neglected. In the overland flow process, an energy balance also exists. Flow or volume measurements can account for inflow, surface storage, and runoff. Infiltration volume can be measured by changes in soil-water content in the root zone before and after irrigation, with the remainder going to deep percolation below the plant root zone.

(1) Description and stages of typical surface water movement

Inflow—Irrigation stream flowing into a furrow, corrugation, rill, border, basin, or field.

Advance stage—Process of the leading edge of water moving across the field either in channel or as overland flow.

Advance rate—Time or rate at which the advance front moves across the field.

Storage stage—That portion of time or volume occurring between end of advance (or shutoff) and start of recession time, generally measured between specific points (and time) during an irrigation.

Recession stage (rate)—That portion of the irrigation time between inflow shutoff and beginning of recession at the upper end of the field. Recession rate is the rate at which the recession front moves over the surface. To be practical, recession ends when less than 10 percent of the wetted soil surface is covered by water.

Infiltration—A process or rate of water entering into the soil at the air-soil interface.

Outflow (runoff)—Volume depth or streamflow rate flowing past the end of the field.

Figure 6-1 displays the definitions and characteristics of surface irrigation. Table 6-1 displays gross irrigation application for a variety of net application depths and efficiencies.

This part of chapter 6 reflects existing methodology and calculation procedures and examples in NEH, part 623 (section 15), chapters 4 and 5. Reference to current academia and research involving what is described as the zero-inertia model will also be made.

Design procedures and examples provided in section 652.0605 are developed from state approved computer programs using existing methodology from chapters 4 and 5, or from Agricultural Research Service's publication, *Surface Irrigation Model, SFRF*. SFRF methodology will be used as the basis for future surface irrigation designs in NRCS. Trial applications of SFRF in some locations have shown the model more nearly fits actual field conditions than those from existing methodology given in NEH part 623, chapters 4 and 5.

Figure 6-1 Surface irrigation stage definitions

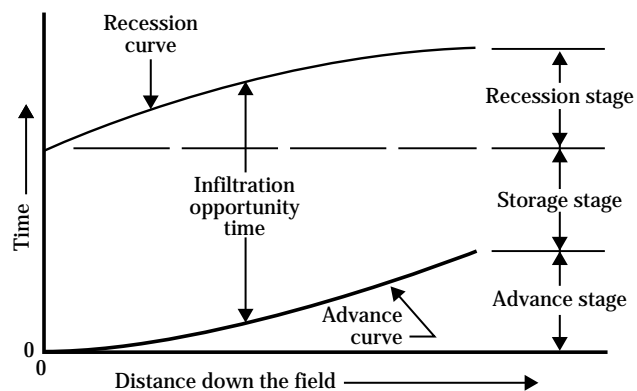

Table 6-1 Gross irrigation application, in inches ^{1/}

Net irrig depth (in)	Application efficiency (%)									
	80	75	70	65	50	55	50	45	40	35
0.40	0.50	0.53	0.57	0.62	0.67	0.73	0.80	0.89	1.00	1.17
0.60	0.75	0.80	0.85	0.92	1.00	1.09	1.20	1.33	1.50	1.71
0.80	1.00	1.07	1.14	1.23	1.33	1.45	1.60	1.78	2.00	2.29
1.00	1.25	1.33	1.43	1.54	1.67	1.82	2.00	2.22	2.50	2.86
1.20	1.50	1.60	1.71	1.85	2.00	1.18	2.40	2.67	3.00	3.43
1.40	1.75	1.87	2.00	2.15	2.33	2.55	2.80	3.11	3.50	4.00
1.60	2.00	2.13	2.29	2.46	2.67	2.91	3.20	3.56	4.00	4.57
1.80	2.25	2.40	2.57	2.77	3.00	3.27	3.60	4.00	4.50	5.14
2.00	2.50	2.67	2.86	3.08	3.33	3.64	4.00	4.44	5.00	5.71
2.20	2.75	2.93	3.14	3.38	3.67	4.00	4.40	4.89	5.50	6.29
2.40	3.00	3.20	3.43	3.69	4.00	4.36	4.80	5.33	6.00	6.86
2.60	3.25	3.47	3.71	4.00	4.33	4.73	5.20	5.78	6.50	7.43
2.80	3.50	3.73	4.00	4.31	4.67	5.09	5.60	6.22	7.00	8.00
3.00	3.75	4.00	4.29	4.62	5.00	5.45	6.00	6.67	7.50	8.57
3.20	4.00	4.27	4.57	4.92	5.33	5.82	6.40	7.11	8.00	9.14
3.40	4.25	4.53	4.86	5.23	5.67	6.18	6.80	7.56	8.50	9.71
3.60	4.50	4.30	5.14	5.54	6.00	6.55	7.20	8.00	9.00	10.29
3.80	4.75	5.07	5.43	5.85	6.33	6.91	7.60	8.44	9.50	20.86
4.00	5.00	5.33	5.71	6.15	6.67	7.27	8.00	8.89	10.00	11.43
4.20	5.25	5.60	6.00	6.46	7.00	7.64	8.40	9.33	10.50	12.00
4.40	5.50	5.87	6.29	6.77	7.33	8.00	8.80	9.78	11.00	12.57
4.60	5.75	6.13	6.57	7.08	7.67	8.36	9.20	10.22	11.50	13.14
4.80	6.00	6.40	6.86	7.38	8.00	8.78	9.60	10.67	12.00	13.71
5.00	6.25	6.67	7.14	7.69	8.33	9.09	10.00	11.11	12.50	14.29
5.20	6.50	6.93	7.43	8.00	8.67	9.45	10.40	11.56	13.00	14.36
5.40	6.75	7.20	7.71	8.31	9.00	9.82	10.80	12.00	14.00	16.00
5.60	7.00	7.47	8.00	8.62	9.33	10.18	11.20	12.44	14.00	16.00

1/ Includes deep percolation and tailwater runoff.

(b) Level basins, borders

This surface irrigation system uses relatively large flow rates supplied to level or nearly level soil surfaces over a short period of time. The basin (borders) may be any shape and is surrounded on all boundaries by a control barrier, such as a low dike or levee. The water is confined until infiltrated into the soil.

Level basins have been used for many years for irrigating orchards, citrus, grapes, alfalfa, small grains, and grass pasture. Similar to the level basin principal, contour levee irrigation has been used for centuries for growing rice.

Design of basin size depends on water supply flow rate, soil intake characteristics, and available soil water capacity. Basin irrigation can be adapted to most crops and certain marginal quality water not usable in other methods of irrigation. This system is best adapted for low to medium intake soils, where infiltration tends to be more uniform.

With proper design and management, level basin systems can result in high distribution uniformity and high overall application efficiency. Application efficiencies of individual irrigation events exceeding 90 percent can be obtained. Lack of uniformity in soil intake characteristics across the basin can reduce distribution uniformity of water infiltrated, as can using inadequate inflow rates.

(1) Advantages

- Level basin irrigation systems are the easiest to manage of any system. Application volume is controlled by inflow time of set, assuming inflow rate is known.
- Properly designed and managed level basin systems minimize deep percolation losses and high application efficiencies are attained. Distribution uniformity can be greatly improved over other irrigation systems. There is no runoff except for rice where flow through water is used to maintain the desired water surface elevation.
- Leaching saline, sodic, and other toxic ions is easier than with other methods. The reason for this is that water covers the entire soil surface uniformly and at a reasonably uniform depth. The water has the opportunity to infiltrate evenly, thereby reducing residual salts that often remain with graded border irrigation. Rainfall does not run off, so it can also be used for leaching. Leaching of toxic ions with level irrigation systems may not be as water efficient as leaching with sprinklers (unsaturated) because of some concentration of flow in macro pores.
- The guess work in applying the right amount of water is reduced since there is no surface runoff and nearly all water applied to a basin is infiltrated and used or lost to deep percolation within the basin.
- Relatively light applications of water are possible.
- Automation can be adapted as follows: The time of set, thus the amount of water applied, can be controlled directly with time clock operated gates in both head ditch and turnout(s) into a basin. However, with relatively large flows, powered gate control devices may require 110 volt power or a large battery(s). Drop open and drop close gates that are operated by gravity and water pressure against the head gate are available.
- Few turnout or outlet structures into a basin are needed.
- Except where rice fields are drained, no tailwater exists for further handling.
- Level basin areas as large as 10 to 40 acres can be irrigated when large streams are available and proper water control structures are used. Fields can be farmed using large equipment.
- Increased yields may result because more uniform amounts of water can be applied. Uniform distribution results in improved germination, improved plant environment, and more uniform growth. Leaching of plant nutrients is controlled. Knowledge of required application volume and timing is very important when using this irrigation system. Irrigation scheduling is discussed in Chapter 9, Irrigation Water Management.
- With operator-owned laser controlled equipment, annual maintenance or touch up can maintain fields in as designed condition. Laser controlled equipment can grade the surface to within about 0.025 to 0.05 foot of design elevation. Growers have discovered several advantages of annual laser controlled land leveling or planing, especially with grower owned equipment and with annual crops. Advantages of a near perfect system are realized every year instead of only the first year after leveling. Annual costs are about the same as re-leveling every 3 to 4 years.

(2) Limitations

- Precision leveling is required for uniform water distribution. If low or high areas exist, uneven infiltration occurs and distribution uniformity is reduced.
- Laser controlled leveling or surface planing equipment is almost essential to obtain uniform water distribution and high irrigation efficiencies.
- The correct amount of water must be applied. Over-application of water can lead to excessive plant inundation, high water temperatures that damage plants, leaching of nutrients, and the use of extra water. Too often when level basin irrigation systems are first installed, the irrigator tends to over irrigate, as 30 to 50 percent of water is no longer lost to runoff.
- To meet desirable basin size and shape objectives, earthwork volumes may be greater than for other surface irrigation methods.
- Variable soil intake characteristics within a single basin can create poor water distribution uniformity.
- Large basin inflow structures require erosion control measures. More than one inlet onto a field may be desirable.
- Typically, surface drainage must be provided to divert high rainfall events off the field.
- Relatively large streams of water are needed and should be used.
- If the surface drainage system does not release precipitation runoff in the natural drainage flow path, easements may be required.
- Some direct evaporation when irrigating low intake soils results because of excessive infiltration time (may be several hours). Also crop scalding can be a problem with some crops on low intake soils in very hot climates.

(3) Planning and design considerations

Factors to be considered in system design include:

- Intake characteristics of the soil can change throughout the season as farm equipment compacts the soil, from crop to crop, and from year to year.
- Large flow rates are desirable to maximize distribution uniformity of infiltrated water and basin size.
- Flow resistance of the crop affects the minimum flow needed to provide uniform flow depth and time of advance across the basin.

- Net application of water (depth in inches) can change as different crops are grown and as crop rooting depth increases during the season. Typically time is varied rather than flow rate.
- Available water capacity of soil in the actual plant root zone can vary because depth varies with root development.
- Topographic and soils characteristics of the site influence basin shape, earthwork required, and the size of basins and fitting basins within areas of uniform soils. Hydraulically, basins do not have to be rectangular. Often earthwork volumes can be reduced if nonrectangular shapes are used.

With this information, the length and width (or shape and size) of basins can be designed to obtain high distribution uniformity and acceptable application efficiencies. Basins that have the same size and shape are desirable, but not required.

In general, the entire basin should be covered by water in less than half of the total required irrigation opportunity time. For highest distribution uniformity, total coverage should take place within a fourth of the required irrigation opportunity time. This minimizes the effect of variability of soil intake rates and irregularities in the field surface.

To maximize distribution uniformity on basins, the inflow rate must be known, the design inflow time must be monitored, and water must be applied according to crop needs and soil conditions. Measuring delivery inflow is essential to knowing the inflow rate (Q). If a large delivery inflow is split into two or more flows for irrigation heads, additional measurement may be needed.

Carefully monitoring of design inflow time (T) is essential, especially when using large flows and short irrigation sets. For example, with inflow $Q = 15 \text{ ft}^3/\text{s}$, and design opportunity time $T = 35$ minutes, an extra turn-on time of 10 minutes can increase the applied depth of water 29 percent. An extra turn-on time of only 5 minutes means an increase of 14 percent. Careless timing can change a season long irrigation efficiency from good to mediocre or poor quickly. The irrigator must change heads of water when needed rather than convenient. This is a big step in proper water management.

Applying water according to crop needs and in the amount the soil will hold maximizes irrigation water use.

(4) Design procedures

Basic design principles and procedures are described in NEH, Part 623 (Section 15), Chapter 4, Border Irrigation. Design procedures and examples provided in section 652.0605 are developed from state approved computer programs using existing methodology from chapters 4 and 5 of this guide or from ARS publication, *Surface Irrigation Model, SRFR*.

(c) Contour levee (rice lands)

Contour levee irrigation is similar to level basin irrigation except when growing rice. Water is retained by small dikes or levees that are constructed generally on the contour. Additional leveling may be required to square up fields or to widen the contour dike interval.

Where rice is grown, water is applied to the level or nearly level area (basins) between levees at a rate (in excess of the intake rate of the soil) to maintain ponding. Flow-through water is used to maintain a preselected water surface elevation; thus some tailwater may be occasionally discharged from the lowest basin. This water can contain undesirable chemicals.

Automated static non flow-through systems are being developed in some areas to reduce water use and downstream surface water pollution. These systems must consider water surface distortion by wind in addition to water surface evaporation and plant transpiration. Water surface sensors are used to monitor water depth in each basin. Two to four water surface sensing stations in each basin are recommended. When the water surface lowers to a predetermined level, signals are transmitted to a controller at an inlet structure to allow additional water to enter the basin.

(1) Advantages

- High irrigation efficiencies are obtainable on soils that have a very low intake rate.
- Maximum utilization of rainfall can be realized by maintaining water surface elevations slightly lower than flashboard crest elevations of water control structures.

- Uniform distribution of water and high application efficiency can be realized if flow-through water is minimized or reused.
- Runoff from rainfall can be handled with little additional structure requirement.
- Installation cost can be relatively low because land preparation is less where dikes and levees are installed on the contour. Size of areas between levees doesn't need to be uniform.
- Simple water level control devices can be used. Automation at inflow structures to maintain a constant water level in the area between levees can reduce labor requirements and tailwater losses.

(2) Limitations

- Works best on soils that have a very low intake rate.
- Soils having restriction to vertical water movement, typically 18 to 30 inches below the soil surface, minimize water lost to deep percolation.
- Land grading is generally required to maximize area sizes between levees and provide a uniform depth of water. Land leveling can be substantial if it is desirable to make all basins the same size.
- Relatively large irrigation inflows are required to fill the basins. Flows larger than 5 ft³/s with single inlet structures require erosion protection.
- Use is limited to soils with land slopes less than 0.5 percent.
- Residual pesticides can be carried downstream into public water through tailwater discharge.
- Surface drainage is required in high rainfall areas.

(3) Planning & design considerations

Design considerations are based on three critical periods of rice irrigation operation. They are flushing, flood establishment, and flood maintenance.

Flushing—A water supply should be available to flush the field between planting and flood establishment. To prevent seed development problems and plant stress, water should not remain on the soil surface for more than 3 days.

Flood establishment—Flood establishment is the application of water to inundate the soil surface to a planned depth. A maximum flood-up period of less than 6 days ensures uniform crop growth and maturity. Pump or diversion flow rates should be sufficient

to provide a minimum of 1 inch of water depth above the highest point in the field, plus that needed for evapotranspiration during the flood-up period.

Flood maintenance—Flood maintenance is the application of water to maintain a planned water elevation in the area between levees. To maintain inundation, water must be added to replace crop evapotranspiration, lateral seepage losses of outside levees, deep percolation, flow-through water, and less effective rainfall for the period. Average daily evapotranspiration should be used for planning and design so that the flood is maintained during the most critical periods. Flow-through water should be minimized.

(4) Design procedures

Basic design principles and procedures are described in NEH, Section 15, Chapter 6, Contour Levee Irrigation, and in the Texas Rice Irrigation Guide.

(d) Level furrows

Level furrow irrigation is similar to both level basin and graded furrow irrigation. Laser controlled land leveling is required for highest irrigation uniformity. Irrigation water must be applied rapidly, using as large a stream as the furrow can contain, until the design volume or depth of irrigation is applied. Dikes along edges of each irrigation set can be used to contain water. The end of the furrow or field is blocked so the water is contained and ponded within each furrow. The same site conditions for level basins apply for level furrows. Level furrow irrigation is best suited to soils that have a moderate to low intake rate and moderate to high available water capacity.

(1) Advantages

- High application uniformity can be attained with a properly designed and managed system.
- Net irrigation application can be easily adjusted. Light applications can be applied where water can be introduced at both ends of the furrow or where outflow into a lower basin is allowed.
- There is no runoff from irrigation.
- This system is well suited to automation (see discussion of level basin and borders).
- Level basin (furrow) irrigation systems are the easiest to manage of all irrigation systems. Application volume is controlled by time, assuming the inflow rate is known.

(2) Limitations

- Except on uniform flat fields, extensive land preparation is required for initial installation.
- Typically, surface drainage must be provided to divert high rainfall events off the field.
- Set times are generally short requiring frequent changes.
- Relatively large streams of water are needed and should be used.
- Uniformity of the soil surface must be maintained. This essentially requires the use of laser controlled grading and planing equipment. (This is true with all surface irrigation systems.)
- Where land leveling activities (or natural conditions) expose soils with variable infiltration characteristics, infiltration uniformity can be poor.

(3) Planning and design considerations

Furrows should have adequate capacity for at least half the volume of the net irrigation application. Where it is undesirable to inundate a portion of the crop, or where the soil has low intake, the furrow cross section should be large enough to contain all the volume or depth of water applied per irrigation set.

(4) Design procedures

Basic design principles and procedures are described in NEH Part 623 (Section 15), Chapter 5, Furrow Irrigation, second edition. This chapter contains tables for a limited selection of field conditions. Computer programs are available that the planning technician can use to facilitate design. Design procedures and examples provided in section 652.0605 are developed from state approved computer programs using existing methodology from chapters 4 and 5 of this guide or from ARS publication, *Surface Irrigation Model, SRFR*.

(e) Graded borders

Graded border irrigation is a surface irrigation system where controlled surface flooding is used. The field to be irrigated is divided into strips of uniform width and grade by parallel dikes or border ridges. Each strip is irrigated separately. Water is introduced at one end and progressively covers the entire strip.

Irrigation of graded borders is a balanced advance and recession kind of water application. The borders (border strips) slope in the direction of irrigation, and the ends are usually open. Each strip is irrigated by diverting a stream of water onto the border at the upper end. The stream size must be such that the desired volume of water is applied to the strip in a time equal to, or slightly less than that needed for the soil to absorb the net irrigation amount required. When the desired volume of water has been delivered onto the strip, the stream is turned off. Water temporarily stored on the ground surface moves down the strip to complete the irrigation.

Uniform and efficient application of water depends on the use of an irrigation stream of proper size. Too large a stream results in inadequate irrigation at the upper end of the strip and often excessive surface runoff at the lower end. If the stream is too small, the lower end of the strip is inadequately irrigated and the upper end has excessive, deep percolation. Chapter 9, Irrigation Water Management, discusses procedures to evaluate an irrigation event and develop necessary adjustments in flow and time of set.

(1) Advantages

- Water with relatively high suspended sediment loads can be used.
- Graded borders can be used in rotation with other methods and systems of applying water including sprinkler and furrow irrigation systems.
- With proper system design and maintenance, this method requires relatively little labor. Labor can be further reduced by system automation.
- With properly designed and maintained systems and proper management, relatively high application efficiencies can be obtained on medium intake rate soils.
- Distance between border dikes can be set to fit existing cultivation and harvesting equipment. Properly designed and constructed dikes can be crossed by equipment.

(2) Limitations

- Must have sufficient depth of soil after land leveling for growing crops.
- To attain the best distribution uniformity, frequent observation (or automation) is required to shut off water at required times. Advancing temporary surface storage completes irrigation of the lower part of the border.

- Relative uniform topography is required to allow needed land leveling.
- Each border strip should have little or no cross slope.
- Slope should be uniform in the direction of irrigation with no reverse slope.
- A moderate level of irrigator skill and management is required.
- Uniform light applications of water are difficult to apply.

(3) Planning and design consideration

The following factors must be considered in the design of a graded border system. When this information is known, the border width, initial flow rates, and inflow times can be determined. Factors for consideration are:

- Intake characteristics of the soil
- Available flow rate
- Flow resistance of the crop to be grown
- Quantity (depth) of the water to be applied
- Water quality
- Slope
- Erodibility of the soil
- Available water capacity of soil in actual plant root zone (depth varies with root development)

As a general rule for a properly designed and managed graded border system, water should be shut off when the wetting front has reached two-thirds to three-fourths of the border strip length. Detailed designs are based on estimates of intake rates, net water application, crop flow restriction (roughness coefficient), erodibility of the soil, and net water application. All these factors are variables even on the same soil type and the same field. For this reason designs must allow for adjustments of flow rates, application times during system operation, or both. Some growers choose to deficit irrigate lower portions of the field to conserve water, reduce set time, and limit runoff.

Slope in the direction of irrigation should not exceed the following:

Arid & semiarid		---- Humid ----	
non-sod	sod	non-sod	sod
2 %	4 %	0.5 %	2 %

(4) Design procedures

Basic design principles and procedures are described in NEH, Part 623 (Section 15) Chapter 4, Border Irrigation. Design procedures and examples provided in section 652.0605 are developed from state approved computer programs using existing methodology from chapters 4 and 5 of this guide or from the ARS publication *Surface Irrigation Model, SRFIR*.

(5) Modifications to graded border systems

Border surge (characteristics and design considerations)—The general principles of surge irrigation work with graded borders the same as they do with graded furrows. The surge irrigation technique works best where the soil infiltration rate needs to be reduced (i.e., medium to coarse textured soils). Surge irrigation can be used to reduce both the net and total depth of irrigation water applied. (See discussion of furrow surge irrigation procedures later in this chapter.) The main difference is that an automated system capable of surging larger volumes of water to a single border is required. This generally requires large gated pipe or multiple risers. Developing equipment to automate ditch turnouts has been attempted, but such equipment is not commercially available at the time of this writing. Border surge can also be accomplished by using a surge valve to split the water between two adjacent borders via open ended pipelines and short ditches.

Border cablegation (characteristics and design consideration)—Cablegation is an excellent way to automate graded border systems providing the slope (fall) along the head ditch or supply pipeline is adequate. Approximately 0.2 foot per 1,000-foot grade is required on the supply pipeline at head ditch location. See discussion of furrow cablegation irrigation procedures later in this chapter. Large diameter gated pipe is generally required to handle the larger inflows needed for borders than that needed by furrows. This is a good way to provide accurate inflow times for short borders that would otherwise take frequent visits by the irrigator. One advantage with cablegation is that inflow times are easily changed by a simple adjustment of the cable speed controller. Water application design procedure is the same as for a manually operated system.

(f) Graded furrow characteristics

Graded furrow irrigation is a surface irrigation system that applies water to the soil by allowing water to flow downslope, in evenly spaced channels called furrows, rills, or corrugations. These small channels convey water down the field to the plants either growing in the furrows or on beds between the furrows. Graded furrow systems differ from border irrigation in that only part of the ground surface is covered with water. Water enters the soil by both vertically downward and lateral infiltration. The furrow stream is applied until the desired application depth is obtained. The time that water must be supplied to furrows is dependent upon the volume of water required to refill the soil profile to the desired irrigation depth. The intake rate of the soil, spacing of furrows, and length of the field all affect the amount of water to be applied. Surface grading (land leveling) to provide uniform slopes is essential to permit uniform water application and efficient irrigation.

Furrow irrigation also includes applying water with corrugations. Corrugations are typically used to irrigate noncultivated close-growing field crops using small closely-spaced channels directed down the primary slope of the field. Corrugations are also used to help guide irrigation streams in border strips. In this case the design is based on the border design procedures instead of the furrow method. Corrugations are frequently formed after the crop has been seeded, such as with small grains. In case of a perennial crop, such as alfalfa, they are reshaped as needed to maintain the desired channel cross section. Water application principles are the same as for furrow, with spacing, size, shape, and retardance characteristics being the primary differences. Corrugation stream sizes are small in comparison to furrow streams, and lengths of run are relatively short because of the smaller flows generally used and the resistance to flow caused by the growing crops.

Current ARS research and academia support the zero-inertia theory of surface irrigation, especially with furrow irrigation in lieu of the process in NEH, Part 623 (Section 15) Chapter 5, Furrow Irrigation.

(1) Advantages

- The number of furrows irrigated at one time can be adjusted to match available water delivery. Adequate inflow to each furrow should always be used.
- Uniform application can be obtained if adequate management practices are followed and the land has been properly prepared.
- Initial capital investment is relatively low on lands not requiring extensive land leveling. The furrows and corrugations are constructed by readily available and commonly used farm implements.
- Water with relatively high suspended sediment loads can be used.

(2) Limitations

- Water erosion hazards may be high, depending on field slope and soil texture. Erosion is of increasing concern as farm managers become more aware and as controls are placed on the amount of sediment that may leave the field and enter public water bodies.
- Tailwater (runoff) is nearly always required by graded furrow irrigation to provide uniform or adequate irrigation in the lower part of the field.
- To get adequate water infiltrated in the lower end of the field, the upper end is almost always overwatered resulting in deep percolation losses. Graded furrow system modifications, such as tailwater reuse, surge, and cablegation, can minimize deep percolation losses.
- Salts from either the soil or water supply can concentrate on ridges and beds. This can be a problem during seed germination and early stages of plant development even with salt-tolerant crops. Planting on ridge slopes and good water management help minimize this limitation.
- With some low and high intake soils and wide planting beds, lateral spread of water may not be adequate to provide complete irrigation across the bed in a reasonable irrigation time.
- With high intake soils the difference in intake opportunity time along the furrow, because of the time required for the stream to advance, can make it difficult to obtain high distribution uniformity. Furrow irrigation system modifications, such as tailwater reuse, surge, and cut back, can minimize nonuniformity.
- Furrows and corrugations create a rough field

surface, which is inconvenient to cross with farm equipment.

- Labor requirements are high because irrigation streams must be carefully regulated to achieve uniform advance and infiltration. Intake rate varies with each furrow because of tillage equipment compaction (soft versus hard furrow, or wheel versus nonwheel furrow) and can require adjustment of inflows in all furrows during the set. Adjustments of water inflow may be necessary several times during the set to maintain uniform advance rates in all furrows.
- Adequate leaching of salts is more difficult than with borders or sprinkler systems.
- Land leveling and preplant land grading or planing is normally required to provide uniform furrow grades.

(3) Planning and design considerations

Factors that must be considered in graded furrow design include:

- Intake characteristics of the soil (or advance rate of known inflows).
- Erodibility of the soil.
- Available water supply.
- Depth of water to be applied each irrigation.
- Furrow spacing (distance between furrows in which water will be introduced). This is quite important when the irrigator is using inflows to alternate furrows.
- Field slope in direction of irrigation and cross slope.
- Length of furrows.
- Flow resistance of crop to be grown.
- Available water capacity of soil in plant root zone (depth of root zone varies with root development).

With this information the flow rate per furrow and inflow time can be designed for desirable uniformity. Amounts of deep percolation below the crop root zone and runoff can be estimated.

Optimum distribution uniformity for a given system occurs when uniform grade is in the direction of irrigation. Typically a constant flow rate is turned into the furrow for the entire irrigation set. Flow rates and set times are designed to provide a desirable net application depth for a planned length of furrow. Runoff is essential beyond that part of the field receiving adequate irrigation. Runoff from the field can be

reduced where deficit irrigation is planned and can be tolerated by the crop in the lower part of the field. Seasonal changing of soil intake characteristics requires adjustments in inflow rates and time of set.

Normally, one furrow is between each crop row except for some bedded crops where two or more crop rows are planted on each bed. In these cases the furrows are along each pair of crop rows. See figure 6-2. The size (width and depth) of furrows and the spacing between rows depend on: the soil type, the crop, local cultural practices; and, on cultivation and harvesting equipment. Spacing of gates on gated pipe and setting of siphon tubes should match furrow spacing on field crops.

(4) Design procedures

Basic design principles and procedures are contained in NEH Part 623 (Section 15), Chapter 5, Furrow Irrigation and in ARS publication, *SRFR, A computer program for simulating flow in surface irrigation, Furrows-Basins-Borders* (WCL Report #17 1990). Planning technicians can use design charts where they have been prepared, do the calculations by using a small calculator, or by use of a computer. Many programs have been developed for computer use. One is the ARS model, SRFR. See section 652.0605 for design procedures and examples.

Figure 6-2 Typical furrow and bed arrangement for row crops

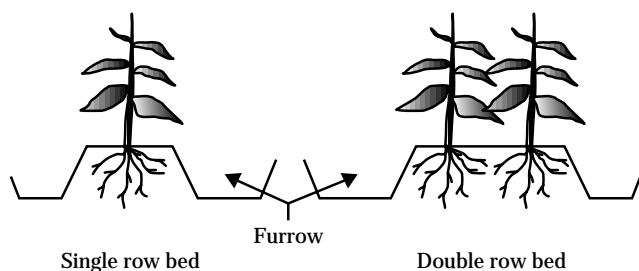

(5) Modifications to graded furrow irrigation systems

Several modifications to graded furrow irrigation systems can improve uniformity of applied and infiltrated water and increase application efficiency. Some are quite easy and cost effective to automate. These modifications will be described individually as design procedures and field application techniques apply to each. The modifications include:

(i) Graded furrow with cutback of inflow—In this type of furrow system, a large flow of water is initially turned into the furrow. When the water has nearly reached the end of the furrow, the inflow rate is reduced, or cutback. This procedure can increase uniformity of infiltrated water throughout the furrow length and reduce runoff. This modification has not had widespread use because of the additional labor required to manually reduce the flow rate and then reset the extra water that becomes available from the cutback. Cutback and resetting new water requires continual diligence by the irrigator to keep up with the new turn-on and turn-off times. The cablegation technique was developed as an attempt to automate cutback systems.

Most surge irrigation equipment has options available for multiple half cycle times, for use when the water advance reaches the end of the field. This "soak cycle" approximates a cutback system.

The following guidelines provide a practical procedure:

- Cutback initial flow when water reaches about three-fourths of the distance down the furrow.
- The inflow rate is typically reduced to half the initial rate.
- The reduced inflow rate should be applied until the desired application amount is reached.

Design procedures—Basic design principles and procedures are discussed in NEH, Part 623 (Section 15), Chapter 5, Furrow Irrigation. Design procedures and examples provided in section 652.0605 are developed from state approved computer programs using existing methodology from chapters 4 and 5 of this guide or from ARS publication, *Surface Irrigation Model, SRFR*.

(ii) Graded furrow with blocked ends—This modification to graded furrow irrigation has the potential to reduce or eliminate runoff and to improve water distribution uniformity and application efficiency. The ends of furrows are blocked, thereby ponding occurs in the lower part of the field. A tailwater ditch can be used to cause reverse flow in those furrows where water has not reached the end of the furrow. Infiltration is increased in this lower end. For best water distribution uniformity, blocked end furrow irrigation systems should pond water on the lower fourth to third of the field. Care must be exercised not to flood the plants in this area if they will not tolerate inundation.

Since runoff is eliminated, potential pollution from nutrients and pesticides to downstream surface water can also be substantially reduced. However, all the applied irrigation water is now infiltrated, thereby increasing the potential for pollution of ground water. Often blocking furrow ends only trades runoff for deep percolation loss. When converting to graded furrows with blocked ends, adjustments to inflow rates and possibly set time are essential. Inflow rates and set time are typically reduced. Blocked end furrow systems work best on low gradient fields.

Advantages:

- Eliminates runoff.
- Application uniformity can be increased.

Limitations:

- Limited to field slopes where the backed up or ponded area is between a fourth and a third of the length of the field.
- Furrows must have a large enough cross section to contain the ponded water.
- An increase in labor is required to watch and adjust inflows to match advance and infiltration in all furrows and prevent dike overtopping at the lower end.

Planning and design considerations:

The volume of water delivered to the furrow is equal to the average intake over the furrow length. The design of a graded furrow with blocked ends is similar to that for a level furrow in that the volume of inflow needed to provide the desired amount of application is provided to the furrow. Difficulty comes in accounting for and adjusting inflows for individual furrow intake characteristics; i.e., hard versus soft furrows.

Design procedures:

Basic design principles and procedures are presented in NEH, Part 623 (Section 15), Chapter 5, Furrow Irrigation, for level furrows. See section 652.0605 for design procedures and examples.

(iii) Graded furrow with modified slope—Slope modification to graded furrow irrigation has the potential to increase uniformity of infiltrated water. The two types of slope modification are:

- Slope that is gradually reduced throughout the entire length of the field.
- Slope that is graded in the upper part of the field and level in the lower part.

In the first type, slope in the direction of irrigation is gradually reduced throughout the full length of the field. Theory is to obtain a more uniform opportunity time for infiltration throughout the furrow length. Increased grades at the upper end decrease advance time for water to reach the lower part of the field. The irrigator must adjust inflow rates to create a uniform advance in all furrows. Adjustment throughout the season is also usually required.

In the second type, slope in the direction of irrigation can be divided into two parts—a graded upper field and a level lower field. Irrigation tailwater runoff from the sloping upper field irrigates the lower field. Slope changes typically occur at one-half, two-thirds, or three-fourths of the total furrow length.

Modified slope furrow irrigation systems can have some of the highest distribution uniformities of any system. However, they also require the most intense water management.

Advantages:

- High potential for increased irrigation uniformity.
- Limited (or eliminated) tailwater runoff.
- Decreased deep percolation.

Disadvantages:

- Higher irrigator skill and labor are required.
- Adaptable only on certain topographic locations.
- Most difficult of all irrigation systems to manage.
- Works best for design conditions.
- Requires adjusting furrow inflow rates throughout the season and from year to year.

Design procedures:

Design each slope section as a separate field. Except for the upper most field where the water supply is in a head ditch or pipeline, tailwater runoff from the higher elevation field is the furrow inflow for the next lower field. Because of changing intake characteristics both seasonally and yearly, furrow inflow is difficult to project for the lower fields. Typically lower value crops are grown on the lowest field.

Planning and design considerations are the same as those for graded furrow.

(iv) Contour furrow—Where downslope irrigation grade is excessive, the direction of irrigation furrows can be turned cross slope or on the contour. This will reduce the furrow grade. Unless the field slope is quite uniform, irrigation grades can be variable; a factor that tends to reduce distribution uniformity, application efficiency, and to increase runoff. On moderately sloping land, a principal concern is the possibility of furrow streamflows breaking across ridges or beds. This is more of a problem with crops, such as onions and beans, where shallow furrows are used or where surface residue is in the furrows. Where large water supplies are available and land slope is nearly level, furrows can be directed across the slope to convert a graded furrow irrigation system to a level furrow system. This often delays land leveling cost by several years.

Advantages:

- Irrigation grades are decreased.
- Erosion can be reduced.
- Can be used on field slopes that exceed desirable irrigation grade.
- Can minimize or delay land preparation costs.

Limitations:

- Point rows may result where field slopes are not uniform.
- Head and tailwater ditches may be on erosive grades.
- Overtopping during precipitation events can increase erosion.
- High irrigator skill and labor are required.
- Not suited to areas with high intensity rainfall events unless adequate provisions are made to control erosion.

Design procedures:

Design procedures for a contour furrow system are the same as those for graded furrow.

(v) Level furrow—Furrows are on nearly flat or level grade. A constant flow rate is turned into each furrow for the entire irrigation set. Flow rates and set times are designed to provide a desirable net application depth for a planned length of furrow. There is no runoff. Where the tail end of furrows is connected with a ditch, outflow from the faster advancing furrows can enter adjacent furrows from the tail end. This can improve uniformity of infiltration throughout the field. Total fall in the length of run cannot exceed half the net depth of application.

Advantages (see section 652.0601(d):

- High application uniformity can be attained.
- Net irrigation application can be easily adjusted.
- There is no irrigation runoff.
- Well suited to automation.
- Easiest to manage of all irrigation systems.
- With a uniform water supply, time of set determines application amount.

Limitations (see section 652.0601(d):

- Except on uniform flat fields, extensive land preparation is required for initial installation.
- Providing surface drainage in moderate to high rainfall areas is essential.
- Set times are generally short requiring frequent changes.
- Relatively large streams of water are needed and should be used, otherwise infiltration uniformity can be poor.
- Uniformity of soil surface must be maintained.

(vi) Graded furrow using surge technique—

Surge irrigation is the intermittent application of water to furrows or borders creating a series of on-off periods of either constant or variable time intervals. Usually the water is alternated (switched) between two irrigation sets at predetermined, often varied time increments until water has advanced to the end of the field or until irrigation is complete. Surge has the potential, with good management, to significantly decrease deep percolation and runoff, and significantly improve infiltration uniformity. Under some conditions it can reduce furrow erosion. Surge irrigation is most effective on fields where it is desirable to reduce soil intake rate.

During the first *on* period, the inflow wetting front advances down the furrow some distance, typically 20 to 25 percent of the furrow length. During the *off* period, water is applied to a second furrow typically on a different set. Each time water is turned on, it progresses more rapidly across the wetted area. More flow is then available to progress further down the dry furrow. The increased advance is caused by the decrease in water intake rate in the previously wetted area and decreased furrow roughness. By alternating flows in furrows, the total advance time and volume of water applied are both reduced when compared to standard continuous flow methods. Generally, surging results in more uniform water infiltration throughout the length of the furrow. Figure 6-3 illustrates how surge flow compares with conventional steady flow furrow irrigation methods.

Irrigation water can be surged manually to reduce the required advance time to the end of the field. These high labor systems are typically used on recently tilled soils and on soils that crack when dry.

Some irrigators use surge as a labor saving device, operating two irrigation sets with each water change. Because half the water is applied to each irrigation set, total set time may need to increase to provide an adequate irrigation. Where overirrigation has occurred in the past, less water is applied at better uniformity within the same set time.

Once the advance phase is complete, surge valve time interval can be set to provide a cutback irrigation inflow (short equal time intervals on each side). Some refer to this action as a soak cycle. Typically runoff is reduced without sacrificing irrigation uniformity down the furrow.

The system uses a battery powered, timer controlled valve that controls the direction of the irrigation flow. This is usually accomplished with a butterfly type valve as illustrated in figure 6-4. Solar powered panels are available for battery charging. Programmable controllers are also available. The control valve alternately directs the irrigation head to flow in opposite directions from the valve, usually in gated pipe. Modifications have been adapted for use on open concrete lined ditches using gated ports.

Advantages:

- Generally less water is used, distribution uniformity is increased, deep percolation at the upper end of the field is decreased, and overall application efficiency is increased.
- Surging times can be easily adjusted when using timer flow control valves.
- Small application amounts can be applied.
- Where water is pumped, energy use can be reduced.
- Overall, deep percolation and runoff can be reduced.
- One controller can be moved from site to site to operate additional valve bodies.

Limitations:

- Normal opening and closing of valves for surging is not practical for manual operation. However, manually operated long surge cycles on cracking clay soils may be advantageous.
- Care must be taken to assure adequate water is being applied, especially at the lower end of the field.
- Additional cost is associated with surge valve(s) and controller(s).
- When surge equipment is used on clay and clay loam soils, careful management is necessary to avoid excessive field runoff, especially if adequate water is applied to the plant root zone at the lower end of the field.

Planning and design considerations:

For many soils, experience has been that the same stream size under surge flow advances to the end of the field on both sets in nearly the same amount or less time it takes one conventional set in continuous flow. Flows advance to the end of twice as many furrows with the same amount of water and time. Surge flows allow light irrigations to be applied more efficiently (for germination of new crops, for crops with shallow root systems, and between rainfall events in semiarid climatic regions).

Many existing gated pipe systems can be converted to surge. Depending on existing outlets from a buried pipe system (or from a head ditch), layout of gated pipe for a surge system may be relatively easy. Perhaps only surge valves are needed. Solar battery powered, time clock controlled, commercial valves are readily available. Valve controllers that can be programmed in variable surge times during the advance

Figure 6-3 Surge irrigation versus conventional continuous flow furrow irrigation

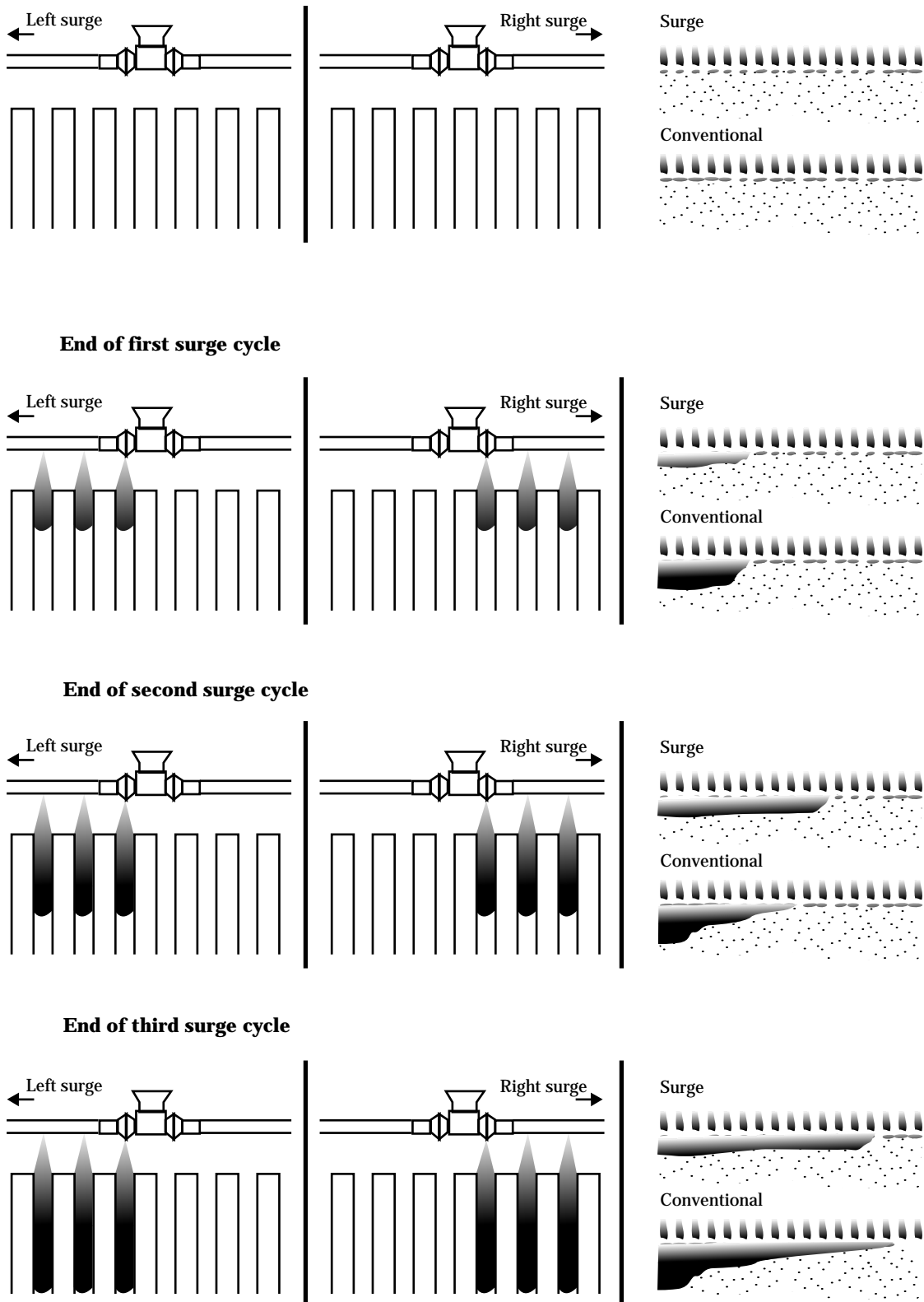
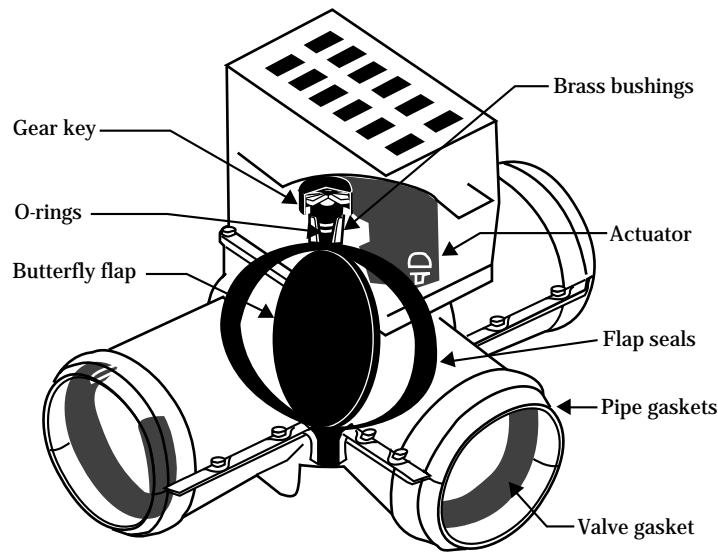
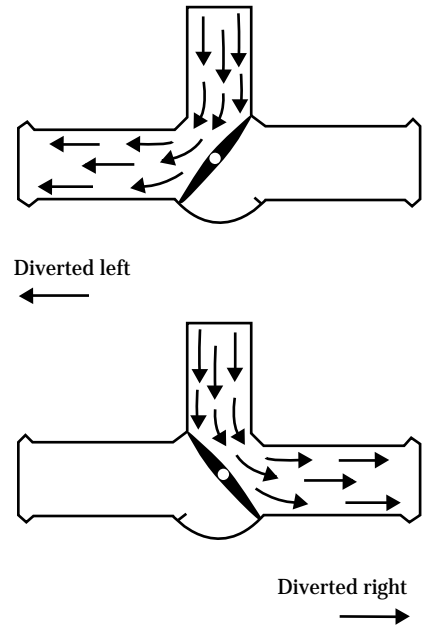

Figure 6-4 Butterfly type surge valves



Single butterfly type valve



Double butterfly type valve

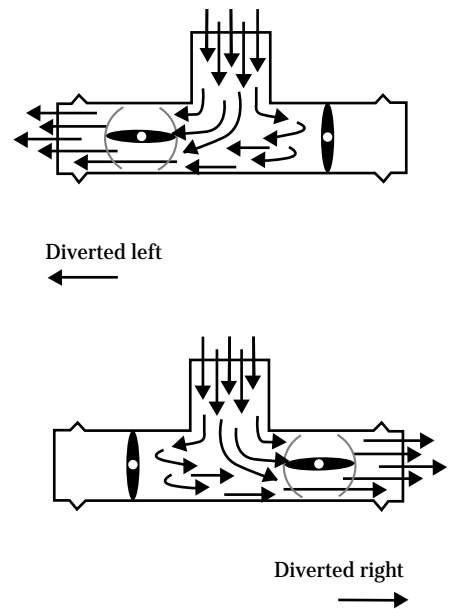

cycle are recommended. They should also be programmable for short duration surges after the water has reached the end of the furrow. This type of valve allows maximum flexibility in managing surge irrigation.

Sometimes costs and labor can be reduced by using several valve bodies with one controller. This allows leaving the valve bodies and gated pipe in place across the field(s) during the season, or with an extra valve body, the next irrigation set can be readied while the existing set is in operation. Only one controller is moved from place to place when each irrigation set is started.

Surge flow irrigation requires a greater level of management skill than conventional furrow irrigation. Most irrigators need assistance when first operating a surge system. They need to be able to observe the progress of each irrigation during different parts of the irrigation season as infiltration changes and to make the appropriate adjustments in surge times and flow rates. Field observations and evaluations of each irrigation application can help in fine tuning surge cycling times. Adjustments to gates are necessary to maintain uniform advance in all furrows. Screening of irrigation canal and reservoir water is necessary to limit debris from partly plugging valves and gates in gated pipe. Constant and uniform flow from gate openings is essential throughout the irrigation set.

Alternative methods for providing proper on-times include:

- Variable time-constant distance advance, variable cutback time method—This method varies the times of surges advancing in the furrow and the time of surges after water reaches the end of the furrow. Time adjustments can often be made so water in the furrow never quite recedes during a surge, yet runoff is kept very low.
- Variable time-constant distance advance, constant cutback method—This method varies the times of surges advancing in the furrow and uses a constant time for surges after water has reached the end of the furrow. This method may be most beneficial with moderate to high intake soils.
- Constant time-variable distance method—This method is used when the surge controller cannot automatically utilize variable surge times.

When using any of these methods, the planning technician and irrigator must realize that to apply the same amount of water, the surge sets need to be allowed to run longer than they previously ran to irrigate the same area. This is true unless only a light application is desired, and is especially the case when irrigating low intake soils.

Design procedures:

Design procedures and examples provided in section 652.0605 are developed from state approved computer programs using existing methodology from chapters 4 and 5 of this guide, or from ARS publication *Surface Irrigation Model, SRFRR*.

(vii) Graded furrow using cablegation technique—This modification to graded furrow irrigation can potentially decrease runoff, increase uniformity of infiltration, and decrease labor required. A plug inserted inside a gated pipe at the head ditch location is pushed slowly downslope through the pipe by water pressure. As the plug moves past the gates, water flows out the gates. Furrow flow (gate discharge) gradually reduces until the free water surface in the gated pipeline is lower than the gate opening. The plug is restrained by a small cable or rope attached to a hydraulic or electric braking device located at the head end of the gated pipe. The speed of the cable controls the time of set and depth of application. Cablegation has some of the same benefits as cutback irrigation. Maximum furrow inflow occurs at the beginning of irrigation as the moving plug clears the opened gate. Figure 6-5 illustrates the general arrangement of controls, pipes, and outlets in a cablegation system. Large gates, or risers on a buried pipeline, can be used to irrigate borders.

Advantages:

- Reduces labor. The system is essentially an automated gated pipe system.
- Easy to adjust speed of plug (irrigation set time).
- Improves distribution uniformity. Can reduce runoff and deep percolation.
- Variable grades along the gated pipe can be accounted for.

Limitations:

- Precise grade is required for gated pipe to achieve uniformity of gate discharge (furrow inflow).

- Screening to remove trash in the irrigation water is necessary.
- Some water is lost because of bypass requirements as the first few furrows in the set are irrigated and the plug has moved far enough to allow water to discharge from all outlets.
- Cabling works best where gated pipeline grades are between 0.2 and 2.0 feet per 100 feet (0.2 to 2.0%).

Planning and design considerations:

A single pipe is used to transmit water along the upper edge of the field and to distribute equal amounts to furrows or borders. The pipe is sized large enough to carry the head of water at the head ditch grade without completely filling the pipe (partial pipe flow). The plug causes water from the supply source to fill the pipe and flow out the outlets. See figure 6-5.

In this figure, the outlets (a) nearest the plug have the greatest pressure head; therefore, the greatest outflow. As the plug moves down grade, the pressure head decreases for any one gate causing the outflow to decrease (b). This process continues until outflow ceases because the outlet is above the water level in the pipe (c).

Partial pipe flow condition is essential for cabling to function. Once gates are adjusted for the desirable furrow flow, adjustments for following irrigations are seldom necessary.

Shortly after the plug reaches the end of the pipe and the last furrow has been irrigated the desired amount of time, water is shut off and the plug is removed by removing a cap on the end of the gated pipe. The cap

Figure 6-5 General arrangement of controls, pipe, and outlets

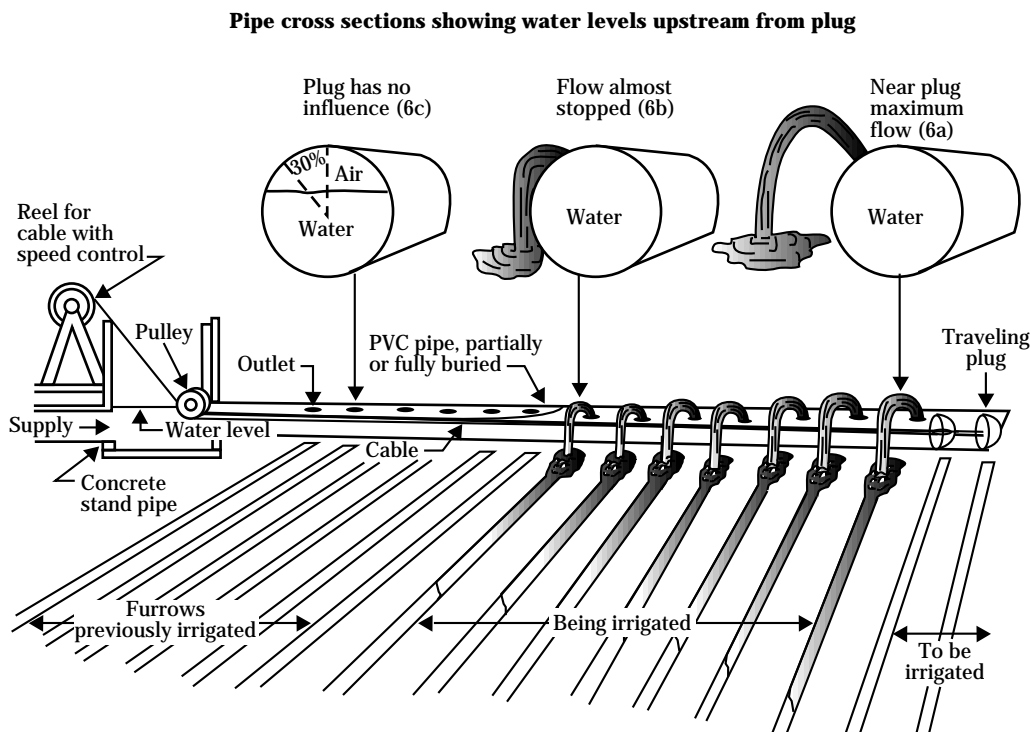

is replaced and the cable rewound onto the winch. The plug is reattached to the cable at the head of the pipe ready for the next irrigation. Water brakes, hydraulic rams, or electrical winch devices control the speed of the cable and plug. The water brake is a low cost, but very effective, water powered device. See ARS publication ARS-21, *Cablegation Systems for Irrigation*, for details of speed control devices. Rewinding of the cable is generally done by hand.

Design procedures:

Design methodology is reviewed in ARS publication ARS-21, *Cablegation Systems for Irrigation*, and several supplements published in recent years reviewing current research. Design procedure and examples are presented in section 652.0605.

(viii) Graded furrow with tailwater reuse (pumpback)—This modification to graded furrow irrigation can increase overall field application efficiency since most of the runoff or tailwater is returned to the head of the same field or to a lower elevation field for reuse. Furrow inflow rates are generally higher for decreased advance times and improved distribution uniformity. The components of a tailwater reuse (pumpback) facility includes tailwater collection ditches, a pumping plant with sump, pipeline(s), and a holding pond at either the lower end or the head end of a field or farm.

Advantages:

- Offsite runoff is decreased, thereby decreasing potential pollution of other surface water.
- Wastewater is available for irrigation or other on-farm uses.
- Better utilization of water delivered to the farm.
- Furrow irrigation application uniformity is increased.
- Soluble chemicals contained in tailwater are reapplied to cropland.

Limitations:

- Irrigated cropland is often taken out of production for the reservoir or sump. Many times ponds can be located in odd shaped corners that are not farmed.
- Flow to downstream users depending on runoff is reduced.

- Depending on chemical application and management, runoff can contain high levels of nutrients and pesticides. This can create a potential hazard to wildlife, especially water fowl that are drawn to ponded water.

Planning and design considerations:

Items to consider for this type of system are topography and layout of irrigated fields and the irrigators management level and desire. Figure 6–6 displays a typical tailwater recovery and reuse system in conjunction with an underground distribution pipeline.

Where the holding pond is located at the head end of the field or farm, only a small pumping plant and pump sump are required at the lower end. This alternative allows the pumping of tailwater as it occurs. The peak flow used to size the pump is generally less than half of the irrigation inflow, and a smaller diameter pipe is needed. The pump can be cycled or have float control switches that automatically turn on and turn off the pump as runoff collects in the sump, or it can be set to run continuously during the runoff period. Regardless where the holding pond is located, it should have the capacity to store runoff from one complete irrigation set.

Where siphon tubes, spiles, or ditch turnouts are used, cutback irrigation can result when water is returned to the supply ditch only during the first half of the irrigation set. While pumping back to the presently used head ditch, the water surface in the head ditch raises, causing siphon tube, spile, or turnout discharge to increase. This is generally undesirable. Where storage is inadequate, additional furrows must be set to use the pumpback water. Where gated pipe is used, pumpback flows are generally uniform and constant during the irrigation set. Additional gates are opened to discharge the pumpback water. To reduce labor and odd irrigation set times, it is typically easier to use the pumpback water on new sets. However, storage to contain runoff from one complete irrigation is necessary.

Where erosion is present, a small, shallow sediment settling basin should be installed just upstream of the sump pump or inlet end of the holding pond. A shallow basin can be cleaned relatively easily with available farm machinery, while a large pond or pit may require cleaning with large construction type equipment.

Erosion should be minimized with proper design and installation of collection ditches and sump or pit inflow structures. Irrigation tailwater should enter the sump or pond in a protected inlet structure (i.e., pipe drop inlet) at or near the pump inlet. Suspended silts and clays are then pumped back onto the field.

Tailwater collection ditches excavated below furrow outlet grade are the major cause of erosion when furrow irrigating highly erosive soils. Furrow outflow is often allowed to drop several inches into the tailwater collection ditches. An erosion headfall develops and works its way upstream in the furrow. This condition effectively removes soil and carries it into the tailwater collection ditch. Narrow vegetative strips (10 to 15 feet wide) and hand placed straw in the furrows just upstream of the tailwater collection ditch are effective means to control this type of erosion. Buried pipelines with risers at furrow grade can also be used.

Many pumps are available for use in tailwater recovery facilities. Tailwater runoff can contain suspended sediment, plant debris, worms, insects, and farm chemicals. Either sufficient screening is required to keep the material out of the pump, or a pump is selected that can handle the material. Pumping heads are generally low; therefore, horsepower requirements are generally low. Electric power is preferred to drive pumps because tractor and diesel engines are typically overpowered. However, for limited use a farm tractor may be desirable.

Tailwater reuse facility design requires reasonable estimates of runoff rate and volume. A field evaluation can be provided for an irrigation event to estimate the runoff, or runoff can be measured. A field evaluation or tailwater flow measurement should be made during periods of maximum expected tailwater runoff (i.e., second irrigation after furrows are smoothed by previous irrigation and before maximum crop water use).

Figure 6-6 Typical layout for a tailwater recovery and reuse facility

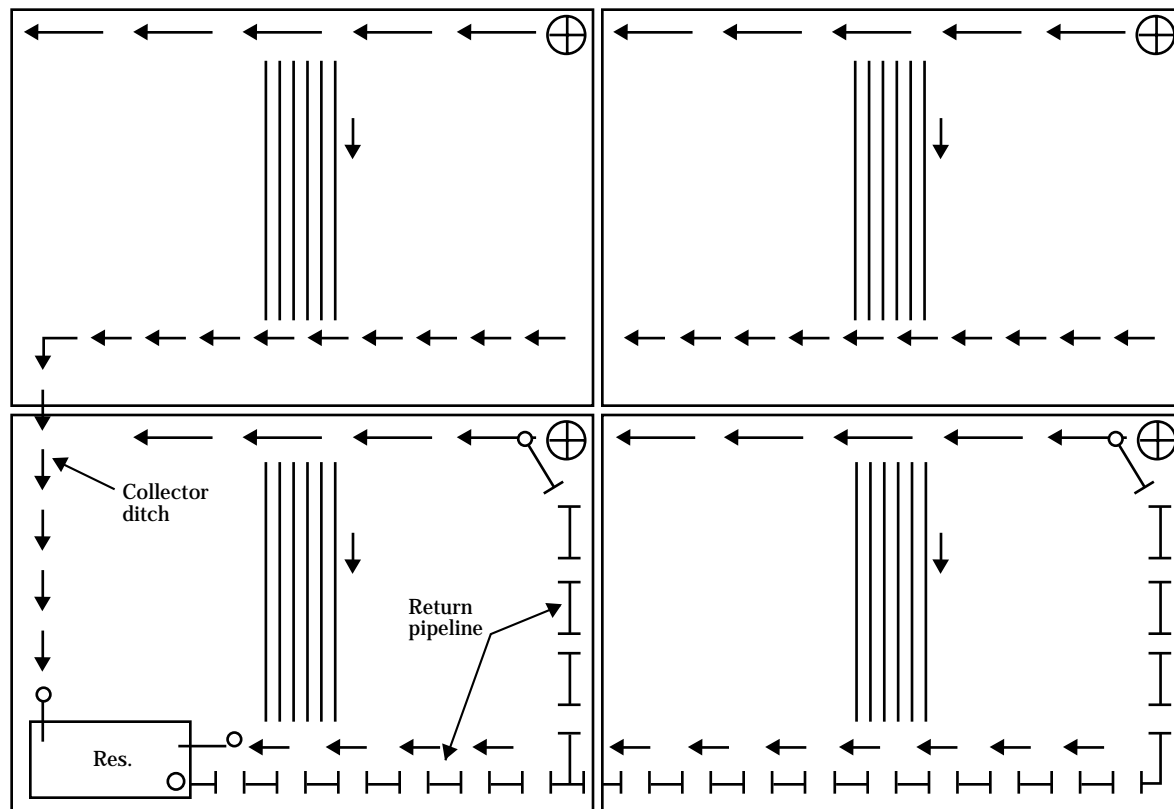

Measurement of runoff is relatively easy using portable measuring weirs, flumes, or small orifice plates. Seepage, evaporation, and overflow losses occur in the recovery, storage, and transport of tailwater. Losses can be as high as 25 to 35 percent of the runoff volume depending on the many variables and management skills of the irrigator.

Design procedures:

See Chapter 7, Farm Distribution Components, for additional discussion, design procedures, and examples.

(g) Contour ditch

Contour ditch is a form of controlled surface flooding. This system consists of installing a series of irrigation ditches or gated pipe running across the slope on the contour with little grade (< 0.1 ft per 100 ft). Water is discharged with siphon tubes, from gated pipe, or allowed to flow over the banks of the contour ditch uniformly along the length of the irrigation set. Generally, no flow constraints, such as dikes or levees, are along the length of run. In theory the water moves down the slope as a uniform sheet, but in practice it generally does not. The flow mostly moves to low areas and becomes nonuniformly distributed. Runoff is collected in the next downslope contour ditch and redistributed. Pasture and hay are the crops typically grown. Corrugations can be used to help irrigation flows.

The spacing between the ditches is governed by topography, soil intake rate, and net irrigation application. This type system is applicable to slopes up to 15 percent. On slopes of more than 2 percent, it should be restricted to sod forming crops. This system is adaptable to the steep residual soils in foothill areas and is generally used where season long water is not available at a reasonable cost.

(1) Advantages

- Contour ditch is low in establishment costs, requiring very little field preparation. However, land leveling or grading between the ditches can improve the uniform distribution of water.
- Irrigation efficiencies can be reasonable (50 to 60%) where soils are underlain by impermeable layers and where diligence is practiced for reuse of runoff.

- Flow onto fields from contour ditches can be semi-automated by use of continuously moving portable dams. The ditch generally must be well sodded since flow is typically over the bank. This works well with permanent crops, such as alfalfa, clover, and pasture.

(2) Limitations

- High labor requirement until system is fully established, then labor can be low.
- Should not be used on highly erodible soils unless stabilized by permanent sod type crop. It is recommended crop establishment be done with a temporary sprinkler system.
- Open ditch maintenance is high.

(3) Planning and design considerations

The most frequently encountered problem with contour ditch irrigation is maintaining adequate water spread throughout the length of run. The more uniform the field slope, the more uniform the irrigation flow is across the irrigation set. Corrugations installed down the principal grade are often used to help maintain uniform distribution.

Contour ditch systems are generally designed from local experience. The planning technician must follow up with the irrigator to assist in making adjustments as necessary to improve distribution uniformity. Table 6-2 provides estimates of design efficiencies. Under best site and management conditions, overall application efficiencies of 35 to 60 percent are possible. Typically, efficiency is in the range of 25 to 50 percent. Collection of runoff and redistribution is necessary to obtain these levels. See table 6-3 for general guidelines for recommended maximum length of run using a unit width stream of 0.01 cubic foot per second per foot.

(4) Design procedures

Designs for contour ditch irrigation systems are difficult because the ground surface, slopes, and lengths of run vary. Only rough approximations can be made, and adjustments after initial irrigations are necessary. Basic surface irrigation system design principles and field experience have been used to develop design tables and computer programs. See section 652.0605 for design tables, procedures, and examples.

Table 6-2 Recommended design efficiencies for contour ditch irrigation systems ^{1/}

Field slope ^{2/} %	Design slope %	----- Border intake family -----						
		0.1	0.3	0.5	1.0	1.5	2.0	3.0
0.00 - 0.10	0.10	50	50	55	60	60	60	60
0.10 - 0.25	0.20	50	50	55	60	60	60	60
0.25 - 0.50	0.40	50	50	55	50	60	60	60
0.50 - 1.00	0.75	50	50	55	50	60	60	60
1.00 - 2.00	1.50	40	45	50	50	55	55	55
2.00 - 4.00	3.00	40	45	50	50	55	55	55
4.00 - 6.00	5.00	35	40	40	40	45	45	45
6.00 - 9.00	7.50	35	40	40	40	45	45	45
9.00 - 15.00	11.00	35	40	40	40	45	45	45

1/ These recommended design efficiencies are based on good maintenance and management. Land smoothing between contour ditches is assumed.

2/ With field slopes of less than 2 percent, very smooth topography, and with nearly parallel contours, an alternative system, such as graded borders, may provide better overall control of irrigation water.

Table 6-3 Contour ditch irrigation—length of run, maximum length of run, and average irrigation time (unit width stream = 0.01 cubic foot per second per foot)

Border intake family	Net irrig. appl. (in)	Approx. irrig. time (hr)	Maximum length of run (ft) ^{1/}									
			----- 1 to 2 -----		----- 2 to 4 -----		----- 4 to 8 -----		----- 8 to 16 -----		----- 16 to 32 -----	
			MST (ft)	VST (ft)	MST (ft)	VST (ft)	MST (ft)	VST (ft)	MST (ft)	VST (ft)	MST (ft)	VST (ft)
0.1	1.0	4.9	250	500	275	300	125	200	90	150	60	100
	2.0	15.0	250	500	175	300	125	200	90	150	60	100
	3.0	31.0	250	500	175	300	125	200	90	150	60	100
	4.0	50.0	250	500	175	300	125	200	90	150	60	100
0.3	1.0	3.6	250	440	175	300	125	200	90	150	60	100
	2.0	5.1	250	500	275	300	125	200	90	150	60	100
	3.0	8.2	250	500	175	300	125	200	90	150	60	100
	4.0	12.0	250	500	175	300	125	200	90	150	60	100
0.5	1.0	2.2	250	330	275	300	125	200	90	150	60	100
	2.0	4.3	250	420	175	300	125	200	90	150	60	100
	3.0	6.6	250	490	175	300	125	200	90	150	60	100
	4.0	7.1	250	500	175	300	125	200	90	150	60	100
	5.0	9.1	250	500	275	300	125	200	90	150	60	100
	6.0	11.0	250	500	175	300	125	200	90	150	60	100
1.0	1.0	1.2	175	175	175	185	125	200	90	150	60	100
	2.0	2.1	215	215	175	225	125	200	90	150	60	100
	3.0	3.2	250	250	175	260	125	200	90	150	60	100
	4.0	4.4	2250	275	175	290	125	200	90	150	60	100
	5.0	5.7	250	305	175	300	125	200	90	150	60	100
	6.0	7.0	250	330	175	300	125	200	90	150	60	100
1.5	1.0	.08	125	125	135	135	125	140	90	150	60	100
	2.0	1.5	150	150	160	160	125	16	90	150	60	100
	3.0	2.2	175	175	175	185	125	195	90	150	60	100
	4.0	3.0	190	190	175	200	125	200	90	150	60	100
	5.0	3.8	205	205	175	215	125	200	90	150	60	100
	6.0	4.6	220	220	175	240	125	200	90	150	60	100
2.0	1.0	.07	100	100	105	105	110	110	90	120	60	100
	2.0	1.2	115	115	125	125	125	130	90	135	60	100
	3.0	1.07	130	130	135	135	125	145	90	150	60	100
	4.0	2.3	145	145	150	150	125	160	90	150	60	100
	5.0	2.9	155	155	165	165	125	170	90	150	60	100
	6.0	3.5	170	170	175	175	125	180	90	150	60	100
3.0	1.0	0.5	70	70	75	75	80	80	85	85	60	100
	2.0	0.8	85	85	90	90	90	90	90	100	60	100
	3.0	1.2	90	90	95	95	100	100	90	105	60	100
	4.0	1.06	100	100	105	105	110	110	90	115	60	100
	5.0	2.0	110	110	110	110	115	115	90	120	60	100
	6.0	2.4	115	115	120	120	125	125	90	130	60	100

^{1/} MST - Moderately Smooth Topography—Contours are essentially parallel and cross slope is not more than a fourth the general downslope. No rills, dikes, or furrows are present.

VST - Very Smooth Topography—Contours are very smooth and nearly parallel, and cross slope does not exceed 0.1 percent. All minor irregularities have been removed by land smoothing.

(h) Furrow erosion control

Irrigation induced furrow erosion is a major problem on highly erodible soils with slopes as flat as 1 percent. Even soils that have flatter slopes can have erosion problems. Maximum allowable furrow flow is, in most part, determined by the amount of erosion that may occur. Soils may erode if the furrow velocity exceeds about 0.5 feet per second. Figure 5–13 in NEH Part 623 (Section 15), Chapter 5, Furrow Irrigation, shows velocity and depth of flow for various stream sizes and grades in a standard shaped furrow. Recommended maximum allowable stream sizes are:

$Q = 15 / S$	erosion resistant soils
$Q = 12.5 / S$	average soils
$Q = 10 / S$	moderately erodible soils
$Q = 5 / S$	highly erodible soils (This value can range from 3 to 9, depending on erodibility of soils.)

where:

Q	= gpm per furrow
S	= slope in percent

A practical upper limit for inflow rate is about 50 gallons per minute, regardless of furrow slope. Streams larger than 50 gallons per minute generally require a much larger furrow cross section, or furrow ridge inundation occurs.

Sampling the amount of sediment coming off a field being planned for irrigation, or one similar to the one being planned, is the best way to determine degree of erosion. Close observations must be made along the entire furrow length to see where erosion is actually occurring and where sediment deposition is occurring. Erosion and sediment deposition throughout the length of the furrow is a dynamic process. Typically, most erosion occurs within the first few feet of furrow length or in the last few feet of the furrow. The primary cause is high velocities from head ditch outlets (gated pipe, siphon tubes, spiles, etc.) or excess dropoff at end of furrow into tailwater collection ditches.

An Imhoff cone may be used to evaluate furrow sediment discharge. Flow at any point in the furrow length can be used, but the sample is generally taken at the outflow point. A 1 liter sample is taken, placed in the Imhoff cone and allowed to settle for 30 minutes (Trout 1994). The sediment level in the cone is read

directly in mL. Conversion from volume to weight is necessary. This conversion can be estimated at 1 gram = 1 mL, or can be determined by calibration using local soils. Furrow outflow rate throughout the irrigation, furrow length and spacing must be known to estimate sediment yield in tons per acre for that specific field condition. Many tests are required with fully controlled conditions before collected data can be accurately expanded to other conditions, such as other soils, slopes, residue amounts, and furrow flow, length, shape, and roughness.

The planning technician can suggest several alternatives to the water user for reducing furrow erosion to acceptable levels. For example, conversion to a low application rate sprinkler system may be necessary to reduce erosion to desirable levels. With highly erosive soils, furrow irrigation can be difficult to manage in a manner that allows water to be applied uniformly and efficiently and yet have minimal erosion. High levels of water management and residue intensive cultural practices are generally required when surface irrigating highly erosive soils on field slopes of more than 1 percent.

Some methods and practices that can reduce field erosion and sediment deposition in tailwater collection facilities and surface water bodies are:

Improve water application—Change inflow rate, change time of set, or use surge technique. All parameters must be evaluated so as to not increase deep percolation losses in the upper part of the field. An increase in deep percolation can mean increased potential for ground water pollution.

Modify existing system—Shorten length of run or reduce irrigation grades with corresponding changes of furrow inflow rate.

Convert to another irrigation method (or system)—Change system to a low application rate sprinkler or micro irrigation system.

Change cropping sequence or crops—Use higher residue producing crops.

Change tillage systems, reduce tillage operations, or change tillage equipment—Use reduced tillage or no-till cultural practices to maintain higher rates of residue on the soil surface.

Improve surface residue—Place straw in furrow by hand or equipment.

Install vegetative filter strips at head or lower ends of field, or both—Plantings can be permanent or temporary. These areas are typically equipment turn areas with few or no plants. A vegetative filter strip at the lower end of field helps filter out sediments as well as chemicals (fertilizers and pesticides) attached to the eroded soil particles.

Change land use—Convert to crops providing permanent cover.

Redistribute the collected sediment (this is topsoil)—Annually haul and respread the collected eroded soil as a normal farming operation. This may be needed only during the years when crops are grown without sufficient surface residue or permanent cover.

Add polycrylimide to furrow inflow water—Recent field research by ARS has demonstrated that erosion reduction can also be realized by adding polyacrylamide (PAM), at very low concentrations, to the irrigation inflow stream (about 1 lb/acre per irrigation). PAM reduces erosion by stabilizing soil in the bottom and sides of the furrow and by flocculating suspended sediments. It is presently used in the food processing and wastewater treatment industries to flocculate suspended solids, allowing them to settle out. Application during the advance phase of the first and third to fifth irrigation is generally sufficient unless cultivation destroys the furrow seal. Whey from cheese making has also showed promise as a soil stabilizer.

One method to analyze potential furrow erosion and sediment yield and the effect of various conservation measures is to use the procedure in WNTC Engineering Tech Note W-23, *Furrow Sediment & Erosion Program, FUSED*. This procedure was developed using results from field research at the University of Wyoming and the ARS in Kimberly, ID. The process includes predicting:

- Sediment yield from the end of a field
- Amount of erosion at the upper end of the field
- Depth of soil eroded
- Years to erode a given depth of soil as a result of furrow irrigation
- Impacts of a number of applicable conservation practices

A computer program was developed in West NTC area to assist in making computations when comparing alternatives. The program user manual should be consulted for detailed guidance. An example using FUSED computer program for determining furrow erosion and sedimentation is presented in Chapter 15, Resource Planning & Evaluation Tools and Worksheets.

Caution should be used in expanding FUSED to other areas without providing local field evaluations and monitoring. USLE and RUSLE replacement program, WEPP, when completed and field tested, will contain erosion and sediment yield determination modules for various irrigation systems. WEPP should be used in place of FUSED when it becomes available.

652.0602 Sprinkle irrigation systems

(a) General

With the sprinkle irrigation method, water is applied at the point of use by a system of nozzles (impact sprinkler heads, spray nozzles, etc.) with water delivered by surface or buried pipelines. Sprinkler irrigation systems are classed by operation of the laterals. The three main types of sprinkle systems (laterals) are fixed, periodic move, and continuous/self move.

Sprinkler irrigation system examples include solid set (portable and permanent), handmove laterals, side roll (wheel-line) laterals, end tow laterals, hose fed (pull) laterals, perforated pipe laterals, high and low pressure center pivots and linear (lateral) move laterals, and stationary or traveling gun sprinklers and booms. Low Energy Precision Application (LEPA), and Low Pressure In Canopy (LPIC), systems are included with sprinkler systems as an operational modification to center pivot and linear move systems.

Pressure for sprinkler systems is generally provided by pumping, powered by electric motors and diesel, natural gas, L P gas, or gasoline engines. Where sufficient elevation drop is available, sprinkler systems can be operated using gravity to provide the necessary operating pressure.

If the system is properly designed and operated, application efficiencies of 50 to 95 percent can be obtained. The efficiency depends on type of system, cultural practices, and management. Poor management (i.e., irrigating too soon or applying too much water) is the greatest cause of reduced water application efficiency when using sprinklers. System losses are caused by:

- Direct evaporation in the air from the sprinkler spray, from the soil surface, and from plant leaves that intercept spray water.
- Wind drift (normally 5 to 10 percent depending on temperature, wind speed, and droplet size).
- Leaks and system drainage.
- Surface runoff and deep percolation resulting from, nonuniform application within the sprinkler pattern. If the system is designed to apply water at less than the maximum soil infiltration

rate, no runoff losses will occur. With some systems where water is applied below or within the crop canopy, wind drift and most evaporation losses are reduced. Soil surface storage is especially important where low pressure in-canopy center pivot laterals are used. LEPA systems use complete soil, water, and plant management to prevent runoff.

The water infiltration process under sprinkler irrigation differs from that in surface irrigation. With surface methods, water is ponded on the surface. With sprinkle irrigation, water is applied so ponding does not occur or is only temporary. System application rate should be less than the maximum allowable rates shown in Chapter 2, Soils, unless soil surface storage (ponding) can be assured without appreciable translocation of applied water.

On sloping sites where the soils have a low to medium intake rate, runoff often occurs under center pivot systems, especially at the outer end of the sprinkler lateral. Developing surface storage with reservoir tillage, rough tillage, and residue management practices or temporarily increasing intake rate with ripping between plant rows helps control water translocation.

Planning and design considerations and guidelines for selection of sprinkler irrigation equipment presented later is not all inclusive. Refer to NEH, Part 623, (Section 15), Chapter 11, Sprinkle Irrigation, for further details. Operating pressures for these guidelines are grouped as follows:

Pressure	lb/in ²
Low	2 to 35
Moderate	35 to 50
Medium	50 to 75
High	75+

The range of single event application efficiency (E_a) values for various types of sprinkle systems are displayed in table 6-4. Season long irrigation application efficiencies typically are lower because of early season plant water requirements and soil intake rate changes.

Soil characteristics relating to irrigation are provided in Chapter 2, Soils. Crop characteristics relating to irrigation are provided in Chapter 3, Crops, and irrigation water requirements are provided in Chapter 4, Water Requirements.

The required capacity of a sprinkle irrigation system depends on the size of the area irrigated, gross depth of water to be applied at each irrigation, and the operating time allowed to apply the water. See NEH, Part 623, Chapter 2, Irrigation Water Requirements, for further details regarding crop water needs. The required capacity of a sprinkle system can be computed by:

$$Q = \frac{453 A d}{f T} \quad \text{or} \quad Q = \frac{453 A d'}{T}$$

where:

Q = system capacity (gpm)

A = area irrigated (acres)

d = gross depth of application (inches)

f = time allowed for completion of one irrigation (days)

T = actual operating time per day (hours per day) to cover entire area

d' = gross daily water use rate (inches per day)—may be peak or average, depending on need and risks to be taken.

Note: This equation represents the basic irrigation equation $QT = DA$ with conversion factors for sprinkler irrigation design. Typically, tables readily available by NRCS and manufacturers pertaining to sprinkler heads, pipe friction losses, and pump curves are in units of gallons per minute (gpm) rather than cubic feet per second, cubic meters per second, or liters per minute.

Table 6-4 Application efficiencies for various sprinkler systems

Type	E_a (%)
Periodic move lateral	60 – 75
Periodic move gun type or boom sprinklers	50 – 60
Fixed laterals (solid set)	60 – 75
Traveling sprinklers (gun type or boom)	55 – 65
Center pivot - standard	75 – 85
Linear (lateral) move	80 – 87
LEPA - center pivot and linear move	90 – 95

(b) Periodic move sprinkler irrigation systems

A periodic move sprinkler irrigation system is set in a fixed location for a specified length of time to apply a required depth of water. The length of time in a position is called the length of set or irrigation set time. The lateral or sprinkler is then moved to the next set position. Application efficiencies can range from 50 to 75 percent for the low quarter area of the field (E_q). The low quarter area definition commonly applies to all periodic move or set type sprinkler systems.

(1) Periodic move systems

(i) Handmove laterals—This system is composed of portable pipelines with risers and sprinkler heads. Portable or buried mainline pipe with uniformly spaced valve outlets provides a water supply. Portable aluminum, or sometimes plastic, lateral pipe has quick couplers. Risers and sprinkler heads are either center-mounted or end-mounted. Lateral sections are typically 20, 30, or 40 feet long. When the lateral has completed the last set location in the field, it must be dismantled and moved back across the field to the start position unless multiple laterals are used and the finish location is adjacent to the start location of the next set. Application efficiencies can be 60 to 75 percent with proper management.

A handmove system has a low initial cost, but requires high operating labor. It is difficult to use in tall crops, such as corn or mature vineyards. Riser height must be based on maximum height of the crop to be grown. For hydraulic reasons minimum height is generally 6 inches. Risers over 4 feet in height must be anchored and stabilized. Handmove systems are sometimes used to establish a crop that will later be irrigated by a surface system. Leaching salts and other toxic ions from soils is sometimes accomplished using handmove sprinklers. Handmove sprinklers are easily adapted to odd shaped fields. Because 3-inch diameter laterals are easier to pick up by hand and carry to the next set, they are much preferred over those that are 4 inches in diameter. However, long laterals should be 4 inches in diameter. Because of excessive bending while being carried, 40 foot lengths of 2-inch diameter pipe are unsuitable.

(ii) Side (wheel) roll laterals—A side (wheel) roll system is similar to a handmove system except that wheels are mounted on the lateral. The lateral pipe serves as an axle to assist in moving the system side-ways by rotation to the next set. The sections of the lateral pipe are semi-permanently bolted together. Each pipe section is supported by a large diameter (at least 3 ft) wheel generally located at the center, but can be at the end. The lateral pipe itself forms the axle for the wheels. The lateral is moved mechanically by a power unit (air-cooled gas engine) generally mounted at the center of the line. With proper management, application efficiencies can be 60 to 75 percent.

The side roll system can be used only on low growing crops, such as grass pasture, grain, grain sorghum, alfalfa, sugar beets, potatoes, and vegetables. The system is best adapted to rectangular fields on relatively uniform topography. A flexible hose or telescoping section of pipe is required at the beginning of each lateral to connect onto mainline outlet valves.

Wheel diameters should be selected so that the lateral clears the crop. Specified lateral move distance is equal to the distance moved by a whole number of rotations of the line. Commonly used nominal wheel diameters are about 5, 6, and 7 feet. Wheels as large as 10-foot diameter are sometimes used to clean taller crops or to allow wheel lines to be moved across furrows and ridges.

Self-righting or vertical self-aligning sprinkler heads are used because the sprinkler head is always upright, even with partial rotations. Without the self-aligning heads, extra care must be taken so that the pipe rotation is fully complete for the full length of the lateral and all sprinkler heads are upright. The ends of the lateral usually trail a little and must be moved by hand for proper alignment, or the lateral can be moved just past the set position and then backed up to align the ends properly. Poor distribution uniformity results if the sprinkler heads are not upright. Undulating topography usually requires alignment by hand for best uniformity.

Side roll lateral pipe diameters of 4 or 5 inches are most common. Common sprinkler head spacing is 30 or 40 feet. Laterals can be up to 1,600 feet long with one power unit. Lateral lengths of 1,320 feet are generally considered maximum for rough, steep, or undulat-

ing topography. Figure 6-7 displays a typical side roll or handmove system operation layout.

Quick-drain valves are installed at several locations on each lateral to assist line drainage before it is moved. The lateral moves much easier when it is empty. Drain valves are a factor in the minimum operating pressure that must be used on the lateral. Typically drains will not close and seal properly below about 24 pounds per square inch. Drain valves should be well maintained to provide proper closing upon filling the lateral line to start the next irrigation set.

Empty laterals must be anchored to prevent movement by wind. They roll very easily and should be properly restrained, especially during the nonirrigation season when the irrigator spends little time in the field.

A variation to the side roll lateral (called side move) is the addition of small diameter trail lines at each sprinkler head location. These trail lines can have three, four, or five sprinkler heads, and the complete unit can be an equivalent of two or three typical laterals. With this modification, the lateral pipe cannot serve as the axle when being moved because trail lines are attached directly to the lateral pipe. A separate drive shaft and the main sprinkler lateral are supported by an A-frame at each wheel location. The A-frame is supported by two wheels.

Figure 6-7 Side roll or handmove sprinkler system layout

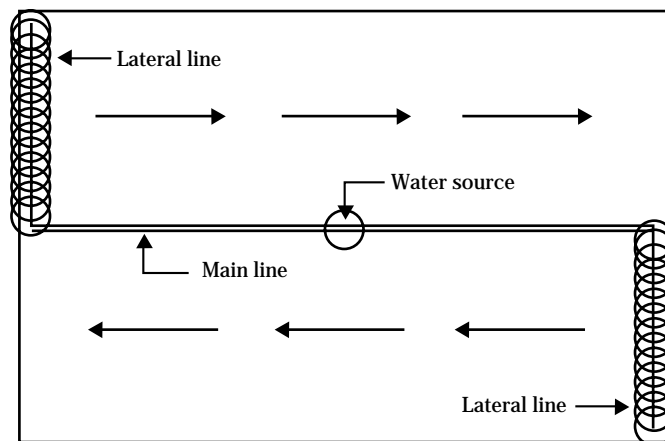

This variation requires dismantling of the trail lines when the lateral has reached the end set, where trail lines are hauled back to the start location. The main sprinkler lateral is typically moved back to the start location by a centrally located power unit, usually an air-cooled gas engine.

(iii) End-tow laterals—The end-tow lateral system is similar to a hand move system except that it consists of rigidly coupled lateral pipe and is mounted on skid plates or dolly wheels. The mainline is buried across the middle of the field. Laterals are towed lengthwise across the mainline from one side to the other with a tractor. Both ends of the lateral can be connected to the mainline via a flexible hose. After draining the pipe through quick-drain valves, a small tractor can easily tow a quarter-mile-long line to its new set.

Two support or carriage types are available. One is a skid plate attached to each coupler to slightly raise the lateral pipe off the ground, protect the drain valve, and provide a wear surface when towing the pipe. Out-riggers are placed every 200 to 300 feet to prevent overturning. The other carriage type uses small metal wheels located midway between couplers to allow easy towing. Guide rollers are used near the mainline to position the lateral at the next set. Typically lateral positions are offset a half of the total move. Application efficiencies can be 60 to 75 percent with proper management.

This system is best suited to grass pasture, but can be used in row crops if unplanted tow paths are maintained. It requires a fairly large area adjacent to the mainline to allow positioning of the lateral to the next set on the opposite side of the mainline. When used with row crops, this area can be planted to grass or alfalfa. The advantage of this system is its relatively low cost and minimum labor requirement.

(iv) Hose fed (pull) laterals—A variation to end-tow laterals is the hose fed system. A few (typically one to five) low capacity sprinkler heads are mounted on small diameter flexible plastic or rubber hoses that are attached to outlet valves. The hoses with equally spaced sprinklers are pulled by hand to the next adjacent set. To utilize small, light weight flexible hose that can be easily moved by hand, submains are used. The number of sprinkler heads, thus the length of

laterals, is limited by both high friction loss in the small diameter hose and the ease of moving. This system is excellent for orchards and irregular shaped fields where the number of sprinklers per hose can vary in proportion to the field or set width to be covered. With proper management, application efficiencies can be 50 to 65 percent.

(v) Gun type sprinkler—Large, periodic move, gun type sprinklers are operated and moved as a large single impact type sprinkler head. Sprinkler discharge flows can range from 50 to more than 1,000 gallons per minute. Nozzle diameters can vary from 1/2 to 1 3/4 inches, and operating pressures from 60 to more than 120 pounds per square inch. The sprinkler is moved from one set to the next set either by hand or using a small tractor, depending on their size and whether they are towable. Generally only one sprinkler is operated per lateral. Laterals are generally aluminum pipe with quick-coupled joints.

When irrigating, the sprinkler is allowed to remain at one location (set) until the desired amount of water is applied. Application rates can be very high, and uniformity of application can be adversely effected with wind greater than 4 miles per hour. Droplet size will be large beyond 50 feet from the sprinkler, thus soil puddling can occur and sensitive crops can be damaged. With proper management, application efficiencies can be 50 to 60 percent.

(vi) Boom sprinkler—Periodic move boom systems are operated and moved with a tractor similar to large gun sprinklers. The boom generally contains several closely spaced impact sprinklers or spray heads. It rotates around a central swivel joint where water is introduced. Power for the rotation comes from back pressure caused by directional sprinkler nozzles. The supply line is generally portable aluminum with quick-coupled joints. When irrigating, the boom is allowed to remain at one location (set) until the desired amount of water is applied.

Boom sprinkle systems are not suitable for use in windy areas. Wind adversely affects uniformity of application and rotational operation. High winds can overturn the entire boom. With proper management, application efficiencies can be 50 to 60 percent.

(vii) Perforated pipe—Perforated pipe systems spray water from 1/16-inch diameter or smaller holes drilled at uniform distances along the top and sides of a lateral pipe. The holes are sized and spaced to apply water uniformly along the length of the lateral. Common operating pressures are 5 to 20 pounds per square inch. Application rates close to the lateral are generally quite high. Spacing between lateral sets must be quite close to obtain an acceptable uniformity of application. Either plastic or aluminum laterals with quick-coupled joints are used. Water used must be free of debris, otherwise hole plugging is a problem. With proper management, application efficiencies can be around 50 percent.

(2) Planning and design considerations

(i) Sprinkler heads—Rotating, impact type sprinkler heads operating at intermediate pressure (30 to 60 lb/in²) are commonly used on periodic move lateral type systems. Rotating impact sprinkler heads come with many variations including full circle, part circle, low and standard trajectory height, with and without straightening vanes, and single or double nozzle. The second nozzle on a double nozzle head is typically a 3/32- or 1/8-inch diameter orifice. It is used as a fill-in to improve pattern uniformity.

Flow control valves at the base of each sprinkler head or flow control nozzles may be required where the terrain undulates or has significant changes in elevation. Flow control nozzles require about 2 to 4 pounds per square inch. Impact type sprinkler heads can be operated at 25 to 35 pounds per square inch to reduce energy. Some systems operate on gravity pressure.

(ii) Laterals—Laterals are generally laid out perpendicular to the slope. To obtain near-uniform application of water throughout the length of lateral, pipe diameter and length should result in discharge at the sprinkler nozzle within plus or minus 10 percent of design. (A maximum nozzle pressure difference of 20 percent provides a discharge not varying more than 10 percent from each nozzle.) To create less confusion and to facilitate dismantling, moving, and stacking, the same sprinkler head, nozzle size, and diameter of lateral are recommended throughout the length of hand move laterals. Convenient set times are 23.5, 11.5, or 7.5 hours, thus allowing a half hour for draining and moving laterals, with one, two, or three moves

per day. Moving the lateral three times a day is not popular because one move always comes in the dark at a inconvenient time and with increased labor cost.

(iii) Lateral set sequencing—Lateral sets can be sequenced in several ways. Using a typical 40 by 50 foot spacing for a periodic move lateral system, the following methods can be used to move laterals across a field.

Move at 50-foot sets across the field. Portable laterals must be dismantled and hauled back to the first set position. Side roll laterals must be rolled all the way back to the first or initial set position. The irrigator may choose to apply half the irrigation application in each direction. However, this requires twice the number of moves. Distribution uniformity is reasonable under conditions where moderate pressure is used and wind is not a serious problem.

Move at 100-foot sets across the field. Then reverse direction and move back at alternating 100 foot sets. This allows convenient operation of the system without having to dismantle and haul back or move the lateral to the initial or start position. Distribution uniformity depends on wind conditions. Lateral pipes are hand carried twice as far as in the first method, but the lateral does not need to be dismantled and hauled back.

Use 25-foot offset pipe when moving across the field the second time and each alternating set thereafter, with both the 50-foot and 100-foot set methods. This procedure improves overall distribution uniformity especially in windy areas. Existing 50-foot systems can be easily converted by adding a 20- to 30-foot swing or offset line. (Slight realignment of the lateral is needed to evenly divide the set.)

With any set sequence, alternating day-night set with each rotation across the field is recommended. Crop evapotranspiration or winds generally are different during daytime and nighttime hours causing varying losses. Nighttime application is generally more efficient with better distribution uniformity. As much as 10 percent more net application is accomplished with night time sets. Sometimes 11-hour night sets and 13-hour day sets are used to overcome the difference.

(3) Application efficiencies

Both Distribution Uniformity (DU), and Christiansen Uniformity (CU) coefficients are used to determine the application efficiency (E_a) of the low quarter (E_q or AELQ) or of the low half (E_h or AELH). This then becomes the design application efficiency.

$$E_q = DU \times R_e \quad \text{and} \quad E_h = CU \times R_e$$

where:

R_e = effective portion of water applied

CU estimates can be obtained from NEH, part 623 (section 15), chapter 11, tables 11-9 to 11-12. R_e estimates are obtained using figure 6-8.

Figure 6-8 Effective portion of applied water— R_e

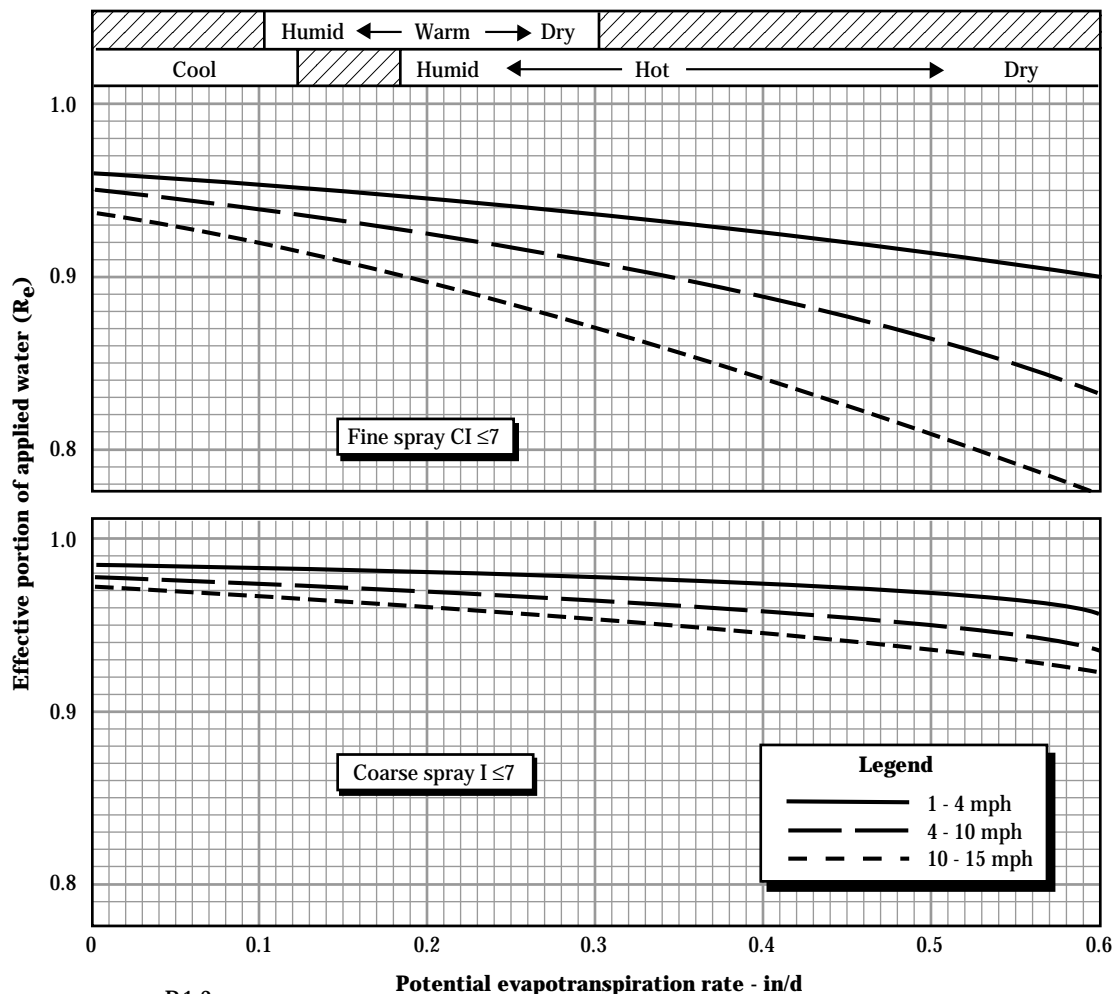

$$CI = \frac{P \cdot 1.3}{B}$$

Where:

- CI = spray coarseness index
- P = nozzle operating pressure (psi)
- B = nozzle size (64ths of an inch)

If the value of CI is less than 7, the spray is coarse. If it is more than 17, the spray is fine. When the value of CI falls between 7 and 17, the R_e value can be interpolated.

(i) Moderate and low operating pressures—Impact type sprinkler head operating pressures below 35 pounds per square inch require close lateral and sprinkler head spacing. Low pressure sprinkler heads are available to use with low pressure operation, 25 to 35 pounds per square inch. Spacing of heads on laterals and distance moved (spacing between laterals) must be designed accordingly to provide acceptable uniformity. About 25 pounds per square inch is the lowest operating pressure recommended for impact type sprinkler heads. Standard lateral drain valves may not close properly when operating pressures are below 24 pounds per square inch. Sprinkler head spacing and lateral move distances of 20 by 20 feet, 20 by 30 feet, 30 by 30 feet, and 30 by 40 feet are common with low pressure operation.

(ii) Flow regulation devices—Flow regulation devices or pressure regulators are either inserted near the base of the sprinkler, or they are an integral part of the sprinkler nozzle. The friction loss through the regulator, typically 2 to 4 pounds per square inch, must be included in calculations for required mainline operating pressure, especially when using low operating pressures. For example, if a valve was selected to maintain about 30 pounds per square inch at the sprinkler, a pressure loss of about 4 pounds per square inch can be expected across the regulator and must be accounted for.

(iii) Preliminary estimate of sprinkler spacing and sprinkler sizes—NEH, part 623 (section 15) chapter 11, tables 11-9 to 11-12 can be used to make a preliminary estimate of sprinkler spacing, nozzle size, and operating pressure. Many design slide rules and computer programs are available from sprinkler equipment manufacturers. The slide rules are convenient for developing preliminary design trials and for estimating purposes. A preliminary estimate of overall irrigation application efficiency is required. Experience in an area and personally doing several designs and field evaluations help provide confidence in planning and designing.

(4) Design procedures

A step-by-step procedure for planning and designing a sprinkler irrigation system includes:

Step 1—Identify resource concerns and problems. Determine objective(s) and purpose of new or revised irrigation system. Include soil, water, air, plant, and animal resources, and human considerations.

Step 2—Inventory resources for field or farm. Include area irrigated, soil(s), topography, water source, and when available, water quantity and quality, power type and location, crops, irrigator's desire for a type of sprinkler system and timeframe for moving laterals, labor availability, availability of sprinkler irrigation equipment dealers, and water management skill and desire of the irrigation decisionmaker.

Step 3—Determine soil characteristics and limitations. Include AWC, maximum allowable application rate, usable rooting depth, acidity, salinity, and water table. Typical (actual) crop rooting depth needs to be identified for specific fields and soils. In most soils, actual depth (and pattern) is less than usable rooting depth because of farm management decisions (i.e., timing of field operations) and type of field equipment used. A field investigation is strongly recommended in addition to data in the local NRCS FOTG. If a field contains more than one soil, the most restrictive soil must be determined. Crops use essentially the same amount of water whether growing in sand or clay soil. Thus, the system should be managed to meet the needs of the more restrictive soil.

Step 4—Determine net irrigation water requirements for crops to be grown. Use season, month, and peak or average daily use rate, accounting for expected rainfall and acceptable risks.

Step 5—Determine irrigation frequency, net application, gross application (based on estimated application efficiency), and minimum system capacity requirements.

Step 6—Determine alternative irrigation systems suitable to the site. Include the sprinkler system desired by the user. Evaluate alternative irrigation systems and their multiresource impacts on the environment (soil, water, air, plant, animal, and human considerations) with user.

Step 7—Provide preliminary sprinkler head design. Include spacing, discharge, operating pressure, wetted diameter, head type, nozzle size(s), average application rate, and performance characteristics.

Step 8—Determine number of laterals needed for selected time of set, set spacing, moves per day, and frequency of irrigation in days.

Step 9—Evaluate design. Does it meet the objective and purpose(s) identified in step 1?

Step 10—Make adjustments as needed. This process may need to be done more than once so the system fits the field, soils, crops, water supply, environmental concerns, and the desires of the irrigation decision-maker.

Step 11—Finalize sprinkler irrigation system design, layout, and management skills required by the irrigation decisionmaker.

Step 12—Determine lateral size(s) based on number of heads, flow rate, pipeline length, and allowable pressure loss differential between first and last sprinkler head. Determine if pressure or flow regulators are needed. Determine minimum operating pressure required in mainline(s) at various critical locations on the terrain. Several trial lateral locations may need to be evaluated to determine the range of friction loss and consequent pressure required at various locations along the mainline.

Step 13—Determine mainline sizes required to meet pressure and flow requirements according to number of operating laterals. This includes diameter, pipe material, mainline location, and the location and type of valves and fittings. It involves hydraulic calculations, basic cost-benefit relationships, and potential pressure surge evaluations for pipe sizes and velocities selected. Mainline operating pressure measured at the discharge side of each lateral outlet valve should be within 10 percent of the design lateral operating pressure. Where chemigation is anticipated, less operating pressure difference is desirable. A graphic solution can be helpful when sizing main supply pipelines. The ground line and pipe hydraulic grade line (HGL) along the mainline can be plotted for easy identification of critical pressure locations. The distance between the ground line and HGL will be the operating pressure at that main line location.

Step 14—Determine maximum and minimum Total Dynamic Head (TDH) required for critical lateral location conditions. Determine total accumulated friction loss in mainline, elevation rise (drop) from pump to extreme point in the fields, water surface to ground surface (lift) at pump, column loss with vertical turbine pumps, and miscellaneous losses (fittings, valves, elbows) at the pump and throughout the system. It is wrong to assume miscellaneous losses are minor and to gloss over them. Type and size of valves, radii of elbows, and sharpness of fittings are important. Check them out and know how they affect system performance. See section 652.0605 for nomographs and tables used to estimate head losses.

Step 15—Determine maximum and minimum pumping plant capacity using required flow rate and TDH. Estimate brake horsepower for the motor or engine to be used.

Step 16—Preselect several alternative pumps available from various dealers in the area. Use pump performance curves prepared for each make and model of pump. Every pump has a different set of performance (characteristic) curves relating to operating head (pressure) output and discharge capacity. Select pump(s) and power unit(s) for maximum operating efficiency within the full range of expected operating conditions. Multiple pumps may be desirable to efficiently meet both minimum and maximum conditions. Pump and drive unit alternatives are recommended as a reference for determining availability. Only pump capacity and TDH requirements are recommended to be provided to the user. Never select a pump based on horsepower alone. Let a pump dealer select the appropriate motor or engine and pump to fit the conditions. Availability of a pump dealer for providing maintenance and repair should be considered by the operator. Buying a used pump without first checking pump characteristic curves for that specific pump is seldom satisfactory. A pump needs to match the required capacity and TDH for efficient and economic performance. An inefficient operating pump can use needless excess energy.

Step 17—Prepare final layout and operation, maintenance, and irrigation water management plans. Include method(s) of determining when and how much to irrigate (irrigation scheduling). Provide recommendations and plans for at least one water measuring device to be installed in the system for water management purposes.

Planning steps may be substantially abbreviated when the planning technician provides only basic resource information and limitations. The design of the sprinkler system and components is done by an irrigation system design consultant or equipment dealer. Regardless of who does the design, the processes listed in

steps 1 through 17 should be followed to provide an adequate system suitable to the site.

Design procedures and examples are provided in section 652.0605 and in more detail in NEH, Part 623, (Section 15), Chapter 11, Sprinkle Irrigation. Manufacturer literature is readily available and most useful in selection of sprinkler head models, nozzle sizes, and discharge at various pressures.

Example 6-1 Typical field data for a side roll (wheel line) lateral system

Known data from Field Office Technical Guide:

Crop: Alfalfa Peak ET_c = .30 in/day, MAD = 50%
Soil: Glenberg loam AWC for 5 ft = low 6.9 in, mid 7.9 in, high 8.9 in
 AWC for 4 ft = low 5.7 in, mid 6.5 in, high 7.3 in
 AWC for 3 ft = low 4.5 in, mid 5.2 in, high 5.8 in
Soil sprinkler intake rate: 0.40 in/hr (max. sprinkler application rate)

where:

ET_c = crop evapotranspiration
 MAD = management allowable depletion (deficient)
 AWC = available water capacity of soil

Field: 80 acres, 1,320 x 2,640 feet, rectangular

Water source: Well at midway point of the long way of field on one edge (see sketch on worksheet)
 water depth *while pumping* = 100 ft
measured maximum flow = 1,000 gpm

Power: Power available at well is 3-phase, 440-volt AC electric current

Topography: Maximum difference in elevation (all slopes are uniform):
 between field midway point and uphill end of most faraway lateral = 25 ft
 to downhill end of field from midway point = 20 ft
 elevation difference (uphill) from well across midway point of field = 12 ft

Landowner wants to complete irrigation in 6 days or less. Convenient set times are 8, 12, or 24 hours (including a half hour for draining and changing laterals for each move). Prefers side roll laterals.

Example 6-1 Typical field data for a side roll (wheel line) lateral system—Continued

- Find:**
- Net and gross application in inches and frequency in days
 - Select sprinkler head make, model, sprinkler spacing along lateral, discharge, operating pressure, application rate, and if flow or pressure regulator are required.
 - Distance lateral to be moved between irrigation each set (spacing of valve outlets), layout, length(s), and number of laterals required.
 - Set times and total time to irrigate entire field.
 - Flow rate per lateral, lateral material, diameter, and friction loss. Check sum of lateral(s) flow rate(s) against minimum capacity requirements with:

$$Q = \frac{453 A d}{f T}$$

where:

Q = flow in gpm

A = area in acres

d = gross depth of application in inches

f = time allowed (frequency) for completion of one irrigation in days

T = actual operating time in hr/d

- Pressure required in mainline for worst case lateral location.
- Mainline—material, diameters, friction losses, including valves and fittings.
- Water measuring device.
- Total mainline flow requirements at pump, pump capacity.
- TDH, including lift from water level to pump.
- Pump and motor/engine size selection.

Computations:

Exhibit 6-1, Sprinkler irrigation system planning/design worksheet, is used to determine minimum irrigation requirements based on soils, crops, and system design requirements. See chapter 15 for the master blank worksheet used in this example.

Exhibit 6-1 Sprinkler irrigation system planning/design worksheet

U.S. Department of Agriculture
Natural Resources Conservation Service

Page 1 of 5

Sprinkler Irrigation System Planning/Design Worksheet

NAME _____ DATE _____ PREPARED BY _____

DISTRICT _____ COUNTY _____ ENGR JOB CLASS _____

Inventory

Water source _____ Amount available _____ ft³/sec _____ gpm _____ acre-ft Seasonal variation _____

Power source: Electric _____ volts, _____ phase; Internal combustion engine _____ fuel type; Other _____

Soils Data

Design Soil Series	Available water capacity, AWC (in/ft depth)					Depth to ¹		Sprinkler intake rate (in/hr)
	0-1	1-2	2-3	3-4	4-5	Inhibiting layer (ft)	Water table (ft)	

¹ Actual observed depth in the field.

Crop Evapotranspiration (Monthly)

Crops	Acres	Month		Month		Month	
		Depth (in)	Volume (ac-in)	Depth (in)	Volume (ac-in)	Depth (in)	Volume (ac-in)
Totals (1)		(2)		(3)		(4)	

Crop Weighted Evapotranspiration (Monthly) (Note: Maximum Monthly Total ET is greatest of nos. 2, 3, or 4 above)

ET, depth = $\frac{\text{Maximum Total Monthly ET, ac-in/mo}}{\text{Total Acres, A (1)}}$ = _____ in /mo

Irrigation Requirements

Crops	Root zone depth ² (ft)	Total AWC (in)	Management allowed depletion (%)	Max Net replacement (in)	Peak daily ET (in)	Max freq @ peak E T @ max net (days)

² Use weighted peak monthly ET and net irrigation to determine weighted peak daily E T.

Exhibit 6-1 Sprinkler irrigation system planning/design worksheet—Continued

U.S. Department of Agriculture
Natural Resources Conservation Service

Page 2 of 5

Sprinkler Irrigation System Planning/Design Worksheet—Continued

NAME _____ DATE _____ PREPARED BY _____

Design Data — (Based on weighted crop ET, _____ % irrigation efficiency)

	Application		Weighted ² peak daily crop ET (in)	Frequency, F (days)	System requirements	
	Net, D (in)	Gross F _g (in)			Total gpm, Q	gpm/ac

² Use weighted peak monthly ET and net irrigation to determine weighted peak daily E T.

Q = system requirements—gpm
H = Total operating hours/day
(suggest using 23 hours for one move per day)
(suggest using 22 hours for two moves per day)

$$Q = \frac{453 A D}{F H \text{ Eff}/100} = \text{_____ gpm} = \text{_____ gpm}$$

Sprinkler head spacing, (S_L) _____ ft, Lateral spacing on mainline (S_M) _____ ft, Minimum Required wetted diameter = _____ ft

Sprinkler head: make _____; model _____; nozzle size _____; lb/in² _____ gpm _____; wetted dia _____ ft

Application rate _____ in/hr, Application time _____ hr/set. Net application = (_____ in/hr) (_____ eff) (_____ hr/set) = _____ in

Maximum irrigation cycle = Net application _____ in/peak ET in/d = _____ days

Minimum number of laterals = _____ number of lateral sites _____
(irrigation frequency, _____ days) (moves/day, _____)

Designed laterals: Number _____, Diameter _____ in, Type _____, Moves/day _____

Total number of sprinkler heads = (number of laterals) (number of heads/lateral) = _____

System capacity = (Total number of sprinkler heads _____) (gpm/head _____) = _____ gpm

Lateral design

Allowable pressure difference along lateral = 0.2 (sprinkler head operating pressure in lb/in²) = _____ lb/in²

Actual head loss (worst condition) _____ lb/in²

Pressure required at mainline: P = (sprinkler head lb/in² _____) + (0.75) (Lateral friction lb/in² _____) +/- (ft elev) / (2) (2.31) = _____ lb/in²

(plus for uphill flow in lateral, minus for downhill flow). Use sprinkler head lb/in² only if elevation difference along lateral is = or > 0.75 (lateral friction loss lb/in²)

(2.31). Under this condition, flow regulation may be required at some sprinkler heads to maintain proper sprinkler head operating near the mainline.

Exhibit 6-1 Sprinkler irrigation system planning/design worksheet—Continued

U.S. Department of Agriculture

Natural Resources Conservation Service

Page 3 of 5

Sprinkler Irrigation System Planning/Design Worksheet—Continued

NAME _____ DATE _____ PREPARED BY _____

Mainline Design

Mainline material _____ (IPS, PIP, SDR, CLASS) lb/in² rating _____, other description, _____

Friction factor used _____. Formula (check one) Hazen-Williams Manning's Darcy-Weibach Other (name) _____

Station		Diameter pipe (in)	Flow (gpm)	Velocity (fps)	Distance (ft)	Friction loss (ft/100 ft)	Friction loss this section (ft)	Accumulated friction loss (ft)	Remarks
From	To								

NOTE: desirable velocities—5 ft/sec or less in mainlines, 7 ft/sec or less in sprinkler laterals.

Determination of Total Dynamic Head (TDH)

Pressure required at main _____ lb/in² _____ ft

Friction loss in main _____ lb/in² _____ ft

Elevation raise/fall in main _____ lb/in² _____ ft (2.31 feet = 1 psi pressure)

Lift (water surface to pump) _____ lb/in² _____ ft

Column friction loss _____ lb/in² _____ ft

Miscellaneous loss _____ lb/in² _____ ft

Total (TDH) _____ lb/in² _____ ft (NOTE: TDH must be in feet for horsepower equation)

Approximate brake horsepower = $\frac{\text{TDH (ft)} \times \text{Q (gpm)}}{3960 \times \text{Eff} / 100}$ = $\frac{\text{_____ ft} \times \text{_____ gpm}}{3960 \times \text{_____ \%} / 100}$ = _____ HP

Mean sea level elevation of pump _____ ft (NOTE: check required versus available NPSL for centrifugal pumps)

Pump curve data attached yes no , If not, pumping plant efficiency assumed = _____% (recommended using 65-75%)

Bill of materials attached yes no

Exhibit 6-1 Sprinkler irrigation system planning/design worksheet—Continued

U.S. Department of Agriculture
Natural Resources Conservation Service

Page 4 of 5

Sprinkler Irrigation System Planning/Design Worksheet—Continued

NAME _____ DATE _____ PREPARED BY _____

Other Design Considerations

Item	Evaluation performed	NOT needed	Location	Size
Measuring device				
Expansion couplers				
Reducers				
Enlargers (expanders)				
Manifolds				
Bends & elbows				
Tees				
Valved outlets				
Surge facilities (valves, chambers)				
Control valves				
Check non-return flow valves				
Pressure relief valves				
Air-vacuum valves				
Drain facilities				
Thrust blocks				
Anchors				
Pipe supports				
Other				

Remarks _____

Special drawing(s) attached _____

Irrigation system design by _____ Date _____

Reviewed and approved by _____ Date _____

Exhibit 6-1 Sprinkler irrigation system planning/design worksheet—Continued

U.S. Department of Agriculture Natural Resources Conservation Service		Page 5 of 5		
Sprinkler Irrigation System Planning/Design Worksheet—Continued				
NAME _____ DATE _____ PREPARED BY _____				
<hr/>				
Irrigation System Location and Layout Map				
<p>SHOW:</p> <input type="checkbox"/> Area irrigated with sprinklers <input type="checkbox"/> Direction of prevailing wind <input type="checkbox"/> Elevations, contours <input type="checkbox"/> High and low points <input type="checkbox"/> Water source and pump location <input type="checkbox"/> Mainline and submain locations <input type="checkbox"/> Layout: lateral(s), travelers, guns <input type="checkbox"/> Direction of move <input type="checkbox"/> North arrow				
Scale	Community	Section	Township	Range

(c) Fixed-solid set sprinkler irrigation systems

A fixed or solid set sprinkler irrigation system has enough pipe and sprinkler heads that none of the laterals need to be moved to complete an irrigation once in place. Laterals can be either permanently buried or portable pipe laid on the ground surface. To irrigate the field, one or more blocks (sections) of sprinklers are cycled on and off with a control valve at the mainline. Opening and closing of valves can be manual, programmed electronically, or timer clock controlled. A solid set sprinkler system can be easily automated. Application efficiencies can be 60 to 85 percent depending on design and management.

In addition to applying irrigation water, these systems are used to apply water for environmental control, such as frost protection, crop cooling, humidity control, bud delay, crop quality improvement, dust control, and chemical application. See NEH, Part 623, Chapter 2, Irrigation Water Requirements, and section 652.0605, State supplement, for detailed discussion of auxiliary water use.

(1) Planning and design considerations

Solid set portable laterals—Solid set portable lateral systems are generally used for high value crops, such as nurseries, vegetables, or turf production, where the system can be moved from the field before harvest. However, they also can be used with permanent crops, such as orchards and berries, where the portable laterals can be left in the field. This type of system is sometimes used to germinate crops, such as lettuce, which will later be furrow irrigated.

Advantages:

- Reduced labor requirements because the pipe does not need to be moved while in the field.
- Allows light applications at frequent intervals.

Disadvantages:

- High cost of needing sufficient lateral pipe and sprinklers to cover the entire field.
- Can cause inconvenience for cultivation or other cultural operations.
- Tall sprinkler risers need support, protection, or both.

With portable mainline(s), control valves are typically operated manually. Renting a portable solid set system for limited use (crop establishment, crop cooling, specialty crops) can be more economical than ownership.

Solid set permanent laterals—This sprinkler irrigation system is similar to the portable system except both mainline(s) and laterals are generally buried below the depth of normal field operations. Sprinkler lateral flow can be sequenced manually or automatically by various timer activated electric solenoid valves. With annual crops, the risers are installed outside of any tillage operations. This system is most adapted to permanent crops, such as orchards, grapes, cranberries, cane berries, turf for landscaping, and golf courses. Solid set systems can be used on annual crops, alfalfa, or pasture. However, caution must be exercised during tillage or harvest operations to prevent damage to risers and sprinkler heads. Risers must also be protected from livestock.

(2) Design procedures

Design of solid set systems is similar to periodic move systems. The only difference is that each lateral is individually designed. Sizes can be effectively reduced toward the end of the lateral as flow decreases. Blocks of laterals are then tied together using submains to create operating blocks or units and minimize the number of control valves. Individual sprinkler heads and spacing are designed to fit soil, crop, desired application rates and amounts, local wind conditions, and management available. Figure 6–9 displays a solid set system layout.

With orchards and vineyards, tall risers can be used to provide overhead irrigation. Quick couplings are available for lowering sprinkler heads for maintenance and replacement. Minimum distribution uniformity standards at ground level typically cannot be met when sprinkle irrigating fruit and nut orchards, citrus groves, banana plantations, vineyards, cane berries, and tall bush berries from either overhead or ground level located sprinkler heads. However, minimum distribution uniformity standards still apply for design and operation purposes. Lateral movement of soil water is desirable and necessary in some soils to prevent dry spots in root development areas. In arid and semiarid areas, development of the support root system for trees and vines will only be in areas of

adequate soil moisture. Overhead systems are preferred for climate control systems, although recent research has shown some degree of protection can be obtained from undertree sprinklers.

A diamond or triangular pattern for sprinkler head layout is recommended for solid set systems, thereby improving application uniformity. Adequate (typically 50%) overlapping patterns from adjacent sprinkler nozzles are essential for temperature modification systems and those used for shallow rooted annual crops regardless of sprinkler head layout. Deep rooted perennial crops like trees, blueberries, and vines tolerate less application uniformity.

(d) Continuous (self) move sprinkler irrigation systems

(1) Center pivot sprinkler irrigation system

A center pivot sprinkler irrigation system consists of a continuously moving, horizontal rotating single lateral supported by towers and anchored at a fixed pivot point at the center of the field. This system irrigates a circular field unless end guns and swing lines are cycled in corner areas to irrigate more of a square field. The commonly used term, *continuous move*, is not totally accurate because the end tower moves at an adjustable time controlled start-stop operation. Intermediate towers start and stop to maintain alignment.

Figure 6-9 Solid set sprinkler system layout

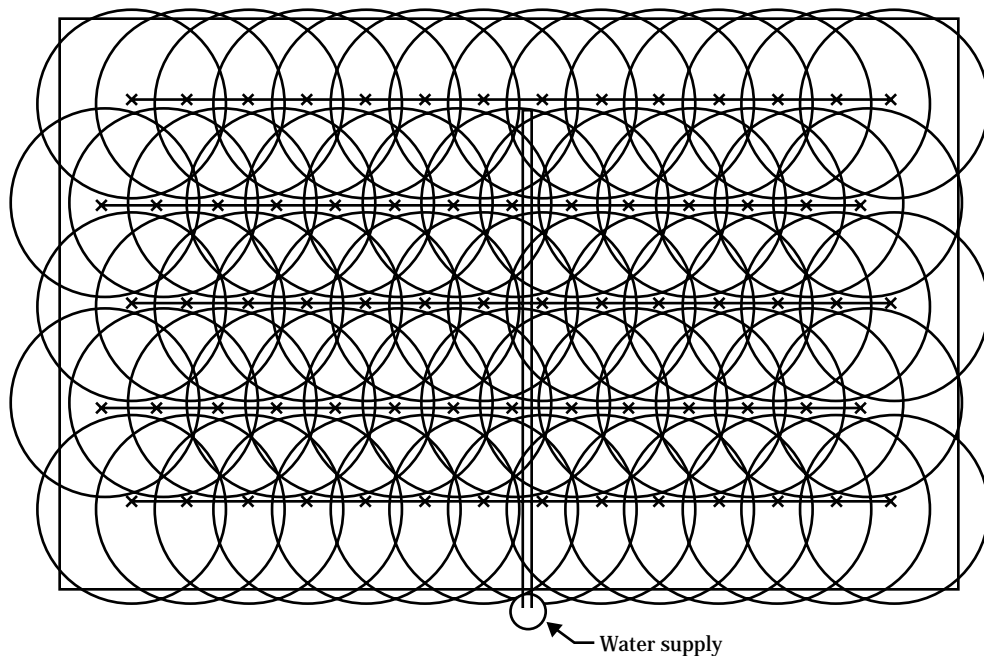

Various operating pressures and configurations of sprinkler heads or nozzles (types and spacing) are located along the lateral. Sprinkler heads with nozzles may be high or low pressure impact, gear driven, or one of many low pressure spray heads. A higher discharge, part circle, sprinkler head generally is used at the extreme end of the lateral to irrigate the outer fringe of the lateral. Typically, 25 percent of lateral maintenance is spent maintaining this end gun. Each tower, which is generally mounted on rubber tires, has a power device designed to propel the system around the pivot point. The most common power units include electric motor drive, hydraulic water drive, and hydraulic oil drive.

The towers are spaced from 80 to 250 feet apart (span), and lateral lengths vary up to 2,600 feet (0.5 mile). Long spans require a substantial truss or cable system to support the lateral pipe in place. The most common lateral length is 1,320 feet, which covers about 125 to 140 acres per 160-acre field (quarter section). With proper management, application efficiencies can be 75 to 90 percent, depending on wind speed and direction, sprinkler type, operating pressure, and tillage practices.

Use of the center pivot has grown rapidly since it was first developed. Many improvements have been made. For example, some models now contain an added swing lateral unit (corner system) that expands to reach the corners of a field and retracts to a trailing position when the system is along the field edge. The corner system unit operates only in the corners. When the corner unit starts up, discharge flow in all other heads is reduced and overall field distribution uniformity is affected. These systems cover nearly 150 to 155 acres of a square 160-acre (quarter section) field. Typically 85 percent of maintenance is spent maintaining the swing lateral corner unit itself. Typically, less than adequate maintenance results in corner systems operating all the time. Total field application uniformity is reduced even further.

Many techniques have been developed to reduce energy used, lower system flow capacities, and maximize water use efficiency. They include using Low Energy Precision Application (LEPA) and Low Pressure In-Canopy (LPIC) systems. LEPA systems (precision application) require adequate (implemented) soil, water, and plant management. LPIC systems are used on lower value crops where localized water translocation is acceptable.

Advantages:

- Operating labor is reduced as compared to periodic move sprinkler systems. One individual can adequately handle 8 to 10 center pivot systems (1,000 to 1,500 acres)
- Main supply line requirements are minimized because a stationary delivery point is used.
- With good water management, relatively high water application uniformity is possible.
- With a full circle pivot, the lateral is at the starting point after one revolution.
- Because small amounts of water can be applied, it is relatively simple to maintain a high degree of water management.
- Light, frequent applications can be made.
- With adequate design and reasonably level land, systems with nozzle pressures as low as 10 pounds per square inch can be used.
- Chemical applications (chemigation) can be made through the system.
- With multiple fields, some pivot laterals can be towed to adjacent fields to be operated from several pivot points.
- Pivots can operate as part circle systems because they are capable of operating either forward or in reverse.

Limitations:

- Where the pivot point is in the center of a 160-acre field, only 125 to 140 acres are irrigated. This leaves up to 20 percent of the field nonirrigated unless special units, such as corner systems, are used to fill in the corners. Often corners are irrigated with portable laterals or solid set sprinkler systems. Graded furrow surface irrigation systems are also used for corners where soils are suitable, grades are uniform, and gated pipe is available.
- Application rates at the outer end of a low pressure center pivot lateral can be 30 to 50 inches per hour (in/hr) for periods of 10 to 15 minutes, depending on the length of the lateral and nozzle configuration. This can lead to translocation (or runoff) of applied water and erosion where adequate soil surface storage is not provided. When using sprinkler heads discharging large droplet sizes, soil surface compaction may increase towards the outer edge of the circle. The longer the pivot lateral and smaller the wetted diameter of each sprinkler or spray head, the greater the application rate.

- Light, frequent irrigations help minimize translocation and runoff, especially with low pressure systems. This increases potential water evaporation losses and may not be ideal for crops grown or water supply and system management. The irrigator must manage soil moisture more intensely throughout the season than with other systems. Otherwise, soil moisture shortages can occur.
- Because this system is relatively expensive compared to other irrigation systems, center pivot systems are often designed to barely meet, or even fall short of meeting, peak daily crop water use. Unless the system is designed to fully meet peak daily use, it generally cannot keep up in extended periods of extremely hot and dry conditions during maximum crop water use. An irrigation system should never be designed to depend on adequate rainfall to occur during the irrigation period unless the producer adequately understands and fully accepts the risks involved. If the producer accepts these risks, that a statement in writing may be obtained to forestall future litigation.
- With the radial distance from the pivot point, such concentric band includes a larger irrigated area. Thus, the most water must be carried toward the outer end of the lateral. This results in lower pressures at the end of the lateral and higher friction losses along the pipe, which translates into higher pumping costs when compared to a linear move sprinkle irrigation system or other sprinkler irrigation systems.
- When a large end gun or corner system is used for the corners, a booster pump at the end of the lateral is typically used. When the booster pump to supply water to the large end guns and corner systems comes on, all other sprinkler heads throughout the length of the pivot lateral have less discharge. Overall field distribution uniformity is affected.
- Maintenance costs of center pivot laterals with corner systems is high, compared to standard pivot systems.

Planning and design considerations:

An irrigation equipment dealer can use a computer program provided by each center pivot system manufacturer to perform a detailed design specific for that make and model of pivot. Because sprinkler pipe size and head spacing combinations are unique for each

manufacturer, this is the only way accurate, detailed designs can be prepared. The farmer is generally provided with a detailed copy of the design and nozzle configuration. Evaluating this information (including the nozzling package) is always the first step when providing a detailed field evaluation on a specific pivot system.

As a service to a cooperator, NRCS can review pivot designs prepared by others to assure the proposed application provides adequate water to satisfy the needs of the crop(s) and match the available water capacity of the soil, and that it does not have negative impacts on field or farm resources (soil, water, air, plants, animals, and human considerations) including soil erosion, offsite sedimentation, and pollution of surface and ground water. The planning technician can provide daily crop water use and soil resource information, including limitations, to the irrigation decisionmaker for use by the designer.

Each pivot system manufacturer has a selection of carefully designed packages from which to select. Each package has certain application characteristics. The planning technician must be able to supply the land user with information on desirable characteristics so that the user can work with the dealer to select an optimum system package for the field. NRCS personnel, irrigation dealers, manufacturers, and the user need to work together as a team to get the best system for onsite conditions installed and properly operated.

Resource site and system features that should be provided include:

- Maximum and normal irrigation water requirements of the crop(s).
- Intake rate or maximum application rate for the most limiting or restrictive soil, tillage practices, and available surface storage.
- Translocation, runoff, and erosion potential.
- Suitability of crop for irrigation method and system.
- Available water capacity of limiting soil.
- Actual crop rooting depth(s).
- Irrigation decisionmaker management skill and labor required.

Maximum application rate for a pivot takes place in the area between the outer two tower assemblies. The application rate typically ranges from 2 to more than 50 inches per hour. **The application rate is depen-**

dent on type of sprinkler heads, width of spray pattern, system capacity, and distance from the pivot point. Application rate is constant for a specific point regardless of lateral rotation speed. Application volume (depth) is totally independent on the lateral rotation speed. The narrower the width of spray pattern, the higher the application rate. Low pressure spray heads typically have a narrow width of spray pattern. Because of this narrow spray pattern, LEPA and LPIC systems can have application rates exceeding 30 to 50 inches per hour for short time periods.

Sprinkler nozzles on continuously moving lateral systems apply water in a stationary pattern similar to an ellipse. Application rates at a point a given distance perpendicular to the pivot lateral begin at zero until droplets begin impacting. They reach a maximum when the center of the sprinkler head (lateral) is directly above the point, and decrease again to zero when the trailing edge of the application pattern passes the point. The depth applied at the given point is represented by the area under the application rate versus time curve. To achieve a uniform depth of

application over the entire area of the circle (field), application rates must increase as the distance from the pivot point increases. Elapsed time of application decreases.

As can be seen in figure 6–10, intake characteristics of a soil are a function of rate over time. When application rates are greater than the soil intake rate curve, a potential for translocation or runoff occurs unless soil surface storage is provided. For a given application amount, the wider the wetted sprinkler pattern, the less the application rate. Narrower (typically lower pressure) wetted sprinkler pattern sprinkler nozzles provide greater application rates. Table 6–5 displays typical wetted patterns and operating pressures of various sprinkler heads on center pivot systems.

The speed of lateral rotation normally varies from 12 to 120 hours per revolution. With a center pivot system, the application rate (in/hr) at any one location is the same, regardless of the speed of rotation. However, the greater the lateral speed the less total water is applied in a given area for a given rotation. The speed (typically designated as percentage of the time

Figure 6–10 Typical soil intake and sprinkler application rate curves

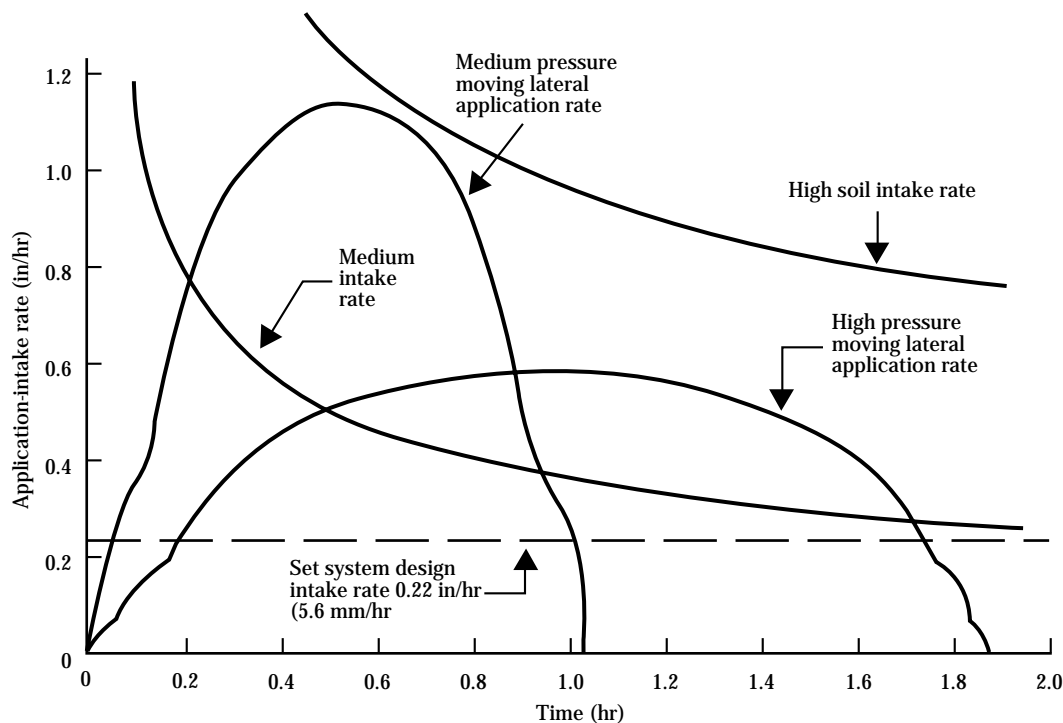

moving) of a center pivot system generally is controlled by the end tower, called the master or control tower. A system of alignment controls keeps the other towers in line with the master tower. To maintain alignment, the towers are continually in start-stop operation. If a tower gets stuck and cannot move, the system shuts down (if automatic system shutoff is functioning).

With a properly designed, maintained, and managed center pivot system, water application depth is relatively uniform over the length of the lateral after several rotations. The start-stop characteristics of the system can cause nonuniformity in a small area on one rotation. With additional rotations, nonuniformity due to start-stop action of individual towers is minimized. Overall system maintenance is important. Clogged sprinklers, improperly functioning flow regulators, and improper system pressures quickly degrade uniformity of application. Applicator maintenance is most important towards the outer end of the lateral because of the large area covered by only a few nozzles.

Figure 6–11 shows percent of total area of application versus radius for a quarter-mile-long lateral.

Occasionally, pivots up to a half mile long are installed. These pivots have very high application rates in the outer quarter to third of the irrigated area and can work properly only under certain conditions. Most important of these conditions are:

- Topography must be flat enough to allow high application rates at the outer part of the circle without significant translocation, runoff, and erosion.
- Soil must have a relatively high intake rate.
- Soil surface storage (surface roughness).
- Crops that can be established under high application rates are grown.
- Cultural practices that promote surface residue utilization for improved soil condition and surface storage, such as pitting, are implemented and maintained throughout the irrigation season.

Table 6-5 Typical operating pressures and wetted diameter patterns

System	Operating pressure (lb/in ²)	Wetted diameter (ft)
Heads mounted on top of lateral pipe		
High pressure impact	75 +	160
Medium pressure impact	50 - 75	100 - 130
Low pressure impact	35 - 50	40 - 100
360-degree spray, low pressure	20 - 35	20 - 40
180-degree spray, low pressure	20 - 35	10 - 20
Rotating spray	15 - 50	up to 70
Spray booms, low pressure	20 - 35	120
Heads mounted on drop tubes		
Fixed spray, low pressure	20 - 35	20 - 40
Rotating spray	15 - 50	up to 60
LPIC application devices ^{1/}	5 - 10	5 - 15
LEPA application devices ^{2/}	2 - 10	2 - 5

^{1/} LPIC = Low Pressure In Canopy
^{2/} LEPA = Low Energy Precision Application

Figure 6-11 Application area along a quarter-mile-long pivot system lateral

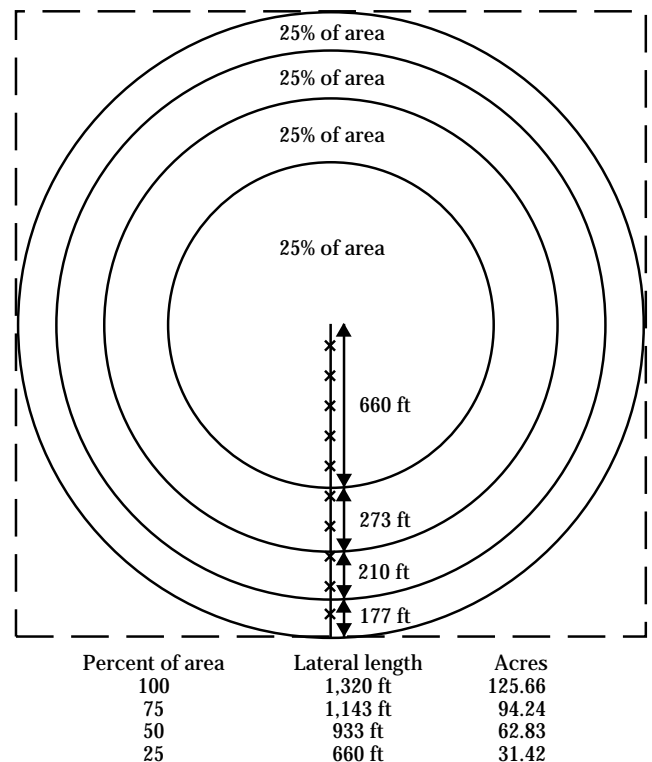

Many combinations of application devices, flow regulators, applicator spacing, lateral pipe sizes, tower spacing, operating pressures, application rates and spray characteristics exist. Drop tubes that have low pressure spray heads located a few inches above the ground surface or canopy are often used instead of sprinkler heads attached directly to the lateral. Drop tubes and lower pressure (larger droplets) reduce wind and evaporation losses.

Center pivot systems can be operated as either high or low pressure systems. Low pressure systems are becoming more desirable because of reduced energy use. Where pressure (flow) regulators are not required, pressures of 5 to 10 pounds per square inch in the lateral are used for Low Energy Precision Application (LEPA) and Low Pressure In Canopy (LPIC) systems. Center pivots used as LEPA and LPIC require temporary soil surface storage because of very high application rates; otherwise, surface water translocation and runoff occur. Temporary surface storage, plus infiltration during the application period, must be capable of storing the planned application amount per irrigation. Surface storage can be provided with surface residue, soil roughness, or small basins. Adequate soil surface storage must be available throughout the irrigation season.

Some center pivot systems use a large partial circle, hydraulic-revolving gun type sprinkler at the end of the lateral line. This sprinkler extends the irrigated diameter of the pivot to help fill in corners of the field. The area covered by the gun seldom receives as much water as the remainder of the field. Generally, this is the area producing the poorest yields. Typically over 75 percent of total maintenance is required by the end gun.

A total system economic analysis of inputs and outputs needs to be made to determine whether increased crop yields from the irrigated area served by the end gun covers costs. Costs include lower total field water application uniformity, reduced water supply for the remainder of the field, increased tillage area, and increased labor to maintain the end gun.

Recommendations for reducing operational problems associated with center pivot sprinkler systems:

Crops can be planted in circular rows around the center pivot system rather than planting in straight rows. Circular planting results in 94 percent of the rows being longer than those in traditional fields. This type planting reduces wheel traction problems for the center pivot machine, increases irrigation uniformity, and can reduce runoff and soil erosion. A very light water application should be used to leave tire tracks as a guide for planting equipment. Always apply water when creating guide markings. Weight of water in the pipeline can extend the lateral length several feet compared to its empty lateral length.

Tower wheel rutting problems can be a severe operational problem where medium textured soils with poor structure become wet. As a rut deepens, it collects water and saturates the soil thus increasing the rutting problem. Erosion can occur in the ruts on sloping fields as a result of the concentrated flow. Using boom-backs to place the spray behind the tower helps to alleviate this problem.

Irrigation uniformity can be improved by smoothing the land under the center pivot system to remove any minor undulations and localized steep slopes. Best results are achieved using a cropping system that maintains crop residue at the ground surface. A no-till system of residue management is a desirable alternative.

Use furrow pitting and diking in the outer quarter of the irrigated area. Various machines can be used to make dikes or basins in the furrow area every few feet. Applied irrigation water and precipitation are stored to prevent translocation and runoff.

In arid and semiarid areas, pre-irrigation (irrigation before the soil is prepared for planting) may be a desirable management practice. The idea is to at least partly fill the root zone with moisture before working the soil and planting the crop. This helps create a deep root system and stores moisture for use during periods when the sprinkler system is unable to keep up with crop needs. Pre-irrigation is seldom needed in humid areas.

For maximum efficiency the system should move just fast enough to prevent excessive runoff.

Frequently, center pivot irrigation systems are operated at too high speed. Experience has shown frequent irrigation often seals the soil, reduces water infiltration, and increases evaporation. Excessive speed also causes unnecessary wear and tear on the equipment. In arid areas 0.25 to 0.50 inch of the application amount can be lost to soil and plant evaporation with each revolution. Thus when water supplies are short or become short, consider sacrificing part of the crop area and slowing the pivot to apply more water with each rotation. Eliminating irrigation on part of the circle for the latter part of the season may be more beneficial and provide a higher quality product on the fully irrigated portion.

Deep chiseling or ripping may be beneficial to remove root and water restrictive tillage pans and temporarily increase soil intake rate (particularly on clay loam soil). This is an expensive field operation, and unless the cause of compaction is corrected, the operation must be repeated. Heavy equipment, tillage when wet, excess tillage, or poor soil condition often cause tillage pans to reoccur.

Design procedures:

The hydraulic design of a center pivot sprinkler system is complex. Today, most systems are designed using one of several computer programs usually by the company proposing to do the installation. The following equation can be used for guidance to determine if maximum application rates and depths of water applied by center pivot sprinklers are in accordance with NRCS standards. NEH, Part 623 (Section 15), Chapter 11, Sprinkle Irrigation, reviews detailed design procedures.

Given:

- R = 1,350 ft
- d' = 0.3 in
- T = 24 hr/d
- Area = 131.4 acres

System capacity:

$$Q = \frac{453 A d'}{T} = \frac{453 \times 131.4 \times 0.3}{24} = 744 \text{ gpm}$$

where:

- Q = system capacity (gpm)
- A = area irrigated (acres)
- T = actual operating time (hr/d)
- d' = daily gross depth of application required during peak use rate period (in)
- R = maximum radius irrigated (ft). Also include length of corner system if applicable

Application rate:

As a moving lateral sprinkler system moves across a point in the field, the application rate varies from zero to maximum and returns to zero. With center pivots, both the average application rate and the maximum application rate increases the further the point in the field is located from the pivot. To calculate the average and maximum application rate along a center pivot lateral, the total lateral capacity and radius can be used. Equations are provided as follows:

$$I = \frac{2(96.3)rQ}{R^2 w} \quad \text{or} \quad I_x = \frac{245rQ}{R^2 w}$$

where:

- I = average application rate at point r (in/hr)
- Q = system capacity (gpm)
- r = radius from center of pivot to point under study (ft)
- w = wetted width of sprinkler pattern (ft)
- R = maximum radius irrigated (ft)
- I_x = maximum application rate at any point r (in/hr) (assuming elliptical application pattern of sprinkler head with a multiplier of 4/π)

Where r, R, Q, and w are held constant:

$$I_x = 1.25 I$$

(2) Low energy precision application (LEPA) systems

LEPA is a low energy precision water application system that supplies water at the point of use. This system combines a self moving mechanical device (center pivot or linear move) along with water and soil management to produce retention and efficient use of all water received (precipitation and irrigation). The soil surface and residue management provide adequate water infiltration and temporary surface water storage. The LEPA management program provides near zero water translocation or runoff.

Advantages:

- The LEPA method of distributing water is a relatively new total management systems approach to pivot and linear system irrigation. The only association with a center pivot and linear sprinkler systems is with the actual mechanical system itself. LEPA systems distribute water directly onto or very near the ground surface, below the crop canopy through drop tubes fitted with low pressure (5 to 10 lb/in²) application devices. Because system operating pressures are low, pumping energy is reduced compared to standard systems.
- Lower system capacities per unit area are generally used for LEPA as compared to conventional surface and sprinkle systems. This method of applying water close to the ground surface essentially eliminates wind drift and evaporation losses especially after the crop has gotten taller than 18 inches. With adequate soil (tillage and residue) management, translocation and field runoff are eliminated. Practically all losses result from deep percolation below the crop root zone. These losses can be minimized if the irrigation decisionmaker follows an adequate program of irrigation scheduling. Application efficiencies of 95 percent and an application device discharge coefficient uniformity of more than 96 percent should be the objectives of the irrigation decisionmaker. The concept of precision irrigation should prevail with operation and management of LEPA systems.

Limitations:

LEPA is generally used on field slopes of 1 percent or less on a significant portion of the field. Planned maximum water application depth per irrigation or precipitation event should not exceed soil surface storage volume less infiltration during the event. Application rates exceeding 30 inches per hour, for short periods of time, have been measured on the outer end of low pressure center pivot laterals. LEPA requires cultural and residue management practices that provide adequate season-long soil surface storage. Basins constructed with furrow pitting or diking equipment is required, especially on low and medium intake soils. The small basins hold irrigation and precipitation until total infiltration occurs, thus eliminating runoff and improving water distribution uniformity.

Planning and design considerations:

LEPA systems must be capable of conveying and discharging water within a single furrow area. Water is typically confined between two adjacent crop rows. The application device is typically attached to the end of drop tubes that are located or positioned in either every furrow or in alternate furrows. Discharge devices must place water near or directly onto the soil surface. For precision application of irrigation water using LEPA systems, circular rows must be used with center pivots and straight rows with linear systems. Application devices should distribute and confine the water to the furrow area without eroding furrow dikes or crop beds. To optimize water placement, planting should be done to match the travel pattern and location of the drop tube applicators.

Minimum system capacity should be based on local crop ET needs for crops grown in the crop rotation, accounting for the available water capacity of specific soils in the field.

Some minor land grading may be needed to remove localized high and low areas in the field to provide uniform application device heights above the soil surface between towers. Spacing and location of drop tubes must coincide with crop row spacing. Water must not be applied into the tower track. Cross flow from adjacent furrows to the wheel track should also be avoided.

LEPA application devices should contain flow control devices or pressure regulators, or both, where needed. Application devices are normally convertible to at least two of the following modes: bubble, flat spray, chemigation, and drag sock. The application device should distribute the water within or across the furrow width without causing erosion of the crop bed, dams, and dikes, and thus diminishing soil surface storage.

Soil surface storage—The following provides field storage capacity and sizing of typical basins at 0 percent field slope:

Storage (in)	----- Basins ----- every row	alt row	Basin dimensions top width (in)	bot. width (in)	Dike space (in)	Row space (in)
2.0	x		18	6	60	36
1.0		x	18	6	60	60

(3) Low pressure in canopy (LPIC) systems

LPIC is a low energy, low pressure, center pivot or linear move water application system that applies water within the crop canopy near the ground surface. It is similar to low energy precision application (LEPA) systems, but does not have as restrictive site and water application conditions. LPIC irrigation systems typically have some local translocation of applied water, but no field runoff. In most areas local translocation is interpreted as having water on the soil surface no further than 30 feet ahead of or behind the lateral position. Good soil and water management are required to obtain potential application efficiencies in the high 80's.

Advantages:

- The LPIC method of distributing water within the crop canopy can be installed on soils and topography unsuitable for the LEPA management system. LPIC systems distribute water through drop tubes fitted with low pressure (5 to 10 lb/in²) application devices. Because system operating pressures are low, pumping energy is reduced compared to above canopy or high pressure center pivot and linear move systems.
- With good water and soil management and medium to coarse textured soils, LPIC irrigation systems have been successfully used on slopes up to 6 percent. Good soil condition and adequate soil surface storage for applied water (precipitation and irrigation) are essential. Terracing may be required to control rainfall and irrigation induced erosion on steeper slopes.
- Lower system capacities per unit area generally are used for LPIC as compared to above canopy sprinkle irrigation systems. In-canopy applications essentially eliminate wind drift and evaporation losses especially after the crop has grown taller than 18 inches. With proper water and soil management, application efficiencies of at least 85 percent can be obtained. Application device discharge coefficient uniformity can be more than 90 percent.

Limitations:

- LPIC is generally used with field slopes of 3 percent or less on a significant portion of the field. Maximum application depth per irrigation or precipitation event should not exceed soil surface storage less infiltration during the event. Excellent soil condition and surface storage

must be maintained throughout the irrigation season. Application rates in excess of 30 inches per hour, for short periods of time, have been measured at the outer end of low pressure center pivot laterals.

- Even with proper water and soil management, LPIC irrigation systems generally are not suitable for use on low intake soils.
- Maintaining dikes or basins is difficult on soil slopes greater than 3 percent.
- Terraces may be needed to prevent erosion on slopes greater than 2 percent.

Planning and design considerations:

Low pressure in canopy (LPIC) systems must be capable of applying water without significant translocation or field runoff. Application devices on drop tubes can be spaced from 2 to 10 feet. Experience has shown crop yields are adversely affected because of poor application uniformity when using a wider spacing. Nonuniformity exists with any drop tube spacing greater than every other row. Many irrigation decision-makers feel reducing the initial investment by using a wider application device (and drop tube) spacing is justified.

Application devices should deliver water to the furrow area without eroding furrow dikes, dams, or crop beds. Planting orientation should match the travel pattern or direction of lateral movement. A very light water application can be used to leave tire tracks to guide planting equipment. Always apply water when creating guide markings. Weight of water in the lateral pipeline can extend the length several feet.

Minimum system capacity should be based on local crop ET needs for crops grown in the crop rotation, accounting for the available water capacity for specific soils in the field.

Some minor land grading may be needed to remove small high and low areas in the field to provide a near uniform application device height above the soil surface between lateral towers. Spacing and location of drop tubes need to coincide with crop row spacing and the location of the rows within the lateral span of the mechanical irrigation system. Water should not be applied into the tire track. Cross flow from adjacent furrows to the wheel track should also be avoided.

LPIC application devices should contain flow control devices or pressure regulators, or both, where needed. Application devices are normally operated in the flat spray mode. These devices should distribute water uniformly across the soil surface without excessive crop interference. The LPIC system is used for center pivot and linear move laterals. LPIC is a low pressure within canopy system. It is similar to LEPA, but does not have the site and application restrictions. It may not have the precision application required of LEPA and is more likely to have translocation and erosion problems.

(4) Linear (lateral) move sprinkler irrigation systems

A linear move sprinkle irrigation system is a continuous, self-moving, straight lateral that irrigates a rectangular field. The commonly used term, continuous move, is not totally accurate because the lateral moves in a timed start-stop operation. The system is similar to the center pivot lateral in that the lateral pipe is supported by trusses, cables, and towers mounted on wheels. A linear move sprinkle irrigation system is similar to a side roll wheel line system because it irrigates a rectangular field with uniform sized nozzles and spacing throughout the length of the lateral.

Most linear systems are driven by electric motors located in each tower. A self-aligning system is used to maintain near straight line uniform travel. One tower is the master control tower for the lateral where the speed is set, and all other towers operate in start-stop mode to maintain alignment. A small cable mounted 12 to 18 inches above the ground surface along one edge or the center of the field guides the master control tower across the field.

Linear move systems can be equipped with a variety of sprinkler or spray heads. Drop tubes and low pressure spray heads located a few inches above ground surface or crop canopy can be used instead of sprinkler heads attached directly to the lateral. Both options reduce wind and evaporation losses.

Linear move systems can be operated as either high or low pressure systems. Low pressure systems are becoming common because of reduced energy use. Low pressures of 5 to 10 pounds per square inch (plus 4 pounds per square inch with pressure regulators) are used where linear systems are used as Low Energy Precision Application (LEPA) and Low Pressure In Canopy (LPIC) systems.

Where linear move systems are used as LEPA and LPIC, temporary soil surface storage is necessary to limit surface water translocation or runoff because of the high application rates. Temporary surface storage, plus infiltration during the application period, must be capable of receiving the application amount per irrigation. Surface storage can be provided with surface residue, small basins, or both. Surface storage must be available throughout the irrigation season. Application rates are medium to high.

Advantages:

The major advantage of linear move sprinkler irrigation systems is that all the field is irrigated. Application uniformity can be high because the laterals are nearly continuously moving. Because of the potential for high application uniformity and the ability to put on small amounts of water (at higher lateral speeds), several forms of chemigation are practical.

Limitations:

The major disadvantages of linear move sprinkle irrigation systems are high initial cost, high annual operating cost, and need to supply water to the moving lateral. Generally, this type system is used on medium to high value crops and for multiple crop production areas. Unlike center pivots, when laterals reach the edge of the field and irrigation is complete, the laterals must be moved. They are either moved back (dead headed) to the starting position or moved endwise to an adjacent field. When moving the lateral endwise, tower wheels must be rotated 90 degrees or be placed on individual tower dollies.

Planning and design considerations:

NEH, Part 623 (Section 15), Chapter 11, Sprinkle Irrigation, page 11–109, provides details concerning design. Manufacturers' technical data should be consulted for additional machine specific up-to-date information.

Field layout and water source delivery methods must be considered when planning and designing a linear move system. Figure 6–12 displays typical alternatives for field layout showing water source locations. Water can be supplied to the moving lateral system by using an engine driven centrifugal pump or by using pipe-lines and risers to move water under pressure.

An engine driven centrifugal pump mounted on board the master control tower can lift water from a concrete lined ditch and provide pressure to sprinklers on the moving lateral pipeline. The engine also runs a DC generator to provide power for tower drive motors. The ditch can be located anywhere in the field perpendicular to the lateral, but is generally located in the center of the field or along one edge. The ditch must be installed on a relatively flat grade to provide adequate water depth without overtopping. A moving end dam checks water moving in the concrete lined ditch and provides submergence over the pump suction pipeline inlet. A screen on the pump suction pipeline helps to prevent debris from entering the lateral.

Water under pressure can be supplied to the moving lateral irrigation system via a buried pipeline and risers. The pipeline must be located perpendicular to the moving lateral, typically in the center of the field or along one edge. Typically a flexible hose connects the moving lateral pipe to riser valves on the buried pipeline. Riser connect/disconnect can be manual or automated.

When operated manually, the system must be stopped with each mainline outlet (riser) change. Spacing of outlet risers is dependent on the length and size of hose the irrigator is able to drag from one outlet riser to the next. A small tractor can tow the hose, thereby allowing wider spacing of outlet risers. Slower lateral speeds and higher application amounts keep manual labor and the wear and tear on the hose to a minimum.

When riser connect/disconnect is automated, a powered valve opener proceeds the moving lateral dragging the supply hose in search of the next riser. If a riser is not found, the valve opener returns to the master tower and repeats the search process.

Upon locating a riser valve, the valve opener aligns itself over the riser, secures the valve body, and opens the valve. Water pressure in the forward supply hose signals a rear valve body and supply hose to disconnect. The rear powered valve body with supply hose moves towards the lateral, searching for the next riser. When secured, water pressure in the rear valve body and hose signals the forward valve body to

Figure 6-12 Typical field layout of linear systems

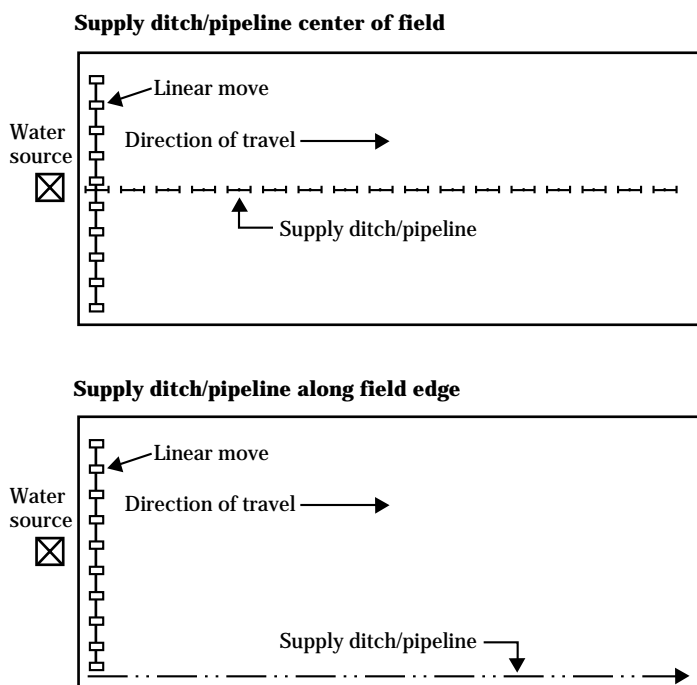

disconnect. The moving lateral proceeds down the field as water is supplied alternately by forward and rear valve connections.

(e) Traveling gun sprinkler irrigation systems

The traveling gun (traveler, gun, big gun) is a high-capacity, single-nozzle sprinkler fed with water from a flexible hose that is either dragged on the soil surface or wound on a reel. The gun is mounted on wheels and travels along a straight line while operating. The unit is equipped with a water piston or water turbine powered winch that reels in an anchored cable or hose. Some units have a small auxiliary gasoline engine to power the reel. This eliminates the water pressure required to operate the reel, and the hose speed is consistent. The cable guides the unit along a path and tows a high-pressure flexible hose connected to the water supply system. Figure 6-13 displays a typical traveling gun type system layout.

Application depth is regulated by the speed at which the hose or cable reel is operated or by the speed of a self-contained power unit. Traveling sprinklers are well adapted to odd shaped fields and to tall field crops, such as corn, if wetting adjacent areas is not a problem.

As the traveler moves along its path, the sprinkler wets a 200- to 400-foot-wide strip of land. After the unit reaches the end of a travel path, it is moved and set to water an adjacent strip of land. The overlap of adjacent strips depends on the distance between travel paths, diameter wetted by the sprinkler, average wind speed, and application pattern of the sprinkler used. The sprinkler is reset by towing it to the edge of the field.

Sprinkler discharge flows can range from 50 to more than 1,000 gallons per minute with nozzles ranging from 0.5 to 1.75 inches in diameter and operating pressure from 60 to more than 120 pounds per square inch. Table 6-6 displays typical discharges and wetted diameters for gun type sprinklers with 24 degree angle

Figure 6-13 Traveling gun type sprinkler system layout

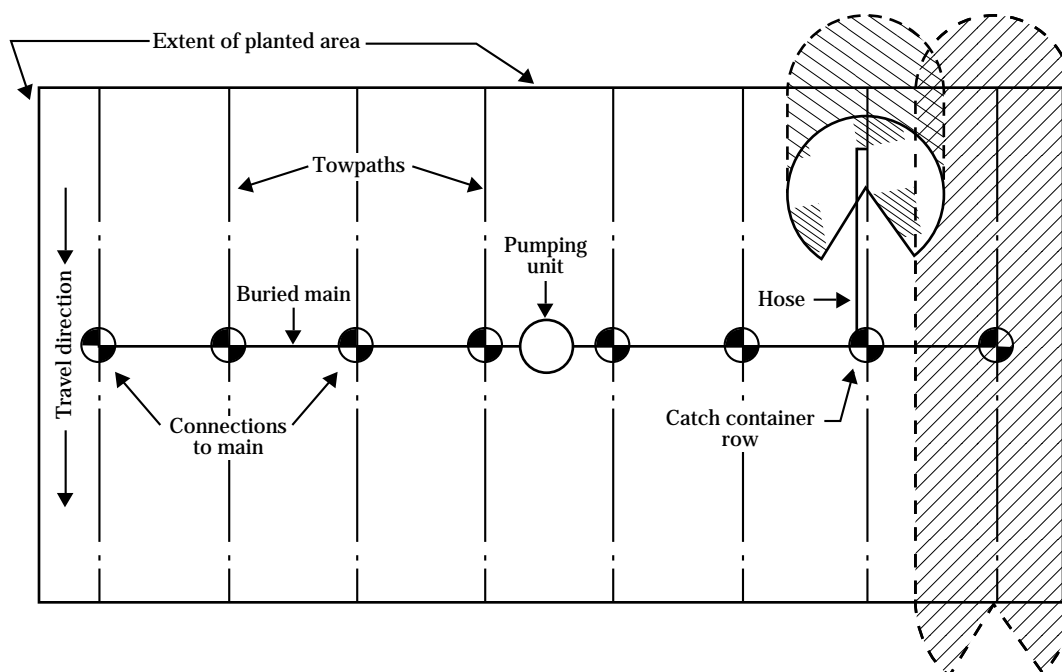

of trajectory and tapered nozzles operating when there is no wind. The three general types of traveling gun sprinklers are cable reel, hose reel, and self-powered/propelled.

Cable reel—The cable reel unit has a large gun type sprinkler mounted on a 4-wheel chassis equipped with a water piston or turbine-powered winch that reels in an anchored cable. The cable guides the unit along a path as it tows a high-pressure, flexible, lay-flat hose that is connected to the water supply system. The typical hose is 4 to 5 inches in diameter and up to 660 feet long. This allows the unit to travel up to 1,320 feet. After use, the hose can be drained and wound onto a reel.

Hose reel—The hose reel unit is equipped with a water turbine or gasoline auxiliary engine to power the hose reel. The hose reel can be located either at the sprinkler or at the water source (pipe outlet valve). When included with the sprinkler, a 4-wheel chassis carries the hose reel and sprinkler, which is pulled in by the hose attached to a water source (pipe outlet valve). The hose is usually flexible, reinforced, polyethylene material and is typically between 4 and 5 inches in diameter. Generally, the maximum hose length is 850 feet. This allows the unit to move 1,700 feet.

Self-powered/propelled—This unit has a self-contained pump and is self-propelled by drive wheels. A gun type sprinkler is mounted on top of the unit. The machine straddles a supply ditch and is guided by the ditch.

(1) Advantages

- Odd shaped fields can be irrigated with automated equipment.
- Manual labor is minimized.
- Suitable on sandy or high intake rate soils.
- Suitable for irrigating several different fields in a crop rotation.

(2) Limitations

- Traveling gun type sprinklers are not suitable on low intake rate soils or soils that tend to surface seal as a result of puddling.
- The turbines to power the winch and fittings on hose fed systems require additional water supply pressure. Because of the typical field size and the desire to keep costs down, it is tempting to reduce the flexible hose size for the length required. Decreased capital cost is a trade-off for increased energy cost. An energy cost analysis should be made. When possible, manufacturers' technical data should be used to make the analysis.

Table 6-6 Typical discharges and wetted diameters for gun type sprinklers with 24° angles of trajectory and tapered nozzles operating when there is no wind

Sprinkler pressure (lb/in ²)	Sprinkler discharge and wetted diameter tapered nozzle size (in)									
	0.8		1.0		1.2		1.4		1.6	
	gpm	ft	gpm	ft	gpm	ft	gpm	ft	gpm	ft
60	143	285	225	325	330	365	—	—	—	—
70	155	300	245	340	355	380	480	435	—	—
80	165	310	260	355	380	395	515	455	675	480
90	175	320	275	365	405	410	545	470	715	495
100	185	330	290	375	425	420	575	480	755	510
110	195	340	305	385	445	430	605	490	790	520
120	205	350	320	395	465	440	630	500	825	535

- To cast a droplet of water over 50 feet requires a droplet size greater than 0.25 inch to resist air friction. Well graded soils and soils low in organic matter are subject to puddling or surface compaction, thus further reducing soil intake rate and increasing potential translocation. Some crops may also be damaged by large droplet sizes.
- To adequately irrigate edges of the field, water is applied outside of the field boundaries.

(3) Planning and design considerations

Large gun type sprinklers require the highest pressures of any sprinkler system. In addition to the high operating pressure required at the sprinkler nozzle, hose losses can add another 20 to 40 pounds per square inch to the total system dynamic pressure head (TDH). Therefore, gun type sprinklers are well suited to supplemental irrigation where seasonal net irrigation requirements are small. This helps to mitigate the high power costs associated with high operating pressure. An energy cost evaluation should be made. Traveling gun sprinklers can be used where crops and irrigation needs are rotated from field to field. Table 6-7 displays friction loss in flexible pressure irrigation hose used on traveling gun type sprinklers.

Distribution uniformity is typically fair in the inner part of a 100- to 200-foot-wide strip; however, along the ends and sides it is poor. Typically, the ends and sides of the strip are inadequately irrigated. Application uniformity of large gun sprinklers is adversely affected by wind speeds of more than 5 miles per hour. A gun type system is not recommended in windy areas.

Power requirements to drag a hose depend on the size of hose, soil texture, soil moisture conditions, and crop. Pull energy requirement is greatest on wet, bare, sticky soils and less on wet vegetation or bare, sandy soils. On sticky soils the tow paths for the traveling unit and hose should be left in grass or other vegetation. Excessive wear to the hose can occur on soils containing sharp or abrasive rock fragments.

Guidelines for sizing traveling gun type sprinkler hoses are shown in table 6-8. Table 6-9 displays recommended maximum travel lane spacing as a function of wetted diameter and average wind speed. The gross depth of water applied for continuous moving large gun type sprinkler heads is given in table 6-10.

Table 6-7 Friction loss in flexible irrigation hose used on traveling gun type sprinkle system

Flow (gpm)	Friction Loss (lb/in ² /100 ft)				
	----- hose size (in) -----				
	2 1/2	3	3 1/2	4	4 1/2 5
	----- lb/in ² per 100 ft -----				
100	1.6	0.7	0.3		
150	3.4	1.4			
200	5.6	2.5	1.4	0.6	
250		3.6		0.9	
300		5.1	2.6	1.3	0.6
400			2.3	1.3	
500			3.5	2.1	
600				4.9	2.7 1.1
700				3.6	2.1
800					4.6 2.7
900					3.4
1000					4.2

Table 6-8 Guidelines for sizing traveling gun type sprinkler hoses

Flow range (gpm)	Hose diameter (in)
50 to 150	2.5
150 to 250	3.0
200 to 350	3.5
250 to 500	4.0
500 to 700	4.5
> 700	5.0

Table 6-9 Maximum travel lane spacing for traveling gun type sprinklers as a function of wetted diameter and wind speed

Wetted diameter	Wind speed (mi/hr)			
	> 10	5-10	0-5	0
	Percent of wetted diameter			
	50	60	70	80

Maximum travel lane spacing (feet)				
200	100	120	140	160
300	150	180	210	240
400	200	240	280	320
500	250	400	350	400
600	300	360	420	480

Table 6-10 Gross depth of water applied for continuous moving large gun type sprinkler heads ^{1/}

Sprinkler flow (gpm)	Spacing between travel lanes (ft)	Depth of water applied Travel speed (ft/min)							
		0.4	0.5	1	2	4	6	8	10
inches									
100	165	2.4	1.9	1.0	0.5	0.24	0.16	0.12	0.09
200	135	4.9	3.9	2.0	1.0	0.5	0.32	0.24	0.19
	200	4.0	3.2	1.6	0.8	0.4	0.27	0.2	0.16
300	200	6.0	4.8	2.4	1.2	0.6	0.4	0.3	0.24
	270	4.4	3.6	1.8	0.9	0.4	0.3	0.22	0.18
400	240	6.7	5.3	2.7	1.3	0.7	0.44	0.33	0.27
	300	5.3	4.3	2.1	1.1	0.5	0.36	0.27	0.21
500	270	7.4	6.0	3.0	1.5	0.7	0.5	0.37	0.29
	330	6.1	4.9	2.4	1.2	0.5	0.4	0.3	0.24
600	270	8.9	7.1	3.6	1.8	0.9	0.6	0.45	0.36
	330	7.3	5.8	2.9	1.5	0.7	0.5	0.36	0.29
700	270	10.4	8.3	4.2	2.1	1.0	0.7	0.5	0.42
	330	8.5	6.8	3.4	1.7	0.8	0.6	0.4	0.34
800	300	10.7	8.5	4.3	2.1	1.1	0.7	0.5	0.43
	360	8.9	7.1	3.6	1.8	0.9	0.6	0.4	0.36
900	300	12.0	9.6	4.8	2.4	1.2	0.8	0.6	0.5
	360	10.0	8.0	4.0	2.0	1.0	0.7	0.5	0.4
1000	330	12.2	9.7	4.9	2.4	1.2	0.8	0.6	0.5
	400	10.0	8.0	4.0	2.0	1.0	0.7	0.5	0.4

1/ (equation) average depth of water applied = 1,605 x (sprinkler flow, gpm) / (land spacing, ft) x (travel speed, ft/min)

(4) Design procedures

NEH, Section 623 (Section 15), Chapter 11, Sprinkle Irrigation, pages 11–84 to 11–89, provides a detailed explanation of design procedures and an example. This material should be used as a design guide. Applicable equations include:

Application rate:

Traveling sprinkler:

$$I_t = \frac{C Q}{R^2 \text{ Deg}}$$

where:

- I_t = approximate average application rate from traveling gun (in/hr)
- C = unit conversion constant = 13,624
- Q = gun discharge (gpm)
- R = wetted radius of nozzle (ft)
- Deg = portion of circle receiving water (degrees). Usually does not exceed 270°.

Stationary sprinkler:

$$I_t = \frac{C Q}{R^2}$$

where:

- I = approximate average application rate from a stationary large gun (in/hr)
- C = unit conversion constant = 30.7
- Q = gun discharge (gpm)
- R = wetted radius of nozzle (ft)

Application depth:

$$F_n = \frac{C Q \text{ Eff}}{W S}$$

where:

- F_n = net application depth (in)
- C = unit conversion constant = 1.605
- Q = gun discharge (gpm)
- Eff = estimated application efficiency (decimal)
- W = tow path spacing (ft)
- S = travel speed (ft/min)

(f) Traveling boom sprinkler irrigation systems

A traveling boom system is similar to a traveling gun system except a boom containing several nozzles is used. The boom can be moved by a self-contained, continuously moving power unit by dragging or coiling the water feed hose on a reel. The boom usually rotates, but may be fixed. A boom can be nearly 100 feet long with discharge nozzles spaced uniformly along the boom. Nozzle discharge patterns on the boom overlap one another. Back pressure from fixed nozzles rotates the boom.

Field tests indicate distribution uniformity for traveling boom sprinklers can be higher than traveling guns for the same diameter of coverage. A nonrotating boom can start and stop near the edge of a field, thereby providing adequate irrigation to these areas.

(1) Advantages

- Can be fabricated locally in any good farm machine shop.
- Can save labor after initial installation.

(2) Limitations

- High maintenance requirements.
- Lack of commercial dealers and support for replacement parts

(3) Planning and design considerations

Design of a traveling boom sprinkler system is similar to a traveling gun type system. Operating pressures are generally much less than for large gun type sprinklers. The edge and end effect is less than that for large gun type sprinklers because the wetted diameter of individual nozzles is much less. Local shop fabricated self-propelled booms can be effective and apply water efficiently on small farms growing high value specialty crops, such as berries, fresh vegetables, and melons.

652.0603 Micro irrigation systems

(a) General

Micro irrigation is the broad classification of frequent, low volume, low pressure application of water on or beneath the soil surface by drippers, drip emitters, spaghetti tube, subsurface or surface drip tube, basin bubblers, and spray or mini sprinkler systems. It is also referred to as drip or trickle irrigation.

Water is applied as discrete or continuous drops, tiny streams, or miniature spray through drip emitters or spray heads placed along a water delivery line called a lateral or feeder line. Typically, water is dispensed from a pipe distribution network under low pressure (5 to 20 lb/in²) in a predetermined pattern. The outlet device that controls water release is called an emitter. Water moves through the soil from the emission point to soil areas of higher water tension by both capillary and gravity forces. The amount of soil wetted depends on soil characteristics, length of irrigation period, emitter discharge, and number and spacing of emitters. Number and spacing of emitters are dependent on the spacing and size of plants being irrigated. If water management is adequate, line source emitters can be used for row crops. Micro irrigation can efficiently distribute an otherwise limited water supply.

With proper water management, application efficiencies for a well designed, installed, and maintained micro irrigation system can be in the range of 80 to 90 percent for the area irrigated. Without proper water management, they are typically 55 to 65 percent. By far the greatest water management problem is over-irrigation.

Principal uses for micro irrigation systems are providing water for windbreaks, vegetables, berries, grapes, fruit, citrus and nut orchards, nursery stock, and landscape and ornamental plantings. Figure 6-14 shows a typical micro irrigation system layout in an orchard. In areas where the water supply is inadequate and water cost is high, subsurface micro systems can be cost effective for irrigation of high value row crops. Buried line source lateral systems have been in continuous operation since 1982.

(b) Types of micro irrigation systems

(1) Point-source emitters (drip/trickle/bubbler)

In the point-source form of micro irrigation, water is applied to the soil surface as discrete or continuous drops, tiny streams, or low volume fountain through small openings. Discharge is in units of gallons per hour (gph) or gallons per minute (gpm) over a specified pressure range. Discharge rates typically range from 0.5 gallon per hour to nearly 0.5 gallon per minute for individual drip emitters.

Microtubes (spaghetti tubing) are classed as point-source emitters even though they are actually tubes rather than emitters. Microtubes consist of various lengths of flexible tubing that is small in diameter (.020 to .040 inch). Typically, no other water control device is used. Discharge rates are adjusted by varying the length of the tubing. The longer the tube, the greater the friction loss, which decreases the discharge rate.

Because discharge orifices are small, complete filtration of water is required. Bubblers are commonly used with ornamental landscape plantings, orchards, and grape vineyards. Flows are generally less than 1 gallon per minute. Figure 6-15 illustrates typical drip emitter devices.

Figure 6-14 Typical orchard micro system layout

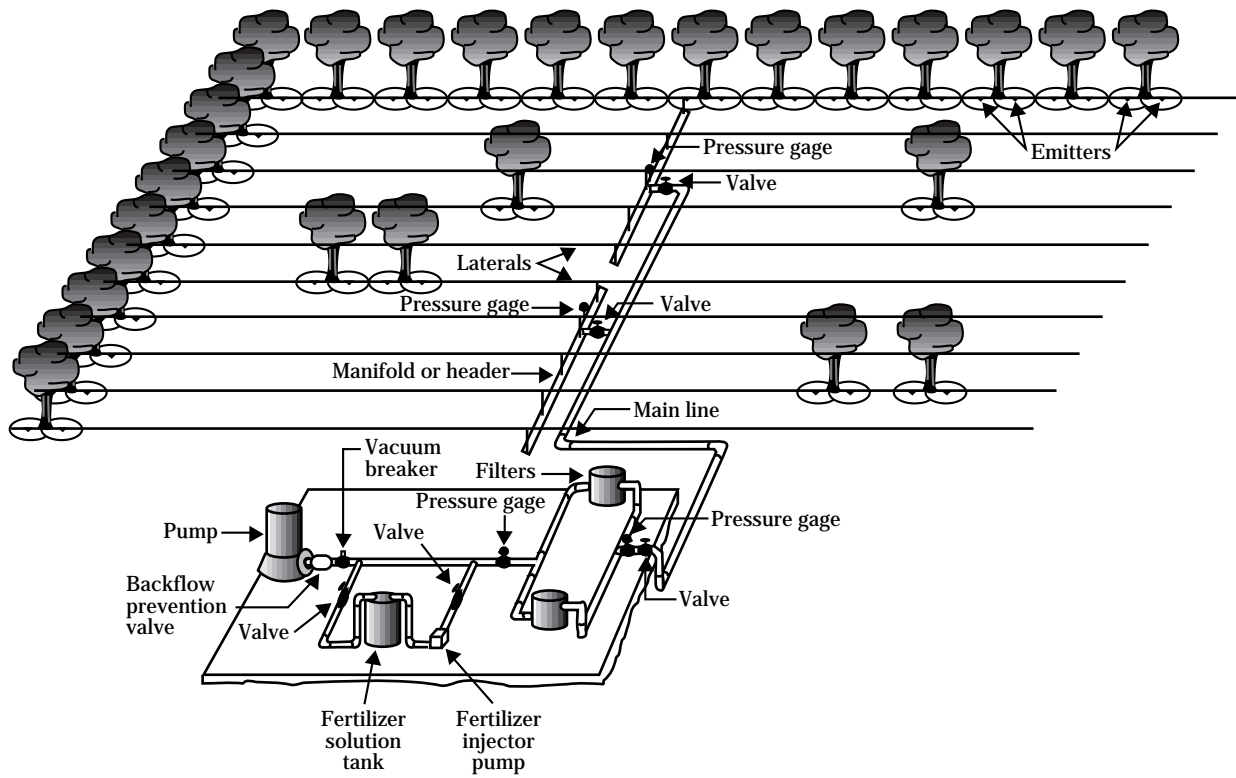
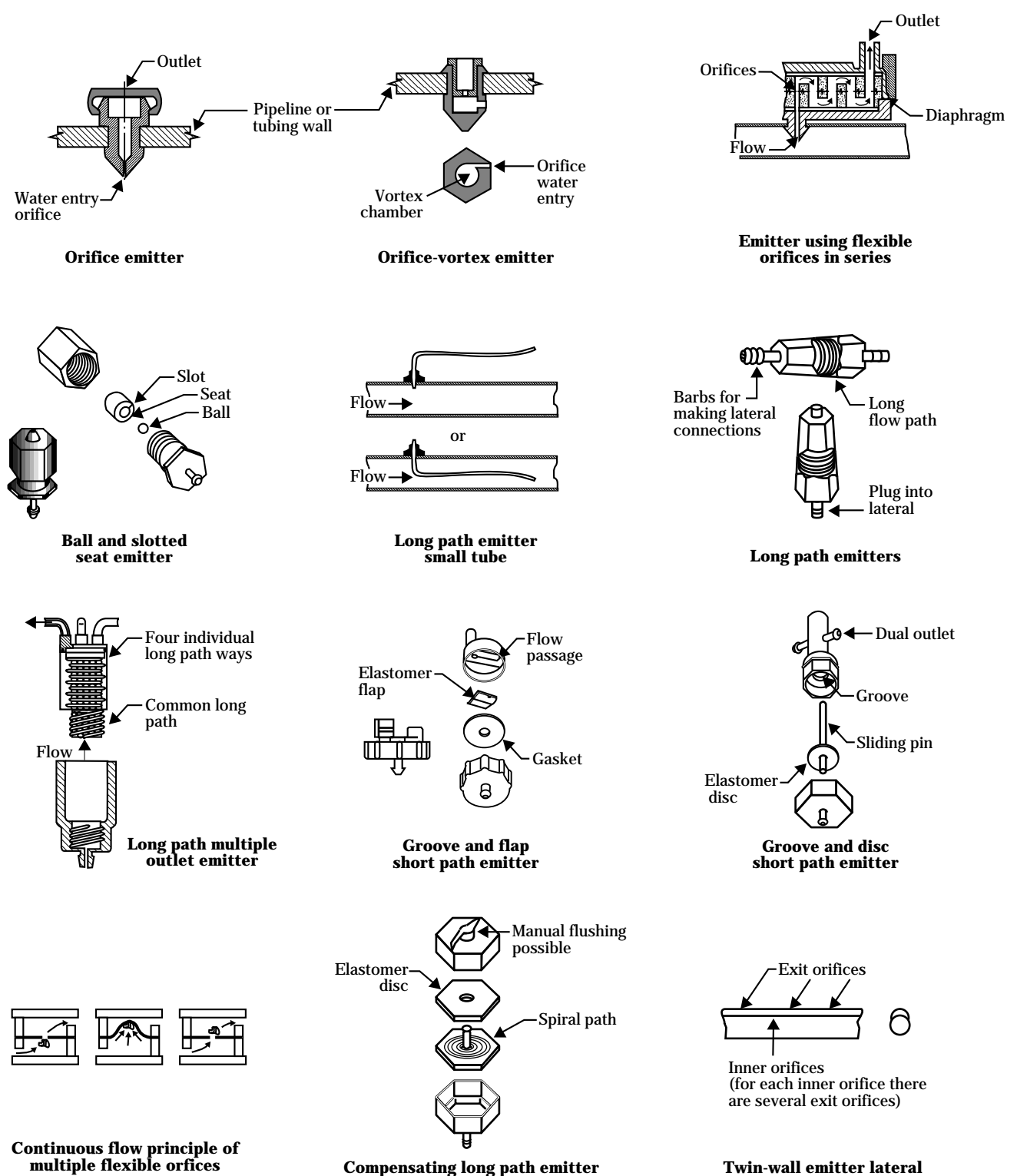

Figure 6-15 Emitter devices



(2) Surface or subsurface line-source emitter systems

This type micro irrigation uses surface or buried flexible tubing with uniformly spaced emitter points (or porous tubing). The tubing comes as layflat tubing, flexible tubing, or as semirigid tubing that retains its shape. Generally, this system is used in permanent crops, but has been used successfully as either surface or buried lines with high value row crops, such as vegetables, cotton, and melons. Figure 6-16 shows typical examples of surface and subsurface emitter devices.

Surface or subsurface line-source emitter systems have a uniform discharge in units of gallons per hour per foot (gph/ft) or gallons per minute per 100 feet (gpm/100 ft) over a specified pressure range. Because discharge orifices are small, complete filtration of water is required.

Figure 6-16 Surface and subsurface line source emitter devices

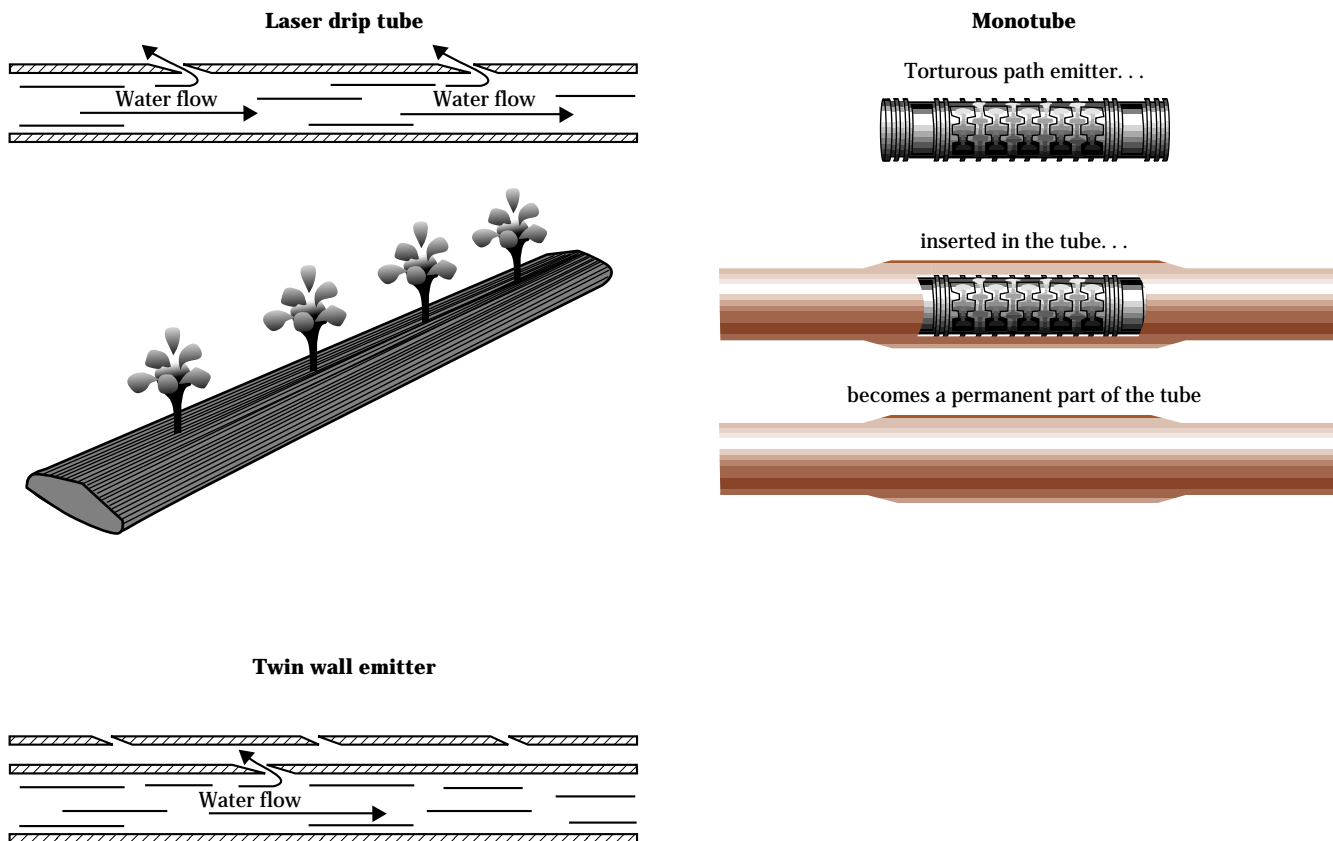

(3) Basin bubblers

The basin bubbler micro irrigation system applies water to the soil surface in small fountain type streams. The streams have a point discharge rate greater than that for a typical drip or line source system, but generally less than 1 gallon per minute. The discharge rate normally exceeds the infiltration rate of the soil, so small basins are used to contain the water until infiltration occurs. Discharge is generally from a small diameter (3/8 to 1/2 inch) flexible tube that is attached to a buried or surface lateral and located at each plant vine or tree. The typical emitter device is not used, and discharge pressures are very low (< 5 lb/in²). Figure 6–17 displays a typical basin bubbler system.

Basin bubblers are used in orchards and landscaping and ornamental plantings. These systems are best used with medium to fine textured soils where lateral water movement can provide adequate soil moisture for the desirable plant root development area. With coarse textured soils, bubbler discharge rates are increased and shorter time periods used, thereby providing more wetted area above the potential plant root zone.

The discharge orifice is larger than that of the other systems, so little or no water filtration is required. Generally, screening of coarse debris and small creatures is sufficient. Drains must be provided to allow discharge of any collected sediment.

Flow to each discharge point is controlled by adjusting the elevation at the outflow end of the tubing. The tubing is attached to a support stake. Decreasing the elevation along the lateral compensates for head loss in the lateral.

This simple system distributes water uniformly to each tree without special flow regulating devices. Operating pressures less than 2 pounds per square inch can

distribute water on up to 10 acres. Bubbler basins apply water to a larger soil volume than do drip emitters; therefore, only one outlet device is needed per plant or tree. This promotes increased root development that may be needed to support the plant in windy areas. Irrigation scheduling is also easier.

(4) Spray or mini sprinkler

With spray or mini sprinkler micro irrigation systems, water is applied to the soil surface as spray droplets from small, low-pressure heads. The typical wetted diameter is 2 to 7 feet. Discharge rates are generally less than 30 gallons per hour (0.5 gpm). The wetted pattern is larger than that of typical drip emitter devices, and generally fewer application devices are needed per plant.

Spray and mini sprinklers also have less plugging problems and less filtration required than point-source emitters (drippers). Many spray heads only require the replacement of the orifice to change discharge rate. If an orifice becomes plugged, it is easily removed and cleaned or replaced. Spray or mini sprinkler head application patterns can be full, half circle, or partial circle (both sides). Figure 6–18 illustrates typical spray and mini sprinkler type heads.

Figure 6–17 Basin bubbler system

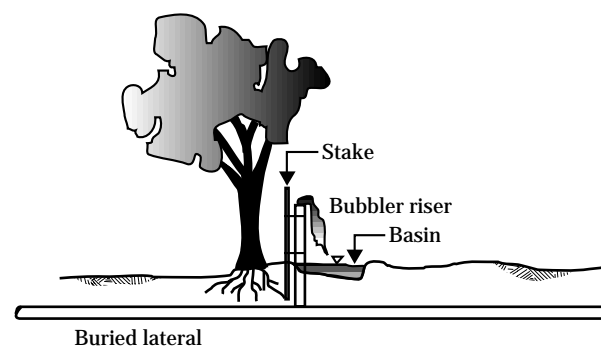
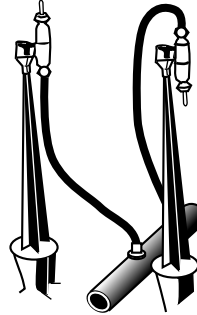

Figure 6-18 Various mini spray and sprinkler heads

Mini-sprinkler on wedge

Composed of mini-sprinkler, coupler (cantal), flexible pvc tubing (2 ft), plunger, wedge.

Flow in gph at 20 lb/in ²	Color code
4	blue red
6	blue blue
13	gray black
15	black black
24	blue black
26	red black
35	brown black



Mini-sprinkler on wedge with pressure regulator

Composed of all components listed in mini-sprinkler on wedge 1 with addition of pressure regulator (regulated working pressure of 30 lb/in²) (2 atm).

Flow in gph at 30 lb/in ²	Color code
16	gray black
18	black black
29	blue black
32	red black
42	brown black

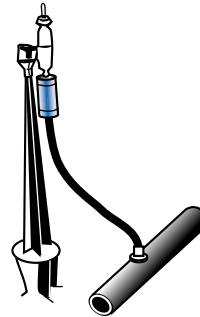

Mini-sprinkler on flexible riser

Composed of mini-sprinkler, flex riser, plunger.

Flow in gph at 20 lb/in ²	Color code
4	blue red
6	blue blue
13	gray black
15	black black
24	blue black
26	red black
35	brown black

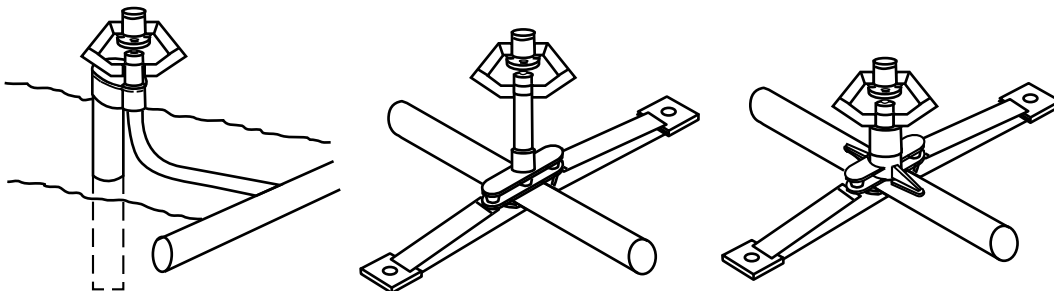
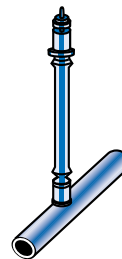

(c) Advantages of micro irrigation systems

Micro irrigation can be one of the most efficient methods of irrigation. Little if any runoff and little evaporation occur, and deep percolation can be controlled with good water management. Water is applied at the point of use (plant transpiration). Other advantages of micro irrigation systems are:

- Systems are easily automated with soil moisture sensors and computer controlled for low labor requirements.
- Soil moisture levels can be maintained at predetermined levels for start-stop operation.
- Fertilizer can be efficiently added to irrigation water. With proper water management, there is minimum waste caused by deep percolation, and less opportunity for ground water pollution.
- Much of the soil surface remains dry, reducing weed growth and soil surface evaporation.
- The soil surface remains firm for use by farm workers and equipment.
- Frequent irrigations can be used to keep salts in the soil water more diluted and moved away from plant roots. Irrigation with water of higher salinity is possible (requires a high level of management). Where salts are present, soil-water movement must always be toward the edges of the wetted bulb (away from roots). A common mistake is to shut the system down when precipitation occurs, often creating soil-water movement into the plant root zone.
- Micro irrigation can be used on all terrain and most agricultural crops and soils and is often used on steep, rocky ground that is unsuitable for other forms of irrigation.
- Low tension water availability to plants enhances growth and improves crop yield and quality.

(d) Limitations of micro irrigation systems

Micro irrigation is considered expensive to install and maintain. In general, the cost of micro systems is greater than that for sprinkle or surface systems. Frequent maintenance is essential, and a high level of management is required to obtain optimum application efficiencies. Other limitations include:

- Clogging is a major problem in all micro systems. Emitter outlets are very small, and can be easily clogged with chemical precipitates, soil particles, or organic materials. Clogging can reduce or stop water emission. Chemical treatment of the water is often necessary, and filters are almost always required. Filtration and treatment can be costly, especially where water is taken from surface sources containing sediment and debris. During installation, care should be taken to clean all construction debris from the inside of pipelines as this material can cause plugging.
- Animals, especially rodents, can damage surface (and shallow subsurface) installed plastic pipe less than 4 inches in diameter.
- With low operating pressures, poor distribution uniformity can result because of elevation differences on undulating ground. Pressure regulators or pressure compensated emitters are then necessary. However, they require about 2 pounds per square inch for operation.
- On steep terrain, automatic gravity draining of laterals to a low point within the field can cause low distribution uniformity, especially in low pressure, high volume systems. This problem is aggravated by frequent on-off cycles, but can be overcome by installing air-vacuum valves in a raised pipe arch (i.e., dog leg) at one or more locations in the lateral. Drains are installed just upstream of each pipe arch. This increases the number of sites affected by lateral pipe drainage, thus decreasing effects on distribution uniformity because each drain discharges less water.

- When soil water is reduced in the plant root zone, light rains can move salts in surrounding soil into the plant root zone, which can constitute a potential hazard. Salts also concentrate below the soil surface at the perimeter of the soil volume wetted by each emitter. If the soil dries between irrigations, reverse movement of soil water can carry salts from the perimeter back into the root zone. To avoid salt damage to roots, water movement must always be away from the emitter and from the plant root zone. As strange as it may seem, in high soil salinity areas or when using high saline or sodic water for irrigation, one may need to irrigate when it rains.
- A smaller volume of soil is wetted at each plant. Plants can be quickly stressed if the system fails (i.e., pump failure, water source cutoff, pipeline or valve failure). Daily checking of the system is necessary even when all or part is automated. Storing a 3-day plant-water supply in the soil is recommended along with daily replacement of water used.
- Multiple emitters at each plant are recommended to decrease effects of manufacturer variability, to increase area of root development, and to reduce risk of plant damage should an emitter become plugged.

(e) System components

System components should include the following, in order of installation starting at the water source point (see fig. 6-19).

1. Prescreening of debris and settling of coarse sediments if source is surface water. Need control valves and flow measuring device.
2. Provide system operating pressure of 5 to 20 pounds per square inch using pump(s) or gravity flow. Need pressure gage and control valves.
3. Chemical injector device(s) for injecting fertilizers and other pipeline cleaning chemicals.
4. Filtering system to remove fine organic, suspended sediment and chemical precipitates. Need pressure gage upstream and downstream of filter device.
5. Filter system backflush device. Need control valves.
6. Mainlines typically are buried PVC plastic pipe with control valves as necessary.
7. Submains typically are buried PVC plastic pipe with control valves, pressure regulators, and drains as necessary.
8. Laterals or feeder lines are either surface or buried PE or PVC plastic flexible tubing.
9. Emitter devices.
10. Appropriately placed soil moisture sensing devices. Start of irrigation can be manual, computer programmed, or with a time clock. Lateral on-off sequencing can be automated with solenoid operated valves. A controller and electric valving can help assure proper irrigation timing to meet soil depletion and plant needs.

(f) Planning and design considerations

(1) Water quality

Water quality is usually the most important consideration when determining whether a micro irrigation system is physically feasible. Well and surface water often contain high concentrations of undesirable minerals (chemicals). Surface water can contain organic debris, algae, moss, bacteria, small creatures, weed seeds, and soil particles. Well water can also contain sand.

Various forms of algae are in almost all quiet surface water. Sunlight and water high in nutrients encourage algae growth. Algae are hard to remove from laterals and emitters once it gets established. The best way to handle algae is to prevent it from forming. Chlorine can be injected at the end of each irrigation cycle to

help prevent algae buildup. Algae growth is especially a problem where sunlight aids algae growth inside white plastic pipe that is installed above the ground surface. Black pipe (PE pipe) is not affected because sunlight does not penetrate the pipe. White plastic pipe can be painted with a dark color to help prevent sunlight penetrating the pipe and provide some UV protection.

Bacterial slime can plug emitters and small tubing. Conditions favoring slime growth include pH of 4.5 to 6, low oxygen level, temperatures greater than 46 degrees Fahrenheit, organic matter, dissolved iron and manganese, and hydrogen sulfide. Treatment is by injection of chlorine, sodium hypochlorite (household bleach), or calcium hypochlorite (swimming pool chloride). Continuous injection of chlorine at 1 ppm is effective. Periodic shock treatment with concentrations of 10 ppm can also be used.

Figure 6-19 Micro system components

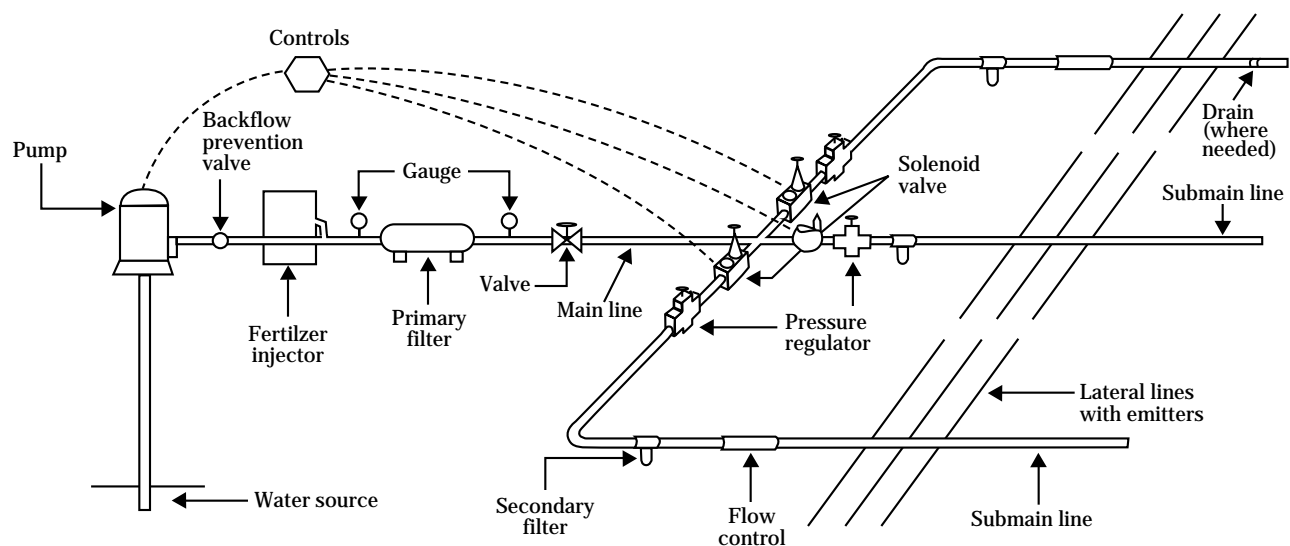

Water with a high Sodium Absorption Ratio (SAR) and low water Electrical Conductivity (EC_w) destroys the structure of the soil, which results in a drastically reduced intake rate. Sodium content may also be high enough to be toxic to the plant. Unless well water characteristics are known, water should be tested for EC_w and SAR. See chapter 13 of this guide for further discussion.

If water softeners are used in a home water system, do not use the softened water in a micro irrigation system. Large amounts of salt are added to soften the water. Besides not being good for plant growth, salt precipitates at the emitter discharge orifice and tends to plug emitters. Attach the micro system into the water system upstream of any water softener.

Water with relatively high salinity (high EC_w), as defined in chapter 13, can sometimes be used with a micro system. A higher soil-moisture level (lower soil-water tension) can help assure water for plant growth is readily available. Additional irrigation water keeps the salts leached from the plant root zone. To accomplish this, the soil must have good internal drainage.

Bicarbonate concentrations in water higher than 2.0 milliequivalents per liter (meq/L), coupled with a pH above 7.5, and temperatures greater than 70 °F promotes scale development (precipitation of mineral deposits). With black plastic pipe placed on the ground surface and exposed to direct sunlight, the water temperature inside can get quite high. A scale (precipitate) is formed inside the walls of the pipe and emitters. Injections of acid (food grade phosphoric or sulfuric) can be used for cleaning, but will not completely reclaim partly blocked lines and emitters. Continual treatment is usually necessary. Treatment of water before it is used in the system allows precipitation and collection of the carbonates to occur before they get into the pipe system. Periodic treatment within the pipe system can dislodge built up scale and cause plugging of emitters.

Another common problem with well water is high iron concentration, which can result in iron precipitating in the line. This encourages the growth of iron bacteria.

The resulting slime can plug emitters. Where iron is present in concentrations of 0.4 ppm or greater, it can be oxidized to form a precipitate. This precipitate should be filtered out before the water enters the irrigation system. Table 6–11 displays physical, chemical, and biological factors that cause plugging of emitters. Table 6–12 displays plugging potential from irrigation water used in micro systems.

Soil particles near 2 micron size tend to stick together because of physical size, shape, and electric charge. Under very low velocities they can clog emitter orifices. Flushing the lines regularly and using larger size emitters helps prevent clogging. Also using a chemical dispersant, such as hexamethaphosphate, can keep particles dispersed so they do not stick together.

Table 6–13 displays the typical composition and classification of water used in micro systems. It should be noted either one, two, or all three factors (physical, chemical, and biological) can be present in a micro system. The designer and irrigator need to know what is present in the irrigation water and in what concentration.

Table 6–11 Physical, chemical and biological factors causing plugging of emitters

Physical	Chemical	Biological
Organic debris	Ca or Mg carbonates	Filaments
Aquatic weeds, moss	Ca sulfate, Ferric iron	Slimes
Algae	Metal hydroxides, carbonates, silicates and sulfides	Microbial deposits
Aquatic creatures, snails, fish	Fertilizers phosphate, ammonia	iron ochre manganese ochre
Plastic particles	manganese	sulfur
Soil particles—sand, silt, clay	iron, zinc, copper	ochre

Table 6-12 Plugging potential from irrigation water used in micro irrigation systems

Problem	Low	Medium	Severe
Physical			
Suspended solids, ppm	50	50 -100	> 100
Chemical			
pH	7.0	7.0 – 8.0	> 8.0
TDS, ppm	500	500 – 2,000	> 2000
Manganese, ppm	0.1	0.1 – 1.5	> 1.5
Iron, ppm	0.1	0.1 – 1.5	> 1.5
Hydrogen sulfide, ppm	0.5	0.5 – 2.0	> 2.0
Biological			
Bacteria population - no. per mL ^{1/}	10,000	10,000 – 50,000	> 50,000

^{1/} Bacteria populations reflect increased algae and microbial nutrients.

Table 6-13 Typical composition and classification of water used in micro irrigation systems

Source of water	Physical ^{1/}		Chemical ^{1/} iron or manganese ppm	bacteria population number/mL	Biological ^{1/} classification - physical/chemical/ biological
	suspended solids (ppm)	dissolved solids (ppm)			
City water	1	500	0.05	10	0-4-0
Runoff water	300	50	0.05	10,000	10-0-6
River water	70	900	0.10	4,000	6-8-4
Well water	1	1,650	0.05	40,000	0-10-9

^{1/} Physical and biological composition of water can change during the season and between seasons.

(2) Clogging

Clogging of emitters is the most serious problem of micro irrigation. Properly designed and maintained filtration systems generally protect the system from most clogging. Clogging causes poor water distribution, which in turn may damage the crop if emitters are plugged for a long time. When the plant(s) shows excessive stress, it is generally too late to correct the problem. Multiple emitters per plant are recommended. The main causes of clogging are algae, bacterial slime, precipitate, construction debris, and sediment. In general, adequate filtration, line flushing, and chemical treatment prevent most clogging.

The irrigator must see or know when clogging is occurring. The capability of the irrigator to observe operation of emitters or spray heads is rated as follows. The ratings are in order of easiest to see to most difficult to see from a reasonable distance (i.e., from the seat of a small 4-wheel drive RV unit).

Type emitter	Observation
1 Basin bubblers	Water bubbling out of the pipe and water on the ground surface.
2 Spray heads	Spray coming from the heads and the resulting wetness on the ground surface and plant leaves.
3 Point emitters suspended above ground surface	Water dripping out of the emitter and the resulting wetness on the ground surface.
4 Line source and point source emitters lying on the ground surface; spaghetti tubing	The line must be picked up to see if the emitter is operating. Wetness of ground surface around the emitter can also be observed. Raising the emitter too high causes the flow rate to change.
5 Subsurface or buried tubing	Ground surface moisture caused by upward capillary action and plant condition indicate emitter operation. Buried emitters cannot be seen, and their replacement is more difficult. The Crop Water Stress Index Gun (infra red thermometer reading) can be used to detect plant stress before it is visible to the eye.

Note: The only way to be assured whether the emitter is discharging near design flow is to check it using a catch can or rain gutter trough device and a stop watch. The operating pressure also needs to be checked. A little ingenuity is often necessary to develop catch can devices that collect all the water discharging from an in-line emitter or spray head, and to measure operating pressure.

(3) Filter systems

All water must be screened and filtered to some degree before use in a micro irrigation system. Water quality, temperature, flow rate, and emitter orifice size determine the type of filter. One rule of thumb is to select filters that retain all particles at least a tenth the diameter of the smallest passageway in the system. For example, a 250-micron filter would be used to remove all particles passing through a 25 micron opening. Ordinary window and door screen approximates 8-12 mesh (0.125-0.083 inches).

Surface water must first be screened to remove organic debris, weed seeds, small aquatic creatures, and coarse sediment. Self-cleaning screens provide transportation and storage outside the flow area for debris removed by the screen. When using flow-through screens, debris should remain on the screen surface unless mechanically removed or a back-flushing facility is used. Most wells produce some sand, precipitates, and particles that can cause emitters to plug. The turbulent fountain screen is effective for screening out coarse material, and it requires minimum labor for maintenance (fig. 6-20).

Filters cannot remove dissolved minerals, algae cells, or bacteria. The degree of filtration is generally given in terms of screen mesh size. The relationship of mesh size to particle size is displayed in table 6-14. Porous flexible tubing requires sand bed filters unless water is clean.

Filter types include centrifugal force, graded sand, cartridge, disc, and mechanical screens. Sand filters can be backflushed manually or automatically. Cartridge filters are generally replaceable. Relatively low cost replaceable cartridge filters can be used for small systems. When properly operated, centrifugal force separators are generally effective down to fine sand particle sizes. Disk filters separate during the backflush cycle.

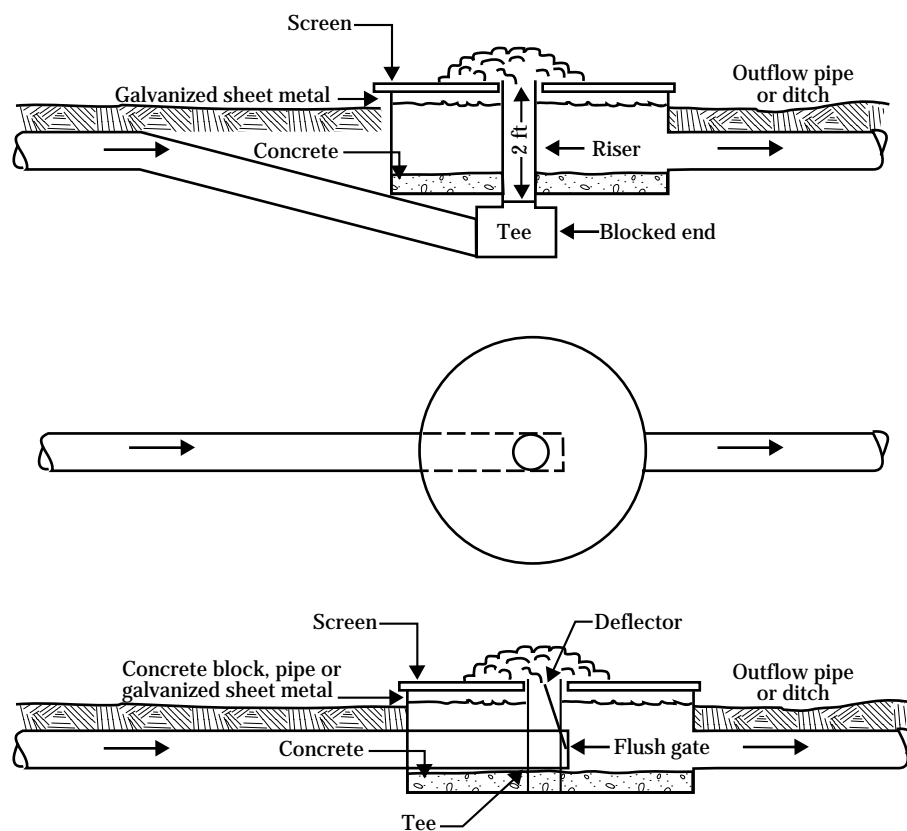
Figure 6-20 Turbulent fountain screen**Recommended screen and riser pipe diameters**

--- Flow rate --- (ft ³ /s) (gpm)	Screen diameter (in)	Riser pipe diameter (in)
1 450	42	8
2 900	48	10
3 1,350	60	12
4 1,800	72	15
5 2,250	84	18

Mechanical screens are either removed and hand cleaned or backflushed. A clean well water source may require an 80 to 100 mesh filter. Normally, a 160 to 200 mesh screen contains particles unable to pass through most emitters. Generally, the finer the screen mesh the faster it plugs up. Two or more filters or a larger screen or filter area increase the time between cleaning. Multiple screen or filter systems can be cleaned while the system is in operation. Table 6-15 displays filters used in micro irrigation systems.

Sand bed filters use graded sand for the medium, either in graduated layers or single sand particles. The size and type of sand determine pore space size, which controls the degree of filtration. Pore diameter is about a seventh of the sand particle diameter. Commercial sands generally are designated by number, becoming finer as the number gets larger (table 6-14). Under flow conditions of less than 20 gallons per minute per square foot of media surface, commercial sands are efficient and have relatively large debris-holding capacity.

Table 6-14 Particle size equivalents

Particle	Microns ^{1/}	Inches	Screen mesh
No. 11 - Granite	952	.037	
No. 10 - Silica sand	524	.021	
No. 30 - Silica sand	335	.013	
Very coarse sand	1000 - 2000	.0393 - .0786	18 - 10
Coarse sand	500 - 1000	.0197 - .0393	35 - 18
Medium sand	250 - 500	.0098 - .0197	60 - 35
Fine sand	100 - 250	.0039 - .0098	160 - 60
Very fine sand	50 - 100	.0020 - .0039	270 - 160
Silt	2 - 50	.00008 - .0020	
Clay	2	< .00008	

^{1/} 1000 micron = 1 millimeter.

Table 6-15 Filters used for micro irrigation systems

Type	Practical filtration limit
Settling basins	Varies with time and water chemistry (usually 100% of 40 micron size and larger particles settle in 1 hr)
Sand separators	To 74 microns
Screen filters	To 74 microns
Sand bed filters	To 25 microns
Cartridge filters	To 25 microns
Disc filters	To 25 microns

Sand filters are cleaned by backwashing (backflushing). Backwashing can be done automatically on a timed cycle, at a specified pressure drop across the filter, or manually. Facilities must be available to receive, store, and dispose backwash water, sediment, and debris. Periodic chemical treatment may be necessary to control algae in the filter bed.

Disc filter elements consist of flat, grooved rings resembling poker chips with a hole in the center. A stack of rings forms a cylindrical filtering body. Grade of filtration (400 to 25 microns) depends on the size and number of grooves in the individual grooved rings. The rings are held tightly together with a compressed spring.

The filtration process takes place throughout the entire cylinder volume (stacked rings). Water flow direction is from outside the cylinder toward the center. When properly sized (flow capacity wise) and with larger than 140 mesh screening, head losses through the disc cylinders are relatively low. Manufacturer recommended minimum operating pressures are in the range of 30 pounds per square inch, with maximum operating pressures of 100 to 200 pounds per square inch, depending on model. Backflush water (at typical pressures of 40 to 50 lb/in²) allows the disc to separate and flush out the collected soil and debris particles that have been caught in the grooves.

A filter is one of the most important components of a micro irrigation system and must be kept clean to be effective. Monitoring line pressure at filter inlet and discharge points helps check performance and signal a change occurring in the filter.

(4) Soil moisture distribution

Micro irrigation normally wets only a part of the potential plant root zone in a soil. In arid areas, crop root development is generally limited to that volume of soil wetted from the emitter system. For agricultural crops, typically half to three-fourths of the potential root development area is wetted (irrigated). For landscape plantings, individual plants are irrigated.

The volume of soil wetted is a function of the emitter type, emitter discharge, distance between emitters, time of set, and soil texture. Distribution and extent of soil wetting should be a major consideration in the design of any micro irrigation system. For medium and

fine textured soils, wetted area width from a point source is generally equal to or greater than wetted depth. With coarse textured soils, wetted width is less than wetted depth; therefore, more emitters are necessary to obtain adequate irrigation for root development.

The ability of a plant to resist dislodging by wind is determined by root development (typically plant root zone wetted pattern). This is especially the case in arid areas, and to some extent in all areas. Table 6-16 compares wetted diameter and area for various soil textures. A full surface area cover crop is difficult to maintain in an arid environment if less than complete surface area irrigation coverage is provided.

(5) Distribution lines

The micro irrigation distribution system is a network of pipes, tubing, and valves. Generally, mainlines carry water from the pump to a system of submains. Submains then carry the water to headers (manifolds) and then into laterals or feeder lines. Mainlines and submains are generally buried PVC plastic pipe. Fittings are cemented or use O-ring gaskets for water tightness. Submains can also be flexible tubing either buried or laid on the ground surface. Mainlines and submains are typically buried to provide access and limit potential equipment damage. Laterals or feeder lines are normally 3/8- to 3/4-inch-diameter polyethylene (PE) flexible tubing either buried or laid on the ground surface. Lateral fittings generally are slip joint with hose clamps for water tightness. In some areas rodents and small animals (i.e., coyotes, squirrels) will damage PE pipe that is less than 4 inches in diameter.

Table 6-16 Diameter and area of soil wetted by a single emitter with no restrictive horizons

Soil texture	Wetted diameter (ft)	Wetted area (ft ²)
Coarse	2 - 4	4 - 12
Medium	4 - 5	12 - 20
Fine	5 - 7	40 - 60

(6) Emitter application

The discharge (emitter) device is unique to a micro irrigation system. Many types, shapes, and discharge ranges are commercially available. They can be either pressure compensating or noncompensating.

Discharge devices can be divided into two general categories based on field application: line-source and point-source. Point-source include microspray or sprinkler heads, microtubing, and bubbler systems. Manufacturers of emitter devices can furnish performance data that show discharge versus pressure for each size and kind of emitter manufactured. Section 652.0605 includes additional discussion of specific emitters that are commercially available.

Line-source emitters are used for closely spaced row crops, such as vegetables, cotton, sugarcane, grapes, strawberries, melons, and some small fruit. These emitters are either a series of equally spaced orifices along a single or double chamber tube, or they are small openings in porous tubing. Closely spaced buried line source emitter tubing has been shown to be effective in small areas of turf, especially where surface spray is not desirable.

The discharge rate of line-source emitters is in gallons per hour or gallons per minute per unit length of tubing (gpm/100 ft, or gph/ft). The emitter or orifice spacing affects the location and amount of water delivered to each plant. Operating pressures range from 5 to 30 pounds per square inch. Line source emitters should be used on nearly level ground and can be installed on the ground surface or as buried feeder lines.

Point-source emitters are used for windbreaks, fruit, citrus and nut orchards, grapes, cane berries, blueberries, bananas, ornamental and landscape shrubs, nursery stock, and greenhouse crops. The point-source emitter is an individual emitter typically attached to 1/4- to 3/4-inch-diameter PE flexible tubing. Orifice flow rates vary from a half gallon per hour for drippers, 30 gallons per hour for spray heads, and 1 gallon per minute for basin bubbler devices.

(7) Miscellaneous control devices

- Gate valves provide on-off control. They can be operated manually or with timed or automatic solenoid valves.
- Pressure regulating valves control pressure within desired limits of emitter discharge.

- Vacuum relief valves prevent soil particles from entering the system when negative pressures develop (i.e., the system is shut off).
- Pressure gages monitor pressures in the system.
- Flushing valves discharge collected sediment and other debris.
- Drain valves drain water from the system.
- Injectors add chemicals (fertilizers, acid, chlorine).
- Flow measuring devices monitor how much water is applied.

(8) Fertilizing

The application of plant nutrients through a micro irrigation system is convenient and efficient. Several injectors are commercially available. Nitrogen can be injected in the forms of anhydrous ammonia, aqua ammonia, ammonium phosphate, urea, ammonium nitrate, and calcium nitrate. Some chemicals may change the pH in the water, thereby affecting other chemicals in the water. Phosphorus is usually added in acid form. Potassium can be added as potassium sulfate, potassium chloride, and potassium nitrate. Other micronutrients can be added, but may react with salts in irrigation water resulting in precipitation. Care should be taken so the injected nutrients don't react with other chemicals in the water to cause precipitation and plugging.

(9) Costs

Equipment, filtration, control, and numerous laterals needed for a micro system generally result in a high cost per acre. Per acre costs are highly influenced by filtration costs. For example filtration requirements are relatively the same for 20 acres as for 40 acres. Adequate filtration cannot be overstressed. Because of reduced filtration requirement and number of laterals, basin bubbler and spray systems can be more economical, especially for orchards and landscaping.

(10) Maintenance

Frequent maintenance is essential to keep emitters functioning at design flow. Maintenance items include:

- Clean or backflush filters when needed.
- Flush lateral lines regularly.
- Check emitter discharge often; replace as necessary.
- Check operating pressures often; a pressure drop (or rise) may indicate problems.

- Inject chemicals as required to prevent precipitate buildup and algae growth. Inject liquid fertilizers when needed.
- Service pumps regularly.

(11) Automation

Micro irrigation systems can be operated fully automatic, semiautomatic, or manually. A time clock or programmed control panel can be installed to operate solenoid valves, to start and stop the irrigation, and to control each submain and lateral. This degree of automatic control is simple, the parts are readily available, and it effectively controls the desired amount of water to be applied. A manual priority switch that can override clock or control panel switches is desirable to postpone or add irrigations. A fully automatic system, using soil moisture sensors to provide the triggering mechanism to start an irrigation, is also simple to install and operate. Several sensors may be needed, depending on soils and rooting depth of crops to be grown. Where water supply is adequate overirrigation is the biggest water management problem with automated systems.

(g) Design procedures

The primary objective of good micro irrigation system design and management is to provide sufficient system capacity to adequately meet crop-water needs. Uniformity of application depends on the uniformity of emitter discharge, system maintenance, and elevations of the ground surface. Nonuniform discharge is caused by pressure differentials from friction loss, plugging, elevation change, and manufacturing variability. Using pressure compensating emitters somewhat alleviates the elevation change and pressure differential problem. Using multiple emitters for a single shrub, vine, plant, or tree helps to compensate for manufacturing variability and minimize plant damage that results from plugged or malfunctioning emitters.

The designer of a micro irrigation system must make a rational choice about the duration of application, the number of emitters per plant, specific type of emitter device(s), and the discharge per emitter to provide the most effective irrigation. In most situations the required water volume (or rate) to irrigate a specific crop is less than that required by other irrigation methods; thus the minimum system capacity require-

ment is not a limiting factor if adequate water was available for other irrigation methods.

(1) Water management

Proper water management when using micro irrigation is essential to avoid excessive water use. The ease of applying an irrigation, especially under manual control, brings a mentality of *when in doubt irrigate*. Deep percolation, typically the result of overirrigation, cannot be seen. As a result, overirrigation is by far the biggest problem with users of micro irrigation. Field application efficiencies are often measured in the mid 60 percent, while most micro irrigation systems are designed assuming application efficiencies of more than 90 percent. The irrigation system designer needs to have realistic expectations of water management skills and desires of the user.

(2) Duration of application

The least cost per acre is generally achieved by the system having the longest duration or lowest flow rate and smallest pipe sizes. The duration for application is influenced by the overall irrigation schedule and by incorporating a factor of safety in the design. Application time must be sufficient to apply the water that has been consumed since the previous irrigation. Ideally, continuous or demand delivery of irrigation water provides the lowest cost design and best irrigation scheduling opportunity. Therefore, the duration of each irrigation can be determined after the following are known:

- Gallons of water needed per plant per day to meet evapotranspiration.
- Desired interval between irrigations (frequency of irrigation).
- Application rate per emitter or unit length.

Hours operation per irrigation are determined by:

$$\frac{\text{Gallons of water per plant per day}}{\text{Application rate per plant in gallons per hour}}$$

Gallons of water needed per day per plant are calculated using the evapotranspiration rate of the plant(s), soil MAD level, and AWC of the planned soil volume.

Even if water used by an individual plant is to be replaced daily, a 3-day water supply be stored in the plant root zone to is recommended provide water when irrigation system discharge is interrupted. If the system operates less frequently than daily, increase

the time of operation or the number of emitters for each plant to increase water applied each irrigation. Ideally, a system can be designed to run 24 hours per day; but most systems should run no more than 18 hours. Time is needed for general maintenance, breakdowns, and to provide a factor of safety during extreme high plant water use periods. Using more emitters of the same discharge rate with less duration is generally better than fewer emitters with greater capacity.

(3) Discharge per emitter

Drip emitters are mechanical devices designed to operate at low pressure (2 to 20 lb/in²) from 0.5 gallon per hour to nearly 0.5 gallon per minute. Discharge rates of line source emitters are in units of gallons per hour per foot or gallons per minute per 100 feet. Discharge rate should be within plus or minus 15 percent of the average system flow rate.

(4) Number of emitters

Micro irrigation requires a decision be made about the percentage of potential rooting volume to be watered. It is recommended at least 40 to 50 percent of the area under a tree, plant, or shrub drip line (at mature size) receive moisture. Part of this requirement comes from providing an anchor system to support the plant. Plant roots do not normally develop where the soil is dry; i.e., water tension is 15 bars (atmospheres) or greater. An onsite test may be needed to determine vertical and lateral movement of water from a point source.

Typically in uniform fine to medium textured soils, the wetted width is equal to the wetted depth. In coarse textured soils, the wetted width is typically no more than half the wetted depth.

Emitters should be spaced equidistant around the shrub or tree and should be located within a third of the distance from the trunk to the drip line. With line source emitters, 12- to 36-inch spacing is typical. In coarse textured soils, line source emitters should be spaced less than 12 inches apart, and medium textured soils less than 24 inches. Emitter spacing also depends on plant type and density.

Microspray or sprinkler heads provide the largest wetted soil volume. A minimum of two application devices should be used per shrub or tree. Figure 6-21 displays alternative ways to layout emitters for individual trees.

(5) Laterals or feeder lines

Most lateral or feeder lines are flexible PE plastic tubing. Emitter devices are either attached directly to the pipe or the pipe may contain built-in orifices. Surface installed tubing is subject to damage from animals, rodents, and field operating equipment. The designer should be guided to size laterals so that discharge differences are kept to less than 10 percent between the first and last emitter on the line. Even though pressure compensating emitters may be used, lateral friction loss must be evaluated to help assure minimum pressures are maintained for proper emitter (and regulator) operation. Table 6-17 displays maximum pressure variation for typical emitters.

Most micro systems are divided into subunits connected by manifolds through control valves to a submain or mainline that feeds several laterals. The total pressure variation in both the manifold and laterals must be considered when sizing pipelines. In an optimum design, the total pressure loss in the subunit should be equally divided between the manifold and the laterals. For example, if a total of 4 pounds per square inch pressure variation is allowed, 2 pounds per square inch can be lost in the manifold and 2 in the laterals.

Figure 6-21 Alternative emitter layout

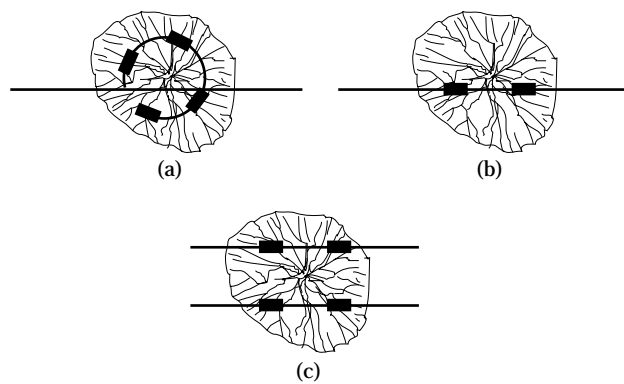

(6) Mainlines and submains

Mainlines and submains (including manifolds) are generally buried PVC plastic pipe. Laterals or feeder lines need to be installed as nearly level as possible. On sloping fields submains and mainlines should be installed up and down the slope. A 5-foot elevation change represents over 2 pounds per square inch pressure change, which can change emitter discharge more than the allowable 10 percent in low pressure systems.

To maintain uniform pressure at outlets to laterals the designer should consider the following:

- Divide the submains into shorter lengths or off balance the outlets so less than a 10-foot drop is present between inlet from the mainline and lowest outlet to a lateral pipeline.
- Install pressure regulators at each outlet to laterals.
- Install flow regulators at each outlet to laterals.
- Use pressure compensating emitters where needed.
- Size submains and laterals to reduce and sometimes nearly eliminate friction losses.
- Provide adequate pressure to operate pressure and flow regulators at design discharge.

(7) Other

When planning, the designer must determine total irrigation system needs. These needs include settling basins, screens, filters, pumps, flow meters, fertilizer injectors, chlorine or acid injectors, mainlines, submains, laterals, emitters, valves (both manual and electric valves for automatic operation), pressure gauges, drains, timer clocks, and soil moisture monitoring devices. Not all systems require all equipment.

(8) Basic information needed for planning and design

- Topographic map with 2-foot contour interval including field shape, layout, dimensions, and elevations of key points.
- Soil series, texture, AWC, and MAD level for crop(s) grown, crop ET, area, and volume of soil to be wetted by micro system.
- Tree, shrub, or crop—type, size, location, spacing, and plant density.
- Water source—quantity, quality, location, delivery schedule, water measuring device(s).
- Desirable surface or subsurface emitter system and laterals or feeder lines.
- Water screening and filtering system and settling basins.
- Submains, mainlines, valves, pressure gages, pressure and flow regulators, and injectors.
- Power supply: type, location.
- Pumping plant.
- Future expansion including mature tree size, interplantings of new trees, and different crops to be grown in a rotation.
- Growers desire as to level of operation and automation, management skills available, and irrigation scheduling.

Table 6-17 Recommended maximum pressure variation, in pounds per square inch, for typical emitters ^{1/}

	Nonpressure compensating		Pressure compensating	
Design pressure	15	20	15	20
Pressure variation ^{2/}	13 -17	17 - 23	11 - 20	14 - 26
Pressure range	4	6	9	12

^{1/} Based on 20 percent flow rate variation.

^{2/} The allowable pressure variation is an estimate for typical point source emitters. If available, manufacturers' discharge data should be used instead.

(9) Design steps

The steps necessary for the design of a micro system include:

Step 1. Determine net depth of application

$$F_n = \frac{C Q N T E}{A f}$$

where:

C = 1.604 as units conversion factor

Q = discharge rate in gph per emitter per foot of lateral

N = number of outlets (application devices, emitters) or total length of lateral tubing in feet

T = hours of operation per day (suggest a maximum of 18 hr/d)

A = area of field in square feet served by number of emitters

E = overall field application efficiency, including irrigation scheduling (expressed as a decimal with a maximum of 0.90)

f = percent of total area to be wetted (as a decimal)

Step 2. Emitter design.

Step 3. Determine flow per lateral, submain, and mainlines. Determine total system capacity to meet design plant evapotranspiration.

Step 4. Size laterals, submains, and mainlines.

Step 5. Determine pump size needed.

Step 6. Determine screening, settling basin, and filter system needs.

Step 7. Determine fertilizer injector needs.

Step 8. Determine chlorine and acid injector needs.

Step 9. Determine number and location of pressure gauges, valves, drains, and measuring devices needed.

Step 10. Provide how to determine plant water need (irrigation scheduling).

Step 11. Prepare irrigation system operation, management, and maintenance plans.

Example designs are included in section 652.0605. Master blank design worksheets are included in chapter 15 of this guide.

(10) Installation

All pipelines and tubing should be designed to permit draining and flushing to remove foreign matter that can clog emitters. All pipelines should be drained to prevent freezing, algae growth, and other such problems.

Pressure gauges should be installed at the inlet and outlet end of each filter. These gauges aid in determining when the filter needs to be cleaned or backwashed. For automatic backflushing systems, a threshold pressure differential is set to initiate backflush operations.

Surface installed lateral or feeder lines should be snaked to allow for contraction and expansion caused by temperature change. Add 5 to 10 percent to the length for expansion and contraction (snaking). Microtubing used as minilaterals at each plant allows the mainline to adjust to temperature and to move while emitters or minisprinklers on the microtubing laterals remain in place.

Figure 6-22 displays a typical small system hookup that can be installed on a domestic water source.

Figure 6-22 Typical small system hookup

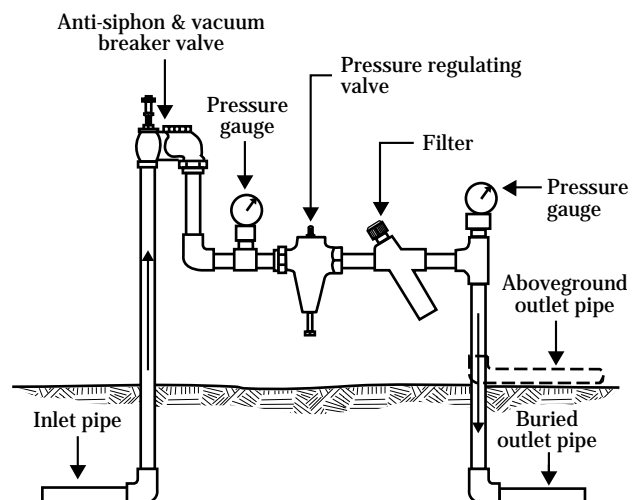

(h) Windbreaks

Irrigation of windbreaks can be desirable for one of two purposes:

- To establish the windbreak.
- To maintain the windbreak throughout its life

The type of micro system and how it is installed, operated, and maintained is dependent on purpose and type of trees or shrubs to be irrigated (fig. 6–23).

Windbreak micro system design can be complicated because different tree and shrub sizes and spacings may be included in the layout. Lateral emitter spacings or capacities may vary with each row, which can require a separate design for each lateral. Drought tolerance should be developed over several months or years by encouraging deeper root development patterns. Longer, less frequent irrigations encourage deeper root development. Design methods in NEH, part 623, (section 15), chapter 7, can be used when the purpose of the system is to irrigate a windbreak throughout its life. Chapter 4, Irrigation Water Requirements, and the state supplement of this guide provide local water requirements for shrubs and trees.

When establishment of the windbreak is the objective, the following additional factors must be considered:

The system should be designed to last up to 5 years. Usually the distribution pipelines can be laid on the surface, although surface installations may make it difficult to use farm equipment for weed control. Potential rodent and wildlife damage should also be a consideration as to whether the distribution lines are on the surface or buried.

Once plants are established, water application should be timed to apply a larger quantity of water less frequently. This encourages deep rooting.

Augering a deep small diameter hole (post hole size) below each tree or shrub and backfilling the hole with local soil disrupts horizontal soil restrictions. This action helps move applied water deeper and encourages deep rooting.

In arid and semiarid areas, water application should be made in the spring as early as possible after the soil has thawed. This helps fill the entire soil profile to field capacity.

Figure 6–23 Typical windbreak layout

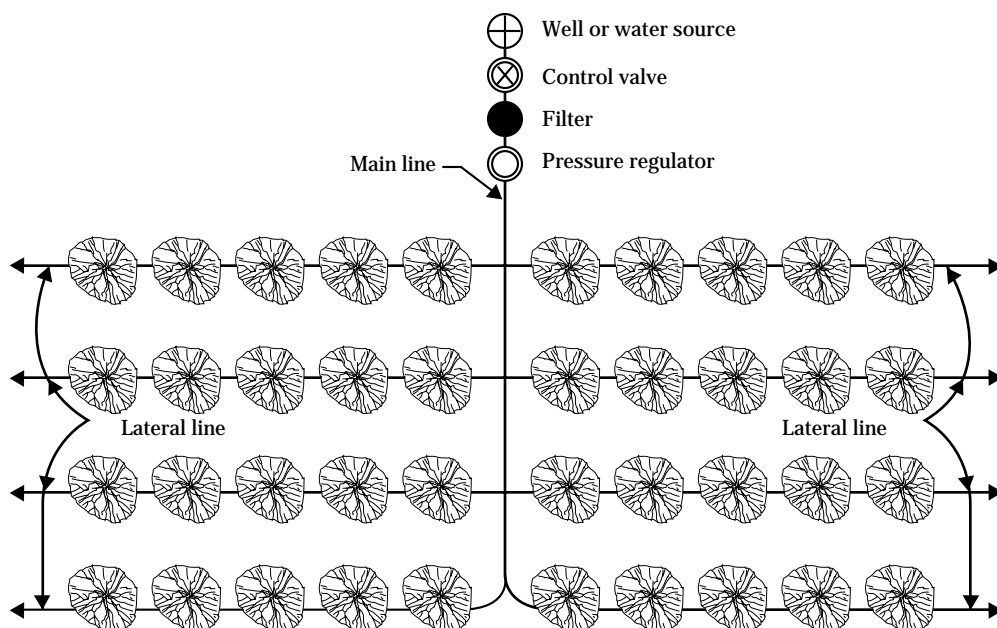

Discontinue water application in the fall before freezing temperatures. This helps ensure hardening off for winter. The lines should be drained.

To establish windbreaks in areas where precipitation can supply the needed water, irrigation needs to be discontinued after the plants are well established. This may require one or two summers of controlled tapering off. Less frequent applications of longer duration can encourage deeper root development.

Do not provide full irrigation to the plants. Use only the minimum amount of water necessary to produce healthy plant growth. Slower growth helps provide a stronger shrub or tree. Check soil moisture periodically with a hand probe. Once irrigation starts, plants should not be put into excessive stress for lack of moisture. Encourage rooting in nonirrigated areas by managing precipitation as a water source.

Micro irrigation systems used strictly for windbreak establishment require fewer emitters than systems used in mature stands. Emitters can be added as the shrubs and trees grow and mature, but the system must be designed to provide adequate capacity. The size of the laterals, submains, and mains should be designed to deliver adequate water to mature stands.

The following information is a guide to the number of emitters required in a medium to fine texture soil. Typically in coarse soils, it is better to use several low discharge emitters evenly spaced around the shrub or tree. On-time can be adjusted to provide the desired wetted depth and lateral water movement in the soil.

Low shrubs 2 to 3 feet tall	One or two 1-gph emitters	Placed 6 to 12 inches from base of plant.
Shrubs or trees to 5 feet tall	Two or three 1-gph emitters	Placed 12 inches from base of plant.
Shrubs or trees 5 to 10 feet tall	Three to four 1-gph emitters, or one or two 2-gph emitters	Equally spaced 2 to 3 feet from base of plant.

Trees
>10 feet tall

Four to six
1-gph emitters,
or two or three
2-gph emitters

Equally spaced
about 4 to 8 feet
from trunk. Gen-
erally, for a sin-
gle tree, multiple
emitters are bet-
ter than fewer.

(i) Irrigating stream side (riparian) trees and shrubs

When supplying moisture to establish deep rooting trees in stream side riparian areas, point source micro irrigation emitters encourage deep rooting in layered coarse soils overlaying a water supply.

Using a power-pole sized auger (for trees), drill a hole at least 2 feet below the water table; then backfill hole with material removed. A post hole sized auger can be used for most shrubs. Backfill material will be free of horizontal soil layers caused by compaction and soil gradation (typically present in most water and wind deposited soils). Plant the tree or shrub near or in the hole, then locate an emitter at the top of the backfilled hole. Once the plant is established, irrigate with long duration, less frequent applications. Water will move down the disturbed soil profile. Developing roots will follow the irrigation water in the disturbed hole down to the water table. Long-term nonirrigated successful riparian vegetation (trees and shrubs) can be established 15 to 20 feet above a water source.

652.0604 Subirrigation systems

(a) General

Subirrigation is a water table management system that controls the elevation of a water table to provide water necessary for desired crop growth. A water table management system can lower an existing water table, maintain an existing water table, or raise a water table to a desirable elevation. A water table is generally held at a constant elevation during a crop growing season, but can be fluctuated. Water from a water table is supplied to plant roots by upward capillary water movement through the soil profile, also referred to as upflux. Water table is controlled by:

- Providing subsurface drainage to lower or maintain an existing water table, or by removing water from the soil profile using buried laterals.
- Providing controlled drainage by capturing rainfall to raise a water table to a desired elevation at or above the buried laterals.
- Introducing irrigation water via a buried lateral system to raise or maintain a water table at desired elevation at or above the buried laterals.

(1) Primary objectives of a water table management system

- Provide for trafficability of the soil surface for timely use of farm equipment.
- Reduce crop stress caused by excess water in the plant root zone.
- Reduce crop stress caused by deficiency of available soil moisture in the plant root zone.
- Provide a better root development environment in the soil.
- Minimize harmful offsite environmental pollution.
- Maximize use of rainfall.
- Minimize need for additional irrigation water.
- Control salinity.

(2) Advantages

- Permits storage of water in lower part of soil profile.
- Reduces need for pumping irrigation water for meeting crop water requirements.
- Can incorporate a subirrigation lateral system with a subsurface drainage lateral system with low additional cost.
- Reduces drainage pumping costs if required.
- Can be relatively easy to automate control of water levels in control structures.
- Captures plant nutrients at or near the water table for future use by plants.

(3) Disadvantages

- Labor intensive to manually adjust the elevation of weirs in water control structures to change from drainage mode to irrigation mode.
- Labor intensive to set and readjust automatic water level controlled mechanisms in water control structures. However, labor is minimal once they are adequately set.
- Total system costs can be relatively high in soils that have low hydraulic conductivity and are in high rainfall areas with undulating topography.
- Water quality must be high.
- In saline areas, an intensive salt content monitoring and management program is required to prevent excessive long-term upward movement and accumulation of damaging salts. Salt-tolerant crops can be effectively irrigated with saline water from a shallow water table, but where low salt-tolerant crops are included in the cropping rotation, downward movement of salts at some time may be required. The latter would require using excess irrigation water for leaching of salts, thus requiring free drainage. Offsite environmental pollution can occur where drainage effluent high in salts is allowed to enter surface water.

(b) Irrigation system components

A water table management system can consist of buried drainage or irrigation laterals, submains, mains, water table control structures, irrigation water intake structures, flow measuring devices, surface or buried irrigation water supply pipelines, a pumping plant, and power supply.

Buried laterals consist of a system of underground conduits generally spaced at uniform intervals. In the drainage mode, laterals discharge into a system of collectors or submains that outlet into mains. In the irrigation mode, flow is then reversed. Figure 6-24 displays a schematic of typical water management system with subsurface drainage laterals used for drainage or subirrigation. Separate systems for irrigation and drainage are encouraged for maximum efficiency.

The size, spacing, and depth of laterals are a function of soil hydraulic conductivity, desired elevation of water table in relation to ground surface (depth), available flow from soil mass to and from pipelines, available hydraulic gradient of laterals, and desirable time to reach a planned water table elevation. The size of submains and mains are a function of soil hydraulic conductivity and area served, lateral layout, discharge to and from laterals, and available hydraulic gradient of submains and mains.

Although separate subirrigation and drainage systems are more efficient, dual purpose systems are often used. Dual purpose systems generally require resetting slide gates and flashboards when changing from drainage to irrigation or irrigation to drainage modes; sometimes several times each growing season.

Each lateral (or group of laterals) requires a water table control structure in or near the submain. The water table control structure can be set manually or automatically to either allow free drainage or to establish a water table elevation upstream of the structure.

Irrigation intake structures are vertical pipes located in submains that simply allow input of irrigation water at the ground surface from an external water source. In the irrigation mode, water flows from the submains into the laterals and then out of the laterals into the soil. External water is supplied when rainfall does not maintain the desired water table elevation.

The most common pipe material for buried laterals is corrugated polyethylene plastic pipe (CPP). It can be installed either as perforated or nonperforated tubing preferably using laser grade controlled trenching and installation equipment.

(c) Planning and design considerations

(1) Controls

Water table elevation is commonly controlled by a manually adjusted weir for a group of laterals where submains discharge into the main. When excessive rainfall occurs, the water level in the control structure is lowered to allow free flow through the structure. This allows the drainage system to remove excess water more quickly.

The operator must decide when to raise or reset the weir to allow the water table to reestablish itself at the desirable height. If done too early the water table is held too high, and if done too late the water will have drained, thereby losing valuable water.

One solution is to provide an automatic water level control system. Float controlled valves can be used in place of the manually adjusted weir. When excessive rainfall events cause drainage outflow, the float mechanism opens a drain valve. As drainage outflow

Figure 6-24 Typical water table management system

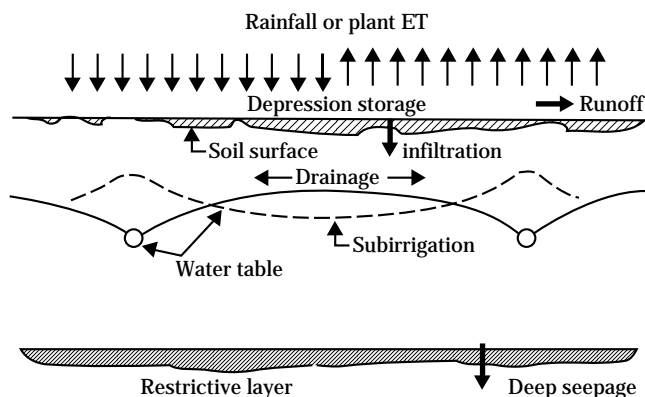

decreases, the float mechanism closes the drain valve as necessary. To maintain the water table at the desired elevation during periods of expected rainfall, it may be desirable to lower the controlled water table elevation 3 to 6 inches. This will increase available soil-water storage and allow the float controlled mechanism to discharge larger volumes of water during or immediately after heavy rainfall events.

(2) Upward water flow

Upward water flow (up flux) rate is a function of soil properties, primarily texture, and water table depth. Upward flow rate is generally most significant for medium textured soils where the hydraulic gradient and hydraulic conductivity together produce a usable rate of water supply.

Figure 6–25 displays water table contribution to meet irrigation requirements as a function of soil type and water table depth. For a sandy loam soil to meet a crop ET rate of 0.2 inch per day in a steady state upward flow condition, the water table needs to be held at about a 2-foot depth. However, with either clay or sand, the water table depth needs to be about 0.5 foot. Additional details are provided in NEH, Part 623 (Section 15), Chapter 2, Irrigation Water Requirements. Also refer to section 652.0605 for local data on soils versus upward flow rate characteristics.

(3) Installation

Installation of buried drainage pipe can be accomplished with a variety of equipment and labor including:

- Laser grade controlled trenching or plow-in equipment with continuous placement of CPP drainage tubing, with or without filter or envelope material.
- Laser or nonlaser controlled trenching equipment with hand installed CPP drainage tubing, clay or concrete tile, and semirigid perforated plastic or perforated steel pipe.
- Backhoe type equipment with hand installed CPP drainage tubing, clay or concrete tile, and semirigid perforated plastic or perforated steel pipe.

Most common buried drainage pipe is corrugated polyethylene plastic pipe (CPP) tubing. However, concrete and clay tile or perforated PVC plastic or steel pipe can be used. With concrete and clay tile, the joints are butted together with no gaskets. Protection is needed to prevent soil particle movement into the

pipeline at the open joints. When water is introduced into a subsurface irrigation system (buried conduits), velocities through the perforations or joints are typically higher than those in the drainage mode. The higher velocities can dislodge soil particles that can then move into the conduit in the drainage mode. Depending on soil characteristics, flow rate and velocity, opening size, and configuration in the buried conduit, filters, and envelope material may be needed. See NEH, Section 16, Drainage, or the local drainage guide for additional details on filter and envelope design criteria.

(d) Design procedures

In many areas design procedures and criteria are based on local field experience. Retrofitting of existing subsurface drainage systems to water table management systems typically involves the installation of water table control structures. The area to be subirrigated will closely coincide with the area drained. To assure full field coverage, additional buried laterals may need to be installed for subirrigation laterals.

NRCS has supported the development of computer models to assist with planning, design, and operation of water table management systems. These models include DRAINMOD and SI-DESIGN.

(1) DRAINMOD

This computer model was developed by North Carolina State University (Richard “Wayne” Skaggs) with NRCS support. DRAINMOD is a simulation model that characterizes responses in a soil-water regime to various combinations of subsurface and surface water management operations. It can predict the response of a water table and soil water movement above a water table to rainfall, crop ET, various degrees of subsurface and surface drainage, and the use of water table control. It was originally intended for use mostly in humid areas, but can be used anywhere historical hourly rainfall data are available. Soil parameters for use in the model are developed by the computer program, DMSOILS.

Figure 6-25 Water table contribution to irrigation requirements as a function of water table depth and soil type

Soil type	Line number
Sticky clay	1
Loamy sand	2
Clay	3
Peat	4
Clay loam	5
Sandy loam	6
Fine sandy loam	7

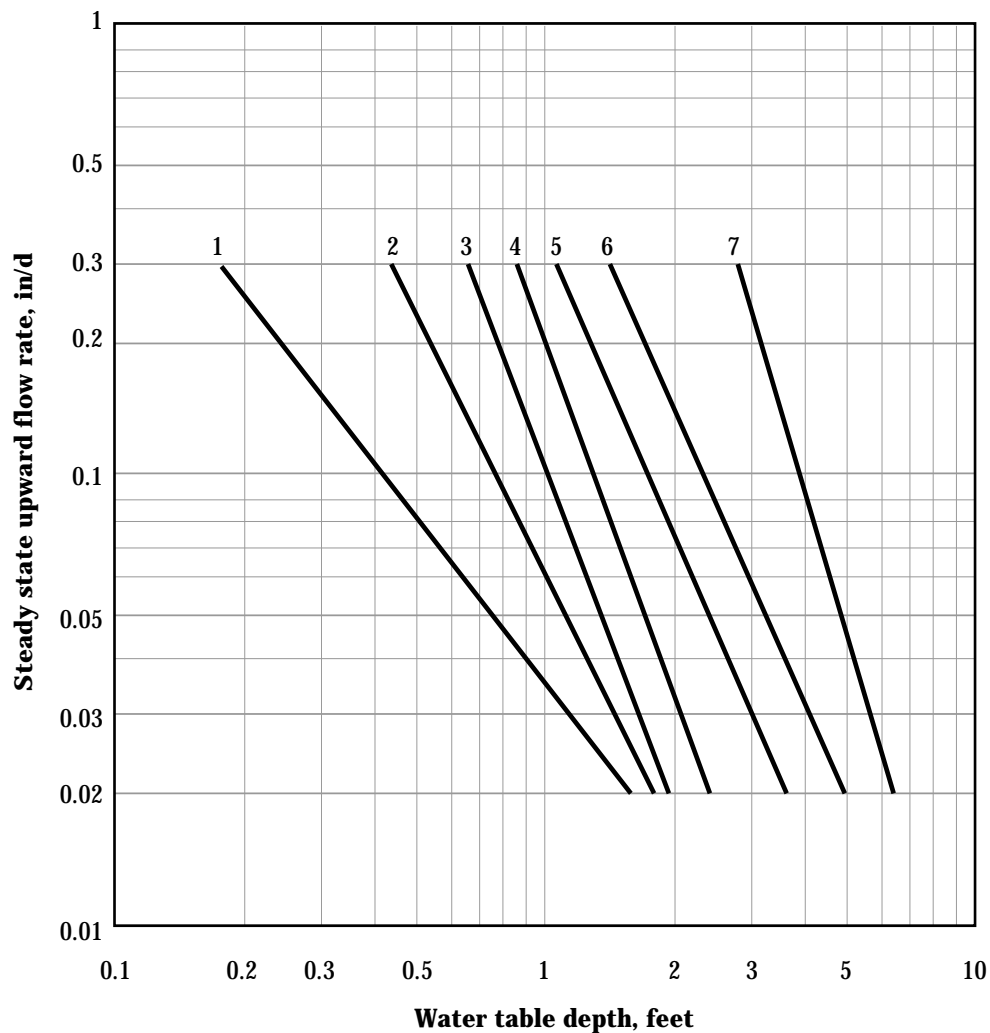

(2) SI-DESIGN

This model was developed by Michigan State University (Harold "Bud" Belcher) with NRCS support. The objective of the model is to aid efficient design of water table management systems. It has modules for:

- Rainfall management—Calculates design rainfall amounts using historic growing season rainfall at desired frequency of occurrence.
- Investigating effect of buried lateral systems—Depth to lateral and to water table at midpoint between laterals, lateral diameter, hydraulic gradient of laterals, area effected (length and spacing).
- Assisting in determining the diameter of submains and mains.
- Evaluating the economic efficiency of production versus system components—Diameter, depth, and lateral spacing.

Specific locally approved design procedures and design examples are provided in section 652.0605.

652.0605 State supplement

Design procedures, tables, figures, charts, and design examples are presented using state approved procedures and computer programs. Complete procedures for planning and designing micro systems are in NEH, Part 623, (Section 15), Chapter 7, Trickle Irrigation. Supplier equipment catalogs and manufacturers' technical data are necessary for specific designs. Many types, shapes, and sizes of emitters, porous tubing, flexible PE plastic lateral tubing, and other accessories are commercially available.

WA652.0605 State Supplement

Irrigation System Design

Irrigation system design information is obtained from a number of software programs and guides. Information is available on the web (see Chapter 5, Section 652.0505) for a number of different sources. Other information is contained in NRCS references such as NEH Section 15. Section 15 has various chapters on different types of system.

This state supplement section includes some basic information which can be used to design irrigation systems with the above listed references material. The following tables and reference material include information that is not readily available.

Table WA6-1, titled “GPM/Acre Requirement to Meet Peak Consumptive Use Irrigating 24 hrs/day,” should be used in order to calculate the acres that can be irrigated from the crop consumptive use amount (Chapter 4) and the efficiency of the system. The flow rate of the water supply must be adequate to meet peak crop consumptive use. The landowner may want to alter cropping patterns to more effectively utilize water supplies. For instance, planting the entire acreage to alfalfa would require a peak water use in July and August. Planting part of this acreage to winter wheat would move the peak use rate to the spring months. Normally, there would be a larger water supply available in the spring with a surface water source and the peak use in July and August could be reduced.

Another alternative would be to use a limited irrigation approach. Using the information in the Washington supplement (Chapter 3, Crops) of the National Irrigation Guide (NIG) to determine when to apply irrigation water when limited supplies are available will help to maximize production with a limited water supply.

These alternatives need to be evaluated in light of current market conditions. The objective is to

maximize economic returns for the landowner, not necessarily to maximize crop production.

Use Table WA6-1 to obtain system flow rate (GPM/Acre) from the peak consumptive use rate and the system efficiency.

Irrigation application efficiencies are shown in Table WA6-2, for typical systems used in Washington. The average efficiency column would be considered normal for design.

Example:

A landowner has a flow of 1000 gpm. The peak consumptive use of the crop is 0.25 inch/day. How many acres can be irrigated with a furrow system at 50 percent irrigation efficiency irrigating 24 hours per day? From Table WA6-1, find 9.4 gpm/acre needed.

$$\begin{aligned} \text{Acres} &= 1000 \text{ gpm} / 9.4 \text{ gpm/acre} \\ &= 106 \text{ acres can be irrigated} \end{aligned}$$

How many acres can be irrigated with 65 percent efficiency? Again from Table WA6-1, find 7.3 gpm/acre.

$$\begin{aligned} \text{Acres} &= 1000 \text{ gpm} / 7.3 \text{ gpm/acre} \\ &= 137 \text{ acres can be irrigated} \end{aligned}$$

For a different number of irrigation hours per day than 24, the formula below the table must be used. An Excel workbook could be used to create tables similar to Table WA6-1 for other time increments.

For a system that is only operated for 15 hours per day at 50 percent efficiency, what is the gpm/acre to apply the 0.25 inches per day?

$$q = \frac{(453) \times (d) \times (A)}{(t) \times (E)} = \frac{(453) \times (0.25 \text{ in.}) \times (1.0 \text{ ac.})}{(15 \text{ hr.}) \times (0.50)}$$

$$q = 15.1 \text{ gpm/acre}$$

Where:

d = net application depth in inches

A = acres

T = time in hours

E = irrigation efficiency of the system

$$E = \frac{\text{net irrigation}}{\text{gross application}}$$

Table WA6-1 GPM/Acre Requirement to Meet Peak Consumptive Use Irrigating 24 hrs./day

Consumptive Use in Inches/Day													
Irrigation Eff.	0.15	0.16	0.17	0.18	0.19	0.20	0.21	0.22	0.23	0.24	0.25	0.26	0.27
30%	9.4	10.1	10.7	11.3	12.0	12.6	13.2	13.8	14.5	15.1	15.7	16.4	17.0
40%	7.1	7.6	8.0	8.5	9.0	9.4	9.9	10.4	10.9	11.3	11.8	12.3	12.7
50%	5.7	6.0	6.4	6.8	7.2	7.6	7.9	8.3	8.7	9.1	9.4	9.8	10.2
60%	4.7	5.0	5.3	5.7	6.0	6.3	6.6	6.9	7.2	7.6	7.9	8.2	8.5
65%	4.4	4.6	4.9	5.2	5.5	5.8	6.1	6.4	6.7	7.0	7.3	7.6	7.8
70%	4.0	4.3	4.6	4.9	5.1	5.4	5.7	5.9	6.2	6.5	6.7	7.0	7.3
75%	3.8	4.0	4.3	4.5	4.8	5.0	5.3	5.5	5.8	6.0	6.3	6.5	6.8
80%	3.5	3.8	4.0	4.2	4.5	4.7	5.0	5.2	5.4	5.7	5.9	6.1	6.4
85%	3.3	3.6	3.8	4.0	4.2	4.4	4.7	4.9	5.1	5.3	5.6	5.8	6.0
90%	3.1	3.4	3.6	3.8	4.0	4.2	4.4	4.6	4.8	5.0	5.2	5.5	5.7
95%	4.0	3.2	3.4	3.6	3.8	4.0	4.2	4.4	4.6	4.8	5.0	5.2	5.4

Consumptive Use in Inches/Day													
Irrigation Eff.	0.28	0.29	0.30	0.31	0.32	0.33	0.34	0.35	0.36	0.37	0.38	0.39	0.40
30%	17.6	18.2	18.9	19.5	20.1	20.8	21.4	22.0	22.7	23.3	23.9	24.5	25.2
40%	13.2	13.7	14.2	14.6	15.1	15.6	16.0	16.5	17.0	17.5	17.9	18.4	18.9
50%	10.6	10.9	11.3	11.7	12.1	12.5	12.8	13.2	13.6	14.0	14.3	14.7	15.1
60%	8.8	9.1	9.4	9.8	10.1	10.4	10.7	11.0	11.3	11.6	12.0	12.3	12.6
65%	8.1	8.4	8.7	9.0	9.3	9.6	9.9	10.2	10.5	10.7	11.0	11.3	11.6
70%	7.6	7.8	8.1	8.4	8.6	8.9	9.2	9.4	9.7	10.0	10.2	10.5	10.8
75%	7.0	7.3	7.6	7.8	8.1	8.3	8.6	8.8	9.1	9.3	9.6	9.8	10.1
80%	6.6	6.8	7.1	7.3	7.6	7.8	8.0	8.3	8.5	8.7	9.0	9.2	9.4
85%	6.2	6.4	6.7	6.9	7.1	7.3	7.6	7.8	8.0	8.2	8.4	8.7	8.9
90%	5.9	6.1	6.3	6.5	6.7	6.9	7.1	7.3	7.6	7.8	8.0	8.2	8.4
95%	5.6	5.8	6.0	6.2	6.4	6.6	6.8	7.0	7.2	7.4	7.6	7.7	7.9

This table is based on the formula
$$Q = \frac{(453) \times (d) \times (A)}{(t) \times (E)}$$

where Q = gallons per minute irrigation flow rate

453 = conversion factor

d = net application depth in inches

A = acres

t = time in hours

E = irrigation efficiency of the system = $\frac{\text{net irrigation}}{\text{gross application}}$

Table WA6-2 Application efficiency range for various irrigation systems¹

Type	Range	Avg (%)
Surface Irrigation		
Level Basin	80-95	85
Graded Border	50-80	65
Furrow or Corrugations	50-80	65
Surge	60-90	75
Micro Irrigation		
Point Source Emitter	70-95	88
Line Source Emitter	75-95	90
Spray Emitter	70-95	85
Sprinkler Irrigation		
Handline/Wheeline	60-85	75
Traveling Big Gun	55-75	65
Solid Set (Above Canopy)	60-75	60
Solid Set (Below Canopy)	70-85	75
Center Pivot		
Impact Sprinkler w/end gun	75-90	80
Drops, spray heads w/o end gun	75-95	85
Lateral Move		
Spray heads		
w/ hose feed	75-95	90
w/ canal feed	75-95	85

Wind and temperature can affect efficiency. For example – a 5/32” nozzle will loose 9% in winds of 5 mph and 80⁰ F.

A 5/32” nozzle will loose about 20% if wind is 15 mph. The losses will reach 26% with 15 mph wind and temperatures of 100⁰ F.²

¹ IRRIGATION SYSTEM EFFICIENCIES,2002, Terry A. Howell, ARS, Bushland, TX

² Montana State Univ, Extension Service – Wind Effects on Irrigation Efficiency – Management Harder than it Sounds! Jim Bauder,

Polyacrylamide

Polyacrylamide (PAM) has been used for the past 15 years on surface irrigation fields to reduce erosion. The amount of sediment saved has been shown to be 96% of the non-PAM field. The following excerpt on polyacrylamide is from the Nebraska Extension Service¹. This is included to show the benefit of PAM on soils, crops, and field configurations similar to those found in Central Washington.

Research was conducted at the Panhandle Research and Extension Center in Scottsbluff, Nebraska in 1996 and 1997. Furrow stream size was approximately 12 g.p.m. Field slope was 0.2 percent and field length was 1,000 feet. The soil was a Tripp, very fine sandy loam. The crop grown was dry beans in 30-inch rows with every

other row irrigated. Furrow advance time to 1,000 feet and sediment loss (tons/acre) were measured and given in *Figures 1-3*.

In 1996, the three treatments were: 1) PAM; 2) no PAM; and 3) patch PAM. *Figures 1* and *2* show the results for three irrigations during the growing season. The patch PAM treatment was done by sprinkling PAM in the dry furrow before water was started. Advance time was similar for all treatments. The amount of soil loss was greatest for the no PAM treatment and the least for the PAM treatment. The patch PAM treatment, although providing some reduction in erosion, was not as effective as having the PAM mixed with the water prior to application.

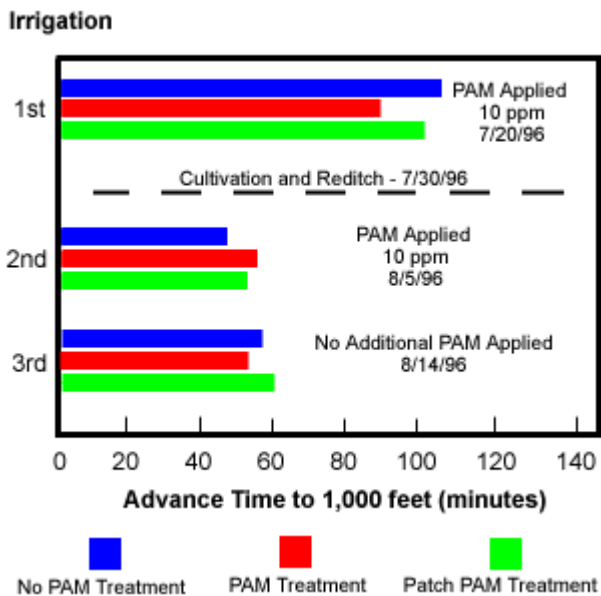

Figure WA6-1. Furrow advance time to 1,000 feet for each irrigation, treatment of no PAM, PAM and patch PAM (1996).

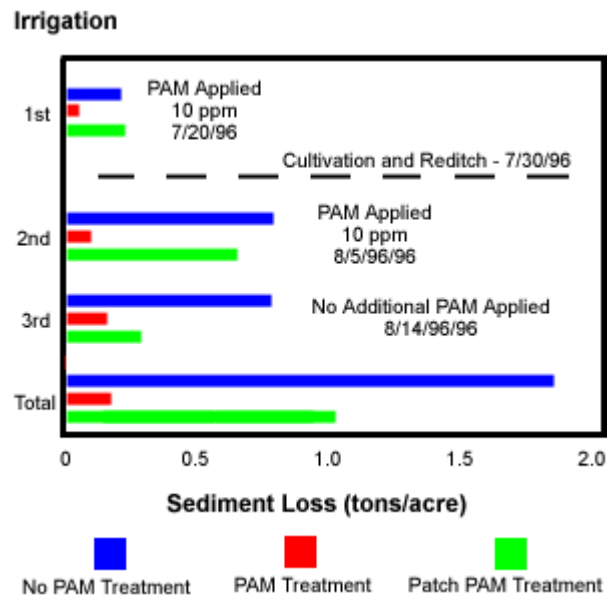

Figure WA6-2. Sediment loss (tons/acre) for each irrigation and total sediment loss (tons/acre) for treatments of no PAM, PAM and patch PAM (1996).

In 1997, four treatments were compared: 1) PAM; 2) no PAM; 3) surge irrigation with PAM; and 4) surge irrigation with no PAM. These results are shown in *Figure 4*. The advance time to 1,000 feet was similar for all four treatments during the three irrigations. However, the advance times for the treatments using surge irrigation were slightly below the advance times for the conventional irrigation treatments. Soil erosion was consistently less when PAM was mixed with the irrigation water.

If a producer is using surge and wants to try using PAM, particular attention should be paid to furrow

advance time. Surge irrigation, through its wetting and drying process, tends to seal the surface of the soil and reduce intake rate. This, in turn, advances water down the field faster.

On many soils, PAM tends to increase soil intake rate by maintaining open pores on the soil surface. The result may be slower water advance times. Using polyacrylamide in irrigation water probably means water management strategies must change. For more information on making management changes to furrow irrigation systems, see [NebGuide G97-1338, *Managing Furrow Irrigation Systems*](#).

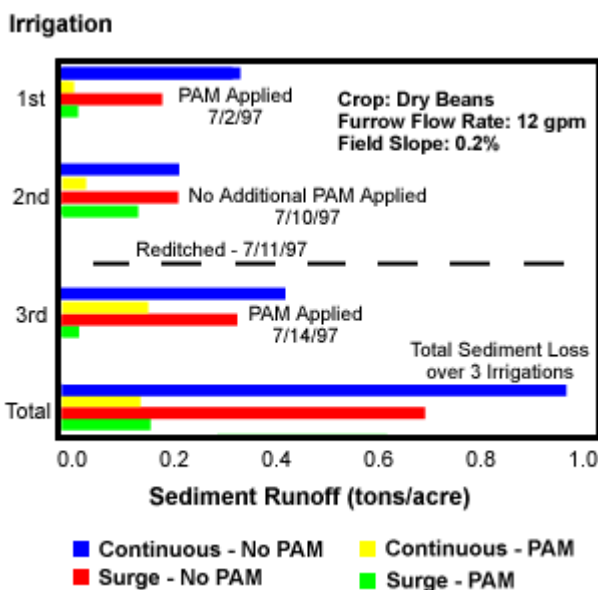

Figure WA6-3. Sediment loss (tons/acre) for each irrigation and total sediment loss (tons/acre) for treatments of no PAM – continuous irrigation, PAM – continuous irrigation, no PAM – surge irrigation and PAM – surge irrigation (1997).

Sprinkler Irrigation

Typical irrigation precipitation rates are given below. This is based on the following equation:

$$\text{Prec. Rate} = \frac{\text{Nozzle - gpm} * 96.3}{\text{Spacing - ft}}$$

Table WA6-3 Irrigation Precipitation Rate, inches per hour

Spacing - ft	Discharge per Sprinkler - gpm																			
	1	2	3	4	5	6	7	8	9	10	12	15	20	25	30	40	50	60	70	80
20x20	0.2	0.4	0.7	0.9	1.2	1.4	1.6	1.9	2.1	2.4										
20x30	0.1	0.3	0.4	0.6	0.8	0.9	1.1	1.2	1.4	1.6	1.9									
20x40	0.1	0.2	0.3	0.4	0.6	0.7	0.8	0.9	1.0	1.2	1.4	1.8								
20x50	0.1	0.1	0.2	0.3	0.4	0.5	0.6	0.7	0.8	0.9	1.1	1.4	1.9							
20x60	0.0	0.1	0.2	0.3	0.4	0.4	0.5	0.6	0.7	0.8	0.9	1.2	1.6	2.0						
25x25	0.1	0.3	0.4	0.6	0.7	0.9	1.0	1.2	1.3	1.5	1.8	2.3								
30x30	0.1	0.2	0.3	0.4	0.5	0.6	0.7	0.8	0.9	1.0	1.2	1.6	2.1							
30x40	0.0	0.1	0.2	0.3	0.4	0.4	0.5	0.6	0.7	0.8	0.9	1.2	1.6	2.0	2.4					
30x50	0.1	0.1	0.2	0.3	0.3	0.4	0.5	0.5	0.6	0.7	0.9	1.2	1.6	1.9	2.1					
30x60	0.1	0.1	0.2	0.2	0.3	0.3	0.4	0.4	0.5	0.6	0.8	1.0	1.3	1.6	2.1					
40x40	0.1	0.1	0.2	0.3	0.3	0.4	0.4	0.5	0.6	0.7	0.9	1.2	1.5	1.8	2.4					
40x50	0.1	0.1	0.1	0.2	0.2	0.3	0.3	0.4	0.4	0.5	0.7	0.9	1.2	1.4	1.9					
40x60	0.1	0.1	0.2	0.2	0.2	0.3	0.3	0.4	0.4	0.6	0.8	1.0	1.2	1.6	2.0					
40x80	0.0	0.1	0.1	0.1	0.1	0.2	0.2	0.2	0.3	0.3	0.4	0.6	0.7	0.9	1.2	1.5	1.8	2.1		
50x50	0.1	0.1	0.1	0.2	0.2	0.3	0.3	0.3	0.4	0.5	0.7	0.9	1.1	1.5	1.9	2.3	2.7			
50x60	0.1	0.1	0.1	0.1	0.2	0.2	0.2	0.2	0.3	0.3	0.4	0.6	0.8	0.9	1.2	1.6	1.9	2.2		
50x70	0.1	0.1	0.1	0.1	0.1	0.1	0.2	0.2	0.2	0.3	0.4	0.5	0.6	0.8	1.1	1.3	1.6	1.9	2.2	
50x80	0.1	0.1	0.1	0.1	0.1	0.1	0.2	0.2	0.2	0.2	0.3	0.4	0.6	0.7	0.9	1.2	1.4	1.6	1.9	
60x60	0.1	0.1	0.1	0.1	0.1	0.1	0.2	0.2	0.2	0.3	0.4	0.5	0.6	0.8	1.0	1.3	1.6	1.8	2.1	
60x70	0.1	0.1	0.1	0.1	0.1	0.1	0.2	0.2	0.2	0.3	0.4	0.5	0.6	0.9	1.1	1.3	1.6	1.8	2.1	
60x80	0.1	0.1	0.1	0.1	0.1	0.1	0.2	0.2	0.2	0.3	0.4	0.5	0.6	0.8	1.0	1.2	1.4	1.6	1.9	
70x70	0.1	0.1	0.1	0.1	0.1	0.1	0.2	0.2	0.2	0.3	0.4	0.5	0.7	0.9	1.1	1.3	1.6	1.8	2.1	
70x80	0.1	0.1	0.1	0.1	0.1	0.1	0.2	0.2	0.2	0.3	0.4	0.5	0.6	0.8	1.0	1.2	1.4	1.6	1.9	
70x90	0.1	0.1	0.1	0.1	0.1	0.1	0.2	0.2	0.2	0.3	0.4	0.5	0.6	0.8	1.0	1.2	1.4	1.6	1.9	
80x80	0.1	0.1	0.1	0.1	0.1	0.1	0.2	0.2	0.2	0.3	0.4	0.5	0.6	0.8	1.0	1.2	1.4	1.6	1.9	
80x90	0.1	0.1	0.1	0.1	0.1	0.1	0.2	0.2	0.2	0.3	0.4	0.5	0.6	0.8	1.0	1.2	1.4	1.6	1.9	

	0.1	0.1	0.1	0.1	0.1	0.2	0.3	0.3	0.4	0.6	0.7	0.8	0.9
80x100	0	1	2	4	8	4	0	6	8	0	2	4	6
100x100			0.1	0.1	0.1	0.1	0.2	0.2	0.3	0.4	0.5	0.6	0.7
			0	2	4	9	4	9	9	8	8	7	7

ⁱ G98-1356- **Polyacrylamide – A Method to Reduce Soil Erosion** - This NebGuide describes polyacrylamide, what it is, how it can be used to reduce soil erosion due to, irrigation and what water management changes must be considered. - C. Dean Yonts, Extension Irrigation Engineer, Brian Benham, Extension Water Management Engineer

Chapter 7

Farm Distribution Components

Contents:	652.0700	General	7-1
	652.0701	Pipelines	7-2
		(a) Typical pipe installation and materials for irrigation systems	7-2
		(b) Specific applications	7-3
	653.0702	Open ditches	7-4
		(a) Unlined ditches	7-4
		(b) Lined ditches	7-4
		(c) Seepage losses	7-5
	652.0703	Water control structures	7-6
		(a) Related structures for open ditches	7-6
		(b) Related structures for gravity pipelines	7-8
		(c) Related structures for pumped pipelines	7-8
	652.0704	Water measurement	7-9
		(a) Planning and design considerations	7-9
	652.0705	Irrigation runoff, tailwater recovery and reuse	7-11
		(a) Planning and design considerations	7-11
	652.0706	Irrigation system automation	7-15
		(a) Planning and design considerations for automation	7-15
	652.0707	Pumping plants	7-17
	652.0708	Drainage systems	7-18
		(a) Precipitation runoff	7-18
		(b) Irrigation runoff (tailwater)	7-19
		(c) Subsurface drainage	7-19
		(d) Environmental factors	7-20
	652.0709	Chemigation	7-21
		(a) Advantages	7-21
		(b) Disadvantages	7-21
		(c) Planning and design considerations	7-22
	652.0710	State supplement	7-29

Tables	Table 7-1	Expected recovery from runoff	7-13
	Table 7-2	Tailwater pit sizing for intermittent pumpback facility	7-14
	Table 7-3	Overall efficiencies obtainable by using tailwater recovery and reuse facility	7-14
	Table 7-4	Liquid fertilizers (solutions) for sprinkler application	7-27
	Table 7-5	Dry fertilizers for sprinkler application	7-28
	Table 7-6	Comparison of typical analysis of clear suspension-type liquid fertilizers	7-28
	Figures	Figure 7-1	Irrigation water distribution system layout for several fields and various irrigation methods and systems
Figure 7-2		Typical tailwater collection and reuse facility for quick-cycling pump and reservoir	7-11
Figure 7-3		Gravity flow from storage tank	7-23
Figure 7-4		Injection on suction side of pump	7-23
Figure 7-5		Venturi principle of injection	7-23
Figure 7-6		Pitot tube injection	7-23
Figure 7-7		Pressure metering pump injection	7-24
Figure 7-8		Backflow prevention device using check valve with vacuum relief and low pressure drain	7-25
Figure 7-9		Safety devices for injection of chemicals into pressurized irrigation systems using electric power	7-26
Figure 7-10		Safety devices for injection of chemicals into pressurized irrigation systems using internal combustion engine power	7-26

652.0700 General

Irrigation water should be made available to each part of the farm irrigation system at a rate and elevation or pressure that permits proper operation of irrigation application devices or facilities. Irrigation water should be conveyed as economically, efficiently, and safely as possible without excessive losses or erosion. Water should be delivered to the plant at a suitable quality for the planned purpose. All components of a farm irrigation water delivery system must be sized to furnish adequate irrigation water to meet planned crop use or scheduled delivery from an irrigation district. If

water is delivered on a rotation or turn basis, the system must be large enough to allow delivery of water in the time allowed. Plans should provide for future needs and expansion. Figure 7-1 displays a typical multifield delivery system for various irrigation methods and systems.

Sizing a system to meet peak (or planned) period crop water use requires careful consideration of many alternatives and compromises. They involve ditch and pipe size, pump size, labor considerations, capital investment, operating costs, available water capacity of soils, crop rotations, plant stress risk levels, and overall management of the farm enterprise. Providing water, along with good water management, to meet

Figure 7-1 Irrigation water distribution system layout for several fields and various irrigation methods and systems

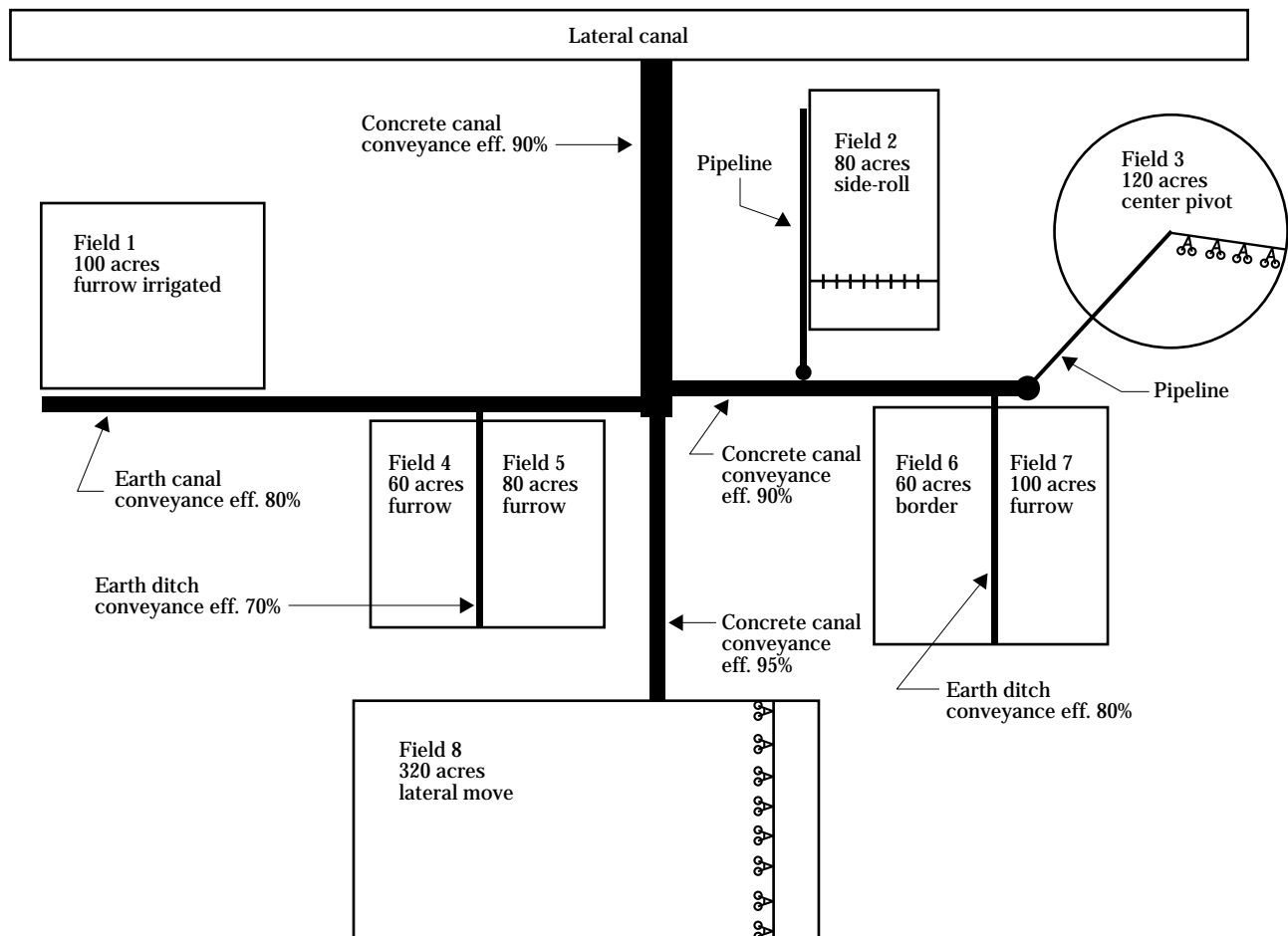

crop needs 80 percent or even 50 percent of the time can be more economical than providing full irrigation for all conditions. This is especially true in humid and semihumid areas where a substantial part of plant water need is provided by rainfall.

Farm distribution components (facilities) include all necessary appurtenances, such as water control structures, slide gates, trash racks, screening devices, water measuring devices, flow control valves, air release valves, vacuum relief valves, pressure regulating or relief valves, controllable flow turnouts and drains, plus other components necessary for the long-term operation and maintenance of the system. All facilities should be located so they interfere as little as possible with farming operations. Components of the distribution system should be readily accessible for operation and maintenance. An operation and maintenance plan should be provided as part of the system plan or design.

Water delivery should be adaptable to meet specific crop water needs for each irrigation system used. Basic components of distribution systems include pipelines, unlined and lined open ditches, water control structures, water measurement devices, tailwater recovery and reuse facilities, system automation, pumping plants, surface drainage systems, and chemical storage, injection and transport facilities.

Design criteria, procedures, friction loss tables and charts, and design examples are provided in many Natural Resources Conservation Service (NRCS) references. These references include National Engineering Handbook (NEH) Part 634 (Section 3), Hydraulics; NEH Part 623 (Section 15), Irrigation; National Engineering Field Handbook, Chapters 3, Hydraulics, and 15, Irrigation; and several design notes and technical releases. Many programmable calculator and computer programs are also available to assist in the design of pipelines, open ditches, and pumping plants. References, tools, and programs most commonly used are included in 652.0710, State Supplement, and in Chapter 15, Resource Planning and Evaluation Tools and Worksheets.

652.0701 Pipelines

Pipeline delivery systems can be pumped or gravity flow and consist of buried pipe, surface installed pipe, or both. A buried pipe can extend from a water source to the farm and to individual fields with surface pipe used for distribution within the field. Buried pipe can also extend into fields as a field main (or submain) and have risers and valves appropriately spaced to deliver water to surface ditches, portable water conveyance pipelines, gated pipe, or sprinkler laterals.

(a) Typical pipe installation and materials for irrigation systems

(1) Culverts

Culverts are generally short pipe sections where partial pipe flow conditions exist.

Typical use includes:

- Equipment crossings in open channels (canals, laterals, ditches)
- Water control structures with flow control gate installation
- Water measuring

Materials are generally galvanized steel or aluminum corrugated pipe; PVC plastic pipe; corrugated PE (regular or smooth bore) plastic pipe; and reinforced or nonreinforced concrete pipe.

(2) Gravity pipelines

Generally gravity pressure pipelines are longer pipe sections where full pipe flow, partial pipe flow, or a combination of both conditions exist. They rely on elevation drop to provide sufficient hydraulic gradient for flow to occur. Gravity pipelines are used to transport water in a conveyance or distribution system, or from a source to point of use, as buried or surface, permanent or portable pipes. Typical use includes:

- Water conveyance pipelines to reduce seepage and evaporation losses, prevent erosion, or provide control of water delivery.
- Inverted siphons to replace flumes or to cross low areas including gullies.
- Gated pipe to distribute water into furrows.
- Pipelines to provide gravity pressure for sprinkler or micro irrigation systems.

Materials are generally plastic, welded steel, galvanized steel, reinforced or nonreinforced concrete, reinforced fiber glass, or aluminum.

(3) Pumped pressure pipelines

Pumped pressure pipelines can be buried or surface installed. Generally longer sections are used where full pipe flow conditions exist and shorter sections where water is pumped from a source (pond, canal, stream, well) to an open ditch that is close by. A pump is used to provide adequate pressure head to overcome elevation and pipe and fitting friction losses. Pipelines can be permanent or portable. They are used to transport water in a conveyance and distribution system or from source to point of use. Typical use includes:

- Pipe within a pumping plant system that lifts water from source to open ditch or field.
- Conveyance and distribution system.
- Pipelines to contain pressurized flows for use in sprinkler and micro irrigation systems.

Materials are generally welded steel, galvanized steel, aluminum, or plastic.

(b) Specific applications

Gated pipe is a surface portable pipe (generally PVC or aluminum) used to distribute controlled flows to furrows at very low pressure head (< 1 to 2 lb/in²). Disposable, thin wall (7 or 10 mil), lay-flat PE pipe is also available. Its use is generally limited to 1 or 2 years. With the pipeline filled with water, a hand punch mounted on a handle, approximately 2 feet long, is moved in an arc to create holes (or gates) at each furrow. Hole sizes are selected to discharge predetermined amounts of water at each furrow, based on head available in the pipeline. Pipeline grades can be established where only two or three hole sizes are necessary in a quarter-mile pipeline. Maximum head (pressure) in lay-flat PE pipe must be less than 10 feet (4 psi).

Gated pipe can be used in place of an open head ditch at the upper end of a field. It is also well suited to use in place of an intermediate temporary head ditch on fields too long to be irrigated in one length of run. Socks or other devices attached to each gate help to reduce exit velocities; thereby minimizing erosion at the head of furrows. The degree the gates are opened accurately regulates water flow to each furrow. Where

water source to the gated pipe is from open ditches, screening for debris removal may be necessary to prevent plugging of gate openings. Gated pipe is used in cablegation and surge systems. Once gated pipe is installed at the head of the fields for the duration of the irrigation season and the gates are adjusted, additional labor is rarely necessary.

The most common problem with gated pipe is having excess pressure head. Excess pressure head accelerates pipeline leakage at the joints and furrow erosion immediately downstream of gates. Easy to install devices are available to reduce pressure head. These can be installed inside the pipe as controllable low head gates or outside the pipe as flow-through stands or boxes.

When disposable PE pipe is used, the pipeline is laid out, filled with water, and predetermined sized holes punched for each irrigated furrow. When reinforced PVC lay-flat pipe is used, adjustable gates can be inserted in the holes. Typically two or more hole sizes are required across the field to deliver a design flow rate to each furrow (or border strip). Very low pressure head is used in the pipelines, thus friction loss and elevation differences become critical.

653.0702 Open ditches

Open ditches are typically open channels of geometric cross sections used to carry irrigation water to its point of use. These ditches should be of adequate size and installed on nonerosive grades. Small, inadequate ditches that do not have proper water control structures and maintenance probably are the source of more trouble and consume more time in operating a surface irrigation system than any other cause.

Open channels that carry irrigation water from a source to one or more farms are typically referred to as canals and laterals; and are generally permanent installations. Field or farm ditches convey and distribute water from the source of supply (canals, laterals, wells) to a field(s) within a farm. Most are permanent installations except where they are used within a long field to shorten length of runs, where excessive sediment is in irrigation water, or where crop rotations require differing field layouts. In these cases they are installed at planting time and removed before or following harvest.

Head ditches are used to distribute water across the high end of a field for surface irrigation, typically perpendicular to the direction of irrigation. They provide water for all surface irrigation systems including basin, border, furrow, corrugations, contour ditch, and contour levee. The water surface in head ditches should be high enough above the field surface to allow design discharge from outlet devices under all conditions. Outlets installed too high can cause soil erosion, which in turn requires correction.

Outlet devices may be siphon tubes, notches or cut-outs, gated ports or pipes (spiles), or gated structures. Notches or cutouts require less head to operate than siphon tubes; however, variation in flow caused by water surface elevation change can be greater. Siphon tubes require at least 4 to 6 inches head difference between the water level in the ditch and field, with 8 to 10 inches recommended. If possible, head ditches should be nearly level so that water can be checked for maximum distances, thus requiring fewer check dams and less labor. Good workable grades are 0.05 to 0.2 foot per 100 feet.

Field ditches work best and require less maintenance when constructed in medium to fine textured soils. Seepage is typically low, and banks are more stable and are easier to build and maintain. Vegetation and burrowing animals can cause problems with any soil. Open ditches take up valuable space and can hinder farm operations. Maintenance requirements are much higher than those for pipelines.

Open ditches, laterals, and canals can provide good habitat for a variety of wildlife. Keeping ditches clear of vegetation requires less overall maintenance, but limits wildlife cover and food. Herbicides are sometimes not friendly to wildlife and their food supply. Well vegetated ditchbanks can help prevent soil erosion and at the same time be good habitat for several varieties of upland game birds.

(a) Unlined ditches

Seepage is generally not a problem in medium to fine textured soils; however, erosion and downstream sediment deposition can occur if soils are erosive. In coarse textured soils, seepage can be a big problem. Delivery and field ditches are generally installed and cleaned with a V-ditcher mounted on or pulled by a farm tractor. Larger ditches can be constructed and maintained using backhoe type equipment or small front-end loaders.

Water measuring and control using unlined ditches is less convenient and sometimes difficult. Portable plastic or canvas dams are generally used to raise the water elevation for diversion onto a field. Typically portable plastic or canvas dams have a useful life of 1 year.

(b) Lined ditches

Seepage, erosion and bank stabilization problems in medium to coarse textured soils can be controlled with ditch linings. The lining material used depends on climate (temperature extremes, freezing and frost heave potential), soil conditions, on-farm livestock, local area wildlife, such as deer, installation cost, and maintenance. Improved water control on the downstream end of head ditches can be reason enough to install ditch lining material.

Ditch lining materials include compacted soil, high expanding colloidal clay (bentonite), hand formed nonreinforced or reinforced concrete, slip formed nonreinforced concrete, pneumatic applied concrete mortar (gunnite), cold spray-applied membrane, and flexible membranes of plastic, elastomeric, or butyl rubber. Flexible membranes should be protected from physical damage and ultraviolet light by covering with aggregate or soil. Flexible membranes with concrete or aggregate protection can be installed underwater if the water velocity is less than 5 feet per second.

The suitability, limitations, and general installation requirements of lined ditches are described in more detail in NEH, Part 623 (Section 15), Chapter 3, Planning Irrigation Systems. Design criteria, installation requirements, and material specifications for the most common linings are detailed in the National Handbook of Conservation Practices and other references.

(c) Seepage losses

Methods used to determine conveyance efficiency and estimate seepage losses from open ditches include:

- Measuring inflow and outflow in specific reaches using existing or portable measuring devices, such as weirs, flumes, or current meters.
- Using controlled ponding and measuring the rate of water level drop.
- Using seepage meters, such as a portable constant-head permeameter.
- Estimating losses based on characteristics of the base material.

Controlled ponding is one of the most accurate methods, but must be done during a non-operation period. It requires installation of small dams to isolate the study area. Ponding must begin above the normal water surface elevation and continue below the normal elevation of operation. At the normal water surface, the volume of water lost (usually cubic feet) can be converted to a rate per hour (or minute) per square foot of wetted ditch perimeter.

Accuracy of the inflow-outflow method depends on accuracy of flow measuring devices and is generally limited to longer reaches. However, seepage can be measured during operation periods.

Estimating seepage losses in the delivery system is described in more detail in NEH, Part 623 (Section 15), Chapter 2, Irrigation Water Requirements. A range of expected seepage losses, depending on the base material in the ditch, lateral or canal, is provided. The range is dependent on the amount of fines in the soil.

652.0703 Water control structures

Water control structures are an integral part of the farm distribution system. These structures are typically constructed to help assure proper delivery and distribution of water supply, to prevent erosion, and to keep water losses to a minimum. Adequate water control structures also reduce labor. They include water measuring devices, an essential part of efficient water application and use. The type of structures and materials adaptable are dependent on climate, site conditions, water delivery system, irrigation system used, and cost of installation and maintenance. Water control structures are described in more detail in NEH, Part 623 (Section 15), Chapter 3, Planning Farm Irrigation Systems; National Engineering Field Handbook, Chapter 15; and National Handbook of Conservation Practices, FOTG (Section 4).

(a) Related structures for open ditches

Where open ditches are used to deliver water to sprinkler, surface, or subirrigation systems, structures are typically needed to screen and remove trash and debris, settle and remove sediment, measure flow, divide water, control grade for erosion protection at gated flow turnouts and ports, for spill and overflow, ditch checks, and pipeline inlets and outlets. Some type of structure may be needed to carry water across depressions or drains and under roadways or other obstructions. Flumes, inverted siphons (sag pipes), and culverts are the most commonly used structures for these purposes.

(1) Flumes

Flumes are channels constructed from metal, wood, concrete, or plastic. They are used to:

- Control water through a short channel reach; i.e., water measuring flume ditch check.
- Transport water across landscape depressions.
- Transport water across high seepage or unstable areas.

Flumes can be supported directly on earth or by a concrete, metal, or wood substructure. Flume capacity is usually determined by the flow capacity of the ditch. The foundation and substructure are designed to support full flume conditions even though normal flow rates are less. Flume channels can be any shape, but are typically rectangular, half round, or full diameter pipe. Hydraulically, all operate as open channels. Properly designed welded steel and corrugated metal pipe can be used to span short distances instead of providing a continuous substructure.

(2) Siphons

Siphons are used to carry water over low rises on the landscape or other obstructions. For flow to occur the net hydraulic gradient must be positive, including entrance head, pipeline friction, and outlet head losses. Maximum allowable rise is determined by location of the site above mean sea level. In all practicality, elevation differences should be no more than 5 to 10 feet, with both ends of the siphon either covered by water or controlled with a valve.

A vacuum pump can be used to prime the siphon and exhaust accumulated air during operation, thus maintaining siphon capacity. Air must be exhausted, but not allowed to enter the conduit. Siphon design water velocities should be 2 to 3 feet per second.

Slow velocities can be a problem in siphons. Negative pressures cause dissolved air to release and collect at the high point of the siphon. The increased size of the air bubble causes reduction in flow by reducing the effective cross section area of the pipe. Ultimately, the siphon may cease operation. High velocities help carry dissolved air on through the siphon or at least give less residence time in the negative pressure zone. Multiple individually controlled pipelines that are small in diameter may be desirable rather than one larger pipeline. Operating as few pipelines in the group as possible is suggested where flows are low. This helps maintain higher pipeline velocities.

Available alternatives to using a siphon should be seriously considered because construction requirements are high and continuous high maintenance is required. If energy is available, high volume propeller or axial flow pumps are generally preferred.

(3) Inverted siphons

Inverted siphons (sometimes called sag pipes) are closed conduits used to carry water across depressions in the landscape. They can be installed on multiple foundations above the ground surface or can be buried. Inverted siphons can also be used to cross under roadways, pipelines, and other obstructions. For flow to occur the net hydraulic gradient must be positive, including entrance head, pipeline friction, and outlet head losses. To prevent freezing damage in cold climates, drainage of the conduit during winter months should be considered. Inverted siphons differ from flumes in that some part of the siphon operates under a pressure head.

(4) Culverts

Culverts are conduits installed at or slightly below ditch grade and are commonly used to carry water under farm roads or field access points. They are typically corrugated metal pipe (CMP), welded steel pipe, concrete pipe, or plastic pipe. Either full or partial pipe flow conditions occur, depending on design and installation. To increase flow area at shallow depths, a larger circular pipe installed below grade may be more desirable than a pipe of elliptical (pipe arch) cross section or multiple pipes on grade. Where pipeline velocities are greater than 2 feet per second, the full pipe diameter can be considered as the effective hydraulic cross section. Where pipeline velocities are less than 2 feet per second, or to be more conservative, assume the below grade portion of the pipe is silted full.

(5) Grade control structures

Where the ditch grade is such that the design flow would result in an erosive velocity, some protective structure, such as a chute spillway, drop spillway, or pipe drop (or canal lining), is necessary. These structures control velocity in the ditch by dropping the water abruptly from a higher elevation to a lower elevation in a short protected distance. They can also serve as a ditch crossing (if designed as such) or water measuring device. With grades exceeding 2 to 3 percent, such alternatives as a pipeline or lined ditch should be considered. In all cases unstable flows (including hydraulic jumps) must occur within the structure.

(6) Distribution structures and devices

Distribution control structures are necessary for easy and accurate division of irrigation water to fields on a farm or to various parts of a field. These structures may consist of:

- Division boxes to direct flow of water to two or more pipelines or ditches.
- Check structures that raise the elevation of the water surface upstream so that water can be diverted from the ditch onto a field.
- Turnout structures to divert part or all the irrigation stream to a selected part of the irrigated area.

Each water division structure should provide flow measurement on every outlet. Calibrated flow cross sections or standard water measuring weirs and flumes can be used. Little cost increase is incurred where the measuring device is designed and installed as a part of the initial structure.

Various devices are used for controlling and discharging water into each furrow, basin, or border. For basin and border systems, outlet control devices are generally either flashboard structures, gated structures, short gated pipe, or large diameter siphon tubes. Where large flows are used, erosion protection at the structure outlet is generally needed. Where water velocities within the structure are appropriate to prevent sedimentation, outlets can be installed below field grade. Excess energy is absorbed as water raises with the structure (apron or pipeline).

For furrow systems, near equal flow should be delivered to each furrow. The most commonly used outlets are siphon tubes or gated spiles or pipe. To change flow, only the slides on gates need to be adjusted or the water level can be raised or lowered at the upstream or downstream end of the siphon tube. Flow rate in siphon tubes results from head (elevation) difference in upstream and downstream water levels. Where the outlet end of a siphon tube is above the water surface in the furrow, the pipe centerline elevation of the tube outlet becomes the downstream water level. Two smaller diameter siphon tubes are frequently used for each furrow. This allows one to be removed to cutback or reduce flow in a furrow where the advance rate is excessive (such as wheel compacted or hard furrows).

Cutback flows can also be achieved by raising the outlet end of the siphon tube (generally by inundating a larger part of the siphon tube), thereby reducing the available head on the tube. However, the irrigation head or ditch flow must be reduced, the additional water must be bypassed, or additional siphon tubes must be set. When additional tubes are set, a new irrigation set start time and end time are established. They then need to be cut back, and the extra water reset, and so forth.

(b) Related structures for gravity pipelines

Where gravity flow pipelines are used to distribute water to surface or subsurface irrigation systems or to help pressurize sprinkler irrigation systems, structures are typically needed for:

- Trash and debris removal, and perhaps water screening (or filtering)
- Pipeline inlet and outlet
- Flow measurement
- Miscellaneous valves, such as flow control, air release, vacuum relief, pressure regulation, and surge control
- Head control for gated pipe, cablegation, and surge systems
- Drains

(c) Related structures for pumped pipelines

Where pumped pipelines are used to distribute water to surface, sprinkler, micro, and subirrigation systems, structures are typically needed for pumping plant inlets (including trash and debris removal), water screening (filtering), flow measurement, drains, surge blocks, and valves, such as pressure regulation, air release, vacuum relief, and flow control.

Standard drawings for water control structures should be used whenever and wherever possible.

Materials used in water control structures include cast in place concrete, concrete or cinder block masonry, grouted rock riprap, steel (painted, galvanized, glass coated), aluminum, treated or nontreated wood, and plastic. Nonstructural concrete or cinder block masonry structures can be installed without mortar if every hole is filled with mortar and a #3 (3/8 inch) reinforcing bar is used to help maintain vertical alignment. Horizontal reinforcement (i.e., K web) with mortar, is provided every 16 to 24 inches of height. An extended reinforced concrete structure floor provides footings (foundation) for stacked blocks. Number three or larger reinforcing bars extend out of the foundation into the first two or three layers of blocks. For aesthetics, exposed areas can be plastered with mortar.

Durability, installation and maintenance costs, aesthetics and environmental compatibility, ease of use, farm labor skills, and availability of materials are all necessary considerations for designing these related structures. Many standard drawings are available for water control structures. See section 652.0710, State supplement, for standard drawings and design procedures.

652.0704 Water measurement

A method of measuring water flow onto a field is an important part of every irrigation system. As the demand for water and energy increases, the need for more efficient use of water increases. Water measurement is essential for equitable distribution of the water supply and for efficient use on the farm. Knowing how *much water* is applied is essential for proper irrigation water management. Flow measurement has other uses; for example, they can indicate when a pump impeller is becoming worn and inefficient or when well discharge becomes reduced. Flow changes can also indicate clogged screens or partly closed or plugged valves. Water rights and use requirements increasingly specify that measuring devices be installed.

The most common methods of water measurement and the equipment or structures are described in greater detail in NEH, Part 623 (section 15), Chapter 9, Measurement of Irrigation Water; the ASAE publication Flow Measuring Flumes for Open Channel Systems written by Bos, Replogle, Clemmens in 1991; and the U.S. Bureau of Reclamation's interagency 1997 publication of the Water Measurement Manual. USDA NRCS and Agricultural Research Service provided input to this publication to make it state-of-art in flow measurement. Publication is late 1997.

Common measuring devices are further described in chapter 9 of this guide. Units of flow rate and flow volume commonly used are cubic feet per second (ft³/sec), gallons per minute (gal/min), gallons per hour (gal/hr), million gallons per day, acre-inches per day, acre-feet per day, miners inches, head of water, acres of water, feet of water, shares, acre feet, acre inches, and inches of water. Head or depth units commonly used are feet, tenths and hundredths of feet; and inches and tenths of inches.

Irrigation consultants must acquaint themselves with terms and flow units used locally and must be able to convert to units commonly used in tables, graphs, charts, and computer programs. Many ARS, commercial, and university computer programs used for design of irrigation system components can use either English or metric units.

(a) Planning and design considerations

To accurately measure water, water measurement devices must be installed according to requirements specific to that device. In addition, they must be operated under the conditions for which they are designed. Maintenance must be performed as with any other part of an irrigation system. Re-calibration of some devices may be necessary to assure long-term continuing accuracy.

Many types of devices can be used for flow measurement. The best suited device depends on accuracy desired, ease of use, durability, availability, maintenance required, hydraulic characteristics, ease of construction, and installation cost. In some areas state and local requirements dictate. The following methods or devices each have their own flow equation or calibration process.

(1) Open ditch flow

Volumetric—Flow measurements are made by measuring time required to fill a known volume.

Submerged orifices—Sharp edged orifices of various shapes and sizes can be used. Head differential of water surface upstream and downstream causes flow through the orifice. Flow is calculated using standard orifice flow equations. The orifice flow "Coefficient" for many types of orifices has been determined experimentally.

Weirs—Sharp crested (Cipolletti, 90° V-notch, rectangular) and broad crested (Replogle). Flow depth (head) is measured upstream of crest. Crest width (opening width) can be either standard to fit previously prepared tables or measured, and flow is calculated using standard equations. Sharp crested weirs must meet criteria for the specific type (typically 1/8 inch). Tables are readily available for standard crest widths. Head loss across sharp crested weirs is high, often several inches or feet. Where installation and operation meet standard, accuracy can be within 5 percent of actual.

The broad crested weir (sometimes called a Replogle flume) is the easiest to install of any weir or flume and can accurately measure water with as little as 1 inch of head loss. There is only one critical surface and it is level in all directions. However, a short section of

lined ditch or flume is required (plus or minus 10 ft). With a stilling well, accuracy can be within 2 percent of actual. Well designed and constructed shaft gauges are typically within 5 percent of actual. Only one flow measurement depth is required.

Flumes (Parshall, WSC, cutthroat, or V-notch)—Head is measured, crest width is standard or measurable, and flow is calculated using standard equations. Tables are readily available for standard widths. Measurement is fairly accurate at near submerged flow condition; however, measurement of flow depth both upstream and downstream of the control section is required. Accuracy can be within 5 percent of actual. Because of the numerous critical surfaces, these flumes can be difficult to construct. Since flow measuring accuracy is no better (and often worse) these flumes are no longer recommended. The Replogle flume should be used.

Current meter—Actual flow velocity at various points and depths (typically .6 or .2 and .8) within the flow cross-section is measured. Flow is calculated based on

$$Q = A V$$

Repeated measurements are typically taken at each measuring location. Technique and practice are important to keep accuracy within 10 percent of actual.

Velocity head rod (jump stick)—Rise in water surface elevation is measured when a standard rod is placed in the water flow path with the narrow side and then the flat side facing upstream. The difference in water surface level represents velocity head. Velocity (V) is calculated from:

$$V = (2 g h)^{\frac{1}{2}}$$

Flow is then calculated using $Q=AV$, wherein A is the flow area represented by each velocity and segments are accumulated to present the total flow.

Float method—Surface flow velocity and flow cross-section are measured, then flow rate is calculated using:

$$Q = C A V$$

where:

C = coefficient of discharge calibrated for site conditions, typically 0.80 to 0.95

Rated sections—A staff gage is provided to indicate flow depths. Velocity at various depths is measured using a current meter. Flow is calculated using $Q = AV$. A depth versus flow rate curve is developed for each specific cross section; thereafter, only flow depth is measured. Accuracy depends on technique and consistency of the technician taking readings.

(2) Pipe flow

Flow meters (propeller, impeller)—Flow meters are volumetrically calibrated at the factory for various pipe diameters. Accuracy can be within 5 percent of actual if meter is well maintained and calibrated periodically. Annual maintenance is required. Debris and moss collect quite easily on the point and shaft of the impeller causing malfunction. Therefore, some degree of screening for debris and moss removal may be necessary.

Differential head meters—These meters include pitot tube, shunt flow meters, and low head venturi meters. Pressure differential across an obstruction is measured, thus providing velocity head. Flow is calculated using $Q = AV$. Coefficients provide for improved accuracy.

Orifice plates—Pressure head upstream and downstream of an orifice of known cross section is measured. Flow is calculated using $Q = AV$. Coefficients provide for improved accuracy.

Ultrasonic meters—These meters measure changes in sound transmission across the diameter of the pipe caused by the flowing liquid. They are generally high cost and are most often used only in permanent installations. Some types work well only with turbid water (doppler). Others (transit time) work best in clean water. Portable sonic meters are available, but require a high degree of technology to operate them satisfactorily on different pipe diameters and materials. Frequent calibration can be required.

652.0705 Irrigation runoff, tailwater recovery and reuse

Tailwater recovery and reuse (pumpback) facilities collect irrigation runoff and return it to the same, adjacent, or lower fields for irrigation use. Such facilities can be classified according to the method of handling runoff or tailwater. If the water is returned to a field lying at a higher elevation, it is referred to as a return-flow or pumpback facility. If the water is applied to adjacent or lower-lying field, it is termed sequence use. In all cases runoff is temporarily stored until sufficient volume has accumulated to optimize application efficiency on each succeeding irrigation set.

Components consist of tailwater ditches to collect the runoff, drainageways, waterways, or pipelines to convey water to a central collection area, a sump or reservoir for water storage, a pump and power unit, and a pipeline or ditch to convey water for redistribution. Under certain conditions where gravity flow can be used, neither a pump nor pipeline is necessary.

(a) Planning and design considerations

(1) Storage

A tailwater collection, storage, and return flow facility must provide for temporary storage of a given amount of water. It includes the required pumping equipment and pipeline or ditch to deliver water at the appropriate rate to the application system. A sequence system should have storage, a pump, and only enough pipe to convey water to the head ditch of the next adjacent or downslope field. It may be possible to plan the facility so there is enough elevation difference between fields to apply runoff water to a lower field by gravity without pumping. Only the lowest field(s) require pumpback or have tailwater runoff.

Recovery facilities may also be classified according to whether or not they accumulate and store runoff water. Facilities storing precipitation and irrigation runoff water are referred to as reservoir systems. Reservoirs can be located either at the lower end of

the field or at the upper end. Facilities that return the runoff water for direct irrigation require the least storage capacity. They have automatically cycled pumping and are termed cycling-sump facilities.

One or more types of recovery systems may be applicable to a given farm. A sump is used where land value is high, water cannot be retained in a reservoir, or water ponding is undesirable. Dugouts or reservoirs are more common and most easily adapted to storage and planned recovery of irrigation tailwater. Hydraulically, only tailwater runoff from one irrigation set needs to be stored. Storing water from a maximum of two irrigation sets improves management flexibility. Figure 7-2 displays a typical plan for tailwater recovery facility involving a pumpback system.

Cycling-sump facilities require more intensive water management. When cycling begins, the furrow advance phase should begin, otherwise additional furrows must be started. One option is to reduce the incoming water supply by the amount equivalent to the return rate being added.

Reservoir facilities tend to increase irrigation efficiency while decreasing management intensity requirement. Reservoir tailwater reuse facilities collect

Figure 7-2 Typical tailwater collection and reuse facility for quick-cycling pump and reservoir

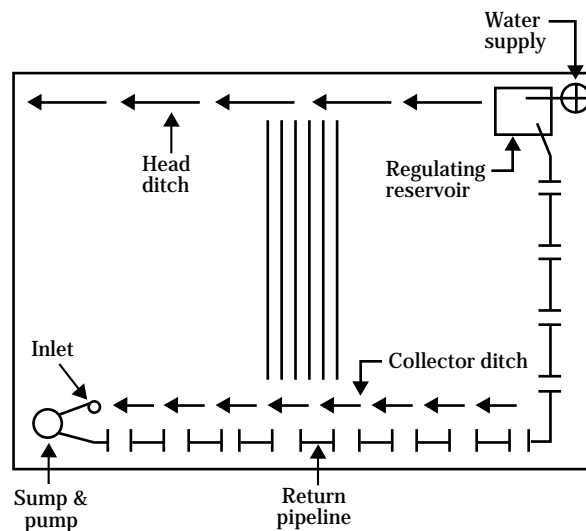

enough water to use as an independent supply or as a supplement to the original supply. Thus they have the most flexibility. The reservoir size depends on whether collected water is handled as an independent supply and, if not, on the rate water is pumped for reuse.

Tailwater reuse reservoirs should be at least 8 feet deep, preferably 10 feet deep, to discourage growth of aquatic weeds. For weed control, side slopes of 2 or 2.5 feet horizontal to 1 foot vertical are recommended. Some soils require flatter slopes to maintain stability. A centrally located ramp with a slope of five to one (5:1) or flatter should be provided for wildlife, either as access or for exiting after accidentally falling in. The reservoir should remain nearly full when not in use to help assure a positive hydraulic gradient for reservoir sealing. At least 2 feet of water depth should remain in the reservoir to provide pump intake submergence, protect the reservoir bottom seal, and provide water for wildlife. Tailwater inflow must enter the reservoir at or near the pump intake. Most suspended sediments return to the upper end of the field instead of settling in the reservoir.

(2) Pumps

Cycling-sump facilities consist of a sump and pump large enough to handle the expected rate of runoff. The sump is generally a vertical concrete or steel conduit with a concrete bottom. The conduit is about 6 to 10 feet deep when placed on end. Pump operation is controlled automatically by a float-operated or electrode-actuated switch. Some storage can be provided in the collecting ditch or pipeline upstream of the sump.

The size, capacity, location, and selection of equipment for these facilities are functions of the selected irrigation system, topography, layout of the field and the water users irrigation management and desires.

Many different low head pumps are used with tailwater reuse facilities. Pumps include single stage turbine, horizontal centrifugal (permanent or tractor driven), submerged vertical centrifugal, and propeller or axial flow pumps. Pumping heads are generally low, consequently energy requirements are low (5 to 10 hp), even for reasonably high flow rates. Tractor driven pumps are typically overpowered.

Caution should be used when selecting pump and power unit size. For example, in a cycling-sump facility the lowest continuous pumping rate that will maintain the design flow rate should be used. For reservoir type facilities where water is delivered from a tailwater sump directly to the head ditch, it is better to pump at a high rate for the first part of an irrigation set (to decrease irrigation advance time). Pumping efficiencies can be in the range of 20 to 75 percent, depending upon the type and size of pump selected, the power unit used, and pump inlet and outlet conditions. Some degree of screening at the pump inlet is generally required. In all cases, irrigation water management should optimize use of water, labor, and energy.

(3) Sizing for runoff

Runoff (RO) flows must be measured or estimated to properly size tailwater reuse sumps, reservoirs, and pumping facilities. Table 7-1 displays expected recovery in gallons per minute based on irrigation head or inflow and expected runoff. Expected recovery and return to the head of the irrigation system is based on 65 percent of the runoff. Seepage, evaporation, overflow, and miscellaneous losses occur in a recovery, storage, and pumpback system. An irrigation system evaluation should be used to determine runoff. An example of a tailwater recovery and pumpback facility follows:

Furrow flow analysis gives runoff	RO = 35%
Irrigation head (inflow)	$Q_i = 1,000$ gpm
Expected recovery at peak runoff	$Q_r = 228$ gpm

Use this recovery flow to size transport and storage facilities. In addition, capacity should be provided to handle concurrent peak runoff events from both precipitation and tailwater, unexpected interruption of power, and other uncertainties. Where a reservoir, recovery pit, or dugout is used, it should have the capacity to store the runoff from one complete irrigation set. Pump capacity will be dependent on the method or schedule of reuse planned. Table 7-2 provides data for sizing tailwater reservoirs and sumps based on desired pump peak flow and desired set time. Overall irrigation efficiencies obtainable by using tailwater recovery facilities are listed in table 7-3.

Where irrigation tailwater cannot enter at or near the pump, a small collection basin installed at the inlet to the storage reservoir is more desirable than allowing sediment to collect in the reservoir. The basin can be

cleaned easily with available farm machinery, while a large pit requires cleaning with contractor-sized equipment. Either way, sediment storage must be provided. Generally when an irrigation water user sees how much sediment accumulates, erosion reduction measures are taken. They readily relate to costs involved in removal.

Examples of determining recovery volume and storage capacity for tailwater recovery and reuse systems using tables 7-1 and 7-2 follow:

Given: Inflow = 1,000 gpm @ 12 hour set time
Outflow = 40 %

Solution: From table 7-1:
Recovery = 260 gpm.
This would be the expected flow for a continuously operating pumpback facility.

Given: Inflow = 1,000 gpm @ 12 hour set time
Desired pumpback flow 500 gpm @ 12 hour set

Solution: From table 7-2:
Volume of storage = 2,000 ft³.
This would be the expected storage needed for an intermittent pumpback facility.

Table 7-1 Expected recovery from runoff ^{1/}

Inflow Q _i (gpm)	----- Estimated runoff, Q _r (gpm) -----						
	20%	25%	30%	35%	40%	45%	50%
150	20	24	29	34	39	44	49
200	26	33	39	46	52	59	65
300	39	49	59	68	78	88	98
400	52	65	78	91	104	117	130
500	65	81	98	114	130	146	163
600	78	98	117	137	156	175	195
700	91	114	137	159	182	205	228
800	104	130	156	182	208	234	260
900	117	146	176	205	234	263	293
1,000	130	163	195	228	260	293	325
1,200	156	195	234	273	312	351	390
1,400	182	228	273	319	364	410	455
1,600	208	260	312	364	416	468	520
1,800	234	293	351	410	468	527	585
2,000	260	325	390	455	520	585	650
2,200	286	358	429	501	572	644	715
2,400	312	390	468	546	624	702	780
2,600	338	423	508	592	676	671	845
2,800	364	455	546	637	728	819	910
3,000	390	488	585	683	780	878	975

1/ **Note:** Estimated runoff is that amount of water that normally runs off the end of the furrows or borders. This flow rate can be arrived at by field measurement or from judgment based on soil or field intake characteristics, inflow rates, field slope, length of run, method of irrigation, and irrigator's ability. Irrigation inflow is the amount of irrigation water (or head) used for the irrigation set.

Table 7-2 Tailwater pit sizing for intermittent pumpback facility ^{1/}

Pumpback flow (gpm)	Length of set -----			
	6-hour	8-hour	12-hour	24 hour
	----- ft ³ -----			
100	200	267	400	800
200	400	533	800	1,600
300	600	800	1,200	2,400
400	800	1,067	1,600	3,200
500	1,000	1,333	2,000	4,000
600	1,200	1,600	2,400	4,800
700	1,400	1,867	2,800	5,600
800	1,600	2,133	3,200	6,400
900	1,800	2,400	3,600	7,200
1,000	2,000	2,667	4,000	8,000
1,100	2,200	2,933	4,400	8,800

1/

This includes a 10 percent safety factor.

Table 7-3 Overall efficiencies obtainable by using tailwater recovery and reuse facility

Original applic effic %	% of water reused	----- First reuse -----			----- Second reuse -----			----- Third reuse -----			----- Fourth reuse -----		
		% of orig water used	Effect use - % of orig	Accum effect %	% of orig water used	Effect use - % of orig	Accum effect %	% of orig water used	Effect use - % of orig	Accum effect %	% of orig water used	Effect use - % of orig	Accum effect %
60	40	16	9.6	69.6	2.6	1.5	71.1	1.1	0.7	71.8	0.2	0.1	71.9
	60	24	14.4	74.4	5.8	3.5	77.9	1.4	0.8	78.7	0.4	0.2	78.9
	80	32	19.2	79.2	10.2	6.1	85.3	3.3	2.0	87.3	1.0	0.6	87.9
50	40	20	10.0	60.0	4.0	2.0	62.0	0.8	0.4	62.4	0.2	0.1	62.5
	60	30	15.0	65.0	9.0	4.5	69.5	2.7	1.4	70.9	0.8	0.4	71.3
	80	40	20.0	70.0	16.0	8.0	78.0	6.4	3.2	81.2	2.6	1.3	82.5
40	40	24	9.6	49.6	5.8	2.3	52.9	1.4	0.6	53.5	0.3	0.1	53.6
	60	36	14.4	54.4	13.0	5.2	59.6	4.7	1.9	61.5	1.7	0.7	62.2
	80	48	19.2	59.2	23.0	9.2	68.4	11.0	4.4	72.8	5.3	2.1	74.9
30	40	28	8.4	38.4	7.8	2.4	40.8	2.2	0.7	41.5	0.6	0.2	41.7
	60	42	12.6	42.6	17.8	5.3	49.9	7.5	2.3	52.2	3.1	0.9	53.1
	80	56	16.8	46.8	31.4	9.4	56.2	17.6	5.3	61.5	9.8	3.0	64.5
20	40	32	6.4	26.4	10.2	2.1	28.5	3.2	0.7	29.2	1.0	0.2	29.4
	60	48	9.6	29.6	23.0	4.6	34.2	11.0	2.2	36.4	5.3	1.1	37.5
	80	64	12.8	32.8	41.0	8.2	41.0	26.2	5.3	46.3	17.5	3.5	49.8

652.0706 Irrigation system automation

Automated irrigation systems reduce labor, energy, and water input while maintaining or increasing irrigation efficiency. Automation is the use of mechanical gates, valves, structures, controllers, and other devices to automatically divert water into an operating irrigation system to satisfy the water requirement of a growing crop.

Research and development by ARS, state experiment Stations, and industry have produced successful structures, controls, computer software, and other devices to automatically control irrigation water. However, automated irrigation (with the exception of micro and solid set sprinkler) use is limited. New technology, including automation, is adopted only when the irrigation water user views the real (or perceived) risk as being equal to or less than the current procedure being used. Commercially produced systems and components are currently available.

The increasing cost of power for pumping and irrigation labor is increasing water users' interest in ways of reducing costs. Automation of surface and sprinkler systems is one consideration. Many irrigators who consider switching from surface irrigation to sprinkler irrigation have continued with surface methods to reduce or eliminate pumping costs. All irrigation systems that apply water by surface, sprinkler, subsurface, and micro irrigation methods can presently be automated to some degree. A high potential exists to increase irrigation efficiencies through improved irrigation water management using existing irrigation systems. Reduced labor and increased production are added benefits.

(a) Planning and design considerations for automation

Automated irrigation systems and their associated components are classified as either automatic or semiautomatic.

(1) Automatic systems

Fully automated irrigation systems normally operate without operator attention except for calibration, periodic inspections, and routine maintenance. The irrigator determines when or how long to irrigate and then turns water into the system and starts programmed controllers to initiate the automated functions.

Fully automated systems typically use either soil moisture sensors or computer processed climatic data to activate electric or pneumatic controlled switches and valves. Soil moisture sensors send a signal to a central controller when soil water has been depleted to predetermined levels. Daily climatic data can also be used to signal a controller to apply irrigations. NRCS SCHEDULER is a field proven irrigation scheduling software usable nationwide. It can be used with fully automatic, semiautomatic, and manually operated surface, sprinkle, micro, and subsurface irrigation systems.

Once irrigation has been started, water is diverted into the farm distribution system and irrigation is completed without operator intervention. Irrigation duration can be controlled by programmed timers, soil moisture sensors, or surface water sensors. Fully automated systems require a water supply available essentially on demand, such as from irrigation district canals, private wells or reservoirs.

(2) Semiautomatic systems

Semiautomatic systems and controls require attention during each irrigation and are usually simpler and less costly than automatic systems. Most semiautomated systems use mechanical or electronic timers to activate control structures at predetermined times. The irrigator generally determines the beginning time and duration, then manually resets or returns the devices to their original position. Some devices can be moved from one location to another before the next irrigation. Parts of a given system may be automatic, while other parts are semiautomatic or manually operated. Often automation of one irrigation set change (during the night or offsite working hours) has nearly the same benefits as a fully automated system and at considerably less cost and risk.

(3) Communications

Most automated and some semiautomated system components can be remotely controlled by centrally located controllers. Such systems require communication between the controller and system components located in the field. Communication may be by direct interconnecting electrical wires, hydraulic or pneumatic conduits, radio or infrared telemetry, or a combination of these. Spurious signals and interference is sometimes a problem when telemetry is used.

(4) Surface irrigation system automation

Technology is available to automate most surface irrigation systems; however, automation use is limited. New technology adoption by a user must have a real or perceived risk equal to or less than the method or system currently in use. If an irrigator cannot sleep until he or she personally checks to see if a valve or gate changed during the night, automation is of no benefit.

Level basin and level furrow surface irrigation systems are perhaps the easiest to automate. Where irrigation inflows are known application volume can be controlled by time. With graded furrow and graded border surface irrigation systems, succeeding irrigation set changes can be initiated by the presence of free water on the soil surface at a predetermined location down the field.

Drop-open or drop-close gates in a short flume or lined ditch can be used to control water surface elevation and location in open ditches. Gravity plus the pressure of water in the ditch operates each gate. Typically, irrigation water discharge from a supply ditch onto a field is controlled by water surface elevation in the ditch and the number of openings onto the field.

Ditches must be installed on a predetermined grade and elevation so that water will be applied uniformly to borders or to the correct number of furrows at a proper design rate. Set time is provided to allow a full or planned irrigation to occur.

Simple electronic or windup timers can control gate operation. A 12 volt battery (or 120 volt AC) with a solenoid can move a slide bolt initiating gate movement. Some batteries are kept charged by solar panels. Both drop-open and drop-close gates are actuated and sealed by the energy from water moving in the supply ditch. With drop-open gates irrigation progresses downstream. Drop-close gates require that irrigation

proceed upstream. A 12 volt battery (or 120 volt AC) can be used (either directly or to power a pump) for electric, hydraulic, and pneumatic opening and closing motors and cylinders. Each irrigation head can be semiautomatic with two gate opening (closing) assemblies. While the second assembly is operating, the first or previous assembly is moved ahead and adjusted for the next irrigation set.

Gates, ports, spiles, notches, or longitudinal overflow weirs can direct water onto a field. Adequate erosion control is always a consideration.

Gated pipe systems, including surge and cablegation, can be automated using electric or wind-up timer controlled valves to initiate the irrigation cycle. There after, the surge or cablegation controller operates the irrigation set. Some field cross slope or fall in the gated pipeline is necessary. ARS Publication 21, Cablegation Systems for Irrigation: Description, Design, Installation and Performance (ARS 1985), should be referenced for cablegation design. NRCS publication Surge Flow Irrigation Field Guide (USDA 1986), should be referenced for surge design.

(5) Sprinkler and micro irrigation systems

Several methods of automating sprinkler and micro irrigation systems are available. Center pivot manufacturers presently have fully automatic devices including monitoring of climate for determining crop ET, soil moisture monitoring, and system on-off controllers, all controlled with an onboard computer. Automatic systems are available with fully automatic controllers including moisture sensors or time clock operation for solid set sprinkler, micro, and greenhouse irrigation systems.

Periodic move irrigation systems, such as side roll and handmove systems, generally are not automated. However, a simple form of automation is timer controlled lateral shutdown and turn-on. With two laterals the dry lateral can be moved at a time more convenient to the irrigator. This allows the irrigator to have some flexibility when water is changed. Although not necessary, this method works best when water is available on demand.

652.0707 Pumping plants

As power and equipment costs increase, designing and maintaining efficient pumping plants becomes more important. Designing an efficient, cost effective pump requires close attention to detail and a knowledge of basic hydraulic principles of pump design. The designer must consider the pump, delivery system, and irrigation system as a whole. An annual economic analysis may be needed to determine the least costly alternative. See chapter 11 of this guide for economic analysis procedures.

Every commercially manufactured pump has a known and published relationship between head (pressure) and volume (capacity) produced. This relationship is generally plotted as a curve called the pump characteristic curve, pump performance curve, or pump head-capacity curve. Multiple curves are used to show characteristics of different impeller diameters and impeller rotation speeds used in the same size and model pump. Pump characteristic curves are available from pump dealers and manufacturers free of charge to designers and pump owners. Every pumping plant evaluation should include a review of the pump characteristic curves for the pumps being used. Pump specific characteristic curves are essential for designing or evaluating pumps operating in series or parallel.

Variables contributing to the head-capacity relationship include:

- Pump make, model number, and discharge size
- Impeller type, diameter, and speed of rotation
- Number of impellers (or pumps) operating in series
- Net input energy required (usually expressed in brake horsepower)
- Net positive suction head (in feet)
- Impeller efficiency

Net Positive Suction Head (NPSH) is the elevation water can be raised at sea level by the suction side of a specific pump impeller. Unless the pump is self priming, the pump impeller must first be filled with water. If the allowable NPSH for a specific pump is exceeded, the pump will lose prime.

Every pump installation has an optimum operating efficiency. The designer should strive to select pump operation at or near that efficiency. It is very unlikely that a used (or even new) pump at a bargain price can be obtained that fully meets the system needs without first checking the specific Head-Capacity Curve for that specific make, model, and size of pump. **Horsepower alone is an inadequate specification for selecting a pump.** Flow capacity (Q) and Total Dynamic Head (TDH) are required for pump selection. At high elevations an adjustment factor for elevation may be needed. Manufacturers use different factors to convert brake horsepower to recommended motor or engine horsepower of the drive unit.

Detailed examples of pump design are in NEH, Part 623 (Section 15), Chapter 8, Irrigation Pumping Plants, and NEH, Part 624 (Section 16), Chapter 7, Drainage Pumping. In addition, pump manufacturers' catalogs and computer programs have information and design assistance on pump design and pump head-capacity characteristics. Chapter 15 of this guide gives information on interpreting pump characteristic curves, and chapter 11 has information about cost analysis for irrigation systems.

652.0708 Drainage systems

Purposes of agricultural drainage of irrigated land are to control and manage soil moisture in the crop root zone, provide for improved soil conditions, and improve plant root development. Soil used for growing turf, landscaping, and agricultural crops must have free drainage. In some cases soils are naturally well drained; however, many soils need installed surface and subsurface drainage systems to provide proper soil moisture management flexibility. The greater the management flexibility, the greater the potential for proper water and nutrient management. Thus, to improve water quality, management flexibility must improve. Where water tables are in or near the plant root zone, water table control is an essential component of irrigation water management.

Capacity of drainage improvements must be based on an analysis of the area irrigated, the anticipated irrigation application efficiency, and the proportion of runoff and deep percolation anticipated as runoff.

Subsurface drainage installation on irrigated land is not a substitute for proper irrigation water management. However, adequate drainage of the crop root zone is essential for long-term production. Only when good irrigation water management is practiced should subsurface drainage installation be considered as an additional water management practice. Also, subsurface drainage is a part of, not a substitute for, proper salinity, sodicity, nutrient, and pesticide management.

Irrigation with saline or sodic water can inhibit crop growth and degrade the soil resource. See chapters 2 and 13 of this guide for information on irrigation water and soil salinity or sodicity. Good water management along with properly designed and managed subsurface drainage systems can help maintain a level of salinity or sodicity in the plant root zone that allows sustained agricultural production.

Provisions to remove excess precipitation and soil seepage water promptly and safely from irrigated land must be maintained as part of farm irrigation water management. Without proper water removal, soil, water, plant and animal resources can be degraded. In some cases discontinuation of improperly managed irrigation may be the only possible alternative.

Properly installed subsurface drainage systems can be used successfully in water short areas as a supplemental source of irrigation water, if it is of reasonably good quality. The water may be used on the field that was drained or on other crops in a different field.

Increasing the plant root zone (available soil-water storage) is a recommended water conservation practice. In high saline or sodic areas, subsurface drainage water may be used on salt-tolerant crops that are specifically grown to dispose of drainage water. Special disposal methods, such as use of the effluent for irrigation of agroforestry plots, for constructed wetlands, or in evaporation ponds, may be necessary for poor quality water that cannot be disposed of in public water bodies. Caution must be exercised, however, to know if toxic elements are in the drainage effluent and, if so, the concentration. Because ponded water attracts waterfowl, any negative impacts on wildlife need to be known and avoided.

In high water table soils, subsurface drainage improves soil condition and the potential plant root zone depth for most crops. This increased soil volume increases plant-water availability when precipitation is less than adequate, and improves plant nutrient availability. Improved soil condition increases soil microorganism activity, thus less fertilizer is generally needed, plus the potential for leaching of nutrients below the plant root zone is decreased.

Laws, regulations, and public perception may increasingly limit new subsurface drainage developments and methods used to dispose of drainage water. Most drainage issues will involve maintaining or rehabilitating existing drainage systems. The irrigation/drainage planning technician must be thoroughly familiar with local laws and regulations governing drainage.

(a) Precipitation runoff

High volume storm water runoff should be safely stored, diverted around, or carried through the irrigation system to protect the land, irrigation system, and crop. This may require special erosion control measures or modifications in the design or layout of an irrigation system.

Standard NRCS procedures, as illustrated in the Engineering Field Handbook, are available to determine the volume and rate of runoff from precipitation. Runoff from precipitation can leave the land through natural watercourses or constructed ditches and channels. Tailwater or wastewater ditches are generally needed at the lower end of irrigation runs to collect runoff from rainfall and irrigation. Storm runoff peaks generally govern capacity requirements. Where storage and tailwater recovery facilities are provided for irrigation, storm runoff containing a large sediment volume should bypass or be trapped before entering the storage reservoir to prevent rapid loss of storage capacity.

(b) Irrigation runoff (tailwater)

Surface irrigation systems cannot place 100 percent of applied water in the plant root zone. However, level basin, border, and furrow surface irrigation systems operated with good water management including planned deficit irrigation in all or part of the field can approach 100 percent water use. Using tailwater reuse on surface irrigation systems along with good water management practices can be efficient. Planned irrigation deficit in all or part of the field, surge, cutback, blocked ends and tailwater reuse are techniques or modifications that, when properly used, can improve irrigation uniformity while reducing field or farm runoff.

To make a near uniform application of water with a graded surface irrigation system without using some of the above techniques or modifications, some irrigation runoff must result, typically 30 to 50 percent. Often runoff water is reduced or eliminated by reducing inflow streams or blocking the ends of furrows and borders. This practice without an appropriate change in water management and system layout often trades runoff water for deep percolation (nonuniformity), which cannot be seen.

Theoretically, sprinkle irrigation systems should not have runoff. In reality, even with proper water and soil management, local translocation, and perhaps some field runoff can occur because of the variable conditions including soils, topography, and crop interference. If field runoff is anticipated, runoff facilities and management must be a part of every irrigation system plan.

Tailwater from irrigation must be recovered and reused, or it must be disposed of without damage to downstream lands and water supplies.

(c) Subsurface drainage

Excess percolation of precipitation and irrigation water and nearly impermeable soil layers can cause high water tables. High water tables can restrict crop root development and promote saline or sodic soil conditions. Seepage from upslope areas, canals, reservoirs, and sumps may also waterlog adjacent downslope lands. Excess water that enters the soil profile often percolates below the crop root zone. Unless the underlying material is sufficiently permeable to allow continued flow, a water table can form and encroach into the potential plant root zone. The water table must be held below the crop root zone to provide aerobic soil conditions for plant root development and function.

Subsurface drains are normally designed to control the water table at least 4 feet below the ground surface. Significant quantities of water can be provided from a water table for plant use. Desirable depth to water table is somewhat dependent on soil type. See information on upflux rate in Chapter 6, Subirrigation. Subsurface drainage systems may consist of interceptor drains, relief drains, or pumped drains. Subsurface drains may also be needed to reduce or eliminate toxic materials from moving to deeper aquifers that contain high quality water.

Design of subsurface drains should be according to procedures for arid land as described in NEH, Part 624 (Section 16), Drainage of Agricultural Lands, chapters 4 and 5. Chapter 7 of this guide provides information on pumped drainage.

(1) Interceptor drains

Interceptor drains are used in sloping areas that have a high water table gradient. They are generally oriented perpendicular to the direction of ground water flow. Subsurface drains are commonly used because the drain must be located according to soil and ground water conditions, which may not correspond to field boundaries, fences, or property lines.

(2) Relief drains

Relief drains are generally used in level to gently sloping areas that have a low water table gradient (slow water movement through the soil). These drains generally are planned as a series of parallel drain conduits in a grid or herringbone pattern in which each lateral is connected to a submain or main that leads to an open channel or sump pump.

(3) Pumped drains

Pumped drains are used when soils are underlain by porous sand or gravel with aquifers that can be lowered by pumping or where insufficient fall exists for a gravity outlet. Detailed subsurface and ground water studies are required to determine the feasibility of lowering the water table by pumping, on a large enough area to be economical.

Pumped drains are also used where a layering of the groundwater table is for a short period of time, i.e., during harvest for improved soil trafficability, in the early part of the growing season for plant establishment, and following periods of excess precipitation.

(d) Environmental factors

Drainage planning requires careful consideration of environmental factors including wetlands, wildlife habitat, and water quality. An environmental assessment of impacts on soil, water, air, plant, and animal resources is important when dealing with drainage. Drainage related environmental issues and laws are complex and subject to varying interpretation, which complicates planning. It frequently takes considerable effort to resolve or to even determine the status of these issues.

(1) Wetlands

A wetland classification determination is necessary where wetland conditions are suspected or evident. Wetlands created by irrigation water seepage or runoff must be considered under current laws. It may be necessary to mitigate irrigation caused wetlands if system improvements in adjacent areas dry up irrigation induced wetlands.

Surface and subsurface drainage can have beneficial wetland effects. Discharges of drainage water can be used to create or enhance wetland areas. Quality of drainage discharges is an important consideration for the creation or enhancement of wetlands used by wildlife.

(2) Water quality

National and State laws require that drains discharging into State watercourses meet certain water quality standards. Currently irrigation runoff is classified as a nonpoint source. As such, discharge permits are not required. However, if a downstream water user files a complaint, water quality restrictions may be placed on discharges from irrigated land. Permits are required for discharges from point sources, such as feedlots, and can be required for subsurface drain outlets.

652.0709 Chemigation

Chemigation is the application of chemicals via an irrigation application system. Included are fertilizers, soil amendments (gypsum or sulfur), herbicides, insecticides, fungicides, nematicides. Specific forms of chemigation are sometimes called fertigation, herbigation, or insectigation; however the most commonly used term that covers everything is chemigation.

Chemigation is accomplished by injecting the chemical into a flowing water supply. Most chemigation is applied by sprinkler systems (linear or center pivots) or micro systems. Soil amendments are typically applied in surface systems. Unless uniformity is high, applying agricultural chemicals through irrigation systems is not recommended. Always follow instructions on the chemical label to determine suitability and methodology of chemigation.

Properly managed chemigation requires injecting chemicals into the water in carefully measured amounts. Care must be taken to prevent backflow of chemically laden water into any water source. Backflow prevention devices are required where chemicals are injected into any pressurized irrigation system. Distribution of water on the field must be uniform, carefully managed, and controlled. This requires the proper equipment and careful attention to detail. Water quality laws are strict concerning handling of chemicals applied through irrigation systems. Only chemicals labeled for chemigation (usually sprinkler system) application should be used.

(a) Advantages

The advantages of using chemigation include:

- Cost of chemigation versus aerial or ground application can be less.
- A chemical can be applied when it is needed without waiting for the proper weather conditions the supplier or labor availability. The procedure can reduce total labor.
- Application can be more uniform than by other methods under certain conditions.

- With soil incorporated herbicides, the appropriate amount of water can be applied to incorporate the herbicide to the depth desired and to activate it immediately.
- Soil compaction is reduced because it is not necessary to pass field equipment over the field to apply chemicals.
- Mechanical damage to crops is less than with mechanical surface application methods.
- The hazards to operators are fewer.
- Less fertilizer may be required, particularly under micro irrigation.
- Losses from wind drift can be reduced or eliminated depending on the method of irrigation. This can reduce one cause of chemical loss and pollution.
- Chemigation techniques are compatible with no-till soil management systems.

(b) Disadvantages

The disadvantages of using chemigation are:

- Some chemicals are corrosive to irrigation equipment, especially immediately downstream of the injection point. In most cases the chemicals are diluted further downstream to the point that corrosion is not a serious problem. Injection equipment must be designed to handle concentrated chemicals.
- Combining chemicals can be dangerous and expensive if not done with full knowledge of the potential, sometimes violent, reactions. Chemicals can also produce precipitates, which can clog equipment, or produce toxic vapors.
- Losses because of volatilization can occur, particularly under sprinkler irrigation.
- Chemicals that can be used successfully under chemigation are limited. Many chemicals are either not registered for chemigation application or are specifically prohibited from being used.
- Excess water application or rainfall during chemigation can cause the loss of chemicals or make them ineffective through deep percolation or runoff. Lost chemicals can contribute to water pollution.
- Special injection equipment and irrigation system safety equipment are required. This adds to the expense of the operation.

- A potential hazard to water supplies is always present particularly with pesticides and herbicides.
- Much is still not known about the best and safest ways to handle chemigation. The technique is relatively new.
- A high degree of management and irrigation uniformity are required.

(c) Planning and design considerations

The following information is intended to give NRCS personnel a general understanding of chemigation on pressure type systems. Detailed design of such systems must be done by a qualified engineering firm or by those involved in the sale and servicing of equipment.

(1) Chemical injection equipment

Chemical compounds to be applied through injection equipment must be in one of the following forms:

- Miscible or emulsible liquid
- Soluble, dry powder (crystal)
- Insoluble, wettable, dispersible powder.

Some equipment is manufactured for specific material (i.e., type of chemical, chemical concentration, viscosity), so the appropriate types of chemicals and equipment should be chosen. The equipment must have adequate capacity. The common methods of injecting chemicals are illustrated in figures 7-3 to 7-8. Pumps can be powered by electric drives, engine drives, or water motors. Equipment can be categorized by the way the inflow rate of the chemical is controlled. The four categories are gravity flow, educator, metering pump, and proportioner system.

(i) Gravity flow from chemical storage tanks (fig. 7-3)—This is the crudest category of chemical injection. Control of injection rate is accomplished by adjusting a valve that approximately regulates chemical flow into the irrigation water. Chemical flow is either into the suction end of a pump or into an open gravity flow system. This type injection is generally used in surface systems, particularly to add soil additives, such as sulfur compounds. It requires careful operator attention.

(ii) Educator—This is the simplest way of introducing chemicals into the system. Methods used for this category are:

- Injection on suction side of pump (fig. 7-4)
- Venturi principle injection (fig. 7-5)
- Pitot tube injection (fig. 7-6)

The chemical injection rate is approximately proportional to water flow. The method requires some operating attention. It can handle liquids and water soluble or dry material. The educator equipment should be used where water flow is nearly constant.

Figure 7-3 Gravity flow from storage tank

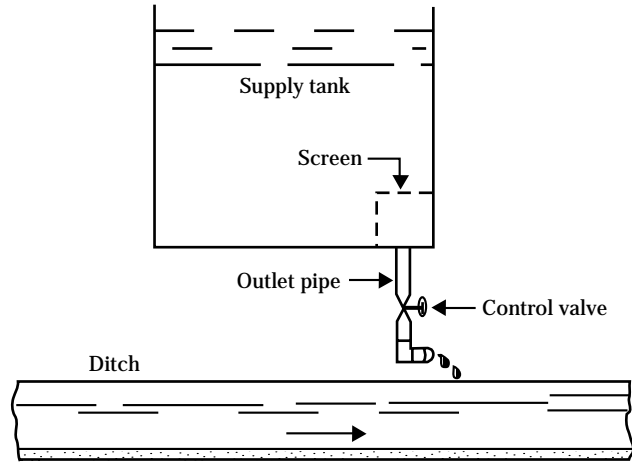

Figure 7-5 Venturi principle of injection

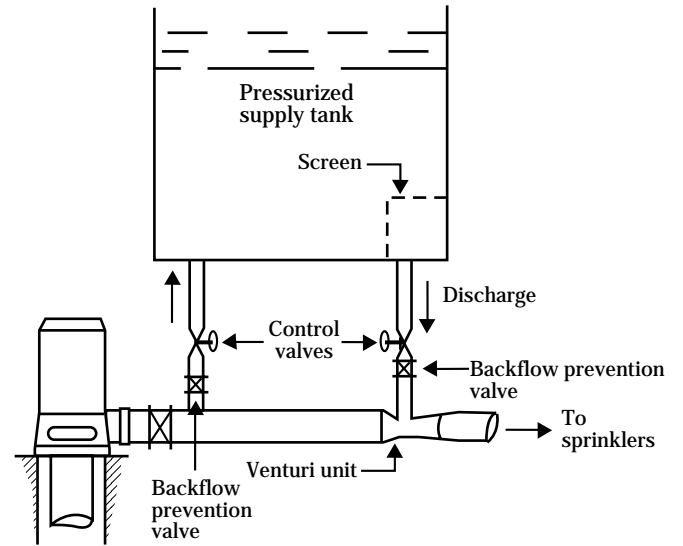

Figure 7-4 Injection on suction side of pump ^{1/}

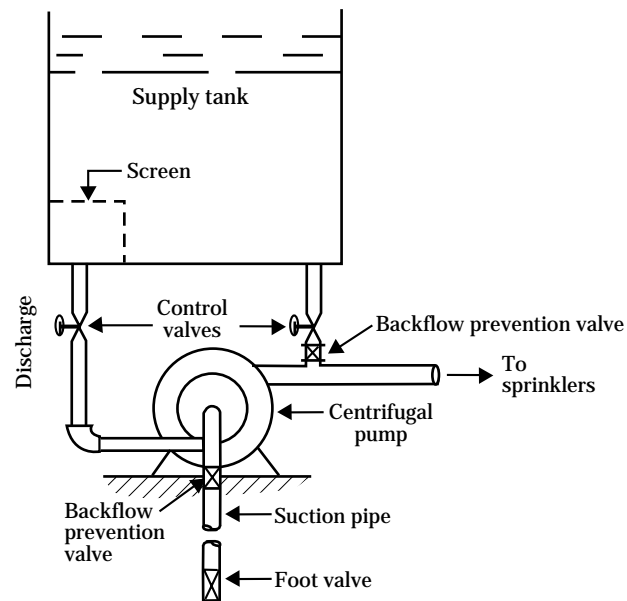
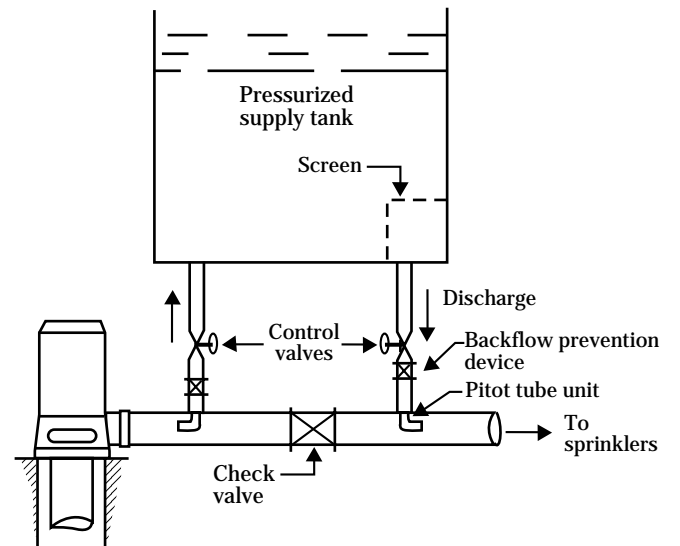

Figure 7-6 Pitot tube injection



^{1/} **Note:** Check local regulations before using this method of chemical injection.

(iii) Metering pump (fig. 7-7)—This method accurately meters the chemical into the irrigation water at a predetermined rate. The chemical inflow rate is constant with respect to time and allows the operator to make changes in the application rate. It should be used where the rate of water flow is nearly constant. The method of injection used is the injection pump. It can only inject liquids.

(iv) Proportioner system—This method of injection accurately proportions chemicals to irrigation water flow. It consists of a sensor that determines the water flow rate, a chemical flow control module, and an injector pump that injects the chemical. This category of injection equipment should be used where the irrigation flow rate varies. It is automatic and requires little operator attention.

(2) Safety equipment

Technology is available to make the safety aspects of chemigation acceptable. However, any time mechanical devices are being used there is always the possibility of failure, malfunction, or accidents. Successful and safe chemigation requires safety devices be installed on the chemigation system. These devices are designed to eliminate three possible pollution problems:

- Backflow of undiluted chemicals to the nurse tanks or water source
- Spill of chemicals on the surface
- Backflow of water mixed with chemicals from the irrigation system.

American Society of Agricultural Engineering Standard ASAE EP409 covers safety standards for chemigation equipment and operation. Bulletins, such as No. 1717, Safety and Calibration Requirements for Chemigation, from Oklahoma State University, Cooperative Extension Service, are readily available through most Cooperative Extension Service offices.

Figure 7-7 Pressure metering pump injection

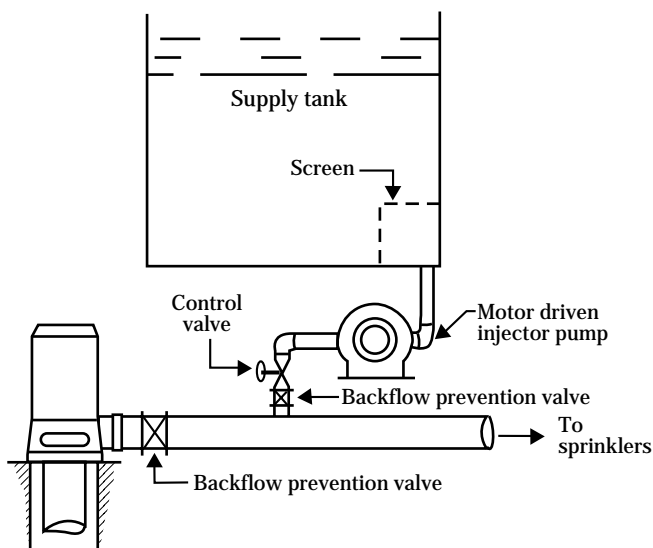

The Environmental Protection Agency provides stringent requirements for safety equipment and procedures when applying certain agricultural chemicals through pressurized irrigation systems. Chemicals approved for chemigation have specific verbatim statements on the label. They include:

- The system must contain a functional check valve, vacuum relief valve, and low pressure drain appropriately located on the irrigation pipeline to prevent water source contamination.
- The pesticide injection pipeline must contain a functional, automatic, quick-closing check valve to prevent flow of fluid back toward the injection pump.
- The pesticide injection pipeline must also contain a functional, normally closed, solenoid-operated valve located on the intake side of the injection pump and connected to the system interlock to prevent fluid from being withdrawn from the supply tank when the irrigation system is either automatically or manually shut down.
- The system must contain functional interlocking controls to automatically shut off the pesticide injection pump when the water pump motor/engine stops.

- The irrigation line or water pump must include a functional pressure switch which will stop the water pump motor when the water pressure decreases to the point where pesticide distribution is adversely affected.
- Systems must use a metering pump, such as a positive displacement injection pump (i.e., a diaphragm pump) effectively designed and constructed of materials that are compatible with pesticides and capable of being fitted with a system interlock.
- Do not apply pesticides when wind speed favors drift beyond the area intended for treatment.

Safety devices are described in the following paragraphs.

Interlock—This connects the irrigation pumping plant and the chemical injection pump. If the irrigation pump stops (line pressure drops), the injection pump stops.

Low pressure drain—An automatic low pressure drain should be placed on the bottom of the irrigation pipeline. If the mainline check valve leaks, the solution will drain away from, rather than flow into the water source.

Backflow prevention valve—Used to keep water or a mixture of water and chemical from draining or siphoning back into the water source (fig. 7-8).

Inspection port—Located between the pump discharge and the mainline check valve, the port allows for a visual inspection to determine if the check valve leaks. The vacuum relief valve connection can serve as an inspection port.

Chemical injection line check valve—This device stops flow of water from the irrigation system into the chemical supply tank and, if the opening pressure is large enough, can prevent gravity flow from the chemical supply tank into the irrigation pipeline following an unexpected shutdown (figs. 7-9 and 7-10).

Chemical suction line strainer—The strainer is necessary to prevent clogging or fouling of the injection pump, check valve, or other equipment.

Solenoid valve—Additional protection can be provided by installation of a normally closed solenoid valve so that it is electrically interlocked with the engine or motor driving the injection pump. The valve provides a positive shutoff on the chemical injection line. If any portion of the downstream irrigation system is lower than the chemical tank, the solenoid valve can prevent the chemical from being siphoned out of the tank.

Chemical resistant hose clamps and fittings—All components that are in contact with the chemical or chemical mixture, from the strainer to the point of injection on the irrigation pipeline, should be made of chemically resistant materials.

Check valve—Used in a pipeline to allow flow in one direction only.

Figure 7-8 Backflow prevention device using check valve with vacuum relief and low pressure drain

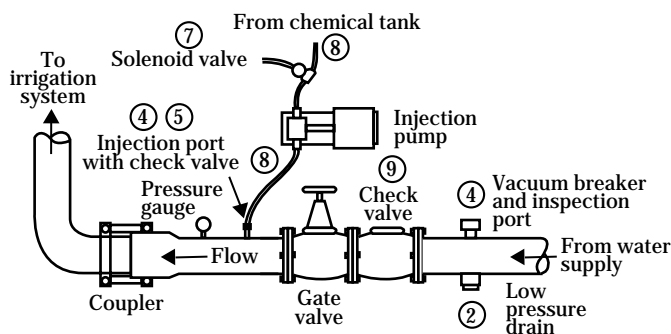

Figure 7-9 Safety devices for injection of chemicals into pressurized irrigation systems using electric power

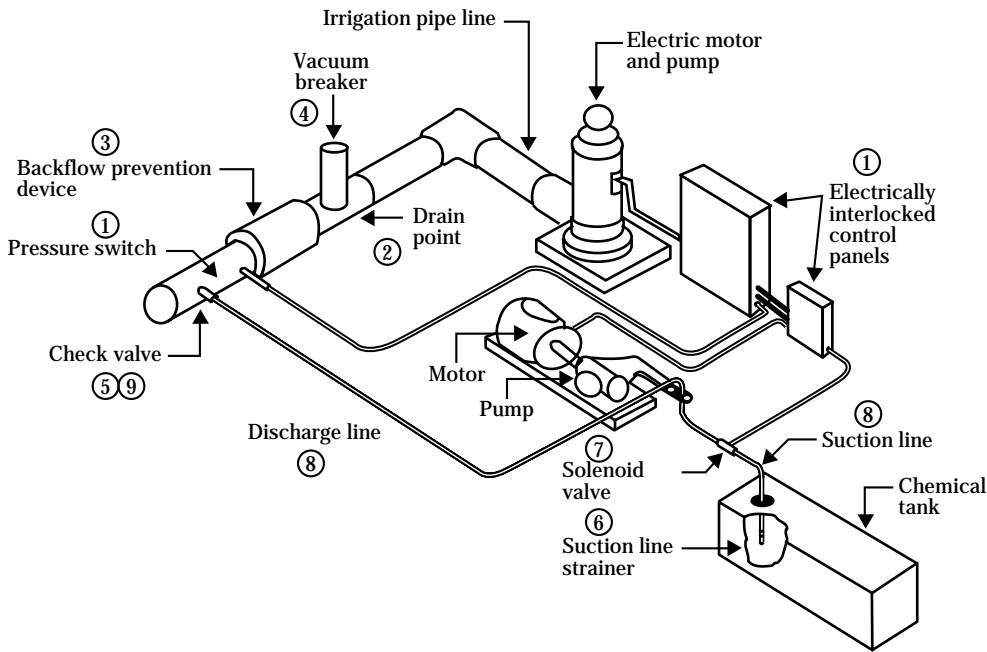
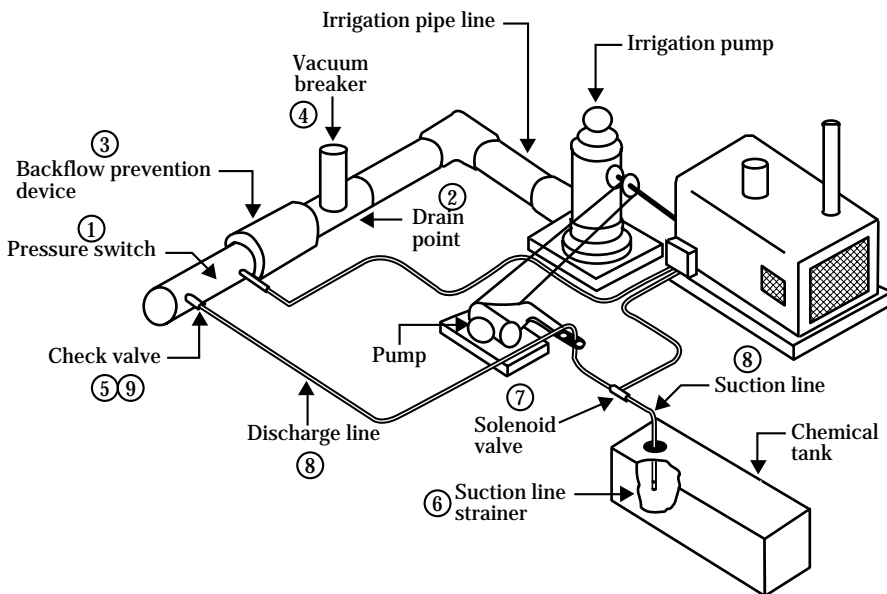

Figure 7-10 Safety devices for injection of chemicals into pressurized irrigation systems using internal combustion engine power



(3) Fertilizer application

The great variety of fertilizer products available allow several choices to be considered in selecting a fertilizer for a particular situation. The three categories of fertilizers used are clear liquid, dry, and suspension liquid.

Clear liquid fertilizers—These materials are flowable products containing nutrients in solution. This makes them convenient to handle with pump injectors, venturi-tubes, and gravity flow from gravity storage tanks. Liquid fertilizers contain a single nutrient or combinations of nitrogen (N), phosphate (P), and potash (K). The most common liquid fertilizers used are listed in table 7-4.

Dry fertilizers—A wide variety of soluble dry fertilizers is used for injection into irrigation systems. The dry fertilizer may be dissolved by mixing with water in a separate open tank and then injected into the irrigation stream, or they can be placed in a pressurized container through which is bypassed a portion of the sprinkler stream. In the later case the bypassed stream continuously dissolves the solid fertilizer until it has been applied. Typical dry fertilizers are shown in table 7-5.

Suspension liquid fertilizers—Suspension liquid fertilizers produce higher analysis grades than clear grades given the same ratio of N, P, and K. Table 7-6 shows a comparison of typical analysis of clear and suspension liquid fertilizers. The suspension mixtures contain 110 to 133 percent more plant nutrients than corresponding clear liquids. Because of their higher nutrient content, suspensions generally are manufactured, handled, and applied at less cost than clear liquids. Another advantage is that they can hold large quantities of micronutrients.

Table 7-4 Liquid fertilizers (solutions) for sprinkler application ^{1/}

Solution product	Total nitro	Avail phos acid	Water soluble potash	Total sulfur	Approximate pounds of product for 1 pound of nutrient			
	% N	% P	% K	% S	N	P	K	S
Ammonium nitrate	20				5			
Ammonium phosphate		8	24		12	4		
Potassium ammonium phosphate	15	15	10		7	7	10	
(N-P-K liquid mixes)	10	10	10		10	10	10	
	15	8	4		7	12.5	25	
Urea (low biuret)	23			4.4				
Urea - ammonium nitrate	32		3.1					
Phosphoric acid		52 - 54			1.8 - 1.9			
Calcium ammonium nitrate	17				6			

^{1/} Source: National Fertilizer Development Center, Tennessee Valley Authority, Muscle Shoals, Alabama, 1965.

Table 7-5 Dry fertilizers for sprinkler application ^{1/}

Dry product	Total nitro	Avail phosph acid	Water soluble potash	Total sulfur	Approximate pounds of product for 1 pound of nutrient			
	% N	% P ₂ O ₄	% K ₂ O	% S	N	P ₂ O ₄	K ₂ O	S
Ammonium nitrate	33.5				3			
Calcium ammonium nitrate	26				4			
(Mono) ammonium phosphate	11	48		2.6	9	2		40
Ammonium phosphate sulfate	13	39		7	8	2.5		14
Ammonium phosphate sulfate	16	20		15.4	6	5		7
Ammonium phosphate nitrate	24	20			4	5		
Ammonium phosphate nitrate	27	14			4	7		
Diammonium phosphate	21	53			5	2		
Ammonium chloride	25				4			
Ammonium sulfate	20-21			24	5			4
Calcium nitrate	15.5				6			
Sodium nitrate	16				6			
Potassium nitrate	13		44		8		2.3	
Urea	45-46				2.2			
Double or treble super phosphate		42-46		10		2.3		10
Potassium chloride			60-62				1.7	
Potassium sulfate			50-53	18			2	5.5
Sulfate potash magnesia			26	15			4	7
Nitrate soda potash	15		14		7		7	

^{1/} Source: National Fertilizer Development Center, Tennessee Valley Authority, Muscle Shoals, Alabama, 1965.

Table 7-6 Comparison of typical analysis of clear suspension-type liquid fertilizers ^{1/}

Ratio N-P-K	Grade clear	Suspension
3:1:0	24-8-0	27-9-0
2:1:0	22-11-0	26-13-0
1:1:0	19-19-0	21-21-0
1:2:2	8-8-8	15-15-15
1:3:1	5-10-10	10-20-20
1:3:2	5-15-10	9-27-18
1:3:3	3-9-9	7-21-21

^{1/} Source: National Fertilizer Development Center, Tennessee Valley Authority, Muscle Shoals, Alabama, 1965.

(i) Herbicide application—A few herbicides are applied by sprinkler systems. Most treatments involve combinations of herbicides in suspension. Only herbicides registered for application with irrigation water can be used. Most application is done with soil applied herbicides before crop germination. Applying irrigation water at low enough rates to use foliage type herbicides is difficult.

(ii) Pesticide application—Application of pesticides by sprinkler systems is limited. Only pesticides for grasshoppers and corn borers are registered for application by irrigation. Water application must be less than 0.5 inch per hour.

(iii) Other planning and management considerations—When irrigators apply chemicals through an irrigation system, consideration needs to be given to travel time to the field area being irrigated. The time it takes for a chemical to travel from the point of injection (usually at the pump) to the area being irrigated must be known to calculate when to close the valve or shut down the pump, thus being assured that all the chemical is applied. Volume of clean water following chemical application can be reduced.

652.0710 State supplement

WA652.0710 State Supplement

(a) General Information

This section contains technical information required for the design of various irrigation components. The components covered herein are primarily engineering practices and are required for the efficient development and operation of irrigation systems. For further information concerning documentation of these practices, refer to the Washington Note Keeping and Documentation Manual.

Standard drawings are available on the Washington NRCS web site at:

http://www.wa.nrcs.usda.gov/technical/ENG/cad_support/standard_dwgs/index.html

This site is updated as new drawings are completed and approved.

Other web sites are available for system design examples and information. The listing below is a sampling of sites.

Determining the Amount of Irrigation Water Applied to a Field can be calculated using tools show in this guide. A web site that has good information on water application is:

<http://ag.arizona.edu/pubs/water/az1157.html>

Software programs on the NRCS office computers include the following programs:

FIRI – Farm Irrigation Rating Index. This is a program to compare system alternatives

for a field or farm. The result is an overall water use rate and system efficiency.

AgPipe – This is a program that can be used to determine pipe, pump, valving, and other appurtenances in an irrigation design.

Copies of the two programs can be loaded at;

<http://www.wcc.nrcs.usda.gov/nrcsirrig/>

(b) Irrigation Water Conveyance, Practice Standard - Codes 430AA through 430HH

This section summarizes design criteria for irrigation pipelines. It also includes various technical aids used in pipeline design. For detailed information refer to the following standards contained in the Washington Field Office Technical Guide (FOTG), Section IV located at the Washington NRCS web page. The list below is a summary of pipe types contained in the FOTG:

- Irrigation Water Conveyance, Aluminum Tubing Pipeline - Code 430AA
- Irrigation Water Conveyance, Asbestos-Cement Pipeline - Code 430BB
- Irrigation Water Conveyance, Non-reinforced Concrete Pipeline - Code 430CC (includes rubber gasket joint, mortar joint, and cast-in-place pipe)
- Irrigation Water Conveyance, High-Pressure, Underground, Plastic Pipeline - Code 430DD (includes PVC, ABS, and PE plastic pipe)
- Irrigation Water Conveyance, Low-Pressure, Underground, Plastic Pipeline - Code 430EE (includes PVC, ABS, and PE plastic pipe)

- Irrigation Water Conveyance, Steel Pipeline - Code 430FF
- Irrigation Water Conveyance, Reinforced Plastic Mortar Pipeline - Code 430GG
- Irrigation Water Conveyance, Rigid Gated Pipeline - Code 430HH (includes Aluminum and PVC gated pipe)

(1) Design Criteria Summary

(i) **Working Pressure**--The maximum allowable working pressure is that pressure at which the pipe is warranted to operate continuously without failure. All pipelines should be designed to operate at a pressure less than or equal to the working pressure. Working pressure varies greatly from one pipe material to another. Always refer to the specific pipeline standard for detailed criteria.

(ii) **External Load Limit**--This is the maximum allowable load due to soil and vehicle weight that may be applied to the pipe. This factor is usually controlled by placing limits on the maximum and minimum amount of fill that may be placed over a pipeline.

(iii) **Capacity**--The pipeline shall be designed to have sufficient flow capacity to deliver the amount of water necessary to meet planned irrigation requirements. Where water is supplied by a well, the pipeline is generally designed to carry the total well output.

(iv) **Velocity**--Some pipe materials have a maximum velocity limitation. This limitation is usually imposed to minimize damage from surge pressures. The following NRCS practice standards contain velocity limitations:

- 430BB, 430DD, 430EE, 430GG - 5 ft/sec maximum
- 430HH - 7 ft/sec maximum

(v) **Friction Losses**--This section indicates the minimum allowable roughness coefficient to be used in calculating pressure or head loss in a pipeline due to friction.

(vi) **Outlets**--These are appurtenances to the pipeline that deliver water to a field or another water conveyance or storage area. Typical examples include line gate valves, risers and alfalfa valves, and hydrants.

(vii) **Check Valves**--These are devices that prevent reverse flow back into a pump and/or well after the pump is shut down. Check valves help prevent pump damage and help minimize the chance of polluted water in the pipeline flowing back into the well. Where chemigation or fertigation is planned the check valve must meet the Washington state requirement of having a 4" access opening between the source and the introduction of chemicals or nutrients.

(viii) **Stands**--A stand is a device used to convey water from the source of supply into the pipeline. In most cases, the stand is installed between the pump discharge and the beginning of the pipeline. Stands are generally constructed of steel and aid in controlling air entrapment, surge pressure, and vacuum or negative pressure.

(ix) **Vents**--A vent is a vertical conduit attached to the pipeline that is open on one end to the atmosphere. The purpose of a vent is to allow for overflow when pressure exceeds maximum allowable working pressure. Vents are rarely used at this time on

pumped systems, having been replaced by pressure relief valves.

(x) Pressure Relief Valves--These valves are set to overflow when a specified pressure is reached. This valve protects the pipeline from rupture due to excessive pressure.

Pipe materials conforming to NRCS Practice Standards 430AA, 430BB, 430DD, 430FF--Pressure relief valves shall be no smaller than 1/4 the nominal pipeline diameter and shall be set to open at a pressure no greater than 5 psi above the pressure rating of the pipe.

Pipe materials conforming to NRCS Practice Standards 430CC and 430EE--Pressure relief valves shall have the capacity to discharge the design flow rate of the pipeline at a pressure no greater than 50% more than the working pressure of the pipe. The valves should be set to open at the pipe working pressure.

Pipe materials conforming to NRCS Practice Standard 430GG shall conform to both of the above-stated criteria.

Pressure relief valves are to be installed on all pump stands and at the end of the pipeline if needed. On a system that does not have a pump stand, a pressure relief valve shall be installed between the check valve and the beginning of the pipeline.

(xi) Air and Vacuum Release Valves--These valves allow air to escape during pipeline filling and allow air to enter the line to prevent vacuum formation during draining operations. Air and vacuum release valves are to be installed at the following points:

- On the pump stand
- At any summit in the pipeline

- At the end of the pipeline
- At any in-line control device, such as a line gate valve or hub end gate
- At any location where there are changes in pipeline grade in a downward direction of flow greater than 10 degrees (18%)

Refer to the specific standard for criteria regarding size requirements for air and vacuum release valves. There are continuous acting air and vacuum relief valves which shall be used wherever there is the possibility of air in the line during operation.

(xii) Drainage--Provisions for draining the pipeline shall be made if recommended by the manufacturer or required to prevent damage from freezing.

(xiii) Flushing--A valve shall be installed at the end of the pipeline to allow for flushing if a sediment accumulation hazard exists.

(xiv) Thrust Control--Thrust blocks, or anchors, are to be installed wherever there is an abrupt change in pipeline grade, alignment, or reduction in pipe size. Thrust blocks absorb the axial thrust at these locations, thereby preventing rupture, or separation, of the pipeline.

(xv) Materials Protection--Certain pipe materials require protective measures to prevent early failure from chemical attack. Aluminum and steel require protection from corrosion. Sulfates and salts may degrade concrete pipe. These substances may occur in the irrigation water, and/or in the soil in contact with the pipeline.

Refer to Figure WA7-5 for an example of a typical pump installation including appurtenances.

(2) Design Tables

There are numerous methods and procedures used to design irrigation pipeline systems. Spread sheets for profiles, pipe type, and pressures are available along with tables in NRCS references (TR77, AgPipe, etc.); National Field Handbook, Chap 2, Hydraulics; along with slide rules, and books. Various materials can be used for the irrigation system. However, materials must be compatible with the site components or protection must be provided. All systems designed must follow NRCS practice standards and procedures.

c) Design Summary for Low Pressure, Underground, Plastic Pipeline - Code 430EE

This summary covers the major criteria for this practice. Refer to the standard and specifications for further details.

(1) Velocity

Flow Rate at Which a Velocity of 5 ft./sec occurs

Nominal Pipe Dia. (Inches)	Flow Rate (GPM)
6	441
8	783
10	1224
12	1763
14	2399
15	2754

(2) Stands

Pump stand, or "dogleg", to be located at the outlet of the pump discharge pipe. For a

closed system, the minimum diameter of stand or "dogleg" is the pipe diameter.

(3) Check Valves

Install check valves between the pump discharge and the stand.

(4) Pressure Relief Valves

Install on the pump stand or level portion of the "dogleg."

Capacity of Various Pressure Relief Valves, in GPM, at 32.5 PSI, Set to Open at 22 PSI*

Valve Size (Inches)	Waterman AA-96CAA-9	Fresno AA-6PR900PR600
3	675	60 630 165
4	1030	120 1045 ---
6	1580	1550 ---

* From manufacturer's test data. Refer to manufacturer's literature for PRV capacity for pipelines with working pressures greater than 22 psi.

(5) Air and Vacuum Release Valves (Air Relief Valves)

Minimum Size of Air & Vacuum Release Valve Installation*

ARV Size (Inches)	Nominal Pipe Dia. (Inches)
1-1/2	4
2 & 2-1/2	6 & 8
3	10
4	12, 14, 15

* Based on manufacturer's data for Waterman AV-150 and size table contained in 430EE standard. Other valves may be used subject to meeting opening-size requirements contained in the 430EE standard.

(5) Air and Vacuum Release Valves (Air Relief Valves) (continued)

Install air and vacuum release valves at the following locations:

1. Pump stand or "dogleg"
2. Any high point (summit) in the pipeline
3. End of pipeline
4. On either side of any in-line control device, such as a hub end gate or line gate valve
5. Wherever there are changes in pipeline grade in a downward direction of flow greater than 10 degrees (18% slope).

(6) Outlets and Appurtenances

Install a sufficient number of risers and alfalfa valves to facilitate operation of gated pipe, irrigation of borders, or to deliver water to other specific points. Install line gate valves or hub end gates as required to manage water delivery in the system.

(d) Chemigation and Fertigation

Washington State has separated chemigation and fertigation as two different practices. Tables WA7-1 and WA7-2 provide a summary of requirements for these practices. Refer to the WAC 16-202-1001 to 1024 or contact the Washington State Department of Agriculture in Olympia for further guidance.

Table WA7-1

Chemigation

Refer to WAC 16-202-1001 to 1024 for complete write-up

	Definition	Pressurized System	Non Pressurized System	Venturi	Alternative System
Backflow Prevention on Water Delivery System	Device that prevents the flow of water from the irrigation distribution system back to the water source	Mainline Check Valve w/ vacuum relief valve, low pressure drain, and 4" inspection port (or other access point)	Hydraulic discontinuity downstream of diversion point. Must be allowed by label for non pressurized systems	Mainline check valve or hydraulic discontinuity	System Design, Barometric Pipe Loop, or WSDA approved design
Application Tank Protection	Product container and appurtenances used for the storage of product that is dedicated for use with an irrigation system	Automatic check valve with at least 10 psi opening (cracking) pressure	Hydraulic discontinuity	Automatic quick closing check valve	Spring loaded check valve, normally closed solenoid w/ interlock, or a normally closed solenoid check valve
Metering Device	Positive displacement injection pump, venturi device or gravity feed device capable of being calibrated and used to gauge chemical placement into the irrigation system	Positive displacement pump interlocked to irrigation pump	Adjustable valve, flow control device, or other metering mechanism	Only on constant flow and pressure systems	A person may not be the metering device, electronic documentation is required
Injection Device	Device used to inject a substance into an irrigation system	Injection line check valve downstream of irrigation line check valve	Air gap or hydraulic discontinuity	Normally closed solenoid operated valve connected to the system interlock	Barometric loop or solenoid and check valve
System Interlock	An arrangement, or interconnection, of the irrigation pump or a pressure or flow sensing device with the chemical injection unit in such a manner that shutdown of the chemigation injection system will occur in the event of any component malfunction or failure	Electric, hydraulic, or mechanical system interlock	Slide metering scale or batch tank with a method to stop flow if supply changes.	Booster, or auxiliary pumps, must be connected with the system interlock or normally closed solenoid valve	A solenoid and check valve
Monitoring Schedule		Minimum of once every four hours, unless the label requires more (continuous when sensitive areas are at risk)	Minimum of once every four hours, unless the label requires more (continuous when sensitive areas are at risk)	Minimum of once every four hours, unless the label requires more (continuous when sensitive areas are at risk)	Minimum of once every four hours, unless the label requires more (continuous when sensitive areas are at risk)

Tank Placement
Tank Identification
Cross-Connected to Water Supply Intended for Human Use

Down gradient and > than 20' from wellheads and sensitive areas or use a secondary containment facility
 Identification 2" high, displaying: registered product label(s), max. capacity, contact name w/ phone number, and tank ID no. attached to tank during application.
 Cross connections must contain a backflow prevention device approved by WA State Dept of Health. Physical separation in the form of an approved air gap may be used.

Table WA7-2

Fertigation

Refer to WAC 16-202-2001 to 2021 for complete write-up

	Definition	Pressurized System	Non Pressurized System	Venturi	Alternative System
Backflow Prevention on Water Delivery System	Device that prevents the flow of water from the irrigation distribution system back to the water source	Mainline Check Valve w/ vacuum relief valve, low pressure drain, and 4" inspection port (or other access point)	Hydraulic discontinuity downstream of diversion point	Mainline check valve or hydraulic discontinuity	System Design, Barometric Pipe Loop, or WSDA approved design
Application Tank Protection	Product container and appurtenances used for the storage of product that is dedicated for use with an irrigation system	Automatic check valve with at least 10 psi opening (cracking) pressure	Hydraulic discontinuity	Automatic quick closing check valve	Spring loaded check valve, normally closed solenoid w/ interlock, or a normally closed solenoid check valve
Metering Device	Positive displacement injection pump, venturi device or gravity feed device capable of being calibrated and used to gauge chemical placement into the irrigation system	Positive displacement pump interlocked to irrigation pump	Adjustable valve, flow control device, or other metering mechanism	Only on constant flow and pressure systems	A person may be the metering device, onsite during application
Injection Device	Device used to inject a substance into an irrigation system	Injection line check valve downstream of irrigation line check valve	Air gap or hydraulic discontinuity	Normally closed solenoid operated valve connected to the system interlock	Barometric loop or solenoid and check valve
System Interlock	An arrangement, or interconnection, of the irrigation pump or a pressure or flow sensing device with the chemical injection unit in such a manner that shutdown of the fertigation injection system will occur in the event of any component malfunction or failure	Electric, hydraulic, or mechanical system interlock	Slide metering scale or batch tank	Booster, or auxiliary pumps, must be connected with the system interlock or normally closed solenoid valve	A person may be the system interlock or a solenoid and check valve
Monitoring Schedule		Daily (continuous when sensitive areas are at risk)	Daily (continuous when sensitive areas are at risk)	Daily (continuous when sensitive areas are at risk)	Daily (continuous when sensitive areas are at risk)

Tank Placement Down gradient and > than 20' from wellheads and sensitive areas or use a secondary containment facility

Tank Identification Identification 2" high, stating: contents, max capacity, contact name w/ phone number, and tank ID no. attached to tank during application.

Cross-Connection to Water Supply Intended for Human Use Cross connections must contain a backflow prevention device approved by WA State Dept of Health. Physical separation in the form of an approved air gap may be used.

Chapter 8

Project and Farm Irrigation Water Requirements

Contents:	652.0800	General	8-1
	652.0801	Project objectives	8-2
	652.0802	Requirements	8-3
		(a) System capacity requirements	8-3
		(b) Alternative delivery schedules	8-5
		(c) On-farm irrigation water requirement	8-6
		(d) Project irrigation water requirements	8-7
	652.0803	Project conveyance, distribution, and delivery facilities	8-8
	652.0804	Irrigation delivery system automation	8-9
	652.0805	Water budget	8-10
	652.0806	Water source	8-12
	652.0807	Evaluating alternatives and selection	8-12
	652.0808	Project cost and benefits	8-13
	652.0809	Planning process for irrigation projects	8-13
		(a) Watershed-based planning	8-13
		(b) Project planning relationships	8-14
		(c) Outline for irrigation project planning	8-16
	652.0810	State supplement	8-21

Table	Table 8-1	Example of relative canal capacities with different water schedules, for greater than 5 deliveries per lateral	8-5
	<hr/>		
Figures	Figure 8-1	Processes involved in determining project irrigation water requirements and sizing facilities	8-4
	Figure 8-2	Relationship between relative service area and relative canal capacity for different irrigation schedules for greater than 5 deliveries per lateral	8-5
	Figure 8-3	Example project water budget	8-11
	Figure 8-4	Resource planning process for project plan—steps 1-4	8-14
	Figure 8-5	Resource planning process for project plan—steps 5-8	8-15

652.0800 General

The previous chapters of this Guide focused on individual fields where the water supply and other conditions do not limit operation of on-farm irrigation systems. Where water for multiple farms is supplied by an offsite group, a water distribution system and schedule for the irrigated area must be developed. It is desirable to have an adequate source of water available and supplied to each irrigated parcel in a timely manner for the crops selected. Various methods have been employed to accomplish this distribution. Crop irrigation water requirements and water supply are primary considerations.

Experience in planning, design, operation, and management of existing projects is desirable. When formulating a project, a thorough multidisciplinary evaluation is needed to obtain the most technically appropriate, economical, and environmentally sound solution. The project must be manageable and reasonable to operate and maintain. It must also be socially acceptable and meet today's standards.

This chapter provides concepts that illustrate the use of irrigation water requirement principles when planning and designing irrigation projects. This is not a design guide for irrigation delivery systems. Refer to other appropriate guidelines for more information on project design. The Natural Resources Conservation Service (NRCS) reference *Economic and Environmental Principles and Guidelines for Water Related Land Resource Implementation Studies* provides detailed guidelines for documentation. Section 652.0808 describes in detail a planning outline that will assist planning staffs with irrigation project planning. The intensity of investigations required varies with the level of planning, scope, and significance of the project. Generally, preliminary planning is less intensive than planning for investigation and evaluation of the selected alternative. Many computer programs are available to perform various parts of project evaluation. Their use is encouraged.

An irrigation project is defined as blocks of irrigated land within a defined boundary, developed or administered by a group or agency. Water is delivered from a source to individual turnouts via a system of canals,

laterals, or pipelines. The irrigated block generally involves many farms that can have multiple fields per farm. Irrigation water requirements used for designing, managing, or upgrading irrigation projects are similar to an on-farm analysis. With projects, the analysis is expanded to include all landowners, cropland area, crops, and irrigation systems. General examples are provided to illustrate the procedure. Irrigation projects should distribute the available water supply to irrigators in an equitable and dependable manner. The irrigator should be aware of flow rates and frequencies of available water in their own terms. In some areas, a visual understanding is as important to the water user as is an actual flow in gallons per minute (gpm), cubic feet per second (ft³/s), miners inches, or local measurement terms.

Project irrigation water requirement analysis include:

- Determining irrigable lands and project impacts on natural resources.
- Determining water availability.
- Determining crop irrigation water requirements.
- Determining on-farm irrigation water requirements.

Determining irrigable lands and project impacts on soil, water, air, plants, animals, and local people (SWAPA+H)—A field analysis should be made to determine suitability of irrigable lands. Basic are a quality soil survey and 1- to 5-foot contour topographic maps. To support estimates for soils interpretations, irrigation related field and laboratory tests may be needed. The information can include bulk densities to help determine available water capacity, field tests to determine soil intake characteristics, specific ranges in salinity levels, and types and concentration of toxic elements. Other considerations include internal drainage capability, water table existence and depth, soil erodibility, farmability, and onsite and offsite environmental concerns (wildlife, water quality, air quality).

Determining water availability—This includes the source, quantity, timeliness, location, quality, and water right availability.

Determining crop irrigation water requirements

—Composite or weighted crop ET values are developed for on-farm seasonal and peak use periods. These values are then compiled and weighted to represent the entire project area. Percent of area of each crop is determined. Effective precipitation and ground water contribution during the growing season is accounted for as a reduction of required seasonal crop ET and net irrigation requirement (NIR). An analysis should provide a project wide seasonal and peak *net irrigation water requirement*.

Determining on-farm irrigation water requirements

—Overall farm irrigation efficiencies of all water beneficially used on the farm are combined to determine project gross water delivery requirements. Irrigation efficiencies for single irrigation events as well as full season must be recognized. Project water requirements are typically based on full season irrigation efficiencies. Application of irrigation water includes some unavoidable losses. Because of the many factors associated with irrigation systems, management, and climate, applying irrigation water at 100 percent efficiency is currently unachievable. Beneficial uses of water can include:

- providing for crop ET,
- reasonable losses resulting from application and distribution inefficiency,
- leaching of excess salts, and
- climate control for crops (i.e., frost protection, slowing of bud development, slowing of ripening process, seed germination, crop cooling, plus others).

652.0801 Project objectives

Project wide benefits, impacts, and objectives are considered in the project irrigation water requirement analysis. Sponsors (landowners) must have a net economic benefit from irrigated cropland to continue farming. The group, district, or company that delivers the irrigation water must deliver water at a reasonable unit price to the user, but still cover short- and long-term costs. Economic analysis procedures for project development and operations are not described in detail in this chapter. Typically, it is a very complex process using project specific criteria. See chapter 11 for economic evaluations for on-farm irrigation systems. Issues of economics and flexibility must ultimately be considered in irrigation project development and operation. Ultimate size of project is generally limited by available water supply, soils, topography, purpose of applying water, and economics.

Irrigation projects provide and affect far-reaching social, economic, and environmental impacts to surrounding communities as well as to the region. Some benefits of an irrigation project are:

- Value of cropland is increased.
- Crop diversity is allowed.
- Additional labor is required for on-farm crop production.
- Additional businesses are needed to support irrigation and farming equipment.
- Additional processing and transportation facilities for agricultural products are necessary.
- Many other less tangible values change including aesthetics and community economic stability.

Water development facilities, such as reservoirs, open canals, laterals, and farm ponds, draw many and varied wildlife. Consideration should be given to habitat requirements associated with specific wildlife; i.e., canal and ditchbank vegetation as well as odd shaped areas.

Without consideration and careful planning, irrigation project activities can negatively impact water quantity and quality, wetlands, fisheries, and wildlife. Certain pesticides and other toxic elements found in some irrigation drainage and tailwater (runoff) can negatively impact certain waterfowl and fish. Tailwater collection and reuse facilities should be considered. However, with proper and careful planning, negative impacts can be mitigated with establishment or enhancement of areas specifically for wildlife, augmentation of water supplies, and establishing and maintaining public recreation facilities.

The planning process requires assessment of the impacts, and Resource Management System (RMS) planning requires quality criteria be established and met for all resources. In most cases, if the correct assessments are done and proper alternatives chosen, mitigation is not necessary because adverse impacts are collectively avoided with established quality criteria.

652.0802 Requirements

(a) System capacity requirements

Determining required distribution system capacities is generally the most difficult process in computing irrigation supply needs. Irrigation systems should supply enough water over prolonged periods to satisfy the difference between crop evapotranspiration (ET) demand, rainfall, and ground water contribution. The most conservative method of designing system capacity requirements is to provide enough capacity to meet maximum expected or *peak* crop ET rates. With projects, this is generally done on a monthly basis. For high value crops, meeting weekly *peak* crop ET may be necessary where a very high level of water management can be provided.

A frequency distribution analysis of mean daily crop ET (daily crop ET vs. frequency, by some time period) can display risks involved in providing something less than meeting peak crop ET 100 percent of the time. Using an example crop in California:

Supplying water for a 95 percent probability (19 of 20 years) requires system capacity to meet a mean daily crop ET = .23 inches per day. By reducing system capacity to meet a mean daily crop ET = .20 inches per day, an 85 percent probability (17 of 20 years) can be met. The reduction in system capacity may be economically justified.

In areas where rainfall provides a substantial portion of crop water needs, a frequency analysis of precipitation should be performed. See additional information in National Engineering Handbook (NEH), Part 623, Chapter 2, Irrigation Water Requirements, pp 2-187 to 2-226.

Figure 8-1 displays the general procedure used by the Bureau of Reclamation to size delivery systems for projects. The flexibility factor displayed accounts for the type and management of the delivery system. The factor is the ratio of the actual delivery compared to the minimum continuous delivery requirement. A flexibility factor greater than 1.0 provides excess capacity so that individual irrigators can better manage their water; i.e., irrigation scheduling program and improved uniformity of application because of the

opportunity to use larger heads of water with surface irrigation. Either upstream or downstream water surface control in canals and main laterals can be used to assist delivery system automation. With open conveyance systems, it has been shown that controlling the water surface elevation upstream of the farm delivery measuring device and headgate contributes greatly to accurate water deliveries. Accurate farm deliveries benefit both the irrigator and the delivery organization.

Figure 8-1 Processes involved in determining project irrigation water requirements and sizing facilities

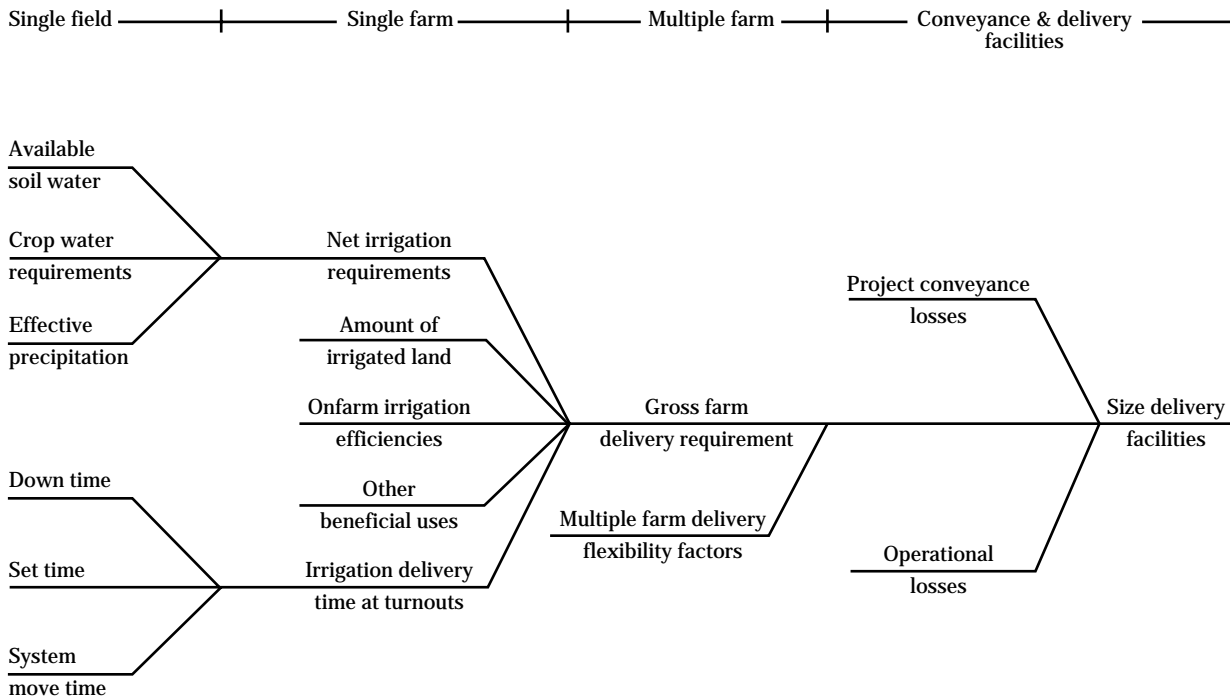

(b) Alternative delivery schedules

Alternative delivery schedules should be evaluated for sizing main canals and pipelines. A slight increase in capacity can provide much improved delivery flexibility and scheduling and be quite reasonable in cost. With new installations, increased pipeline and canal capacities often can be built with minimal increase in cost.

To develop and maintain good irrigation scheduling programs, an arranged or demand type delivery schedule is necessary. Continuous and rotational type delivery schedules limit on-farm irrigation scheduling. Relative canal capacity versus relative service area for different water delivery schedules and irrigation systems is displayed in figure 8-2 (Albert J. Clemmens, ASCE, I and D Division Proceedings, 1987). Note in table 8-1, the increase in canal capacity from a rotational delivery system to an arranged delivery system would be about 16 percent. This can represent only a few inches of water depth in a canal at little increased cost. Often with new installations, increased pipeline and canal capacity can be built with minimal increase in cost. With larger capacity pipelines, there may be no increase in cost because standard pipeline diameters are readily availability and used.

Figure 8-2 Relationship between relative service area and relative canal capacity for different irrigation schedules for greater than 5 deliveries per lateral (demand and arranged schedules at 90% performance level; A_n = normal area of irrigation per delivery, Q_n = normal or guaranteed minimum delivery rate)

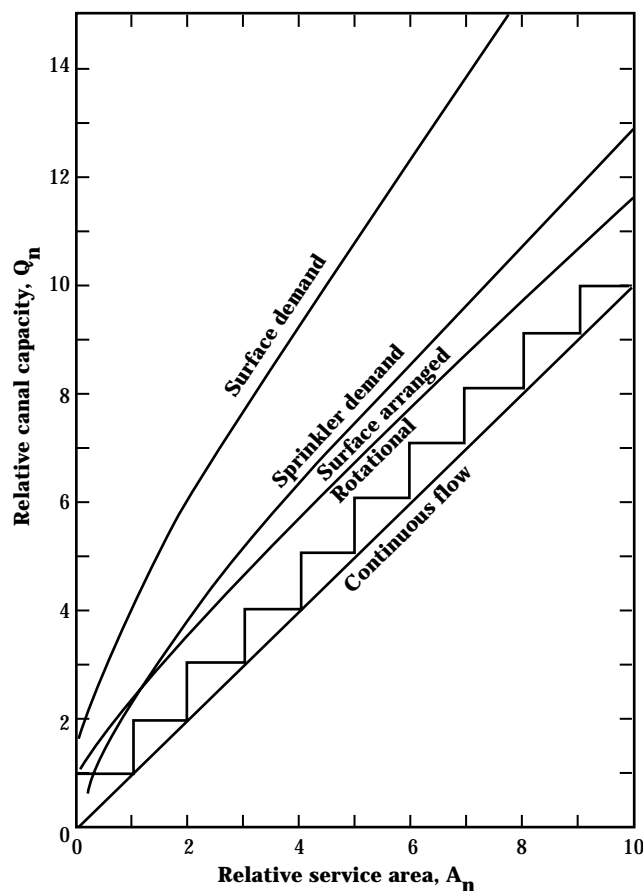

Table 8-1 Example of relative canal capacities with different water schedules, for greater than 5 deliveries per lateral

Delivery schedule	Normal area of irrigation delivery	
	40 acres	80 acres
	gpm	gpm
Continuous flow (at 10 gpm per acre)	400	800
Rotational	500	900
Arranged—surface (basins)	580	950
Demand—sprinkler	700	1,080
Demand—surface	950	1,500

(c) On-farm irrigation water requirement

Chapter 4 and NEH, Part 623, Chapter 2, Irrigation Water Requirements describe methodology for determination of crop ET and crop water requirements. A computer spreadsheet is a good tool to evaluate and summarize all parameters for a desired period. Typical crop rotations are used to develop multicrop water requirements. The evaluation is usually done monthly to provide a basis for monthly storage or diversion and delivery needs. Parameters and steps used for a typical on-farm analysis include:

- Crop evapotranspiration (ET_c)—Determine a weighted crop ET including all crops grown. This should be based on various climatic areas in the project if the differences are sufficient. Often small valleys adjoining larger valleys have different microclimates.
- Effective precipitation (P_e)—Determine weighted effective precipitation for each climatic area.
- Ground water contribution—Determine weighted contribution to plant growth by the water table.
- Net Irrigation Water Requirement (IR)—Determine weighted net irrigation water requirements for all crops grown. Water needed and used for climate and salinity control (auxiliary water) must be included. The formula below is used to calculate the net irrigation water requirement.
- Application efficiencies—Estimate typical overall on-farm efficiencies based on method and system of water application and management. Other factors include typical soil intake characteristics and available water capacity (AWC), typical field size, shape and slopes, net applications, and climatic factors. Water losses to deep percolation and runoff must be estimated. In some project areas, all or part of this water can be available to downslope water users. Seasonal irrigation efficiencies must be established and used rather than single event application efficiencies. It may be advantageous to use realistic estimated monthly irrigation efficiency values rather than one value for the entire season. Typically irrigation efficiencies are lower during spring and fall when less water is required by crops.
- Gross irrigation requirement—Determine weighted gross irrigation water requirements for all crops grown in the project area, by irrigation method and system. Net application per irrigation is a major factor in application efficiencies especially for surface irrigation. The formula to determine gross irrigation requirement is shown below.

Net Irrigation Water Requirement:

$$\text{Net IR} = ET_c - P_e - \text{Ground water contribution} + \text{Auxiliary water needs}$$

Gross Irrigation Requirement:

$$\text{Gross Irrigation Requirement} = \frac{\text{Net irrigation water requirement}}{\text{Seasonal irrigation efficiency}}$$

(d) Project irrigation water requirements

The on-farm water requirement data must now be expanded project wide. If the on-farm typical weighted irrigation water requirement represents the entire project area, then all laterals and canals are sized accordingly, with the irrigated area controlling. Often, specific crops are grown in specific climate, soils, or geographic areas in the project, even to the extent that a single irrigation method and system may be used. For example, micro irrigation systems are well adapted to providing irrigation water to vineyards or orchards on rocky hillsides. Typical gross irrigation water requirements must then be established for those specific areas. Parameters for expanding on-farm data to project wide use include:

- Water requirement—Water delivery requirements need to be established using a planned water delivery schedule and applying management flexibility factors. Flow requirements by lateral or canal are established, based on weighted gross irrigation water requirement on a per acre basis.
- When sizing public water distribution laterals, remember peak water use for a specific crop can affect only one, two, or portions of several laterals. Averaging peak consumption across the entire area may not be realistic.
- Project efficiencies—Project water conveyance and control facility losses must be analyzed when determining delivery capacities. These losses can be as high as 50 percent or more in long, unlined, open channels in alluvial soils.
- In some existing water districts or companies, flow through or "management" water constitutes over 30 percent of the canal capacity. Flow through water is either returned to natural water courses as operational spills or added to downstream water deliveries. With today's technology, simple automatic gate/valve control devices can limit flow through water to less than 5 percent.
- Tailwater redistribution—Collection of field runoff from surface irrigation systems can be redistributed to meet lower elevation project water requirements, if allowed by state law. Quality of runoff is typically less than that diverted at the source. Irrigation tailwater may contain nutrients, pesticides, and, when surface

irrigating, highly erosive soils and sediment. Reuse of runoff water should be strongly considered rather than allowing the flow to enter public water. By reusing runoff water either on the farm where it originated or on farms (fields) at a lower elevation, overall water use efficiency can be improved and diversion flow, pumpage, or storage reduced. (For more information, see chapter 7). Tailwater collection, redistribution, and proper irrigation water management need to be part of a resource plan that meets FOTG quality criteria for all resources.

652.0803 Project conveyance, distribution, and delivery facilities

Typically, delivery canals and laterals are located to provide complete control of water delivery to users. Main canals are generally installed on relatively flat grades for ease of control, to reduce water control structures, and to maximize the area irrigated using gravity flow delivery. However, pumping can be economical for delivery of water to areas at higher elevation.

Sufficient elevation drop along a distribution canal or lateral often allows replacement of the open channel with a pressurized irrigation pipeline. Benefits as well as negative impacts must be assessed as part of the planning process. In some areas, sufficient elevation drop can be available to deliver pressurized water to operate low to moderate pressure sprinkler heads and for low pressure micro systems. Local wildlife can suffer when all existing open canals, laterals, and farm ditches are replaced with buried conduits. Mitigation of lost wet areas because of lining or installing conduits should be considered. An environment assessment (EA) or environmental impact statement (EIS) may be needed to adequately assess potential impacts. National Environmental Protection Act (NEPA) policies and regulations may apply for project analysis where potential effects on the environment can occur and federal funding is involved.

Objectives for conveyance, distribution, and delivery facilities should include:

- Maximizing irrigated acres within physical, environmental and economic limits
- Minimizing land disturbance by minimizing excessive cut and fill areas for conveyance system facilities
- Providing complete control of all water by:
 - Reducing canal seepage. Install channel linings or pipelines to reduce seepage losses in high water loss soils.
 - Reducing operational spills. Use appropriate distribution system water management to minimize management or flow through water. Consider semiautomation or full automation as a management tool.

- Using adequate water measuring devices to measure flows in all diversion, division, and delivery facilities. Equitable delivery of water according to water rights and delivery schedules is essential for user harmony. Maintaining an adequate record of water diverted and delivered is also essential. Irrigation organizations that have installed water measuring devices on lateral and farm turnouts typically experience from 20 to more than 40 percent increase in usable water. It is human nature to provide *a little more water than required* to minimize complaints. Ditch riders (person controlling delivery) tend to open the gate a little more when they are uncertain about flows. Accurate water measurement is essential for high level on-farm water management. See discussion on water measuring devices in chapter 9.
- Installing, operating, and maintaining adequate structures for grade control, water level control, and delivery. (See USBR reference Design of Small Canal Structures). Consideration should also be given to automation of control structures and valves (see USBR reference Canal Systems Automation Manual, 1991). With a fully automated system, almost immediate adjustments can be made to increase or decrease water availability in a canal or conduit system when changes are made in water delivery to the user. This may require increased capacity in main canals or conduits. Semiautomation can be very cost effective.
- Providing a water delivery schedule to the user that promotes good irrigation water management and water conservation. As mentioned before, consideration should be given to an arranged or demand type delivery schedule so the irrigation decision-maker can receive water according to plant needs.
- Small storage and regulating reservoirs can be located within the irrigated area to temporarily store water discharging from canals and laterals when severe changes in delivery rate(s) occur, or when excess water is available. These small reservoirs help prevent operational spills

of excess water that cannot be stored within the main canal system. They balance out, and generally reduce overall diversion requirements. Water levels in these reservoirs tend to fluctuate widely as inflow and outflow change rapidly. An added advantage occurs when the water source is a long distance from the irrigated area. A canal or pipeline can contain (store) several acre feet of water that must be delivered, stored, or spilled when many irrigators discontinue irrigation, for example to harvest alfalfa hay, or during an unexpected short rainy period. Check structures or valves should be used to contain or discharge (into protected watercourses) excess water that cannot be placed in regulating reservoirs.

652.0804 Irrigation delivery system automation

Water conveyance facilities can be automated to deliver irrigation flow rates *on demand* for most users. Typically only a slight to moderate increase in canal or pipeline capacity is required. Facilities that measure and control water surface elevation (or pressure) are generally quite simple. Headgates and valves can be calibrated to control water surface elevations within 0.01 feet.

With automation, irrigation delivery systems can operate at capacity with limited manual adjustments. Water deliveries can be interrupted by the user without jeopardizing the main delivery system. Automation encourages better user understanding of plant water needs. When manual water deliveries are changed in 12- or 24-hour increments, fine tuning water applications to meet actual plant water need becomes more difficult. With automation, water can be changed at any time.

With most delivery systems, at least semiautomation of key headgates or valves is appropriate and cost effective. Labor to change headgates is reduced.

Experience has shown that controlling the hydraulic grade line (water surface elevation in open channels) immediately upstream of farm turnouts provides the most accurate water deliveries with the least labor. Also downstream water surface control on laterals makes it easier to divide water between a few users.

Typically, less water is diverted when agricultural water delivery systems are automated, mainly because of more precise control. Automation of urban water systems often use more water because it is delivered by a time clock.

Downstream water control can provide flexible and demand operation. Any change in flow rate within the system causes upstream gates or pumps to make a corresponding adjustment automatically, until eventually the gates or pumps at the far upstream supply point respond. Therefore, downstream control is limited to canals or laterals, including pump systems, which have a flexible supply of water. Downstream

control canals usually are supplied from a regulating reservoir, but pumps or wells conjunctively used can supply some of the flexibility where multiple pumps are used. An example of the latter may be where the water source is a multipump pumping plant at a river or reservoir.

With downstream control, the water surface or pressure leaving the structure is controlled. A constant water surface elevation or pressure is maintained at some point downstream of the control facility regardless of the number of turnouts opened.

The nature of automated upstream control is to pass all problems downstream while maintaining turnout flow rate control for all upstream users. With upstream control, the water surface (or pressure) entering the facility is controlled by opening or closing a gate to a lower ditch or pipeline. In open channels, broadcrested weirs can be used to provide constant discharge at a given upstream water surface elevation.

Energy for opening and closing small to very large gates can use water pressure (head), gravity, electric, or pneumatic energy.

Floats, pressure tapes, pressure transducers, sonic transmitters, and air bubblers are used to sense the water surface elevation. A stilling well is necessary if the water surface fluctuates more than the open/close gate tolerance. Typically, the water surface sensing unit requires very little energy. A 12 volt DC, deep charge car type battery, or 115 volt AC is generally used.

652.0805 Water budget

A project wide water budget can be an effective tool to analyze total water needs versus total water availability. A water surplus or deficit is readily recognized. A budget can show diversion, pumping, or storage requirements for any selected time period. Typically, a month-by-month analysis is used for the growing season or entire calendar year. Water budgets can be developed for specific items. For example, budget(s) may be developed for: individual system peak crop ET, project wide average crop ET, project wide peak crop ET, water quality management, or water conservation. Often a variety of crops with peak water use requirements occurring at different periods of the growing season are grown to reduce peak water delivery needs. Parameters that might apply to a project wide water budget include:

- Weighted crop ET requirement.
- Effective precipitation that changes soil moisture within the plant root zone.
- Ground water contribution to plant water needs.
- Net irrigation water requirement (to make up soil moisture deficit).
- Irrigation efficiency (accounting for unnecessary irrigations, losses to deep percolation and runoff).
- Auxiliary water requirement (leaching for salinity control; climate control such as frost, cooling, or humidity; seed germination).
- Gross irrigation water requirement.
- Water conveyance system losses (evaporation, phreatophyte plant use, seepage, operational spills).
- Diversion, pumping, and storage requirements.

The following example and data displayed in figure 8-3 are an example water budget for a sprinkle irrigation project. Design single event irrigation application efficiency of a sprinkler system can be 65 to 70 percent or higher. For the total irrigation season project wide, it is assumed in this example that an overall average of 55 percent is more typical. Project wide efficiencies are typically lower because of nonmeasured water delivery, extra irrigations, conveyance facility seepage and leaks, and deliveries and irrigation application not according to plant needs. A weighted crop ET is determined that would represent an average for crops irrigated in a project.

Given: Area = 1,000 acres
 Seasonal on-farm irrigation efficiency = 55%
 Seasonal weighted crop ET = 28.0 acre-inches per acre
 Monthly crop ET effective precipitation (Pe) as shown
 Root zone moisture level assumed at full AWC at start of season

Figure 8-3 Example project water budget

Item	April	May	June	July	Aug	Sept	Oct	Total
For 1.0 acre ----- (acre-inches / acre) -----								
Crop ET	1.4	2.5	5.6	6.8	6.0	4.5	1.2	28.0
Pe	2.5	2.1	0.7	0.2	0.4	1.0	1.5	8.4
Net IR	0.0	0.4	4.9	6.6	5.6	3.5	0.0	21.0
Gross IR	0.0	0.7	8.9	12.0	10.2	6.4	0.0	38.2
Losses:								
From Excess Precip. ^{1/}	1.1						0.3	1.4
From Excess Irrig. ^{2/}		0.3	4.0	5.4	4.6	2.9		17.2
Total ^{3/}								18.6
For 1,000 acres ----- (acre-ft) -----								
Crop ET	117	208	467	567	500	375	100	2,334
Net IR	0	33	408	550	467	292	0	1,750
Gross IR	0	58	742	1,000	850	533	0	3,183
Losses:								
From Excess Precip. ^{1/}	92						25	117
From excess Irrig. ^{2/}		25	333	450	383	242		1,433
Total ^{3/}								1,550

1/ Where effective precipitation (P_e) exceeds crop evapotranspiration (ET_c), the excess effective precipitation infiltrates into the soil and is assumed to go to deep percolation.

2/ Where P_e is less than crop ET, losses or excess is due to irrigation.

3/ Represents total water losses due to both inefficient irrigation and excess effective precipitation. For offsite determination of impacts on water quality, further partitioning may be desirable to determine how much is lost to each individual item (i.e., Deep Percolation, Runoff, and for Spray and Drift). This requires a monthly soil-water and crop-water balance analysis. This is suitable for planning purpose where only historical normal temperature and precipitation data are available. Where local real time climate data are available, the water balance analysis process discussed and calculated in NRCS (SCS) SCHEDULER would be appropriate for daily decisions.

652.0806 Water source

Irrigation water may be from direct gravity diversion or pumping from natural streams, springs, or sloughs; ground water using wells; lakes and reservoirs; or a combination of these. In addition to irrigation project needs when using a reservoir, storage may include municipal, recreation, fire protection, fishery and wildlife, sediment retention, flood protection, downstream natural stream flow augmentation, and power generation.

Determining if water is available and can be used for irrigation purposes is necessary before spending much time on project planning. This may require a preliminary hydrologic analysis and search of issued state water rights. A permit may be required to divert surface water, install wells and pumps, and to store and beneficially use public water. Typically, detailed plans for irrigation storage reservoirs are required and must be approved by a state regulatory agency before construction starts.

652.0807 Evaluating alternatives and selection

Keeping objectives of sponsors and the community in mind and evaluating alternatives (including economical, social, and environmental impacts) are probably the most important part of a project analysis. This step requires a multidiscipline approach that should involve landowners, engineers, agronomists, biologists, economists, water quality specialists, social science specialists, and others. See section 652.0809 and the NRCS National Planning Procedures Handbook for a more detailed discussion of the planning process. Parameters and steps for evaluating alternatives leading up to a selection should include:

- Sponsors identify goals and objectives.
- Identify community concerns and objectives.
- Research applicable local laws and regulations.
- Establish project specific quality criteria.
- Environmental assessment and impacts of each alternative component and cumulative effects of components for each alternative are considered; including soils, water quality and quantity, air quality, plants of concern, and animals (including fishery, wildlife, and endangered species). People including cultural resources and social impacts of alternatives are also a consideration.
- Benefits for each alternative that reaches final consideration. Some alternatives drop out early for obvious reasons; i.e., costs, extreme negative resource and social impacts.
- Fishery and wildlife impacts and mitigation needs.
- Project costs for each alternative that reaches final consideration.
- Interim cost versus benefit analysis, and economic impacts on landowner, community, and region.
- Selection of best alternative, based on objective(s) and goals of sponsors, that meets established quality criteria.
- Operation and maintenance.

652.0808 Project cost and benefits

A detailed project benefit-cost analysis is developed for the selected alternatives. Depending on need, a benefit-cost analysis can be limited to individual landowners and their ability to pay the cost of water and make a net profit with irrigation improvements. Current and reasonable values must be assigned to all components of the project.

Project costs:

- Engineering planning and design, contract administration, construction inspection, permits.
- On-farm land preparation, irrigation system(s), and distribution facilities.
- Cost of water to landowner, which include costs of:
 - Conveyance, distribution and delivery facilities and all associated structures.
 - Water source—diversion facilities, wells and pumps, storage reservoir.
 - Fishery and wildlife mitigation, maintaining or reconstructing wetlands.
 - Management, operation and maintenance of facilities (buildings, staff, equipment)

Note: For a total project benefit-cost analysis, costs must also include all landowner ownership and operation expenses.

Project Benefits:

- Economic, social, and environmental benefits for on-farm, community, and regional levels.
- Power generation revenue (as applicable).
- Other benefits including fishery, wildlife, and recreation use of reservoirs and open canals.

It may be difficult and time consuming to determine all impacts on soil, water, air, plants, animals, and humans (SWAPA+H). For a true benefit-to-cost analysis, dollar values need to be assigned to community benefits including aesthetics, nongame wildlife, environment, social welfare, and economic improvement to community, state, and region. Other Federal, state, and local agencies can be sources of data.

652.0809 Planning process for irrigation projects

The NRCS National Planning Procedures Handbook (September 1993) provides guidance in using the NRCS planning process to develop, implement, and evaluate project plans. The purpose of the planning and implementation process is to:

- Provide methodology that helps planners work effectively with sponsors to identify opportunities and needs and to solve identified resource problems or concerns.
- Help sponsors recognize and understand natural resource conservation principles, concerns, and problems. Resource treatment and effects are considered for each alternative.
- Develop and evaluate alternatives that lead to decisions to implement and maintain conservation treatments and management for the project.
- Enable sponsors to achieve their objectives as well as meet social, legal, and program requirements.
- Help sponsors develop a plan that meets established project specific quality criteria including environmental concerns.
- Assess the effectiveness of installed practices in meeting the goals and objectives of the sponsors while solving problems and impacts on environmental values.

(a) Watershed-based planning

The watershed-based planning approach provides a comprehensive process that considers all natural resources in the watershed (project) as well as social, cultural, and economic factors. The process tailors workable solutions to ecosystem needs through the participation and leadership of sponsors. The watershed approach follows the established planning process and empowers local people to recognize problems and opportunities and find workable solutions for resolving issues and attaining goals related to ecosystems. This approach provides a forum for successful planning and conflict resolution. The result is a watershed plan that is a clear description of resource concerns, goals to be attained, and identified

sources for technical assistance, education assistance, and funding assistance from Federal, State, and local entities for implementing solutions.

(b) Project planning relationships

Project planning relationships are displayed in figures 8-4 (steps 1-4) and 8-5 (steps 5-9).

Figure 8-4 Resource planning process for project plan—steps 1-4

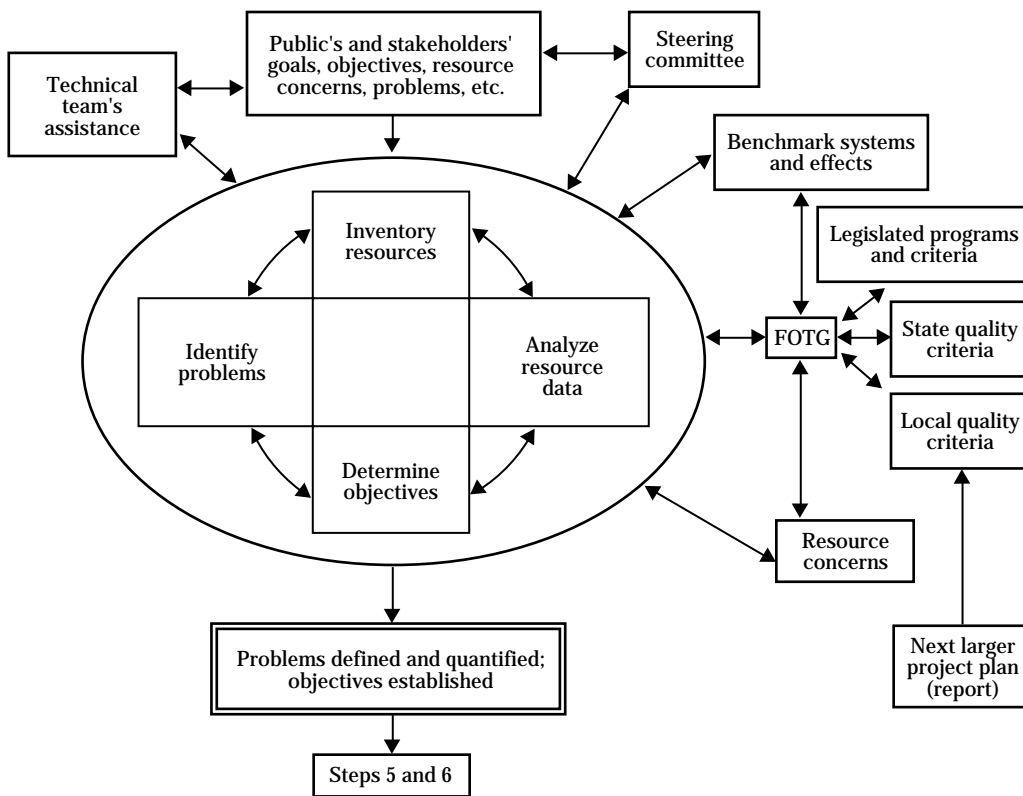
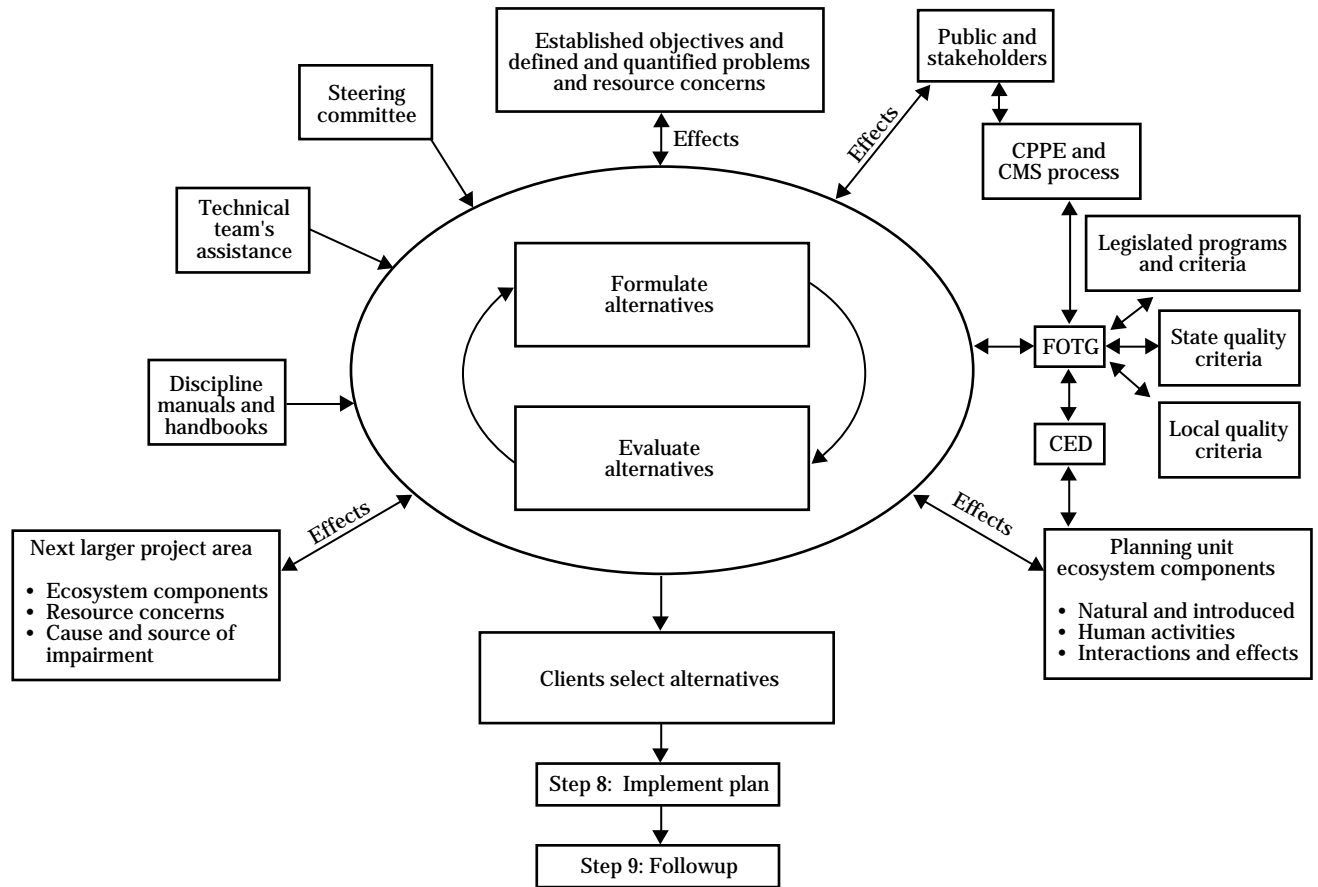

Figure 8-5 Resource planning process for project plan—steps 5-9



(c) Outline for irrigation project planning

The following outline is a guide for inventorying, investigating, and analyzing physical resources for a project. It can assist planning personnel with irrigation aspects of planning a project. Adherence to the principles of the outline will help ensure a uniform approach in estimating physical feasibility, benefits, effects, and impacts at the various stages of progressive planning.

The outline is not intended to indicate a fixed chronological order or procedure. Many of the investigations may be carried on concurrently. Perform only those items described in the outline that are directly applicable to appraise the capability of satisfying a component need. The procedural outline is subject to additions or deletions should a particular project warrant.

Intensity of investigations required for various outline components varies with the level of planning and the scope and significance of the project being planned. Generally, the lowest intensity is associated with pre-application planning level. It increases to full intensity for investigation of the selected plan.

The procedural outline does not describe program requirements or format for plan preparation. It provides an orderly format for planning, implementation and evaluation. As a part of the planning process, it provides an orderly format for organizing information to facilitate comparison of alternatives. It also provides guidance for writing of plans, organizing supporting documentation, and facilitating reviews.

Step 1. Identify problems and concerns (scoping process)

An interdisciplinary team should review sponsors application and gather and review existing information about the project area and ecosystem(s). They should:

- Determine environmental, social, economic, and cultural resources in the area. Other agencies and specific interest groups are good sources for information.
- Make a field review of the project area with specific interest in sponsors concerns, but look at all natural resources.

- Obtain input from the public, other agencies, and special interest groups. This is generally best done at one or more public meetings. All personnel or groups affected by the project should be interviewed for their real (or perceived) concerns and problems. Small groups can be effective in identifying resources of concern.

Step 2. Determine objectives

Help sponsors develop project planning goals and objectives based on needs and values regarding the use, treatment, and management of available resources, both onsite and offsite. Establish project specific quality criteria for resources of concern. Use or enhance FOTG quality criteria.

Step 3. Inventory resources

Review goals and objectives determined in step 2 as related to land uses, production goals, and problem solving. Tailor inventory detail to expected complexity of resource setting. This can be accomplished using the scoping process. Review with sponsors the purpose and importance of the inventory process, what should be done, how much time will be required, and what documentation will be provided.

Develop Plan of Work (POW) outlining; list of tasks, discipline, time frame to do task, and expected product for each task.

Have sponsors assist throughout the inventory process as much as possible.

Suggested inventory procedure outline:

- A. Develop project base map
 1. Identify cultural features, communities, roads, railroads, public and private utilities, climatic stations, sloughs, ponds, streams, lakes, key points where resource data have been collected, wildlife preserves, parks
 2. Topography or elevations typically one to five contour intervals

-
- B. Overlay maps
 - 1. Soils
 - 2. Farm boundaries, irrigation organization boundaries
 - 3. Water rights by year established (if appropriate)
 - 4. Skeletal outline
 - a. Project conveyance facilities including canal and pipeline locations and delivery points
 - b. Drainage facilities—surface and subsurface
 - c. Reservoirs
 - d. Diversion points
 - e. Wells
 - f. Water control structures, measuring devices
 - 5. Irrigation service areas
 - a. Present
 - b. Potential
 - 6. On-farm irrigation methods, systems, or both
 - C. Conservation farm maps
 - 1. Skeletal outline of farm distribution system and field layout. Inventory may be by farm, group of farms, project, or sample area as determined by intensity of study and variation of conditions. Delivery location(s) and amount of water delivered are shown for each farm.
 - D. Soils
 - 1. Description of soil series, surface textures, management groups
 - a. Acreage and location
 - b. Soil moisture storage management groups
 - c. Intake characteristics
 - (1) Furrow, rill, corrugation
 - (2) Border, basins
 - (3) Sprinkler
 - d. Soil chemistry; i.e., salinity, sodicity, pH
 - e. Erodibility designation or group from both water and wind
 - f. Water table depth by month, season
 - E. Crops
 - 1. Crops grown including time of year
 - 2. Acres of each crop
 - 3. Acres by irrigation method and/or system(s)
 - 4. Growing season with planting and harvest dates for multiple cropping
 - F. Water supply
 - 1. Quantity records—historical or probability
 - a. Reservoir storage availability
 - b. Direct stream diversion
 - c. Ground water including depth
 - 2. Quality records
 - a. Chemical and mineral content
 - b. Sediment content and type
 - c. Temperature, if a factor
 - 3. Water rights
 - a. Listing of water rights as to source
 - b. Priorities by date
 - c. Seasonal volume, flow rate, or both
 - d. How administered (state, irrigation organization, group, water user)
 - 4. Competing water uses from the same source
 - G. Climatic records (mean monthly and seasonal, or monthly for historical period)
 - 1. Temperature maximum, minimum, average daily, and growing degree days, if available
 - 2. Precipitation—effective precipitation during growing season
 - 3. Humidity
 - 4. Wind—speed and prevailing direction, by month or season
 - 5. Pan evaporation
 - 6. Solar radiation
 - 7. Percent probable sunshine
 - H. Energy sources
 - 1. Type—electric, natural gas, diesel, gravity, solar
 - 2. Availability—brownouts, lightening
 - 3. Cost, rates and power interruption potential
 - I. Project conveyance facilities
 - 1. Canals, laterals, pipelines, etc., including shape, location and size
 - 2. Capacity - based on size, shape, and conveyance gradient or elevations
 - 3. Length(s)
 - 4. Conveyance losses (preferably measured)
 - a. Seepage
 - b. Evaporation
 - c. Evapotranspiration—stream side vegetation, submersed and floating aquatic weeds
 - d. Operational and management spills and other losses

5. Method of delivery
 - a. Continuous flow
 - b. Rotation
 - c. Demand, including elapsed time between request and delivery. Is quantity variable? Is delivery period (time) variable? Can user request variable time and amount?
 - d. Combination
 6. Water measuring facilities
 - a. Canal and lateral division boxes
 - b. Pipeline division points
 - c. Pumping plant discharge
 - d. Farm deliveries
 7. Geology
- J. Project runoff and wastewater disposal including reuse facilities
1. Type
 2. Capacity
 3. Location of disposal facilities and areas, outlets, pump back or reuse facilities and areas
 4. Real or anticipated effects of runoff and wastewater disposal.
- K. Irrigation methods and systems
1. Irrigation method (surface, sprinkle, micro, subirrigation) and systems (furrow, border, handmove sprinkler, line source micro, etc.)
 2. Acreage by method and system—Inventory by field, farm, group of farms, project area or representative sample areas, as determined by study, diversity of soils, management areas
 3. Quantity of water used or applied
 - a. Per irrigation or application event
 - b. Per irrigation season
 - c. For auxiliary use; i.e., chemigation, frost protection, temperature control, leaching
 4. On-farm irrigation scheduling methods
 5. Project irrigation scheduling methods
- L. Return flow—tailwater, runoff usable in the project.
1. Quantity records, field measurements, sample evaluations, etc.
 2. Quality records
 - a. Chemical concentration
 - b. Mineral content
 - c. Organic content
 - d. Sediment content
 3. Location in the project

Step 4. Analyze resource data

Use scoping process to determine the types of analyses needed. Identified problems and concerns, sponsor's objectives, program criteria, and environmental values to be considered. Input from sponsor, irrigation water user's interdisciplinary team, special interest group(s), public, and other agencies affected by the project is necessary. Type of planning, size, cost, potential for adverse environmental or social impact, and controversy need to be considered. Agreement by the sponsor(s) and Federal, State or local agencies is essential.

Define the existing and future resource conditions in the project area. This can help define the conditions that limit sponsors from fully realizing their objectives. Separately analyze *With* and *Without* Project Conditions. Without Project Conditions can be for existing conditions or future without project conditions. One of these is selected and used as the benchmark to compare alternatives. Typically several alternatives are analyzed, and some are eliminated before the near final selection of best alternative(s).

Analysis of resource data outline:

- A. Project area to be irrigated
 1. Acreage of composite groups of soils that can be managed similarly
 2. Acreage by crop
 3. Acreage by irrigation method and/or system
- B. Crop water requirements
 1. Project wide composite for different crops; i.e., weekly, monthly
- C. Water supply, by days, weeks, or months as needed
 1. Frequency (continuous, intermittent)
 2. Historical period (including time of year)
 3. Risk assessment (probability)
- D. Conveyance efficiencies, by month
 1. By type and condition of conveyance facility
 2. By construction material; i.e., earth, concrete, PVC pipeline, steel pipeline
- E. Overall application efficiencies including management
 1. By irrigation method and/or system
 2. By type and condition of on-farm distribution facilities

- | | |
|---|--|
| <p>F. Crop water budget/balance, by probability, historical period</p> <ol style="list-style-type: none"> 1. Acres provided full water supply 2. Acres provided partial water supply 3. Water deficiencies and excesses <ol style="list-style-type: none"> a. Volume b. Time periods <p>G. Project delivery system capacity requirements</p> <ol style="list-style-type: none"> 1. Unit peak period water requirements 2. Composite peak period water requirements 3. Farm turnout capacity and pressure requirements 4. Project conveyance facility capacity and pressure requirements 5. Water measurement for division of supply for farm delivery <p>H. Irrigation benefits</p> <ol style="list-style-type: none"> 1. Net returns <ol style="list-style-type: none"> a. Crop yield and quality improvements, optimizing net benefits b. Reduced farm, irrigation, or both organization operation costs 2. Environmental improvements <ol style="list-style-type: none"> a. Water quality improvements—reducing agricultural related chemicals, salts, sediments, and organic material in ground and surface water; reducing stream temperatures b. Water quantity improvements—reducing seepage and deep percolation losses thereby reducing pumping, diversion and storage requirements resulting in increased in-stream flows, decreased ground water mining c. Community benefits d. Other resource improvements—air quality, wildlife habitat <p>I. Review and finalize quality criteria for project with water users and nonwater users affected by the project</p> | <p>Step 5. Formulate project (components) alternatives</p> <p>Identify practices (components) and other treatments that address the sponsors goals and objectives.</p> <p>Land treatment (structural and nonstructural) as well as preventative measures should be considered. Management improvements using the existing system is always the first increment to be considered.</p> <p>Develop alternatives (composite of components) as necessary.</p> <p>Make a preliminary evaluation of the effects of each practice on resource concerns, problems, objectives, and environmental values.</p> <p>Develop preliminary designs and cost estimates.</p> <p>Compare alternative to project quality criteria.</p> <p>Estimate environmental, social, economic, and human effects. Acceptability of the alternative by the sponsor, the public, and State and Federal agencies should be established. Needed measures to mitigate any potential environmental damages need to be included.</p> <p>Analyze the risk and uncertainty associated with each alternative.</p> <p>Use sponsor(s) and public affected by the project to help identify and formulate alternatives.</p> <p>Develop benefit-to-cost analysis for selected alternative(s).</p> |
|---|--|

Step 6. Evaluate project (components) alternatives

Quantify effects on soil, water, air, plant, and animal resources plus social and economic considerations, both for the benchmark and each alternative. Quantification of effects should be done as agreed to by the interdisciplinary team. Evaluation detail for each alternative will vary and become more refined as needed in the selection process. The sponsors, public, and other agencies and interest groups affected by the project should be included in the quantification process.

Compare the effects of each alternative to the benchmark. Both beneficial and adverse impacts are considered.

Compare alternative to project quality criteria.

Display evaluations in a manner easily understood by the sponsor, public, special interest groups, individual landowners, and other agencies.

Step 7. Make decisions

- Assist the sponsor(s) in reviewing alternatives and evaluations.
- Provide opportunity for public response.
- Sponsor(s) review the plan, public input, obligations, and responsibilities.
- Compare selected alternative to project specific quality criteria.
- Sponsor provides a decision, with public information (and review) as necessary.

Step 8. Implement project plan

Develop Plan of Work (POW) for implementation of practices and measures. Include list of tasks, disciplines involved, and time required for preparing real property acquisition maps, acquiring necessary right-of-way, prepare design surveys, final design of construction drawings and specifications, cost estimates, bid documents, and installation sequence and schedule. Particular attention should be paid to all special environmental concerns, such as threatened and endangered species, cultural resources, and wetlands. Sponsors obtain necessary agreements, permits, and approvals.

Develop plans for any mitigating loss of environmental values that resulting from project plan implementation. If established project quality criteria was appropriate, mitigation should be minimal.

Develop Operation, Maintenance, and Replacement (O, M, and R) plan and agreement(s). Identify who will do the work and the process followed for periodic inspections and development of plans for remedial action.

Step 9. Evaluate project plan (follow-up)

Establish evaluation criteria including what use will be made of the results.

Develop POW to guide evaluation efforts. Develop by component, project, and individual discipline the products to complete the evaluation. This should include work to be performed by the sponsor, NRCS, contractor, and other agencies. The POW will vary based on the project and the purpose of the evaluation. Identify personnel who will be involved in remedial work and together develop procedures to be used, time required, and cost. Develop a schedule showing who has responsibility for a specific action, when it is to begin, when it is completed, and what is to be the product.

As identified in the Plan of Work, periodically:

- Gather information, make analyses, develop recommendations, and prepare necessary reports.
- Take necessary action as a result of the evaluation.

Examples of evaluations may include:

- Dam performance and safety inspections
- Monitoring water quality
- Performance evaluations of measuring devices, conveyance and delivery facilities, and pumps
- Delivery (conveyance) system operation and management

652.0810 State supplement

Chapter 9

Irrigation Water Management

Contents:	652.0900	General	9-1
	652.0901	Irrigation water management concepts	9-2
		(a) Irrigation water management concepts	9-2
	652.0902	Soil-plant-water balance	9-4
		(a) Soil	9-4
		(b) Measuring soil-water content	9-7
		(c) Crops	9-19
		(d) Upward water movement (upflux)	9-22
	652.0903	Irrigation scheduling	9-22
		(a) General	9-22
		(b) Irrigation scheduling methods	9-23
	652.0904	Irrigation system evaluation procedures	9-30
		(a) General	9-30
		(b) Irrigation efficiency definitions	9-31
		(c) Irrigation system evaluations	9-33
		(d) Simplified irrigation system and water management evaluations	9-34
		(e) Abbreviated water management and irrigation system evaluations	9-35
		(f) Water management and irrigation system evaluations	9-36
		(g) Detailed irrigation system evaluation procedures	9-45
	652.0905	Soil intake determination procedures	9-185
		(a) General	9-185
		(b) Surface irrigation systems intake	9-186
		(c) Sprinkle irrigation systems	9-189
		(d) Infiltration and application rate test procedures	9-190
		(e) Automation of testing for maximum application rate	9-205

652.0906	Water measurement	9-205
	(a) General	9-205
	(b) Using water measurement	9-205
	(c) Basic hydraulic concepts	9-206
	(d) Open channel primary measuring devices	9-206
	(e) Closed-pipeline primary measuring devices	9-206
	(f) Secondary measuring devices	9-207
	(g) Methods of water measurement	9-207
	(h) Measuring method categories	9-208
	(i) Suitable measurement methods for irrigation and drainage	9-210
	(j) Demands made on a measuring device	9-212
	(k) Getting the most from open channel measuring devices	9-214
	(l) Matching requirements and meter capabilities	9-214
	(m) Open channel flow measurements	9-214
	(n) Pipeline flow meters and applications	9-217

Tables	Table 9-1 Available water capacity for various soil textures	9-6
	Table 9-2 Oven dry moisture content based on 3-minute carbide moisture tester readings	9-13
	Table 9-3 Recommended depths for setting tensiometers	9-14
	Table 9-4 Interpretations of readings on typical electrical resistance meter	9-17
	Table 9-5 Types and characteristics of flow meters	9-209
	Table 9-6 Major operational characteristics of flumes and weirs	9-211

Figures	Figure 9-1 Total soil-water content for various soil textures with adjustment for changes in bulk density	9-5
	Figure 9-2 Soil-water content versus depth	9-6
	Figure 9-3 Available soil-water holding worksheet (feel and appearance)	9-9

Figure 9-4	Soil-water content worksheet (gravimetric method)	9-11
Figure 9-5	Determination of soil moisture and bulk density using Eley volumeter and Speedy moisture tester	9-12
Figure 9-6	Tensiometer, installation, gauge, and servicing	9-15
Figure 9-7	Example irrigation scheduling program flowchart using soil water content for validation	9-24
Figure 9-8	Soil-water measurements used to predict day to irrigate	9-25
Figure 9-9	Typical water balance irrigation scheduling worksheet	9-27
Figure 9-10	NRCS (SCS) SCHEDULER—seasonal crop ET	9-29
Figure 9-11	NRCS (SCS) SCHEDULER—seasonal soil moisture status	9-29
Figure 9-12	Plot of example advance and recession curves	9-37
Figure 9-13	Minispray head catch device (made from a 2-liter plastic soft drink bottle)	9-44
Figure 9-14	Border downslope profile and cross-section	9-56
Figure 9-15	Cylinder infiltrometer curves	9-57
Figure 9-16	Cylinder infiltrometer test data	9-58
Figure 9-17	Advance and recession curves	9-59
Figure 9-18	Cylinder infiltrometer curve	9-61
Figure 9-19	Depth infiltrated curve	9-63
Figure 9-20	Soil-water intake curve	9-78
Figure 9-21	Furrow profile	9-95
Figure 9-22	Advance recession curve	9-96
Figure 9-23	Flow volume curves	9-97
Figure 9-24	Soil water intake curve	9-98
Figure 9-25	Ditches, turnouts, measuring devices, and field grid for example site	9-105
Figure 9-26	Cumulative intake curve	9-113

Figure 9-27	Example cylinder infiltrometer test data	9-114
Figure 9-28	Catch can data for lateral move system	9-121
Figure 9-29	Typical split flow layouts for micro irrigation system	9-163
Figure 9-30	Typical wetted area under a plant with two emitters	9-163
Figure 9-31	Water infiltration characteristics for sprinkler, border, and furrow irrigation systems	9-187
Figure 9-32	Cylinder infiltrometer	9-191
Figure 9-33	Soil description	9-194
Figure 9-34	Example cylinder infiltrometer test data using form NRCS-ENG-322	9-195
Figure 9-35	Example cylinder infiltrometer test data accumulated intake for border irrigation design	9-196
Figure 9-36	Standard intake families for border irrigation design	9-197
Figure 9-37	Furrow accumulated intake versus time	9-200
Figure 9-38	Intake families as used with furrow irrigation	9-201
Figure 9-39	Transit-time acoustic flowmeters: diametrical path, diametrical path reflective, and chordal path transducer configuration	9-207
Figure 9-40	Profile of long-throated flume	9-216
Figure 9-41	Profile of sharp-crested weir	9-216

Examples	Example 9-1	Estimating furrow inflow and outflow depths	9-39
	Example 9-2	Evaluation computation steps	9-56
	Example 9-3	Evaluation computation steps for level border and basin irrigation systems	9-77
	Example 9-4	Evaluation computation steps for graded furrow irrigation systems	9-95

	Example 9-5	Evaluation computation steps for contour ditch irrigation systems	9-113
	Example 9-6	Evaluation computation steps for periodic move and fixed set sprinkler irrigation systems	9-129
	Example 9-7	Evaluation computation steps for continuous move center pivot and linear move laterals	9-146
	Example 9-8	Evaluation computation steps for continuous move, large gun type sprinklers	9-160
	Example 9-9	Evaluation computation steps for micro irrigation systems	9-169
	Example 9-10	Evaluation computation steps for irrigation pumping plants	9-181
<hr/>			
Exhibits	Exhibit 9-1	Guide for estimating soil moisture conditions using the feel and appearance method	9-8
	Exhibit 9-2	Completed worksheet—Surface irrigation system, detailed evaluation of graded border system	9-48
	Exhibit 9-3	Completed worksheet—Surface irrigation system, detailed evaluation of level border and basins	9-71
	Exhibit 9-4	Completed worksheet—Surface irrigation system, detailed evaluation of graded furrow system	9-85
	Exhibit 9-5	Completed worksheet—Surface irrigation system, detailed evaluation of contour ditch irrigation system	9-106
	Exhibit 9-6	Completed worksheet—Sprinkler irrigation system, detailed evaluation of periodic move and fixed set sprinkler irrigation systems	9-123
	Exhibit 9-7	Completed worksheet—Sprinkler irrigation system, detailed evaluation of continuous/self move center pivot lateral	9-138

Exhibit 9-8	Completed worksheet—Sprinkler irrigation system, detailed evaluation of continuous move, large sprinkler gun type	9-155
Exhibit 9-9	Completed worksheet—Micro irrigation system detailed evaluation	9-166
Exhibit 9-10	Completed worksheet—Irrigation pumping plant detailed evaluation	9-175

Chapter 9

Irrigation Water Management

Contents:	652.0900	General	9-1
	652.0901	Irrigation water management concepts	9-2
		(a) Irrigation water management concepts	9-2
	652.0902	Soil-plant-water balance	9-4
		(a) Soil	9-4
		(b) Measuring soil-water content	9-7
		(c) Crops	9-19
		(d) Upward water movement (upflux)	9-22
	652.0903	Irrigation scheduling	9-22
		(a) General	9-22
		(b) Irrigation scheduling methods	9-23
	652.0904	Irrigation system evaluation procedures	9-30
		(a) General	9-30
		(b) Irrigation efficiency definitions	9-31
		(c) Irrigation system evaluations	9-33
		(d) Simplified irrigation system and water management evaluations	9-34
		(e) Abbreviated water management and irrigation system evaluations	9-35
		(f) Water management and irrigation system evaluations	9-36
		(g) Detailed irrigation system evaluation procedures	9-45
	652.0905	Soil intake determination procedures	9-185
		(a) General	9-185
		(b) Surface irrigation systems intake	9-186
		(c) Sprinkle irrigation systems	9-189
		(d) Infiltration and application rate test procedures	9-190
		(e) Automation of testing for maximum application rate	9-205

652.0906	Water measurement	9-205
	(a) General	9-205
	(b) Using water measurement	9-205
	(c) Basic hydraulic concepts	9-206
	(d) Open channel primary measuring devices	9-206
	(e) Closed-pipeline primary measuring devices	9-206
	(f) Secondary measuring devices	9-207
	(g) Methods of water measurement	9-207
	(h) Measuring method categories	9-208
	(i) Suitable measurement methods for irrigation and drainage	9-210
	(j) Demands made on a measuring device	9-212
	(k) Getting the most from open channel measuring devices	9-214
	(l) Matching requirements and meter capabilities	9-214
	(m) Open channel flow measurements	9-214
	(n) Pipeline flow meters and applications	9-217

Tables	Table 9-1	Available water capacity for various soil textures	9-6
	Table 9-2	Oven dry moisture content based on 3-minute carbide moisture tester readings	9-13
	Table 9-3	Recommended depths for setting tensiometers	9-14
	Table 9-4	Interpretations of readings on typical electrical resistance meter	9-17
	Table 9-5	Types and characteristics of flow meters	9-209
	Table 9-6	Major operational characteristics of flumes and weirs	9-211

Figures	Figure 9-1	Total soil-water content for various soil textures with adjustment for changes in bulk density	9-5
	Figure 9-2	Soil-water content versus depth	9-6
	Figure 9-3	Available soil-water holding worksheet (feel and appearance)	9-9

Figure 9-4	Soil-water content worksheet (gravimetric method)	9-11
Figure 9-5	Determination of soil moisture and bulk density using Eley volumeter and Speedy moisture tester	9-12
Figure 9-6	Tensiometer, installation, gauge, and servicing	9-15
Figure 9-7	Example irrigation scheduling program flowchart using soil water content for validation	9-24
Figure 9-8	Soil-water measurements used to predict day to irrigate	9-25
Figure 9-9	Typical water balance irrigation scheduling worksheet	9-27
Figure 9-10	NRCS (SCS) SCHEDULER—seasonal crop ET	9-29
Figure 9-11	NRCS (SCS) SCHEDULER—seasonal soil moisture status	9-29
Figure 9-12	Plot of example advance and recession curves	9-37
Figure 9-13	Minispray head catch device (made from a 2-liter plastic soft drink bottle)	9-44
Figure 9-14	Border downslope profile and cross-section	9-56
Figure 9-15	Cylinder infiltrometer curves	9-57
Figure 9-16	Cylinder infiltrometer test data	9-58
Figure 9-17	Advance and recession curves	9-59
Figure 9-18	Cylinder infiltrometer curve	9-61
Figure 9-19	Depth infiltrated curve	9-63
Figure 9-20	Soil-water intake curve	9-78
Figure 9-21	Furrow profile	9-95
Figure 9-22	Advance recession curve	9-96
Figure 9-23	Flow volume curves	9-97
Figure 9-24	Soil water intake curve	9-98
Figure 9-25	Ditches, turnouts, measuring devices, and field grid for example site	9-105
Figure 9-26	Cumulative intake curve	9-113

Figure 9-27	Example cylinder infiltrometer test data	9-114
Figure 9-28	Catch can data for lateral move system	9-121
Figure 9-29	Typical split flow layouts for micro irrigation system	9-163
Figure 9-30	Typical wetted area under a plant with two emitters	9-163
Figure 9-31	Water infiltration characteristics for sprinkler, border, and furrow irrigation systems	9-187
Figure 9-32	Cylinder infiltrometer	9-191
Figure 9-33	Soil description	9-194
Figure 9-34	Example cylinder infiltrometer test data using form NRCS-ENG-322	9-195
Figure 9-35	Example cylinder infiltrometer test data accumulated intake for border irrigation design	9-196
Figure 9-36	Standard intake families for border irrigation design	9-197
Figure 9-37	Furrow accumulated intake versus time	9-200
Figure 9-38	Intake families as used with furrow irrigation	9-201
Figure 9-39	Transit-time acoustic flowmeters: diametrical path, diametrical path reflective, and chordal path transducer configuration	9-207
Figure 9-40	Profile of long-throated flume	9-216
Figure 9-41	Profile of sharp-crested weir	9-216

Examples	Example 9-1	Estimating furrow inflow and outflow depths	9-39
	Example 9-2	Evaluation computation steps	9-56
	Example 9-3	Evaluation computation steps for level border and basin irrigation systems	9-77
	Example 9-4	Evaluation computation steps for graded furrow irrigation systems	9-95

	Example 9-5	Evaluation computation steps for contour ditch irrigation systems	9-113
	Example 9-6	Evaluation computation steps for periodic move and fixed set sprinkler irrigation systems	9-129
	Example 9-7	Evaluation computation steps for continuous move center pivot and linear move laterals	9-146
	Example 9-8	Evaluation computation steps for continuous move, large gun type sprinklers	9-160
	Example 9-9	Evaluation computation steps for micro irrigation systems	9-169
	Example 9-10	Evaluation computation steps for irrigation pumping plants	9-181
<hr/>			
Exhibits	Exhibit 9-1	Guide for estimating soil moisture conditions using the feel and appearance method	9-8
	Exhibit 9-2	Completed worksheet—Surface irrigation system, detailed evaluation of graded border system	9-48
	Exhibit 9-3	Completed worksheet—Surface irrigation system, detailed evaluation of level border and basins	9-71
	Exhibit 9-4	Completed worksheet—Surface irrigation system, detailed evaluation of graded furrow system	9-85
	Exhibit 9-5	Completed worksheet—Surface irrigation system, detailed evaluation of contour ditch irrigation system	9-106
	Exhibit 9-6	Completed worksheet—Sprinkler irrigation system, detailed evaluation of periodic move and fixed set sprinkler irrigation systems	9-123
	Exhibit 9-7	Completed worksheet—Sprinkler irrigation system, detailed evaluation of continuous/self move center pivot lateral	9-138

Exhibit 9-8	Completed worksheet—Sprinkler irrigation system, detailed evaluation of continuous move, large sprinkler gun type	9-155
Exhibit 9-9	Completed worksheet—Micro irrigation system detailed evaluation	9-166
Exhibit 9-10	Completed worksheet—Irrigation pumping plant detailed evaluation	9-175

652.0900 General

Irrigation water management (IWM) is the act of timing and regulating irrigation water application in a way that will satisfy the water requirement of the crop without wasting water, soil, and plant nutrients and degrading the soil resource. This involves applying water:

- According to crop needs
- In amounts that can be held in the soil and be available to crops
- At rates consistent with the intake characteristics of the soil and the erosion hazard of the site
- So that water quality is maintained or improved

A primary objective in the field of irrigation water management is to give irrigation decisionmakers an understanding of conservation irrigation principles by showing them how they can judge the effectiveness of their own irrigation practices, make good water management decisions, recognize the need to make minor adjustments in existing systems, and recognize the need to make major improvements in existing systems or to install new systems. The net results of proper irrigation water management typically:

- Prevent excessive use of water for irrigation purposes.
- Prevent excessive soil erosion
- Reduce labor
- Minimize pumping costs
- Maintain or improve quality of ground water and downstream surface water
- Increase crop biomass yield and product quality

Tools, aids, practices, and programs to assist the irrigation decisionmaker in applying proper irrigation water management include:

- Applying the use of water budgets, water balances, or both, to identify potential water application improvements
- Applying the knowledge of soil characteristics for water release, allowable irrigation application rates, available water capacity, and water table depths
- Applying the knowledge of crop characteristics for water use rates, growth characteristics, yield and quality, rooting depths, and allowable plant moisture stress levels
- Water delivery schedule effects
- Water flow measurement for onfield water management
- Irrigation scheduling techniques
- Irrigation system evaluation techniques

See Chapter 15 for resource planning and evaluation tools and for applicable worksheets.

652.0901 Irrigation water management concepts

(a) Irrigation water management concepts

Field monitoring techniques can be used to establish when and how much to irrigate. The long existing rule of thumb for loamy soils has been that most crops should be irrigated before more than half of the available soil water in the crop root zone has been used. It has also been demonstrated that certain crops respond with higher yields and product quality by maintaining a higher available soil-water content, especially with clay soils. Desired or allowable soil moisture depletion levels, referred to as Management Allowable Depletion (MAD), are described in Chapter 2, Soils, and Chapter 3, Crops. If the Available Water Capacity (AWC) of the soil, the crop rooting depth for the specific stage of growth, and the MAD level are known, then *how much water to apply* per irrigation can be determined. Part 652.0903 reviews measurement of soil-water content and describes tools, techniques, and irrigation scheduling. Part 652.0908, Water management, addresses the importance of measuring a predetermined quantity of water onto the field.

(1) Concepts of irrigation water management

The simplest and basic irrigation water management tool is the equation:

$$Q T = D A$$

where:

- Q = flow rate (ft³/s)
- T = time (hr)
- D = depth (in)
- A = area (acres)

For example, a flow rate of 1 cubic foot per second for 1 hour = 1-inch depth over 1 acre. This simple equation, modified by an overall irrigation efficiency, can be used to calculate daily water supply needs by plants, number of acres irrigable from a source, or the time required to apply a given depth of water from an irrigation well or diversion. Typically, over 80 percent of IWM concerns can be at least partly clarified by the application of this equation.

Quantity of water to be applied is often determined by available water capacity of the soil, planned management allowable depletion, and estimated crop evapotranspiration (ET_c). When rainfall provides a significant part of seasonal plant water requirements, irrigation can be used to supplement plant water needs during dry periods resulting from untimely rainfall events.

Water should be applied at a rate or quantity and in such a manner to have sufficient soil-water storage, be nonerosive, have minimal waste, and be nondegrading to public water quality. Irrigations are timed to replace the planned depleted soil moisture used by the crop. Effective rainfall during the growing season should be taken into consideration.

(2) When to irrigate

When to irrigate is dependent on the crop water use rate, sometimes referred to as irrigation frequency. This rate can be determined by calculation of ET_c rate for specific crop stage of growth, monitoring plant moisture stress levels, monitoring soil-water depletion, or a combination if these. Too frequently, crop condition is observed to determine when to irrigate. When plants show stress from lack of moisture, it is typically too late. Generally, crop yield and product quality have already been adversely affected. The over-stress appearance may also be from shallow roots resulting from overirrigation or from disease, insect damage, or lack of trace elements. Certain plants can be excessively stressed during parts of their growth stage and have little effect on yield. Part 652.0903 reviews measurement of plant moisture stress levels and describes tools, techniques and irrigation scheduling.

(3) Rainfall management

In moderate to high rainfall areas, managing the timing of irrigations to allow effective use of rainfall during the irrigation season is a common practice. The irrigation decisionmaker can attempt to predict rainfall events and amounts (which too often does not work), or the depleted soil water is never fully replaced with each irrigation. Instead, between 0.5 and 1.0 inch of available water capacity in the soil profile can be left unfilled for storage of potential rainfall. Rainfall probability during a specific crop growing period and the level of risk to be taken must be carefully considered by the irrigation decisionmaker. Applied irrigation water should always be considered supplemental to rainfall events.

(4) Water supply limitations

Where water supply is limiting, deficit or partial year irrigation is often practiced. Partial irrigation works well with lower value field crops. It does not work well with high value crops where quality determines market price, especially the fresh vegetable and fruit market. Typically, water is applied at times of critical plant stress (see Chapter 3, Crops) or until the water is no longer available for the season. Yields are generally reduced from their potential, but net benefit to the farmer may be highest, especially when using high cost water or a declining water source, such as pumping from a declining aquifer. An economic evaluation may be beneficial.

(5) Water delivery

Water supply and delivery schedules are key to proper irrigation water management. When water users pump from a well or an adjacent stream or maintain a diversion or storage reservoir, they control their own delivery. In some areas delivery is controlled by an irrigation district or company. Delivery by an irrigation district may be controlled by its own institutional constraints (management) or by canal supply and structure capacity limitations.

Flexibility in delivery generally is controlled by institutional restraints or capacity limitations on the downstream ends of irrigation laterals. Capacity limitations are primarily because required storage is not within or very close to farm delivery locations. Where water supplies are not limited and delivery is in open canal systems, irrigation districts often carry from 10 to 30 percent additional water through the system as *management water* to reduce district water management requirements. Low cost semi or fully automated controllers are available for water control structures that accomplish the same purpose with less water. (One large irrigation district discovered they had over 20 percent more water available to users when water measuring devices and semiautomatic gate controls were installed at each major lateral division.) The following schedules are widely used.

(i) Fixed and rotation—With fixed delivery time at fixed delivery rates, irrigation districts provide a single delivery point to an individual water user or to a group of neighbors that rotate the delivery among themselves. Generally the delivery schedule is the

easiest to use and the least costly. Turnout gates are adjusted to deliver a given share of water on a continual basis. This delivery schedule however, generally promotes the philosophy of **use the water (whether the crop needs it or not) or lose it**. This practice is not conducive to proper irrigation scheduling. Many project delivery systems have been designed based on this delivery schedule method because of the perception it allows minimum capacity sizing of all components. When in fact, only the lower end of laterals (± 5 water users) is affected.

(ii) Arranged—The water user requests or orders water delivery at a rate, start time, and duration in advance. Most arranged schedules require a minimum of 24 to 48 hours advance notice for water to be turned on or turned off. Arranged schedules often require water be turned on or off at specific times; i.e., 7 to 9 a.m., to correspond to ditch riders' schedules. This delivery schedule requires good, advance communication between water user and irrigation company. Irrigation districts need to have flexibility in their delivery with this method. Temporary storage facilities are typically needed because water spills out the end of the delivery system.

(iii) Demand—A demand schedule is one that allows users to have flexibility of frequency, rate, and duration of delivery. A municipal water system meets this type of delivery schedule system. It also works best where the water user owns and maintains the water supply; i.e., well, storage reservoir, and stream diversion. On-demand schedules are technically feasible for most moderate to large irrigation districts. Except for downstream ends of supply laterals, canal and lateral sizes are the same whether demand, rotation, or arranged deliveries are used. Temporary storage is provided by main canals and laterals; however, canal appurtenances (diversions, turnouts, and flow measuring devices) must be sized accordingly. With smaller delivery systems, slight oversizing of main canals and temporary storage facilities can often be provided at a small increase in delivery system cost. Modifications to on-demand schedule can work well. For example, the rate may be limited, but frequency and duration made flexible. This method works quite well in many projects if the main canal capacity is increased slightly and if temporary storage facilities are provided within the delivery system.

Most onfarm irrigation delivery and distribution facilities are limited by their capacity. Therefore, variable frequency and duration are typically the best delivery schedule reasonably available. A good irrigation scheduling program can be developed around this type of delivery schedule.

(6) Water measurement

A key factor in proper irrigation water management is knowing how much water is available to apply or is applied to a field through an irrigation application system. Many devices are available to measure open channel or pipeline flows. See Chapter 7, Farm Distribution Systems, for more details. Too many irrigators consider water measurement a regulation issue and an inconvenience. The importance of flow measurement for proper irrigation water management cannot be overstressed. Typically, less water is used where adequate flow measurement is a part of the water delivery system and a unit cost billing mechanism is used. In addition to chapter 7, the joint USBR, ARS, and NRCS water measurement publication should be consulted.

652.0902 Soil-plant-water balance

Detailed soil and crop characteristics were described in chapters 2 and 3 of this guide. Applying those characteristics and monitoring changes in soil-water content, plant moisture tension levels, canopy cover, root development, and water use rates provide valuable factors to implement proper irrigation water management. Generally, water budgets are a planning tool, water balance is the daily accounting of water availability. Both can be important irrigation water management tools.

(a) Soil

Soil intake characteristics, field capacity, wilting point, available water capacity, water holding capacity, management allowed depletion, and bulk density are soil characteristics that irrigation consultants and decisionmakers must take into account to implement proper irrigation water management. Also see Chapter 2, Soils, and Chapter 17, Glossary.

Field capacity (FC) is the amount of water remaining in the soil when the downward water flow from gravity becomes negligible. It occurs soon after an irrigation or rainfall event fills the soil. Field capacity is generally assumed to be 1/10 atmosphere (bar) soil-water tension for sandy soils and 1/3 atmosphere (bar) tension for medium to fine textured soils. For accurate results these points should be measured in the laboratory, but can be measured (reasonably close) in the field if done soon after an irrigation and before plants start using soil moisture.

Free or excess water is available for plant use for the short time it is in the soil. With coarse textured soil, excess water can be available for a few hours because free water drains rapidly, but with fine textured soil it can be up to 2 days because free water drains more slowly. Laboratory results are typically good for homogenous soils, but results may be inaccurate for stratified soils because of free water movement being restricted by fine textured layers. In stratified soils, proper field tests can provide more representative data.

In stratified soils, a common perception that downward water movement is held up by fine textured soil layers is not entirely true. In fact, water enters fine textured soil layers almost immediately. However, because the fine textured soil has greater soil-water tension, downward water movement into a coarse textured soil below is restricted. A recently published NRCS video, *How Water Moves Through Soil*, demonstrates water movement in various soil profiles.

Wilting point (WP), sometimes called wilting coefficient, is the soil-water content below which plants cannot obtain sufficient water to maintain plant growth and never totally recover. Generally, wilting point is assumed to be 15 atmospheres (bar) tension. It is measured only in the laboratory using a pressure plate apparatus and is difficult to determine in the field.

Available water capacity (AWC) is that portion of water in the soil (plant root zone) that can be absorbed by plant roots. It is the amount of water released between field capacity and permanent wilting point, also called available water holding capacity. Average available water capacities are displayed in table 9-1, based on texture in the profile. A specific soil series (i.e., Warden) can have different surface textures. Average soil-water content based on various textures and varying bulk density is displayed in figure 9-1.

Soil-water content (SWC) is the water content of a given volume of soil at any specific time. This is the water content that is measured by most soil-water content measuring devices. Amount available to plants then is SWC - WP.

Figure 9-1 Total soil-water content for various soil textures with adjustment for changes in bulk density

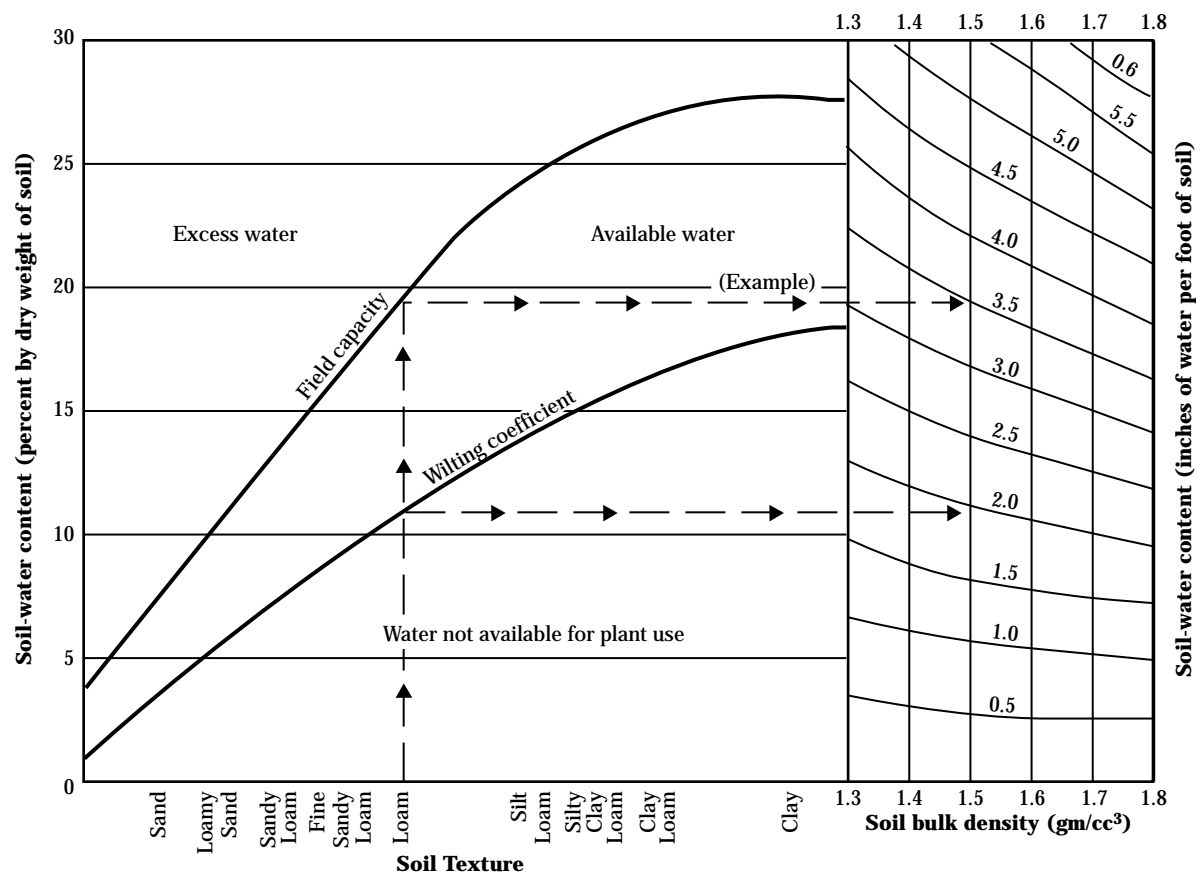

Management allowable depletion (MAD) is the desired soil-water deficit at the time of irrigation. It can be expressed as the percentage of available soil-water capacity or as the depth of water that has been depleted in the root zone. Providing irrigation water at this time minimizes plant water stresses that could reduce yield and quality.

Bulk density is the mass of dry soil per unit bulk volume. It is the oven dried weight of total material per unit volume of soil, exclusive of rock fragments 2 mm or larger. The volume applies to the soil near field capacity water content. To convert soil-water content on a dry weight basis to volumetric basis, soil bulk density must be used. Bulk density is an indicator of how well plant roots are able to extend into the soil. See Chapter 2, Soils, for example of conversion procedure. Core soil samplers are most commonly used to collect in-place density samples. Commercial samplers available include the Madera sampler in which a 60 cc sample is collected. This sampler was developed for use with a neutron probe. The Eley Volumeter and the AMS core sampler are other examples. Other commercial push type core samplers use known volume removable retaining cylinders. These cylinders contain the core samples.

NRCS soil scientists use liquid saran to coat soil clods, and the volume of the clod is determined in a soils laboratory using a water displacement technique. This process provides the least disturbance to a soil sample; however, obtaining clods from sandy soils can be difficult. Techniques to determine density used in construction, such as using a sand cone, and balloon methods can also be used in soils with coarse rock fragments or with coarse sandy soils. Rock fragments cause disturbance of core samples when using a push type core sampler.

Soil-water profiles are a plot of soil-water content versus soil root zone depth. As a water management tool, this plot visually displays available water, total water content, or water content at the time to irrigate level (fig. 9-2).

The rate of decrease in soil-water content is an indication of plant water use and evaporation, which can be used to determine **when to irrigate and how much to apply**. This is the basic concept in scheduling irrigations.

Table 9-1 Available water capacity for various soil textures

Soil texture	Estimated AWC	
	in/in	in/ft
Sand to fine sand	0.04	0.5
Loamy sand to loamy fine sand	0.08	1.0
Loamy fine sands, loamy very fine sands, fine sands, very fine sands	0.10	1.2
Sandy loam, fine sandy loam	0.13	1.6
Very fine sandy loam, silt loam, silt	0.17	2.0
Clay loam, sandy clay loam, silty clay loam	0.18	2.2
Sandy clay, silty clay, clay	0.17	2.0

Figure 9-2 Soil-water content versus depth

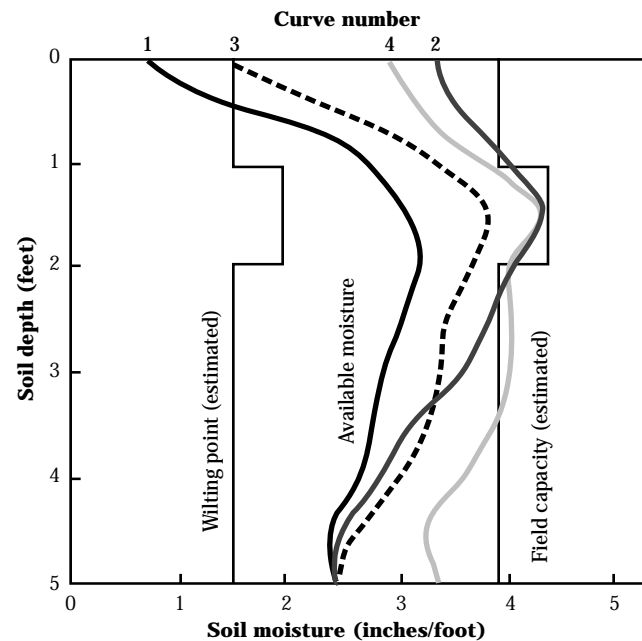

An interpretation of data that soil moisture curves 1 through 4 on figure 9–2 represent includes:

- Curve #1—This curve shows the upper 6 inches of the soil profile is below wilting point. Shallow rooted plants are excessively stressed. Below a depth of 12 inches, soil moisture is still ample at 50 percent. If it is desirable to maintain soil moisture at 50 percent of total available moisture or higher (i.e., for plants with less than 10 inches rooting depth), it is time to irrigate, maybe even a little late to maintain optimum growth conditions. Deeper rooted plants are still drawing moisture from below a depth of 12 inches.
- Curve #2—This curve represents what soil moisture may be a day or two after an irrigation. The lower part of the soil profile did not reach field capacity. However, this situation may be desirable for crops with less than 25-inch rooting depth. For deeper rooted crops, additional water should have been applied.
- Curve #3—This curve represents moisture withdrawal from shallow rooted plants. There is ample moisture below 12 inches. A light application of water, to 12 inches depth, is needed for shallow rooted plants. A heavy application of water could put excess water below the crop root zone.
- Curve #4—This curve represents what soil moisture may be a day or two after an irrigation. The soil profile below a depth of 12 inches is nearly at field capacity, indicating a good irrigation application to approximately a 4-foot depth. Water is probably still moving downward.

(b) Measuring soil-water content

To measure soil-water content change for the purpose of scheduling irrigation, several site locations in each field and each horizon (or if homogenous at 6 inch depth increments) at the site (test hole) should be sampled. Quite often, the experienced irrigation decisionmaker calibrates available soil water in the soil profile relative to one sample at a specific depth. Multiple sites in a field are used to improve confidence in determining when and how much water to apply.

Most commercial soil-water content measuring devices provide a numerical measurement range. This measurement range is an indication of relative water content. The range might be 0 to 100 percent AWC or 0

to 10. Readings represent different specific soil-water content depending on soil type. Most devices that indicate relative values are difficult to calibrate to relate to specific quantitative values. A calibration curve for each specific kind of soil and soil-water content (tension) should be available with the device or needs to be developed.

If the irrigator is only interested in knowing when to irrigate, a specific indicated value on the gauge or meter may be sufficient. The manufacturer may provide this information either prebuilt into the device or with separate calibration curves. Irrigators must know what number (value) on the meter represents what approximate soil-water content level for their field and soils. They then must associate a specific number on the gauge to when irrigation is needed for each soil texture. Irrigation system design and water management planning provide the **how much to apply**. Example worksheets are provided in Chapter 15, Planning and Evaluation Tools.

(1) Methods and devices to measure or estimate soil-water content

(i) Soil feel and appearance method—This method is easy to implement and with experience can be accurate. Soil samples are collected in the field at desired depths, typically at 6 inch increments. Samples are compared to tables or pictures that give moisture characteristics of different soil textures in terms of feel and appearance. With practice, estimates can be obtained within 10 percent of actual. Typically the irrigation decisionmaker needs to learn only a few soils and textures.

Exhibit 9–1 displays the identification of soils and corresponding available water content when using feel and appearance method for determining soil-water content. The NRCS color publication, *Estimating Soil Moisture by Feel and Appearance*, is reproduced in chapter 15. Figure 9–3 is an example worksheet for determining soil-water deficient (SWD) in the soil profile.

Every operation can afford tools necessary to use this method of soil-water determination. Tools required are a push type core sampler, auger, or shovel. Care should be taken to not mix soil layers when sampling. Example forms for recording field data and calculating depleted or available soil-water content are in chapter 15.

Exhibit 9-1 Guide for estimating soil moisture conditions using the feel and appearance method

Available soil moisture (%)	Coarse texture fine sand, loamy fine sand	Moderately coarse texture sandy loam, fine sandy loam	Medium texture sandy clay loam, loam, silt loam	Fine texture clay loam, silty clay loam
	0.6 – 1.2	1.3 – 1.7	1.5 – 2.1	1.6 – 2.4
	----- Available water capacity (in/ft) -----			
0 – 25	Dry, loose, will hold together if not disturbed, loose sand grains on fingers with applied pressure	Dry, forms a very weak ball ^{1/} , aggregated soil grains break away easily from ball	Dry, soil aggregations break away easily, no moisture staining on fingers, clods crumble	Dry, soil aggregations easily separate, clods are hard to crumble with applied pressure
25 – 50	Slightly moist, forms a very weak ball with well defined finger marks, light coating of loose and aggregated sand grains remain on fingers	Slightly moist, forms a weak ball with defined finger marks, darkened color, no water staining on fingers grains break away	Slightly moist, forms a weak ball with rough surfaces, no water staining on fingers few aggregated soil pressure	Slightly moist, forms a weak ball, very few soil aggregations break away, no water stains, clods flatten with applied
50 – 75	Moist, forms a weak ball with loose and aggregated sand grains remain on fingers, darkened color, heavy water staining on fingers, will not ribbon ^{2/}	Moist, forms a ball with defined finger marks, very light soil water staining on fingers, darkened color, will not slick	Moist, forms a ball, very light water staining on fingers, darkened color, pliable, forms a weak ribbon between thumb and forefinger	Moist, forms a smooth ball with defined finger marks, light soil water staining on fingers, ribbons between thumb and forefinger
75 – 100	Wet, forms a weak ball, loose and aggregated sand grains remain on fingers, darkened color, heavy water staining on fingers, will not ribbon	Wet, forms a ball with wet outline left on hand, light to medium water staining on fingers, makes a weak ribbon between thumb and forefinger	Wet, forms a ball with well defined finger marks, light to heavy soil water coating on fingers, ribbons between thumb and forefinger	Wet, forms a ball, uneven medium to heavy soil water coating on fingers, ribbons easily between thumb and forefinger
Field capacity (100%)	Wet, forms a weak ball, light to heavy soil water coating on fingers, wet outline of soft ball remains on hand	Wet, forms a soft ball, free water appears briefly on soil surface after squeezing or shaking, medium to heavy soil water coating on fingers	Wet, forms a soft ball, free water appears briefly on soil surface after squeezing or shaking, medium to heavy soil water coating on fingers	Wet, forms a soft ball, free water appears on soil surface after squeezing or shaking, thick soil water coating on fingers, slick and sticky

1/ Ball is formed by squeezing a hand full of soil very firmly with one hand.

2/ Ribbon is formed by when soil is squeezed out of hand between thumb and forefinger.

Figure 9-3 Available soil-water holding worksheet (feel and appearance)

U.S. Department of Agriculture
Natural Resources Conservation Service

Soil Water Holding Worksheet

Field _____ Location in field _____
 Year _____ By _____
 Crop _____
 Planting data _____ Emergence data _____
 Soil name if available _____

Factor	Season	
	1st 30 days	Remainder of season
Root zone depth or max soil depth - ft		
Available water capacity AWC - in		
Management allowed deficit MAD - %		
Management allowed deficit MAD - in		

(Note: Irrigate prior to the time that SWD is equal to or greater than MAD - in)

Estimated irrigation system application efficiency _____ percent

Data obtained during first field check					Data obtained each check		
(1) Depth range (in)	(2) Soil layer thickness (in)	(3) Soil texture	(4) Available water capacity (AWC) (in/in)	(5) AWC in soil layer (in)	(6) Field check number	(7) Soil water deficit (SWD) (%)	(8) Soil water deficit (SWD) (in)
					1		
					2		
					3		
					4		
					5		
					6		
					7		
					8		
					1		
					2		
					3		
					4		
					5		
					6		
					7		
					8		

Total AWC for root zone depth of _____ ft=
 Total AWC for root zone depth of _____ ft=

AWC(5) = layer thickness(2) x AWC(4)

SWD(8) = $\frac{AWC(5) \times SWD(7)}{100}$

SWD summary		
Check number	Check date	SWD totals
1		
2		
3		
4		
5		
6		
7		
8		

(ii) Gravimetric or oven dry method—Soil samples are collected in the field at desired depths using a core sampler or auger. Care must be taken to protect soil samples from drying before they are weighed. Samples are taken to the office work room, weighed (wet weight), oven-dried, and weighed again (dry weight). An electric oven takes 24 hours at 105 degrees Celsius to adequately remove soil water. A microwave oven takes a few minutes. Excessive high temperatures can degrade the soil sample by burning organic material. The drying oven can exhaust moisture from several samples at one time, but the microwave typically dries only one or two samples at a time. Percentage of total soil-water content on a dry weight basis is computed. To convert to a volumetric basis, the percentage water content is multiplied by the soil bulk density. Available soil water is calculated by subtracting percent total soil water at wilting point.

Tools required to use this method are a core sampler or auger, soil sample containers (airtight plastic bags or soil sample tins with tight lids), weighing scales, and a drying oven. Soil moisture will condense inside plastic bags, when used. This is part of the total soil moisture in the sample and must be accounted for in the weighing and drying operation. Standard electric soils drying ovens are commercially available. A much shorter drying time can be used with a microwave oven or infrared heat lamp, but samples need to be turned and weighed several times during drying to check water loss. Samples should be allowed to cool before weighing. These drying procedures are more labor intensive than using a standard drying oven at 105 degrees Celsius. Figure 9-4 displays an example worksheet for determining soil-water content of the soil profile.

(iii) Carbide soil moisture tester—A carbide soil moisture tester (sometimes called Speedy Moisture Tester) can provide percent water content of soil samples in the field; however, practice is necessary to provide satisfactory and consistent results. The tester is commercially available. Typically, a 26-gram soil sample and a measure of calcium carbide are placed in the air tight container. Some models use a 13-gram sample. When calcium carbide comes in contact with water in the soil, a gas (oxy-acetylene, C_2H_2) develops. As the reaction takes place, the gas develops a pressure in the small air tight container. The amount of gas developed is related to amount of water in the soil sample (providing excess carbide is present).

Caution: If inadequate carbide is available to react with all of the water, indicated moisture content is low. The higher the water content, the higher the pressure. The tester provides a gauge that reads percent soil-water content on a wet-weight basis. A standard chart is available to convert percent soil-water content from wet weight basis to dry weight basis. Figure 9-4 displays an example worksheet for determining soil-water content of the soil profile. The worksheet shown in figure 9-5 can help determine soil moisture and bulk density using the Eley volumeter and carbide moisture tester. Table 9-2 displays oven dry moisture content, P_d , based on meter gauge reading, W_p . This instrument measures total water held in the soil sample. To obtain AWC, subtract water held at W_p .

Figure 9-4 Soil-water content worksheet (gravimetric method)

U.S. Department of Agriculture
Natural Resources Conservation Service

**Worksheet
Soil-Water Content
(Gravimetric Method)**

Land user _____ Date _____ Field office _____

Taken by _____ Field name/number _____

Soil name (if available) _____ Crop _____ Maximum effective root depth _____ ft

Depth range inches	Soil layer thickness inches d	Soil texture	Sample			Tare weight g Tw	Net dry weight g Dw	Volume of sample cc Vol	Moisture percentage % Pd	Bulk density g/cc Dbd	Soil-water content in/in SWC	Layer water content inches TSWC
			Wet weight g WW	Dry weight g DW	Water loss g Ww							

Dry weight (Dw) of soil = DW - TW = _____ g Weight of water lost (Ww) = WW - DW = _____ g Bulk density (Dbd) = $\frac{Dw(g)}{Vol (cc)}$ = _____ g/cc

Percent water content, dry weight Pd = $\frac{Ww}{Dw} \times 100 =$ _____ % Soil-water content (SWC) = $\frac{Dbd \times Pd}{100 \times 1} =$ _____ in/in

Total soil-water content in the layer (TSWC) = SWC x d = _____ inches

Figure 9-5 Determination of soil moisture and bulk density using Eley volumeter and Speedy moisture tester

U.S. Department of Agriculture
Natural Resources Conservation Service

**Determination of Soil Moisture and Bulk Density (dry)
Using Eley Volumeter and Carbide Moisture Tester**

Farm _____ Location _____ SWCD _____
Crop _____ Soil type _____ Date _____ Tested by _____

(1)	(2)	(3)	(4)	(5)	(6)	(7)	(8)	(9)	(10)	(11)	(12)	(13)
Texture	Thickness of layer	Volumeter							Bulk density (g/cc)	Soil-water content (in)	Soil-water content at field capacity	Soil-water deficit (in)
		Reading before (cc)	Reading after (cc)	Volume (cc)	% Wet wt.	% Dry wt.	% Wilting point	% Soil-water				
	d			V	W _p	P _d	P _w	SWC _p	Db _d	SWC	AWC	SWD
Totals												

Wet weight of all samples in grams unless otherwise shown.

$$Db_d = \frac{26}{V(1 + P_d)} \times 100$$

$$SWC = \frac{Db_d \times SWC_p \times d}{100 \times 1}$$

$$SWC_p = P_d - P_w$$

Table 9-2 Oven dry moisture content based on 3-minute carbide moisture tester readings

Gauge reading ^{1/}	Oven dry moisture, P _d (%)									
	0	.1	.2	.3	.4	.5	.6	.7	.8	.9
2	2.0	2.1	2.2	2.3	2.4	2.5	2.6	2.7	2.8	2.9
3	3.0	3.1	3.2	3.3	3.4	3.5	3.6	3.7	3.8	3.9
4	4.0	4.1	4.2	4.3	4.4	4.5	4.6	4.7	4.8	4.9
5	5.1	5.2	5.3	5.4	5.5	5.7	5.8	5.9	6.0	6.1
6	6.2	6.3	6.4	6.5	6.6	6.8	6.9	7.0	7.1	7.2
7	7.3	7.4	7.5	7.6	7.7	7.9	8.0	8.1	8.2	8.3
8	8.4	8.5	8.6	8.7	8.8	9.0	9.1	9.2	9.3	9.4
9	9.5	9.6	9.7	9.8	9.9	10.1	10.2	10.3	10.4	10.5
10	10.6	10.7	10.8	11.0	11.1	11.2	11.3	11.4	11.6	11.7
11	11.8	11.9	12.0	12.2	12.3	12.4	12.5	12.6	12.8	12.9
12	13.0	13.1	13.3	13.4	13.5	13.7	13.8	13.9	14.0	14.2
13	14.3	14.4	14.6	14.7	14.8	15.0	15.1	15.2	15.3	15.5
14	15.6	15.7	15.9	16.0	16.2	16.3	16.4	16.6	16.7	16.9
15	17.0	17.1	17.3	17.4	17.5	17.7	17.8	17.9	18.0	18.2
16	18.3	18.4	18.6	18.7	18.9	19.0	19.1	19.3	19.4	19.6
17	19.7	19.8	20.0	20.1	20.3	20.4	20.5	20.7	20.8	21.0
18	21.1	21.3	21.4	21.6	21.7	21.9	22.0	22.2	22.3	22.5
19	22.6	22.8	22.9	23.1	23.2	23.4	23.5	23.7	23.8	24.0
20	24.1	24.3	24.4	24.6	24.7	24.9	25.0	25.2	25.3	25.5
21	25.6	25.8	25.9	26.1	26.2	26.4	26.5	26.7	26.8	27.0
22	27.1	27.3	27.4	27.6	27.7	27.9	28.1	28.2	28.3	28.5
23	28.6	28.8	28.9	29.1	29.2	29.4	29.6	29.7	29.9	30.0
24	30.2	30.4	30.5	30.7	30.8	31.0	31.1	31.3	31.4	31.6
25	31.7	31.9	32.0	32.2	32.3	32.5	32.7	32.8	33.0	33.1
26	33.3	33.5	33.6	33.8	33.9	34.1	34.3	34.4	34.6	34.7
27	34.9	35.1	35.2	35.4	35.5	35.7	35.9	36.0	36.2	36.3
28	36.5	36.7	36.8	37.0	37.1	37.3	34.5	37.6	37.8	37.9
29	38.1	38.3	38.4	38.6	38.8	39.0	39.1	39.3	39.5	39.6
30	39.8	40.0	40.1	40.3	40.5	40.7	40.8	41.0	41.2	41.3
31	41.5	41.7	41.8	42.0	42.2	42.4	42.5	42.7	42.9	43.0
32	43.2	43.4	43.5	43.7	43.8	44.0	44.2	44.3	44.5	44.6
33	44.8	45.0	45.1	45.3	45.5	45.7	45.8	46.0	46.2	46.3

1/ Carbide moisture tester—3-minute readings = W_p

(iv) Tensiometers (moisture stake)—Soil-water potential (tension) is a measure of the amount of energy with which water is held in the soil. Tensiometers are water filled tubes with hollow ceramic tips attached on the lower end and a vacuum gauge on the upper end. The container is air tight at the upper end. The device is installed in the soil with the ceramic tip in contact with the soil at the desired depth. The water in the tensiometer comes to equilibrium with soil water surrounding the ceramic tip. Water is pulled out of the ceramic tip by soil-water potential (tension) as soil water is used by plants. This creates a negative pressure (vacuum) in the tube that is indicated on the vacuum gauge. When the soil is rewetted, the tension gradient reduces, causing water to flow from the soil into the ceramic tip.

The range of tension created by this device is 0 to 100 centibars (0 to 1 atmospheres). Near 0 centibars is considered field capacity, or near 0 soil water tension. Practical operating range is 0 to 80 centibars. The upper limit of 80 centibars corresponds to about: 90 percent AWC depletion for a sandy soil and about 30 percent AWC depletion for medium to fine textured soils. This limits the practical use of tensiometers to medium to fine textured soils with high frequency irrigation or where soil-water content is maintained at high levels. Tensiometers break suction if improperly installed and if the soil-water tension exceeds practical operating limits, typically 80 to 85 centibars. Once vacuum is broken, the tube must be refilled with water and the air removed by using a small hand-operated vacuum pump. A period to establish tensiometer-soil-water stability follows.

Tensiometers require careful installation, and maintenance is required for reliable results. They must also be protected against freeze damage. Maintenance kits that include a hand vacuum pump are required for servicing tensiometers. The hand pump is used to draw out air bubbles from the tensiometer and provide an equilibrium in tension. Tensiometers should be installed in pairs at each site, at one-third and two-thirds of the crop rooting depth. A small diameter auger (or half-inch steel water pipe) is required for making a hole to insert the tensiometer. Figure 9-6 shows a tensiometer and gauge and illustrates installation and vacuum pump servicing. Tensiometers are commercially and readily available at a reasonable cost.

When installing tensiometers, make a heavy paste from part of the soil removed at the depth the ceramic tip is to be placed. When the hole has been augured about 2 inches below the desired depth of the ceramic tip, the paste is placed in the hole. As you install the tensiometer tube, move the tube up and down a few times to help assure good soil paste contact with the ceramic tip. Do not handle or touch the ceramic tip as contamination from material and body oil on the hands affects water tension on the tip. If the soil is wet at the desired ceramic tip depth, tensiometers can be installed by driving a rod or 0.5-inch diameter galvanized iron pipe to the desired depth. The end of the driving rod should be shaped the same as, but slightly smaller than the tensiometer tip. Pour a little water in the hole, move the driving rod up and down a few times to develop a soil paste at the bottom of the hole. Insert tensiometer tube, move the tube up and down a few times to help assure good soil paste contact with the ceramic tip.

Tensiometers installed at different rooting depths have different gauge readings because of soil water potential change in rooting depths. With uniform deep soil, about 70 to 80 percent of soil moisture withdrawal by plant roots is in the upper half of the rooting depth. Recommended depths for setting tensiometers are given in table 9-3.

Table 9-3 Recommended depths for setting tensiometers

Plant root zone depth (in)	Shallow tensiometer (in)	Deep tensiometer (in)
18	8	12
24	12	18
36	12	24
> 48	18	36

Figure 9-6 Tensiometer, installation, gauge, and servicing

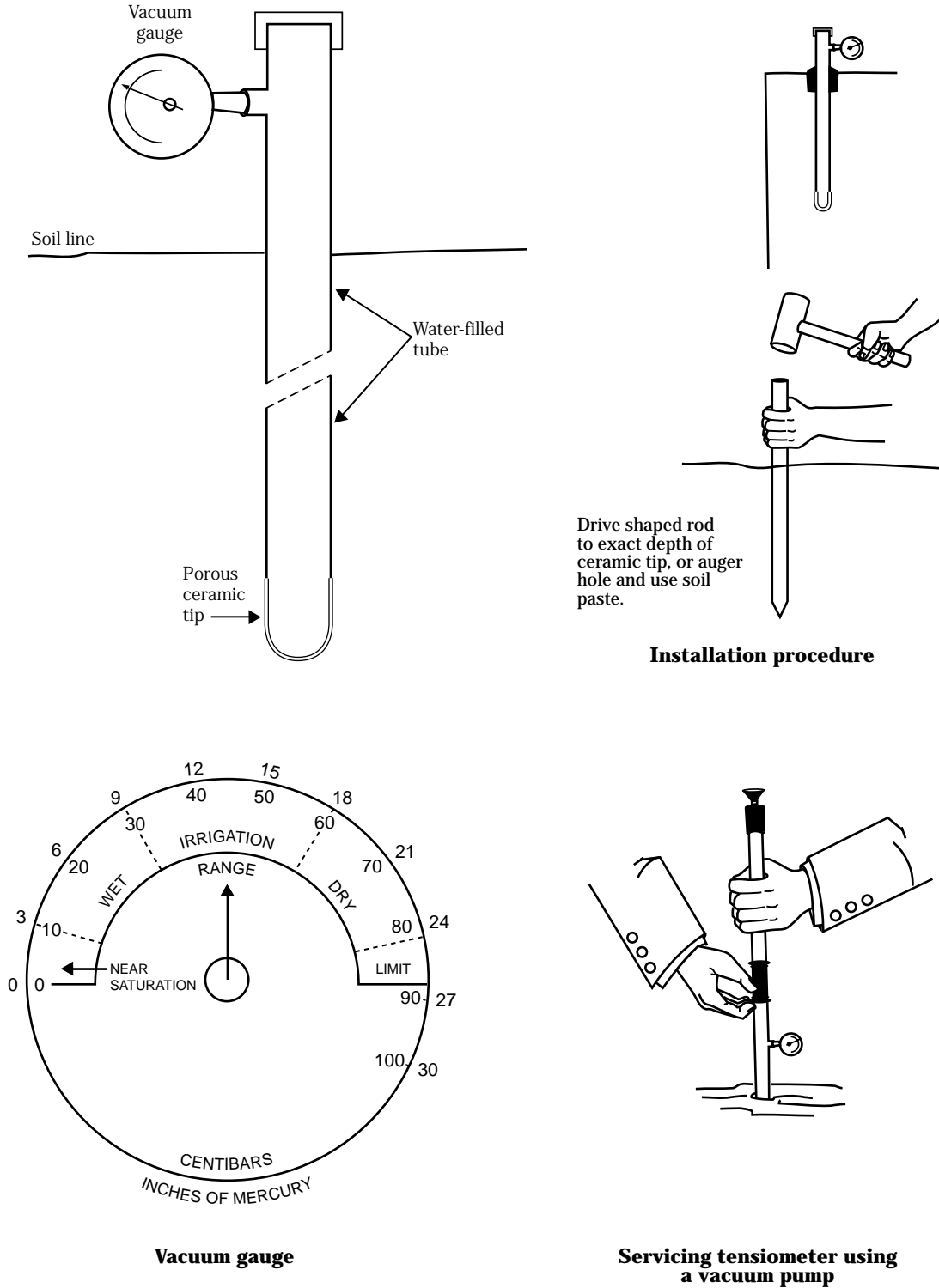

(v) *Electrical resistance (porous) blocks*—Electrical resistance blocks are made of material where water moves readily into and out of the block. Materials are typically gypsum, ceramic, nylon, plastic, or fiberglass. When buried and in close contact with the surrounding soil, water in the block comes to water tension equilibrium with the surrounding soil. Once equilibrium is reached, different properties of the block affected by its water content can be measured. Electrical resistance blocks work best between 0 and 2 atmospheres (bars). Thus, they have a wider operating range than do tensiometers, but are still limited to medium to coarse textured soils.

Electrical resistance blocks are buried in the soil at desired depths. Intimate contact by the soil is essential. With porous blocks, electrical resistance is measured across the block using electrodes encased in the block. Electrical resistance is affected by the water content of the block, which is a function of the soil-water tension. Electrical resistance is measured with an ohm meter calibrated to provide numerical readings for the specific type of block. Higher resistance readings mean lower water content, thus higher soil-water tension. Lower resistance readings indicate higher water content and lower soil-water tension.

Gypsum blocks are affected by soil salinity, which cause misleading readings, and are prone to breakdown in sodic soils. They are best suited to medium and fine texture soils. Being made of gypsum, the blocks slowly dissolve with time in any soil. The rate is dependent upon pH and soil-water quality. Freezing does not seem to affect them. Blocks made from other material do not dissolve; therefore, have a longer life. Electrical resistance blocks are relatively low cost and with reasonable care are easy to install. Close contact with soil is important.

Installation tools required are a small diameter auger for making a hole for inserting blocks, a wooden dowel to insert blocks, and water and a container for mixing soil paste. (Multiple electrical resistance blocks can be installed in the same auger hole.) After the hole has been augered to about 2 inches below the deepest block installation depth, a soil paste is made from removed soil and placed about 6 inches deep in the bottom of the hole. Wet resistance block with clean water.

Handling or touching the electrical resistance block may affect soil moisture readings. With the electrical resistance block carefully held on the end of the dowel by the wires, place the block in the hole at the desired depth with a slight up and down movement to help assure soil paste contact with the block. Check for broken wires with an electric meter. Hold the electric wires along the side of the hole and carefully fill the hole with soil. Soil should be replaced by layers. It should be from the same layer from which it was removed. Repeat soil paste and block procedure at each electrical resistance block depth.

When electrical resistance blocks are located properly, almost anyone can obtain readings. One person with a meter can provide readings for many field test sites. Where farms are small, neighbors can share a single meter. Following each reading a report is developed and given to each farm irrigation decisionmaker. The irrigation decisionmaker must learn to interpret meter readings to decide the right time to irrigate.

Electrical resistance blocks and resistance meters (battery powered) are commercially and readily available. Table 9-4 displays interpretations of readings from a typical electrical resistance meter.

(vi) *Thermal dissipation blocks*—These blocks are porous ceramic materials in which a small heater and temperature sensors are imbedded. This allows measurement of the thermal dissipation of the block, or the rate at which heat is conducted away from the heater. This property is directly related to the water content of the block and thus soil-water content. Thermal dissipation blocks must be individually calibrated. They are sensitive to soil-water content across a wide range. Meter readings can be used directly, or translated using manufacturer's charts to soil-water tension. Specific meters are to be used with specific type of blocks.

(vii) Neutron scattering—A neutron gauge estimates the total amount of water in a volume of soil by measuring the amount of hydrogen molecules in the soil. Hydrogen is a key element in water (i.e., H₂O). The device is commonly called a neutron probe. The probe itself consists of a radioactive source that emits (scatters) high energy neutrons and a slow speed neutron detector housed in a unit that is lowered into a permanent access tube installed in the soil. The probe is connected by a cable to a control unit (neutron gauge) remaining at the surface. The control unit includes electronics for time control, a neutron counter, memory, and other electronics for processing readings.

Fast neutrons, emitted from the source and passing through the access tube into the surrounding soil, gradually lose their energy (and speed) through collisions with hydrogen molecules. The result is a mass of slowed or thermalized neutrons, some of which diffuse back to the detector. The detector physically counts returned neutrons. The number of slow neutrons counted in a specific interval of time is directly related

to the volumetric soil-water content in a sphere ranging from 6 to 16 inches. A higher count indicates higher soil-water content, and a lower count indicates lower soil-water content.

When properly calibrated and operated, the neutron gauge can be the most accurate and most repeatable method of measuring soil-water content. When plotted, count versus soil-water content is a linear relationship. The gauge as it comes from the manufacturer is calibrated to a general kind of soil (medium texture) and to a medium soil bulk density. A microprocessor calculates soil-water content in acre-inches or percent, dry weight basis. However, the gauge must be calibrated for in-place soils and type of access tube material being used; i.e., PVC, aluminum, or steel. Calibration is done using gravimetric sampling procedures. Also, for any soil texture other than what the device was calibrated to by the manufacturer, or with widely varying bulk density, the device must be recalibrated. This is a time-consuming process in layered soils on alluvial sites where the texture and bulk density vary widely. Recalibration is generally not necessary in medium textured, medium bulk density, uniform soils.

Table 9-4 Interpretations of readings on typical electrical resistance meter

Soil water condition	Meter readings ^{1/} (0 – 200 scale)	Interpretation
Nearly saturated	180 – 200	Near saturated soil often occurs for a few hours following an irrigation. Danger of water logged soils, a high water table, or poor soil aeration if readings persists for several days.
Field capacity	170 – 180	Excess water has mostly drained out. No need to irrigate. Any irrigation would move nutrients below irrigation depth (root zone).
Irrigation range	80 – 120	Usual range for starting irrigations. Soil aeration is assured in this range. Starting irrigations in this range generally ensures maintaining readily available soil water at all times.
Dry	< 80	This is the stress range; however, crop may not be necessarily damaged or yield reduced. Some soil water is available for plant use, but is getting dangerously low.

^{1/} Indicative of soil-water condition where the block is located. Judgment should be used to correlate these readings to general crop conditions throughout the field. It should be noted, the more sites measured, the more area represented by the measurements.

The total volumetric soil-water content reading (count) of the neutron gauge should be translated into available soil-water content (AWC). Field capacity and wilting point levels must be known. It is more convenient if field measurements could be taken near those soil-water content levels. The neutron gauge method is highly accurate (1 to 2 percent of actual) if properly operated and adequately calibrated except:

- in the upper 6 inches of soil profile where fast neutrons tend to escape above the soil surface;
- in high clay content soil that contain tightly bound hydrogen ions that are not reflected in the detecting process;
- in soil with high organic matter content; and
- in soil containing boron ions.

These soil conditions all require recalibration of the gauge. Chapter 15 contains example worksheets, typical calibration curves, and sample displays for soil-water content by depth relationships.

Because a neutron gauge contains a radiation source and is a potential safety hazard to a technician using a gauge, special licensing, operator training, handling, shipping, and storage are required. The wearing of a radioactive detecting film badge is required by all technicians when handling and using a neutron gauge. The use of a neutron gauge is not to be taken lightly. NRCS operates under a site license held by the USDA Agricultural Research Service. Inspections of storage facilities are made periodically. Disposal of old neutron probes (radioactive source) is strictly controlled by U.S. Nuclear Regulatory Commission (NRC).

A neutron probe is recommended for large farms or farm groups where use efficiency and accuracy can justify high initial cost, maintenance, and operating under NRC requirements.

Tools needed are:

- Approved storage facility for the probe at the workshop and in the vehicle
- Small diameter soil auger
- Soil bulk density sampler
- Watertight access tubes that fit snugly against the soil
- Gravimetric soil sampling equipment (core sampler, auger, sample bags, weighing scales, drying oven) for calibration
- Neutron gauge

- Small square of canvas
- Tool box containing a variety of tools
- Film badges for everyone involved

(vii) Dielectric constant method—The dielectric constant of material is a measure of the capacity of a nonconducting material to transmit high frequency electromagnetic waves or pulses. The dielectric constant of a dry soil is between 2 and 5. The dielectric constant of water is 80 at frequency range of 30 MHz – 1 GHz. Relatively small changes in the quantity of free water in the soil have large effects on the electromagnetic properties of the soil-water media. Two approaches developed for measuring the dielectric constant of the soil-water media (water content by volume) are time domain reflectometry (TDR) and frequency domain reflectometry (FDR).

For TDR technology used in measuring soil-water content, the device propagates a high frequency transverse electromagnetic wave along a cable attached to parallel conducting probes inserted into the soil. A TDR soil measurement system measures the average volumetric soil-water percentage along the length of a wave guide. Wave guides (parallel pair) must be carefully installed in the soil with complete soil contact along their entire length, and the guides must remain parallel. Minimum soil disturbance is required when inserting probes. This is difficult when using the device as a portable device. The device must be properly installed and calibrated. Differing soil texture, bulk density, and salinity do not appear to affect the dielectric constant.

FDR approaches to measurement of soil-water content are also known as radio frequency (RF) capacitance technique. This technique actually measures soil capacitance. A pair of electrodes is inserted into the soil. The soil acts as the dielectric completing a capacitance circuit, which is part of a feedback loop of a high frequency transistor oscillator. The soil capacitance is related to the dielectric constant by the geometry of the electric field established around the electrodes. Changes in soil-water content cause a shift in frequency. University and ARS comparison tests have indicated that, as soil salinity increases, sensor moisture values were positively skewed, which suggests readings were wetter than actual condition.

FDR devices commercially available include:

Portable hand-push probes—These probes allow rapid, easy, but only qualitative readings of soil-water content. Probe use is difficult in drier soil of any texture, soils with coarse fragments, or soils with hardpans. A pilot hole may need to be made using an auger. The probe provides an analog, color-coded dial gauge (for three soil types—sand, loam, and clay), or a digital readout. The volume of soil measured is relatively small (a cylinder 4 inches tall by 1 inch in diameter). Several sites in a field should be measured, and can be, because probes are rapid and easy to use. Proper soil/probe tip contact is essential for accurate and consistent readings.

Portable device that uses an access tube similar to a neutron gauge—The probe suspended on a cable is centered in an access tube at predetermined depths where the natural resonant frequency or frequency shift between the emitted and received frequency is measured by the probe. The standard access tube is 2-inch diameter schedule 40 PVC pipe. Installation of the access tube requires extreme care to ensure a snug fit between the tube and the surrounding soil. Air gaps or soil cracks between the tube and soil induce error.

The device is calibrated by the manufacturer to sand and to an average bulk density for sand. Recalibration is required for any other soil texture and differing bulk density. The volume of soil measured is not texture or water content dependent, and approximates a cylinder 4 inches tall and 10 inches in diameter. Accuracy can be good in some soils with proper installation and calibration, and there are no radioactive hazards to personnel such as when using a neutron gauge. Proper installation of the access tube is essential and can be quite time consuming. Accuracy of data is largely dependent on having a tight, complete contact between the access tube and the surrounding soil. Before making a large investment in equipment, it is highly recommended that adequate research be done on comparison evaluations that are in process by various universities and the ARS. Good sources of information are technical papers and proceedings of ASAE, ASCE, and Soil Science Society of America, as well as direct discussion with personnel doing evaluations.

Other electronic sensors—Numerous sensors are commercially available using microelectronics. Inexpensive devices sold at flower and garden shops measure the electrical voltage generated when two dissimilar metals incorporated into the tip are placed in an electrolyte solution; i.e., the soil water. Most of these devices are sensitive to salt content in the soil-water solution.

Factors to be evaluated for the selection and application of a soil-water content measuring program include:

- Initial cost of device, appurtenances, special tools, and training
- Irrigation decisionmaker's skill, personal interest, and labor availability
- Field site setup, ease of use and technical skill requirements
- Repeatable readings and calibration requirement
- Interpretations of readings—qualitative and quantitative needs
- Accuracy desired and accuracy of device
- Operation and maintenance costs
- Special considerations including licensing from NRC (private individuals do not operate under ARS licensing), storage, handling, film badge use, training required, disposal of radioactive devices, and special tools required for access tube installation

(c) Crops

Crop characteristics are important for the irrigation planner and decisionmaker to know. Those characteristics necessary for implementing a proper irrigation water management program include purpose of crop, crop evapotranspiration, critical growth periods, and root development.

(1) Crop evapotranspiration

Crop evapotranspiration (ET_c) is the amount of water used by the crop in transpiration building of plant tissue and evaporated from the soil or plant foliage surface. It is determined by using local climatic factors and stage of growth. Several equations can be used depending on climate data availability and degree of intensity of IWM program. ET_c provides one of the key ingredients in scheduling irrigations; i.e., how much water the crop uses or is projected to use.

(2) Critical growth periods

Plants generally need sufficient moisture throughout the growing season. Most crops are sensitive to water stress during one or more critical growth periods during their growing season. If adequate moisture is not available during the critical period(s), irreversible loss of yield or product quality results. With many fruit and fresh vegetable crops, lack of available water at critical growth periods can result in a product that may be partly or totally unmarketable on the fresh market because of poor quality. See Chapter 3, Crops, for critical growth stages, and chapter 15 for IWM tools.

(3) Root development

Roots develop as plants grow and mature. Major factors controlling root development are stage of plant growth, usable soil depth, soil compaction, soil condition, and amount of water in the soil. Irrigation should be planned to provide water only to the usable plant root zone unless leaching for salinity control is necessary.

Never assume a plant root zone depth. Observe and measure the actual depth roots penetrate a soil profile by digging a shallow pit and auguring. Notice the pattern of root development in the side of the pit. Check for roots in handfuls of augured soil. Generally 2 to 4 feet of total depth is adequate. If root development pattern depth is overestimated, an overirrigation recommendation is guaranteed. Plants will show unneeded stress between irrigations.

(4) Yield (quality) versus water use relationships

Most crops respond to water availability and use to provide a given biomass or yield. Limited data are available for predicting specific yield versus water use relationships except for a few crops. With most crops, yield and product quality are reduced where excess water is applied. Too much water can also be detrimental to crop yield by leaching of otherwise available plant nutrients below the root zone. Water is also wasted. Tables or curves for several crops are in Chapter 3, Crops.

The following methods and devices are commercially available to measure plant moisture tension levels. They can provide indications of plant moisture stress.

(i) Crop Water Stress Index (CWSI)—The crop water stress gun measures plant canopy (foliage), temperature, ambient air temperature, relative humidity, and a range of solar radiation. The CWSI gun is commonly mistakenly called infrared gun or IR thermometer. In the CWSI gun a microprocessor calculates plant water stress and expresses it as an index from 0 to 1.0 or 0 to 10, depending upon the manufacturer. (The latter avoids using a decimal. Overall range is the same.) Threshold stress levels are developed for each crop for determining when to irrigate. Once developed, the stress index for a specific crop appears to be usable in all climate zones and for similar crop species. When first used in an area, it is best to affirm calibration based upon local conditions. When the canopy temperature in relation with other climate factors increases to a predetermined upper target level, the plants are considered stressed. A well watered plant has relative cool foliage because of the continual plant transpiration and has an index near zero. When plant canopy temperature reaches ambient temperature, the plant is not transpiring moisture and is probably beyond permanent wilting point. When following good water management practices, the irrigator can provide irrigations before upper target threshold stress levels are reached.

Periodic soil-water content checks should be made to relate plant water stress indexes and soil-water content levels. Observe and measure the depth of plant roots. Adequate soil moisture may be present below the plant root zone. CWSI readings can be observed over several days to predict the need for irrigation 3 to 5 days in advance.

This device is relatively easy to use and can provide rapid results at varied locations in a field. Proper techniques for use are important. Readings can be taken when the sky is clear or overcast, but not clouded over. The best time is midmorning to early afternoon, and the foliage must be dry. Readings must be taken only of foliage, not bare soil, landscape, sky, or other factors. Average several readings to improve accuracy. The gun is held at least 1 meter above the crop canopy, but not more than 10 meters. Direct the device more or less down onto the crop canopy. This creates a challenge with tall crops (corn, cotton, fruit, citrus, nuts). Caution must be exercised because apparent high stress levels may be from factors other than moisture, such as insects and disease. The user

should be able to observe field conditions and correctly interpret readings. Several models are commercially available. Different crops have different target stress levels.

Technology exists to provide CWSI readings from aircraft and satellite. Current limitations include getting information into the hands of the irrigation decisionmaker for timely irrigation water management decisions. Other uses of the CWSI gun include identification of plant stress before visual observation signs appear. Observing irrigation uniformity across the field and damage from crop insects, fungus (including root rot), and rodents are a few other uses.

(ii) Leaf moisture stress (pressure chamber)—This method involves encasing a part of the plant, such as a leaf, inside a pressure chamber, and checking the amount of pressure required to force the fluid stored in the sample back out the stem. Nitrogen gas is typically used. The pressure required to reverse the flow of plant moisture is interpreted to indicate plant moisture tension (stress). Target tension (stress) points must be developed for specific plants, after which it can be used as a reference for subsequent tests. Success of this method depends on standardization of the test protocol. It is desirable to take readings at predawn. Predawn plant water tension is controlled by soil-water tension, and daytime plant moisture tension is controlled by climate. Plant moisture stress can be several times higher during the heat of the day than at predawn and not be consistent at any specific time of day for each day. Sun angle, cloud cover, temperature, humidity, and wind all affect plant moisture tension levels during daylight hours.

(iii) Evaporimeter (atmometer)—An evaporimeter consists of a flat, porous ceramic disk (Bellani plate) in which water is drawn up by capillary action as water is evaporated from the disk. It is used to directly estimate crop evapotranspiration rate. Several commercial models can be easily installed near the edge of a field or on a roadway in a field. (The unit must be located far enough into the field to avoid field boundary effects.) One commercial model provides a green canvas-like material covering the ceramic disc to simulate crop leaf color. Reasonably good correlation has been found between field measurements and that calculated from Penman-type equations. Small difference in evaporation rates may be found between individual meters. Maintaining water levels and removal for freeze protection are necessary.

(iv) Evaporation pans—U.S. Weather Bureau Class A evaporation pans are standard sized, opentop metal water containers. Water is evaporated from a saturated source (water body) with solar energy. Coefficients must be applied to the evaporation rate representing pan coefficients and crop growth stage coefficients. Nonstandard pans have been tried with varying degrees of success. Materials range from galvanized metal wash tubs to PVC pipe (placed vertically). The devices are generally calibrated to a local Class A evaporation pan, and can be reasonably effective in determining when to irrigate. Coefficients are applied to the pan evaporation rate to represent crop evapotranspiration rate.

(v) Infrared photography—Aerial infrared photography can show current plant condition by the darkness of green vegetation. Red color intensity on photo prints displays dark green and lighter green patterns in the vegetation. Infrared photography is a valuable tool to visually observe local areas within an irrigation system or field(s) that receive either insufficient or excess irrigation water. Red color intensity differences can result from:

- Wrong sized or plugged nozzles or broken sprinkler heads giving poor distribution patterns
- Shallow or coarse textured soil areas (inclusions)
- Insect, fungus, or disease damage

Some skill is required to interpret color intensity on infrared photo prints. Plant canopy (foliage) temperature measured with a crop water stress gun may also be helpful.

(vi) Visual—Observation of plant condition is too often the only basis used for determining when a crop needs irrigated. By the time leaf color or degree of curl indicates the need of water, the plant generally is overstressed and yield and product quality are negatively affected. However, certain crops can be stressed at noncritical growth stages with little effect on yield. Some well-watered crops normally show visual signs of stress at or following solar noon on hot days. Overirrigation, especially early in the growing season, limits plant root development volume and depth, which limits the volume of soil containing water available for plant use. Often adequate soil water exists below existing plant root systems, but roots cannot grow rapidly enough to obtain adequate moisture to maintain plant evapotranspiration and growth.

Some irrigation decisionmakers randomly locate (or plant small areas in critical locations) a plant that shows moisture stress before the main crop. Corn is often used as a moisture stress indicator plant because it shows stress several days before many other crops. Many other indicator plants can be used. See Chapter 3, Crops.

(d) Upward water movement (upflux)

When a water table exists close to the root zone, crops extract water from the capillary fringe or water moving upward (upflux) into the crop root zone. The rate of upward flow depends primarily on the depth to the water table and soil texture. See Chapter 6, Irrigation System Design, for additional discussion.

652.0903 Irrigation scheduling

(a) General

Irrigation scheduling is that part of proper irrigation water management involving the decision, when to irrigate and how much water to apply. Scheduling tools provide information that irrigation decisionmakers can use to develop irrigation strategies for each field on the farm. Such strategies may be based on long-term data, representing average conditions, or may be developed as the season progresses, using real time information and short-time predictions. In both cases information about the crop, soil, climate, irrigation system, water deliveries, and management objectives must be considered to tailor irrigation scheduling procedures to a specific irrigation decisionmaker and field condition. An irrigation scheduling tool needs only be accurate enough to make the decision when and how much to irrigate.

The need for proper irrigation water management, including irrigation scheduling, can best be demonstrated by identifying physical effects. To be most effective, identify the physical effects the irrigation decisionmaker is most concerned about, then show how proper irrigation water management will affect the concerns. The concerns include:

- Energy cost per season (fuel or electricity)
- Irrigation labor (kind of labor, timing, and amount)
- Wear and tear on irrigation equipment
- Plant response (yield) compared to potential
- Quality of product or crop
- Amount of irrigation water used
- Soil condition
- Plant response to fertilizer used
- Water quality onsite or offsite

Modern scheduling is based on soil-water balance or crop-water balance for one or more points in the field. By measuring existing and estimating future soil-water content or monitoring crop-water stress level, irrigation water can be applied before damaging crop stress occurs. Scheduling irrigation involves forecasting of crop water use rates to anticipate future water needs.

Figure 9–7 displays a flowchart for an irrigation scheduling process that uses soil-water content monitoring as the crop-water use indicator. Other techniques used to monitor current crop condition, such as infrared photography and leaf and plant moisture stress level index typically do not include a continual monitoring of soil-water content. Periodic checking of soil moisture status is generally sufficient to validate or update scheduling model.

The producer's management objective must be considered when developing a scheduling program. Maximizing net return is a common objective; other objectives may be to minimize irrigation costs, maximize yield, use less water, minimize ground water and downstream surface water pollution, optimize production from a limited water supply, use less energy for pumping, or to improve product quality.

Several scheduling techniques and levels of sophistication can be applied to track the amount of soil water in the crop root zone and crop water use. In some locations crop water use information is made available via newspapers, telephone call-in, television, or by computer modem systems. All irrigation scheduling programs should account for rainfall measured at the field site. Because of the spatial variation in rainfall, amount recorded at the farmstead or in town often does not represent precipitation at the field site. With precipitation (usually rainfall) at the field site known, accuracy for scheduling irrigations is improved. The amount available to meet plant water needs is called *effective precipitation*.

In addition to soil water to plant relationships, other factors are important in selecting a method of scheduling irrigations and setting up the scheduling procedures. Labor skill, availability, and personal interest dictate what type and level of intensity for readings and calculations can be made to make the scheduling procedure work. Irrigation district policies and capabilities often dictate when and for how long an irrigator will get water; i.e., delivery schedule. Cultural operations, such as hay cutting, over-canopy pesticide application, or row crop cultivation, have a major impact on scheduling. Some farmers do not like to keep written records; however, most have accepted the fact that they must for other purposes. Many farmers have a personal computer system. Some prefer to hire management services to give them information needed.

All these factors must be taken into account when determining what irrigation scheduling procedure will be best suited to a water user. A good rule to follow, **keep it simple and easy to understand**, even when a computer system is used. Adaptation requires maintaining the risk perceived equal to or less than the current way irrigation water is being scheduled.

(b) Irrigation scheduling methods

Irrigations can be scheduled using methods varying from simple soil water monitoring using the feel and appearance method to sophisticated computer assisted programs that predict plant growth. Scheduling involves continual updating of field information and forecasting future irrigation dates and amounts.

Crop yield and quality can be improved with most plants by maintaining lower soil-water tensions (higher moisture levels). Thus, it is wise to irrigate when the soil profile can hold a full irrigation. Waiting until a predetermined percent of soil AWC is used can cause unnecessary stress.

(1) Soil and crop monitoring methods

Some scheduling practices are based solely on monitoring soil-water content or crop water use. Irrigations are needed when the soil-water content or crop water use reaches predetermined critical levels. Soil-water content and plant moisture tension measuring devices and procedures are described in section 652.0902(b). Using the monitoring data is briefly described in this section.

Accurate monitoring should provide the irrigation decisionmaker information at or soon after the time of measurement. The data must be available to ensure that the field can be irrigated before moisture stress occurs. Monitored data must be displayed so that the information is easy to understand and use to predict an irrigation date. When past data are projected forward, usually the future will resemble the past. Rapidly growing crops and weather changes must be considered. Local weather forecasts can provide a guide as to when to irrigate, but frequent field measurements are often necessary.

Figure 9-7 Example irrigation scheduling program flowchart using soil water content for validation

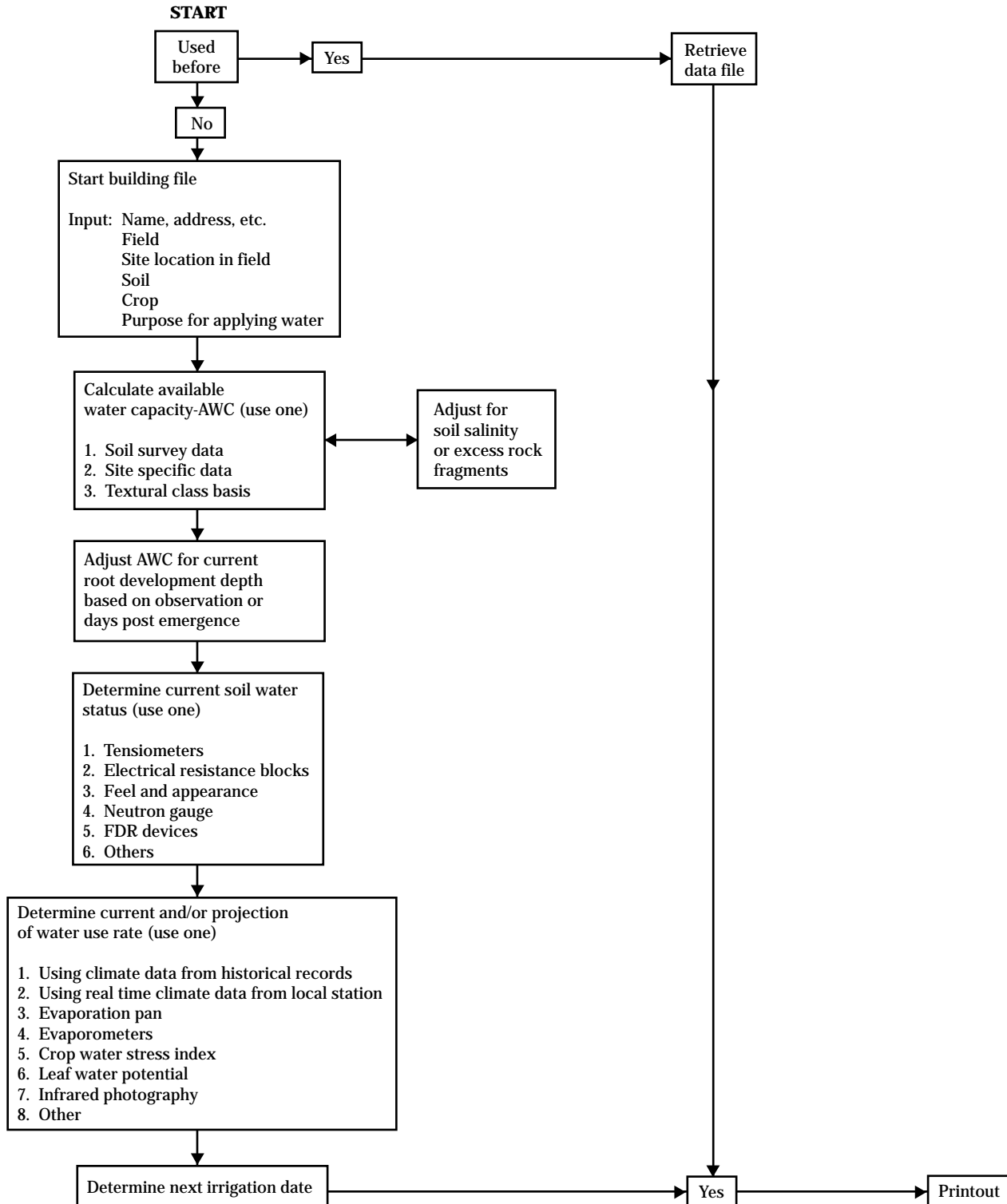

(i) Crop water use monitoring—Monitoring crop conditions can be used to estimate when to irrigate, but it does not provide any information on how much water to apply. Crop water use can be measured, but it is usually calculated or estimated. The Crop Water Stress Index (CWSI) method measures plant condition and compares that status to a known reference for a well watered plant condition. Infrared photography indicates presence or lack of surface moisture, either on soil surface or plant leaf surface. Some skill is necessary to interpret color intensity on infrared photographs. What appears to be plant moisture stress may result from other causes, such as insect damage, lack of key nutrients, or from other toxic materials on leaf surfaces. Number of sets, days, and rotation or cycle time to get across a field should be considered when using a field monitoring method.

Some level of soil and crop monitoring is essential for efficient irrigation water management. Growing high value crops can support a sophisticated monitoring and scheduling program whether it be for optimizing water use and crop yield, maintaining desirable crop quality, minimizing use of fertilizer, or educing runoff, deep percolation, or both. Monitoring can be accurate where irrigators are adequately trained and personally interested. The monitoring schedule should fit into the pattern of irrigation. Monitoring dates before and after an irrigation should be flexible and adjustable to provide better management information.

(ii) Soil moisture monitoring—Monitoring soil-water content before, during, and after the crop growing season is the primary tool to schedule irrigations or calibrate other less labor intensive irrigation scheduling tools.

Soil moisture monitoring is perhaps the most accurate irrigation scheduling tool. With experience the feel and appearance method can be used to accurately determine soil moisture available for crop use. If other methods are used to determine soil moisture, the feel and appearance method should also be used to check the other method and to *experience* the fingers in determining soil moisture. At first three to five samples are examined at four or five sample sites in a field. Again with experience and a specific crop and soil, one soil sample at a depth of 12 to 18 inches can be sufficient per sample site. At this depth soil samples can be removed with a soil probe or small auger, typically under the growing plant. Displaying moisture

content at various depths may be desirable at each monitoring site. Too little or too much soil moisture in the profile becomes more apparent when displayed graphically.

Soil moisture monitoring is used to calibrate or affirm other irrigation scheduling methods that predict plant water use by measuring plant stress (crop water stress index, plant tissue monitoring) or calculate plant water use based upon climatic data. Examples are NRCS (SCS) SCHEDULER computer software or checkbook method. With these other methods, checking actual soil moisture is like receiving your bank statement from the bank. It affirms or cautions you when an error may exist or other adjustments are needed. See Section 652.0902(b), Measuring soil-water content.

Many computer scheduling programs use soil moisture measurements for updating methods based on computing the soil-water balance. Figure 9-8 provides a schematic of a basic soil-water content monitoring display to schedule irrigations. The same principal can be used regardless of units provided by a soil-water content or plant moisture tension level measuring device. Displaying may be desirable the various depths, if applicable, at each monitoring site.

Figure 9-8 Soil-water measurements used to predict day to irrigate

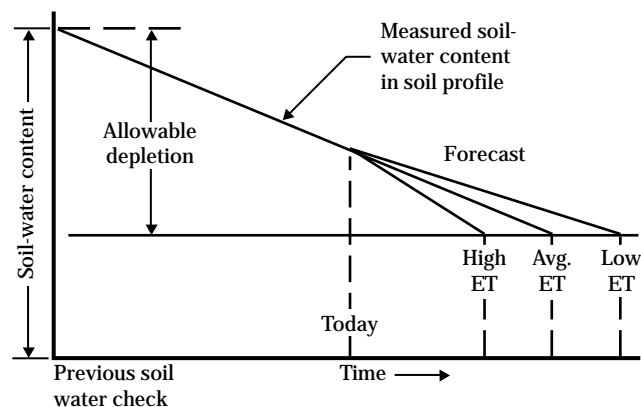

(2) Checkbook method

The checkbook irrigation scheduling method is similar in principle to using a checkbook to transfer money into or out of a home checking account. In this case, instead of a bank holding the money, the soil profile holds water available for plant growth in the root zone. If the amount of available water (bank balance) in the root zone at the end of day one is known and if the water losses (withdrawals) and gains (deposits) that occurred on day two are known or can be estimated, then the amount of soil water in the root zone at the end of day two can be calculated.

Deposits of water to the plant root zone are effective precipitation, irrigation, or water table contribution. Withdrawal of water from the root zone is primarily crop evapotranspiration (ET_c) and soil evaporation. Manual, adding machine, hand calculator, or computer bookkeeping methods can be used. Checkbook crop use data can be forecasted crop ET, pan evaporation, or other data. Because of spatial variability, rainfall amounts should be measured at the field. Net irrigation or precipitation application amounts can be reasonably estimated. Soil-water content measurements should be made to calibrate calculations and other measurements.

Deep percolation cannot be directly measured in a field situation, but is accounted for in field application efficiency, which also includes improper irrigation timing (too much water too late). Irrigation depths applied under sprinkler systems can be measured by using catch cans (rain gauges) to determine application amounts, flow measuring devices to measure irrigation flows to laterals or from sprinkler heads, and estimates of evaporation losses. A water balance method, such as the checkbook method, is used by the irrigator to track crop water use and soil-water deficit.

Crop evapotranspiration reporting services are sometimes available. This community wide, private, or public service calculates daily crop evapotranspiration for selected crops and provides this information to irrigators through radio, newspaper, television, or by a special telephone service. The TV Weather Channel displays maps showing ET of well-watered grass for the preceding week.

The Water Balance Irrigation Scheduling Worksheet (fig. 9-9) may be used with the checkbook method.

(3) Computer assisted methods

Computerized irrigation scheduling allows the storage and transfer of data, easy access to data, and calculations using the most advanced and complex methods for predicting crop ET. Many computer software programs are available to assist in scheduling irrigations. Most programs access data bases for soil characteristics, crop growth characteristics, climate, water supply, irrigation system, and economic data. The ability to directly access and process climate data from a regional network of local stations or an onsite weather station has greatly streamlined data entry and analysis for computerized scheduling. Scheduling programs are no better than the data used or the ability of the irrigator to interpret output data.

(i) Daily crop evapotranspiration— ET_c is computed to the day of real-time climate data availability, then the method predicts crop ET for up to 10 days in the future. The data can be used by the irrigator to keep a water balance worksheet (fig. 9-9) for each field. This type program generally is used by a local agency or district, consultant, water company, or water district to provide information to local irrigators. Crop ET data are often available to the irrigation decisionmaker in local newspapers, telephone dial-up service, or television. Irrigation decisionmakers for large farms or farms growing high value crops often use onfarm weather station(s) and the farm computer to calculate daily plant water use. However, almost any size farm can support the use of a computer. The computer facilitates the management of all natural resource data as well as record keeping on the farm. The method is similar to the checkbook method.

(ii) Local real-time climate data—Climate data are retrieved by computer phone modem, soils data and crop growth characteristics are accessed, current crop ET is computed, monitored soil-water content is input if available, and a complete crop-soil water balance set of records is developed by computer software for each field being scheduled. Actual onsite, field by field, irrigation system performance is used as basis to determine net irrigation application values. This type program is used directly by the irrigator (or farm consultant) using their own computer and telephone modem.

Figure 9-9 Typical water balance irrigation scheduling worksheet

U.S. Department of Agriculture
Natural Resources Conservation Service

**Typical Water Balance Irrigation
Scheduling Worksheet**

Grower _____ Field ID _____ Crop _____
 Planting date _____ Full cover date _____ Harvest date _____
 Soil water holding capacity (in/ft) _____; _____; _____; _____ Rooting depth _____
 Management allowable depletion _____ Minimum soil-water content _____

Date	Daily crop ET (in)	Forecast crop ET (in)	Cum total ET (in)	Rainfall (in)	Irrigation applied (in)	Cumulative total irrigation (in)	Allowable depletion balance (in)	Soil- water content (in)	Predicted irrigation date

A good irrigation scheduling program can be updated on a regular basis with soil-water content data to improve efficiency and accuracy of determining when to irrigate and how much water to apply. Following periods of excess rainfall when soils are probably at or near field capacity is an easy calibration point. Calculated available soil water should be near field capacity. When crop ET and water costs versus crop yield data are known, a true current economic evaluation can be presented to the irrigation decisionmaker. Improved predictions from computerized irrigation scheduling allow the irrigation decisionmaker to lengthen the period between field monitoring and reduce the uncertainty of the soil-water balance. Adequate and timely water can be provided to the crop and deep percolation losses minimized when following a good irrigation scheduling program.

Some currently available computer programs are briefly described in the following paragraphs. Documentation required to run the program must be available and easy to understand.

NRCS (SCS) Scheduler (DOS Version 3.0 as of 6/96)—This irrigation scheduling program was developed for NRCS by Michigan State University. It is usable nationwide and is applicable in most climates. Using onfarm characteristics and local real time climate data, a simple accounting process is employed to:

- Determine daily and monthly evapotranspiration of the crop.
- Determine seasonal irrigation requirement.
- Account for change in soil-water content since it was last measured.
- Predict rate at which soil water will decrease over the next 10 days.

This program works with any soil and may be applied to any number of crops as crop-specific growth data become available. Currently the program includes 42 crop curves. Climatic data and crop information necessary for local irrigation scheduling should be developed or adapted from local information. Accounting for onsite rainfall is essential. Climate data may be entered manually or transferred directly from a local real-time climatic data collection station via phone modem. To update the soil-water balance, soil-water content monitoring data can be input at anytime. Figures 9–10 and 9–11 display seasonal crop ET curves and soil-water content status using NRCS (SCS) SCHEDULER computer program.

US Bureau of Reclamation Scheduling program (Agrimet)—Bureau of Reclamation has adopted and modified a computer scheduling program developed at USDA Agriculture Research Station at Kimberly, Idaho. Agrimet is the Northwest Cooperative Agricultural Weather Network. It is cooperatively sponsored by land grant universities, Cooperative Extension Service, NRCS, local soil and water conservation districts, ARS, local irrigation districts, and other state and local water resource agencies and organizations.

Sensors collect real time climate data (air temperature, relative humidity, solar radiation, precipitation, and wind run speed and direction). A data collection platform (DCP) interrogates the sensors at programmed intervals, every 15 minutes or hourly, depending on the parameter. The DCP transmits the data every 4 hours via the GOES satellite to a central receive site in Boise, Idaho. The recorded parameters are used to calculate a daily reference ET based on the 1982 Kimberly-Penman equation. Crop water use models are run daily to translate the local climatic data into daily ET information for crops at each weather station. Anyone with a computer, a modem, and an Agrimet user name can access Agrimet for weather data or site-specific daily crop water use information from throughout the Pacific Northwest Region. Other onfarm factors to be considered when using the published crop ET data include water used for environmental control, salinity control, and irrigation system application efficiency and uniformity.

ARS personnel at Ft. Collins, Colorado, developed a computer assisted irrigation scheduling program. Program software uses minimum to optimum field data to predict when to irrigate. Default values replace measured data where necessary. In general, the better the field data input, the more precise the data output.

University scheduling programs—Several computer scheduling programs are available and supported by many local universities. Typically, these programs apply statewide or to more localized areas within a state. The State Supplement section at the end of this chapter gives additional information on programs available from local universities.

Figure 9-10 NRCS (SCS) SCHEDULER—seasonal crop ET

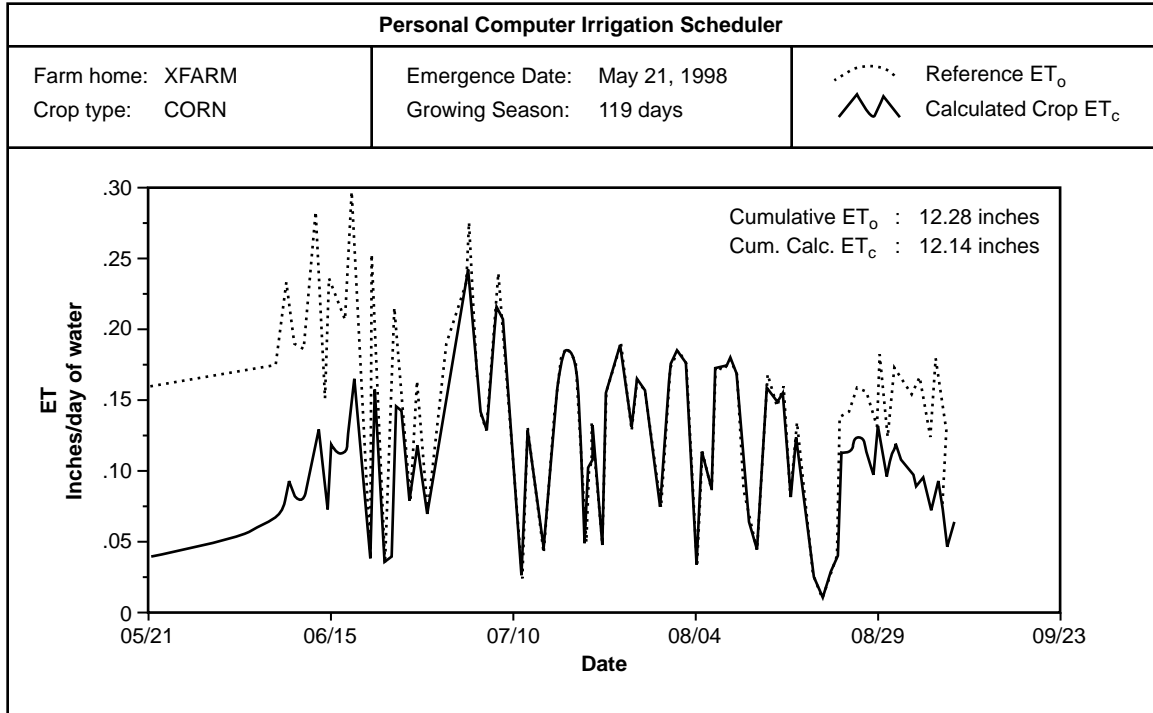
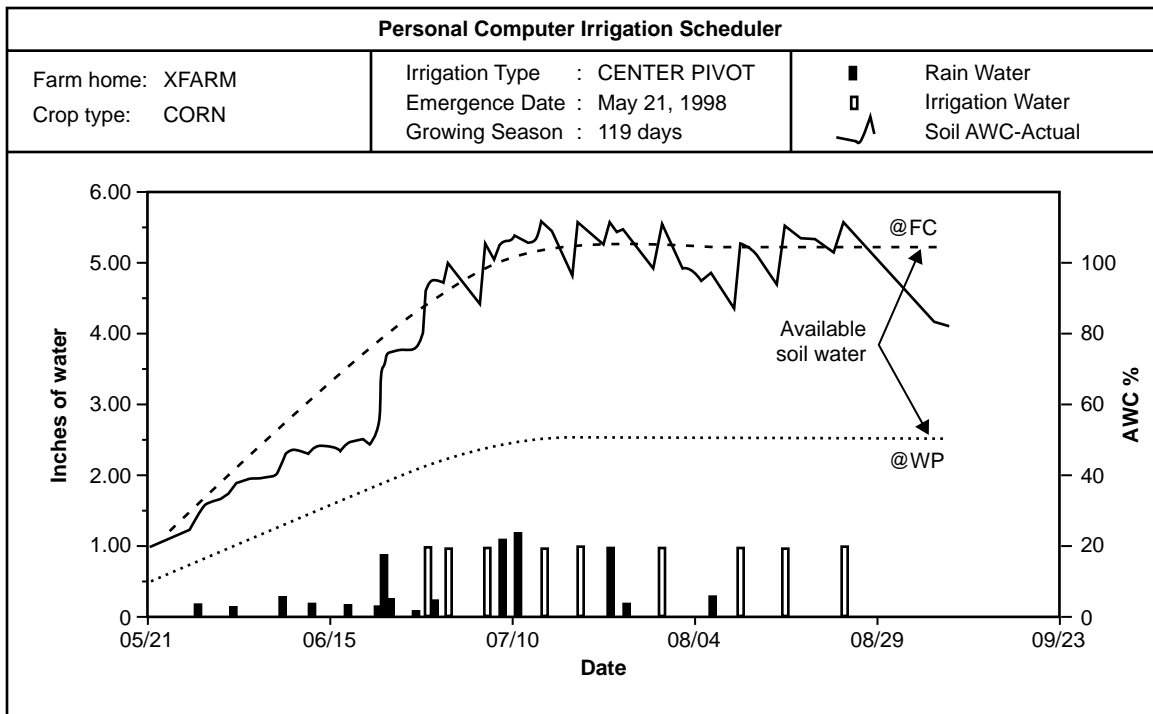

Figure 9-11 NRCS (SCS) SCHEDULER—seasonal soil moisture status



(4) Consultative irrigation scheduling services

Consultants are available who will (for a fee) provide irrigation scheduling services throughout the irrigation season. These consultants often offer other agricultural services including fertilizer and pest management programs.

The advantages of this type scheduling are:

- The consultant is generally well trained and professional.
- The latest techniques are typically used, including state-of-art soil-water content measuring devices and computers.
- Fine tuned management can be maintained.
- Water management integrated with fertilizer, pest, and other management programs can result in optimum plant growing conditions.
- The farm manager who is willing to pay for such services is probably going to follow the recommendations faithfully.
- The saving or proper timing of one irrigation often pays for the service for the entire growing season.

(5) Commercial service

Associated with crop growing contracts, many commercial companies provide field assistance to the irrigator to assure that expected crop yield and crop quality are obtained. Assistance from a field specialist, involving irrigation and fertilizer recommendations and insect control, is typically provided as part of the crop contract arrangement.

652.0904 Irrigation system evaluation procedures

(a) General

The effectiveness of irrigators' irrigation water management practices can be determined by making field observations and evaluations. The results of these observations and evaluations are used to help them improve water management techniques, upgrade their irrigation system(s), or both. Improvements to operations and management can conserve water; reduce labor, energy, and nutrient losses; generally improve crop yields, biomass, and product quality; and reduce existing or potential water pollution. The following principles apply to all irrigation methods and systems.

- Irrigation should be completed in a timely manner to maintain a favorable soil-water content for desired crop growth. An exception may be made where the water supply is limited. In this situation, water should be applied in a manner that maximizes water use benefits.
- The amount of water applied should be sufficient to bring the crop root zone to field capacity minus allowable storage for potential rainfall events.
- Water should be applied at a rate that will not cause waste, erosion, or contamination of ground water and downstream surface water.
- Improving management of the existing system is always the first increment of change for improved water management. Each irrigation evaluation should consider a change in water management decisions only, and then a change in water management decisions and irrigation system performance.

Evaluation is the analysis of any irrigation system and management based on measurements taken in the field under conditions and practices normally used. An examination of irrigation water management practices should attempt to answer the following questions:

- Is the water supply sufficient (quantity and quality) and is it reliable enough to meet the producers objective?
- Are irrigations being applied in a timely manner?

- How is the need for irrigation determined? What is the planned soil-water deficit (SWD)? Is it dry enough to irrigate, too dry, or wet enough to stop irrigating?
- How much water is being applied by each irrigation? How is this amount determined?
- Is irrigation causing erosion or sediment deposition in parts of the field? Off the field?
- How uniform is water being applied over the irrigated area?
- How much water is being infiltrated into the area being irrigated?
- Is there excessive deep percolation or runoff in parts of the field?
- How much deep percolation or runoff? Are amounts reasonable?
- Does water applied for salinity management meet salt level balance needs throughout the soil profile? meet quality of water being used? for the crop being grown? during the desirable crop growth period? over the field?
- Does water applied for climate control meet uniformity and rate objectives?
- Are pesticides or fertilizers being applied through the irrigation system? (May require a high level of management, more or less water per application, and such additional safety devices as back flow prevention devices.)
- Is there a real or potential pollution problem being caused by irrigation?
- What is the overall irrigation application efficiency (mostly affected by management decisions) and irrigation system distribution uniformity of application (highly dependent on system flow rates and configuration)?
- On a sprinkle (or micro) irrigated field, is there translocation of water from the point of application to adjacent areas? How does this affect uniformity of application?

(b) Irrigation efficiency definitions

Irrigation efficiencies are a measure of how well an irrigation system works as well as the level of management of the system. The definitions that follow are similar to standard definitions developed by ASAE and ASCE, and are used in NRCS.

(1) Conveyance efficiency

Conveyance efficiency (E_c) is the ratio of water delivered to the total water diverted or pumped into an open channel or pipeline at the upstream end, expressed as a percentage. It includes seepage losses, evaporation, and leakage inherent in the specific conveyance facility. With appropriate identification it could also include operational spills.

(2) Irrigation efficiency

Irrigation efficiency (E_i) is the ratio of the average depth of irrigation water beneficially used to the average depth applied, expressed as a percentage.

(3) Application efficiency

Application efficiency (E_a) is the ratio of the average depth of irrigation water infiltrated and stored in the plant root zone to the average depth of irrigation water applied, expressed as a percentage. Average depth stored in root zone (or intercepted by plants) cannot exceed soil-water deficit (SWD), but may be equal. If the entire root zone will be filled to field capacity during an irrigation, then average depth infiltrated and stored in the root zone is SWD.

(4) Application efficiency low quarter

Application efficiency low quarter (AELQ or E_q) is the ratio of the average of the lowest one-fourth of measurements of irrigation water infiltrated and stored in the plant root zone to the average depth of irrigation applied; it is expressed as a percentage.

(5) Application efficiency low half

Application efficiency low half (AELH or E_h) is the ratio of the average of the low one-half of measurements of irrigation water infiltrated and stored in the plant root zone to the average depth of irrigation water applied; it is expressed as a percentage.

(6) Project application efficiency

Project application efficiency (E_p) is the ratio of the average depth of irrigation water infiltrated and stored in the plant root zone to the average depth of irrigation water diverted or pumped; it is expressed as a percentage. Project application efficiency includes the combined efficiencies from conveyance and application. It can be the overall efficiency of only onfarm facilities, or for community projects, it may include both on and off-farm efficiencies.

(7) Potential or design application efficiencies

Potential or design application efficiencies are usually those recommended in the irrigation guide and in various tables and charts in NEH, Part 623 (Section 15), Irrigation. These efficiencies are typically used for designing irrigation systems. The efficiency recommendations usually assume good management and maintenance of a well designed and installed system. If it is anticipated that a specific irrigator will not meet these criteria, then a lower potential application efficiency should be used than those recommended in references. Judgment by the designer is required. Overestimating the operator's level of management can result in an inadequate irrigation system design.

(8) Uniformity of application

How uniform an irrigation system applies water across the field is important. Within a range of physical conditions and management, any irrigation method can apply water in such a manner that over 90 percent of applied water is used by the plant. However, the range of physical conditions (topography, soils, water supply) in which this level of uniformity and management can be accomplished, can be narrow. Selection of a different irrigation method and system may provide a wider, more reasonable range of conditions; thus fewer management limitations.

(9) Distribution uniformity

Distribution uniformity (DU) is a measure of the uniformity of infiltrated irrigation water distribution over a field. DU is defined as the ratio of the lowest one-fourth of measurements of irrigation water infiltrated to the average depth of irrigation water infiltrated, expressed as a percentage. For low value crops, maintenance of vegetation, or areas of partial season irrigation, DU of low one-half may be more economical than using low one-quarter.

Sprinkler systems:

$$DU = \frac{\text{Average low - quarter depth received}}{\text{Average catch can depth received}} \times 100$$

Surface systems:

$$DU = \frac{\text{Average low - quarter depth infiltrated}}{\text{Average depth infiltrated}} \times 100$$

The average low-quarter depth of water received is the average of the lowest one-quarter of the measured values where each value represents an equal area. For calculation of DU of low one-half, substitute average low half depth received or infiltrated in place of low quarter.

(10) Christiansen's uniformity

Christiansen's uniformity (CU) is another parameter that has been used to evaluate uniformity for sprinkle and micro irrigation systems. DU should be used instead of CU. Thus, sprinkler and micro irrigation application uniformity can be directly compared to other irrigation methods and systems. Christiansen's uniformity is expressed as:

$$CU = 100 \left(1.0 - \frac{\sum X}{m n} \right)$$

where:

- X = absolute deviation of the individual observations from the mean (in)
- m = mean depth of observations (in)
- n = number of observations

CU can be approximated by:

$$CU = \frac{\text{Average low - quarter of water received}}{m} \times 100$$

and the relationship between DU and CU can be approximated by:

$$\begin{aligned} CU &= 100 - 0.63 (100 - DU) \\ DU &= 100 - 1.59 (100 - CU) \end{aligned}$$

Some parameters that affect uniformity tend to average out during a series of irrigation applications. Other aspects of nonuniformity tend to concentrate in the same areas, either over or under irrigation during each application. See discussion in NEH, Part 623, Chapter 11, Sprinkle Irrigation, Sprinkle Irrigation Efficiency.

(c) Irrigation system evaluations

(1) First step

Many important factors concerning how well an irrigation system is operating and how well it is being managed can be determined with a few simple observations and evaluation procedures. These procedures are used for a simple, abbreviated, or detailed evaluation and are the first step in any system evaluation.

For any irrigation method or system, equipment needed to check soil moisture and compacted layers is a soil auger, push tube sampler, or soil probe. If the soil is rocky, a shovel (sharp shooter) is also needed

A pressure gauge with pitot tube attachment, drill bits to check nozzle wear, short piece of hose, and calibrated container to check nozzle discharge are needed for sprinkler irrigation systems. For micro irrigation systems, special fittings for pressure gauge and catch containers to check the head and emitter discharge are needed. Surface irrigation systems require measuring devices to check furrow and border inflow and outflow. Flow measuring devices are needed for sub-irrigation systems.

(2) Evaluation procedures

Step 1—Determine basic data about the irrigation system and management from the irrigation decisionmaker. Some questions that might be asked include:

- How does the irrigation decisionmaker determine when to irrigate and how much water to apply?
 - How is length of time for each irrigation set determined?
 - For sprinkler and micro irrigation systems, what are the operating pressures at several locations along a selected lateral?
 - How is the time to shut water off determined?
 - How long does it take for water to reach the end of borders or furrows?
 - What is the irrigation water supply flow rate in early season? mid season? late season?
 - How is flow rate determined?
 - What is the rate of flow onto each border or into a furrow? into the system?
 - What problems (or concerns) have the irrigator experienced with the system?
- Are there dry spots in the field? wet spots? Are large areas of the field under irrigated? overirrigated?
 - Crop production:
 - What is the average production of each field irrigated?
 - Does it meet or exceed county or area averages?
 - Does production vary across the field? If so, what does the irrigation decisionmaker feel are the causes (irrigation system, field surface nonuniformity, water supply amount and location of source or delivery, soil, fertilizer, chemigation, pests)?
 - How much control does the irrigator have over when and how much irrigation water is available? delivery schedule?
 - What are farm manager's objectives?
 - What is the skill level, timing, and amount of labor available?
 - Can water be changed at night? during the middle of the day? at odd hours? If short set times are necessary, is a semiautomatic or complete automatic control system available?

Step 2—Observe the field in question. Look at other fields. Look at the supply system. Look for and ask:

- Are there erosion or sediment deposition areas?
- Are there indications of excessive runoff from part or all of the field?
- Are there problems (benefits) created by excessive irrigation tailwater or field runoff?
- Do leaky ditches and pipelines appear to have excessive water loss (seeps or leaks)? (1gpm=1 acre inch every 20 days)
- Are crops uneven or discolored? Do they show obvious stress?
- Are there water loving plants and weeds present? If so, is there an obvious wildlife benefit?
- Are there saline or swampy areas?
- Are there obvious signs of poorly maintained micro and sprinkler hardware, including leaky gaskets, weak or broken springs, plugged emitters, or worn nozzles?
- Are there poorly maintained diversion or turnout gates, leaks, uneven flows from siphon tubes or gated pipe gates, uneven irrigation heads, weeds, and trash?
- Are there measuring devices? Are they in satisfactory operating condition? Are they used to make onfield water management decisions?

Step 3—With the irrigation decisionmaker, auger or probe several holes at selected locations in the field. This is the best time to start talking to the farm manager or irrigation decisionmaker about proper irrigation water management. The feel and appearance method of moisture determination can also be demonstrated. Look for such information as:

- Is there evidence of an excessive high water table or indications of a fluctuating water table?
- Locate hard pans, compacted layers, mineral layers, or other characteristics that can restrict root growth and the movement of water in the soil. What is the apparent cause(s) of each restriction?
- Does soil texture change at various levels in the soil profile?
- Observe water content of each soil layer. Demonstrate the feel and appearance method of moisture determination to the irrigation decisionmaker. Is the location of wetted soil shallow (typically under irrigated) or deep (typically overirrigated) in the soil profile?
- Are root development patterns normal (unrestricted by soil compaction, overirrigation) for the time of year and stage of crop growth?
- Is soil condition favorable for plant growth?

Step 4—Discuss with the irrigation decisionmaker the findings and information so far obtained. Listen for management reasons. Make recommendations if enough information is available to do so. Make sure there is a true communication with the farm manager or irrigator. Use sketches and narratives, if appropriate. Are decisions based on tradition or field observations and measurements?

(d) Simplified irrigation system and water management evaluations

Some simple evaluation items can be done by irrigation system operators that will help them make management and operation of irrigation equipment decisions. They include:

Item 1—For sprinkler and micro irrigation system, they can check:

- Operating pressures at pump, mainline, sprinkler heads, upstream and downstream of filters to assure they match design.
- Application depth for the irrigation set by using a few 3- to 4-inch random placed, straight sided, vegetable or fruit tin containers for catch containers. Measure water depth in catch containers with a pocket tape. Does it match design and what is desired?
- Discharge from a few microsystem emitters using a one-quart container and a watch. Do not raise emitter more than a few inches. Compute flow in gallons per hour. Do flows match design?
- Translocation and runoff from sprinkler systems.

Item 2—For all irrigation systems, simplified field checking by the operator can include calculation of depth of irrigation for a set using the basic equation,

$$QT = DA.$$

where:

Q = flow rate (ft³/s)

T = time of irrigation application (hr)

D = gross depth of water applied (in)

A = area irrigated (acres)

Item 3—Using a probe, shovel, soils auger, or push type core sampler, the operator can put down a few holes after an irrigation to determine depth of water penetration. Does it match plant rooting depths? Depending on the irrigation system and soil, checking on water penetration could be anywhere from an hour after the irrigation to the next day.

Item 4—Check runoff. Is it excessive? Does it contain sediment?

(e) Abbreviated water management and irrigation system evaluations

An abbreviated evaluation can determine whether a problem(s) exists in a field and how serious it may be. Frequently, a simple evaluation provides enough information to make a decision. Such an evaluation should always precede a more detailed evaluation. With some guidance the irrigation decisionmaker can perform abbreviated irrigation evaluations themselves. Abbreviated management and irrigation system evaluations can be made by onfarm managers or NRCS field staff. Many times, needed changes can be identified in less than an hour.

(1) Sprinkle irrigation

Before irrigation, randomly place calibrated catch containers (or rain gauges) at plant canopy height. Containers should be straight sided with a reasonably sharp edge. When irrigation is complete, a pocket tape or graduated cylinder may be used to measure depth of water caught in each container. This provides an indication of average depth of application only. When sufficient number of containers is used with a uniform spacing pattern within all of the sprinkler lateral application area, pattern uniformity can be calculated (see section 3 in this section).

(2) Sprinkle irrigation (center pivot or linear move)

Using the design nozzle package, source pressure, and lateral size provided by the owner or dealer, a computer evaluation can be made in a few minutes if the computer program is readily available. Field observation of an operating system can identify improper (usually plugged or wrong nozzle size) nozzle operation. A computer equipment evaluation or field inspection of irrigation equipment in use (including lateral pressures and nozzles used) should always precede a detailed system evaluation.

(3) Sprinkle, surface, and micro irrigation

A portable or permanently installed flow measuring device can be used to evaluate gross irrigation water applied. By knowing the flow rate and kilowatt hours per hour energy used with electric powered pumps, the volume of water pumped can be determined using the common electric meter. When using gas or diesel, hours of operation can be determined by knowing the cubic feet, pounds, or gallons of fuel used and the rate

of fuel used per hour. Totalizing time clocks that operate from the engine ignition can also be used.

Irrigators try all too often to cover more acres than the water supply will adequately provide, or they overirrigate a large part of the field to satisfy a small area. Applying the formula $QT = DA$ will solve four out of five IWM problems. Net irrigation depth can be calculated by multiplying gross depth by the overall irrigation efficiency expressed as a decimal.

Some irrigators estimate plant water need accurately then fail to measure flow onto the field, thus applying an unknown quantity of water. Flow measuring devices are one of the most valuable water management tools available to the irrigator. Accurate devices for pipelines and open channels may cost as little as \$50 to over \$1,000. Where water supply is not limited, farmers typically apply too much water, especially where plant water needs or water applied are not measured. This is also common with an irrigation delivery system where water is delivered on a rotation basis.

(4) Surface and sprinkle irrigation

The ball or tile probe is perhaps the most versatile and cheapest tool available to the irrigation decisionmaker. Following irrigation, the probe can be inserted in the soil at various points along the length of run (surface irrigation) or across the field (sprinkle irrigation) to measure the depth of water penetration. (Penetration is easy where water lubricates the soil.) By knowing the soil AWC, the effective irrigation water applied is calculated. Both management application efficiency and system distribution uniformity can be calculated. The ball or tile probe works best where there is an abrupt boundary between a wetted soil and a soil with moisture at less than field capacity. In rocky soil, a sound is emitted when the probe strikes a rock, otherwise no sound should be heard.

The ball or tile probe can also be used to detect excess moisture in lower portions of the soil profile even though soil at or near the surface appears dry, thus delaying irrigation and improving plant vigor.

(5) Surface and sprinkle irrigation

A soil auger or push type core sampling probe can be used at various locations in a field to determine depth of irrigation, extent of lateral movement, and available soil moisture. With experience the irrigation decision-maker can schedule irrigation applications based upon soil moisture at a relatively shallow depth. Application efficiency (E_a) and irrigation system distribution uniformity (DU) can be calculated using soil auger or probe observations. An advantage in using the ball probe, soil probe, or soil auger is that you observe other field crop conditions when walking through the field, thus use the multiresource planning process. Many locations in the field can be quickly checked.

(f) Water management and irrigation system evaluations**(1) Graded or level border (basin)**

(i) Equipment—Equipment needed for a graded or level border includes:

- Soil auger, probe, push type core sampler.
- Watch, 100-foot tape.
- Lath or wire flags for marking stations.
- Portable water measuring device, such as sharp crested weir, Replogle flume, Parshall flume, broadcrested weir, and pipe flow meter. Capacity needed depends on typical inflows used in the area.

(ii) Procedures—The following procedures should be followed.

Before start of irrigation:

- Estimate the soil-water deficit (SWD) at several locations down the border being investigated. Use feel and appearance method.
- Set flags or stakes at uniform distances down the border (generally 100-foot spacing).

During irrigation:

- Observe how uniformly water spreads across the border (basin) width. The soil surface should not have excessively high or low spots, and no intermittent ponding should occur.
- Observe and record the time when the water reaches each station. These times will be used later in plotting a simple advance rate curve.
- Record the time and location of the water front when inflow is turned off.

- Record the time when 90 percent of the soil surface area is no longer covered by water at each station. These times will be used later in plotting a recession curve. No long time ponding should occur.
- Measure or estimate the volume of runoff in terms of percent of inflow volume. (Duration of runoff is determined from the records mentioned above.)
- Probe approximately 24 hours following irrigation, the soil profile down the border strip to check uniformity of water penetration. Where soil and crops are uniform, a previously irrigated border strip may be used for this purpose.
- Determine adequacy of the irrigation with an additional simple check if the rate of inflow is known or can be estimated. Use the basic equation $QT = DA$ to calculate the gross depth of irrigation application from the known rate of inflow, duration of irrigation, and length and width of border strip. An example to determine gross application depth, D , for a border strip 100 feet wide and 1,200 feet long, with 3 cubic feet per second inflow for a set inflow time of 4.5 hours, would be:

$$D = \frac{(Q \times T)}{A}$$

$$D = \frac{(3.0 \text{ ft}^3 / \text{s}) \times (4.5 \text{ hr})}{A} = 4.9 \text{ in.}$$

where:

$$A = \frac{(100 \text{ ft}) \times (1,200 \text{ ft})}{43,560 \text{ ft}^2 / \text{acre}} = 2.75 \text{ acres}$$

When the gross depth of application, $D = 4.9$ inches, is multiplied by the estimated overall application efficiency (decimal), average net depth of irrigation can be estimated. The field technician needs to have experience in ranges of average application efficiencies for the farm or in the general area.

$$\text{Ave. net depth} = 4.9 \times 60\% = 3 \text{ inches (approx.)}$$

(iii) Use of field data—The following steps should be used with the field data:

Step 1—Using distance down the border (stations) and elapsed time in minutes, plot advance and recession curves for the border (fig. 9–12). Show the time when water was shutoff and location of water front at that time. The opportunity time is the time water was in contact with the soil surface (the interval between the advance and recession curves) at any given point (station) along the border. With basins, the water front at various times is plotted on an area basis, similar to topographic contour lines. Advance and recession curves can be plotted at select locations radiating away from the water supply onto the field.

Step 2—Compare probe depths at various locations down the border (basin) keeping in mind that water movement through the soil may not be complete. Does it appear that parts of the border (basin) have had too short an opportunity time?

Step 3—If information on accumulated intake versus time (intake characteristic [family] curve) for the particular soil is available, compare actual opportunity times throughout the length of the border to the opportunity time required for the net application as interpolated from intake characteristic curves.

Step 4—Large variations in opportunity times along the length of the border indicate changes need to be made in the rate of flow, duration of flow, or field surface conditions. Large variations between the opportunity time determined from the intake characteristic (family) curve and the actual opportunity times indicate that changes need to be made in the application or that the estimated intake characteristic (family) curve number is wrong. If it appears that the intake characteristic (family) curve number used is wrong, then a complete system analysis, including ring infiltrometer tests, may be required if more detailed recommendations are desirable.

Step 5—If possible, check the original design. Is the system being operated in accordance with the design (hours of each set, return frequency)? Should redesign be considered?

Step 6—Are irrigation water screening facilities needed?

Step 7—Are there water, soil, or plant management changes that can be made to reduce beneficial water use, fertilizer use, or water lost?

(2) Graded or level furrows

(i) Equipment—The equipment needed includes:

- Soil auger, probe, push type core sampler, shovel.
- Portable flow measuring devices (broadcrested weir/flume, Replogle flume, Parshall flume, v-notch flume, v-notch sharpcrested weir, orifice flow plate, siphon tubes, flow meter in a short length of pipe, bucket).
- Watch with second hand or stop watch.
- Stakes or wire flags for locating stations.

At least three furrows should be evaluated. Included should be the correct proportion of wheel rows, nonwheel rows, and guess rows. A judgment decision must be whether these few furrows adequately represent the entire field.

(ii) Procedures—The following procedures should be followed.

Before the start of irrigation:

- Estimate the soil-water deficit (SWD) at several locations down furrows being investigated (use feel and appearance method). Check soil moisture in the root zone (not necessarily in the center of the furrow). Is it dry enough to irrigate?
- Note the condition of furrows. Has there been a cultivation since the last irrigation?
- Set stakes or wire flags at 100-foot stations down the length of each furrow evaluated.

Figure 9–12 Plot of example advance and recession curves

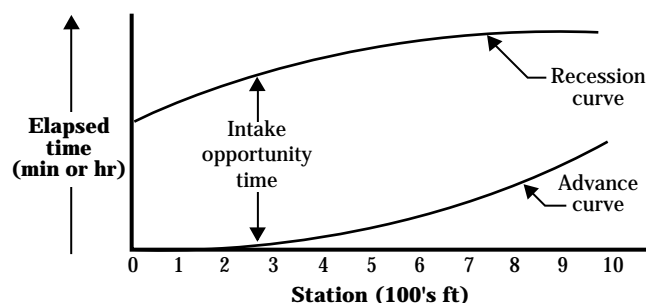

During an irrigation:

- Measure (or estimate) the inflow rate (example 9–1). If siphon tubes are used, a siphon tube head-discharge chart can be used to estimate inflow. If total inflow is known, divide total inflow by the number of furrows being irrigated. Timing furrow flow catch in a bucket of known capacity or using a portable furrow flow measuring device are both accurate.
- Observe the time it takes water to reach each station (lath or wire flag) and to reach the lower end of each furrow evaluated.
- Measure furrow outflow with a portable flow measuring device periodically during the runoff phase to get an average outflow rate in gallons per minute, or estimate runoff rate in terms of percent of inflow rate (example 9–1).
- Check for erosion and sedimentation in the furrow or tailwater collection facilities.
- Dig a trench across a furrow (plant stem to plant stem) to be irrigated by the next set. The wetted bulb can also be observed following an irrigation. Observe conditions, such as:
 - Actual root development, location, and pattern
 - Compaction layers—identify cause (cultivation, wheel type equipment, plowing, disking)
 - Soil textural changes
 - Salt accumulation and location
- About 24 hours following irrigation, probe the length of a representative furrow to check uniformity of water penetration. Where soil and crops are uniform, a previously irrigated furrow set can be used for this purpose.

(iii) Use of field data—The following steps should be used with the field data:

Step 1—Was the soil dry enough to start irrigating? What was the soil-water deficit in the root zone at various points along the furrow before irrigating?

Step 2—Did water penetrate uniformly along the length of furrow? Good uniformity usually is achieved if the stream progresses uniformly and reaches the lower end of the furrow without erosion in about a quarter to a third of the total inflow time. Should furrow length be reduced? increased? Should inflow rate be changed?

Plot the advance curve for the furrow (see fig. 9–12). Plotting of the furrow advance curve is basically the same as the plot of the border advance curve. Shape of advance curve can indicate adequacy of inflow rates in relation to soil intake characteristics for that specific length of furrow. Estimates for adjustments in furrow irrigation operation values can be made using inflow and advance rate estimates.

Step 3—Was there runoff? How much? Water ponding with blocked end nearly level furrows or running off at the lower end of nonblocked furrows is essential for practical operation and a full, uniform irrigation. Runoff water can be collected and reused by using a tailwater collection and return-flow facility.

Step 4—Are the water supply and conveyance systems capable of delivering enough water for efficient and convenient use of both water and labor? Supplies should be large enough and flexible in both rate and duration. Furrow streams should be adjustable to the degree that flow will reach the end of most furrows in about a quarter to a third of the total inflow time. If appropriate, tailwater reuse, cablegation, cutback, or surge irrigation techniques can significantly increase distribution uniformity (see chapter 5).

(iv) Observations—Did soil in the crop root zone contain all of the irrigation water applied? Is there still a soil-water deficit in the root zone or is deep percolation below the root zone occurring? A simple before and after soil-water content check can provide data to estimate amounts before and after irrigation. However, this does not account for uniformity or nonuniformity in application depths throughout the length of the furrow. By simple soil probing or push core sampling throughout the length of the furrow the next day following an irrigation (or on a previous set), depth of water penetration along the furrow can be observed.

With some field experience, inflow rate and set time adjustments can be recommended to improve depth of water penetration and uniformity of water penetration along the furrow length. A detailed field evaluation is necessary for fine tuning recommendations. Often these measurements can be observed by the farm irrigation decisionmaker or irrigator. Until a field technician is experienced with furrow irrigation, a complete evaluation process with data should be used.

Was the soil dry enough to start irrigating? Was it too dry? Compare the SWD to application. How does the crop look? Is there evidence of under irrigation, salinity problems, overirrigation? Are there obvious dry spots? dry strips?

Is there soil erosion? water translocation? or runoff? Is it general or only at specific locations? A solution may be to improve irrigation water or tillage management.

Example 9-1 Estimating furrow inflow and outflow depths

Use the basic equation $QT = DA$ (altered to use common field units; i.e., conversion factor of 96.3 so flow can be shown in gallons per minute and furrow spacing and length in feet)

Inflow: Depth, $D = \frac{(\text{furrow flow, gpm}) \times (\text{set time, hr}) \times (96.3)}{(\text{furrow spacing, ft}) \times (\text{furrow length, ft})}$

Field data: 10 gpm per furrow inflow
12 hours set time
30-inch furrow spacing (with flow every furrow)
1,000-foot furrow length, gives:

$$D = \frac{(10 \text{ gpm}) \times (12 \text{ hr}) \times (96.3)}{(2.5 \text{ ft}) \times (1,000 \text{ ft})}$$

Outflow: $RO = \frac{(\text{average furrow outflow, gpm}) \times (\text{outflow time, hrs}) \times 96.3}{(\text{furrow spacing, ft}) \times (\text{furrow length, ft})}$

Field data: 3.5 gpm average outflow and 9.5 hours outflow time, gives:

$$RO = \frac{(3.5 \text{ gpm}) \times (9.5 \text{ hr}) \times (96.3)}{(2.5 \text{ ft}) \times (1,000 \text{ ft})} = 1.3 \text{ inches}$$

Summary: Infiltration = 4.6 inches – 1.3 inches = 3.3 inches, or 72 percent

$$RO = \frac{1.3 \text{ inches}}{4.6 \text{ inches}} = 28\%$$

(3) Sprinkler systems

(i) Periodic move laterals—This type sprinkler systems include sideroll wheel lines, handmove, end tow, and fixed or solid set operations.

Equipment—The equipment needed includes:

- Soil auger, probe, push type core sampler.
- Bucket calibrated in gallons (2 to 5 gal).
- 5-foot piece of 3/4-inch garden hose.
- Set of new twist drill bits (1/8 to 1/4 inch by 64ths).
- Watch with second hand or stop watch.
- Pressure gauge with pitot tube attachment. Suggest using liquid filled pressure gauges for increased durability, plus the indicator needle does not flutter when making a reading.

Procedures—The following procedures should be used in the evaluation.

Step 1—Estimate the soil-water deficit (SWD) at several locations ahead of the sprinkler lateral. Check irrigation adequacy behind the sprinkler. Use the feel and appearance method.

Check uniformity of water penetration into the soil between sprinkler heads and laterals on the previous irrigation set using a probe or push core sampler. Properly overlapping sprinkler-wetted areas (pressure, discharge, sprinkler head, and lateral spacing) provides nearly uniform application. A detailed evaluation using a complete grid of catch devices can accurately determine application pattern uniformity.

Step 2—Using the IWM formula, $QT = DA$, determine depth of water applied by an irrigation. This is accomplished by first measuring nozzle discharge by placing the hose over the nozzle and then timing the flow into the calibrated container.

Step 3—To check nozzle discharge, fit hose over sprinkler head nozzle (two hoses for double nozzle sprinkler heads). A loose fit is desirable. Direct water into a calibrated bucket. Using a watch or timer, determine the time period it takes to fill the calibrated bucket. Check several sprinkler heads on the lateral. Calculate nozzle flow rate in gallons per minute. Calculate the precipitation rate from manufacturer tables or charts, or use the IWM equation (96.3 is units conversion factor when using gallons per minute and sprinkler head spacing in feet):

$$I = \frac{(96.3) \times (q)}{S_l \times S_m}$$

and

$$\text{Depth of water applied} = I \times H$$

where:

- I = precipitation (application) rate, in/hr
- q = nozzle flow, gpm
- H = set time, hr
- S_l = spacing of heads along lateral, ft
- S_m = lateral spacing along main, ft

Step 4—Take pressure readings at several locations along the lateral(s) using the pitot tube pressure gauge. If not in the critical position, measure elevations and calculate pressure differences if the lateral was moved to that location. Critical location is usually determined by elevation and distance from the mainline or pump. Pressure differences should not exceed 20 percent between any two sprinkler heads on the same lateral. This provides for less than 10 percent difference in discharge between heads on the lateral.

Desirable and design operating pressure should occur in the area that affects most sprinklers; i.e., about a third the distance from upstream end, on uniform diameter, level laterals. Excessive operating pressure produces small droplets, or fogging, and irregular turning of sprinkler heads. Small droplets are subject to wind drift and result in increased application close to the sprinkler head. Too low of a pressure causes improper jet breakup giving large droplet sizes. This typically produces a doughnut-shaped spray pattern, which if not corrected, results in a similar plant growth pattern. Larger droplets are less affected by wind. Very little water is applied close to the sprinkler head. Both conditions, excessive and too little pressure, result in poor distribution patterns.

Step 5—Using the shank end of a new, same size twist drill bit, check the orifice diameter of several sprinkler nozzles for appropriate size and wear. The twist drill shank should just fit into the orifice without wiggle. Excess wiggle indicates excessive wear (or too large nozzle diameter), which indicates nonuniform discharge from nozzles and poor distribution pattern between heads. Nozzles are considered worn if the next diameter bit fits into the orifice or the drill bit can

be moved sideways more than 5 degrees. Wear is typically caused from abrasive sediment in the water. Often excessive wear creates an oblong opening and is readily apparent.

Utilization of field data—The following steps should be used with field data:

Step 1—Was the soil dry enough to start irrigating? Was it too dry? What was the soil-water deficit at various locations in the field ahead of the sprinkler?

Step 2—Compare the SWD to application. How does the crop look? Is there evidence of under irrigation, salinity problems, overirrigation? Are there obvious sprinkler application pattern problems? dry spots? dry strips? donut-shaped patterns?

Step 3—Is there soil erosion, water translocation, or runoff? Is it general or only at specific locations? This indicates whether the application rate is too great. A solution may be to improve irrigation water or tillage management rather than changing hardware.

Step 4—Are sprinkler heads vertical and are self leveling risers on wheel lines operating properly? Are sprinkler heads rotating evenly and timely? (They should rotate at 1 to 2 revolutions per minute.) Do sprinkler head type, nozzle size, and pressure match spacing on lateral and along mainline and design? If it is apparent that sprinkler heads along the wheel line are not plumb, installation of self leveling heads should be recommended. Installing new, proper sized nozzles can be one of the most cost effective operational improvements.

Step 5—If possible, check the original design. Is the system being operated in accordance with the design (pressure, hours of each set, return frequency)? Should redesign be considered?

Step 6—Are gaskets in good condition with no excessive leaks? Are nozzles plugged or partly plugged? Are return springs broken? Is a screening system needed? If the nozzles are oversized, of varying size, or worn, they should be replaced. Replacement with new nozzles of uniform size generally is one of the most cost effective actions an irrigator can take.

(ii) Continuous (self) move—This type sprinkler system includes center pivot, linear, or lateral move.

Equipment—The equipment needed includes:

- Soil auger, probe, small diameter (1 inch) push type core sampler.
- Calibrated catch containers or rain gauges.
- Measuring tape (50 ft).
- Pressure gauge with pitot tube attachment. Suggest using liquid filled pressure gauges for increased durability, plus the indicator needle does not flutter when making a reading.
- Electrical resistance meter (tick meter) to check for stray voltage.
- Stakes to set containers or rain gauges above crop canopy.

Procedures—The following procedures should be used in the evaluation.

Step 1—Safety precautions should be followed before touching or climbing upon an electric powered self moving lateral system. Check for stray electric currents with a properly grounded tick meter or other approved equipment or methods, then use the back of the hand to briefly touch metal lateral components the first time. Don't grab any part of the system until it is checked. Muscles in the hand and fingers contract when subjected to electrical currents, causing the fingers to close and stay closed. If portable ladders are used to reach any of the sprinkler heads, it is advisable to use ladders made from OSHA approved nonconductive material. Hooks should be installed on the upper end of the ladder because the system moves during the evaluation.

Step 2—Uniformly place catch containers or rain gauges at or slightly above the crop canopy equidistant apart (the closer the spacing the more accurate the results, generally not greater than 30 feet apart) and ahead of the moving lateral so the lateral will cross perpendicular over them. For best accuracy, two rows of catch containers are set out and catch is averaged. However, one row is typically used to provide information needed to make general decisions. For center pivot systems, select representative spans near the middle and end of the lateral.

Catch containers or rain gauges are often omitted within 400 feet of the pivot point, as containers represent a small area (less than 3 acres). Uniformly space

containers or rain gauges within each test section. The nearer to the outer end of the lateral, the shorter time period required for the lateral to pass over the catch containers. Let the lateral completely cross the containers. The start-stop operation of self move systems, evaporation losses between night and day operation, and changing wind speeds and direction can cause nonuniformity in catch volume for a single spot. If this appears to be a problem, use two lines of containers or rain gauges at different lateral positions. Use the same container spacing and start distance from pivot point for both rows of catch containers. Water caught in containers positioned at the same distance from the pivot point represent the same area on the lateral. Averages should be used. Identify tower positions when laying out catch containers for later reference when presenting results to the irrigation decision-maker.

If containers are left for an extended time, a small amount of mineral oil placed in them will reduce evaporation effects.

Step 3—Calculate the average depth of water caught in all containers to find average application depth for the length of lateral tested. The longer the lateral length tested, the more representative the average depth of application. Testing the full length of the lateral would represent the total area, but requires more time. Operating pressure should be measured at several points along the lateral.

Special and unique field catch devices and evaluation procedures must be used for low energy precision application (LEPA), low pressure in-canopy (LPIC), and low pressure systems using specialty heads.

(iii) Continuous (self) move—This type sprinkler system includes the traveling gun sprinkler.

Equipment—The equipment needed includes:

- Soil auger, probe, push type core sampler.
- Calibrated catch containers or rain gauges.
- Pressure gauge with pitot tube attachment. Suggest using liquid filled pressure gauges for increased durability plus the indicator needle does not flutter when making a reading.

Procedures—The following procedures should be used in the evaluation.

Step 1—Uniformly space catch containers or rain gauges across the path of the traveling sprinkler. Catch should represent a cross section of the total application. When the sprinkler has completely passed over the catch containers, measure the depth of water in each can and record the distance from the sprinkler travel path. Combine sprinkler catch where lap would have occurred. Calculate the average irrigation application.

Step 2—With water shut off, use calipers (for improved accuracy) to check inside diameter of nozzles on big gun sprinkler heads. It is rather difficult and hazardous to check nozzle discharge with a hose and bucket or use nozzle pressure with a pitot tube on a pressure gauge. If attempted, hold the driving arm down to prevent sprinkler head rotation. An access plug that is often near the base of the big gun can be used to temporarily install a pressure gauge. Line pressure should be corrected for elevation of the nozzle. Manufacturer charts and tables should be referenced.

Utilization of field data—The following steps should be used with the field data:

Step 1—Was the soil dry enough to start irrigating? Was it too dry? What was the soil-water deficit (SWD) at various locations in the field ahead of the sprinkler? following the sprinkler?

Step 2—Compare the soil-water deficit (SWD) to the water application. How does the crop look? Is there evidence of under irrigation? salinity problems? overirrigation? Are there obvious sprinkler application pattern problems? dry spots? dry strips? donut shaped patterns? wet areas?

Step 3—Is there soil erosion, water translocation, or field runoff? Is it general or only at specific locations? These items indicate whether application rate is too great. A solution may be to improve irrigation water or tillage management rather than changing hardware. Increasing traveler speed to apply less water or changing tillage to increase soil surface storage are examples of low cost management changes.

Step 4—Are sprinkler heads positioned vertically? Are sprinkler heads rotating evenly and timely? Do sprinkler head type, nozzle size, pressure, and lane spacing match the design?

Step 5—If possible, check the original design. Is the system being operated in accordance with the design (pressure, speed, return frequency)? Should redesign be considered?

Step 6—Are gaskets in good condition with no excessive leaks? Are nozzles and equipment worn? Is a screening system needed? Should nozzles be replaced?

Step 7—Are there water, soil, or plant management changes that can be made to reduce beneficial water use, fertilizer use, or water loss?

(4) Micro systems

(i) **Equipment**—The equipment needed includes:

- Soil auger, probe, or small diameter (1 inch) push core sampler.
- Catch devices, graduated cylinder with 250 mL capacity. Devices used for catching discharge are generally home crafted so the catch device is fitted to the specific type of emitter device(s). Examples of catch devices are:
 - Troughs made from rain gutter (preferably plastic) or rigid plastic pipe (cut in half longitudinally) for line source emitters.
 - Single catch container for single emitters.
 - Cut and fit 2-liter plastic soda bottles for minispray heads (fig. 9-13)
- Watch with second hand or stop watch.
- Pressure gauge with special adapters to fit polyethylene pipe microsystem fittings.
- Manufacturer emitter performance charts.
- Measuring tape.

(ii) **Procedures**—The following procedures should be used for the evaluation.

Step 1—Set catch devices under selected drippers or over minispray heads and sprinklers, or both. Checking a few emitters can give an idea if a detail evaluation is necessary. Figure 9-13 shows a home fabricated catch device made from a 2-liter plastic soda bottle that can be used to catch flow from minispray heads and sprinklers. Check operating pressure at head and end of lateral or wherever possible and practical. Fittings may need to be installed. A low range reading pressure gauge (0 to 20 psi) may be necessary to obtain reasonably accurate pressure readings. Do not raise a micro irrigation emitter device more than a few inches. Raising the emitter reduces the operating pressure and discharge.

Step 2—Use a probe or push core sampler to determine wetted area and depth of water penetration for all types of emitter devices, including single and line-source emitters for both surface installed and buried laterals. Wetted width should reach the drip line of plants (perennials). Wetted depth should reach potential root zone depth. For annual plants, such as row crops, wetted width should be at a planned width, but generally not less than 50 to 65 percent of the total surface area.

(iii) **Utilization of field data**—The following steps should be used with the field data:

Step 1—Was the soil dry enough to start irrigating? Was it too dry? What was the soil-water deficit (SWD) at various locations in the field ahead of the emitter system? following irrigation? If soils are uniform, a previous irrigation can be used.

Step 2—Compare the soil-water deficit to application. How does the crop look? Is there evidence of under irrigation, salinity problems, or overirrigation? Are there obvious pattern or distribution problems?

Step 3—Are visible emitters operating properly? Are minispray heads and sprinklers rotating evenly and timely?

Step 4—If possible, check the original design. Is the system being operated in accordance with the design (pressure, hours of each set, return frequency)? Should redesign be considered?

Step 5—Are there excessive leaks? Are emitters or nozzles plugged? Is the filter system appropriate and being operated satisfactory?

Step 6—Compare catch against manufacturer's flow rate chart. Discharge variation could be because of plugging, inadequate or excessive pressure, excessive main, submain and lateral head loss, or manufacturing discharge variation.

Step 7—Are there water, soil, or plant management changes that can be made to reduce water use, water lost to nonbeneficial uses, and fertilizer use?

Figure 9-13 Minispray head catch device (made from a 2-liter plastic soft drink bottle)

Step 1. Make cuts as shown

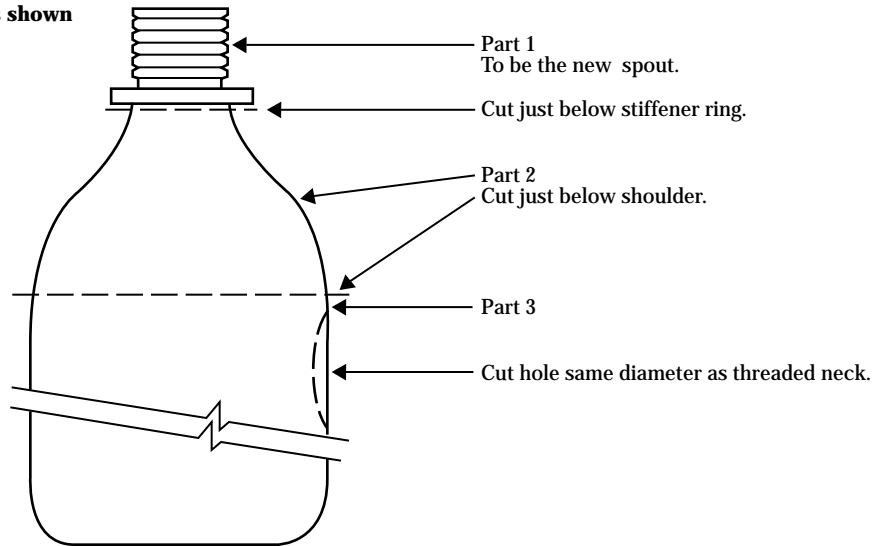

Step 2.

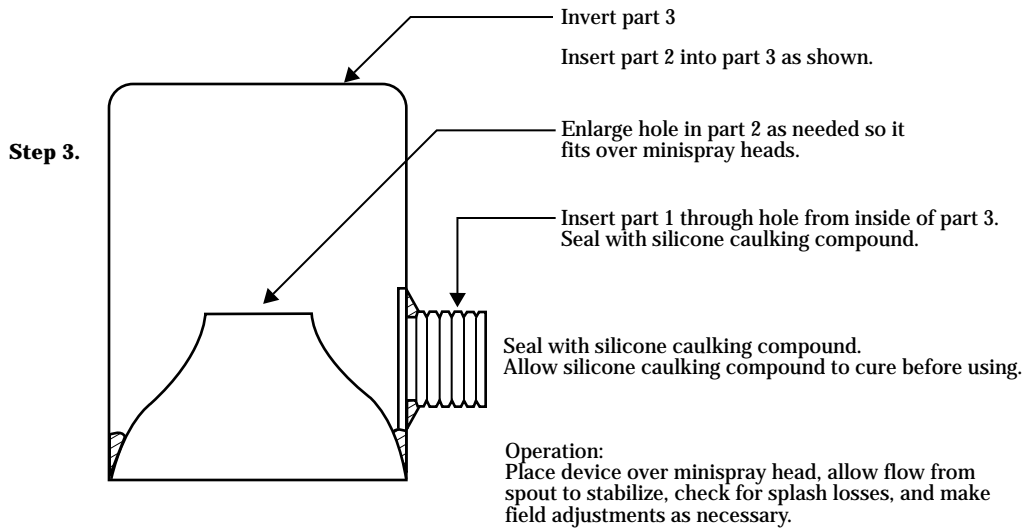

(g) Detailed irrigation system evaluation procedures

More detailed irrigation system evaluations are occasionally needed when complete field data, including pattern uniformity and distribution efficiency, are needed at a particular site. The first-step procedures described in 652.0904(c) should always be completed before deciding to expend the considerable time and effort required to do a complete irrigation system and management evaluation. Each detailed system evaluation consumes from one to five staff person days, depending on type of irrigation system. The objective of any evaluation is to improve irrigation system operation and water management.

The product for the irrigation decisionmaker would be an evaluation report and a comprehensive irrigation system operation and management plan. Depending on local concerns and priorities (i.e., water quantity or quality), it may be desirable to set up multi-agency sponsored IWM teams that have the necessary full-time staff and equipment to provide assistance to farm managers and irrigation decisionmakers. Irrigation decisionmakers should be present during the evaluation so they can observe measurements being taken. The weighted importance (or effect) of measured observations can also be discussed.

In addition to site specific benefits derived from a complete evaluation for the irrigation decisionmaker, collected field data can support or modify estimated values in the local irrigation guide. The data can be used as a basis for future irrigation system planning and design. Another benefit is local on-the-job training opportunities for NRCS irrigation personnel. The best way to learn about planning, designing, and operating irrigation systems is to closely observe and evaluate irrigation system(s) operation and management as they are taking place. Every person performing irrigation planning and design should occasionally go through a complete evaluation on each type of system being used in the area. It is a fantastic learning opportunity. To become adequately experienced in irrigation to where sound knowledgeable and practical recommendations can be made, typically is a long-term process. True communication takes place when the irrigation decisionmaker perceives the consultant's knowledge being equal to or expanded beyond their own.

Providing detailed field evaluations is time consuming and must be comprehensive enough to provide detailed recommendations for improvements to both management and system operations.

This part of chapter 9 describes procedures for performing detailed irrigation system evaluations. Included are detailed procedures for performing irrigation system evaluations for surface, sprinkle, micro, and subirrigation systems and for pumps. Examples and blank worksheets are included in chapter 15 of this guide.

(1) Graded border irrigation systems

Improving water use efficiency of border irrigation has great potential for conserving irrigation water and improving downstream water quality. A detailed evaluation can provide the information for design or help to properly operate and manage a graded border irrigation system. It can help the irrigation decisionmaker determine proper border inflows, lengths of run, and time of inflow for specific field and crop conditions. It should also be recognized that soil intake characteristics have the biggest influence on application uniformity. Intake rate for a specific soil series and surface texture varies from farm to farm, field to field, and throughout the growing season; typically because of the field preparation, cultivation and harvest equipment, and other field traffic.

To approximate the infiltration amount (intake rate) based upon advance and opportunity time for a border, a correlation is made using cylinder infiltration test data. A detailed irrigation system evaluation can identify soil intake characteristics for site conditions within that particular field. It can also provide valuable data to support local irrigation guides for planning graded border irrigation systems on other farms on similar soils.

(i) Equipment—The equipment needed for a graded border irrigation system includes:

- Engineers level and rod, 100 foot tape
- Pocket tape marked in inches and tenths/hundredths of feet
- Stakes or flags, marker for stakes or flags
- Measuring devices for measuring inflow and outflow
- Carpenters level for setting flumes or weirs.
- Cylinder infiltrometer (minimum of 4 rings) set with hook gauge and driving hammer and plate

- Equipment for determining soil moisture amounts (feel and appearance charts, Speedy moisture meter and Eley Volumeter, or Madera sampler and soil moisture sample cans)
- Water supply and buckets to provide infiltrometers with water
- Soil auger, push tube sampler, probe, shovel
- Graded border evaluation worksheet, clipboard, and pencil
- Soils data for field
- Stop watch, camera
- Boots

(ii) Procedures—The field procedures needed for this system are in two main categories: General and inventory and data collection.

General

Choose a typical location in the field to be irrigated. The typical location should be representative of the type of soil for which the entire field is managed. Use standard soil surveys, where available, to locate border evaluation sites. Then have a qualified person determine the actual surface texture, restricted layers, depth, and other soil characteristics that affect irrigation. Soil surveys are generally inadequate for this level of detail. Almost all mapping units have inclusions of other soil. Extension of results to other areas also has more reliability. The site selected should allow measurement of runoff if it occurs. The evaluation should be run at a time when soil moisture conditions are similar to conditions when irrigation would normally be initiated. This procedure is described in the following steps.

Step 1—Obtain information from the irrigation decisionmaker about the field and how it is irrigated; i.e., irrigation set time; borders irrigated per set with typical inflow rates, advance rates (times), adjustments made during irrigation set time, and number of irrigations per season; and tillage and harvesting equipment.

Step 2—Record field observations, such as crops grown, crop color differences in different parts of the border or field, crop uniformity, salinity, and wet areas. Also make field observations concerning erosion and sediment deposition areas. The border to be evaluated should have uniform cross slope grade and uniform downslope grade.

Set stakes or flags at 50- to 100-foot stations down the center of the border to be evaluated. Mark stations so readings can be observed from at least 50 feet; i.e., border dike or adjacent border. Determine field elevation at each station and for a typical cross section of the border.

Record border width (center to center of border dike), strip width (distance between toes of border dikes), and wetted width (width to which water soaks or spreads beyond the edge of dike).

Set flumes, weirs, or other measuring devices at the upper end of the border and at the lower end if runoff is to be measured. Continuous water level recorders in the measuring devices may be convenient to use.

Part of the objective during a detail evaluation is to determine infiltration rate under actual field conditions using cylinder infiltrometers. Set three to five cylinder infiltrometers in carefully chosen typical locations within the border strip. Generally the most convenient location is a couple of hundred feet from the upper end of the strip (close to the water supply). Continuous water level recorders are convenient to use in the infiltrometers. USDA publications reviewing the installation of the cylinders are nearly nonexistent. See Part 652.0905(b) for additional information on installation and operation of cylinders.

Step 3—Estimate soil water deficit at several locations along the border. Use the feel and appearance method, Eley Volumeter/Speedy Moisture Meter, push type core sampler and gravimetric, or some other portable method. Pick one location as being typical for the border strip and record the data for that location on the worksheet.

Step 4—At the same time make note of soil profile conditions. With uniform soils, this can be done in an adjacent border during a later portion of the test when infiltration rates are typically slower. Soil conditions to consider include:

- Depth to water table
- Apparent root depth of existing or previous crop (to determine effective plant root zone)
- Restrictive (compacted) soil layers to root development and water movement; i.e., tillage pans
- Mineral layers
- Hard pans or bedrock
- Soil textural changes

Inventory and data collection

Steps to following during irrigation are:

Step 1—Irrigate with inflow rates normally used by the irrigator, and record starting time.

Step 2—Measure and record the inflow rate at 5- to 10-minute intervals until it reaches a constant rate. During the trial, periodically check inflow rate and record the values. More frequent checks are needed if the inflow rate fluctuates considerably.

Step 3—Observe and record how well water spreads across as water advances down the border strip.

Step 4—Record the time when the leading edge of the water reaches each station. If the leading edge is an irregular line across the border strip, average the time as different parts of the leading edge reach the station.

Step 5—Fill cylinder infiltrometers (rings) as the leading edge of the water flow in the border passes through the test site. An alternative to measuring infiltration while the border is being irrigated is to build berms (or install a larger ring) around infiltrometers being measured. Maintain water between the berm and infiltrometer ring at the same time water is poured into and measured inside infiltrometer rings. Using a hook gauge or other water level recording device, record water levels in each infiltrometer at times shown on the infiltrometer worksheet. See procedure and worksheets in section 652.0905, Soil intake determination procedure.

Step 6—If there is runoff, record the time when it starts. If outflow is being measured, periodically measure the flow rate and record the rate and time of measurement until it ceases.

Step 7—Record the time when water is turned off at the head of the border and the time water recedes past each station. This requires good judgment. On slopes of 0.5 percent or greater, a large part of the water remaining in the border strip when the supply is shut off may move downslope in a fairly uniform manner. On these fields, record recession time at each station when the water has disappeared from the area above it. If the recession line across the border strip is irregular, record the time when less than 10 to 20 percent of

the area is covered by water. Another method is to judge when there is about as much cleared area below the station as there is above the station.

Step 8—On slopes of less than 0.5 percent, a smaller proportion of the water moves down the strip. Some water may be trapped in small depressions and may not be absorbed for some time after surrounding areas are clear. The important thing is to determine when the intake opportunity time has essentially ceased. The recession time may be recorded for a station when 80 to 90 percent of the area between it and the next upstream station has no water on the surface.

Step 9—Immediately after recession, use a probe or auger to check depth of water penetration at several locations down the border. A check at this time will indicate the depth to which water has already percolated. A ball type probe (a 1/2-inch diameter ball welded onto the end of a 3/8-inch diameter push probe) is handy for this task. In the absence of rock, the probe inserts easily where soil has been lubricated by water, and stops abruptly when the wetted front (dry soil) is encountered.

Step 10—If possible, check for adequacy and uniformity of irrigation time when the soil profile has reached field capacity. Sandy soils can be checked 4 to 24 hours after irrigation. Clayey soils typically are checked about 48 hours after irrigation when most gravitational water has drained.

Step 11—If field capacity must be established, determine the soil water content when checking the adequacy of irrigation. With uniform soils, a previously irrigated border strip can be used for this purpose at the same time cylinder infiltrometer rings are being observed.

(iii) Evaluation computations—Information gathered in the field procedures is used in the detailed system evaluation computations. Example 9-2 outlines computations used to complete the Surface Irrigation System Detailed Evaluation Graded Border Worksheet (exhibit 9-2)

Exhibit 9-2 Completed worksheet—Surface irrigation system, detailed evaluation of graded border system

U.S. Department of Agriculture
Natural Resources Conservation Service
Sheet 1 of 8

**Example - Surface Irrigation System Detailed Evaluation
Graded Border Worksheet**

Land user Joe Example Field office _____
 Field name/number West 40
 Observer _____ Date _____ Checked by _____ Date _____

Field Data Inventory:
 Field area 40 acres
 Border number 5 as counted from the North side of field
 Crop Alfalfa Root zone depth _____ ft MAD 3.6 %
 Stage of crop _____

Soil-water data for controlling soil:
 Station 2+00 Moisture determination method Feel & appearance
 Soil series name Glenberg loam

Depth	Texture	AWC (in)*	SWD (%)*	SWD (in)*
<u>0 - 1'</u>	<u>L</u>	<u>2.0</u>	<u>50</u>	<u>1.0</u>
<u>1 - 2'</u>	<u>LFS</u>	<u>1.5</u>	<u>40</u>	<u>0.7</u>
<u>2 - 3.5'</u>	<u>VFLS</u>	<u>2.2</u>	<u>40</u>	<u>0.9</u>
<u>3.5 - 5.0'</u>	<u>GLS</u>	<u>1.5</u>	<u>20</u>	<u>0.3</u>
Total		<u>7.2</u>		<u>2.9</u>

MAD, in = $\frac{\text{MAD, \%} \times \text{total AWC, in}}{100} = \frac{50 \times 7.2}{100} = 3.6$ in

Comments about soils: Compact layer @ 10 - 14 inches

Typical irrigation duration 1.5 hr, irrigation frequency 14 days
 Typical number of irrigation's per year 12 +/-
 Annual net irrigation requirement, NIR (from irrigation guide) 22.1 in
 Type of delivery system (gated pipe, turnouts, siphon tubes) Siphon tubes from concrete lined head ditch

Delivery system size data (pipe size & gate spacing, tube size & length, turnout size) 5 - 4" siphon tubes per border
 Border spacing 30', Strip width 28', Wetted width 29', Length 700'

Field Observations:
 Evenness of water spread across border Notes
 Crop uniformity Notes
 Other observations Notes

NOTE: MAD = Management allowed deficit AWC = Available water capacity SWD = Soil water deficit

Exhibit 9-2 Completed worksheet—Surface irrigation system, detailed evaluation of graded border system—Continued

U.S. Department of Agriculture
Natural Resources Conservation Service

Sheet 2 of 8

**Example - Surface Irrigation System Detailed Evaluation
Graded Border Worksheet**

Data: Inflow X Outflow _____

Type of measuring device 5- 4"x10' Al. siphon tubes

Clock 1/ time	Elapsed time (min)	Δ T (min)	Gage H (ft)	Flow rate (gpm)	Average flow rate (gpm)	Volume 2/ (ac-in)	Cum. volume (ac-in)
Turn on (1051)	0		.25	490			
		9			525	.1740	.1740
1100	9	10	.33	560	625	.2302	.4042
1110	19	10	.50	690	657	.2402	.6462
1120	29	15	.41	625	627	.3464	.9926
1135	44	15	.42	630	632	.3491	1.3417
1150	59	38	.43	635	635	.8887	2.2304
1228	97		.43	635			
Turn off							
(1228)							

Total volume (ac-in) 2.23

Average flow rate =

$$\frac{\text{Total irrigation volume (ac-in)} \times 60.5}{\text{Inflow time (min)}} = \frac{2.23 \times 60.5}{97} = 1.4 \text{ ft}^3/\text{s}$$

Unit flow:

$$q_u = \frac{\text{Average flow rate}}{\text{Border strip spacing}} = \frac{1.4}{30} = 0.047 \text{ ft}^3/\text{s/ft}$$

1/ Use a 24-hour clock reading; i.e., 1:30 p.m. should be recorded as 1330 hours.

2/ Flow rate to volume factors:

Find volume using ft³/s: Volume (ac-in) = .01653 x time (min) x flow (ft³/s)

Find volume using gpm: Volume (ac-in) = .00003683 x time (min) x flow (gpm)

Exhibit 9-2 Completed worksheet—Surface irrigation system, detailed evaluation of graded border system—Continued

U.S. Department of Agriculture
Natural Resources Conservation Service

Sheet 3 of 8

**Example - Surface Irrigation System Detailed Evaluation
Graded Border Worksheet**

Graded border advance recession data

Station (ft)	Advance time			Recession time			Opportunity time (T _o)
	Clock* time	Δ T (min)	Elapsed time (min)	Clock* time	T (min)	Elapsed time ^{1/} (min)	
0+00	Turn on (1051)			Turn off (1228)	Lag (13)		Inflow T ^{2/} (97)
0+00	1101	10	0	1241	35	110	110
1+00	1101	14	10	1316	16	145	135
2+00	1115	12	24	1332	16	161	137
3+00	1127	14	36	1348	8	177	141
4+00	1141	15	50	1356	5	185	135
5+00	1156	19	65	1401	3	190	125
6+00	1215	26	84	1404	3	193	109
7+00	1241		110	1407		196	86

*Use a 24 -hour clock reading; i.e., 1:30 p.m. would be recorded as 1330 hours.

^{1/} Time since water was turned on.
^{2/} Inflow time = turn off time - turn on time.

Exhibit 9-2 Completed worksheet—Surface irrigation system, detailed evaluation of graded border system—Continued

U.S. Department of Agriculture
Natural Resources Conservation Service

Sheet 4 of 8

**Example - Surface Irrigation System
Detailed Evaluation Graded Border Worksheet**

Depth infiltrated

Station	Opportunity time ^{1/} T ₀ (min)	Typical intake curve		Adjusted intake curve	
		Depth ^{2/} infiltrated (in)	Ave. depth infiltrated (in)	Depth ^{3/} infiltrated (in)	Ave. depth infiltrated (in)
0+00	110	3.6		4.0	
1+00	135	4.1	3.9	4.5	4.3
2+00	137	4.1	4.1	4.5	4.5
3+00	141	4.2	4.2	4.7	4.6
4+00	135	4.1	4.1	4.5	4.6
5+00	125	3.9	4.0	4.3	4.4
6+00	109	3.6	3.8	4.0	4.1
7+00	86	3.1	3.3	3.4	3.7
Border extension					
8+00		2.3			
9+00		0			
		Sum of ave. depths		Sum of ave. depths	
		31.3		34.5	

1/ Difference in time between advance and recession curve.

2/ From "typical" cumulative intake curve.

3/ From "adjusted" cumulative intake curve.

Average depth infiltrated (typical)
 = $\frac{\text{Sum of depths (typical)}}{\text{Length (hundreds of feet-extended)}} = \frac{31.3}{9} = 3.5$ in

Extended border area (acres)
 = $\frac{\text{Extended border length} \times \text{wetted width}}{43,560} = \frac{900 \times 29}{43,560} = 0.60$ acres

Actual average depth applied to extended border length
 = $\frac{\text{Ave inflow (ft}^3/\text{s)} \times \text{duration (hr)}}{\text{Extended border area (acres)}} = \frac{1.4 \times 97/60}{0.60} = 3.8$ in

Average depth infiltrated (adjusted)
 = $\frac{\text{Sum of depths (adjusted)}}{\text{Length (hundreds of feet - extended)}} = \frac{34.5}{9} = 3.8$ in

Note: Should be close to actual depth applied.

Exhibit 9-2 Completed worksheet—Surface irrigation system, detailed evaluation of graded border system—Continued

U.S. Department of Agriculture

Sheet 5 of 8

Natural Resources Conservation Service

**Example - Surface Irrigation System Detailed Evaluation
Graded Border Worksheet****Average depth infiltrated low 1/4 (LQ):**

$$\text{Low 1/4 strip length} = \frac{\text{Actual strip length}}{4} = \frac{700}{4} = 175 \text{ ft}$$

$$\text{LQ} = \frac{(\text{Depth infiltrated at begin of L1/4 strip}) + (\text{Depth infiltrated at the end of L1/4 strip})}{2}$$

$$= \frac{4.2 + 3.4}{2} = 3.8 \text{ in}$$

Areas under depth curve:

1. Whole curve	<u>33.9</u>	sq in
2. Runoff	<u>4.4</u>	sq in
3. Deep percolation	<u>9.2</u>	sq in
4. Low quarter infiltration	<u>26.6</u>	sq in

Actual border strip area:

$$= \frac{(\text{Actual border length, ft}) \times (\text{Wetted width, ft})}{43,560} = \frac{700 + 29}{43,560} = .47 \text{ acres}$$

Distribution uniformity low 1/4 (DU):

$$\text{DU} = \frac{\text{Low quarter infiltration area} \times 100}{(\text{Whole curve area} - \text{runoff area})} = \frac{26.6 \times 100}{33.4 - 4.4} = 92 \%$$

Runoff (RO):

$$\text{RO, \%} = \frac{\text{Runoff area} \times 100}{\text{Whole curve area}} = \frac{4.4 \times 100}{33.9} = 13 \%$$

$$\text{RO} = \frac{\text{Total irrigation volume, ac-in} \times \text{RO, \%}}{\text{Actual strip area, ac} \times 100} = \frac{2.23 \times 13}{.47 \times 100} = 0.62 \text{ in}$$

Deep percolation, DP:

$$\text{DP} = \text{Deep percolation area} \times 100 = \frac{9.2 \times 100}{33.9} = 28 \%$$

$$\text{DP} = \frac{\text{Total irrigation volume, ac-in} \times \text{DP, \%}}{\text{Actual strip area, ac} \times 100} = \frac{2.23 \times 28}{.47 \times 100} = 1.33 \text{ in}$$

Exhibit 9-2 Completed worksheet—Surface irrigation system, detailed evaluation of graded border system—ContinuedJ.S. Department of Agriculture
Natural Resources Conservation Service

Sheet 6 of 8

**Example - Surface Irrigation System Detailed Evaluation
Graded Border Worksheet****Evaluation computations, cont:****Gross application, F_g :**

$$F_g = \frac{\text{Total irrigation volume, ac-in}}{\text{Actual strip area, ac}} = \frac{2.23}{.47} = 4.7 \text{ in}$$

Application efficiency, E_a :(Average depth stored in root zone = Soil water deficit (SWD) if entire root zone depth will be filled to field capacity by this irrigation, otherwise use F_g , in - RO, in)

$$E_a = \frac{\text{Average depth stored in root zone} \times 100}{\text{Gross application, in}} = \frac{2.9 \times 100}{4.7} = 62 \%$$

Application efficiency low 1/4, E_q :

$$E_q = \frac{DU \times E_a, \%}{100} = \frac{92 \times 62}{100} = 56.8 \%$$

Average net application, F_n

$$F_n = \frac{\text{Total irrigated volume, ac-in} \times E_a, \%}{\text{Actual strip area, ac} \times 100} = \frac{2.23 \times 56.8}{.47 \times 100} = 2.7 \%$$

Time factors:

Required opportunity time to infiltrate soil water deficit of 3.0 in

$$T_o = \underline{70} \text{ min (} \underline{1} \text{ hr - } \underline{10} \text{ min)}$$

Estimated required irrigation inflow time from adv.-recession curves;

$$T_{in} = \underline{81} \text{ min (} \underline{1} \text{ hr - } \underline{21} \text{ min)}$$

At inflow rate of:

$$Q = \underline{1.4} \text{ ft}^3/\text{s per border strip}$$

Exhibit 9-2 Completed worksheet—Surface irrigation system, detailed evaluation of graded border system—ContinuedU.S. Department of Agriculture
Natural Resources Conservation Service

Sheet 7 of 8

**Example - Surface Irrigation System Detailed Evaluation
Graded Border Worksheet****Present management:**Estimated present average net application per irrigation 3.0 inchesPresent gross applied per year = $\frac{\text{Net applied per irrigation} \times \text{number of irrigations} \times 100}{\text{Application efficiency } (E_a)^{1/}}$

$$= \frac{3.0 \times 12 \times 100}{62} = 58 \text{ in}$$

^{1/} Use the best estimate of what the application efficiency of a typical irrigation during the season may be. The application efficiency from irrigation to irrigation can vary depending on the SWD, set times, etc. If the irrigator measures flow during the season, use that information.

Potential management:Annual net irrigation requirement 22.1 inches, for alfalfa (crop)Potential application efficiency (E_{pa}) 70 percent (from irrigation guide, NEH or other source)Potential annual gross applied = $\frac{\text{Annual net irrigation requirement} \times 100}{\text{Potential application efficiency } (E_{pa})}$

$$= \frac{22.1 \times 100}{70} = 31.6 \text{ in}$$

Total annual water conserved

= $\frac{(\text{Present gross applied} - \text{potential gross applied}) \times \text{area irrigation (ac)}}{12}$

$$= \frac{(58 - 31.6) \times 40}{12} = 91 \text{ acre feet}$$

Annual cost savings:Pumping plant efficiency 55 Kind of fuel electricCost per unit of fuel 7¢/kwh Fuel cost per acre foot \$ 14.33

Cost savings = Fuel cost per acre foot x acre feet conserved per year

$$= 14.33 \times 91 = \$ 1304$$

Example 9-2 Evaluation computation steps

1. Plot the border downslope profile and cross section.

The plot displayed in figure 9-14 shows uniformity of downslope and cross slope. Average downslope gradient is determined.

Figure 9-14 Border downslope profile and cross-section

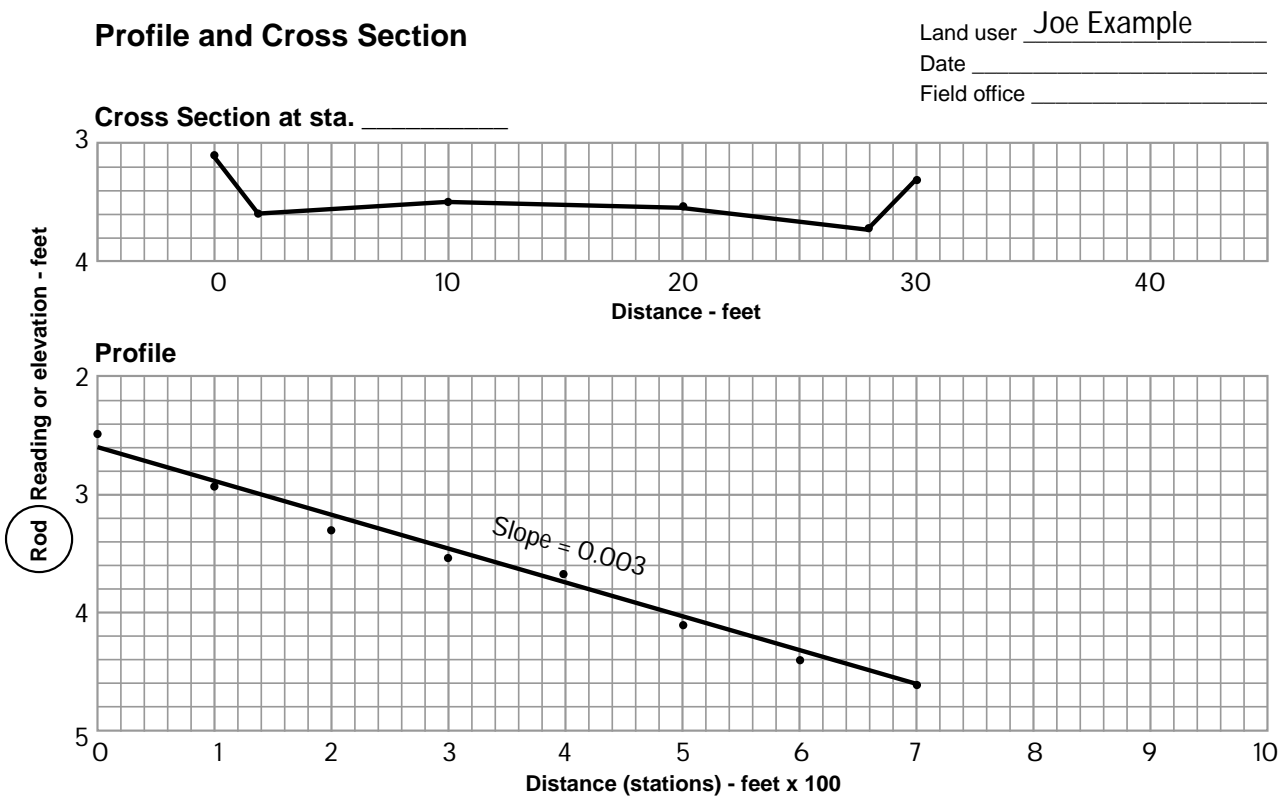

Example 9-2 Evaluation computation steps—Continued

2. **Compute the soil water deficit (SWD).** Compute SWD as shown on worksheet at the test location. This is the net depth of application (F_n) needed for the evaluated irrigation.
3. **Plot a cumulative intake curve for each infiltrometer.** Using log-log paper (fig. 9-15), plot the cumulative intake curve for each infiltrometer and the average of all infiltrometers used. Example field cylinder infiltrometer data are shown in figure 9-16. After all curves have been plotted on the same sheet and deviations have been considered, a typical straight line can be drawn for use in the evaluation. The typical position is later adjusted to represent the duration of irrigation used by the irrigator.

Figure 9-15 Cylinder infiltrometer curves

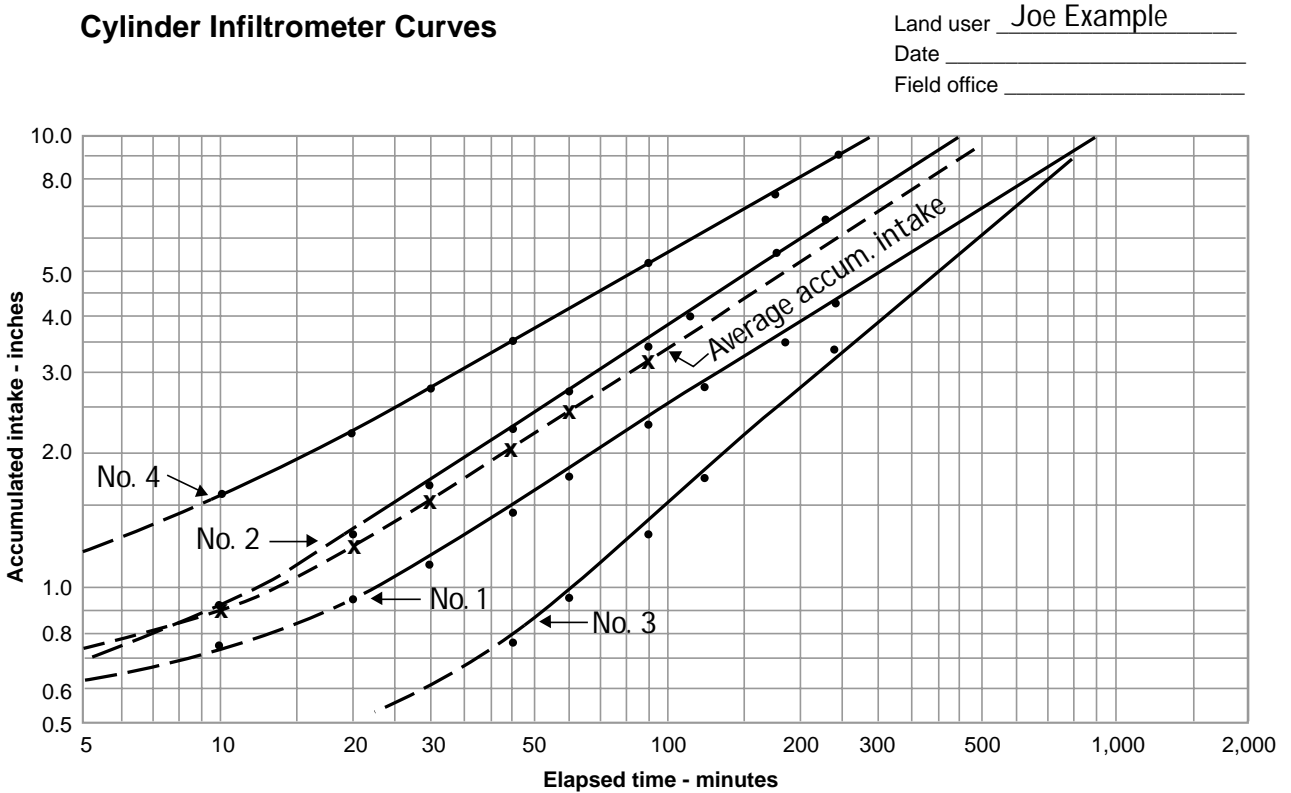

Example 9-2 Evaluation computation steps—Continued

Figure 9-16 Cylinder infiltrometer test data

U.S. Department of Agriculture
National Resources Conservation Service

Cylinder Infiltration Test Data

NRCS-ENG-322
02-96

FARM	Joe Example	COUNTY	STATE	LEGAL DESCRIPTION	NW 1/4 S27, T3N, R28E	DATE	
SOIL MAPPING SYMBOL	SOIL TYPE		Glenberg Loam		SOIL MOISTURE: 0' - 1' - % of available 40% 1' - 2' - % of available 50%		
CROP	Alfalfa	STAGE OF GROWTH					1 week after cutting

GENERAL COMMENTS

Compacted layer between 10 & 14 inches

Elapsed time	Cylinder No. 1			Cylinder No. 2			Cylinder No. 3			Cylinder No. 4			Cylinder No. 5			Average accum. intake
	Time of reading	Hook gage reading	Accum. intake	Time of reading	Hook gage reading	Accum. intake	Time of reading	Hook gage reading	Accum. intake	Time of reading	Hook gage reading	Accum. intake	Time of reading	Hook gage reading	Accum. intake	
Min.	Inches			Inches			Inches			Inches			Inches			
0	11:15	1.80	0	11:16	2.10	0	11:18	3.21	0	11:19	4.10	0				0
5	11:20	2.44	.64	11:22	2.80	.70	11:23	3.56	.35	11:24	5.30	1.20				.72
10	11:25	2.57	.77	11:26	3.05	.95	11:27	3.64	.43	11:28	5.75	1.65				.95
20	11:35	2.76	.96	11:37	3.45	1.35	11:38	3.72	.51	11:39	6.30	2.20				1.26
30	11:45	2.95	1.15	11:46	3.80	1.70	11:47	3.82	.61	11:48	6.85	2.75				1.55
45	12:00	3.25	1.45	12:01	4.35	2.25	12:03	3.97	.76	12:04	7.60	3.50				1.99
60	12:15	3.58	1.78	12:17	4.80	2.70	12:18	4.15	.94	12:19	8.20	4.10				2.38
90	12:45	4.05	2.25	12:46	5.50	3.40	12:47	4.51	1.30	12:47	9.20	5.10				3.01
120	13:15	4.50	2.70	13:16	6.10	4.00	13:17	4.91	1.70	13:18	10.10/ 3.90	6.00				3.60
180	14:15	5.30	3.50	14:17	7.50	5.40	14:18	5.71	2.50	14:19	5.6	7.70				4.78
240	15:15	6.20	4.40	15:16	8.80	6.70	15:18	6.61	3.40	15:19	6.9	9.00				5.88

Example 9-2 Evaluation computation steps—Continued

4. **Plot advance and recession curves (time versus distance) using figure 9-17.** If runoff was not measured, extend the advance and recession curves where the lines intersect (close the ends off). This extended area represents an estimate of border runoff.

Figure 9-17 Advance and recession curves

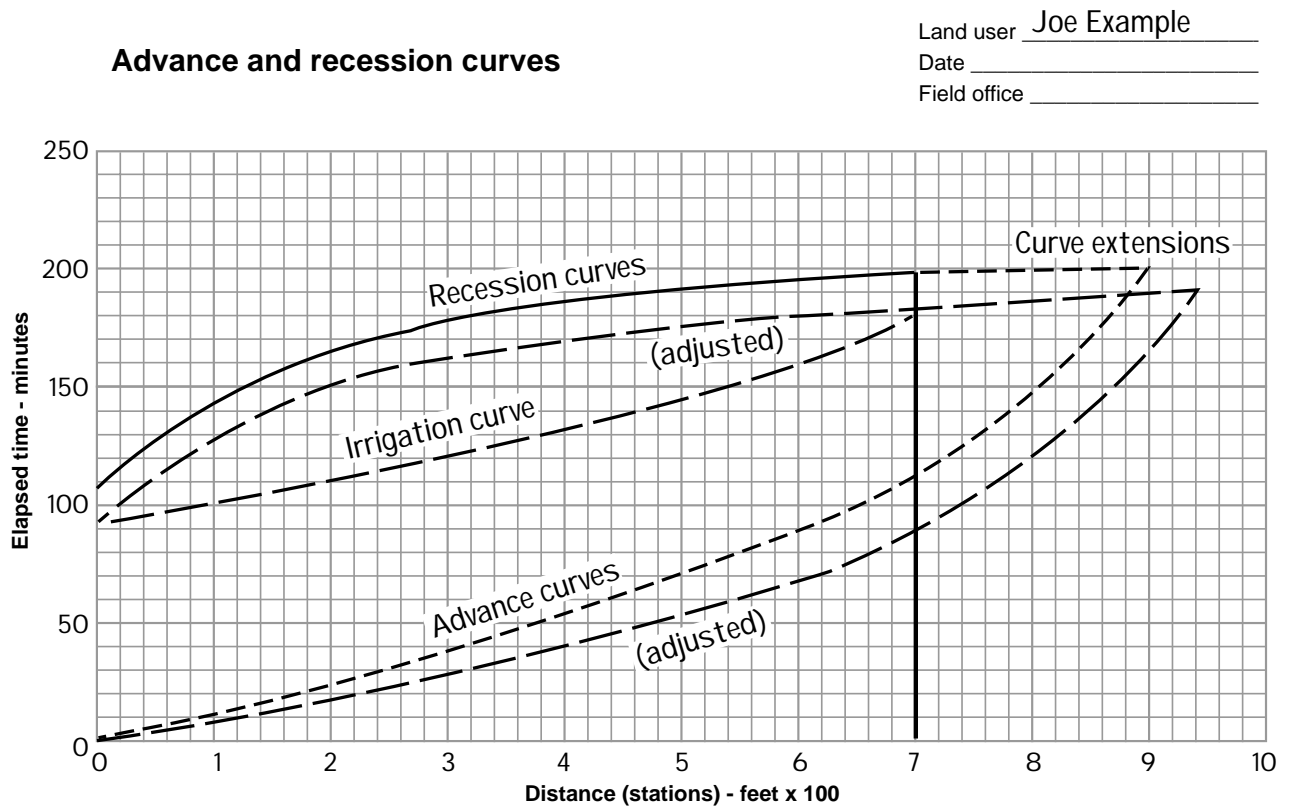

Example 9-2 Evaluation computation steps—Continued**5. Plot the adjusted cumulative intake curve:**

- Determine and record opportunity time for each station, including extended curves on the worksheet. At each station on the border, the opportunity time (time water was on the ground) is determined by measuring the vertical interval (time) between the advance and recession curves.
- Determine and record the depth infiltrated for each station using the opportunity times from the typical cumulative intake curve. Do this for all stations to the extended end of the plotted advance and recession curves. Plotted points beyond the end of the field represent field runoff.
- Compute the average depth of water infiltrated for each station on the worksheet. The depth for a partial station at the end should be proportional to the station length. Total these average depths.
- Determine average typical depth:

$$\text{Ave. typical depth} = \frac{\text{Sum of ave. depths (typical)}}{\text{Length (hundreds of ft)}^{1/}}$$

To check if the location of the typical curve is correct, the actual average depth of water applied is computed:

$$\text{Ave. depth of water applied} = \frac{(\text{Average inflow, in ft}^3/\text{s}) \times (\text{Duration, in hr})}{(\text{Extended border strip area, in acres})}$$

(Use the wetted border width and extended border length to compute the area of the border)

- Correct curve, if needed. A correction is often needed because the infiltrometers check the infiltration at only one spot in the border strip. However, the slope of that curve is probably typical of the average curve for the strip. An adjusted curve, since it is based on the infiltrometer curve slope and actual average depth infiltrated, closely represents the average cumulative intake curve for the border strip and the field.
- Draw an adjusted cumulative intake curve parallel to the typical intake curve prepared from plotted points. The adjusted curve is located as follows:

Using the average intake curve and the average depth infiltrated (3.48 inches), find the corresponding average opportunity time (100 minutes). Then plot a point on 100 minutes and the actual depth applied (3.8 inches). Now draw a line parallel to the average intake curve and through the point at 100 minutes and 3.8 inches. This is the adjusted intake curve. This curve can be plotted on the same worksheet as the field curves or on a separate worksheet. See figure 9-18.

- As a check, the adjusted depths at each station are determined and recorded on page 5 of the worksheet. The averages of these depths are computed and their total is used to compute the adjusted average depth, which should compare closely to the computed actual depth for extended border length:

$$\text{Adjusted ave. depth} = \frac{\text{Sum of average depths (adjusted)}}{(\text{Length, hundreds of ft})^{1/}}$$

1/ Would be 50 feet, if 50-foot stations are used.

Example 9-2 Evaluation computation steps—Continued

Figure 9-18 Cylinder infiltrometer curve

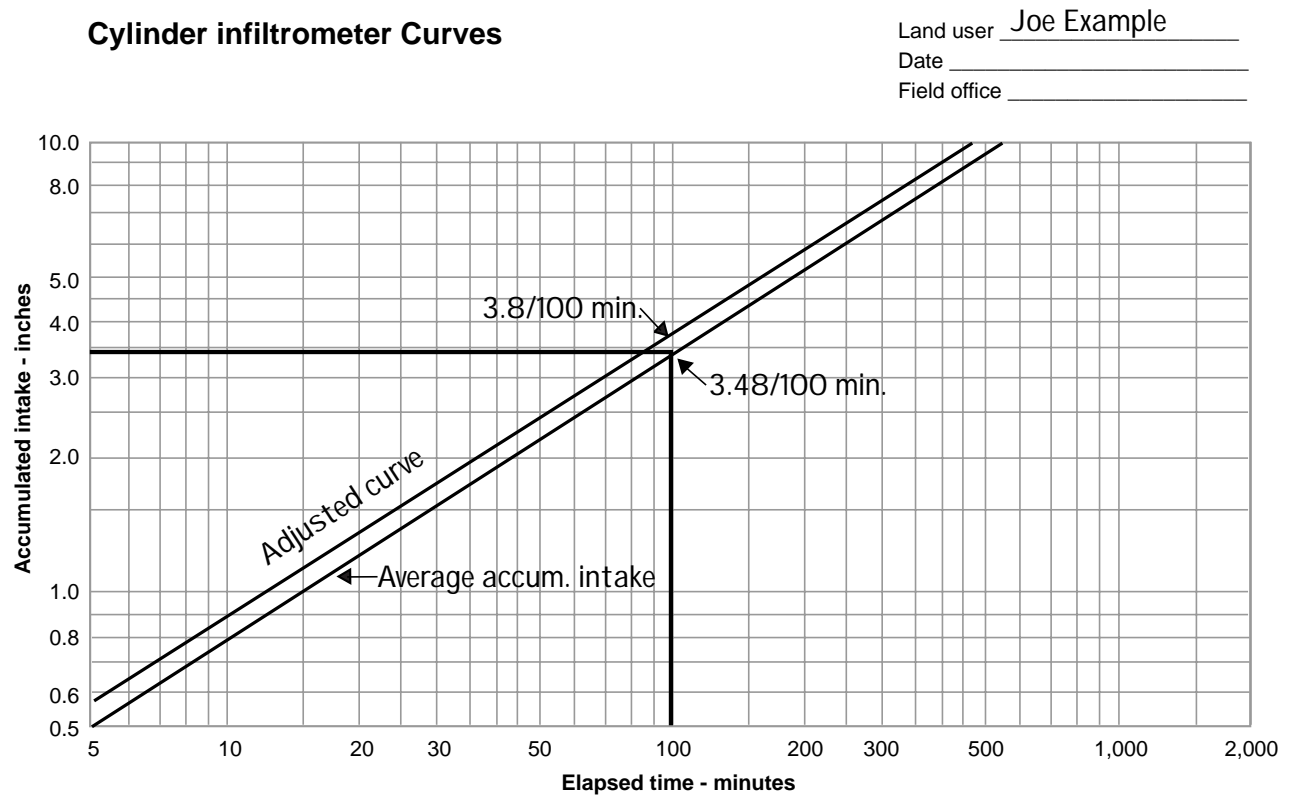

Example 9-2 Evaluation computation steps—Continued**6. Plot a depth infiltrated curve (fig. 9-19) as follows:**

- Plot a cumulative depth infiltrated versus distance curve using depths read from the adjusted intake curve recorded in the previous step.
- Draw a horizontal line at a depth equal to the soil water deficit (SWD).
- Draw a vertical line at the end of border.
- Determine location and length of the low quarter segment of the actual border length. In most cases, this is located at the lower end of the border if blocked ends are not used. On steeply sloping borders, it can occur at the upper end.

$$\text{Low } 1/4 \text{ length} = \frac{\text{Actual border length, ft}}{4}$$

- Compute average depth infiltrated for low quarter:

$$\text{LQ depth} = \frac{\left(\text{Depth infiltrated begin of low } \frac{1}{4} \right) + \left(\text{depth infiltrated end of low } \frac{1}{4} \right)}{2}$$

- Using a planimeter (or by counting squares), determine the areas under the curve at each border station (see fig. 9-19).

Plot the LQ distance on the infiltration curve. Measure the area below the curve between this distance and to the left of the downstream end of the border. This is the low quarter infiltration.

Measure the runoff from the border. This is the area below the curve to the right of the end of the border strip. If runoff was measured, this can be checked by computing total actual runoff volume.

Measure deep percolation. This is the area to the left of the end of the border and above the SWD line.

Example 9-2 Evaluation computation steps—Continued

Figure 9-19 Depth infiltrated curve

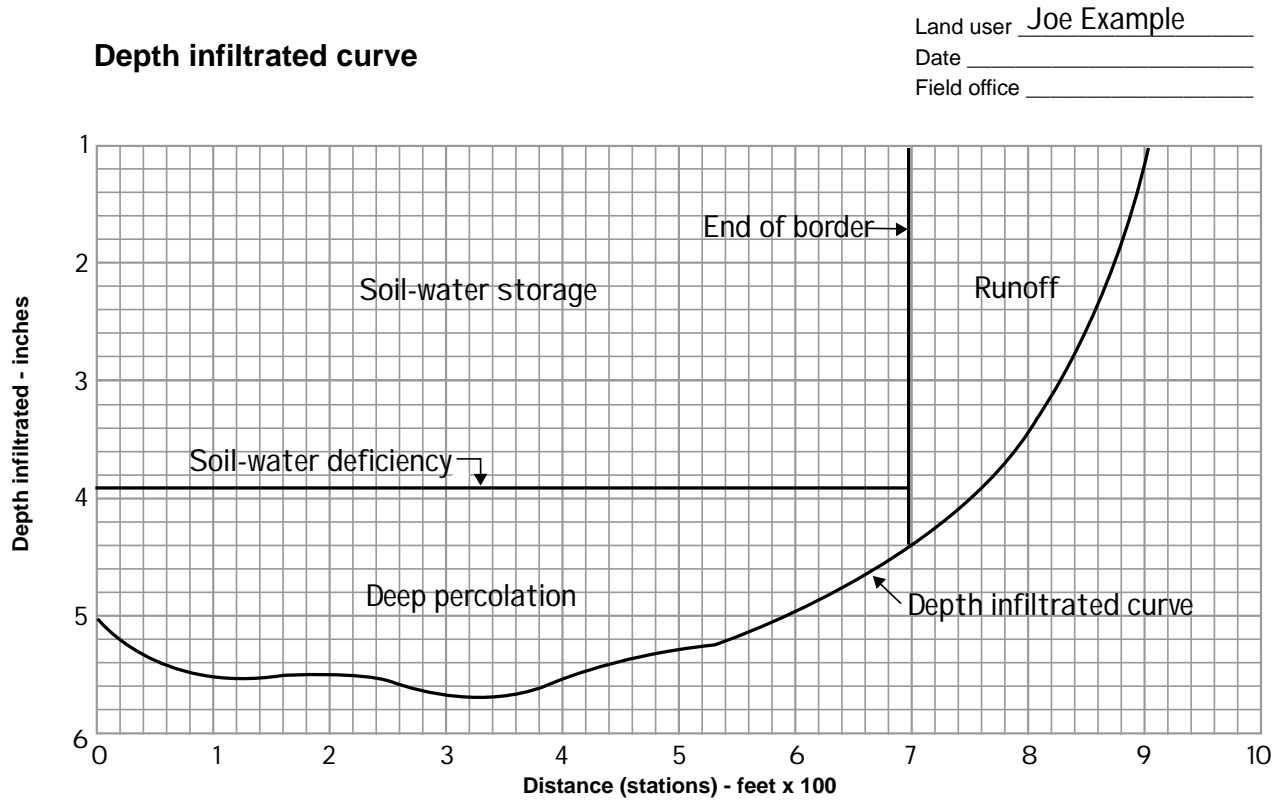

Example 9-2 Evaluation computation steps—Continued**7. Compute irrigation characteristics:**

$$\text{Actual border strip area, acres} = \frac{(\text{actual border length, ft}) \times (\text{wetted width, ft})}{43,560 \text{ ft}^2 / \text{acre}}$$

$$\text{Distribution uniformity low } \frac{1}{4} \text{ DU} = \frac{(\text{Low quarter infiltration area})}{(\text{whole curve area} - \text{runoff area})}$$

where:

DU = distribution uniformity of low quarter

- Total irrigation volume (in acre inches) from the inflow data tabulation:

$$\text{RO} = \frac{(\text{runoff area}) \times 100}{\text{whole curve area}}$$

where:

RO = runoff, %

$$\text{RO depth} = \frac{(\text{total irrigation volume, ac - in}) \times \text{RO}\%}{(\text{actual border strip area, ac}) \times 100}$$

$$\text{DP} = \frac{(\text{deep percolation area}) \times 100}{(\text{whole curve area})}$$

where:

DP = deep percolation depth, %

$$\text{DP depth, inches} = \frac{(\text{total irrigation volume, ac - in}) \times \text{DP}\%}{(\text{actual border strip area, ac}) \times 100}$$

$$\text{F}_g \text{ depth, inches} = \frac{(\text{total irrigation volume, ac - in})}{(\text{actual border strip area, ac})}$$

where:

F_g = gross application depth, in

Example 9-2 Evaluation computation steps—Continued

- Application efficiency (E_a) is the ratio of average depth of water stored in the root zone to gross application depth. In most cases for graded border irrigation, the entire root zone is filled to field capacity by the irrigation. If this is the case, E_a is the ratio of soil water deficit to gross application. Otherwise, it is the ratio of gross application, less runoff to gross application.

$$E_a = \frac{(\text{Ave. depth in root zone, in inches}) \times 100}{(\text{Gross application depth, in inches})}$$

$$E_q = (DU) \times E_a$$

where:

E_q = application efficiency low quarter, %

- 8. Determine the opportunity time required to infiltrate the SWD.** Use the adjusted cumulative intake curve to make your determination.
- 9. Estimate the inflow time required to infiltrate the SWD using the evaluation inflow.** Use an analysis of advance and recession curves and the required irrigation curve to make your estimate.

Potential water conservation and pumping costs savings

- 1. Make a best estimate of the present average net application per irrigation.** This is based on information from the farmer about present irrigation scheduling and application practices and on data generated during the evaluation.
- 2. Compute an estimate of the gross amount of irrigation water used per year.** Use the estimated average net application, average number of annual irrigations (from farmer), and application efficiency determined by the evaluation to compute annual gross:

$$\text{Annual gross water applied} = \frac{(\text{Net applied per irrigation, in}) \times (\text{number of irrigations}) \times 100}{E_a}$$

- 3. Determine annual net irrigation requirements for the crop to be managed.** Use the information in chapter 4 of this guide.
- 4. Determine potential application efficiency (E_{pa}).** Make your determination using information in this guide or from table 4-12, Design efficiency for graded borders, National Engineering Handbook, section 15, chapter 4.

Example 9-2 Evaluation computation steps—Continued**5. Compute potential gross amount to be applied per year:**

$$F_g = \frac{(\text{Annual net irrigation requirement}) \times 100}{E_{pa}}$$

where:

F_g = gross application for year, in

E_{pa} = potential application efficiency, %

6. Compute total annual water conserved (ac-in):

Total annual water conserved:

$$[(\text{Potential gross applied, in}) - (\text{Present gross applied, in})] \times (\text{Area irrigated, ac})$$

7. If pumping cost is a factor, compute cost savings:

- Pumping cost savings: From a separate pumping plant evaluation, determine pumping plant efficiency, kind of fuel, cost per unit of fuel, and fuel cost per acre-inch. Compute fuel cost savings:

$$\text{Fuel Savings} = (\text{Fuel cost per acre inch}) \times (\text{Acre-inches conserved per year})$$

- Water purchase cost savings: Obtain purchase cost data from farmer or water company. Compute as follows:

$$\text{Water cost savings} = \frac{(\text{Cost per acre - foot}) \times (\text{Acre - inches saved per year})}{12}$$

- Compute total potential cost savings:

$$\text{Total potential savings} = \text{Pumping cost savings} + \text{Water cost savings}$$

Analysis of data and preparation of recommendations:

- 1. Compare soil water deficit (SWD) with management allowable depletion (MAD).** This indicates whether the irrigation was correctly timed, too early, or too late.

2. Analyze the advance and recession curves and identify management or system changes that might be made.

- Use the required net application (F_n) from the adjusted cumulative intake curve to determine required opportunity time (T_o).
- Using T_o , draw an ideal recession curve equal to T_o above the advance curve (see example).
- The shape and slope of the recession curve should not change significantly with changes in inflow or duration of flow. By moving the recession curve up or down (changing the time water is applied onto the border strip), required opportunity time can be met at least one point on the curve. To conserve water, minimize runoff, and optimize irrigation efficiency, many irrigators select the point of intersection to be 80 percent of the border length. The lower 20 percent will be under irrigated. If runoff is not a concern, this point of intersection, or management point, can be at the lower end of the border strip.

Example 9-2 Evaluation computation steps—Continued

- Changing inflow rate changes the slope of the advance curve. An estimate of the most efficient flow rate and inflow time can be made as follows:
 - Subtract the required opportunity time (T_o) from the recession time at 0+00. This provides an estimate of the time by which to reduce (or increase) the recession time at the station with the minimum opportunity time.
 - Draw an estimated recession curve parallel to the actual recession curve, equal to the time difference found in the last step.
 - At the downstream end of the border, mark a time, T_o , minutes below the estimated recession curve.
 - Draw an estimated advance curve between 0+00 and the mark made in the last step. This curve should be in about the same shape as the actual advance curve.
 - The actual inflow rate must be determined by trial and error in the field. The amount of change between the actual advance curve and the estimated curve gives some idea of the magnitude of the flow rate change required.
 - To determine required inflow time (T_{in}), subtract the lag time (time between shut off and recession at 0+00) from the required total opportunity time at station 0+00.

Recommendations:

Use field observations, data obtained by discussions with the irrigation decisionmaker, study of the advance recession curves, and data obtained by computations to make practical recommendations. Remember that the data are not exact because of the many variables in soils, crop resistance, slope, and other features. Most effective changes result from a field trial and error procedure based on measured or calculated values. After each new trial, the field should be probed to determine penetration uniformity. Observations can be made to determine the amount of runoff and distribution uniformity. Enough instruction should be given to irrigation decisionmakers so they can observe and take measurements to make necessary adjustments throughout the irrigation season.

Making management changes is always the first increment of change. Recommending irrigation system changes along with appropriate management changes is secondary.

(2) Level borders and basins detailed evaluation

Improving water use efficiency of level border and basin irrigation has great potential for conserving irrigation water and improving downstream water quality. A detailed evaluation provides information for design or to help properly operate and manage a level border irrigation system. It can help the irrigation decisionmaker use proper level border (basin) inflows, lengths of run, and time of inflow for the specific field and crop conditions. Soil intake characteristic has the biggest influence on application uniformity. Intake rate for a specific soil series and surface texture varies from farm to farm, field to field, and throughout the growing season; typically because of the field preparation, cultivation, and harvest equipment. A detailed irrigation system evaluation can tell us the soil intake characteristic for site conditions within a particular field. It can also provide valuable data to support local irrigation guides for planning level border irrigation systems on other farms on similar soils.

(i) Equipment—The equipment for this evaluation includes:

- Engineers level and level rod, 100-foot tape
- Pocket tape marked in inches and tenths/hundredths of feet
- Stakes or flags, marker for stakes or flags
- Flume, weir, or other measuring device to measure inflow
- Carpenters level for setting flume or weir
- Gauge for measuring depth of flow in flow measuring device
- Gallon can(s) or larger for basin stilling well (for windy conditions)
- Soil auger, probe, push type sampler, shovel
- Feel and Appearance Soil Moisture charts, Speedy Moisture Meter/Eley Volumeter, Madera sampler with sample cans, or some other method of determining soil moisture condition
- Level border evaluation worksheets, clipboard, and pencil
- Soils data for field
- Stop watch, camera
- Boots

(ii) Procedures—The field procedures needed to evaluate this system are in two main categories: general and inventory and data collection.

General

Choose a typical basin in the field to be irrigated. The typical location should be representative of the type of soil for which the field is being managed, from an irrigation scheduling standpoint. Use standard soil surveys, where available, to locate border evaluation sites. Then have a qualified person determine the actual surface texture, restricted layers, depth, and other soil characteristics that affect irrigation. Soil surveys are generally inadequate for this level of detail. Almost all mapping units contain inclusions of other soil. Extension of results to other areas also has more reliability. Basin size and configuration should be typical of those in the field. The evaluation should be run at a time when soil moisture conditions are as they will be when irrigation would normally take place.

The field evaluation procedure for basins and level borders uses the whole basin as if it were one large infiltrometer. Inflow volume and volume of water in the basin are measured. Because a small difference in water level in the basin can represent a rather large volume of water, water level changes must be measured accurately.

The field evaluation procedure yields a two-point average intake curve for the basin. The first point on the curve is plotted at the time water is turned off. The second point is defined by plotting the gross application at the average opportunity time. If a more detailed curve is desired or if plot points are desired at earlier times, a cylinder infiltrometer test can be run and plotted (see section 652.0904(g)(1) for procedure). The plotted curve is then adjusted in accordance with the methods described in the procedures for graded border evaluations.

This procedure will use a line of stakes in the direction of water flow; for example, down the center of the level border, to sample opportunity times. In most cases this gives adequate detail for analysis. Water flow in a square basin can be from corner to corner if water enters at a corner.

Typically, values of distribution uniformity and application efficiency of the low quarter cannot be determined exactly because small variations in soil infiltration rate in various parts of the basin and low spots cause appreciable differences in the depth infiltrated. This procedure uses one line of stakes down the basin, which gives an approximation of distribution uniformity. A more refined method of determining distribution uniformity is to stake a complete grid in the basin and determine advance and recession times (and thus time of opportunity) at each grid point. The additional points give more measurements from which to work.

The procedure discussed should be sufficient to provide data for making useful recommendations for modifications in management or the irrigation system. The graded border procedure for evaluation should be used when advance time exceeds half of the opportunity time required to fill the basin. You may be able to roughly determine these times before the evaluation by talking to the irrigator or by observing other basins that have similar soils and inflow. The graded border procedure involves taking cylinder infiltrometer tests and plotting and analyzing advance and recession curves.

Inventory and data collection

Before irrigation starts:

- Get basic information about existing irrigation procedures, concerns, and problems from the irrigation decisionmaker.
- Set stakes or flags at 50- or 100-foot stations down the border. Mark stations on each.
- Take rod readings on the average ground level at each station. Readings should be taken to the nearest 0.05 or 0.01 foot. Take readings at average elevations at each measurement point.
- Set several stilling wells within the level border (basin) for windy conditions.
- Set the measuring device(s) to measure inflow.
- Check the soil water deficit (SWD) at several points in the basin. Use the feel and appearance method, Eley Volumeter/Speedy Moisture Meter, push tube/oven dry, or other acceptable method. For the location chosen as the controlling typical soil, record the SWD data on the evaluation worksheet.

- Make note of soil profile conditions, such as:
 - Depth to water table
 - Apparent root depth of existing or previous crops (for determining effective plant root zone)
 - Soil restrictions to root development; i.e., tillage pans and other compaction layers
 - Mineral layers
 - Hard pans and bedrock
 - Soil textural changes
- Record information about type of delivery system, type and size of turnout(s), width and length of level border or basin.
- Make visual observations of the field including crop uniformity, weeds, erosion problems, crop condition or color changes, and salinity problems. Are there areas receiving too much or not enough water?

During the irrigation:

- Irrigate with the inflow rate normally used by the irrigator and record the start time.
- Check and record the inflow rate several times during irrigation. Record when irrigation ceases (turn-off time).
- Observe advance of the water front across the basin. Record the time water reaches each station. Record the time in 24-hour clock readings. Make this reading as accurately as possible. A small error can make a large difference in water volume. Record readings on the worksheet.
- As soon as water into the basin is turned off, an accurate measurement of water surface elevation in the basin must be determined. This should be done with rod readings to the nearest 0.01 foot. If there is wind or other disturbance in the basin, a stilling well(s) should be set up in the basin to observe water surface elevations. The well can be constructed from a gallon or larger bucket, with the bottom cut out and small holes punched or drilled in the sides below water level. This will buffer wave action. Make sure the measurement location is far enough away from the turnout to not be affected by flow from the turnout. Also, water levels in large basins can vary 0.1 foot or more. Be sure an average water level is used.

-
- Observe the recession of water in the basin. Record the time when water has receded at each of the stations where advance was recorded. Recession should be determined as that time when no more than 10 percent of the water around the station point is still visible on the surface. Some low spots will most likely be in the basin if laser controlled equipment was not used. Sketch the basin showing an outline of areas still containing surface water at the time that 10 percent of the basin still has water on it. This will indicate the leveling uniformity in the basin.
 - Immediately after recession use a probe or auger to check depth of water penetration at several locations in the field. A check at this time will indicate whether water has already percolated too deeply. Typically, the probe penetrates easily where water lubricates the rod and stops abruptly at the wetted front (dry soil). A 3/8-inch diameter steel ball welded onto the point of a 1/4-inch diameter steel rod makes an effective probe.
 - If possible, check for adequacy and uniformity of irrigation at a time when the soil profile has reached the field capacity moisture level. Sandy soils can be checked 4 to 24 hours after irrigation. Clayey soils should be checked about 48 hours after irrigation when most gravitational water has drained. Often a previously irrigated basin with similar conditions can be used.
 - Field capacity must be established. Determine the soil water content when checking for adequacy and uniformity of irrigation.

Exhibit 9-3 shows a completed worksheet for a level border and basin system evaluation. Example 9-3 outlines the steps taken to complete this exhibit.

Exhibit 9-3 Completed worksheet—Surface irrigation system, detailed evaluation of level border and basins

U.S. Department of Agriculture
Natural Resources Conservation Service

Sheet 1 of 6

**Example - Surface Irrigation System Detailed Evaluation
Level Border and Basins Worksheet**

Land user Joe Example Field office _____
Field name/number West 40
Observer _____ Date _____ Checked by _____ Date _____

Field Data Inventory:

Border number 3rd border from west side
Crop Alfalfa Actual root zone depth ^{1/} 5 ft MAD 50 %^{2/}
Stage of crop One week after harvest - 2nd cutting

Soil-water data for controlling soil:

Soil name Lohmiller silty clay
Location of sample Sta. 2+00
Moisture determination method Feel & appearance

Depth	Texture	AWC (in) ^{3/}	SWD (%) ^{4/}	SWD (in)
0-1'	SiC	1.6	60	.96
1-2'	SiC	1.6	50	.80
2-3'	L	2.0	40	.80
3-4'	CL	1.6	40	.64
4-5'	GS	0.5	20	.10
Total		7.3		3.30

MAD = $\frac{(\text{MAD, \%}) \times (\text{total AWC, in inches})}{100} = \frac{50 \times 7.3}{100} = 3.65$ in

Comments about soils: Compost layer at 10 - 14 inches

Typical irrigation duration 2.5 hours, Irrigation frequency 12 days
Annual net irrigation requirements 22 inches, for Alfalfa crop
Typical number of irrigations per year 10
Type of delivery system, describe (earth ditch, concrete ditch, pipeline) Earth ditch

Type and size of turnouts (automated turnout, manual screw gate, alfalfa valve, etc.) Short 24" dia. pipe w/slide gate

Size of basin: Width 250 ft, Length 800 ft

Field Observations:

Crop uniformity Notes
Salinity problems Notes
Other observations Notes

1/ Measure depth of roots of existing or previous crop
3/ AWC = Available water capacity

2/ MAD = Management allowed depletion
4/ SWD Soil water deficit

Exhibit 9-3 Completed worksheet—Surface irrigation system, detailed evaluation of level border and basins—ContinuedU.S. Department of Agriculture
Natural Resources Conservation Service

Sheet 2 of 6

**Example - Surface Irrigation System Detailed Evaluation
Level Border and Basins Worksheet**

1. Basin area (A):

$$A = \frac{\text{Length} \times \text{Width}}{43,560} = \frac{250 \times 800}{46,560} = 4.6 \text{ acres}$$

2. Gross application,
- F_g
- , in inches:

$$F_g = \frac{\text{Total irrigation volume, in ac-in}}{A, \text{ ac}} = \frac{18.9}{4.6} = 4.1 \text{ in}$$

3. Amount infiltrated during water inflow,
- V_i
- :

$$V_i = \text{Gross application} - \text{Depth infiltrated after turnoff} = 4.1 - 1.68 = 2.43 \text{ in}$$

4. Deep percolation, DP, in inches:

$$DP = \text{Gross application} - \text{Soil water deficit, SWD} = 4.1 - 3.3 = 0.8 \text{ in}$$

$$DP, \text{ in } \% = \frac{(\text{Soil water depletion, DP in inches}) \times 100}{\text{Gross application, } F_g} = \frac{0.81 \times 100}{4.1} = 19.8 \%$$

5. Application efficiency,
- E_a
- :

Average depth of water stored in root zone = Soil water deficit, SWD, if the entire root zone average depth will be filled to field capacity by this irrigation.

$$E_a = \frac{(\text{Average depth stored in root zone, } F_n) \times 100}{\text{Gross application, } F_g} = \frac{3.3 \times 100}{4.1} = 80.1 \%$$

6. Distribution uniformity, DU:

$$\begin{aligned} \text{Depth infiltrated low } 1/4 &= (\text{max intake} - \text{min intake}) + \text{min intake} \\ &= \frac{4.5 - 3.75}{8} + 3.75 = 3.84 \end{aligned}$$

$$DU = \frac{\text{Depth infiltrated low } 1/4}{\text{Gross application, } F_g} = \frac{3.84 \times 100}{4.1} = 93.4$$

7. Application efficiency, low 1/4,
- E_q
- :

$$E_q = \frac{DU \times E_a}{100} = \frac{93.4 \times 80.1}{100} = 74.8 \%$$

Exhibit 9-3 Completed worksheet—Surface irrigation system, detailed evaluation of level border and basins—ContinuedU.S. Department of Agriculture
Natural Resources Conservation Service

Sheet 3 of 6

**Example - Surface Irrigation System Detailed Evaluation
Level Border and Basins Worksheet**

1. Present management

Estimated present average net application per irrigation = 3.3 inchesPresent annual gross applied = $\frac{(\text{net applied per irrigation}) \times (\text{number of irrigations}) \times 100}{\text{Application efficiency, low } 1/4, E_q}$

$$= \frac{3.3 \times 10 \times 100}{74.8} \times 100 = 44.1 \text{ in}$$

2. Potential management

Recommended overall irrigation efficiency, E_{des} 80 %Potential annual gross applied = $\frac{\text{Annual net irrigation requirements} \times 100}{E_{des}}$

$$= \frac{22.1 \times 100}{80} = 27.6 \text{ in}$$

3. Total annual water conserved:

= $\frac{(\text{resent gross applied, in} - \text{potential gross applied, in}) \times \text{area irrigated, acres}}{12}$

+ _____ = _____ ac-ft

4. Annual potential cost savings

From pumping plant evaluation: - **NA**

Pumping plant efficiency _____ Kind of fuel _____

Cost per unit of fuel _____ Fuel cost per acre-foot \$ _____

Cost savings = (fuel cost per acre foot) x (water conserved per year, in ac-ft)

$$= \text{_____} \times \text{_____} = \$ \text{_____}$$

Water purchase cost per acre-foot, per irrigation season \$12.00

Water purchase cost savings = (Cost per acre-foot) x (water saved per year, in acre-feet)

$$= 12.00 \times 83 = \$ 996$$

Potential cost savings = pumping cost + water purchase cost = 0 + 996 = \$ 996

Exhibit 9-3 Completed worksheet—Surface irrigation system, detailed evaluation of level border and basins—Continued

U.S. Department of Agriculture
Natural Resources Conservation Service

Sheet 4 of 6

**Example - Surface Irrigation System Detailed Evaluation
Level Border and Basins Worksheet**

Recommendations:

Notes

Exhibit 9-3 Completed worksheet—Surface irrigation system, detailed evaluation of level border and basins—Continued

U.S. Department of Agriculture
Natural Resources Conservation Service

Sheet 5 of 6

**Example - Surface System
Detailed Evaluation Level Border and Basins Worksheet**

Inflow Data

Type of measuring device 36" Trapezoidal sharp crested weir

Clock ^{1/} time	Elapsed time (min)	Δ T (min)	Gage H (ft ³ /s)	Flow rate (ft ³ /s)	Average flow rate (ft ³ /s)	Volume (ac-in) ^{2/}	Cum. volume (ac-in)
Turn on (0705)			.78	6.90			
0710	5	5	.79	7.04	6.97	.5703	.5703
0718	13	8	.80	7.18	7.11	.9402	1.5105
0736	31	18	.84	7.73	7.46	2.2196	3.7301
0805	60	29	.85	7.87	7.80	3.7391	7.4692
0835	90	30	.84	7.73	7.80	3.8680	11.3372
0906	121	31	.83	7.59	7.66	3.9252	15.2624
	150	29			7.59	3.6384	18.9008

Turn off (0935)

		.83	7.59
--	--	-----	------

 Total volume (ac-in) 18.901

Average flow:

Average flow = $\frac{\text{Total irrigation volume, in ac-in}}{\text{Inflow time, in minutes}} \times 60.5 = \frac{18.901 \times 60.5}{150} = 7.62 \text{ ft}^3/\text{s}$

Unit:

$q_u = \frac{\text{Average inflow rate, in ft}^3/\text{s}}{\text{Border spacing}} = \frac{7.62}{250} = 0.03 \text{ ft}^3/\text{s}$

1/ Use a 24-hour clock reading; i.e., 1:30 p.m. is recorded as 1330 hours.

2/ Flow rate to volume factors:

To find volume using ft³/s: volume (ac-in) = .01653 x time (min) x flow (ft³/s)

To find volume using gpm: volume (ac-in) = .00003683 x time (min) x flow (gpm)

Exhibit 9-3 Completed worksheet—Surface irrigation system, detailed evaluation of level border and basins—Continued

U.S. Department of Agriculture
Natural Resources Conservation Service

Sheet 6 of 6

**Example - Surface System Detailed Evaluation
Level Border and Basins Worksheet**

Advance - Recession Data

Station (ft)	Elevation (ft)	Advance time ^{1/} (hr: min)	Recession time ^{1/} (hr: min)	Opportunity time To (min)	Intake ^{2/} (in)	Minimum maximum intake (in)
0+00	49.51	0705	1315	370	4.50	4.50 max.
1+00	49.44	0709	1311	362	4.40	
2+00	49.46	0714	1307	353	4.30	
3+00	49.45	0719	1304	345	4.25	
4+00	49.43	0726	1300	324	4.12	
5+00	49.38	0732	1255	323	4.10	
6+00	49.42	0739	1252	313	3.95	
7+00	49.39	0747	1249	302	3.90	
8+00	49.38	0756	1245	289	3.75	3.75 min.
Total	444.86			2991		

Water surface elevation at water turnoff 49.57 ft ^{3/}

Average field elevation = $\frac{\text{elevation total}}{\text{no. of elevations}} = \frac{444.86}{9} = 49.43$ ft

Depth infiltrated after water turnoff
= (water surface at turnoff - average field elev) x 12
= (49.57 - 49.43) x 12 = 1.68 in

Average opportunity time = $\frac{\text{total opportunity time}}{\text{no. of sample locations}} = \frac{2991}{9} = 332$ min

1/ Use 24-hour clock time. As a minimum, record times at upper end, mid point.
2/ Obtain intake from plotted intake curve.
3/ Water surface elevation should be read to nearest 0.01 ft.

Example 9-3 Evaluation computation steps for level border and basin irrigation systems

1. Determine average field elevations to nearest 0.01 foot.

2. Compute average flow rate data. Use the Inflow Data part of the worksheet to compute the average flow rate based on the flow rate charts for the particular measuring device.

3. Compute the volume in acre-inches for each measurement time interval. Use the equations at the bottom of the inflow data sheets to calculate these values.

4. Determine the total irrigation volume in acre-inches.

5. Calculate the average inflow rate:

$$\frac{(\text{Total irrigation volume, ac - in}) \times 60.5}{\text{Inflow time}}$$

6. Calculate unit flow rate (q_u):

$$q_u = \frac{(\text{Average flow rate, ft}^3 / \text{s})}{(\text{Border spacing, ft})}$$

7. Compute time period between recorded advance and recession times, in minutes. This time is the actual opportunity time (T_o) at each station. Record T_o on the worksheet.

8. Compute the depth infiltrated after water turn-off:

$$(\text{Average water surface elevation at turn-off} - \text{Average field elevation}) \times 12$$

9. Find the average opportunity time for the basin. Average the T_o values for all stations.

10. Compute the area covered by the basin in acres.

11. Compute gross depth of water applied:

$$\frac{(\text{Total irrigation volume, ac - in})}{(\text{Area of basin, acre})}$$

12. Compute amount infiltrated during water inflow:

$$\text{Gross depth of water applied, inches} - \text{Depth infiltration after turnoff, inches}$$

13. Plot a cumulative intake curve on log-log paper (fig. 9-20). The first point is the intersection of inflow time and the amount infiltrated during water inflow. The second point is the intersection of the average opportunity time and the gross application. Draw a straight line through the two points to get the average intake curve for the basin.

Example 9-3 Evaluation computation steps for level border and basin irrigation systems—Continued

Figure 9-20 Soil-water intake curve

Land user Joe Example
 Date 7/25/84
 Location NW1/4,S15,R28E,T2N
 Field office Billings, MT

Soil Water Intake Curves

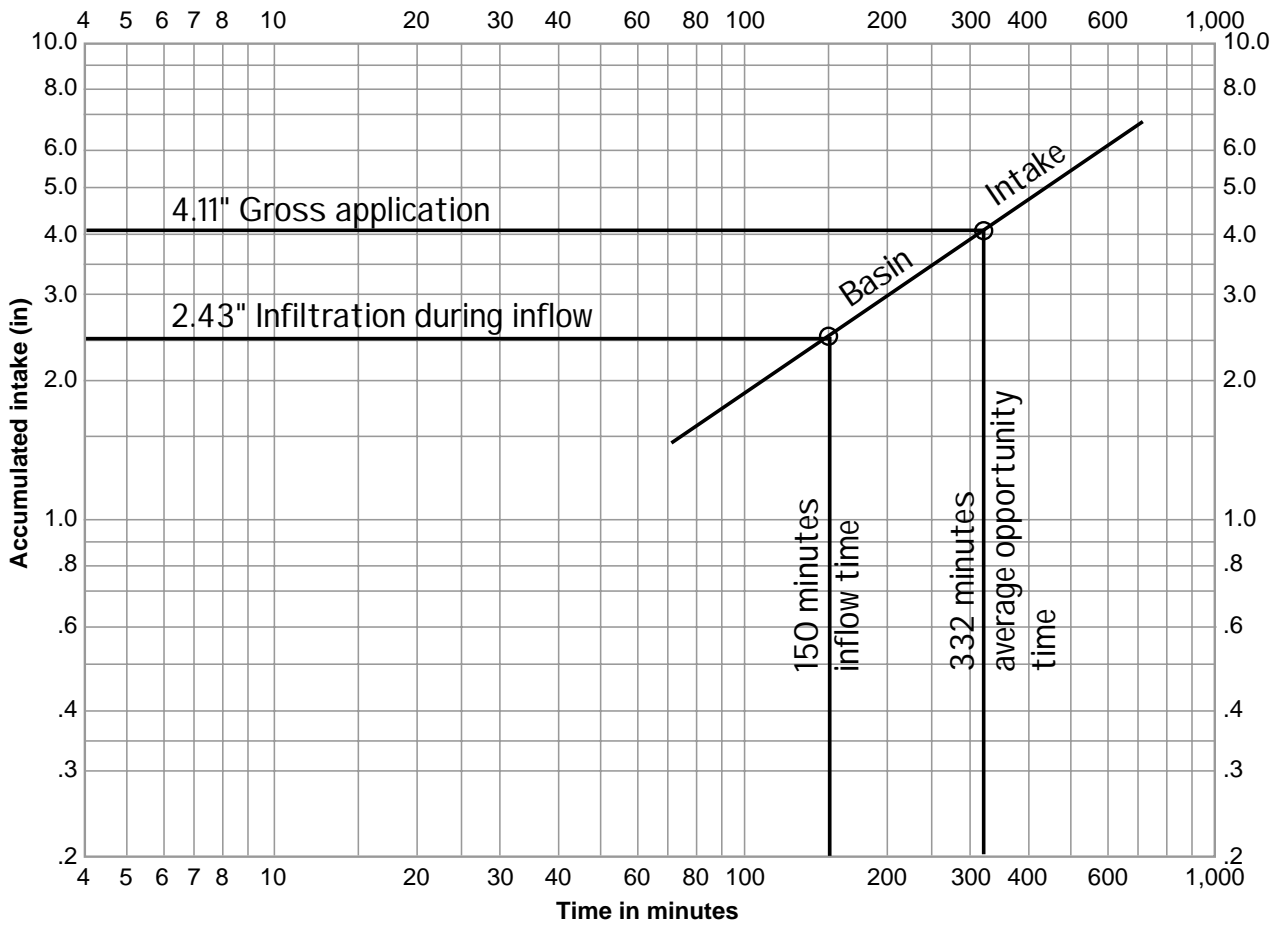

Example 9-3 Evaluation computation steps for level border and basin irrigation systems—Continued**14. Compute deep percolation (DP):**

DP = (Average gross application depth, in inches) – (Soil water deficit, SWD, in inches)

$$DP, \% = \frac{(\text{Deep percolation depth, inches}) \times 100}{(\text{Gross application, inches})}$$

- 15. Compute application efficiency (E_a).** Application efficiency is the ratio of average depth of water stored in the root zone to the gross depth applied. If the entire soil water deficit (SWD) is replaced by the irrigation, then average depth stored in the root zone is equal to the SWD, and the SWD can be used in the calculations. This is often the case with level basin or border irrigation.

$$E_a, \% = \frac{(\text{Ave depth stored in root zone, inches}) \times 100}{(\text{Gross application, inches})}$$

- 16. Determine the intake amounts, in inches.** Using the values of opportunity time (T_o) computed on the Advance-Recession part of the worksheet, determine intake amounts from the intake curve previously plotted. Record these values on the worksheet. Record the maximum and minimum intake amount on the worksheet.

17. Compute the net depth infiltrated (d_n) in the low quarter:

$$\text{Net depth infiltrated, } d_n, \text{ inches} = \frac{(\text{max intake, inches}) - (\text{min intake, inches})}{8} + (\text{min intake, inches})$$

Because of the limited number of sample points, this is a rather rough estimate of net depth infiltrated. A more detailed analysis would involve setting a grid of measured points in the basin.

18. Compute distribution uniformity (DU):

$$DU = \frac{\left(\text{Depth infiltrated low } \frac{1}{4}, \text{ inches} \right)}{(\text{Gross application, inches})}$$

Example 9-3 Evaluation computation steps for level border and basin irrigation systems—Continued**Potential water and cost savings:**

- 1. Make a best estimate of the present average net application per irrigation.** Base your estimate on present irrigation scheduling information, application practices obtained from the irrigation decision-maker, and data derived from the evaluation,
- 2. Compute an estimate of the gross amount of irrigation water used per year.** Use the estimated average net application, average number of annual irrigations (from irrigation decisionmaker), and application efficiency found by this evaluation. Compute as follows:

$$\frac{(\text{Net applied per irrigation, inches}) \times (\text{number of irrigations})}{(\text{Application efficiency, } E_a, \%)} \times 100$$

- 3. Using the irrigation guide, determine annual net irrigation requirements for the crop to be managed.**
- 4. Determine potential application efficiency (E_{pa}).** Use the information in this guide or the chart for estimating efficiency, National Engineering Handbook, section 15, chapter 4 to make your determination.
- 5. Compute potential gross amount to be applied per year.** Gross amount applied, in inches:

$$\frac{(\text{Annual net irrigation requirement, inches}) \times 100}{(\text{Potential application efficiency, } E_{pa}, \%)}$$

- 6. Compute total annual water conserved.** Acre-feet conserved:

$$\frac{(\text{Present gross applied, inches} - \text{Potential gross applied, inches}) \times (\text{Area irrigated, acres})}{12}$$

- 7. If cost is a factor, compute cost savings:**

Pumping cost savings: From a separate pumping plant evaluation, determine pumping plant efficiency, kind of fuel, cost per unit of fuel, and fuel cost per acre-inch. Compute fuel cost savings:

$$(\text{Fuel cost per acre foot}) \times (\text{Acre feet conserved per year})$$

Water purchase cost savings: Obtain purchase cost data from irrigation decisionmaker or water company. Compute as follows:

$$(\text{Cost per acre foot}) \times (\text{Acre feet saved per year})$$

Total potential cost savings: Pumping cost + water cost = Total potential savings.

Example 9-3 Evaluation computation steps for level border and basin irrigation systems—Continued**Analysis of data and preparation of recommendations:**

1. Compare soil water deficit (SWD) with Management allowed deficit (MAD). This indicates whether the irrigation was correctly timed, too early, or too late, and if the correct amount of water was applied.
2. If the basin can be covered in about a fourth of the time needed to irrigate it fully, the adverse effect of unequal opportunity time (T_o) values at various locations within the border will be minimum. If inflow time to cover the basin exceeded a fourth of the opportunity time, determine if there are ways to decrease the inflow time, such as to increase flow rate or decrease basin size.
3. Consider changes that should be made in set time and irrigation scheduling.
4. Consider the need for releveling or changing the basin's size or shape, or both. Experience has shown laser controlled equipment to be superior, especially during final grading. Also with annual crops, annual laser leveling touch up helps maintain the field in an as designed condition and costs no more than releveling every 3 to 4 years.

Use field observations, data obtained by discussion with the irrigation decisionmaker, and data obtained by computations to make some practical recommendations. Remember that the data are not exact. There are many variables. Flow rate changes and other changes result from a trial-and-error procedure. After each new trial the field should be probed to determine water penetration. Enough instruction should be given to operators so they can make these observations and adjustments.

Making management changes is always the first increment of change. Recommending irrigation system changes along with appropriate management changes is secondary.

(3) Graded furrow detailed evaluation

Improving water use efficiency of furrow irrigation has great potential for conserving irrigation water and improving downstream water quality. An abbreviated method of evaluation was presented earlier in this section. A detailed evaluation can determine onsite intake characteristics and provide information for design or to help operate and manage (fine tune) a graded furrow irrigation system. It can help the irrigation decisionmaker use proper furrow inflows, lengths of run, and time of inflow for the specific field and crop conditions.

Soil intake characteristics have the biggest influence on application uniformity. Soil intake rate for a specific soil series and surface texture varies from farm to farm, field to field, within each field, and throughout the irrigation season because of tillage, harvest, and the equipment used. A detailed irrigation system evaluation can identify what the soil intake characteristics are for the site conditions at a particular field. It can also provide valuable data to support local irrigation guides for planning graded furrow irrigation systems on other farms on similar soils.

See American Society of Agricultural Engineer Standard ASAE EP419.1, Evaluation of Irrigation Furrows, for an overall volume balance approach to furrow evaluation.

Observations of the operating condition of delivery system and furrows should be made and recommendations provided for solving any problems. The observation should include:

- Is erosion occurring? head cutting at lower end of furrow? at outlet of siphon or gated pipe? at grade changes? Can erosion problems be solved with conservation treatment measures, such as reduced tillage, no-till, mulching, vegetative strips, crop rotation, or incorporating PAM in the water supply?
- Is sedimentation occurring as a result of furrow erosion? If so, is it occurring in furrow or in tailwater collection ditch?
- Is suspended sediment in irrigation water causing reduced water infiltration as fine material settles out?

- Is trash or debris in water supply causing plugging of siphon tubes or gated pipe outlets, resulting in uneven flow to furrows? Are gates opened excessively wide to allow trash to pass through, resulting in excessive inflow to furrows?
- Is subsurface drainage system operating satisfactorily? Is salinity management satisfactory?
- Are facilities to control surface runoff in place and working properly?

(i) Equipment—The equipment needed for a detailed graded furrow system evaluation includes:

- Engineers level and rod, 100 foot tape
- Pocket tape marked in inches and tenths/hundredths of feet
- Stakes, lath or wire flags for station identification
- Flow measuring devices for measuring furrow inflow and outflow (When measuring furrow inflow where gated pipe or siphons are used, pressure or head differential can be determined and flows calculated. A short piece of clear, small diameter tubing can be used to measure head on outlets in gated pipe. With siphons, tube length and head differential between inlet and outlet can be measured and standard discharge tables used to determine discharge.)
- Carpenters level for setting flumes or weirs
- Equipment for determining soil moisture content, such as feel and appearance charts, Speedy moisture meter and Eley Volumeter, or Madera sampler and soil moisture sample cans)
- Calibrated container for measuring flow if siphon tubes are used
- Soil auger or push tube probe and shovel
- Clipboard, worksheets or evaluation forms, pencil
- Soils data for field
- Watch
- Rubber boots

(ii) Procedure—The field procedures needed for an evaluation of this type system include:

Site location— Choose a site location in the field to be irrigated. The typical location should be representative of the kind of soil for which the entire field is managed. The site should allow measurement of runoff. The evaluation should be run at a time when soil moisture conditions are similar to conditions when irrigation would normally be accomplished.

Furrows— Furrows to be evaluated should have a uniform cross section and a uniform grade between the inflow and outflow measuring points. Inflow and outflow points can be anywhere within the field where it is convenient to obtain flow measurements. At least three adjacent furrows or furrow groups should be measured at each test site. Adjacent furrows on each side of the test area should be irrigated simultaneously for a total of five furrows irrigated. Evaluate wheel rows as well as nonwheel rows. This generally occurs where three adjacent rows are selected; however, there may be two wheel rows and one nonwheel row or two nonwheel rows and one wheel row.

The entire furrow length should be evaluated; however, if time for a full length of run evaluation is not available, partial length rows can be evaluated. The minimum evaluation length for field evaluations should be 200 to 300 feet for high intake soils and 500 to 600 feet for low intake soils. Because of soil variability, shorter lengths, typically 100 to 200 feet, are used to derive values for preparing local irrigation guides. Lengths of 30 to 50 feet are used when using the flowing furrow infiltrometer method.

The steps to follow during the detailed evaluation are:

Step 1—Obtain information from the irrigation decisionmaker about the field and how it is irrigated; i.e., irrigation set time, how many rows set, typical flow advance rate and total time, adjustments made to furrow inflow during irrigation set time, number of irrigations per season, tillage pattern, and equipment. Field observations include identifying furrow erosion and sediment deposition areas, crop color differences in different parts of the field, crop uniformity, salinity and wet areas, and drainage system operation.

Step 2—Set flags or lath stakes at 100-foot stations down the selected furrows (set flags only in the middle furrow). Identify stations on each flag, lath, or stake. Do not walk in the furrows to be evaluated. Determine field elevations at each station, and plot furrow profile. Record furrow spacing (center of ridge to center of ridge) and furrow cross section. Measure the cross section with a straightedge and pocket tape or cross section board.

Step 3—Set measuring flumes, orifice plates, or other flow measuring devices at the upper and lower end of each furrow or reach to be evaluated. If there is

ponded water at the lower end of the field, locate the lower measuring station upstream of the backwater.

Step 4—Estimate soil water deficit using incremental depths throughout the root zone at several locations along the furrow. Use the feel and appearance charts, Speedy Moisture Meter, or some other highly portable method. Select one location as being typical of furrows irrigated and record data for that location on the worksheet.

Step 5—Note soil profile conditions as you are recording soil water deficit data (step 4). Conditions to consider include:

- Depth to water table (if within 5 feet of soil surface)
- Actual plant root depth, root development pattern of existing or previous crop, and restrictions to normal root development
- Compacted layers and mineral layers
- Mineral layers
- Hardpans or bedrock
- Soil textures including textural change boundaries (abrupt or gradual)
- Salinity levels and soil layers of salt accumulation

Field procedure for inventory and data collection:

Step 1—Start furrow inflow with the flow rate normally used by the irrigator and record start time. Time permitting, three different flow levels (high, medium, and low inflow rates) should be used in different test sections to determine effect of using higher or lower furrow inflows.

Step 2—At 5- to 10- minute intervals, check the inflow rate of the test section until it reaches a constant rate. Record the flow rate and time of measurement each time the flow is checked. Periodically during the evaluation check the flow rate and record it. Frequent checks should be made if the flow rate fluctuates considerably.

Step 3—Observe the furrow for erosion or overtopping. Estimate the maximum usable stream size. For new furrows, loose soil often muddies the water at first, but is not considered to be erosion. Also, some erosion often occurs at each turnout, but the furrow stream becomes stable after a short time. Looking closely at the bottom of the furrow when water is

flowing will indicate if movement of soil particles is causing rilling to occur or is just reshaping of the furrow cross section. If erosion is occurring, is there an opportunity to use PAM?

Step 4—Record the time water reaches each station. Record the time runoff starts at each outflow measuring location. Periodically measure the flow rate and record the rate and time of measurement until it ceases.

Step 5—Record the time when water is turned off at the head end of the field. In many cases the water disappears from the furrow relatively uniformly throughout the length of the furrow. In these cases only the time water is shut off and the time water disappears at each furrow station need to be recorded. Nonuniform soil infiltration causes recession timing to be erratic, so use your best estimate.

Step 6—Before leaving the field, use a ball probe or auger to check depth of water penetration at several locations along the length of the furrows. Suggested locations are 1/3 and 2/3 points and at 80 percent of the total furrow length. A check at this time indicates the depth that the water has already penetrated. Another check 24 to 36 hours later will indicate the final depth of water movement. An estimate of final depth can be made using a previous irrigation set on the same soil. Check for adequacy and uniformity of irrigation when the soil profile is at or near field capacity moisture level. A visit the next day may be necessary to observe wetted depth(s) in the soil profile within the area evaluated. Time for free drainage of most gravitational water should be allowed. Sandy soils can be checked a few hours after irrigation. Medium textured soils usually take about 24 hours after irrigation, and clayey soils take about 48 hours.

Step 7—Check the wetted soil bulb for a recently irrigated furrow and record the information. A trench dug across the furrow (stem to stem) is recommended. Also, it is very productive to have the irrigation decisionmaker present when viewing the trench. This is a good time to discuss what is happening in the soil profile, especially if there are restrictive layers (which there usually are). You need to observe the following:

- Location and shape of wetted bulb
- Actual root development pattern and location
- Restrictive layers to root development and water movement penetration; i.e., tillage pans

If it is desirable to establish or check soil moisture at field capacity condition, determine the soil water content or collect samples when checking for adequacy of the irrigation.

(iii) Evaluation computations—The information gathered in the field procedures is used in the detailed system evaluation computations. Example 9-4 outlines the computations used to completed the Surface Irrigation System Detailed Evaluation Graded Furrow Worksheet (exhibit 9-4).

Exhibit 9-4 Completed worksheet—Surface irrigation system, detailed evaluation of graded furrow system

U.S. Department of Agriculture
Natural Resources Conservation Service

Sheet 1 of 10

**Example - Surface Irrigation System Detailed Evaluation
Graded Furrow Worksheet 1**

Land user Joe Example Field office _____
 Field name/number _____
 Observer _____ Date _____ Checked by _____ Date _____

Field Data Inventory:

Show location on evaluation furrows on sketch or photo of field.

Crop Corn Actual root zone depth 4 MAD ^{1/} 50 % MAD 3.9 in
 Stage of crop 24" Planting date (or age of planting) _____
 Field acres 100

Soil-water data:

(Show location of sample on soil map or sketch of field)

Soil moisture determination method Feel and appearance
 Soil mapping unit Haverson loam Surface texture Loam

Depth	Texture	AWC (in) ^{1/}	SWD (%) ^{1/}	SWD (in) ^{1/}
<u>0-8"</u>	<u>L</u>	<u>1.4</u>	<u>60</u>	<u>.84</u>
<u>8-48"</u>	<u>FSL</u>	<u>6.4</u>	<u>40</u>	<u>2.56</u>
_____	_____	_____	_____	_____
_____	_____	_____	_____	_____
_____	_____	_____	_____	_____
		Total <u>7.8</u>		<u>3.4</u>

Comments about soils: Notes

Typical irrigation duration 11 hours, Irrigation frequency 14 days
 Typical number of irrigations per year 8
 Crop rotation Notes

Field uniformity condition (smoothed, leveled, laser leveled, etc., and when) Notes

1/ MAD = Management allowable depletion AWC = Available water capacity SWD = Soil water deficit

Exhibit 9-4 Completed worksheet—Surface irrigation system, detailed evaluation of graded furrow system—Continued

U.S. Department of Agriculture
Natural Resources Conservation Service

Sheet 2 of 10

**Example - Surface Irrigation System Detailed Evaluation
Graded Furrow Worksheet 2**

Cultivation no.	Date	Crop stage	Irrigate?
1	6/25	12"	No
2	7/25	24"	Yes
3	_____	_____	_____
4	_____	_____	_____
5	_____	_____	_____

Delivery system size (pipe diameters, gate spacing, siphon tube size, etc.) 10" diameter
gated pipe w/30" spacing on outlet

Field observations

Evenness of advance across field Notes

Crop uniformity _____

Soil condition _____

Soil compaction (surface, layers, etc.) _____

Furrow condition _____

Erosion and/or sedimentation: in furrows _____
head or end of field _____

Other observations (OM, cloddiness, residue, plant row spacing, problems noted, etc.) _____

Furrow spacing 30 inches

Furrow length 1300 feet

Irrigations since last cultivation None

Furrow profile (rod readings or elevations at each 100 foot. station):

5.4	6.9	7.9	8.9	9.2	9.7	10.4	11.4	12.0	12.6	13.1	14.0
0	1	2	3	4	5	6	7	8	9	10	11
15.6	16.6	17.0									
12	13	14									

Furrow cross section:

Station: _____

Station: _____

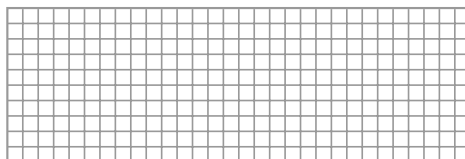
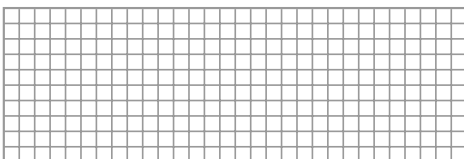

Exhibit 9-4 Completed worksheet—Surface irrigation system, detailed evaluation of graded furrow system—Continued

U.S. Department of Agriculture
Natural Resources Conservation Service

Sheet 3 of 10

**Example - Surface Irrigation System Detailed Evaluation
Graded Furrow Worksheet 3**

Furrow data summary:

Evaluation length 1300 Slope .005 to .016 ft/ft Average .0127

Section through plant root zone:

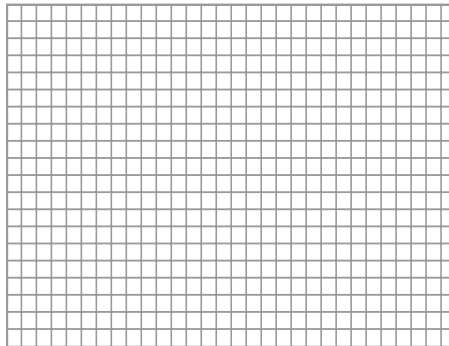

Evaluation computations

Furrow area, A = (furrow evaluation length, L, ft) x (furrow spacing, W, ft)
43,560 ft²/acre

$$A = \frac{1300 \times 2.5}{43,560} = .0746 \text{ acre}$$

Present gross depth applied, $F_g = \frac{\text{Total inflow volume, gal.} \times .0000368}{\text{Furrow area, A, in acres}}$ (Total inflow from worksheet 7)

$$F_g = \frac{13,762 \times .0000368}{0.0746} = 6.8 \text{ inches}$$

Minimum opportunity time, $T_{ox} = 474$ min at station 13+00 (from field worksheet 10)

Minimum depth infiltrated, $F_{min} = 3.4$ inches (from worksheet 10)

Average depth infiltrated, $F_{(0-1)} = 3.8$ (from calculations on worksheet 10)

Distribution uniformity, $DU = \frac{\text{Minimum depth infiltrated, inches}}{\text{Average depth infiltrated, inches}} \times 100 = \frac{F_{min} \times 100}{F_{ave}}$

$$= \frac{3.4 \times 100}{3.8} = 89.5 \%$$

Exhibit 9-4 Completed worksheet—Surface irrigation system, detailed evaluation of graded furrow system—Continued

U.S. Department of Agriculture

Sheet 4 of 10

Natural Resources Conservation Service

**Example - Surface Irrigation System Detailed Evaluation
Graded Furrow Worksheet 4**

$$\text{Runoff, RO\%} = \frac{\text{Total outflow volume, gal} \times 100}{\text{Total inflow volume, gal}} = \frac{6,248 \times 100}{13,762} = 45.4 \text{ \% (Total outflow, worksheet 8)}$$

(Total inflow, worksheet 7)

$$\text{RO, in} = \frac{\text{Total outflow volume, gal} \times 0.0000368}{\text{Evaluation furrow area, A, in acres}} = \frac{6,248}{.0746} \times 0.0000368 = 3.1 \text{ in (Furrow area, worksheet 3)}$$

$$\text{Deep percolation, DP, in} = \text{Average depth infiltrated} - \text{Soil moisture deficit, SMD (Ave. depth worksheet 10 and SMD worksheet 1)}$$

$$\text{DP} = 3.8 - 3.4 = 0.40 \text{ in}$$

$$\text{Deep percolation, DP, \%} = \frac{\text{Deep percolation, DP, in} \times 100}{\text{Gross depth applied, } F_g, \text{ inches}} = \frac{0.4 \times 100}{6.8} = 5.9 \text{ \%}$$

Application efficiency, E_a

$$E_a = \frac{\text{Ave depth stored in root zone}^* \times 100}{\text{Gross application, } F_g, \text{ inches}} = \frac{3.4 \times 100}{6.8} = 50 \text{ \%}$$

*Average depth of water stored in root zone = SWD if entire root zone depth is filled to field capacity by this irrigation. If irrigation efficiency is to be used in place of application efficiency, use average depth of water beneficially used (i.e., all infiltrated depths less than or equal to SWD) plus any other beneficial uses.

Exhibit 9-4 Completed worksheet—Surface irrigation system, detailed evaluation of graded furrow system—Continued

U.S. Department of Agriculture
Natural Resources Conservation Service

Sheet 5 of 10

Example - Surface Irrigation System Detailed Evaluation Graded Furrow Worksheet 5

Potential water and cost savings

Present management

Estimated present gross net application, F_g per irrigation = 6.8 inches (F_g from worksheet 3)

Present gross applied per year = Gross applied per irrigation, F_g x number of irrigations

$$= \underline{6.8 \times 8} = \underline{54.4} \text{ inches}$$

Potential management

Annual net irrigation requirement 20.6 inches, for corn (silage) (crop)

Potential application efficiency, E_{pa} = 70 %

Potential annual gross applied = $\frac{\text{Annual net irrigation req.} \times 100}{\text{Potential application efficiency, } E_{pa}}$

$$= \frac{\underline{20.6 \times 100}}{\underline{70}} = \underline{29.4} \text{ inches}$$

Total annual water conserved = $\frac{(\text{present gross applied} - \text{potential gross applied}) \times \text{area irrigated, ac}}{12}$

$$= \frac{(\underline{54.4} - \underline{29.4}) \times 100}{\underline{12}} = \underline{208} \text{ acre feet}$$

Exhibit 9-4 Completed worksheet—Surface irrigation system, detailed evaluation of graded furrow system—Continued

U.S. Department of Agriculture
Natural Resources Conservation Service

Sheet 6 of 10

**Surface Irrigation System
Detailed Evaluation Graded Furrow Worksheet 6**

Annual cost savings

Water cost

= Cost per acre foot x acre feet saved per year = _____

= \$ _____

Cost savings = Pumping cost + water cost = _____ = \$ _____

Fuel cost savings = (fuel cost per ac-ft) x (ac-ft conserved per year) = _____ = _____

Recommendations Further improvement can be gained by reducing length of run
by half. New inflow rate and time of irrigation would then need to be determined.

Consider automated surge valves.

Exhibit 9-4 Completed worksheet—Surface irrigation system, detailed evaluation of graded furrow system—Continued

U.S. Department of Agriculture
Natural Resources Conservation Service

Sheet 7 of 10

**Example - Surface Irrigation System Detailed Evaluation
Furrow Worksheet 7**

Data: Furrow number 1 Inflow X Outflow _____

Type of measuring device 1" Parshall flume

Clock 1/ time	Elapsed time (min)	Δ T (min)	Gage H (ft)	Flow rate (gpm)	Average flow rate (gpm)	Volume 2/ (gal)	Cum. volume (gal)
Turn on 0630	0		0	0			
0645	15	15	.240	16.6	8.3	125	125
0700	30	15	.240	16.6	16.6	249	374
0800	90	60	.245	17.5	17.1	1,026	1,400
0900	150	60	.250	19.3	18.4	1,104	2,504
1100	270	120	.300	23.3	21.3	2,556	5,060
1300	390	120	.320	26.0	24.7	2,964	8,024
1500	510	120	.300	23.3	24.7	2,964	10,988
1700	630	120	.285	21.5	22.4	2,688	13,676
1708	638	8	0	0	10.8	86	13,762

Total volume 13,762 gallon

1/ Use a 24-hour clock reading; i.e., 1:30 p.m. is recorded as 1330 hours.

2/ Volume = Δ T x average flow rate

Average flow rate = $\frac{\text{Total irrigation volume, gallon}}{\text{Elapsed time, minute}} = \frac{13,762}{638} = 21.6$ gpm

Exhibit 9-4 Completed worksheet—Surface irrigation system, detailed evaluation of graded furrow system—Continued

U.S. Department of Agriculture
Natural Resources Conservation Service

Sheet 8 of 10

**Example - Surface Irrigation System Detailed Evaluation
Furrow Worksheet 8**

Data: Furrow number 1 Inflow _____ Outflow X

Type of measuring device 1" Parshall flume

Clock 1/ time	Elapsed time (min)	Δ T (min)	Gage H (ft)	Flow rate (gpm)	Average flow rate (gpm)	Volume 2/ (gal)	Cum. volume (gal)
0915	0		0	0			
0930	15	15	.112	5.1	2.6	39	39
0945	30	15	.146	7.6	6.4	96	135
1030	75	45	.165	9.3	8.5	383	518
1130	135	60	.183	11.1	10.2	612	1,130
1330	255	120	.200	12.5	11.8	1,416	2,546
1530	375	120	.230	15.5	14.0	1,680	4,226
1700	465	90	.260	18.8	17.2	1,548	5,774
1710	475	10	.27	19.9	19.4	194	5,968
1718	503	28	0	0	10.0	280	6,248
						Total volume	6,248

1/ Use a 24-hour clock reading; i.e., 1:30 p.m. is recorded as 1330 hours.

2/ Volume = Δ T x average flow rate

$$\text{Average flow rate} = \frac{\text{Total irrigation volume, gallon}}{\text{Elapsed time, minute}} = \frac{6,248}{503} = 12.4 \text{ gpm}$$

Exhibit 9-4 Completed worksheet—Surface irrigation system, detailed evaluation of graded furrow system—Continued

U.S. Department of Agriculture
Natural Resources Conservation Service

Sheet 9 of 10

**Example - Surface Irrigation System Detailed Evaluation
Furrow Worksheet 9**

Intake Curve Plotting Data

Opportunity time at time "T"						Intake at time "T"			
Clock time		Inflow time		Outflow time		Opportunity time T _o ^{5/} (min)	Cumulative inflow volume V _{in} ^{6/} (gal)	Cumulative Outflow volume V _{out} ^{6/} (gal)	Intake F ₀₋₁ ^{7/} (in)
(hr-min) ^{1/}	T (hr)	Start ^{2/} (hr)	T1 ^{3/} (hr)	Start ^{2/} (hr)	T2 ^{4/} (hr)				
0915	9.25	6.5	2.75	9.25	0	83	2,824	0	2.0
0945	9.75	6.5	3.25	9.25	.5	113	3,463	135	2.5
1030	10.5	6.5	4.0	9.25	1.25	158	4,421	518	3.0
1130	11.5	6.5	5.0	9.25	2.25	218	5,801	1,130	3.7
1330	13.5	6.5	7.0	9.25	4.25	338	8,765	2,546	5.0
1530	15.5	6.5	9.0	9.25	6.25	458	11,660	4,226	6.1
1700	17.0	6.5	10.5	9.25	7.75	548	13,676	5,774	6.5

- 1/ Use a 24-hour clock reading for collection of field data; i.e., 1:30 p.m. is 1330 hours. Use decimal hours for inflow and outflow times.
- 2/ Time at which inflow or outflow starts in decimal hours (worksheet 7-8)
- 3/ Inflow time: T1 = "T" - inflow start time (worksheet 7)
- 4/ Outflow time: T2 = "T" - outflow start time (worksheet 8)
- 5/ Opportunity time (minutes): T_o = 30 (T1 + T2)
- 6/ Cumulative inflow and outflow volumes (worksheet 7-8). If data were not recorded for time T, interpolate the inflow or outflow.

Surface storage and wetted perimeter for length of furrow with water in it.

L = length of furrow with water in it, ft (worksheet 3) = 1300

S = average furrow slope, ft/ft (worksheet 3) = .0127

n = Mannings "n" (usually 0.04 for furrows, 0.10 for corrugations) = .04

Q_{av} = average inflow rate, gpm (worksheet 7) = 21.6

Surface storage: $V_s = L \left[0.09731 \left(\frac{Q_{av} \times n}{S^5} \right)^{.7567} + 0.00574 \right]$ = 583

Wetted perimeter: $P = 0.2686 \left(\frac{Q_{av} \times n}{S^5} \right)^{.4247} + 0.7462$ = 1.38

7/ Intake plotting point:

V_{in} = Cumulative inflow (gal) from worksheet 7

V_{out} = Cumulative outflow (gal) from worksheet 8

V_s = Surface storage (gal) in length of furrow with water in it

$$F_{0-1} = \frac{1.604 (V_{in} - V_{out} - V_s)}{L \times P}$$

Exhibit 9-4 Completed worksheet—Surface irrigation system, detailed evaluation of graded furrow system—Continued

U.S. Department of Agriculture
Natural Resources Conservation Service

Sheet 10 of 10

**Example - Surface Irrigation System Detailed Evaluation
Furrow Worksheet 10**

Furrow advance/recession data

Station (ft)	Advance time			Recession time			Total elapsed time ^{3/}	Opportunity time (T _o) ^{2/} (min)	Intake in wetted perimeter (in) ^{4/}	Intake in furrow width (in)
	Clock time ^{1/}	Δ T (min)	Elapsed time T _t (min)	Clock time ^{1/}	Δ T (min)	Elapsed time T _r (min)				
0+00				Turn off (1705)			635	Inflow T (635)		
0+00	Turn on (0630)		0		Lag (3)	0	635			
0+00				1708		3	638	638	7.5	4.1
1+00	0635	5	5	1713	5	8	643	638	7.5	4.1
2+00	0644	9	14	1716	3	11	646	632	7.4	4.1
3+00	0658	14	28	1719	3	14	649	621	7.3	4.0
4+00	0711	13	41	1721	2	16	651	610	7.2	4.0
5+00	0724	13	54	1724	3	19	654	600	7.2	4.0
6+00	0742	18	72	1727	3	22	657	585	7.1	3.9
7+00	0755	13	85	1728	1	23	658	573	7.0	3.8
8+00	0806	11	96	1729	1	24	659	563	6.9	3.8
9+00	0821	15	111	1731	2	26	661	550	6.8	3.7
10+00	0840	19	130	1733	2	28	663	533	6.6	3.7
11+00	0900	20	150	1734	1	29	664	514	6.5	3.6
12+00	0917	17	167	1735	1	30	665	498	6.3	3.5
13+00	0944	27	194	1738	3	33	668	474	6.1	3.4
							Totals	8029	97.4	

T_i = 635 minutes

1/ Use a 24-hour clock reading; i.e., 1:30 p.m. is 1330 hours.
3/ Time since water was turned on.

2/ T_o = T_i - T_t + T_r
4/ Interpolated from graph, furrows volume curve

Average opportunity time = $\frac{\text{total opportunity time}}{\text{number of stations}} = \frac{8029}{14} = 574$ minutes

Average depth infiltrated in wetted perimeter, F_{wp}:
F_{wp} = $\frac{\text{total intake in wetted perimeter}}{\text{number of stations}} = \frac{97.4}{14} = 7.0$ inches

Average depth infiltrated in tested length of furrow, F₀₋₁:
F₀₋₁ = $\frac{F_{wp} \times P}{W} = \frac{7.0 \times 1.38}{2.5} = 3.8$ inches

Example 9-4 Evaluation computation steps for graded furrow irrigation systems

1. Plot the furrow profile on cross section paper (fig. 9-21).

Figure 9-21 Furrow profile

U.S. Department of Agriculture
National Resources Conservation Service

**Example - Surface Irrigation System Detailed Evaluation
Furrow Worksheet 11**

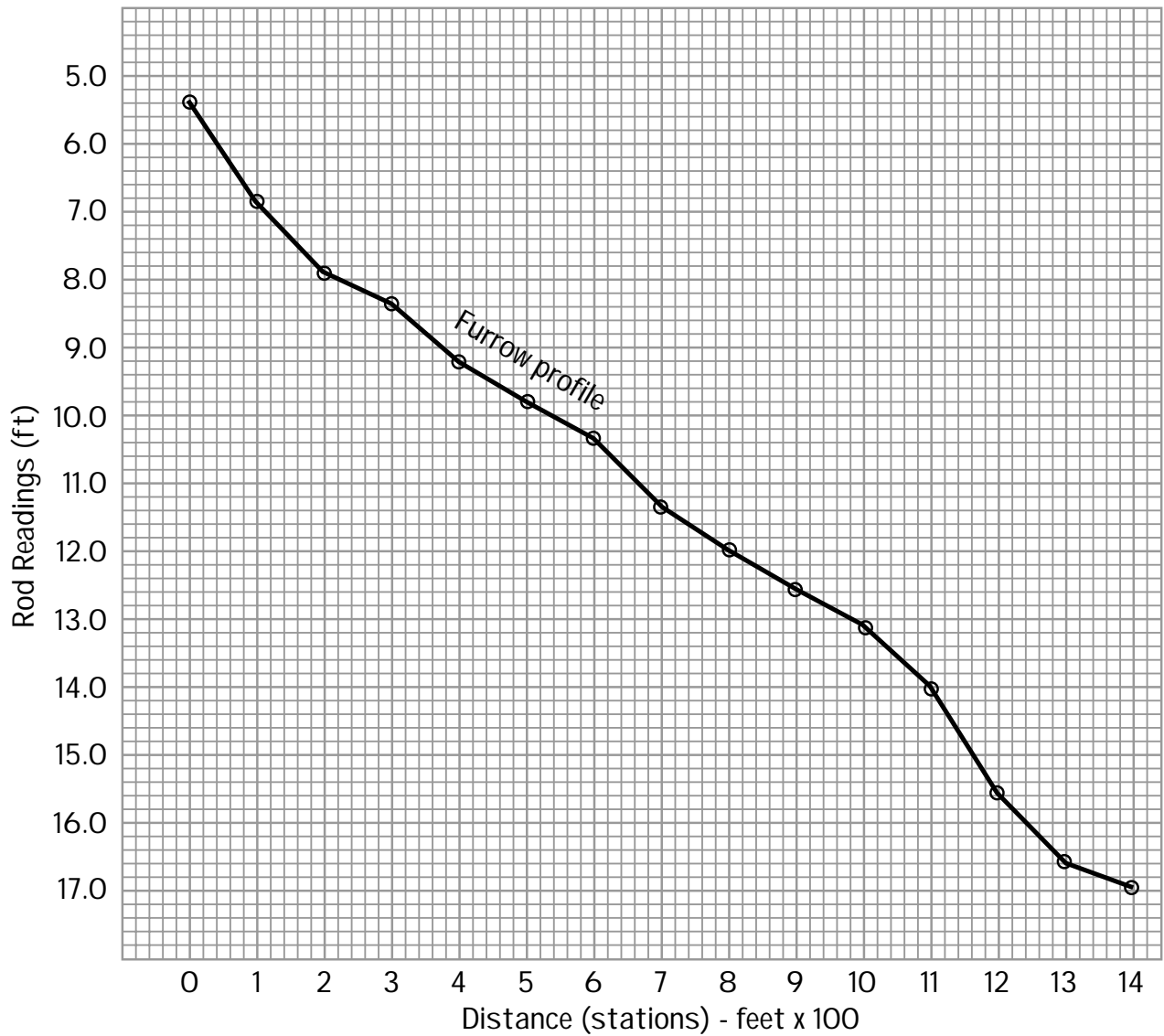

Example 9-4 Evaluation computation steps for graded furrow irrigation systems—Continued

2. **Compute the soil water deficit (SWD) at each station (worksheet 1).** This is the net depth of water required to refill the plant root zone to field capacity. In arid areas, it typically is needed for the evaluation irrigation. In humid areas, some soil water storage can be reserved for anticipated rainfall events (i.e., 1 inch).
3. **Complete the calculation of opportunity times at each station (worksheet 10).** Use the Advance Recession part of the evaluation worksheet 10. Plot (fig. 9-22).

Figure 9-22 Advance recession curve

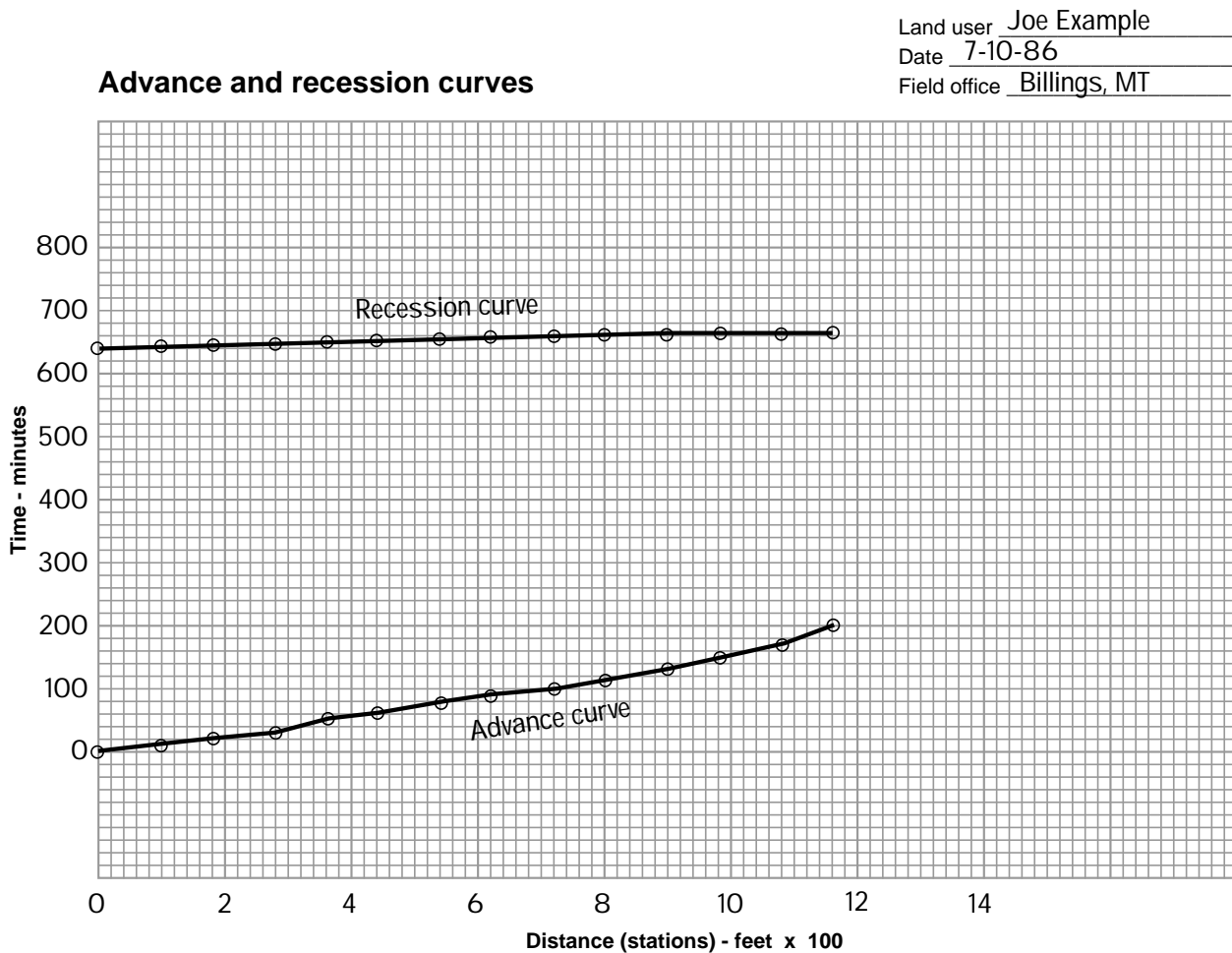

Example 9-4 Evaluation computation steps for graded furrow irrigation systems—Continued

4. **Plot both advance and recession curves from worksheet 10 on the worksheet provided or on cross section paper, figure 9-22.** If recession times for the entire length of furrow were not recorded, plot a straight horizontal line at the average elapsed time when water disappears from the furrow.
5. **Complete the computations for the inflow and outflow data worksheets 7-8.** Plot inflow and outflow volume curves (fig. 9-23) using elapsed time and cumulative volume columns. Offset outflow time by the time difference between start of inflow and outflow. Compute average flow rate for each furrow for both inflow and outflow.

Figure 9-23 Flow volume curves

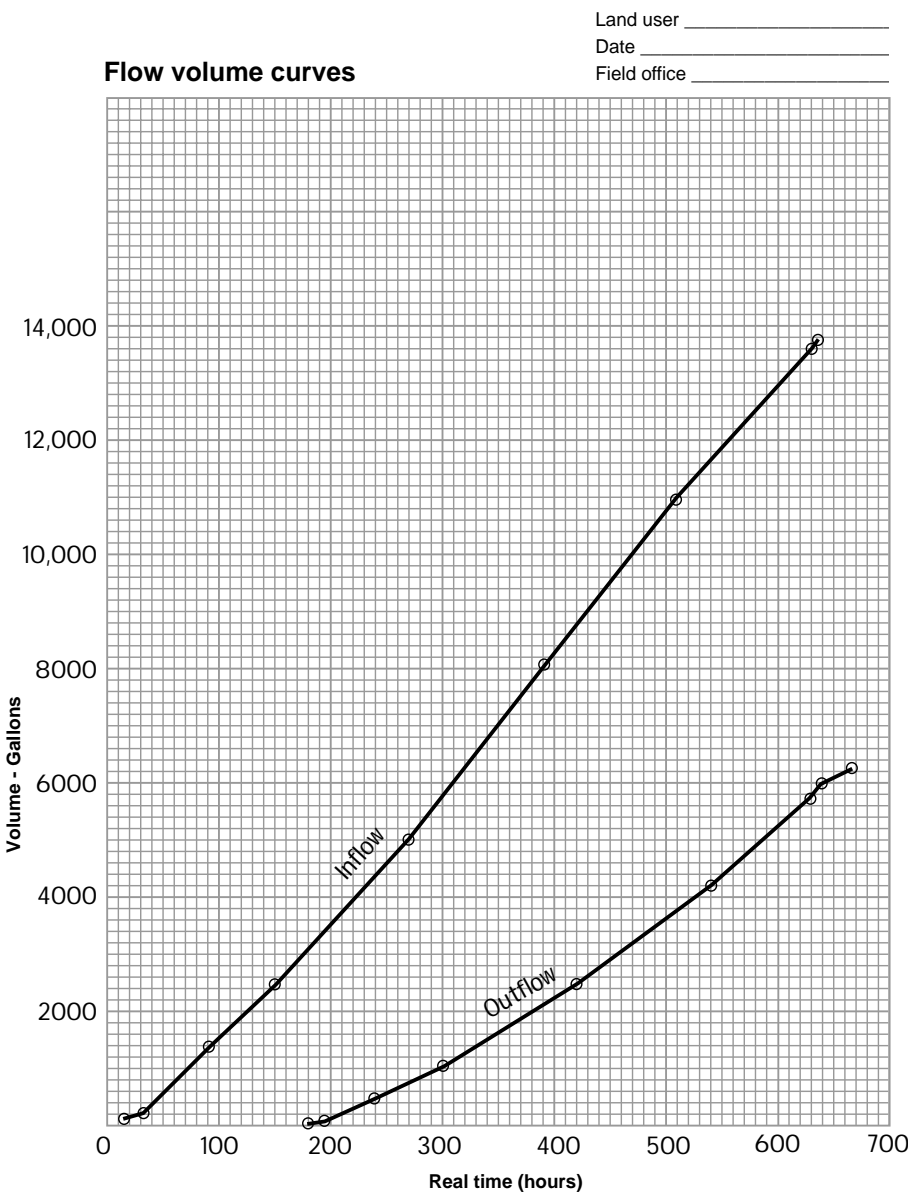

Example 9-4 Evaluation computation steps for graded furrow irrigation systems—Continued

6. **Complete the Furrow Intake Characteristic Curve Input Data Worksheet 9.** Use the data on the advance-recession and the inflow-outflow data sheets. Get cumulative inflow and outflow values from plot of flow volume curves (fig. 9-23) or interpolate from data on worksheets 7-8). Follow the instructions on the sheet for doing the calculations. Computation examples are given in NEH Section 15, Chapter 5, Furrow Irrigation, for full furrow length and partial furrow length evaluations.
7. **Plot intake curve data T_o and $F_{0.1}$ from worksheet 9 on two cycle log-log paper (fig. 9-24).** Draw a best fit line through the plotted points. Compare this line to standard furrow intake characteristic (family) curves (Chapter 2, Soils, fig. 2-4).

Figure 9-24 Soil water intake curves

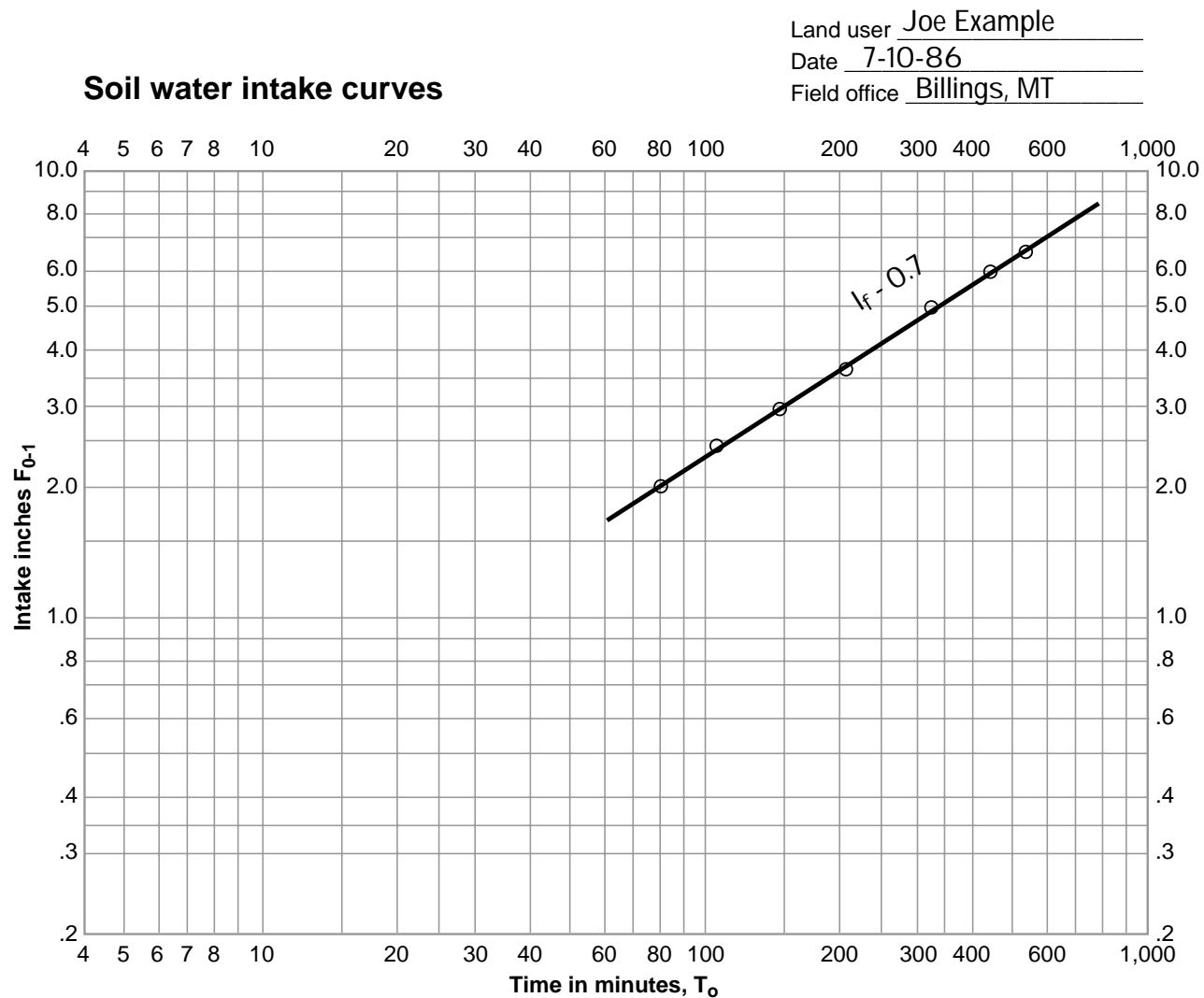

Example 9-4 Evaluation computation steps for graded furrow irrigation systems—Continued

- 8. Determine water depth infiltrated at each station** (worksheet 10). Use the opportunity time at each station (computed on the advance-recession worksheet) and the cumulative intake curve to make your determination. Record the depth infiltrated in the next to the last column of the worksheet. This is the depth infiltrated within the wetted perimeter of the furrow.
- 9. Correct the wetted perimeter intake at each station**(worksheet 10). The wetted perimeter intake at each station must be corrected to account for furrow spacing and representative field area. Multiply the wetted perimeter intake by the ratio of wetted perimeter (P) (worksheet 9) to furrow spacing (W) (worksheet 2). Enter the result in the last column of the advance-recession worksheet 10.
- 10. Compute the average opportunity time, T_o** (worksheet 10):

$$\text{Ave. } T_o = \frac{\text{total opportunity}}{\text{number of stations}}$$

- 11. Compute the average depth of water infiltrated within the wetted perimeter, F_{wp}** (worksheet 10):

$$F_{wp} = \frac{\text{total intake in wetted perimeter}}{\text{number of stations}}$$

- 12. Compute the average intake for the area represented by the furrow spacing.** (worksheet 10)

$$F_{ave} = \frac{F_{wp} \times P}{W}$$

- 13. Compute the furrow area for the evaluation reach (acres)** (worksheet 3):

$$A = \frac{(\text{evaluation furrow length, ft}) \times (\text{furrow spacing } W, \text{ ft})}{43,560 \text{ ft}^2 / \text{ac}}$$

- 14. Compute present gross application depth, F_g , in inches** (worksheet 3):

$$\text{Present } F_g = \frac{(\text{total inflow volume, gal}) \times (.0000368)}{A (\text{furrow area, acres})}$$

- 15. Determine the location(s) along the furrow where the minimum opportunity time (T_{ox}) occurred** (worksheet 3). Use the furrow advance and recession information (worksheet 10) to make the determinations. Record the minimum time.
- 16. Determine minimum depth infiltrated, F_{min}** (worksheet 3). Use the minimum opportunity time from worksheet 10.
- 17. Enter average depth infiltrated, F_{ave} on worksheet 3** (from worksheet 10).
- 18. Compute furrow distribution uniformity, DU** (worksheet 3):

Example 9-4 Evaluation computation steps for graded furrow irrigation systems—Continued

Absolute minimum is often used instead of low quarter, as in other methods of irrigation. Absolute minimum is the ratio of minimum depth infiltrated to average depth infiltrated. However, to compare the furrow surface irrigation system to other irrigation systems, low quarter distribution uniformity should be used.

$$DU_{\min}, \% = \frac{(\text{minimum depth infiltrated, } F_{\min}, \text{ inches})}{\text{average depth infiltrated, } F_{\text{ave}}, \text{ inches}} \times 100$$

To compare irrigation methods:

$$DU\% = \frac{\text{low } \frac{1}{4} \text{ infiltrated}}{\text{average depth infiltrated, inches}}$$

19. Compute runoff, RO (worksheet 4):

$$RO, \% = \frac{\text{total outflow volume, gal}}{\text{total inflow volume, gal}} \times 100 \quad (\text{outflow from worksheet 8, inflow from worksheet 7})$$

$$RO, \text{in} = \frac{\text{total outflow volume, gal} \times 0.0000368}{A, (\text{furrow area, acres})}$$

20. Compute deep percolation, DP:

$$DP, \text{inches} = [(\text{average depth infiltrated, inches}) - (\text{soil water deficit, inches})] \quad (\text{depth worksheet 10 \& SMD worksheet 1})$$

$$DP \% = \frac{\text{deep percolation, inches}}{F_g, (\text{gross depth applied, inches})} \times 100 \quad (F_g \text{ from worksheet 3})$$

21. Compute application efficiency, E_a (%). Average depth of water stored in root zone is equal to the soil water deficit if entire root zone depth will be filled to field capacity by this irrigation; otherwise, use F_g minus RO, in inches.

$$E_a = \frac{\text{ave depth stored in root zone, inches}}{F_g, (\text{gross depth applied, inches})} \times 100$$

If *irrigation efficiency* is to be used in place of *application efficiency*, use average depth of water beneficially used (all water infiltrated depths less than or equal to SWD plus any other beneficial uses).

Example 9-4 Evaluation computation steps for graded furrow irrigation systems—Continued**Potential water conservation and pumping costs savings**

- 1. Use the present gross application per irrigation (F_g , worksheet 3) and number of irrigation and enter on worksheet 5.** Base your estimation on information about present irrigation scheduling and application practices obtained from the irrigation decisionmaker and on data derived from the evaluation.
- 2. Determine the annual net crop and other irrigation requirement and potential application efficiency.** Use the irrigation guide for potential efficiency and crop need. Enter on worksheet 5.
- 3. Compute potential annual gross water applied on worksheet 5:**

$$\text{Potential annual gross water applied, inches} = \frac{(\text{annual net crop and other irrigation requirement, inches})}{E_{pa} (\text{potential application efficiency, \%})} \times 100$$

- 4. Compute total annual water conserved (ac-ft):**

$$\text{Total annual water conserved} = \frac{(\text{present gross applied, in} - \text{potential gross applied in}) \times A (\text{area irrigated, ac})}{12}$$

- 5. If cost is a factor, compute cost savings on worksheet 6:**

Pumping costs savings: From a separate pumping plant evaluation, determine pumping plant efficiency, kind of fuel, cost per unit of fuel, fuel cost per acre foot. Compute fuel cost savings:

$$\text{Fuel cost savings} = (\text{fuel cost per ac-ft}) \times (\text{ac-ft conserved per year})$$

Water purchase costs savings: Obtain purchase cost data from farmer. Compute as follows:

$$\text{Water cost savings} = (\text{water cost per ac-ft}) \times (\text{water conserved per year, ac-ft})$$

Compute total cost savings.

Example 9-4 Evaluation computation steps for graded furrow irrigation system—Continued**Analysis of data and preparation of recommendations:**

1. Compare soil water deficit with management allowable depletion (MAD). This indicates whether the irrigation was correctly timed, too early, or too late.
2. Analyze the advance and recession curves and changes that might be made to improve irrigation uniformity.

Recommendations:

Use field evaluation observations, data obtained by discussion with the irrigation decisionmaker, study of advance-recession curves, and data obtained by computations to make practical recommendations. Remember that the measured and calculated data are not exact. This is mainly because soils vary and there are many other uncontrollable variables. Changes should be made with a trial-and-error procedure. After each new trial the field should be probed to determine water penetration. Observations should be made to determine furrow runoff and distribution. Enough instruction and training should be given irrigation decisionmakers so they can make observations and provide the necessary adjustments.

(4) Contour ditch irrigation detailed evaluation

Improving efficiency of contour ditch irrigation has a great potential for conserving water. Application efficiencies of 10 to 25 percent are common. Potential efficiencies with properly designed, maintained, and managed systems can be 30 to 50 percent. As an example, improving application efficiency from 10 to 40 percent where a net seasonal requirement of 17 inches is met, can conserve 10.6 acre-feet of water per irrigated acre.

Exact values for distribution uniformity and application efficiencies are impractical to determine because of difficulties in measuring depth infiltrated at representative locations in the field. The depth infiltrated varies widely throughout the irrigated area. The following procedure gives an approximation of those factors that are useful in making decisions about changes that might be made to a system or its management.

Choose a typical portion of the field to be irrigated. The site should have a representative soil type and be managed from a scheduling standpoint. If possible, the area irrigated should receive water from an individual turnout without water intermingling from other turnouts. The size and shape of the area irrigated should be typical of the size and shape of areas irrigated in the field.

If water is intermingled from adjacent turnouts during preceding and succeeding sets, estimating or making onsite determinations of the adjacent water opportunity time is necessary at each grid point. Grid point opportunity times are explained in the procedure.

The evaluation should be run at a time when soil moisture conditions are similar to those when irrigation would normally be initiated.

(i) Equipment—The equipment needed for a contour ditch irrigation system includes:

- Two 100-foot tapes (or one 100-foot tape and transit to lay out grid)
- Stakes or flags and marker for stakes or flags
- Flumes, weirs, or other measuring devices for measuring inflow and outflow
- Carpenters level for setting flumes or weirs
- Cylinder infiltrometer set with hammer and hammer plate (minimum 4 rings)

- Hook gauge and engineering scale for infiltrometer
- Equipment for determining soil moisture amounts (feel and appearance charts, Speedy Moisture Meter and Eley volumeter or Madera sampler, and soil moisture sample cans)
- Buckets to supply infiltrometer with water
- Soil auger, push tube sampler, probe, shovel
- Evaluation worksheets, aerial photo of field, clipboard, and pencil
- Watch, camera, boots
- Soils data for field

(ii) Procedures—The field procedures needed for evaluation of this type system are in two categories: general, and inventory and data collection.

General

Step 1—Before irrigation is started:

- Get basic information about existing irrigation procedures, concerns, and problems from the irrigator.
- Select a turnout that irrigates an area representative of areas irrigated from turnouts in the field. If at all possible, select an area where runoff can be measured.
- Stake a grid in the basin to be irrigated. Grid spacing should be such that it defines significant undulations on the irrigated surface. The entire area irrigated from the turnout should be covered.
- Sketch the location of ditches, turnouts, location of measuring devices, and the field grid on a grid sheet as illustrated in figure 9–25.
- Set measuring devices to measure inflow and outflow.
- Set three to five cylinder infiltrometers in carefully chosen typical locations within the area to be irrigated. A location near the supply ditch will be the most convenient for providing water for infiltrometer cylinders. See discussion in section 652.0905, Determining soil intake.
- Check the soil water deficit (SWD) at several grid points in the irrigated area. Use feel and appearance, Eley volumeter/speedy moisture meter, push tube/oven (Madera sampler), or some other method. For the location chosen as the controlling typical soil, record the SWD data on the evaluation worksheet.

- At the same time, make note of soil profile conditions, such as:
 - Depth to water table
 - Apparent root depth and rooting pattern of existing or previous crop
 - Soil or compaction layers restrictive to root development and water movement
 - Mineral layers
 - Hardpans and bedrock
 - Soil textural changes

Step 2—Field observations. Make visual observations of the field including crop uniformity, weeds, erosion problems, crop condition or color changes, and wet areas.

Inventory and data collection

During the irrigation:

- Irrigate with the flow rate normally used by the irrigation decisionmaker and record the start time.
- Check and record the flow rate several times during inflow. Record the turnoff time.
- Observe advance of the water front across the irrigated area. On the map of the area, sketch the position of the water front at six or eight time intervals. Using 24-hour clock readings, record the time when the front reaches each station. An uneven advancing front line indicates location of high and low areas.
- Fill the infiltrometer cylinders when the leading edge of water reaches them. (An alternative is to build dams around the infiltrometers and pour water in the dams at the same time water is poured into the infiltrometers.) Record infiltrometer readings at times shown on the infiltrometer worksheets.
- Record when runoff starts and stops. Check and record runoff several times during the runoff period.
- Observe the recession of the water in the area. On the map of the area, sketch the position at six or eight time intervals. Record the time on each line. These lines should be of contrasting color or type to distinguish them from the advance line.
- Immediately after recession, use a probe or auger to check depth of penetration at several locations in the area. A check at this time indicates the depth that water has already percolated.

- If overlap between irrigation sets has occurred or may occur, the combined opportunity time must be determined for the adjacent sets at those points where overlap is experienced.
- If possible, check for adequacy and uniformity of irrigation at a time when the soil profile has reached field capacity. Sandy soils can be checked 4 to 24 hours after irrigation. Clayey soils should be checked about 48 hours after irrigation when most gravitational water has drained.
- If it is necessary to establish field capacity, determine the soil water content when checking for adequacy and uniformity of irrigation.

(iii) Evaluation computations—The information gathered in field procedures is used in detailed system evaluation computations. Example 9-5 outlines the computations used to complete the Contour Ditch Irrigation System Detailed Evaluation Worksheet (exhibit 9-5).

Figure 9-25 Ditches, turnouts, measuring devices, and field grid for example site

Land user Joe Example

Date _____

Field office _____

Advance - recession sketch

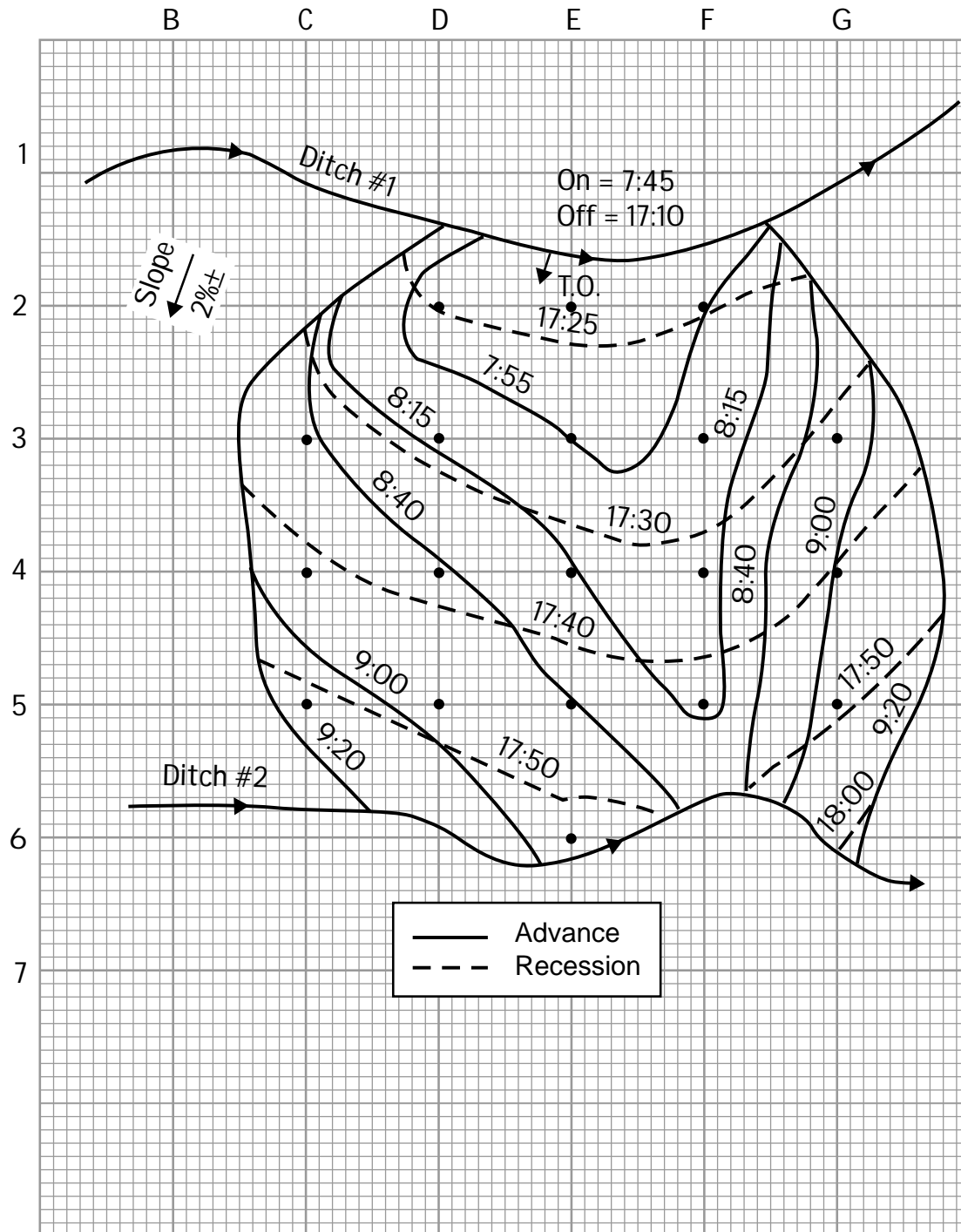

Exhibit 9-5 Completed worksheet—Surface irrigation system, detailed evaluation of contour ditch irrigation system

U.S. Department of Agriculture
Natural Resources Conservation Service

Sheet 1 of 6

**Example - Surface Irrigation System
Detailed Evaluation Contour Ditch Irrigation System Worksheet**

Land user Joe Example Field office _____
Field name/number #10
Observer _____ Date _____ Checked by _____ Date _____

Field Data Inventory:

Field size 50 acres
Crop _____ Root zone depth 4 ft MAD ^{1/} 50 % MAD ^{1/} 4.1 in
Stage of crop 3 weeks other harvest - very dry

Soil-water data:

(Show location of sample on grid map of irrigated area.)

Soil moisture determination method Feel & apperance
Soil series name Fort Collins loam

Depth	Texture	AWC ^{2/} (in)	SWD ^{3/} (%)	SWD ^{3/} (in)
0-4"	L	.72	100	.72
4-20"	CL	2.64	80	2.11
20-48"	CL	4.90	70	4.43
Total		8.26		6.26

Comments about soils: Notes

Typical irrigation duration 7 hr, irrigation frequency 14-20 days
Typical number of irrigations per year 5 +/-

Type of delivery system, (earth ditch, concrete ditch, pipeline) earth head ditch

Method used to turn water out (shoveled opening, wood box turnout, siphon tubes, portable dams, concrete checks with check boards, etc.) wood turnouts

1/ MAD = Management allowable depletion
2/ AWC = Available water capacity
3/ SWD = Soil water deficit

Exhibit 9-5 Completed worksheet—Surface irrigation system, detailed evaluation of contour ditch irrigation system
—ContinuedU.S. Department of Agriculture
Natural Resources Conservation Service

Sheet 2 of 6

**Example - Contour Ditch Irrigation System
Detailed Evaluation Worksheet****Field observations**Crop uniformity NotesWet and/or dry area problems NotesErosion problems NotesOther observations Notes**Evaluation computations**Irrigated test area (from grid map) = (20.0 in²) x (.2296 in²/ac) = 4.6 ac

Actual total depth infiltrated, inches:

Depth, inches = $\frac{(\text{Irrigated volume, ac-in}) - (\text{Runoff volume, ac-in})}{(\text{Irrigated area, acres})}$ Depth, inches = $\frac{49.03 - 6.32}{4.6} = 9.31$ inGross application, F_g , inches: $F_g = \frac{(\text{Total inflow volume, ac-in})}{(\text{Irrigated area, acres})} = \frac{49.03}{4.6} = 10.68$ in

Distribution uniformity low 1/4 (DU):

DU = $\frac{(\text{Average depth infiltrated (adjusted) low 1/4, inches})}{(\text{Average depth infiltrated (adjusted), inches})}$ DU = $\frac{9.02 \times 100}{9.4} = 96$

Runoff, RO, inches:

RO, inches = $\frac{(\text{Runoff volume, ac-in})}{(\text{Irrigated area, ac})} = \frac{6.32}{4.6} = 1.38$ inRO, % = $\frac{(\text{Runoff depth, inches}) \times 100}{(\text{Gross application, } F_g, \text{ inches})} = \frac{1.38 \times 100}{10.68} = 12.9$ %

Exhibit 9-5 Completed worksheet—Surface irrigation system, detailed evaluation of contour ditch irrigation system
—ContinuedU.S. Department of Agriculture
Natural Resources Conservation Service

Sheet 3 of 6

**Example - Contour Ditch Irrigation System
Detailed Evaluation Worksheet**

Deep percolation, DP, inches:

DP, inches = (Gross applic. F_g , inches) - (Runoff depth, RO, inches) - (Soil water deficit, SWD, inches)

$$DP, \text{ inches} = \frac{10.68 - 1.38 - 6.26}{1} = 3.04 \text{ inches}$$

$$DP, \% = \frac{(\text{Deep percolation, DP, inches}) \times 100}{(\text{Gross application, } F_g, \text{ inches})} = \frac{3.04 \times 100}{10.68} = 28.5 \%$$

Application efficiency (E_a):

(Average depth replaced in root zone = Soil water deficit, SWD, inches)

$$E_a\% = \frac{(\text{Average depth replaced in root zone, inches}) \times 100}{(\text{Gross application, } F_g, \text{ inches})} = \frac{6.26 \times 100}{10.68} = 58.6 \%$$

Potential water and cost savings

Present management:

Estimated present average net application per irrigation = 5.0 inches

Present gross applied per year = $\frac{(\text{Net applied per irrigation, inches}) \times (\text{no. of irrigations}) \times 100}{(\text{Application efficiency, } E_a, \text{ percent})}$

$$\text{Present gross applied per year} = \frac{5.0 \times 5 \times 100}{58.6} = 43.0 \text{ inches}$$

Potential management

Annual net irrigation requirement: 13.0 inches, for alfalfa (crop)

Potential application efficiency, E_{pa} : 60 % (from irrigation guide or other source)Potential annual gross applied = $\frac{(\text{annual net irrigation requirement, inches}) \times 100}{(\text{Potential application efficiency, } E_{pa}, \text{ percent})}$

$$\text{Potential annual gross applied} = \frac{13.0 \times 100}{60} = 21.7 \text{ inches}$$

Total annual water conserved:

= $\frac{(\text{Present gross applied, inches}) - (\text{Potential gross applied, inches}) \times \text{Area irrigated, ac}}{12}$

$$= \left(\frac{43.0 - 21.7}{12} \right) \times (4.59) = 8.15 \text{ acre-feet}$$

Exhibit 9-5 Completed worksheet—Surface irrigation system, detailed evaluation of contour ditch irrigation system
—Continued

U.S. Department of Agriculture
Natural Resources Conservation Service

Sheet 4 of 6

**Example - Contour Ditch Irrigation System Detailed
Evaluation Worksheet**

Cost savings:

Pumping plant efficiency _____ percent, Kind of energy _____

Cost per unit of fuel _____ Fuel cost per acre foot _____

Cost savings = (Fuel cost per acre foot) x (Acre inches conserved per year)
= _____

Water purchase cost:

= (Cost per acre foot) x (Acre feet saved per year) =

= (_____) x (_____) = _____

Cost savings = (Pumping cost) + (Water cost) = (_____) + (_____) = _____

Recommendations

Notes

Exhibit 9-5 Completed worksheet—Surface irrigation system, detailed evaluation of contour ditch irrigation system
—Continued

U.S. Department of Agriculture

Sheet 5 of 6

Natural Resources Conservation Service

**Example - Contour Ditch Irrigation System
Detailed Evaluation Worksheet**

Inflow X Outflow _____

Type of measuring device _____

Clock ^{1/} time	Elapsed time (min)	Δ T (min)	Gauge H (ft)	Flow rate (ft ³ /s)	Average flow rate (ft ³ /s)	Volume ^{2/} (ac-in)	Cum. volume (ac-in)
Turn on 0745			1.33	4.75			
0755	10	10	1.36	4.92	4.84	.80	.80
0810	25	15	1.38	5.03	4.98	1.23	2.03
0930	105	80	1.40	5.14	5.09	6.73	8.76
1030	165	60	1.42	5.25	5.20	5.16	13.92
1130	225	60	1.44	5.37	5.31	5.27	19.19
1230	285	60	1.41	5.19	5.28	5.24	24.43
1330	345	60	1.42	5.25	5.22	5.18	29.61
1430	405	60	1.43	5.31	5.28	5.24	34.85
1530	465	60	1.44	5.37	5.34	5.30	40.15
1730	565	100	1.44	5.37	5.37	8.88	49.03

Total volume (ac-in) 49.03

Average flow = Total irrigation volume in (ac-in) = $\frac{49.03}{.01653 \times 565}$ = 5.25 ft³/s

1/ Use a 24-hour clock reading; i.e., 1:30 p.m. is recorded as 1330 hours.

2/ Flow rate to volume factors:

To find volume using ft³/s:

Volume (ac-in) = .01653 x time (min) x flow (ft³/s)

To find volume using gpm:

Volume (ac-in) = .00003683 x time (min) x flow (gpm)

Exhibit 9-5 Completed worksheet—Surface irrigation system, detailed evaluation of contour ditch irrigation system
—Continued

U.S. Department of Agriculture
Natural Resources Conservation Service

Sheet 5 of 6

**Example - Contour Ditch Irrigation System
Detailed Evaluation Worksheet**

Inflow _____ Outflow X

Type of measuring device 3" Parshall flume

Clock ^{1/} time	Elapsed time (min)	Δ T (min)	Gauge H (ft)	Flow rate (ft ³ /s)	Average flow rate (ft ³ /s)	Volume ^{2/} (ac-in)	Cum. volume (ac-in)
Turn on 0830			.20	.082			
0915	45	45	.28	.138	.11	.082	.082
1015	105	60	.44	.279	.209	.207	.289
1115	165	60	.48	.319	.229	.297	.586
1215	225	60	.50	.339	.329	.326	.912
1315	285	60	.52	.361	.350	.347	1.259
1415	345	60	.54	.382	.392	.369	1.628
1515	405	60	.55	.393	.388	.385	2.013
1615	465	60	.57	.415	.404	.401	2.414
1715	525	60	.59	.438	.427	.423	2.837
1750	560	35	.59	.438	.219	.127	2.964
			0	0			

Total volume (ac-in) 2.964

Average flow = Total irrigation volume in (ac-in) = $\frac{2.964}{.01653 \times 565}$ = 0.32 ft³/s

1/ Use a 24-hour clock reading; i.e., 1:30 p.m. is recorded as 1330 hours.

2/ Flow rate to volume factors:

To find volume using ft³/s:

Volume (ac-in) = .01653 x time (min) x flow (ft³/s)

To find volume using gpm:

Volume (ac-in) = .00003683 x time (min) x flow (gpm)

Exhibit 9-5 Completed worksheet—Surface irrigation system, detailed evaluation of contour ditch irrigation system
—ContinuedU.S. Department of Agriculture
Natural Resources Conservation Service

Sheet 6 of 6

Example - Surface System
Detailed Evaluation Contour Ditch Irrigation Systems Worksheet**Grid Data**

Grid point	Advance time ^{1/} (hr:min)	Recession time ^{3/} (hr: min)	Opportunity time "T _o " (min)	Typical depth infil. ^{2/} (in)	Adjusted depth infil. ^{2/} (in)	Low 1/4 adjusted intake ^{4/} (in)
D2	0752	1725	573	6.6	9.7	
E2	0749	1715	566	6.5	9.7	
F2	0755	1725	570	6.6	9.7	
C3	0841	1735	521	6.2	9.2	
D3	0814	1729	555	6.4	9.5	
E3	0755	1728	573	6.6	9.7	
F3	0813	1728	555	6.4	9.5	
G3	0850	1732	522	6.2	9.2	9.2
C4	0853	1742	529	6.3	9.3	
D4	0841	1730	537	6.3	9.4	
E4	0815	1733	558	6.4	9.5	
F4	0814	1733	559	6.4	9.6	
G4	0902	1740	518	6.1	9.2	9.2
C5	0915	1751	516	6.1	9.1	9.1
D5	0855	1748	533	6.3	9.4	
E5	0833	1743	550	6.4	9.5	
F5	0815	1742	567	6.5	9.7	
G5	0905	1750	525	6.2	9.2	9.2
E6	0857	1753	536	6.3	9.5	
G6	0920	1800	460	5.6	8.4	8.4
Total				126.4	187.9	45.1

2/ From "typical" cumulative intake curve.

3/ From "adjusted" cumulative intake curve.

4/ Adjusted intake for lowest intake 1/4 of points (total number of points divided by 4).

Average depth infiltrated (typical):

$$= \frac{\text{Total depth typical}}{\text{Number of grid points}} = \frac{126.4}{20} = 6.32 \text{ in}$$

Average depth infiltrated (adjusted):
 (Should be close to actual depth infiltrated)

$$= \frac{\text{Total depth adjusted}}{\text{Number of grid points}} = \frac{187.9}{20} = 9.395 \text{ in}$$

Average depth infiltrated (adjusted), low 1/4:

$$= \frac{\text{Total depth adjusted, low 1/4}}{\text{Number grid points, low 1/4}} = \frac{45.1}{20} = 9.02 \text{ in}$$

Example 9-5 Evaluation computation steps for contour ditch irrigation systems

1. **On the grid sheet, determine the area, in acres, covered by the irrigation.**
2. **Compute the soil water deficit (SWD).** This is the net depth of application (F_n) needed for the evaluation irrigation.
3. **Plot cumulative intake curves for each infiltrometer.** After all curves have been plotted on log-log paper and deviations have been considered and allowed for, a typical straight line can be drawn for use in evaluation (fig. 9-26). Its position should be checked later and adjusted to show the correct duration of irrigation.

Figure 9-26 Cumulative intake curve (data from figure 9-27)

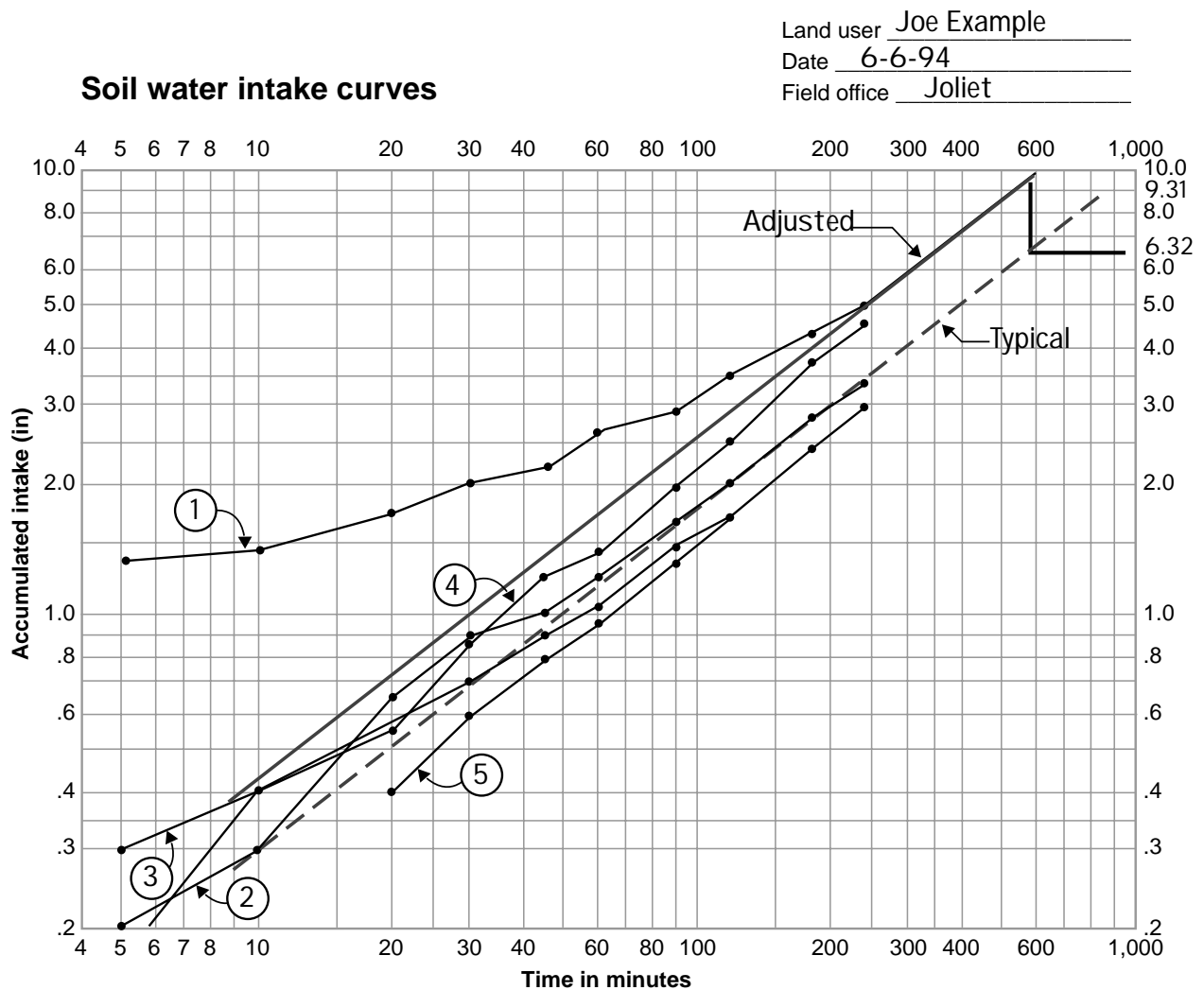

Figure 9-27 Example cylinder infiltrometer test data

U.S. Department of Agriculture
Natural Resources Conservation Service

Example - Cylinder Infiltration Test Data

NRCS-ENG-322
 02-96

FARM Joe Example	COUNTY Carbon	STATE MT	LEGAL DESCRIPTION	DATE 6-6-94
SOIL MAPPING SYMBOL	SOIL TYPE Fort Collins loam		SOIL MOISTURE: 0' - 1' - % of available 1' - 2' - % of available	
CROP Alfalfa grass	STAGE OF GROWTH			

GENERAL COMMENTS

Elapsed time Min.	Cylinder No. 1			Cylinder No. 2			Cylinder No. 3			Cylinder No. 4			Cylinder No. 5			Average accum. intake
	Time of reading	Hook gauge reading	Accum. intake	Time of reading	Hook gauge reading	Accum. intake	Time of reading	Hook gauge reading	Accum. intake	Time of reading	Hook gauge reading	Accum. intake	Time of reading	Hook gauge reading	Accum. intake	
	Inches			Inches			Inches			Inches			Inches			
0	12:01	8.5	0	12:02	7.0	0	12:03	7.2	0	12:04	6.6	0	12:05	8.0	0	
5	12:06	7.2	1.3	12:07	6.8	0.2	12:08	6.9	0.3	12:09	6.3	0.3	12:10	7.9	0.1	
10	12:11	7.1/ 8.8	1.4	12:12	6.7/ 8.2	0.3	12:13	6.8/ 7.8	0.4	12:14	6.2/ 7.2	0.4	12:15	7.6/ 8.25	0.4	
20	12:21	8.55	1.65	12:22	7.85	0.65	12:23	7.65	0.55	12:24	7.05	0.55	12:26	8.25	0.4	
30	12:31	8.2	2.0	12:32	7.6	0.9	12:33	7.4	0.7	12:34	6.75	0.85	12:35	8.05	0.6	
45	12:46	8.1	2.1	12:47	7.5	1.0	12:48	7.2	0.9	12:49	6.4/ 7.6	1.2	12:50	7.85	10.8	
60	13:01	7.7	2.5	13:02	7.3	1.2	13:03	7.05	1.05	13:04	7.4	1.4	13:05	7.7	0.95	
90	13:31	7.35	2.85	13:32	6.9	1.6	13:33	6.65	1.45	13:34	6.9	1.9	13:35	7.35	1.3	
120	14:01	6.85/ 9.05	3.35	14:02	6.55/ 9.05	1.95	14:03	6.45/ 9.2	1.65	14:04	6.4/ 9.2	2.4	14:05	7.0/ 9.2	1.65	
180	15:01	8.3	4.1	15:02	8.3	2.7	15:03	8.5	2.35	15:04	8.1	3.5	15:05	8.5	2.35	
240	16:01	7.55	4.85	16:02	7.7	3.3	16:03	7.95	2.9	16:04	7.35	4.25	16:04	7.9	2.95	

Example 9-5 Evaluation computation steps for contour ditch irrigation systems—Continued

4. **Enter the advance and recession times at each grid point on the grid data worksheet** (exhibit 9-5). This requires some interpolation of the times shown on the map. Compute difference in time between advance and recession, in minutes. This time is the actual opportunity time (T_o) at each grid point. Record T_o on the worksheet.

Find the average opportunity time for the area by averaging the T_o values for all grid points.

Using the computed opportunity times for each grid point, determine and record the typical intake depth for each point from the typical cumulative intake curve. Compute the average depth infiltrated (typical):

$$\text{Ave depth infiltrated, inches} = \frac{\text{Total depth infiltrated, typical}}{\text{Number of grid points}}$$

To check correctness of the location at which the typical curve was drawn, the actual average depth infiltrated is computed:

$$\text{Ave depth infiltrated, inches} = \frac{(\text{Irrigation volume, ac - in}) - (\text{Runoff volume, ac - in})}{(\text{Irrigated area, acres})}$$

A curve correction is needed because the infiltrometers check the infiltration at only one spot in the irrigated area. The slope of that curve is probably typical of the average curve for the area. An adjusted curve, since it is based on the infiltrometer curve slope and actual average depth infiltrated, will more nearly represent the average intake curve for the irrigated area and the field.

Draw a line parallel to the typical line passing through a point that is at the actual average depth infiltrated and at a time corresponding to the typical average depth infiltrated. This new line is the adjusted cumulative intake curve. See figure 9-26.

Using the adjusted intake curve and the opportunity time for each grid point, determine the adjusted intake depth for each grid point. Compute the average depth, adjusted:

$$\text{Ave depth} = \frac{(\text{Total depth infiltrated, adjusted})}{\text{Number of grid points}}$$

Compute the average depth infiltrated low quarter, adjusted:

$$\text{Ave depth infiltrated, inches} = \frac{\left(\text{Total depth infiltrated, adjusted, low } \frac{1}{4} \right)}{\left(\text{Number of grid points, low } \frac{1}{4} \right)}$$

Example 9-5 Evaluation computation steps for contour ditch irrigation systems—Continued**5. Compute irrigation characteristics:**Gross application (F_g):

$$F_g, \text{ inches} = \frac{(\text{Total inflow volume, ac} \cdot \text{in})}{(\text{Irrigated area, acres})}$$

Distribution uniformity – low quarter (DU)

$$DU = \frac{(\text{Total low quarter depth infiltrated})}{(\text{Total depth infiltrated})}$$

Runoff depth (RO):

$$RO, \text{ inches} = \frac{(\text{Runoff volume, ac} \cdot \text{in})}{(\text{Irrigated area, acres})}$$

$$RO, \% = \frac{(\text{Runoff depth, inches})}{(\text{Gross application, inches})} \times 100$$

Deep percolation (DP):

$$DP, \text{ inches} = (\text{Gross application, inches}) - (\text{Runoff depth, inches}) - (\text{Soil water deficit, inches})$$

$$DP, \% = \frac{(\text{Deep percolation, inches})}{(\text{Gross application, inches})} \times 100$$

Application efficiency (E_a)—Application efficiency is the ratio of average depth of water stored in the root zone to gross application depth. In most cases for this type of irrigation, the entire root zone is filled to field capacity by the irrigation. If this is the case, application efficiency is the ratio of soil water deficit to gross application. Otherwise, it is the ratio of gross application less runoff to gross application.

$$E_a = \frac{(\text{Average depth stored in root zone, inches})}{(\text{Gross application, inches})} \times 100$$

6. Compute potential water conservation and pumping cost savings:

- Based on information about present irrigation scheduling and application practices obtained from the irrigation decisionmaker and on data derived from the evaluation, make a best estimate of the present net application per irrigation.

Example 9-5 Evaluation computation steps for contour ditch irrigation systems—Continued

- Compute an estimate of the gross amount of irrigation water used per year. Use the estimated average net application, average number of annual irrigations (from the irrigation decisionmaker), and application efficiency (E_a) found by this evaluation to compute annual gross:

$$\frac{(\text{Net applied per irrigation, inches}) \times (\text{Number of irrigations})}{(\text{Application efficiency, } E_a)} \times 100$$

- From the irrigation guide, determine annual net irrigation requirements for the crop to be managed.
- From the irrigation guide or other source, determine potential system efficiency (E_{pa}).
- Compute annual gross applied:

$$\frac{(\text{Annual net irrigation requirement, inches})}{(\text{Potential application efficiency, } E_{pa})} \times 100$$

- Compute total annual water conserved (ac-ft):

$$\frac{(\text{Present gross applied, inches}) - (\text{Potential gross applied, inches})}{12} \times \text{Area irrigated, acre}$$

- If cost is a factor, compute cost savings:

Pumping cost savings:

From a separate pumping plant evaluation, determine pumping plant efficiency, kind of fuel, cost per unit of fuel, and fuel cost per acre foot. Compute fuel cost savings:

$$(\text{Fuel cost per acre foot}) \times (\text{acre feet conserved per year})$$

Water purchase cost savings:

Obtain purchase cost data from irrigation decisionmaker. Compute as follows:

$$(\text{Cost per acre foot}) \times (\text{Acre feet saved per year})$$

Compute total cost savings.

Example 9-5 Evaluation computation steps for contour ditch irrigation systems—Continued**Analysis of data and preparation of recommendations:**

1. **Compare soil water deficit (SWD) with management allowed deficit (MAD).** This indicates whether the irrigation was correctly timed, too early, or too late.
2. **Consider changes that may be made in set times and scheduling.**
3. **Consider changes that might be made in ditch location and turnout location.**
4. **Consider alternative types of turnouts.** Turnouts with better flow control may improve the ability to manage the system.
5. **Consider whether land smoothing or construction of corrugations would help distribution patterns.**

Recommendations:

Use field observations, data obtained by discussion with the irrigation decisionmaker, and data obtained by computations to make practical recommendations. Remember that the data are not exact because of the many variables. Flow rate changes and other changes are the result of a trial and error procedure. After each new trial, the field should be probed to determine penetration. Enough instruction should be given to operators so they can make these observations and adjustments.

Making management changes is always the first increment of change. Recommending irrigation system changes, along with appropriate management changes is secondary.

(5) Periodic move sprinkler (sideroll wheel lines, handmove, end tow) fixed (solid) sets

The overall efficiency of sprinkler irrigation systems changes with time. Nozzles, sprinkler heads, and pumps wear (lose efficiency), and pipes and joints develop leaks. Some systems are used in ways they were not designed. A sprinkler system evaluation is designed to identify problems and develop solutions. Before a detailed evaluation is made, obvious operating and equipment deficiencies should be corrected by the water user. However, observing and evaluating a poorly designed, installed, or operated system may be a good training exercise to improve employee competence. The following evaluation procedure works satisfactorily with either impact or gear driven type sprinkler heads. Some modification to evaluation tools may be necessary to check pressure and sprinkler discharge.

(i) Equipment needed—The equipment needed to evaluate a periodic move sprinkler system includes:

- Catch containers and stakes—number of containers equals:

$$\frac{\text{lateral spacing} \times \text{sprinkler spacing}}{25}$$

- Two 50-foot tapes
- 500-mL (cc) graduated cylinder (use 250-mL graduated cylinder for light applications).
- Pocket tape (inches)
- Miscellaneous tools—pipe wrench and adjustable wrenches
- Pressure gauge with pitot tube, 0 to 100 psi pressure range (recommend liquid filled)
- Soil auger, push tube sampler, probe, shovel
- Equipment for determining soil moisture amounts—feel and appearance charts, Speedy moisture meter and Eley volumeter, or auger and oven drying cans
- Set of unused high speed twist drill bits, 1/16 to 1/4 inch (by 64ths) for measuring inside diameter of nozzles on impact type sprinkler heads
- Stop watch or watch with second hand
- Wind velocity gauge, thermometer (for air temperature)
- Calibrated bucket (2- to 5-gallon), 5-foot length of 5/8 inch diameter or larger garden hose, need two for measuring discharge from double nozzle sprinkler heads

- Manufacturer's sprinkler head performance charts
- Clipboard and pencil
- Soil data for field
- Camera, boots, rain gear
- Special adapter for measuring discharge from gear driven pop-up type sprinkler heads, if needed
- Worksheets

(ii) Field procedures—The field procedures needed to evaluate this system are in two categories: general and inventory and data collection

General

Obtain pertinent information about irrigation system hardware from the irrigation decisionmaker and from visual observation. Observe general system operating condition, crop uniformity, salinity problems, wet areas, dry areas, and wind problems. Obtain information about the field and how it is irrigated including. This information should include irrigation set time, direction of move of sprinkler laterals, number of moves per day, sprinkler head spacing and move, number of sets or irrigations per season, chemigations, and crops grown in the rotation. If at all possible, perform the evaluation on a day with no or little wind. With lateral sets involving one move per day (24-hour set), it may be desirable to leave catch can containers overnight.

Inventory and data collection

The following steps are needed to collect and inventory data:

Step 1—Estimate soil-water deficit at several locations in the field. Use the feel and appearance, Eley volumeter/Speedy moisture meter, auger or push tube sampler (Madera sampler), or some other method. Pick a typical location, and record the data on the worksheet.

Step 2—While completing step 1, also make note of soil profile conditions including:

- Depth to water table
- Apparent root development pattern and depth of existing or previous crop (for determining effective plant root zone)

- Root and water restrictions:
 - Compacted layers (tillage pans) and probable cause.
 - Mineral layers.
 - Hardpans or bedrock.
 - Soil textures including textural change boundaries (abrupt or gradual).

Step 3—If a portable flow meter is available, insert it at the beginning of the lateral before the irrigation is started and leave it throughout the irrigation. The irrigator could install and remove it when laterals or sets are changed. Clamp-on ultrasonic flowmeters can also be used effectively.

Step 4—Choose a representative location along a sprinkler lateral for the test where pressure is typical for most of the lateral. With one size of lateral pipe, about half the pressure loss resulting from pipeline friction loss in a lateral occurs in the first 20 percent of the length. Over 80 percent of pressure loss occurs in the first half of the lateral length. On a flat field the most representative pressure occurs about 30 to 40 percent of the distance from the lateral inlet to the terminal end.

Almost any container can be used. A sharp edge is desirable. The 12- or 16-ounce clear plastic drinking glass works well. For straight sided containers, the entry rim diameter is measured and the equivalent capacity in cc (mL) for 1-inch application depth is computed. For stackable tapered sided containers, a 500 cc (or 250 cc) graduated cylinder is used to volumetrically measure catch in the cans. The cross sectional area of the top of the container is used to calculate application depth, either in inches or millimeters. Large sized rain gauges can be used as catch containers and can be read directly. To get mL conversion using a circular container, measure the opening diameter in inches and the conversion from mL to inches:

$$\text{mL} = \frac{\pi D^2}{4} \times 16.387$$

Step 5—Place bags over sprinklers affecting the test area. An alternative to this is to insert a small stick or plant stem along the side or into the impact arm of impact type sprinkler heads to jam it open and prevent rotation. Make sure water does not get in the containers while they are being set out. Using a pressure

gauge and pitot tube, hose, calibrated bucket, and stop watch, check pressure and flow measurement at sprinklers next to the test area. All sprinklers on the lateral need to be operating.

Note: Liquid filled pressure gauges are more durable and provide dampening of the gauge needle, allowing pressure readings more easily obtained. Gauges should be periodically checked against known pressures to determine potential errors. Purchasing a quality pressure gauge to start with is a wise investment.

Step 6—Set out catch containers on a 10-foot by 10-foot grid on both sides of the lateral between two or more adjacent sprinkler heads. The grid pattern should be continued perpendicular to the lateral for a distance equal to the next lateral set location or just beyond sprinkler throw radius, whichever is greater. The last rows of catch containers on each side of the lateral will probably catch little water. See figure 9–28 for catch container layout and example catch data.

Each container should be located at approximate plant canopy height within a foot of its correct grid position and set carefully in an upright position with its top parallel to the ground. Any surrounding vegetation that would interfere with a container should be removed. To fasten containers to short stakes with rubber bands may be necessary. Personal ingenuity may be necessary as to shape, height, and setting of catch cans when evaluating low angle sprinkler heads installed close to the ground surface. It is necessary for water to enter the catch container nearly vertical rather than horizontal.

During hot, dry weather when long catch times are used, an evaporation container should be set upwind and away from the sprinklers. The container should be filled with water at the start of the irrigation test, and the amount of evaporation measured at the same time the rest of the containers are read. Depth of water in the evaporation container should approximate half the average catch. This measurement approximates the amount of evaporation that occurred from the catch during the test period.

Quickly remove the cloth bags or small sticks from the sprinkler heads to allow them to start rotating. Start timing the catch.

Figure 9-28 Catch can data for lateral move system

**Lateral move system
catch can data**

Land user _____

Date _____

Field office _____

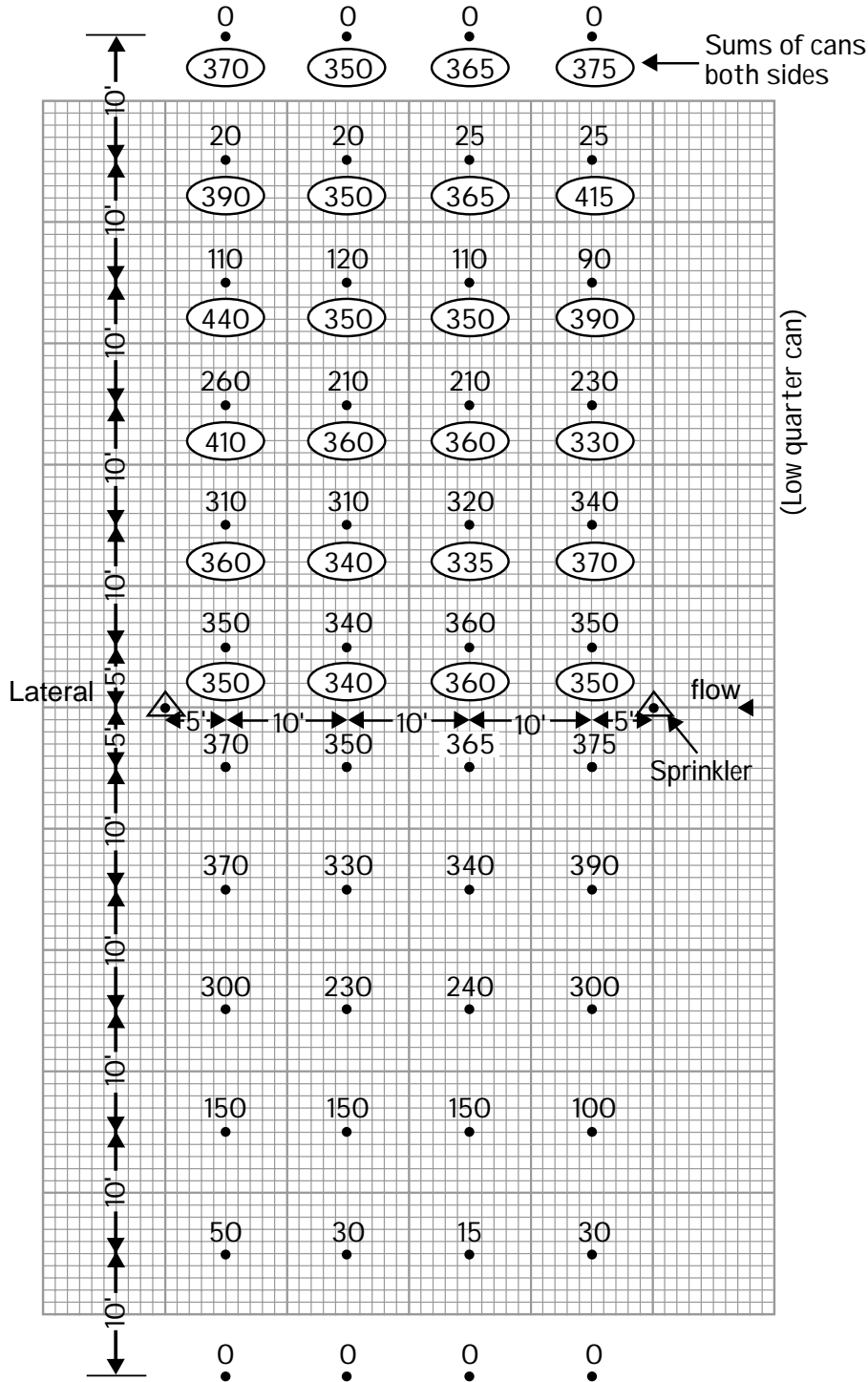

Step 7—At several locations along the lateral, use the shank end of unused high speed twist drill bits to determine nozzle diameters. Check for wear and correct nozzle size. Nozzle size generally is indicated on side of nozzle. Wear is considered excessive when the drill bit can be moved about in the nozzle over 5 to 10 degrees. Observe sprinkler heads for hang-ups, weak springs, and leaks. Impact type heads should rotate at 1 to 2 revolutions per minute. Determining the actual size of sprinkler nozzles being used with gear driven heads using noncircular orifices is difficult. The biggest cause of sprinkler irrigation application nonuniformity is mixed nozzle sizes.

Step 8—Measure and record pressure and flow rate of sprinklers at several locations along the lateral line and at both ends, preferably at the beginning and end of the test period. Pressure is most accurately measured with tip of the pitot tube in the jet stream at the orifice. Inserting the tip of the pitot tube inside the orifice restricts flow; thus, line pressure is measured rather than orifice discharge pressure. Typically the difference is 1 to 2 psi. For most evaluations line pressure is sufficient providing all measurements are line pressure or nozzle pressure.

Step 9—Record how long it takes each sprinkler tested to fill a calibrated bucket. A short length of garden hose over the sprinkler nozzle is used to collect the flow in the calibrated bucket. To avoid modifying nozzle hydraulics, the hose should fit rather loosely. Time the flow into the bucket with a stopwatch. To improve accuracy, determine the sprinkler discharge several times and compute the average. Use two hoses for double nozzle sprinkler heads. It will take personal ingenuity to develop a device to measure discharge from gear driven sprinkler heads. The head should rotate freely. A device similar to the that used when evaluating micro-irrigation systems (minispray heads) may be adopted using a larger two-piece catch container.

Step 10—Record wind speed, air temperature, and whether humidity is low, medium, or high.

Step 11—The test duration should be such that a minimum of 0.5-inch (average) depth of water is collected in catch containers. Terminate the test by replacing bags over the sprinkler heads or blocking head rotation. Record the time.

Step 12—Measure the depth of water caught in each container by pouring water into a graduated cylinder. An alternative to this is to use large commercial plastic rain gauges as catch containers as well as the evaporation container. The difference between the starting and ending depth in the evaporation container needs to be added to all catch container readings. Rain gauges can be read directly.

Step 13—Record the catch data on a grid sheet. Show location of sprinkler heads and lateral pipeline in relation to catch containers. Show north direction, direction of pipeline flow, and prevailing wind direction. Record nearby landmarks to locate the test area for discussion purposes with the water user.

(iii) Evaluation computations—The information gathered in the field procedures is used in the detailed system evaluation computations. Example 9-6 outlines the computations used to complete the Sprinkler Irrigation System Detailed Evaluation Periodic Move and Fixed Set Sprinkler System Worksheet (exhibit 9-6).

Exhibit 9-6 Completed worksheet—Sprinkler irrigation system, detailed evaluation of periodic move and fixed set sprinkler irrigation systems

U.S. Department of Agriculture
Natural Resources Conservation Service

Sheet 1 of 6

**Sprinkler Irrigation System
Detailed Evaluation Periodic Move and Fixed Set Sprinkler System**

Land user Joe Example Prepared by _____
District _____ County _____ Engineer job class _____

Irrigation system hardware inventory:

Type of system (check one) : Side- roll Handmove _____ Lateral tow _____ Fixed set _____
Sprinkler head: make RB, model 30, nozzle size(s) 3/16 by 3/32 inches
Spacing of sprinkler heads on lateral, S₁ 40 feet
Lateral spacing along mainline, S_m 60 feet, total number of laterals 1
Lateral lengths: max _____ feet, minimum _____ feet, average _____ feet
Lateral diameter: 1280 feet of 5 inches, _____ feet of _____ inches
Manufacturer rated sprinkler discharge, 8.6 gpm at 45 psi giving 96 feet wetted diameter
Total number sprinkler heads per lateral 33, lateral diameter 5 inches
Elevation difference between first and last sprinkler on lateral (=/-) -5 feet
Sprinkler riser height - feet, mainline material 6" PVC
Spray type: fine (>30psi), _____ coarse (<30psi)

Field observations:

Crop uniformity _____
Water runoff _____
Erosion _____
System leaks _____
Fouled nozzles _____
Other observations _____

Field data inventory & Computations:

Crop Alfalfa, root zone depth 5 feet, MAD 1/ 50 %, MAD 1/ 3.0 inches
Soil-water data (typical):
(Show locations of sample on soil map or sketch of field)
Moisture determination Feel & appearance
Soil series and surface texture Redfield loam

Depth	Texture	AWC 1/ (in)	SWD 1/ (%)	SWD 1/ (in)
<u>0-1'</u>	<u>L</u>	<u>2.0</u>	<u>50</u>	<u>1.0</u>
<u>1-2'</u>	<u>LFS</u>	<u>1.5</u>	<u>45</u>	<u>0.7</u>
<u>2-35'</u>	<u>VFLS</u>	<u>2.25</u>	<u>45</u>	<u>1.0</u>
<u>3.5-5'</u>	<u>GLS</u>	<u>1.5</u>	<u>20</u>	<u>0.3</u>
		<u>7.25</u>		<u>3.0</u>
Totals				

1/ MAD = Management allowable depletion, AWC = Available water capacity, SWD = Soil water deficit

Exhibit 9-6 Completed worksheet—Sprinkler irrigation system, detailed evaluation of periodic move and fixed set sprinkler irrigation systems—Continued

U.S. Department of Agriculture
Natural Resources Conservation Service

Sheet 2 of 6

**Example - Sprinkler Irrigation System
Detailed Evaluation Periodic Move and Fixed Set Sprinkler System**

Comments about soils (including restrictions to root development and water movement): _____

Present irrigation practices:

Typical irrigation duration 12 hr, irrigation frequency 14 days
 Typical number irrigations per year 8
 Distance moved per set 60 ft, Alternate sets? no

Measured nozzle diameters (using shank of high speed drill bit)

Sprinkler no.	<u>1</u>	<u>13</u>	<u>33</u>
Diameter	<u>3/16 x 3/32</u>	<u>same</u>	<u>same</u>
Size check	<u>m</u>	<u>m</u>	<u>m</u>

(state whether t = tight, m = medium, l = loose)

Actual sprinkler pressure and discharge data:

Sprinkler number on test lateral

	1st		end
Initial pressure (psi)	<u>48</u>	<u>47</u>	<u>46</u>
Final pressure (psi)	<u>47</u>	<u>46</u>	<u>45</u>
Catch volume (gal)	<u>5</u>	<u>5</u>	<u>5</u>
Catch time (sec)	<u>33</u>	<u>34</u>	<u>34</u>
Discharge (gpm)	<u>9.1</u>	<u>8.8</u>	<u>8.8</u>

Test:

Start 0924 stop 1521 duration 5:57 = 5.95 hours

Atmospheric data:

Wind: Direction: Initial from N during same final same
 Speed (mph): initial 0-7 during 5-10 final 5-10

Temperature: initial 65° final 75° Humidity: low med high

Evaporation container: initial — final — loss — inch

Exhibit 9-6 Completed worksheet—Sprinkler irrigation system, detailed evaluation of periodic move and fixed set sprinkler irrigation systems—ContinuedU.S. Department of Agriculture
Natural Resources Conservation Service

Sheet 3 of 6

**Example - Sprinkler Irrigation System
Detailed Evaluation Periodic Move and Fixed Set Sprinkler System****Lateral flow data:**

Flow meter reading _____ - _____ gpm

Average discharge of lateral based on sprinkler head discharge

$$= [1\text{st gpm} - .75 \text{ times } (1\text{st gpm} - \text{last gpm})] \text{ times } (\text{number of heads})$$

$$= \frac{9.1 - .75 (9.1 - 8.8)}{1} = 8.8 \text{ gpm (ave flow per head)}$$

$$= 33 \text{ heads} \times 8.8 \text{ gpm/head} = 290 \text{ gpm}$$

Calculations:Gross application per test = $\frac{(\text{flow, gpm}) \times (\text{time, hr}) \times 96.3}{(\text{lateral length}) \times (\text{lateral spacing})}$

$$= \frac{(290 \text{ gpm}) \times (12 \text{ hours}) \times 96.3}{(1280 \text{ feet}) \times (60 \text{ feet})} = 2.16 \text{ inches}$$

Gross application per irrigation = $\frac{(\text{gross application per test, in}) \times (\text{set time, hour})}{(\text{time, hour})}$

$$= \frac{(2.16 \text{ inches}) \times (12 \text{ hour})}{(5.95 \text{ hour})} = 4.36 \text{ inches}$$

Catch container type Straight sided200 cc (mL) or in, measuring container = 1.0 inches in containerTotal number of containers 48

$$\text{Composite number of containers} = \frac{\text{Total number of containers}}{2} = \frac{48}{2} = 24$$

Total catch, all containers = $\frac{8745 \text{ cc (mL)}}{200 \text{ cc/in}} = 43.73 \text{ inches}$

$$\text{Average total catch} = \frac{\text{Total catch}}{\text{composite no. containers}} = \frac{43.73}{24} = 1.82 \text{ inches}$$

$$\text{Number of composite containers in low } 1/4 = \frac{\text{composite no. containers}}{4} = \frac{24}{4} = 6$$

Total catch in low 1/4 composite containers = $\frac{2045 \text{ cc(mL)}}{200 \text{ cc/in}} = 10.225 \text{ inches}$

Exhibit 9-6 Completed worksheet—Sprinkler irrigation system, detailed evaluation of periodic move and fixed set sprinkler irrigation systems—Continued

U.S. Department of Agriculture

Sheet 4 of 6

Natural Resources Conservation Service

Example - Sprinkler Irrigation System
Detailed Evaluation Periodic Move and Fixed Set Sprinkler System

$$\begin{aligned} \text{Average catch of low 1/4 composite containers} &= \frac{\text{total catch in low 1/4}}{\text{no. composite low 1/4 containers}} \\ &= \frac{10.225}{6} = 1.70 \text{ inches} \\ \text{Average catch rate} &= \frac{\text{Average total catch, inches}}{\text{Test time, hour}} = \frac{1.82}{5.95 \text{ hour}} = 0.31 \text{ inch/hour} \end{aligned}$$

NOTE: Average catch rate is application rate at plant canopy height.

Distribution uniformity low 1/4 (DU):

$$DU = \frac{(\text{Average catch low 1/4 composite containers}) \times 100}{\text{Average total catch}} = \frac{1.70 \times 100}{1.82 \text{ inches}} \text{ inches} \times 100 = 93.4 \%$$

Approximate Christiansen Uniformity (CU):

$$CU = 100 - [0.63 \times (100 - DU)] = 100 [0.63 \times (100 - 93.4)] = 95.8 \%$$

Effective portion of applied water (R_e):

$$R_e = \frac{\text{Average total catch, inch}}{\text{Gross applications/test, inches}} = \frac{1.82}{2.16 \text{ inches}} \text{ inches} = 0.84 \text{ inches}$$

Application efficiency of low 1/4 (E_q):

$$E_q = DU \times (R_e) = 93.4 \times .84 = 78.5 \%$$

NOTE: Use for medium to high value crops.

Approximate application efficiency low 1/2 (E_h):

$$E_h = CU \times (R_e) = 95.8 \times .84 = 80.5 \%$$

NOTE: Use for lower value field and forage crops.

Exhibit 9-6 Completed worksheet—Sprinkler irrigation system, detailed evaluation of periodic move and fixed set sprinkler irrigation systems—ContinuedU.S. Department of Agriculture
Natural Resources Conservation Service

Sheet 5 of 6

**Example - Sprinkler Irrigation System
Detailed Evaluation Periodic Move and Fixed Set Sprinkler System**Application efficiency, (E_a):

$$F_n = \frac{(\text{gross application per irrigation})}{100} \times E_q = \left(\frac{4.36 \text{ inches}}{100} \right) \times 80.5 = 3.51 \text{ inches}$$

$$E_a = \frac{(\text{water stored in root zone})}{(\text{gross application per irrigation})} \times 100 = \left(\frac{3.0 \text{ inches}}{4.36 \text{ inches}} \right) \times 100 = 68.8 \%$$

Losses = (runoff, deep percolation) = gross application per irrigation minus SWD

$$= (4.36 - 3.0) = 1.36 \text{ inches}$$

Potential Water and Cost Savings:**Present management:**

Gross applied per year = (gross applied per irrigation) x (number of irrigations) =

$$= (4.36 \text{ inches}) \times (8) = 34.9 \text{ inches/year}$$

Potential management:Annual net irrigation requirement 14.9 inches/year, for alfalfa (crop)Potential application efficiency (E_q or E_H) 75 % (from NEH, Part 623, Ch 11)Potential annual gross applied = $\frac{(\text{annual net irrigation requirement})}{\text{Potential } E_q \text{ or } E_H} \times 100$

$$= \left(\frac{14.87 \text{ inches}}{75} \right) \times 100 = 19.8 \text{ inches}$$

Total annual water conserved

$$= \frac{(\text{Present gross applied} - \text{potential gross applied}) \times (\text{area irrig. (ac)})}{12} = \text{acre/feet}$$

$$= \frac{(36.7 \text{ inches}) - (19.8 \text{ inches}) \times (40 \text{ acres})}{12} = 56.2 \text{ acre/feet}$$

Exhibit 9-6 Completed worksheet—Sprinkler irrigation system, detailed evaluation of periodic move and fixed set sprinkler irrigation systems—Continued

U.S. Department of Agriculture
Natural Resources Conservation Service

Sheet 6 of 6

**Example - Sprinkler Irrigation System
Detailed Evaluation Periodic Move and Fixed Set Sprinkler System**

Cost savings:

Pumping plant efficiency NA Kind of fuel _____

Cost per unit of fuel \$ _____ Fuel cost per acre/foot \$ _____

Cost savings = (fuel cost per acre-foot) x (acre-feet conserved per year) = \$ _____
= (_____) x (_____) = \$ _____

Water purchase cost:

= (Cost per acre-foot) x (acre-feet saved per year) = _____ x _____ = \$ _____

Cost Savings:

= Pumping cost + water cost = _____ + _____ = \$ _____

Recommendations: _____

Example 9-6 Evaluation computation steps for periodic move and fixed set sprinkler irrigation systems

- 1. Simulate sprinkler lateral overlap.** When only one lateral is operating or when operating laterals are not adjacent, simulate sprinkler lateral overlap by transposing catch from one side of the lateral and adding to catch on the other side. Note that the row of containers that would be next to the lateral during the next set must be added to the row of cans next to the test lateral. By doing this we assume that the transposed half is the same as the same side of the next set. If catch on one side has been beyond the lateral move distance, the row of cans next to the next lateral set should still be overlaid next to the test lateral location, and the extended cans added to the other side.

Assume that the pattern for the next lateral set will have an overlap the same as the transposed half of the evaluated set. This is not always true because the next set may have significantly different patterns as a result of wind or pressure changes. If changes are significant, additional evaluations may be needed.

The worksheet is set up for transposing catch data. Adjustments in computations are needed if data are not transposed when adjacent laterals are operating. The following description is for transposed data.

- 2. Compute the gross application during the test and the gross application for the entire set time.**
- 3. Compute the composite number of containers, total containers divided by 2.**
- 4. Compute the total catch in all containers.**
- 5. Compute the average catch in all containers.** Compute the average catch for all containers with the measure evaporation container or loss added back in (gross application minus evaporation from discharge to catch, wind drift, and system leaks).
- 6. Compute the low quarter number of composite containers:** composite number of containers divided by 4.
- 7. Add the lowest 25 percent composite catches to represent the low quarter.**
- 8. Compute the average low one quarter catch:**

$$\frac{\text{Total catch in low } \frac{1}{4} \text{ containers}}{\text{Number of low } \frac{1}{4} \text{ containers}}$$

- 9. Compute irrigation characteristics:**

- Compute distribution uniformity low 1/4 (DU)

$$DU = \frac{\text{Average catch in low } \frac{1}{4} \text{ containers}}{\text{Average catch container depth}}$$

Example 9-6 Evaluation computation steps for periodic move and fixed set sprinkler irrigation systems—Continued

- Compute approximate Christiansen uniformity coefficient (CU) percent from:

$$CU = 100 - 0.63 \times (100 - DU)$$

- Compute effective portion of applied water (R_e).

The effective portion of applied water compares the amount of water caught in containers to the amount pumped. Any difference is a loss caused by evaporation, spray drift, or leaks. It does not account for deep percolation and runoff. The effective portion of applied water can be estimated using figure 6-8 in chapter 6 by entering the chart with observed data on wind velocity, temperature, and humidity. With data from an analysis, the actual effective portion of applied water is computed as follows:

$$R_e = \frac{\text{Average total catch (in)}}{\text{Gross application (in)}}$$

The effective portion of applied water is frequently confused with application efficiency. Application efficiency is the amount of water stored in the plant root zone divided by the amount diverted or pumped. Application efficiency accounts for all losses between the pump and the plant, including system leaks, evaporation, spray drift, deep percolation, and runoff.

Application efficiency of low quarter (E_q) percentage:

$$E_q = DU \times (R_e)$$

Approximate application efficiency of low half (E_h) percentage. Note it is suggested to use E_q for most conditions; however, E_h may be applicable where low value field crops are irrigated and deep medium texture soils are available.

$$E_h = CU \times (R_e)$$

Application efficiency (E_a) indicates how much water has gone to deep percolation and runoff. First net irrigation application (F_n) is calculated:

$$F_n = \frac{(\text{Gross application per irrigation})}{100} \times E_q$$

$$E_a = \frac{(\text{Ave depth of water stored in root zone})}{\text{Ave depth of water applied}} \times 100 = \frac{F_n}{\text{Ave depth of water applied}}$$

Estimated losses for deep percolation and runoff are:

$$\text{Losses} = \frac{(1 - \text{Gross application})}{100} \times E_a$$

Example 9-6 Evaluation computation steps for periodic move and fixed set sprinkler irrigation systems—Continued**Water and cost savings are computed as follows:**

- 1. Make a best estimate of present net application per irrigation.** Base the estimate on information about present irrigation scheduling and application practices obtained from the water user, and on data derived from the evaluation.
- 2. Calculate the gross amount of irrigation water (F_g) applied during a typical year.** Using water user supplied information about the number of irrigations per season and the application efficiency derived as part of the evaluation, :

$$\text{Annual water applied } (F_g) = \frac{(\text{Net applied per irrigation}) \times (\text{Number of irrigations})}{\text{Application efficiency low } \frac{1}{4}(E_q)}$$

If E_q is not available:

$$F_g = \frac{(\text{Net applied per irrigation}) \times (\text{Number of irrigations})}{\text{Effective portion of applied water } (R_e)} \times 100$$

- 3. Determine potential system application efficiency for low quarter and low half.** Use information in this irrigation guide or other sources to help make the determination. Typical ranges of potential E_q and E_h values are:

$$\frac{E_q}{60 \text{ to } 75\%} \quad \frac{E_h}{70 \text{ to } 85\%}$$

These values are based on full canopy crops and the assumption that the system is well designed, maintained, and managed.

E_q values are typically used for high value crops and crops that have relatively shallow roots. E_h values are often used for relatively low value field and forage crops and deep rooted crops in medium to fine texture soil.

- 4. Compute potential gross applied per year:**

$$\frac{(\text{Annual net irrigation requirement, inches}) \times 100}{\text{Potential } E_q \text{ or } E_h}$$

Example 9-6 Evaluation computation steps for periodic move and fixed set sprinkler irrigation systems—Continued**Potential water conservation and pumping costs savings:****1. Compute total annual water conserved (ac-ft):**

$$\frac{(\text{Present gross applied} - \text{Potential gross applied}) \times \text{Area irrigated}}{12}$$

2. If cost is a factor, compute cost savings:

Pumping cost savings: From a pumping plant evaluation, determine pumping plant efficiency, kind of fuel, cost per unit of fuel, and fuel cost per acre-foot. Compute fuel cost savings:

$$\text{Fuel cost savings} = (\text{Fuel cost per acre foot}) \times (\text{acre feet conserved per year})$$

3. Compute water purchase cost savings (obtain purchase cost data from farmer). Compute as follows:

$$\text{Water purchase cost savings} = (\text{cost per acre foot}) \times (\text{acre feet saved per year})$$

4. Compute total cost savings.**Analysis of data and preparation of recommendations**

1. Compare soil-water deficit (SWD) with management allowable depletion (MAD). This indicates whether the irrigation was correctly timed, too early, or too late.
2. Compare test data to manufacturer's specifications for the make, model, and size of sprinkler head, nozzle(s), or flow regulator. Recommend maintenance or replacement if required.
3. Check system design. Consider changes that might be practical to make in system hardware and operation.
4. Consider changes that may be made in irrigation set times and scheduling (management).
5. Consider changes that may be made in soil, water, and plant cultural practices to improve water infiltration and use.

Recommendations:

Example 9-6 Evaluation computation steps for periodic move and fixed set sprinkler irrigation systems—Continued

Use field observations, data obtained by the water user, and data obtained by computations to make practical recommendations. Remember observed or measured data are not exact mainly because of the many variables. Irrigation system and management changes result from a calculated field trial and error procedure. The field should be probed after each new trial to determine application distribution uniformity and water penetration. Observations should be made to determine if translocation or runoff is occurring and to estimate the amount. Determine if erosion is occurring, and, if so, what may be causing the erosion. Recommend ways to reduce the erosion. If water translocation, runoff, soil erosion, or a combination of these, are occurring, adjustments in application rate set time or equipment replacement may be necessary. Changes in cultural practices may easily solve the problem. Enough instruction should be given to irrigation decisionmakers so they can make observations and adjustments themselves.

Making management changes is always the first increment of change. Recommending irrigation system changes along with appropriate management changes is secondary.

(6) Center pivot lateral—linear (lateral) move lateral

The efficiency of sprinkler systems changes with time. Nozzles and sprinkler and spray heads wear (lose efficiency), and pipes and joints develop leaks. Some systems are used in ways for which they were not designed. Sprinkler system performance evaluations are designed to identify problems and develop solutions. Before a detailed evaluation is made, obvious operating and equipment deficiencies should be corrected by the water user. However, observing and evaluating a poorly designed, installed, and operated system may be a good training exercise to improve employee competence.

The following evaluation procedure works satisfactorily with most spray heads and all impact type sprinkler heads. Modification and a bit of employee ingenuity is necessary to use this procedure with self moving systems using low pressure in-canopy (LPIC) or low energy precision application (LEPA) type discharge devices. Specially designed catch containers are needed. Using rain gutters for application catch devices is one technique that can work with in-canopy flat spray heads and bubblers. Care should be taken to not disturb foliage that would otherwise affect application uniformity. If at all possible, perform any evaluation when there is little to no wind.

(i) Equipment—The equipment needed for a moving lateral system includes:

- Catch containers and stakes: number of containers equals:

$$\frac{(\text{lateral length} + 10)}{30 \text{ ft}^{1/}}$$

^{1/} (30-foot spacing is maximum recommended. Refer to ASAE Standard S436 for recommendations for more precise evaluations.)

- 100-foot tape
- 500-milliliter (cc) graduated cylinder (250 mL cylinder is sufficient for light applications.)
- Pocket tape (inches)
- Pressure gauge with pitot tube, 0 to 100 pounds per square inch pressure range
- Flow measuring device (flow meter, velocity meter)
- Ohmmeter or electric ground check meter (tick meter)
- Soil auger, push tube sampler, probe, shovel

- Equipment for determining soil moisture (fee and appearance soil moisture charts, Speedy moisture meter and Eley volumeter, soil auger and oven drying soil sample containers)
- Stopwatch, thermometer, wind velocity gauge
- Ladder with hooks on top to fit over lateral (system will be moving during evaluation)
- Raincoat, rubber boots
- Manufacturer's pivot system design information (printout)
- Clipboard and pencil
- Soil data for field
- Camera
- Worksheets

(ii) Procedures—The field procedures needed for this system are in two main categories: general and inventory and data collection.

General

Obtain all pertinent system hardware information from the irrigator and from visual observations. Observe general system operating condition, crop uniformity, salinity problems, wet areas, dry areas, translocation, runoff, and other site characteristics. The following steps should be used:

Step 1—Obtain information from the irrigation decisionmaker about the field and how it is irrigated; i.e., speed setting (%), rotation speed (hours per rotation), application depth per single pass or rotation, and passes or rotations per irrigation. Determine how many irrigations or rotations are needed per season.

Step 2—Estimate soil-water deficit at several locations in front of and behind the lateral. Observe if the full plant root zone was filled to field capacity. Use the feel and appearance, Eley Volumeasure and Speedy Moisture Meter, auger or push tube sampler (Madera sampler), or some other acceptable method. Select a typical location and record the data on the worksheet.

Step 3—At the same time, make note of such soil profile conditions as:

- Depth to water table
- Apparent root development pattern and depth of existing or previous crop (to determine effective plant root zone)

- Root and water movement restrictions
 - Restrictive or compacted layers (tillage pans) and probable cause
 - Mineral layers
 - Hardpans or bedrock
 - Soil textural changes

Step 4—An electrical safety check should be made on any electrically operated center pivot system before climbing on or working around it. **The combination of a wet condition and electrical shorts can be deadly.** An ohmmeter or ground check meter (tick meter) should be used to check for current leakage between pivot system and ground. The safety check should be made when the towers are moving to help ensure there are no electrical shorts in an individual tower drive motor. Each tower motor should have the opportunity to run during the check. **Do not proceed with the evaluation if electrical leakage is indicated.** Too often electric operated systems have faulty electrical systems. If no electrical shorts are indicated using an ohmmeter or ground check meter, briefly touch metal components with the back of the hand. Electrical current causes muscles to contract involuntary, thus tightly closing the hand on the component. Only after following the above safety checks should the evaluation proceed.

Inventory and data collection

Step 1—Select a location in the field to run test. Look at elevation change and undulations. Select a location representative of the field being irrigated. You may need to wait a few hours or schedule another day when the lateral is in a desirable location. Sometimes the extreme condition is the operating condition an evaluation is intended to display. Running more than one evaluation at different locations in the field and at different times of day is desirable because of elevation changes in the field, wind drift and evaporation losses between day time and night time, start and stop locations during a test, flow or pressure variations, plus many other variables.

A difference in application from a lateral will be noted when a pivot system's corner systems (guns or swing laterals) are either operating or not operating. The effects of the start-stop operation characteristic (to maintain alignment) and spray head patterns of self move systems are sometimes apparent if two or more catch tests are run at the same location on different

days. This is most noticeable with low pressure systems where spray patterns are narrow. A minimum of two catch tests should be run before renozzling is recommended. Where differences are suspected, two rows of catch containers can be averaged to more nearly represent actual conditions.

Step 2—Determine flow into system. If a portable velocity meter (similar to Cox velocity meter) is available, insert the meter near the water source. Linear move laterals with water source in the center may require two flow measurements to obtain flow going both directions. The pitot device for this type meter can be inserted through a standard small gate valve (3/4 inch). Typically, outlet fittings available on the lateral pipe within the first span are not used. A threaded plug can be removed and replaced with a standard 3/4-inch gate valve, or the valve can be installed at the first sprinkler head before the lateral operates. A pitot tube velocity meter can then be easily installed and removed while the system is operating. Clamp-on type ultrasonic flow meters can also be used.

Velocities in the lateral pipe should be measured far enough downstream from any elbow to avoid excessive turbulence occurring just downstream of the elbow. To obtain a reliable average velocity, take several velocity readings across the diameter of the pipe to position the pitot tube to read maximum velocities. The change in velocity across the pipe diameter is readily apparent. Measure and record flow data at start and end of the catch test. Flow, velocity, and operating pressure can change when other self move systems within the same pumping system are turned on or off during the test. On center pivot systems, end guns and corner swing laterals turning on or off affect flow rate and nozzle discharge along the lateral during the test.

Without regularly scheduled maintenance and calibration, flow data accuracy from onfarm system flow meters is questionable. Poor water quality (debris, sediment, salts, manure, aquatic creatures) causes accelerated wear on impellers and bearings of flow meters. Ultrasonic meters should only be used where turbulence and excessive air movement inside the conduit are minimal. To use only flow and velocity meters that are regularly checked and calibrated is advisable. Poorly maintained flow and velocity meters often provide readings that are 10 to 40 percent in error from actual.

Step 3—Determine operating pressure. As a minimum, operating pressure should be checked at the water source point and near the far end. A pressure gauge may be permanently installed, but do not rely on the reading it displays. Use a gauge that has been recently calibrated or checked. If the evaluator does not want to get wet while checking operating pressures, gauges can be installed and removed from sprinkler or spray head fittings when the system is not running. Installing a short 1/4 inch pipe nipple and ball valve generally costs less than having personnel return to the site to remove a pressure gauge. If sprinkler heads are the impact type, a pitot tube attachment in the pressure gauge can be used to measure operating discharge pressure at the nozzle. A warm day is definitely desirable when using a pitot tube to check operating pressures. Check pressure at several locations along the lateral if possible. Record pressure and location on worksheets.

Pressures can be more easily read when using a liquid filled gauge. The liquid provides a dampening of the gauge needle and improves gauge durability.

Step 4—Determine wind speed and direction, lateral line location, air temperature, and humidity level. Record data on worksheets.

Step 5—Step catch containers. For center pivot laterals, set catch containers on a radius along and in front of the lateral so the sprinkler lateral passes perpendicularly across the row(s) of containers. For linear move laterals, set the catch containers in a straight row in front of the lateral. Any catch container can be used; however, it must be calibrated. The catch container should have a sharp edge. For straight sided containers, the entry rim area is measured and the equivalent capacity in cubic centimeters (milliliter) for 1-inch application depth computed. For stackable tapered sided containers, a graduated cylinder is used to measure catch in the containers. The cross sectional area of the top of the container is used to calculate application depth either in inches or millimeters. Large rain gauges can be used as catch containers and can be read directly.

Set containers in a straight line at any uniform interval (usually 30 feet). Start at the pivot point and extend to a point beyond the wetted area at the outer end of the lateral. The lip of each catch container should be reasonably level. Move individual containers to avoid

tower wheels. On water drive systems, containers located under driver discharge will collect abnormal amounts of water. These should be relocated or discounted during calculations. If crops are too tall to permit unobstructed catches with containers on the ground, use short stakes and rubber bands to locate containers above foliage. Stakes holding catch containers should not extend above the containers.

Step 6—Allow the lateral to pass completely over the containers. With center pivot laterals, it may be desirable to omit catch containers close to pivot point (first one or two spans). The time it takes for the lateral to completely pass over these containers may be longer than is desirable to complete an evaluation, unless containers can be left for several hours or overnight. Also, the percent of field irrigated by the first one or two spans, is small on large pivots.

Step 7—Read or measure the amount of water caught in each catch container. After the lateral has passed completely over all of the containers, measure and record catch volume or water depth. Use a graduated cylinder to measure volume of catch if tapered sided containers are used. Do not measure and record volume of water or catch in containers that have tipped, partially spilled, or if it appears nearby foliage affected catch. Using a graduated cylinder for straight sided containers generally improves accuracy and can be faster.

If containers are left overnight or for long periods during hot and windy conditions, set out an evaporation pan upwind of the test area. Fill the container with a known volume of water (half of the irrigation application depth is recommended) at start of test and then record volume (depth) when other containers are measured and recorded. Evaporation adjustments should be made on all readings. Use the same type of container for both evaporation check and catch. A small amount of mineral oil added to each container protects against evaporation losses.

Step 8—Catch data reduction. With center pivot lateral evaluations, volume or depth caught in each container must be weighted because the catch points represent progressively larger areas as the distance from the pivot increases. To weight the catches according to their distance from the pivot point, each container value must be multiplied by a factor related to the distance from the pivot point. This weighting factor is

simplified by using uniform spacing of catch containers and using the container position number as the weighting factor. A worksheet is set up with predetermined factor values.

When evaluating linear move laterals, radial adjustment of catch values is unnecessary as sprinklers move in a straight path and each one irrigates the same area regardless of their location along the lateral.

For the weighted low quarter average application depths, the number of containers that represent the low quarter of the irrigated area must be determined. The low quarter is selected by picking progressively larger (nonweighted) catches and keeping a running total of the associated position number until the subtotal approximates a fourth of the sum of all catch position numbers.

Step 9—Determine maximum application rate. By careful observation along the lateral, an area representing maximum infiltration rate for the present site conditions can generally be observed. No surface ponding, translocation, or runoff should be occurring. Typically with medium textured soil, this location is about 75 to 85 percent of the distance from pivot on a quarter mile lateral. This location varies with soil texture, soil condition, surface storage, type of spray pattern, and pressure of discharge device. Several measurements should be taken throughout the field (representing a specific soil series and surface texture) to represent a reliable value that can be used in the local irrigation guide.

Temporary surface ponding is a reliable method to extend infiltration opportunity time, especially on the outer end of low pressure, in-canopy sprinkler heads (including LEPA). No water translocation or runoff should be occurring.

(iii) Evaluation computations—The information gathered in the field procedures is used in the detailed system evaluation computations. Example 9-7 outlines the computations used to complete the worksheet, Sprinkler Irrigation System Detailed Evaluation for Center Pivot Lateral Systems (exhibit 9-7).

Exhibit 9-7 Completed worksheet—Sprinkler irrigation system, detailed evaluation of continuous/self move center pivot lateral

U.S. Department of Agriculture
Natural Resources Conservation Service
Sheet 1 of 7

Example - Sprinkler Irrigation System Detailed Evaluation Center Pivot Lateral Worksheet

Land user Joe Example Field office _____
 Observer _____ Date _____ Checked by _____ Date _____

Field name/number _____
 Center pivot number 5 pivot location in field South 1/4
 Acres irrigated 130

Hardware inventory:
 Manufacturer: name and model Valley low pressure
 Is design available? Yes (attach copy) Number of towers 7 Spacing of towers 170'
 Lateral: Material AL, Inside diameter 6 inches
 Nozzle: Manufacturer Senniger
 Position Trailing Height above ground 12 -15 ft
 Spacing 8 ft
 Is pressure regulated at each nozzle? Y operating pressure range 25 - 30
 Type of tower drive electric
 System design capacity 800 gpm, system operating pressure 32 psi

Nozzle data, design:	Pivot	25	90	end
Sprinkler position number	<u>5</u>	<u>25</u>	<u>90</u>	<u>150</u>
Manufacturer	<u>Senniger</u>	<u>same</u>	<u>same</u>	<u>same</u>
Model	_____	_____	_____	_____
Type (spray, impact, etc.)	<u>spray</u>	<u>same</u>	<u>same</u>	<u>same</u>
Nozzle or orifice size	_____	_____	_____	_____
Location	_____	_____	_____	_____
Wetted diameter (ft)	<u>20'</u>	<u>20'</u>	<u>20'</u>	<u>20'</u>
Nozzle discharge (gpm)	_____	_____	_____	_____
Design pressure (psi)	_____	_____	_____	_____
Operating pressure	_____	_____	_____	_____

End gun make, model _____ (when continuously used in corners)
 End gun capacity 71 gpm, Pressure 18 psi, boosted to 60 psi
 End swing lateral capacity _____ gpm, pressure _____ psi

Field observations:
 Crop uniformity _____
 Runoff _____
 Erosion _____
 Tower rutting _____
 System leaks _____
 Elevation change between pivot and end tower 15 ft +/-

Exhibit 9-7 Completed worksheet—Sprinkler irrigation system, detailed evaluation of continuous/self move center pivot lateral—Continued

U.S. Department of Agriculture
Natural Resources Conservation Service

Sheet 2 of 7

Example - Sprinkler Irrigation System
Detailed Evaluation Center Pivot Lateral Worksheet

Wind: Speed 5 +/- mph Direction (from) SE

Line direction: From center to outer tower East moving CCW

Time of day 1100, Humidity: low med high, Air temp _____

Evaporation: start depth _____ inches, end depth _____ inches, Evaporation _____ inches

Crop alfalfa, Root zone depth 5 foot, MAD^{1/} 50 %, MAD 3.6 inches

Soil-water data (typical): (show location of sample site on soil map or sketch of field)

Moisture determination method feel and appearance

Soil series name, surface texture unknown

Depth	Texture	*AWC (in) ^{1/}	*SWD (%) ^{1/}	*SWD (in) ^{1/}
<u>0-1'</u>	<u>L</u>	<u>2.0</u>	<u>50</u>	<u>1.0</u>
<u>1-2'</u>	<u>LFS</u>	<u>1.5</u>	<u>45</u>	<u>0.7</u>
<u>2-3.5'</u>	<u>VFLS</u>	<u>2.25</u>	<u>45</u>	<u>1.0</u>
<u>3.5-5'</u>	<u>GLS</u>	<u>1.5</u>	<u>20</u>	<u>0.3</u>
Totals		<u>7.25</u>		<u>3.0</u>

Comments about soils:

Present irrigation practices:

Typical system application:

Crop	Stage of growth percent	Hours per ^{2/} revolution	Speed setting	Net application (in)
<u>alfalfa</u>	<u>16"</u>	<u>26</u>	<u>50%</u>	_____
_____	_____	_____	_____	_____
_____	_____	_____	_____	_____

Hours operated per day 24 hours

Approximate number of pivot revolutions per season 80

1/ MAD = Management allowed depletion, AWC = Available water capacity, SWD = Soil water deficit

2/ To calculate the hours per revolution around the field, first calculate the average speed the end tower moves per cycle (start to start) = distance in feet divided by time in seconds.

Then: hours per revolution = $\frac{2 \text{ (distance to end tower in feet)} \times \pi}{\text{(end tower speed in ft/s)} \times 3,600 \text{ seconds per hour}}$

Exhibit 9-7 Completed worksheet—Sprinkler irrigation system, detailed evaluation of continuous/self move center pivot lateral—ContinuedU.S. Department of Agriculture
Natural Resources Conservation Service

Sheet 3 of 7

**Example - Sprinkler Irrigation System
Detailed Evaluation Center Pivot Lateral Worksheet****System data:**Distance from pivot point to : end tower 1205 ft, wetted edge 1345 ft* End tower speed: Distance between stakes 50 ftTime at first stake 11:30:00, Time at second stake 11:40:50Time to travel between stakes 10.8 min

* This method is satisfactory for a continuous moving system, but need to allow for moving in start-stop cycles. Recommend using end tower move distance and from start to star. Typically, percent speed setting for end tower represents, 60% = 36 seconds of each minute, 72 seconds of each 2 minutes, etc.

Measured system flow rate 850 gpm, method flow meter

Calculations: _____

Evaluation computations:

Circumference of end tower:

$$\text{Distance to end tower} \times 2\pi = \frac{(6.2832)}{1205} \times 6.2832 = \underline{7571} \text{ ft}$$

End tower speed:

$$\frac{\text{Distance traveled (ft)} \times 60}{\text{Time in minutes}} = \frac{50 \times 60}{10.8} = \underline{278} \text{ ft/hr}$$

Hours per revolution:

$$\frac{\text{Circumference at end tower (ft)}}{\text{End tower speed (ft/hr)}} = \frac{7571}{278} = \underline{27.2} \text{ hr}$$

Area irrigated:

$$\frac{(\text{Distance to wetted edge})^2 \times \pi}{43,560 \text{ square feet/acre}} = \frac{(3.1416) \times 1345^2}{43,560} = \underline{130.5} \text{ ac}$$

Gross application per irrigation:

$$\frac{\text{Hours per revolution} \times \text{gpm}}{435 \text{ x acres irrigated}} = \frac{27.2 \times 850}{435 \times 130.5 \text{ ac}} = \underline{0.39} \text{ in}$$

Weighted system average application:

$$\frac{\text{Sum of: catch x factors}}{(\text{Sum of: factors}) \times \text{number of containers}} = \frac{64155}{969} = \underline{66.2} \text{ cc (ml)}$$

Exhibit 9-7 Completed worksheet—Sprinkler irrigation system, detailed evaluation of continuous/self move center pivot lateral—Continued

U.S. Department of Agriculture
Natural Resources Conservation Service

Sheet 4 of 7

Example - Sprinkler Irrigation System Detailed Evaluation Center Pivot Lateral Worksheet

Convert cc (ml) in measuring cylinder to inches depth in catch container:

200 cc (ml) = 1 inch in catch container

$$\text{Average application} = \frac{\text{Average catch (cc)}}{\text{cc/inch}} = \frac{11840}{242} = \underline{48.9} \text{ in}$$

Weighted low 1/4 average application:

$$\frac{\text{Sum of low 1/4 catch x factors}}{(\text{Sum of low 1/4 factors}) \times \text{number of low 1/4 containers}} = \frac{11840}{242} = \underline{48.9} \text{ cc (ml)}$$

$$\text{Low 1/4 average application} = \frac{\text{Average low 1/4 (cc)}}{\text{cc/inch}} = \frac{48.9}{200} = \underline{0.24} \text{ in}$$

Distribution uniformity low 1/4 a (DU):

$$\text{DU} = \frac{\text{Weighted low 1/4 average applic.}}{\text{Weighted system average application}} = \frac{0.24}{0.33} = \underline{72.7} \%$$

Approximate Christiansen uniformity (CU):

$$\text{CU} = 100 - [0.63 \times (100 - \text{DU})] = 100 - [0.63 \times (100 - \underline{72.7})] = \underline{82.8} \%$$

Effective portion of water applied (R_e):

$$R_e = \frac{\text{Weighted system average application (in)}}{\text{Gross applicaiton (in)}} = \frac{0.33}{0.39} = \underline{0.846}$$

Application efficiency of low 1/4 (E_q):

$$E_q = \text{DU} \times R_e = \underline{72.7 \times 0.846} = \underline{70} \%$$

(Use for medium to high value crops)

Approximate application efficiency low 1/2 (E_h):

$$E_h = \text{DU} \times R_e = \underline{82.8 \times 0.846} = \underline{70} \%$$

(Use for low value field and forage crops)

Exhibit 9-7 Completed worksheet—Sprinkler irrigation system, detailed evaluation of continuous/self move center pivot lateral—ContinuedU.S. Department of Agriculture
Natural Resources Conservation Service

Sheet 5 of 7

**Example - Sprinkler Irrigation System
Detailed Evaluation Center Pivot Lateral Worksheet**

Application:

$$\frac{\text{Gross application x hours operated per day x } (E_q \text{ or } E_h)}{\text{Hours per revolution x 100}}$$

$$= \frac{0.39 \times 24 \times 61.5}{27.2 \times 100} = 0.21 \text{ in/day}$$

Maximum average application rate:

$$\frac{\text{Maximum catch inches x 60}}{\text{Time containers are uncovered in minutes}} = \frac{0.18 \times 60}{5} = 2.16 \text{ in/hr}$$

Pivot revolutions required to replace typical annual moisture deficit:

(Based on existing management procedures)

Annual net irrig. requirement 14.9 in, for alfalfa (crop)

Pivot revolutions required:

$$\frac{\text{Annual net irrig. requirement x 100}}{(E_q \text{ or } E_h) \times \text{gross applic. per irrig.}} = \frac{14.9 \times 100}{70 \times .39} = 55$$

Potential water and cost savings

Present management:

Gross applied per year = gross applied per irrig x number of irrig

$$= 0.39 \times 55 = 21.5 \text{ in/yr}$$

Potential management:

Potential application efficiency (E_{pq} or E_{ph}) 80 percent (from irrigation guide, NEH Sec 15, Ch 11, or other source)Potential annual gross applied = $\frac{\text{Annual net irrig. requirement x 100}}{\text{Potential } E_{pq} \text{ or } E_{ph}}$

$$= \frac{14.9 \times 100}{80} = 18.6 \text{ inches}$$

Exhibit 9-7 Completed worksheet—Sprinkler irrigation system, detailed evaluation of continuous/self move center pivot lateral—Continued

U.S. Department of Agriculture
Natural Resources Conservation Service

Sheet 6 of 7

**Example - Sprinkler Irrigation System
Detailed Evaluation Center Pivot Lateral Worksheet**

Total annual water conserved:

= $\frac{\text{(Present gross applied - potential gross applied)} \times \text{area irrig. (acre)}}{12}$

= $\frac{(21.5 - 18.6) \times 130}{12}$ = 31.4 acre feet

Sheet 1 of 7

Cost savings:

Pumping plant efficiency _____ kind of fuel _____

Cost per unit of fuel _____ fuel cost per acre foot \$ _____

Cost savings = fuel cost per acre foot x acre foot conserved per year

= _____ = \$ _____

Water purchase cost:

= Cost per acre foot x acre feet saved per year = _____

= \$ _____

Cost savings = pumping cost + water cost = _____ = \$ _____

Recommendations:

Exhibit 9-7 Completed worksheet—Sprinkler irrigation system, detailed evaluation of continuous/self move center pivot lateral—Continued

U.S. Department of Agriculture
Natural Resources Conservation Service

Sheet 7 of 7

**Example - Sprinkler Irrigation System
Detailed Evaluation Center Pivot Lateral Worksheet**

Container spacing 30 feet

Container No.	Factor	Catch (cc)	Catch (cc) x Factor	Catch (in)
1	1	out		
2	2	out		
3	3	out		
4	4	60	240	.30
5	5	75	375	.38
6	6	75	450	.38
7	7	60	420	.30
8	8	70	560	.35
9	9	75	675	.38
10	10	70	700	.35
11	11	80	880	.40
12	12	75	900	.38
13	13	85	1,105	.43
14	14	70	980	.35
15	15	Tipped over		-
16	16	70	1,120	.35
17	17	70	1,190	.35
18	18	85	1,530	.43
19	19	100	1,900	.50
20	20	80	1,600	.40
21	21	65	1,365	.33
22	22	65	1,430	.33
23	23	75	1,725	.38
24	24	60	1,440	.30
25	25	65	1,625	.33
26	26	80	2,080	.40
27	27	75	2,025	.38
28	28	55	1,548	.28
29	29	85	2,465	.43
30	30	70	2,100	.35
31	31	75	2,325	.38
32	32	70	2,240	.35
33	33	65	2,145	.33
34	34	65	2,210	.33
35	35	85	2,975	.43
36	36	55	1,980	.28
37	37	65	2,405	.33
38	38	55	2,090	.28
39	39	70	2,730	.35
40	40	60	2,400	.30
41	41	65	2,665	.33
42	42	55	2,310	.28
43	43	40	1,720	.20
44	44	35	1,540	.18
45	45			
46	46			
47	47			

Container No.	Factor	Catch (cc)	Catch (cc) x Factor	Catch (in)
48	48			
49	49			
50	50			
51	51			
52	52			
53	53			
54	54			
55	55			
56	56			
57	57			
58	58			
59	59			
60	60			
61	61			
62	62			
63	63			
64	64			
65	65			
66	66			
67	67			
68	68			
69	69			
70	70			

Sum 969 64,155
.25 x sum of factors 969 = 242

Low 1/4 summation:

44	44	35	1,540
43	43	40	1,720
42	42	55	2,310
38	38	55	2,090
36	36	55	1,980
28	28	55	1,540
7	7	60	420
4	4	60	240

Sum 242 11,840 (low 1/4)

Max application rate data (5 minute catch)

1		15		
2		25		
3		35		18
4		25		
5		20		

Max. rate = max. catch (in) x 60 = 2.16 inches/hour
5 minutes

Exhibit 9-7 Completed worksheet—Sprinkler irrigation system, detailed evaluation of continuous/self move center pivot lateral—Continued

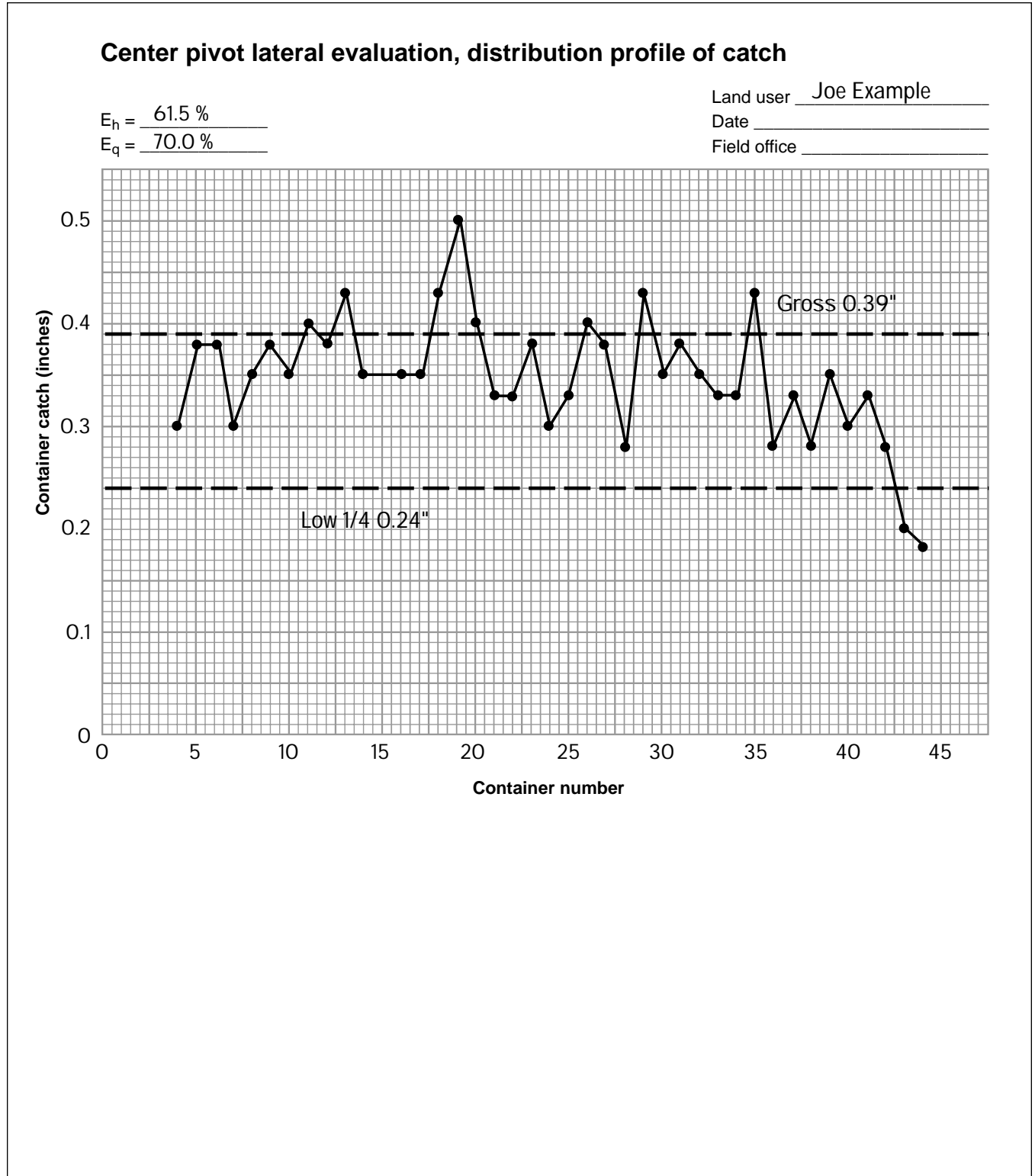

Example 9-7 Evaluation computation steps for continuous move center pivot and linear move laterals**1. Compute maximum application rate:**

$$\text{Application rate, in/hr} = \frac{(\text{maximum catch volume, cc}) \times (60 \text{ min/hr})}{(\text{conversion factor, cc/inch}) \times (\text{time containers are uncovered, min})}$$

2. Determine tower speed:

For center pivot laterals, set a stake next to and in front of the end tower. Start timing when a specific part of the end tower moves past the stake. After the lateral has been in operation for at least 20 minutes, set a second stake in line with the same part of the end tower in its new position. Record time required for travel between stakes or marks, and measure the distance. Use sufficient time and distance to minimize effects of stop and start sequences during the speed check. Generally, the same procedure is used for linear move laterals except any tower can be used. Speed is determined as follows:

$$\text{Speed, ft/hr} = \frac{(\text{distance traveled, ft}) \times (60 \text{ min/hr})}{(\text{time, min})}$$

3. Determine hours per irrigation (revolution for center pivot laterals):

linear move lateral:

$$\text{hours/pass} = \frac{(\text{feet traveled by lateral})}{(\text{lateral speed, ft/hr})}$$

center pivot lateral:

$$\text{hours/rev} = \frac{(\text{circumference of end tower, ft})}{(\text{end tower speed, ft/hr})}$$

where:

$$\text{circumference of end tower} = (\text{distance from pivot to end tower, ft}) \times 2\pi$$

$$\pi = 3.1416$$

$$2\pi = 6.2832$$

4. Determine area irrigated by system:

linear move lateral:

$$\text{area, acres} = (\text{lateral length, ft}) \times (\text{feet traveled by lateral})$$

center pivot lateral:

$$\text{area, acres} = \frac{(\text{distance from pivot to outer wetted area, ft})^2}{43,560 \text{ ft}^2 / \text{acre}} \times \pi$$

Example 9-7 Evaluation computation steps for continuous move, center pivot linear move and lateral systems—Continued**5. Determine system capacity using flow data or pipe flow velocity data from meters:**

From flow meter, read direct in gallons per minute or convert as necessary. System capacity flow is determined using velocity meter data with equation:

$$Q = A \times V$$

where:

Q = flow in system, ft³/s

A = cross sectional area of lateral pipe, ft²

V = average velocity in lateral pipe, ft/s

conversion units: 1 ft³/s = 450 gpm (approximate)

6. Determine gross application per irrigation per revolution:

center pivot/lateral:

$$\text{gross application, acre - inches} = \frac{(\text{hours per revolution}) \times (\text{system capacity in gpm})}{453 \times (\text{irrigated area, acre})}$$

linear move/lateral:

$$\text{gross application, acre - inches} = \frac{(\text{hours per pass or set}) \times (\text{system capacity in gpm})}{453 \times (\text{irrigated area, acre})}$$

7. Determine weighted system average application:

linear move/lateral:

$$\text{average application volume, cc} = \frac{\text{sum of catch, cc}}{\text{number of containers}}$$

center pivot/lateral:

$$\text{average volume, cc} = \frac{\text{sum of (catch} \times \text{factors)}}{\text{sum of factors}}$$

$$\text{average application, inches} = \frac{\text{average volume, cc}}{\text{conversion, cc/in}}$$

(The conversion, cc/in, is dependent on the catch container opening during the test.)

Example 9-7 Evaluation computation steps for continuous move center pivot and linear move laterals—Continued**8. Determine low quarter average application:***linear move lateral:*

$$\text{low } \frac{1}{4} \text{ ave. application} = \frac{\text{sum of } \frac{1}{4} \text{ catch containers}}{\text{number of containers}}$$

center pivot lateral:

$$\text{weighted low } \frac{1}{4} \text{ ave. application} = \frac{\text{sum of } \left(\text{low } \frac{1}{4} \text{ catch} \times \text{factors} \right)}{\text{sum of low } \frac{1}{4} \text{ factors}}$$

Note: With center pivot laterals, each sprinkler irrigates a different size area. Thus a weighted low quarter average application must be used.

9. Determine distribution uniformity low quarter (DU):*linear move lateral:*

$$\text{DU} = \frac{\text{low average application}}{\text{average application}}$$

center pivot laterals:

$$\text{DU} = \frac{\text{weighted low average application}}{\text{weighted system average application}}$$

10. Determine approximate Christiansen's uniformity (CU):

$$\text{CU} = 100 - [0.63 \times (100 - \text{DU})]$$

11. Determine effective portion of applied water, R_e :

Effective portion of applied water is frequently confused with and called application efficiency. Application efficiency is water stored in the plant root zone divided by gross application. Application efficiency accounts for all losses between the pump and the plant, including leaks, evaporation, spray drift, water drive use, deep percolation, and runoff. With pivot irrigation systems, the application amount per revolution generally is less than the soil-water deficit. It usually takes more than one revolution to apply the total soil-water deficit for a mature plant.

Example 9-7 Evaluation computation steps for continuous move center pivot and linear move laterals—Continued

Effective portion of applied water compares the amount of water pumped to the amount caught in catch containers. Any difference is a loss that results from evaporation, spray drift, leaks, or drive losses on water drive systems. It does not account for deep percolation and runoff. The effective portion of applied water can be estimated from figure _____, chapter _____, or figure 11-17 in chapter 11 of the National Engineering Handbook, section 15, by entering the chart with observed data on wind velocity, humidity, temperature, coarseness of spray, and potential crop ET rate. When data are available from a field evaluation, the actual effective portion of applied water is computed as follows:

linear move lateral:

$$R_e = \frac{\text{system average application, inches}}{\text{gross application, inches}}$$

center pivot lateral:

$$R_e = \frac{\text{weighted system average application, inches}}{\text{gross application, inches}}$$

12. Determine application efficiency of low quarter:

$$E_q = DU \times (R_e)$$

13. Determine net application per day:

$$\text{net application, inches} = \frac{(\text{gross application, in}) \times (\text{hours operated per day}) \times E_q}{(\text{hours per irrigation}) \times 100}$$

Note: The hours per irrigation are per revolution for center pivot laterals.

14. Determine maximum application rate:

$$\text{maximum rate, in/hr} = \frac{(\text{maximum catch, inches}) \times (60 \text{ min/hr})}{(\text{time containers are uncovered, min})}$$

15. Estimate number of irrigations (or pivot revolutions) required to replace seasonal moisture or net irrigation requirement (NIR). Obtain NIR from local irrigation guide for crop and climatic area.

linear move lateral:

$$\text{Irrigations required} = \frac{\text{NIR} \times 100}{E_q \times \text{gross application per irrigation, inches}}$$

center pivot lateral:

$$\text{Revolutions required} = \frac{\text{NIR} \times 100}{E_q \times \text{gross application per revolution, inches}}$$

Example 9-7 Evaluation computation steps for continuous move center pivot and linear move laterals—Continued**16. Prepare a plot of catch can data.**

Plot the depth of water caught in containers (inches) against the location of the container with respect to the water supply (pivot) pivot point. Plot straight lines across the graph for gross application, average (weighted) application, and low quarter application. This graph can be one of the best tools for explaining the results of the evaluation to the irrigation decisionmaker.

Potential water conservation and pumping costs savings:

- 1. Make a best estimate of the present gross application applied for the season.** This is based on information about present irrigation scheduling and application practices obtained from the irrigator and on data derived from the evaluation.
- 2. Determine potential system application efficiency.** Use information in the local irrigation guide or other sources. Approximate range of potential E_q values is 75 to 85 percent. Range is based on full canopy crops and assumption that the system is well designed, maintained, and managed.

3. Determine potential gross seasonal application:

$$\text{gross seasonal application, inches} = \frac{\text{NIR} \times 100}{\text{potential } E_q}$$

where:

NIR = seasonal net irrigation requirement

4. Determined total potential average annual water conserved in acre-feet:

$$\frac{(\text{present gross application, inches}) - (\text{area irrigated, acres})}{12}$$

5. If cost is a factor, compute cost savings:

Pumping cost savings: From cost data received from irrigator or by a separate pumping plant evaluation, determine pumping plant operating costs per acre foot of water pumped.

$$\text{Pumping cost savings} = (\text{energy cost per acre foot}) \times (\text{acre feet conserved per year})$$

Water purchase cost savings: Obtain water purchase cost per year from irrigator. In water short areas, many irrigation organizations use a sliding scale for water use billings; i.e., a billing rate for a minimum volume, with increasing rates for increasing use over and above the minimum. Some organizations bill for a fixed volume of water whether used or not.

$$\text{Water purchase cost savings} = (\text{water cost per acre foot}) \times (\text{water saved per year in acre feet})$$

Determine total cost savings.

Example 9-7 Evaluation computation steps for continuous move center pivot and linear move laterals—Continued**Analysis of data and preparation of recommendations:**

1. Compare soil-water deficit (SWD) with management allowed depletion (MAD). This indicates whether the existing method of irrigation scheduling is adequate and whether the right amount of water was being applied. Suggest improving irrigation scheduling techniques if needed. Determine what level of intensity of irrigation scheduling the irrigation decisionmaker can reasonably use.
2. Compare evaluation results to manufacturer's design.
3. Consider existing and potential water translocation, field runoff, and erosion problems as to irrigation system operation, including soil, water, and plant management practices. All sprinkler irrigation systems, especially low pressure in-canopy center pivot laterals, require some degree of soil, water, and plant management to prevent water translocation. Suggest those changes necessary in irrigation water management, operation speed, pressure adjustment, cultural practices, and surface storage needs. Make recommendations that are practical and can reasonably be implemented by the irrigation decisionmaker.

Making management changes is always the first increment of change. Recommending irrigation system changes, along with appropriate management changes, is secondary.

(7) Continuous move, large sprinkler gun type (travelers)

The efficiency of sprinkler irrigation systems changes with time. Nozzles, guns, and pumps wear (lose efficiency), and pipes and joints develop leaks. Some systems are used in ways they were not designed. Sprinkler system evaluations are designed to identify problems and develop solutions. Before a detailed evaluation is made, obvious operating and equipment deficiencies should be corrected by the water user. However, observing and evaluating a poorly designed, installed, or operated system may be a good training exercise to improve competence. Some ingenuity is necessary to check operating pressure of the sprinkler near the nozzle. The high sprinkler gun discharge rate and the continuous moving system make field checking of nozzle discharge unfeasible. Safety during sprinkler gun return rotation also is a factor. It is recommended a calibrated pressure gauge be installed and the nozzle measured when the system is not operating.

Typically, large traveling sprinkler guns are used on irregular shaped fields. With a flexible drag hose to convey water and either a cable and power winch or slow-moving, self-contained, tractor-powered hose reel unit, the sprinkler gun operates as it moves along a lane. Typical operating pressure is 75 to 100 pounds per square inch, and discharge from the sprinkler gun is 200 to 650 gallons per minute. Application rates near the sprinkler gun are relatively high and decrease toward the outer edge of the circle. For effectiveness, traveling large sprinkler guns should apply water in a half circle rearward of the application device. This keeps water and agricultural liquid wastes from spraying the application device, and the device is traveling on relatively dry soil.

(i) Equipment—The equipment needed for a continuous move, large sprinkler gun type system includes:

- Catch containers and stakes
- 50-foot tape
- 500-milliliter (cc) graduated cylinder
- Pressure gauge, 0 to 140 pounds per square inch pressure range
- Inside diameter measurement calipers
- Soil auger, push tube sampler, probe, shovel

- Equipment for determining soil moisture amounts (feel and appearance soil moisture charts, Speedy moisture meter and Eley volumeter, or auger and oven drying soil sample containers)
- Stopwatch
- Wind velocity gauge, thermometer (for air temperature)
- Manufacturer's sprinkler head performance charts
- Clipboard and pencil
- Soil data for field
- Camera, boots, rain gear

The worksheet, Sprinkler Irrigation System Detailed Evaluation: Large Gun Type, is also needed. A copy of this worksheet is in chapter 15.

(ii) Procedure—The procedures needed for this system are in two main categories: general and inventory and data collection.

General

Obtain all pertinent information about system hardware from the water user and from visual observations. What are the irrigation decisionmaker's concerns? Observe general system operating condition, crop uniformity, salinity problems, wet areas, dry areas, translocation, runoff, and other site characteristics. The procedure is described in the following steps:

Step 1—Obtain information from the water user about crops, soils and how the field(s) is irrigated; i.e., travel speed, lane spacing, lane length, pattern overlap, application depth per irrigation. Determine the irrigations or application trips per season.

Determine sprinkler gun design specifications; i.e., operating pressure, nozzle type (taper bore or ring nozzle) and inside diameter, system speed. Actual inside diameter can be measured with inside diameter measurement calipers when system is not operating. Depending on size and height of sprinkler gun, to install a pressure gauge may also be desirable when the system is not operating. While the system is in operation, the height of the gun, configuration of the nozzle, and gun return rotations are hazards when checking pressure at the nozzle. Using a pitot tube is not recommended.

Step 2—Estimate soil-water deficit at several locations in front of and behind the traveler. Observe if the full plant root zone was filled to field capacity. Use the feel and appearance, Eley Volumeasure and Speedy Moisture Meter, auger or push tube sampler (Madera sampler), or some other acceptable method. Select a typical location and record the data on the worksheet.

Step 3—At the same time, make note of such soil profile conditions as:

- Depth to water table
- Apparent root development pattern and depth of existing or previous crop (for determining effective plant root zone)
- Root and water movement restrictions:
 - Compacted layers
 - Mineral layers
 - Hardpans or bedrock
 - Soil textures including textural change boundaries (abrupt or gradual)

Inventory and data collection

Step 1—Select a representative location in the field to conduct the evaluation. Look at elevation change and undulations. Pick a representative location ahead of sprinkler. You may need to wait a few hours or schedule another day when the sprinkler is in a desirable location. Sometimes the extreme condition is the operating condition an evaluation is intended to display. More than one evaluation may be needed at different locations in the field and at different times of the day because of the elevation changes in the field, wind drift and evaporation losses between daytime and nighttime, flow or pressure variations, plus many other variables.

Step 2—Determine system flow rate. If a portable flow meter is available, insert the meter in the flexible feed hose at or near a main line valve. Clamp-on ultrasonic flow meters can also be used if a straight section of aluminum pipe can be inserted between the riser and flexible hose. Measure and record flow data at start and end of the evaluation period. Flow, velocity, and operating pressure can change when other sprinklers within the same pumping system are turned on or off during the test.

Without regularly scheduled maintenance and calibration, accurate flow data from onfarm system flow meters is questionable. Poor water quality (debris,

sediment, salts, manure, aquatic creatures) causes accelerated wear on impellers and bearings of flow meters. Ultrasonic type meters should only be used where turbulence inside the conduit is minimal. Use only flow and velocity meters that are regularly checked and calibrated. Poorly maintained flow and velocity meters often provide readings that are 10 to 40 percent in error from actual.

Step 3—Determine operating pressure. Operating pressure should be checked at the sprinkler head in the riser or near the nozzle. A pressure gauge may be permanently installed, but do not rely on the reading it displays. Use a recently calibrated or checked gauge. If the evaluator does not want to get wet while checking operating pressures, gauges can be installed and removed from sprinkler head fittings when the system is not running. A pitot tube attachment on a pressure gauge can be used to measure operating discharge pressure at the nozzle, a process that is difficult and hazardous. A warm day is the most desirable time to field check operating pressures using a pitot tube. Secure the rotating arm mechanism of a large gun type sprinkler before approaching the system. This helps to prevent unexpected rotation and possible injury. Record pressure and location on worksheet.

Pressures can be more easily read when using a liquid filled gauge. The liquid provides a dampening of the gauge needle and increased durability. Also, an adjustment for elevation must be made ($2.31 \text{ ft} = 1 \text{ psi}$) when pressure is obtained below the nozzle.

Step 4—Determine wind speed and direction, lateral line location, temperature, and humidity level. Record on worksheet.

Step 5—Set out equally spaced catch containers in a row in front of the sprinkler and slightly off the direct line of travel where the containers won't be knocked over by the traveler or trailing hose.

Set containers in a straight line perpendicular to the sprinkler line of travel, at any uniform interval (usually 30 to 50 feet). Start at the center of the sprinkler gun lane line and set out catch containers evenly spaced to the outer end of wetted area. The lip of the container should be reasonably level and at approximate crop canopy height. Use short stakes and heavy rubber bands to locate containers above foliage. The stakes should not extend above the containers.

Any container can be used, however they must be calibrated. Use containers with a relatively sharp edge. For straight sided containers, the entry rim area is measured and the equivalent capacity in cubic centimeters (milliliters) for 1-inch application depth computed. For stackable tapered sided containers, a 500 cubic centimeter graduated cylinder is used to measure catch in the containers. The cross sectional area of the top of the container is used to calculate application depth, either in inches or millimeters. Large rain gauges can be used as catch containers and can be read directly.

Start timing when the sprinkler wetted edges begins to pass over containers. Time ceases when containers are no longer receiving water. The time it takes for the sprinkler to completely pass may be longer than is desirable to complete an evaluation, unless containers can be left for several hours or overnight.

Step 6—Read or measure amount of water caught in catch containers. After the wetted pattern has passed completely over all of the containers, measure and record catch volume or water depth. Use a graduated cylinder to measure volume of catch if tapered sided containers are used. Do not measure and record volume of water or catch in any containers that have tipped or partially spilled or if it appears nearby foliage affected the catch.

If containers are left overnight or for a long time during hot and windy conditions, an evaporation container should be set out upwind of the test area. Fill the container with a known volume (depth) of water approximating half the application depth. Record volume (depth) at beginning and end of test. Evaporation adjustments should be made on all readings. Use the same type container for both evaporation check and catch. A slight film (drop) of mineral oil can provide some evaporative protection.

Step 7—Catch data reduction. Because catch container locations for one pass do not reflect overlap from adjacent lane sprinkler gun trips, catch from one side of the wetted pattern that is in the overlap area must be added to other side. Remember, wind causes pattern distortion and influences overlap. Typically, with traveling large gun type sprinkler heads, overlap

is not 100 percent. Overlap distance can be determined in the field by measuring wetted diameter and lane spacing distances. The wetted distance in the outer part of the wetted circle past the midway point between lanes is the overlap area.

Step 8—Determine the sprinkler travel speed. Set a stake next to the sprinkler. Start timing when a specific part of the sprinkler gun moves past the stake. After at least 20 minutes with the sprinkler gun in operation, set a second stake in line with the same part of the sprinkler gun in its new position. Record time required for travel between stakes or marks and measure the distance. Some stationary time at the end of each lane will provide adequate irrigation at edge of field. Speed is determined as follows:

$$\text{Speed, ft/min} = \frac{\text{distance traveled, ft}}{\text{time, min}}$$

Note: The travel speed of some hose reel sprinklers varies because of a constant hose reel velocity irrespective of the effective reel diameter the hose is being wound (or unwound).

(iii) Evaluation calculations—The information gathered in the field procedures is used in the detailed system evaluation computation. Example 9-8 outlines the computations used to complete the example worksheet (exhibit 9-8).

Exhibit 9-8 Completed worksheet—Sprinkler irrigation system, detailed evaluation of continuous move, large sprinkler gun type

U.S. Department of Agriculture Natural Resources Conservation Service	Sheet 1 of 5			
Example - Sprinkler Irrigation System Detailed Evaluation Continuous Move, Large Sprinkler Gun Type				
Land user _____	Date _____ Prepared by _____			
District _____	County _____ Eng job class _____			
Irrigation system hardware inventory:				
Sprinkler gun make <u>Nelson</u> , model <u>201</u> , nozzle type <u>ring</u>				
Nozzle: size <u>1.5</u> inches, _____ mm				
Manufacturer rated discharge, <u>500</u> gpm at <u>100</u> psi giving <u>510</u> ft wetted diameter				
Hose: length, <u>660</u> ft, diameter <u>4</u> inches				
Towpath: spacing <u>330</u> ft				
Elevation difference between first and last location on towpath (+/-) _____ ft or <u>0</u> % slope				
Gun: height <u>6.5</u> ft				
Mainline: material <u>PVC</u> diameter <u>6</u> inches				
Field observations:				
Crop uniformity <u>Good</u>				
Water runoff <u>None</u>				
Erosion <u>None</u>				
System leaks <u>None</u>				
Wind drift <u>No serious wind drift</u>				
Other observations <u>Crop was short midway between paths</u>				

Field data inventory and computations:				
Crop <u>Corn</u> , root zone depth <u>4.0</u> ft, MAD ^{1/} <u>50</u> %, MAD ^{1/} _____ inches				
Soil-water data (typical):				
(Show locations of sample on soil map or sketch of field)				
Moisture determination method <u>Feel</u>				
Soil series and surface texture <u>Deschutes fine sand loam</u>				
Depth	Texture	AWC (in) ^{1/}	SWD (%) ^{1/}	SWD (in) ^{1/}
_____	_____	_____	_____	_____
_____	_____	_____	_____	_____
_____	_____	_____	_____	_____
_____	_____	_____	_____	_____
_____	_____	_____	_____	_____
Totals		_____	_____	_____
Comments about soils and soil condition: _____				

^{1/} MAD = Management Allowable depletion, AWC = Available water capacity, SWD = Soil water deficit

Exhibit 9-8 Completed worksheet—Sprinkler irrigation system, detailed evaluation of continuous move, large sprinkler gun type—Continued

U.S. Department of Agriculture
Natural Resources Conservation Service

Sheet 2 of 5

**Example - Sprinkler Irrigation System
Detailed Evaluation Continuous Move, Large Sprinkler Gun Type**

Present irrigation practices:

Typical irrigation duration _____ hr, irrigation frequency 10 days
Typical number of irrigations per year 15

Test:

Start _____, Stop _____, Duration _____ = _____ hour

Atmospheric data;

Wind: Direction: Initial _____, during _____, final _____
Speed (mph): Initial 5-10, during _____, final _____

Temperature: initial 75 final _____, humidity: _____ low _____ med _____ high

Evaporation container: initial _____, final _____, loss _____ inches

Pressure: 110 psi, at start of test
110 psi, at end of test

Measured flow into the system 520 gpm

Sprinkler travel speed:

at beginning	<u>9.5</u> ft	<u>10</u> min	=	<u>0.95</u> ft/min
at test site	<u>10.0</u> ft	<u>10</u> min	=	<u>1.0</u> ft/min
at terminal end	<u>10.2</u> ft	<u>10</u> min	=	<u>1.02</u> ft/min
average				<u>1.0</u> ft/min

Calculations:

Gross average depth of water applied = $\frac{(\text{gun discharge, gpm}) \times (1.605)}{(\text{tow path spacing, ft}) \times (\text{travel speed, ft/min})}$

$$= \frac{(520 \text{ gpm}) \times (1.605)}{(330 \text{ ft}) \times (1.0 \text{ ft/min})} = 2.53 \text{ in}$$

Average overlapped catches

System = $\frac{(\text{sum all catch totals } 74.87 \text{ in})}{(\text{number of totals } 33)}$ = 2.27 in

Low 1/4 = $\frac{(\text{sum of low 1/4 catch totals } 12.91 \text{ in})}{(\text{number of low 1/4 catches } 8)}$ = 1.61 in

Average application rate = $\frac{(\text{Flow, gpm}) \times (13,624)}{(\text{tow path spacing, ft}) \times (\text{wet sector, deg.})}$

$$= \frac{(520 \text{ gpm}) \times (13,624)}{(255^2 \text{ ft}) \times (290 \text{ deg})} = 0.38 \text{ in/hr}$$

Maximum application rate = (average application rate, in/hr) x (1.5)

Exhibit 9-8 Completed worksheet—Sprinkler irrigation system, detailed evaluation of continuous move, large sprinkler gun type—Continued

U.S. Department of Agriculture
Natural Resources Conservation Service

Sheet 3 of 5

**Example - Sprinkler Irrigation System
Detailed Evaluation Continuous Move, Large Sprinkler Gun Type**

Container test data

Catch can type _____, 200 cc (mL)/in

Left Right

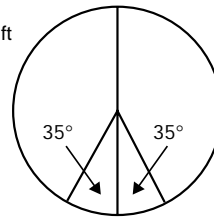

Note part circle operation
and the dry wedge size in degrees

Towpath
and travel
direction

← 4, 3, 2, 1 Container catch row 1, 2, 3, 4 →

Path spacing (ft)	Container catch volume				Right plus left side catch totals	
	Left side of path		Right side of path		mL	inches
	Catch no.	Catch (mL)	Catch no.	Catch (mL)		
330	1	560	33		560	2.80
320	2	540	32		540	2.70
310	3	510	31		510	2.55
300	4	490	30		490	2.45
290	5	505	29		505	2.53
280	6	475	28		475	2.38
270	7	480	27		480	2.40
260	8	460	26		460	2.30
250	9	430	25		430	2.15
240	10	410	24		410	2.05
230	11	370	23		370	1.85
220	12	325	22		325	1.63
210	13	305	21		305	1.53
200	14	345	20		345	1.73
190	15	335	19		335	1.68
180	16	310	18		310	1.55
170	17	305	17		305	1.53
160	18	290	16	35	325	1.62
150	19	250	15	75	325	1.62
140	20	230	14	120	350	1.75
130	21	215	13	215	430	2.15
120	22	165	12	365	530	2.65
110	23	95	11	410	505	2.52
100	24	65	10	515	580	2.90
90	25	25	9	540	565	2.82
80	26	—	8	525	525	2.62
70	27		7	500	500	2.50
60	28		6	490	490	2.45
50	29		5	470	470	2.35
40	30		4	490	490	2.45
30	31		3	540	540	2.70
20	32		2	605	605	3.02
10	33		1	625	625	3.12

Sum of all catch totals 74.87

Sum of low 1/4 catch totals 12.91

Exhibit 9-8 Completed worksheet—Sprinkler irrigation system, detailed evaluation of continuous move, large sprinkler gun type—Continued

U.S. Department of Agriculture

Sheet 4 of 5

Natural Resources Conservation Service

Example - Sprinkler Irrigation System Detailed Evaluation Continuous Move, Large Sprinkler Gun Type

Potential water and cost savings:**Present management:**

$$\begin{aligned} \text{Gross applied per year} &= (\text{Gross applied per irrigation}) \times (\text{number of irrigation}) = \underline{2.53} \text{ in/yr} \\ &+ (\underline{2.53} \text{ in}) \times (\underline{15}) = \underline{38.0} \text{ in/yr} \end{aligned}$$

Potential management:

$$\text{Annual net irrigation requirement} \underline{18.0} \text{ in/yr, for } \underline{\text{Corn}} \text{ (crop)}$$

$$\text{Potential application efficiency (E}_q \text{ or E}_h) \underline{60} \% \text{ (estimated at 55 - 65\%)}$$

$$\text{Potential annual gross applied} = \frac{(\text{annual net irrigation requirement})}{\text{Potential E}_q \text{ or E}_h} \times 100 = \underline{\hspace{2cm}} \text{ in}$$

$$= \left(\frac{\underline{18} \text{ in}}{\underline{60}} \right) \times 100 = \underline{30.0} \text{ inches}$$

Total annual water conserved

$$\begin{aligned} &= \frac{(\text{Present gross applied, inches} - \text{potential gross applied, inches})}{12} \times (\text{area irrigated, ac}) = \underline{\hspace{2cm}} \text{ ac/ft} \\ &= \frac{(\underline{38.0} \text{ in}) - (\underline{30.0} \text{ in})}{12} \times (\underline{80} \text{ ac}) = \underline{53.3} \text{ ac-ft} \end{aligned}$$

Cost savings:

$$\text{Pumping plant efficiency} \underline{\hspace{1cm}} \text{ kind of energy } \underline{\text{Electric}}$$

$$\text{Cost per unit of energy } \$ \underline{\hspace{1cm}} \text{ energy cost per ac-ft } \$ \underline{10.00}$$

$$\text{Cost savings} = (\text{energy cost per ac-ft}) \times (\text{ac-ft conserved per year}) = \$ \underline{\hspace{2cm}}$$

$$= (\underline{10.00}) \times (\underline{53.3}) = \$ \underline{533}$$

Water purchase cost:

$$= (\text{Cost per ac-ft}) \times (\text{ac-ft saved per year}) = \$ \underline{12.50} \times \underline{53.3} = \$ \underline{666}$$

Cost savings:

$$= \text{Pumping cost} + \text{water cost} = \underline{533} + \underline{666} = \$ \underline{1199}$$

Example 9-8 Evaluation computation steps for continuous move, large gun type sprinklers**1. Determine gross depth of water applied:**

The speed checked in the field should nearly match design speed. Speed is based on depth of water applied, gun discharge, and spacing between lanes. Depth of water applied is based on the equation:

$$\text{Gross Ave. depth of water applied} = \frac{1,605 \times (\text{sprinkler discharge, gpm})}{(\text{lane spacing, ft}) \times (\text{travel speed, ft/min})}$$

For ease of use, table 6-10 in chapter 6, section 652.0602(e) of this guide displays this equation in table format. Depending on site conditions (soil, slope, vegetative cover) and application rate, catch containers may not reflect water actually infiltrated because of the water translocation and runoff that occurred. Water translocation and runoff are often greater with large sprinkler gun travelers because of the large water droplet size and velocity upon impact with the ground surface. To obtain net depth of application, assume an application efficiency or determine soil moisture replacement in the plant root zone. Application efficiency of the low quarter, E_q , ranges from 55 to 67 percent where there is little to no wind and with no water translocation or field runoff.

2. Determine system capacity using flow data from a flow meter. Read direct in gallons per minute or convert as necessary. System capacity flow container can also be determined using velocity meter data from the equation:

$$Q = A V$$

where:

Q = flow in system, ft³/s

A = cross sectional area of pipe, ft²

V = average velocity in pipe, ft/s

Conversion units: 1.0 ft³/s = 450 gpm (approximate)

3. Prepare a plot of catch container data. Plot the adjusted depth of water (include adjustment in overlap area) caught in containers (inches) against the location of the container with respect to the sprinkler gun travel path centerline. Average catch is calculated using total catch and dividing by number of containers. Plot this line on the graph. This cross section graph can be one of the best tools for explaining the results of the evaluation to the irrigation decisionmaker.**4. Determine maximum application rate.** An approximation of maximum application rate is determined by using data from catch container(s) with maximum depth of water caught. The maximum average application rate (over entire time water was applied at the specific catch container site) is computed as catch in inches divided by time in hours of test. Since water application pattern approximates a parabola shape (from an adequately operating sprinkler head), maximum rate is about 1.5 times the maximum average rate.

$$\text{Maximum application rate, in/hr} = (\text{average application rate, in/hr}) \times 1.5$$

See section 652.0905(f), Continuous/self move sprinkler, field procedure step 9, for a method to measure maximum application rate.

Example 9-8 Evaluation computation steps for continuous move, large gun type sprinklers—Continued**Potential water conservation and pumping costs savings:**

- 1. Make a best estimate of the present gross water application applied for the season.** This estimate is based on information about present irrigation scheduling and application practices obtained from the irrigator and on data derived from the evaluation.
- 2. Determine potential system application efficiency of the low quarter from information in the local irrigation guide or other sources.** Approximate range of potential E_q values is:

$$E_q = 55 - 65 \%$$

This is based on full canopy crops and assumption that the system is well designed, maintained, and managed, with little to no wind and no translocation.

- 3. Determine potential gross seasonal application:**

$$\text{gross seasonal application} = \frac{\text{NIR} \times 100}{\text{potential } E_q}$$

where:

NIR = seasonal net irrigation requirement

- 4. Determined total potential average annual water conserved in acre-feet:**

$$\frac{(\text{present gross application, inches} - \text{potential gross application, inches}) \times (\text{area irrigated, acres})}{12}$$

- 5. If cost is a factor, compute cost savings:**

Pumping cost savings:

From cost data received from irrigator or by a separate pumping plant evaluation, determine pumping plant operating costs per acre foot of water pumped. Pumping cost savings equals:

$$(\text{energy cost per acre foot}) \times (\text{acre feet conserved per year})$$

Water purchase cost savings:

Obtain from irrigator the water purchase cost per year. In water short areas, many irrigation organizations use a sliding scale for water use billings; i.e., a billing rate for a minimum volume, with increased rates for increasing use over and above the minimum. Others bill for a fixed amount whether used or not. Water purchase cost savings equals:

$$(\text{water cost per acre foot}) \times (\text{water saved per year, acre feet})$$

Determine total cost savings.

Example 9-8 Evaluation computation steps for continuous move, large gun type sprinklers—Continued**Analysis of data and preparation of recommendations:**

1. Compare soil-water deficit (SWD) with management allowed depletion (MAD). This indicates whether the existing method of irrigation scheduling is adequate and whether the right amount of water is being applied. Suggest improving irrigation scheduling techniques if needed. Determine what level of intensity of irrigation scheduling the irrigation decisionmaker can reasonably use.
2. Compare evaluation results to manufacturer's/dealer's design.
3. Consider existing and potential runoff and erosion problems as to operation, cultural, and management practices. Suggest those changes necessary in irrigation water management, such as operation speed, pressure adjustment, cultural practices, and surface storage needs. Cultural practice changes include soil, water, and plant management. Make recommendations that are practical and can reasonably be done by the irrigation decisionmaker.

Making management changes is always the first increment of change. Recommending irrigation system changes, along with appropriate management changes, is secondary.

(8) Micro irrigation systems

Micro irrigation systems, sometimes referred to as trickle or drip systems, are described as the frequent, slow application of water to soil through mechanical devices called drippers, emitters, spray heads, or bubblers. The objective of micro irrigation is to maintain a high soil moisture content in the plant root zone at all times during the irrigation season. This can be accomplished by starting the season with high soil moisture content and replacing the amount depleted by the plant (and some to evaporation) on a 1- to 4-day basis. This is done by delivering the amount of water needed directly to the root zone of each plant through a controlled delivery system.

To accomplish this objective the system must be adequately designed and constructed. A monitoring method to determine the amount of water needed on a daily basis and a method to verify the validity of both the delivery system performance and the amount of water delivered as being adequate are also required.

(i) Components—The various components of a micro irrigation system are shown in a typical layout as in figure 9-29. An adequate filter system is necessary to ensure performance of the controlled delivery (emitters, spray heads, bubblers) at each plant without clogging. Clogged application devices cause poor distribution along the laterals.

Micro irrigation only wets a portion of the soil volume allocated to each plant or row of plants. Where the volume of soil irrigated is small, root growth can be or is restricted. The percentage of the wetted area compared to the total area for each plant depends on the emitter discharge area, discharge rate, spacing of emitters, and soil type. The preferred measure is based on the volume of soil irrigated compared to the total volume available to each plant. Where more than one emitter is used per plant, the wetted volume created by each emitter should overlap in the upper part of the plant root zone as shown in figure 9-30. Where salts are a problem, the overlap should be at the ground surface so salts are not concentrated within the root zone.

One of the objectives in evaluating a micro irrigation system is to determine the average volume of soil wetted per plant. Minimum soil wetted volume appears to be about a third for vines and orchards, and higher for close spaced row crops, such as potatoes, cotton, and tomatoes.

The total plant area does not need irrigating, but overlap should occur in the upper half of the plant root zone and be continuous along the plant row.

The successful operation of a micro irrigation system requires the frequency of irrigation and volume of water applied be carefully scheduled to meet plant

Figure 9-29 Typical split flow layouts for micro irrigation system

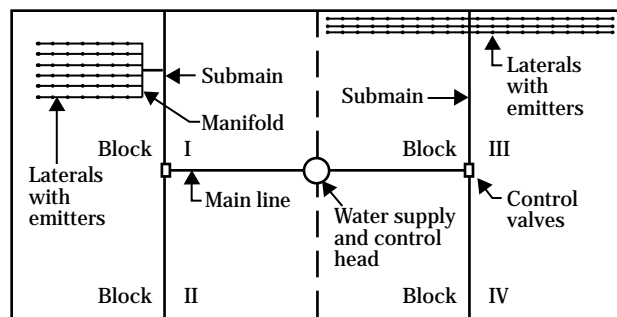
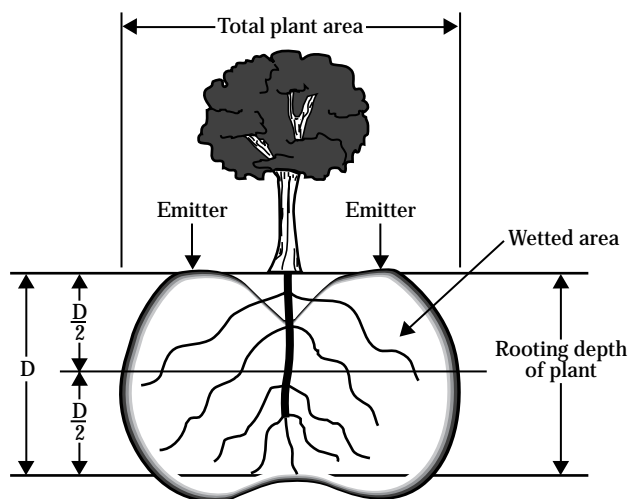

Figure 9-30 Typical wetted area under a plant with two emitters



evapotranspiration (ET). Under-irrigation is easier to detect than overirrigation. Overirrigation is lost to deep percolation and may not be apparent unless the water applied is compared to the plant ET. Properly designed, installed, and operated micro irrigation systems have the capability to place over 90 percent of applied water available for plant use. In reality 65 percent is more common because of inadequate irrigation scheduling resulting in the application of too much water.

The soil salinity level should be checked at various locations from the plant and for various depths to determine if salt buildup is becoming a problem. Where checked periodically, the change in salinity over time is noted.

Field emission uniformity, EU, must be known to properly manage the amount of water applied. Because EU can change throughout the irrigation season, periodic evaluations are needed to determine maintenance needs and irrigation scheduling changes.

(ii) Evaluation process—Use of much of the information is similar to field data and analysis for orchard sprinkler irrigation system. The data needed for evaluating a micro irrigation system can be obtained by determining:

- Duration, frequency, and sequence of operation of a normal irrigation cycle
- Soil-moisture deficit and management allowable depletion
- Rate of discharge and pressure near several emission points spaced throughout the system
- Changes in rate of discharge from emitters after cleaning or other repair
- Percent of soil volume wetted
- Spacing and size of trees, vines, or other plants being irrigated
- Location of emission points relative to trees, vines, or other plants, and uniformity of spacing of emission points.
- Pressure drop at the filter(s)
- General topography

(iii) Equipment—The equipment needed for a micro irrigation system includes:

- Pressure gauge (0 to 50 psi range) with adapters for temporary installation at either end of lateral lines
- Stopwatch

- Graduated cylinder (250 to 500 mL capacity)
- Funnel thave has a 3- to 6-inch diameter
- Shovel, soil auger, or push tube sampler, probe
- Manufacturer's emitter performance charts showing the relationships between discharge and pressure plus recommended operating pressures and filter requirements
- Shop built emitter and spray head catch containers
- Sheet metal or plastic troughs 3 feet long for measuring the discharge from several outlets in a perforated lateral simultaneously or the discharge from a 3-foot length of porous tubing (a piece of 1 1/2 or 2 inch diameter PVC pipe cut in half lengthwise works well)
- Micro Irrigation System Detailed Evaluation Worksheet (see chapter 15)

(iv) Procedure—The following field procedure is suitable for evaluating systems with individually manufactured emitters and systems that use perforated or porous laterals. Record data on evaluation worksheets while collecting the field information.

Step 1—Collect or determine soil and crop characteristics throughout the field.

Step 2—Determine from the irrigation decisionmaker the duration and frequency of irrigation and the concept of applicable MAD.

Step 3—Check and note the pressure at the inlet and outlet of the filter(s) and, if practical, inspect the screens for breaks and other possibilities for contaminants to bypass the screen(s).

Step 4—Collect emitter and lateral information.

Step 5—Locate four emitter laterals along an operating manifold; one should be near the inlet, two near the third points, and the fourth near the outer end. Sketch the system layout and note the general topography, manifold in operation and manifold where the discharge test is conducted.

Step 6—Record system discharge rate and the number of manifolds and blocks (or stations). The number of blocks is the total number of manifolds divided by the number of manifolds in operation at anyone time.

Step 7—For laterals having individual emitters, spray heads, or bubblers, measure the discharge at two adjacent emission points at each of four different tree or plant locations on each of the four selected test laterals. Collect the discharge for a number of full minutes (1, 2, 3, 4, etc.) to obtain a volume between 100 and 200 milliliters for each emission point tested. Convert each reading to milliliters per minute before entering the data on the worksheet. To convert milliliters per minute to gallons per hour, divide milliliters per minute by 63.

These steps produce 8 pressure readings and 32 discharge volumes at 16 different plant locations for individual emission points used in wide-spaced crops with two or more emission points per plant. For perforated tubing, bi-wall, or porous tubing, use a 3- to 5-foot trough and collect a discharge volume at each of the 16 locations described. These are already averages from two or more outlets, so only one reading is needed at each location. Care should be taken to avoid raising an emitter or hose more than a few inches because any raise in elevation reduces discharge pressure and volume.

For relatively wide-spaced crops, such as grapes, where a single outlet emitter or bubbler may serve one or more plants, collect a discharge reading at each of the 16 locations described. Since the plants are only served by a single emission point, only one reading should be made at each location.

Step 8—Measure and record water pressures at the inlet and downstream ends of each lateral tested, preferably under normal operations. On the inlet end, this requires disconnecting the lateral hose, installing the pressure gauge, and reconnecting the lateral before reading the pressure. On the downstream end, the pressure can be read after connecting the pressure gauge the simplest way possible. Be sure to flush the line of sediment and debris before installing the pressure gauge.

Step 9—Check the percentage of soil wetted at one of the plant locations on each test lateral. It is best to select a plant at a different relative location on each lateral. Use a push probe, soil auger, or shovel for estimating the actual extent of the wetted zone below the surface around each plant. Determine the percentage wetted by dividing the wetted area by the total surface area between four plants.

Step 10—If an interval of several days between irrigations is being used, check the SMD in the wetted volume near a few representative plants in the next block to be irrigated. This is difficult and requires averaging samples taken from several positions around each plant.

Step 11—Determine the minimum lateral inlet pressure (MLIP) along each operating manifold. For level or uphill manifolds, the MLIP is at the far end of the manifold. For downhill manifolds it is often about two-thirds the distance down the manifold. With manifolds on undulating terrain, MLIP generally is located on a knoll or high point.

Step 12—Determine the discharge correction factor (DCF) to adjust the average emission point discharges for the tested manifold. This adjustment is needed if the test manifold happened to be operating with a higher or lower MLIP than the system average MLIP. If the emitter discharge exponent, x , is known, use the second formula presented.

Step 13—Determine the average and adjusted average emission point discharges.

(v) Evaluation computations—In micro irrigation all of the system flow is delivered to individual trees, vines, shrubs, plants, rows of plants, or blocks of turf. Essentially, the only opportunity for loss of water is at the tree or plant locations. Therefore, uniformity of emission is of primary concern, assuming the crop is uniform. Locations of individual emission points, or the tree locations where several emitters are closely spaced, can be thought of in much the same manner as container positions in tests of periodic move sprinkler performance.

In exhibit 9-8, there are four single emission points (emitters) per tree in the citrus grove where data were obtained. Therefore, discharge from the two emitters at each tree can be averaged. The minimum rate of discharge (or low quarter) is then the adjusted average discharge of the lowest four (average) discharges per tree, 2.30 gallons per hour for the example evaluation. The adjusted average rate of discharge per tree for the entire system was 2.65 gallons per hour. Example 9-9 shows the computations used for a micro irrigation system evaluation.

Exhibit 9-9 Completed worksheet—Micro irrigation system detailed evaluation

U.S. Department of Agriculture
Natural Resources Conservation Service

Sheet 1 of 3

Example - Micro Irrigation System Detailed Evaluation Worksheet

Land user Joe Example Date _____ Prepared by _____
District _____ County _____

Crop: Citrus age 7 plant and row spacing 22' x 22'

Soil: mapping unit Redcliff L surface texture Loam
actual depth 4 ft AWC 2.0 inches/feet

Irrigation: duration 6 hr frequency 1 da MAD 10 % 0.8 inches/feet

Irrigation system hardware:
Filter: pressure at: inlet 60 psi, outlet 55 psi, loss 5 psi

Emitter: manufacturer SP type flushing spacing 5 ft
Rated discharge per emitter (emission point): 3.0 gph at 30 psi
Emission points per plant 4 giving 72 gallons per plant per day

Later: diameter: 0.58" material PE length 150' spacing 22'

Sketch of micro irrigation system layout:

Exhibit 9-9 Completed worksheet—Micro irrigation system detailed evaluation—Continued

U.S. Department of Agriculture
Natural Resources Conservation Service

Sheet 2 of 3

**Example - Micro Irrigation System
Detailed Evaluation Worksheet**

System discharge: _____ gpm, number of manifolds 32 and blocks 4

Average test manifold emission point discharges at 45 psi

Manifold = $\frac{\text{(sum of all averages } 41.94 \text{ gph)}}{\text{(number of averages } 16 \text{)}} = \underline{2.62} \text{ gph}$

Low 1/4 = $\frac{\text{(sum of low 1/4 averages } 9.07 \text{ gph)}}{\text{(number of low 1/4 averages } 4 \text{)}} = \underline{2.27} \text{ gph}$

Adjusted average emission point discharges at 46.1 psi

System = (DCF 1.012) x (manifold average 2.62) = 2.65 gph

Low 1/4 = (DCF 1.012) x (manifold low 1/4 2.27) = 2.30 gph

Discharge test volume collected in 1.0 minutes (1.0 gph = 63 ML/min)

Outlet location on lateral		Lateral location on the manifold							
		inlet end		1/3 down		2/3 down		far end	
		mL	gph	mL	gph	mL	gph	mL	gph
inlet end	A	132	2.10	160	2.54	192	3.04	195	3.10
	B	160	2.54	188	2.99	140	2.23	205	3.26
	ave		2.32		2.77		2.64		3.18
1/3 down	A	160	2.54	295	3.10	175	2.78	169	2.69
	B	168	2.66	158	2.50	170	2.70	180	2.86
	ave		2.60		2.80		2.74		2.78
2/3 down	A	187	2.97	146	2.31	125	1.99	144	2.29
	B	175	2.78	155	2.46	155	2.46	175	2.78
	ave		2.88		2.38		2.23		2.54
far end	A	170	2.70	190	3.02	210	3.34	151	2.39
	B	125	1.99	135	2.15	166	2.62	130	2.07
	ave		2.34		2.58		2.98		2.18

Exhibit 9-9 Completed worksheet—Micro irrigation system detailed evaluation—Continued

U.S. Department of Agriculture
Natural Resources Conservation Service

Sheet 3 of 3

**Example - Micro Irrigation System
Detailed Evaluation Worksheet**

Lateral:	inlet pressure	<u>47</u> psi	<u>45</u> psi	<u>45</u> psi	<u>45</u> psi
	far end pressure	<u>46</u> psi	<u>43</u> psi	<u>45</u> psi	<u>44</u> psi
Wetted area per plant		<u>150</u> ft ²	<u>125</u> ft ²	<u>140</u> ft ²	<u>145</u> ft ²
		<u>31</u> %	<u>26</u> %	<u>29</u> %	<u>30</u> %

Estimated average SMD in wetted soil volume —

Minimum lateral inlet pressures, MLIP, on all operating, manifolds:

Manifold ID: Test	<u> A </u>	<u> B </u>	<u> C </u>	<u> D </u>	<u> E </u>	<u> F </u>	<u> G </u>	<u> </u>	Ave.
pressure, psi	<u>45</u>	<u>49</u>	<u>47</u>	<u>43</u>	<u>50</u>	<u>48</u>	<u>48</u>	<u> </u>	<u>46.1</u>

Discharge correction factor, DCF, for the system is:

$$DCF = \frac{2.5 \times (\text{average MLIP } \underline{46.1} \text{ psi})}{(\text{average MLIP } \underline{46.1} \text{ psi} + (1.5 \times \text{test MLIP } \underline{45} \text{ psi}))} = \underline{1.015} \text{ psi}$$

or if the emitter discharge exponent, x = 0.5 is known,

$$DCF = \frac{(\text{average MLIP } \underline{46.1} \text{ psi})}{(\text{test MLIP } \underline{45} \text{ psi})} \times \underline{0.5} = \underline{1.012} \text{ psi}$$

Comments: _____

Example 9-9 Evaluation computation steps for micro irrigation systems**Average application depth, D_{aw} :**

The average depth applied per irrigation to the wetted area, D_{aw} , is useful for estimating management allowed depletion (MAD). The D_{aw} in inches is computed from the average gallons per hour (gph) at each emission point, the number of emission points per tree, N , the number of hours of operation per irrigation, and the wetted area per tree in square feet:

$$D_{aw} = \frac{1,605 \times N \times \text{gph} \times \text{hours}}{\text{ft}^2}$$

For the example evaluation:

$$D_{aw} = \frac{1,605 \times 4 \times 2.65 \times 6}{22 \times 22} = 0.21 \text{ inches}$$

Volume per day per tree:

The average number of gallons per day per tree or plant is computed from the average gph at each emission point, the number N of emission points per tree, the number of hours of operation per irrigation, and the irrigation interval in days:

$$\text{Average daily gallons per tree} = \frac{N \times \text{gph} \times \text{hours}}{\text{days}}$$

For the example evaluation:

$$\text{Average daily gallons per tree} = \frac{4 \times 2.65 \times 6}{1} = 63.6 \text{ gpd}$$

Emission uniformity, EU:

To determine whether system application devices are operating at an acceptable efficiency, evaluate the emission uniformity, EU:

$$EU = \frac{\text{minimum rate of discharge per plant}}{\text{average rate of discharge per plant}} \times 100$$

in which the average of the lowest quarter is used as the minimum for each of the four emitters per plant. In the example:

$$EU = \frac{4 \times 2.30}{4 \times 2.65} \times 100 = 87\%$$

General criteria for EU values for systems that have been in operation for at least one season are:

EU (%)	Efficiency
> 90 %	excellent
80 – 90 %	good
70 – 80 %	fair
< 70 %	poor

Example 9-9 Evaluation computation steps for micro irrigation systems—Continued**Potential application efficiency low quarter, PELQ:**

The concept of PELQ used in other evaluation procedures must be modified when evaluating micro irrigation systems. Because micro irrigation wets only a portion of the total soil volume, the SMD must be replaced frequently. SMD is always difficult to estimate because parts of the wetted root zone often remain near field capacity even when the interval between irrigations is several days.

For the example evaluation where irrigations are applied everyday, SMD is practically impossible to estimate. For this reason, SMD must be estimated from weather data or information derived from evaporation devices even though such estimates are subject to error. Because checking for slight under-irrigation is not practical, some margin for safety should be allowed. As a rule, about 10 percent more water than the estimated SMD or evapotranspiration should be applied to the least watered areas. Thus the PELQ under full micro irrigation can be estimated by:

$$\text{PELQ} = 0.9 \times \text{EU}$$

For the example test data:

$$\text{PELQ} = 0.9 \times 87 \% = 78\%$$

In a micro irrigation system, all field boundary effects or pressure variations along the manifold tested are taken into account in the field estimate of EU. Therefore, the estimated PELQ is an overall value for the manifold in the subunit tested except for possible minor water losses resulting from leaks, draining of lines, and flushing (unless leaks are excessive).

Some micro irrigation systems are fitted with pressure compensating emitters or have pressure (or flow) regulation at the inlet to each lateral. However, most systems are only provided with a means for pressure control or regulation at the inlets to the manifolds as was the case with the example system evaluated. If manifold inlet pressures are not properly set, the overall system PELQ is lower than the PELQ of the test manifold. An estimate of this efficiency reduction factor, ERF, can be computed from the minimum lateral inlet pressure, MLIP, along each manifold by:

$$\text{ERF} = \frac{\text{average MLIP} + (1.5 \times \text{minimum MLIP})}{2.5 \times \text{average MLIP}}$$

The ratio between the average emission point discharges in the manifold with the minimum pressure and the system is approximately equal to ERF. Therefore, the system PELQ can be approximated by:

$$\text{System PELQ} = \text{ERF} \times \text{example PELQ}$$

Using the data from the example evaluation and PELQ = 78%, find ERF:

$$\text{ERF} = \frac{46.1 + (1.5 \times 42)}{2.5 \times 46.1} = 0.95$$

and,

$$\text{System PELQ} = 0.95 \times 78 \% = 74 \%$$

Example 9-9 Evaluation computation steps for micro irrigation systems—Continued

A more precise method for estimating the ERF can be made if the emitter discharge exponent, x , is known by

$$\text{ERF} = \frac{(\text{minimum MLIP})}{(\text{average MLIP})}$$

For the example system with orifice type emitters, where $x = 0.5$, this alternative calculation of ERF gives:

$$\text{ERF} = \frac{42^{0.5}}{46.1} = 0.14$$

In this case the two methods for computing ERF give essentially equal results; however, for larger pressure variations or x values higher or lower than 0.5, differences could be significant.

Application efficiency, low quarter (AELQ)

Like PELQ, the concept of AELQ must also be modified for micro irrigation. Effectiveness of a micro system can be estimated by how much of the applied water is stored in the root zone and is available for consumptive use by the plants. Because there are essentially no opportunities for losses by evaporation and wind drift or for inadequate irrigation in which the least watered areas are under-irrigated:

$$\text{System AELQ} = \text{ERF} \times \text{EU}$$

However, if excess water is applied in the least watered areas:

$$\text{System AELQ} = \frac{\text{SMD in wetted area} \times 100}{\text{average depth applied to wetted area}}$$

For an ideal irrigation in which the SMD plus 10 percent extra water is applied to the least watered areas:

$$\text{AELQ} = \text{PELQ}$$

For the example evaluation where daily irrigations were being applied, it was impossible to estimate SMD in the wetted areas around each tree. Furthermore, the average depth applied to the total area, D_a , was only 0.21 inch per day, which is hardly sufficient to meet the expected consumptive use requirements for mature citrus trees at the example evaluation location. Therefore, it is highly probable that the trees were being under-irrigated, in which case for the example EU of 87 percent:

$$\text{System AELQ} = 0.95 \times 87 \% = 83 \%$$

Overall minimum depth applied:

The overall average depth applied to the total area, D_a , multiplied by system PELQ (or AELQ) is useful for managing an irrigation schedule because water requirements are expressed in similar units.

Multiply D_a by the system PELQ except when there is under-irrigation and AELQ is greater than PELQ. For the example evaluation the overall minimum depth applied to the total area, D_n , is:

$$D_n = D_a \times \frac{\text{System PELQ (or AELQ)}}{100}$$

Example 9-9 Evaluation computation steps for micro irrigation systems—Continued

For the example evaluation, which is under-irrigated and has a system AELQ value of 83 percent:

$$D_n = 0.21 \times 83/100 = 0.17 \text{ inch}$$

Analysis and recommendations

Several observations and recommendations can be based on the data collected and the calculation of EU, PELQ, and AELQ.

Pressure differences throughout the operating manifold studied were small. Pressure variations of 20 percent for orifice-type emitters and 10 percent for long tube type result in flow differences of about 10 percent. Obviously each control valve must be adjusted accurately to ensure uniform pressures throughout the field; however, this was not the case as noted by the minimum lateral inlet pressure variations between manifolds as data collected shows.

Uniformity of application throughout the operating manifold, expressed by the EU of 87 percent, was good. Because pressures were nearly constant, most of the lack of application uniformity resulted from variations in operation of the individual emitters. Discharges of emitters A and B at the same location, which would have almost identical pressures, often differed considerably.

Differences in elevation throughout the system were not extreme, so the other manifolds should have produced similar uniformities.

The percentage of wetted area ranged between 26 and 31 percent. This is less than the recommended minimum discussed in the introduction for arid areas.

For the fertilizer application program, urea was injected into the irrigation water to meet nitrogen needs. Other fertilizers were being applied directly to the soil surface and incorporated by cultivation in the fall before the rainy season. This fertilizer program should prove satisfactory and cause no problem with the irrigation equipment.

Emitters—The emitters used in the recorded test were automatic flushing type. The variations in discharge probably resulted from differences in manufacturing tolerances. These emitters, operating at pressures near 45 pounds per square inch, averaged a discharge of 2.62 gallons per hour, which is considerably less than the rated 3 gallons per hour at 30 pounds per square inch. This indicates that the orifices may be closing slowly or clogging after about one season's operation.

Variable clogging can cause large differences in flow from nonflushing emitters even though manufacturing tolerance may be close. Some emitters can be flushed manually. Systems having manually flushed emitters should be flushed monthly, and the change in flow before and after flushing determined. Some outlet emitters are pressure compensating; thus, discharge is constant over a range in pressure variations. Bubbler systems typically use 1/4 to 3/8 inch diameter tubing for outlets where clogging from suspended sediment is not a problem. Insects that build nests in small cavities can be a problem.

Example 9-9 Evaluation computation steps for micro irrigation systems—Continued

Filters—In the example the filter system near the pumping plant seemed to be performing reasonably well. Pressure across it was only 5 pounds per square inch. Small safety screen filters were installed at the inlet to each lateral. This precaution is recommended. Several of these screens were checked at random. All were found reasonably clean; however, several screens had intercepted a considerable amount of coarse material that would have clogged emitters had it passed through the laterals. The operator said that each screen was routinely cleaned after every 1,000 hours of operation.

Changing to a 12-hour irrigation on alternate days instead of continuing the present 6 hours per day could improve the percentage of wetted area because longer applications wet more soil volume. No problems of infiltration were apparent, and the average depth applied to the wet area, D_a , of 0.73 inch could be doubled without exceeding the SMD at a MAD of 30 percent. For example, a total of 8 inches of moisture would be available. The depletion of $2 \times 0.73 = 1.46$ inches gives a MAD of less than 20 percent in the wetted area.

Manifold inlet valves should be adjusted to give the same minimum lateral inlet pressure on each manifold. This increases the system PELQ and AELQ to the PELQ and AELQ of the tested manifold, which is a 5 percent improvement.

It appears emission from laterals has been gradually decreasing, and the system was designed to yield greater flow than was observed. Thus, adding emitters could restore the systems capacity to the original 12 gallons per hour per tree at an average operating pressure of 30 pounds per square inch, while increasing the percent wetted area to almost 40 percent.

The only sure way to improve EU would be to replace the emitters. This is costly and may not be warranted at this time. Chemical treatment may clean some of the mineral deposits and partly restore discharge rate and uniformity.

Overall minimum depth applied to the total area, D_a , (only 0.17 inch per cycle) seems to be marginal for a mature citrus grove during the peak water demand period. Although emitters were rated at 3 gallons per hour when operated at 30 pounds per square inch, the test results in the field indicated an average rate of flow of 2.62 gallons per hour at 45 pounds per square inch. To meet peak demands of water, the flow rate per tree must be restored to the original design of 12 gallons per hour (four emitters at 3 gph) by cleaning or otherwise repairing the emitters, or by adding another emitter to the system at each tree.

Summary

The EU of 87 percent and estimated PELQ of 78 percent of the tested manifold are good. Main system problems are associated with a marginal amount of soil wetted (only about 30%), poor manifold control valve adjustment, and low rates of flow in the system. The irrigation decisionmaker was advised to try scheduling the irrigation to apply water for 12-hour periods on alternate days instead of continuing the current 6 hours per day cycle. He was also urged to:

- Adjust the manifold control valves to obtain equal minimum lateral inlet pressure on all manifolds (it is suggested fittings be installed to allow the use of pressure gauges).
- Clean or repair the emitters, or add an extra emitter at each tree to restore flow rates to the designed volume and to increase the percent of wetted area.

(9) Irrigation pumps

The efficiency of a pump changes with time and depends a great deal on proper maintenance and impeller diameter. Wear ring and impeller wear, corrosion, and metal erosion (cavitation) can affect the efficiency of a pump. Intake screen plugging and pipeline leaks also affect efficiency. Leaks on suction piping are often caused by pinholes in welded joints and loose couplers. Pumps are often used under conditions other than those for which they were designed. Changes in the irrigation system after pump installation often occur. Some pumps are purchased second hand and used in non-optimum situations. Another frequent problem is poor intake and outlet piping configurations. Such problems can dramatically lower pump efficiency. The purpose of a pump evaluation is to identify these problems, determine annual cost attributed to the problems, and make recommendations for modifications to improve operating efficiency and reduce energy use. A pump analysis should be considered part of a complete irrigation system analysis.

National Engineering Handbook, Section 15, Chapter 8, Irrigation Pumping Plants, should be reviewed before doing a pump test. Another useful reference is University of Nebraska's Revised Irrigation Pumping Plant Test Procedure Manual (1985).

(i) Equipment—The equipment needed to test irrigation pumps includes:

- Pressure gauges: one 0 to 100 pounds per square inch and one 0 to 200 pounds per square inch. Liquid filled or waterproof type is recommended.
- Flow meter or other method to determine flow rate.
- Collection of miscellaneous fittings used to install pressure gauges, including pipe thread compound or tape.
- Vacuum gauge: 0 inch to 30 inches Hg (optional, use to find suction head on suction side of pump).
- Electric meter: volts, amps, power factor (for electric motors).
- Hand level and survey rod.
- Pocket tape (inches and tenths of inches).
- Two pipe wrenches, two adjustable wrenches.
- For internal combustion engines:
 - Portable propane tank, hose, and fittings, and scale for weighing tank (if propane engine is analyzed).

- Portable diesel or gasoline tank, hose, and fittings, and scale for weighing tank.
- Method of measuring diesel or gasoline fuel (if weighing scales are not used).
- Watch with stopwatch mode, or stopwatch.
- Pump manufacturer's performance curves for pump(s) being analyzed.
- Pumping plant detailed evaluation worksheet.
- Clipboard and pencil.

Hardware inventory: Obtain the data needed to fill out the data sheet by interviewing the operator and by observing equipment name and data plates. (Use name plate data with caution as component modification(s) may render data obsolete.)

Sketch the pipeline intake assembly and discharge assembly. Show dimensions of component parts. Take pictures of these assemblies.

Safety: Use extreme caution when working around running pumps especially where live drive shafts and belts are exposed. Tie down or remove loose clothing. Use a tick meter to check for stray electrical currents. In the absence of a meter, briefly touch equipment with back of hand. If electrical equipment does not appear to be properly installed or maintained, do not proceed with the evaluation. For personnel safety, observe **no smoking** when performing pump tests where internal combustion engines are used.

The land user or a mechanic should make electrical connections, measure fuel, and make fuel line connections.

(ii) Data inventory and computations—The following steps (example 9–10) are needed to complete testing of irrigation pumps. The information is used in completing the Pumping Plant Detailed Evaluation Worksheet (exhibit 9–10).

Exhibit 9-10 Completed worksheet—Irrigation pumping plant detailed evaluation

U.S. Department of Agriculture Natural Resources Conservation Service	Sheet 1 of 5
Example - Pumping Plant Detailed Evaluation Worksheet	
Land user <u>Joe Example</u> Field office _____ Observer _____ Date _____ Checked by _____ Date _____ Field name or number _____ Acres irrigated _____	
Hardware Inventory: <u>Power plant:</u>	
Electric motor(s): <u>Main pump</u> <u>Booster</u> (if used)	
Make	<u>GE</u> _____
Model	<u>GEPU 25</u> _____
Rated rpm	<u>3450</u> _____
Rated hp	<u>25</u> _____
Internal combustion engine: Make _____ Model _____ Continuous rated hp at output shaft _____ hp at _____ rpm Comments about condition of power plant _____ _____	
Gear or belt drive mechanism: Type: (check one) direct drive _____ gear drive _____ belt drive _____ _____ rpm at driver _____ rpm at pump	
Pumps Type: (centrifugal, turbine, submers.) <u>Centrifugal</u> _____	
Make	<u>Berkeley</u> _____
Model	<u>2 1/2 ZPBL</u> _____
Impeller diameter	<u>8 inches</u> _____
Number of impellers	<u>1</u> _____
Rated flow rate (gpm)	<u>350</u> _____
at head of (ft)	<u>175</u> _____
at rpm	<u>3450</u> _____
Pump curves: Attached <u>Yes</u> (yes or no)	
Comments about condition of equipment _____ _____ _____ _____	

Exhibit 9-10 Completed worksheet—Irrigation pumping plant detailed evaluation—Continued

U.S. Department of Agriculture
Natural Resources Conservation Service

Sheet 2 of 5

Example - Pumping Plant Detailed Evaluation Worksheet

Land user _____ Field office _____

Existing suction or turbine column set-up (sketch showing dimensions)

Existing discharge set-up (sketch showing dimensions)

Data and computations:

Total Dynamic Head (TDH):

Elevation difference - water surface to pump outlet 6 feet

Pressure reading at pump outlet 85 psi

Pressure at pump inlet (where supply is pressurized) — psi

Estimated friction loss in suction pipe or pump column 2 feet

Miscellaneous friction loss 5 feet

TDH = (elevation difference between water source and pump discharge) + (discharge pressure - pressure at inlet) times 2.31 + (estimated suction pipe friction loss) + miscellaneous =

$$\underline{6 + (85 \times 2.31) + 2 + 5} = \underline{209.4} \text{ feet}$$

Flow rate:

Flow meter:

Flow rate = _____ gpm

Velocity meter:

Pipe ID _____ inches

Velocity _____ feet/second

Flow rate, Q, in gpm = (Velocity, in feet/second) x (2.45) x (pipe ID²) =

$$= \underline{\hspace{2cm}} = \underline{\hspace{2cm}} \text{ gpm}$$

Exhibit 9-10 Completed worksheet—Irrigation pumping plant detailed evaluation—ContinuedU.S. Department of Agriculture
Natural Resources Conservation Service

Sheet 3 of 5

Example - Pumping Plant Detailed Evaluation Worksheet

Land user _____ Field office _____

Water horsepower:

$$\text{whp} = \frac{(\text{flow rate, in gpm}) \times (\text{TDH, in feet})}{3960} = \frac{295 \times 209.4}{3960} = 15.6 \text{ hp}$$

Energy input

Electric:

Disk revolutions _____ 10 _____

Time: min _____ sec 53.5 _____ = 53.5 sec

Meter constant (Kh) _____ 28.8 _____

PTR (power transformer ratio - usually 1.0)^{1/} _____ 1 _____CTR (current transformer ratio - usually 1.0)^{1/} _____ 1 _____

$$\text{KW} = \frac{(3.6) \times (\text{disk rev}) \times (\text{Kh}) \times (\text{PTR}) \times (\text{CTR})}{(\text{time, in seconds})} = \frac{3.6 \times 10 \times 28.8 \times 1}{53.5} = 19.38 \text{ (kwh/h)}$$

Diesel or gasoline:

Evaluation time: hours _____ minutes _____ = _____ hours

Fuel use _____ gallons (a small quantity of fuel may also be weighed, at 7.05 lb/gal for diesel and 6.0 lb/gallon for gasoline)

$$\frac{(\text{fuel use, in gallons})}{(\text{time, in hours})} = \text{_____} = \text{_____ gallons/hour}$$

Propane:

Evaluation time: hours _____ minutes _____ = _____ hours

Fuel use _____ lb (weigh fuel used from small portable tank)

$$\frac{(\text{fuel use, in lb})}{(4.25 \text{ lb/gal}) \times (\text{time, in hr})} = \text{_____} = \text{_____ gallon/hours}$$

Natural gas:

Evaluation time: hours _____ minutes _____ = _____ hours

Meter reading: End _____ minus Start _____ = _____ mcf

$$\frac{(\text{fuel used, in mcf})}{(\text{time, in hr})} = \text{_____} = \text{_____ mcf/hr}$$

1/ Some power companies use a type of meter that requires a PTR or CTR correction factor. Check with local power company.

Exhibit 9-10 Completed worksheet—Irrigation pumping plant detailed evaluation—Continued

U.S. Department of Agriculture
Natural Resources Conservation Service

Sheet 4 of 5

Example - Pumping Plant Detailed Evaluation Worksheet

Land user _____ Field office _____

In the next step, the efficiency of the power plant and pump, as a unit, is compared to the Nebraska Standards for irrigation pumping plants. The Nebraska standard for a good condition, properly operated plant. If the comparison comes out less than 100%, there is room for improvement.

Nebraska performance rating:

Nebraska pumping plant performance criteria _____

Pump and Power Plant

Energy source	Whp-h/unit of energy	Energy unit
Diesel	12.5	gallon
Propane	6.89	gallon
Natural gas	61.7	mcf
Electricity	0.885	kW=kwh/hr
Gasoline	8.66	gallon

The Nebraska standards assume 75% pump and 88% electric motor efficiency.

Percent of Nebraska performance rating

$$= \frac{\text{(whp)} \times (100)}{\text{(energy input)} \times \text{(Nebraska criteria, in whp-h/unit)}} =$$

$$= \frac{15.6 \times 100}{19.38 \times .885} = 90.9 \%$$

Horsepower input:

Electric:

$$\frac{\text{(input kW)}}{(0.746 \text{ kW/bhp})} = \frac{19.38}{0.746} = 26.0 \text{ bhp}$$

Diesel:

$$(16.66) \times \text{(energy input, in gal/hr)} = \text{_____} = \text{_____ bhp}$$

Propane:

$$(9.20) \times \text{(energy input, in gal/hr)} = \text{_____} = \text{_____ bhp}$$

Natural gas:

$$(82.20) \times \text{(energy input, in mcf/hr)} = \text{_____} = \text{_____ bhp}$$

Exhibit 9-10 Completed worksheet—Irrigation pumping plant detailed evaluation—Continued

U.S. Department of Agriculture
Natural Resources Conservation Service

Sheet 5 of 5

Pumping Plant Detailed Evaluation Worksheet

Land user _____ Field office _____

Pumping plant efficiency:

$$E_{pp} = \frac{\text{(water horsepower output, whp)} \times (100)}{\text{(brake horsepower input, bhp)}} = \frac{15.6 \times 100}{26.0} = 60.0 \%$$

Energy cost per acre-foot:

Fuel cost per unit 0.54 \$/kW-hr, or \$/gal, or \$/mcf

Cost, in \$/ac-ft = $\frac{(5431) \times (\text{fuel cost, in } \$/\text{unit}) \times (\text{energy input, in kW, gal/hr, or mcf/hr})}{(\text{flow rate, in gpm})}$

$$= \frac{5431 \times 0.054 \times 19.38}{295} = \$ 19.26 /\text{acre-foot}$$

Recommendations:

Exhibit 9-10 Completed worksheet—Irrigation pumping plant detailed evaluation—Continued

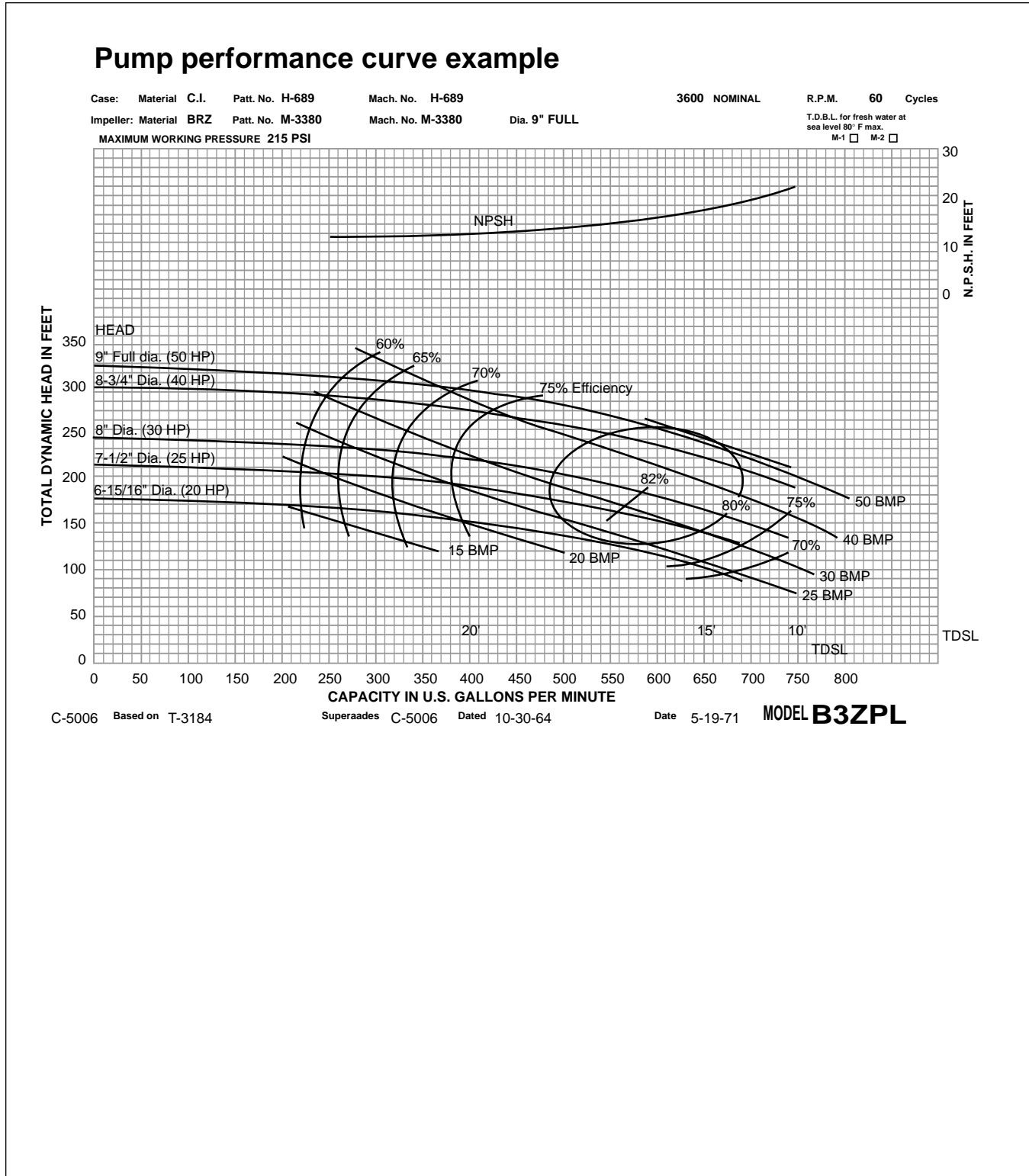

Example 9-10 Evaluation computation steps for irrigation pumping plants**1. Determine total dynamic head (TDH).** This is the sum of:

- static head (elevation difference) between the supply water surface and the pump outlet at the point where pressure is read,
- friction loss in the suction or riser pipe, and
- discharge pressure next to the pump. (If the pressure is positive at the pump inlet, as is the case for a booster pump or gravity flow inlet, inlet pressure is subtracted from the discharge pressure.)

Consideration should be given to operating conditions at times other than the time when the evaluation is done. Fluctuations in the supply water surface or pressure and changes in location and elevation of the irrigation outlet during the course of the irrigation should be considered. Worst cases (lowest and highest estimated TDH) should be compared to the evaluation TDH and pump performance curves.

2. Measure flow rate using the best available method. If a propeller flow meter is used, the most accurate flow rate is achieved by recording total flow at the beginning and end of a time period, such as a half hour, and dividing by time. This compensates for fluctuations in flow rate during that period. Flow meters or velocity meters must be installed far enough downstream of elbows, tees, valves, reducers, and enlargers to have pipeline velocity flow lines parallel to the pipeline centerline. A distance of at least five times the pipe diameter is recommended. Vanes installed in the pipeline can be used to help reduce turbulence.

3. Compute water horsepower (whp):

$$\text{whp} = \frac{(\text{Flow rate, in gpm}) \times (\text{TDH, in ft})}{3960}$$

4. Determine energy input:

Electrical powered units—The easiest method of determining electric energy use is to count the revolutions of the electric meter disk over a period and calculate kilowatt hours.

$$\text{kWh} = \frac{(3.6) \times (\text{disk revolutions}) \times (\text{Kh}) \times (\text{PTR}) \times (\text{CTR})}{(\text{time, in sec})}$$

where:

kWh = kwh/hr = the kilowatt-hours used in 1 hour

Kh = a meter constant shown on the meter

PTR = power transformer ratio, usually equal to 1 (may need to get from power company)

CTR = current transformer ratio, usually equal to 1 (may need to get from power company)

Another way to determine electrical energy use is to measure voltage, amperage, and power factor (if power factor meter is available). All legs of 3-phase power must be measured. This takes proper equipment and should only be done by someone with adequate training. See Nebraska Irrigation Pumping Plant Test Procedure Manual for the procedure.

Example 9-10 Evaluation computation steps for pumping plants—Continued

Diesel or gasoline powered units—Diesel fuel use is determined by running the pump for a period and measuring the amount of fuel used. One way is to fill the fuel tank to a known point, then run the engine for several hours and then refill the tank to the known point with a measured amount of fuel.

Another way is to prepare a 5-gallon fuel can with a fitting and hose just above the bottom. Connect the fuel hose to the engine and run it for a short time. Start timing when the pump pressure has come up to operating pressure. Weigh the fuel container at the beginning and end of the timing period. Number 2 diesel weighs 7.65 pounds per gallon, and gasoline weighs 6.05 pounds per gallon. (Specific weight of diesel and gasoline varies with temperature and type.) Measure or compute gallons per hour used. This is a dangerous operation and should be done by the operator or someone with experience in working with diesel engines. If air is allowed in the fuel system, diesel fuel injectors can malfunction, requiring a diesel specialty mechanic for repair and adjustments.

Propane—The volume of fuel used is determined by running the engine for a short period and weighing the fuel used from a portable tank of propane. The tank should be of the type used on recreational vehicles. Several feet of hose and appropriate connectors are required. This hookup should be done by the operator or someone with experience in working with propane engines. Be sure to exhaust air from the hose before making carburetor connections. Measure or compute the amount of propane used per hour based on 4.25 pounds of fuel per gallon.

Natural gas—The most practical procedure for determining natural gas use is to run the pump at operating load for several hours. Read the gas meter at the beginning and end of the test to determine the number of thousand cubic feet used. Measure the evaluation time in hours and hundredths of hours.

- 5. Compare the pumping plant energy usage to energy use by a well designed and operated pumping plant to measure whether improvements in the plant are warranted.** For this purpose we use a set of standards developed at the University of Nebraska. Nebraska Pump Standards are shown on the worksheet. If the comparison comes out close to or more than 100 percent, then the pumping plant (the combined power unit and pump) is considered satisfactory. If the comparison comes out significantly below 100 percent, then consideration should be given to identifying and making pumping plant changes to improve operation.

Performance of the pumping plant, including power unit and pump, can be determined as follows:

$$\% \text{ of pumping plant performance criteria} = \frac{(\text{whp}) \times (100)}{(\text{energy input}) \times (\text{power plant criteria in whp} \cdot \text{h/unit})}$$

where energy input is in terms of kW for electricity; gallons per hour for diesel, gasoline, and propane; and meters per cubic foot per hour for natural gas.

This criterion is based on 75 percent pump and 88 percent electric motor efficiency as a standard. See chapter 12 of this guide for more information on pumping plant operation.

Example 9-10 Evaluation computation steps for pumping plants—Continued**6. Compute brake horsepower input (bhp) based on fuel used.**

Electric: $\text{bhp} = \text{input kW} / 0.746$

Diesel or gasoline: $\text{bhp} = (16.66) \times (\text{energy input, in gal/hr})$

Propane: $\text{bhp} = (9.20) \times (\text{energy input, in gal/hr})$

Natural gas: $\text{bhp} = (82.20) \times (\text{energy input, in mcf/hr})$

7. Compute overall pumping plant efficiency (E_{pp}):

$$\% \text{ Efficiency} = \frac{(\text{water horsepower output, in whp}) \times (100)}{(\text{brake horsepower input, in bhp})}$$

8. Compute energy cost per acre foot of water delivered:

$$\text{Cost, in } \$/\text{ac} \cdot \text{ft} = \frac{(5,431) \times (\text{fuel cost, } \$/\text{unit}) \times (\text{energy input, in kW, gal/hr, or mcf/hr})}{(\text{flow rate, in gpm})}$$

(iii) Analysis of data—These steps are needed to analyze the data collected.

Step 1—Analyze the pump intake and discharge plumbing to determine if unnecessary pipeline and fitting friction loss or turbulence is present. The pump discharge pipeline should expand to full diameter upstream of valves and fittings. Consult pump manufacturer's data for proper installation procedures.

Step 2—If sizes of pump inlet and discharge piping or fittings appear small, calculate friction loss and make a judgment as to whether changes should be recommended. An eccentric reducer with the flat side up should be used (where needed) to reduce the suction pipeline diameter to the inlet diameter at the pump. The inlet fitting at the pump should be the high point on the suction piping. Pump inlet and outlet diameters are based on pump design, not pipeline design. Generally, velocities in suction piping and discharge piping should be less than 5 feet per second.

Step 3—Compare the results with the design.

(iv) Recommendations

Discuss evaluation conclusions with the operator. Make recommendations based on observations, factual measurements, and experience. The data assist the operator in determining if changes are economically desirable. Use the data in completing cost saving computations in a complete irrigation system analysis. Leave sufficient written documentation for operators to review, study, and make a decision, and to provide to a pump dealer if desired.

(v) General pumping problems

Lack of maintenance is by far the greatest pumping problem. Pumps, valves, fittings, and other parts wear with use. When pumping efficiency drops more than 5 percent, maintenance needs to be performed and worn parts replaced. Excess wear in the wear ring around the eye of the impeller is a major cause of reduced pump efficiency. Removing a few bolts and using a micrometer can determine when replacement or rebuilding is needed. Air leaks in the suction piping is another major cause of pumping problems.

A practical maximum suction lift for most pumps is about 15 feet at sea level. This is because of high velocities in the suction pipeline and fittings and at the pump impeller entrance. Depending on pump elevation above sea level and hydraulic entrance conditions at the pump, cavitation can start to occur at about 8 feet of suction lift. Cavitation sounds like small gravel moving with the water through the pump. It is actually air bubbles in the water collapsing as a result of negative pressure. Excessive negative pressure accelerates metal erosion in the eye of the impeller and on the backside of impeller blades. Air leaks, primarily from fittings and welds, in the suction pipeline also cause a form of cavitation. Cavitation reduces pumping equipment efficiency and useful life.

An overheated motor or engine is an indication of excess load. An electric motor should be warm, but not hot to the touch. Check pump performance (discharge head-capacity) curves for rated power requirements. Centrifugal pump impellers can be trimmed to reduce discharge pressure without significantly reducing discharge flow. Reducing impeller rotations per minute (rpm) reduces pressure and discharge flow. Closing a valve on the pump discharge to reduce pressure does little to reduce energy required at the pump.

(vi) Changing pump performance characteristics—If the current pump performance characteristics are known, the effects of a change in diameter of impeller or pump rpm on performance characteristics can be estimated using a set of equations known as affinity laws.

With constant rpm impeller and varying impeller diameter:

- Capacity varies directly with the impeller diameter.
- Head varies as the square of the impeller diameter.
- Horsepower varies as the cube of the impeller diameter.

With constant impeller diameter and varying pump rpm:

- Pump capacity varies directly with rpm.
- Head varies as the square of the rpm.
- Horsepower input varies as the cube of the rpm.

Changing rpm on AC electric motors is typically not an option. However, under certain conditions and with higher bhp motors, use of a variable frequency drive (VFD) may be an economical option. Cost of installing a VFD versus reduced energy use must be analyzed. VFD's allow the rpm of the AC electric motor to be reduced by varying the frequency of the power into the motor, which in turn reduces the horsepower demand. The drives consist of a converter that changes AC power to DC power and an inverter that changes the DC power into adjustable frequency AC power. As the frequency of the power is decreased, the power to the motor and the motor rpm are both reduced. This decrease in motor rpm can substantially reduce the pump horsepower demand, since the pump horsepower demand is proportional to the pump rpm. The result is that a small change in rpm causes a significant change in pump horsepower demand. Review of such references as *Irrigation Pumping Plants* by University of California (1994) can be helpful in understanding effect of VFD's.

652.0905 Soil intake determination procedures

(a) General

Some knowledge of soil intake characteristics must be available and used to design irrigation systems. Water intake rate of soil is the most important item to be considered in the design of a surface irrigation system, and it is the most variable. Soil intake rate is also important for other irrigation methods. The two purposes for making soil intake or maximum application rate evaluations are to:

- Aid in placing a named kind of soil or group of soils in an intake characteristic (family or group) for future designs.
- Determine the intake characteristics for a specific condition on an individual field.

Table 2-6, Chapter 2, Soils, displays estimates of soil intake characteristics (for basin, border, and furrow surface irrigation) and maximum average application rate (for sprinkle irrigation). These estimates are made by interpretation of data taken from either actual field tests or estimating intake characteristics using surface soil texture by soil series. **Intake characteristic curves (intake family curves) are unitless. It is improper to use any unit, such as inches per hour.** The 1.0 intake family curve does not express an infiltration process averaging 1 inch per hour.

In the past, surface irrigation was the predominant irrigation method used to apply water to the land. Soil intake families were an attempt to group soils with similar intake characteristics for easier data manipulation and fewer digits to handle on a slide rule. Later research and field experience indicated soils were more variable and the infiltration process more complex than originally anticipated. In addition to soil surface texture, soil structure, density, organic matter content, subsurface texture, macro pores, and general soil condition are known to affect the infiltration process.

At least 30 percent of irrigated soils do not follow what was thought to be Standard Intake Curves. Especially with well graded, low organic matter soils, intake curves tend to concave downward instead of upward.

Infiltration reduces to almost zero with time. Although not technically correct, in practice a specific gross application depth and elapsed time are selected and the standard intake family curve nearest that point is used. If a different gross depth of application is selected, a new standard intake curve must be selected to represent that condition. Field measurements and a plotting of a revised accumulated intake versus time curve would work better.

Each irrigation method and system provides its own unique water infiltration process (fig. 9–31). Therefore, determining soil intake characteristics or application rate also must be unique.

Basin and border irrigation have a near uniform depth of free water on the soil surface, which creates a small hydraulic head (pressure) to force water into the soil. Water movement through the soil is primarily downward, first by gravity, then as depth increases by capillary action. With furrows (or corrugations) free water is located in open channels and typically does not cover plant beds. Flow from the furrow is downward (gravitational forces) laterally and even upward into plant rows (capillary forces). Thus, border intake characteristic (family) curves and furrow intake characteristic (family) curves are different.

With sprinkle irrigation (and precipitation), water movement into and through the soil is primarily downward (gravitational and capillary forces). Like border irrigation, the entire soil surface is wetted. However, unlike border irrigation, the small hydraulic head (pressure) on the soil surface does not exist with sprinkle irrigation. If it does, water translocation and runoff typically occur. Average maximum application rate is used for sprinkle irrigation.

Large volume short duration applications made with most low pressure in-canopy application systems require small basins or reservoirs, in-row ripping, residue, or other soil management techniques to limit water translocation and runoff.

Many field tests must be made to determine reliable averages for each soil series. Many factors affect water infiltration. Among them are soil texture, soil condition and recent cultivations, macro pore presence, organic matter content in the surface layer, tillage equipment compaction layers, soil-water content at time of irrigation, and quality of irrigation water as it

affects intake (suspended sediment, electrical conductivity [EC], sodium absorption ratio [SAR], and temperature). See Chapter 13, Quality of Water Supply, for additional information.

Furthermore, intake characteristics of a given soil series vary with location, field, irrigation event, and season. Intake characteristics for furrow irrigation change as the crop growing season progresses. These changes are a result of compaction by cultivation equipment, heavy equipment compaction in furrows, worm activity, sediment in irrigation water, soil consolidation, erosion, sedimentation, and water temperature. Intake characteristics for border irrigation systems with perennial crops can decrease as a result of the operation of harvest equipment on moist soils. Under sprinkler systems having medium to large droplet sizes, intake rates can decrease because of puddling and compaction of bare soil surface and surface sealing from displaced fine soil particles. After the designer selects an intake rate or maximum sprinkler application rate from the irrigation guide, onsite investigations (followup) should be made to check actual field condition soil characteristics that affect design parameters selected.

(b) Surface irrigation systems intake

When providing an analysis of an existing surface irrigation system operation using actual field data (inflow, advance), computer software programs, such as Agricultural Research Service's SRFR program, can provide realistic results. This model uses the kinematic wave and zero-inertia theory, which more nearly simulates actual field flow conditions. The soil infiltration conditions significantly influence the achievable distribution uniformity. The relationship between cumulative infiltrated depth and infiltration opportunity time can be described by a number of empirical expressions. The most common expressions are variations of the power function shown in equation form. This equation is used in computer programs for simulating surface irrigation.

$$Z = k t^a + B t + C$$

where:

- Z = cumulative infiltration
- t = infiltration opportunity time
- a = empirical exponent
- k, B, & C = empirical constants

Figure 9-31 Water infiltration characteristics for sprinkler, border, and furrow irrigation systems

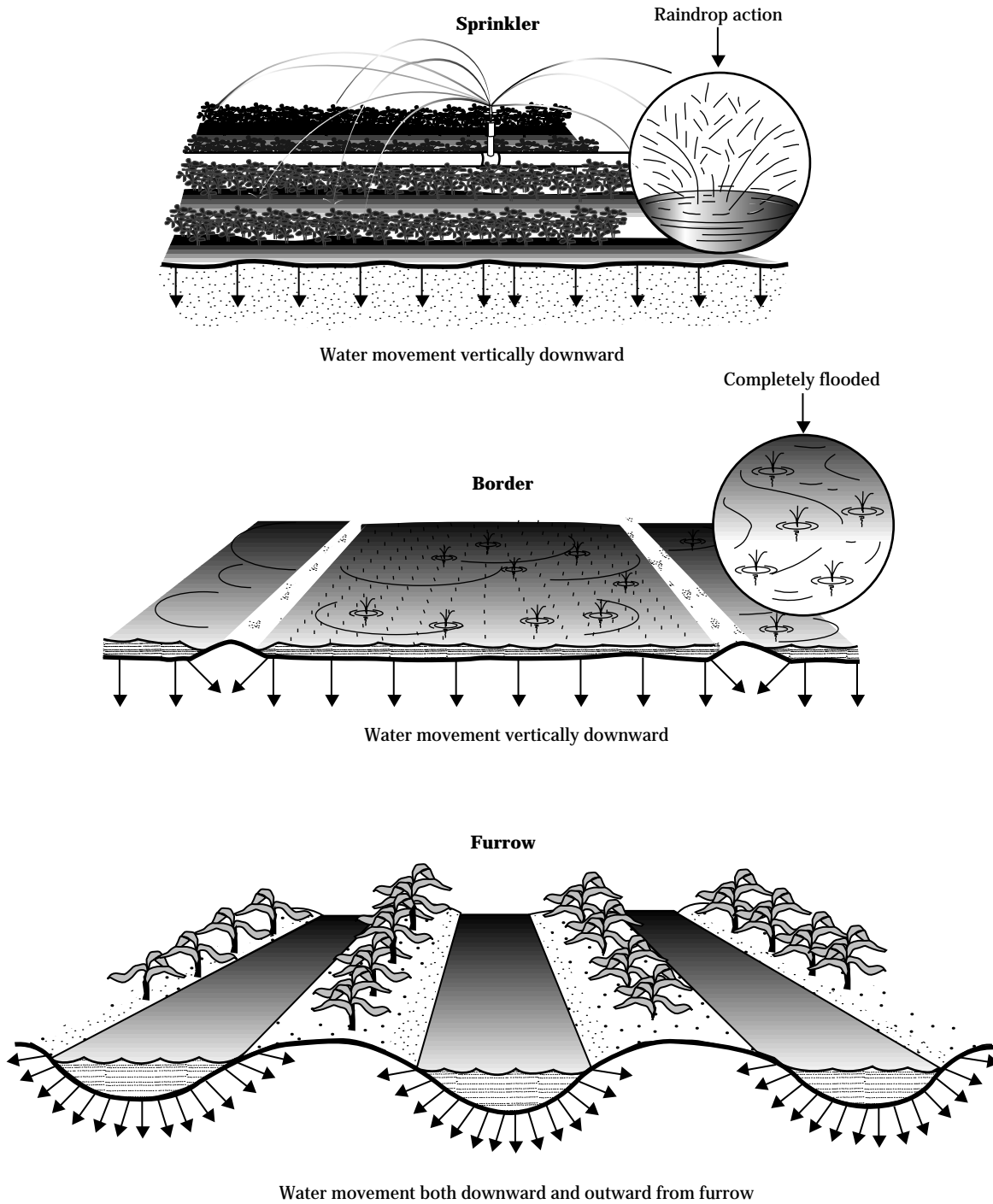

For design of border irrigation systems or to validate an intake family using known field advance and opportunity times for a border system, the concept of intake family is described in NEH, section 15, chapter 4, by the equation (NRCS modified Kostikov equation), as follows:

$$Z = k t^a + C$$

where:

- Z = cumulative infiltration
- t = infiltration opportunity time
- a = empirical exponent
- k & C = empirical constants

(1) Border and basin irrigation systems

When an irrigation takes place for either level or graded border systems, water is ponded on the surface of the soil with water infiltrating vertically downward into the soil. See figure 9–31. The process to determine soil intake characteristics for borders or basins must be similar. A process using a series of cylinders (short lengths of steel pipe driven into the ground) has been developed. They are referred to as cylinder infiltrometers.

Cylinder infiltrometers are installed with buffer rings (or diked earth) around each cylinder to help maintain near vertical water movement. For the intake test, water is ponded in the cylinders and buffer rings to a depth slightly greater than the normal depth of irrigation water flow. Depth of water should be maintained within 20 percent of the normal flow depth. The rate of water level drop is measured in the inside of the cylinder(s) and recorded. With basin irrigation, the entire irrigation set can be used as an infiltrometer.

Data are plotted to display cumulative infiltration in inches versus time. The plotted curve is then compared to a standard set of border intake-family curves to determine the average border intake family for the specific soil at that specific site. See figure 2–3, Chapter 2, Soils, and NEH, Part 623, Chapter 4, Border Irrigation.

(2) Furrow irrigation systems

When an irrigation takes place for either level or graded furrow systems, water within the furrow infiltrates vertically downward, laterally, and diagonally upward into the furrow bed because of soil water tension differential. See figure 9–31. Methods developed to determine soil intake characteristics for furrows need to simulate the actual irrigation process.

Typical furrow conditions needed for determining intake characteristics would include:

- Water flowing in the furrow at a rate and depth similar to a normal irrigation,
- Water flowing at the soil water content when an irrigation is needed, and
- Water flowing in a wheel and nonwheel row or recently cultivated or noncultivated furrow.

The three methods developed to determine infiltration characteristics for furrow irrigation are the furrow inflow-outflow, flowing furrow infiltrometer, and the furrow stream-rate of advance methods. Only the flowing furrow infiltrometer and the furrow stream-rate of advance methods will be described fully in this chapter.

(i) Furrow inflow-outflow method—This method is described in NEH, Part 623, Chapter 5, Furrow Irrigation. When the furrow inflow-outflow method is used, furrow flow rate measuring flumes, weirs, or orifice plates are placed at the head end and lower end of the furrow. The actual irrigation is used for a water supply. Infiltration characteristics of enough furrows (typically four or more) should be measured to be representative of the field. Buffer furrows on each side of test furrow should be used.

(ii) Flowing furrow infiltrometer method—This method was designed by the ARS Water Conservation Lab in Phoenix, Arizona. With the flowing furrow infiltrometer, an auxiliary water supply in a vertical sided container and a return flow pump are needed. After a furrow section (typically 10 meters or 33 feet) is selected, a float controlled water sump with pump is placed at the lower end of the furrow. A flow measuring flume with return hose (from the downstream sump pump) and valve is installed at the upper end of the furrow section.

To begin the furrow intake characteristic test, water from the auxiliary supply reservoir is discharged into the downstream pump sump via the float controlled valve. The return flow pump then transfers the water to the upstream sump and flume via the return hose, where the flow rate is both controlled and measured. A constant flow rate is maintained in the furrow, with water lost by infiltration coming from the auxiliary reservoir via the float control valve in the downstream pump sump. Water surface elevation in the auxiliary reservoir versus time is recorded as soon as the furrow flow rate stabilizes, generally within 5 minutes. Furrow flow rate and soil infiltration volume determine the necessary capacity of the flowing furrow infiltrometer.

(iii) Furrow stream-rate of advance method—When this method is used, the furrow inflow stream is held constant and the rate of advance measured. The gross application calculated at the time water reaches each station (based on an area equal to the furrow spacing times length of advance) is plotted on log-log paper versus time of advance. An average cumulative intake curve results. This procedure assumes all water has been infiltrated into the soil. Thus, the test section must be long enough where surface storage is a small percentage of water infiltrated. Initial points plot as a curve on log-log paper. As the volume of water in surface storage becomes a smaller percentage of total water applied, the curve straightens. The straight line portion represents the accumulative intake curve.

Each method has its own unique field equipment and data collection process even though they provide a similar intake characteristic curve. Data are plotted to display cumulative infiltration in inches versus time. The plotted curve can be matched to a standard set of furrow intake-family curves to determine furrow intake family for that particular soil type. See figure 2–4, Chapter 2, Soils, and NEH, Section 15, Chapter 5, Furrow Irrigation.

(c) Sprinkle irrigation systems

Rotating impact type sprinkler heads apply water to the soil surface intermittently as the jet from the nozzle rotates around a riser. Spray type heads apply water to the soil surface continually. Water infiltrates vertically downward. See figure 9–31. Continuous (self) moving systems use either rotating impact type heads, rotating spray heads, or continuous spray heads. A continuous moving lateral provides an increasing and decreasing application rate pattern (assumed elliptical pattern) on a specific spot; as the lateral approaches, centers over, and moves past a specific spot on the soil surface. Short duration application rates on quarter mile center pivot laterals that have low pressure spray heads can be very high (up to 12 inches per hour). Low Energy Precision Application (LEPA) and Low Pressure In-Canopy (LPIC) systems use very narrow spray pattern discharge devices, thus providing extremely high, short duration application rates (up to 30 inches per hour). All require different processes to determine soil intake characteristics even though a maximum sprinkler application rate is the net result.

Regardless of the sprinkler application process, determining the maximum allowable application rate is a visual observation process. When application rate exceeds soil intake rate, ponding or runoff occurs. The spot or area of soil along the lateral where ponding is beginning to occur and runoff or translocation is just starting represents the area receiving the maximum allowable soil application rate. Ponding is generally not a good indicator by itself, since surface storage can contain an excessive application until sufficient time has elapsed to allow the ponded water to infiltrate. However with most sprinkler systems, some soil surface storage must be available. A small amount of wind can distort application patterns. Typically wind speed is not uniform; therefore, the test should be done during a no-wind condition.

The best judgment of maximum soil infiltration rate can be made by watching the sheen of reflected light on the soil surface as water is applied. With rotating impact sprinklers, the sheen should have just disappeared before the next sprinkler rotation. With spray heads, watch for micro runoff and ponding. Typically many tests are needed on any one soil series because of the small areas that are tested.

For periodic move or set type sprinkler systems using rotating impact type heads, a portable application evaluation device and process were developed by Rhys Tovey and Claude H. Pair, ARS, published in American Society of Agricultural Engineering, 44(12):672-673: Dec. 1963, and Transactions of the ASAE 9(3): 359-363: 1966. The Tovey Meter has a rotating impact type sprinkler head mounted inside a vertically mounted barrel having a vertical narrow discharge slot on one side. The slot allows the sprinkler head to discharge onto an area of about one-tenth of a full circle, thus conserving water and providing a dry area to work from. Water is supplied by a portable water tank. Size of the sprinkler head nozzle (discharge) is increased to where a range of application rates in the wetted pattern from below to above the maximum application rate can be observed. A set of catch containers is placed at some evenly spaced distances from the sprinkler head. Observations are made as to whether the application rate is under, equal to, or exceeds the soil maximum application rate. Catch rates are then measured in the containers in the desired area observed.

More recently, an application device and process have been developed by Michigan State University (MSU). The MSU infiltrometer is a light truss supported pipeline from which several water application devices can be suspended. The pipeline is supported on each end by A-frame style electrical conduit pipe supports. An auxiliary water supply with pump is generally used. Spray heads are typically used in this device. Several sizes of sprinkler or spray heads can provide a range of low-to-excessive application rates for the soil being tested. Sprinkler heads are cycled on and off at different frequencies to vary water application rate. A video is available from NRCS showing the use of the MSU infiltrometer.

Existing sprinkler systems can also be used. Larger than normal discharge sprinkler heads are temporarily installed on two adjacent risers on a lateral. Odd shaped areas somewhere in the sprinkler pattern will visually display ranges of low-to-excessive application rates for the soil and site being tested. Before system startup, valves are placed at least on two adjacent sprinkler heads to allow changing of nozzles without interrupting the balance of the irrigation lateral.

Existing systems are used for continuous moving center pivot and linear laterals. Excessive application

rates occur somewhere along the lateral, typically in the outer quarter to one-third of the center pivot lateral. This is especially true on medium to fine textured soils. Continuous recording catch devices are almost essential to record the increasing and decreasing application rates of a moving lateral. This also is the only way to realistically record an accurate short duration maximum application rate. Where simple catch devices are used, only an average rate for the total irrigation set (lateral pass) is obtained. A method using five catch containers set perpendicular to the lateral can be used to approximate maximum application rate. The containers are kept covered until the lateral is over the first container. The cover is removed and timing is started. An elliptical shape application pattern is used to approximate maximum application rate when compared to average application rate (maximum rate = about 1.5 x average rate). See section 652.0905(g) (iii), Continuous/self move sprinkler, field procedure step 9 for a process to measure maximum soil application rate.

(d) Infiltration and application rate test procedures

(1) Border and basin

A brief description of manual procedures is presented in this part. Use reference ARS-NRCS Bulletin ARS 41-7 for additional information and details of equipment needed.

(i) Equipment needed—The equipment needed for border and basin systems include:

- Set of five cylinder infiltration rings (14- to 16-inch lengths of bare welded steel pipe at least 12 inches in diameter), driving plate, driving hammer, and coarse burlap or cotton sack material to be laid on soil surface inside rings to prevent soil puddling when pouring water into rings. See figure 9-32 for plates showing cylinder infiltrometer and hook gauge.
- Carpenter's level to level rings, hook gauge, engineer's scale, recording forms.
- 50-gallon barrel(s) for water supply, several 3-gallon buckets.
- Soil auger, push type sampler, probe, shovel.
- Buffer rings generally cut from 55-gallon barrels. Small earth dikes built around each ring can also be used. Water level is not measured inside the buffer rings.

Figure 9-32 Cylinder infiltrrometer

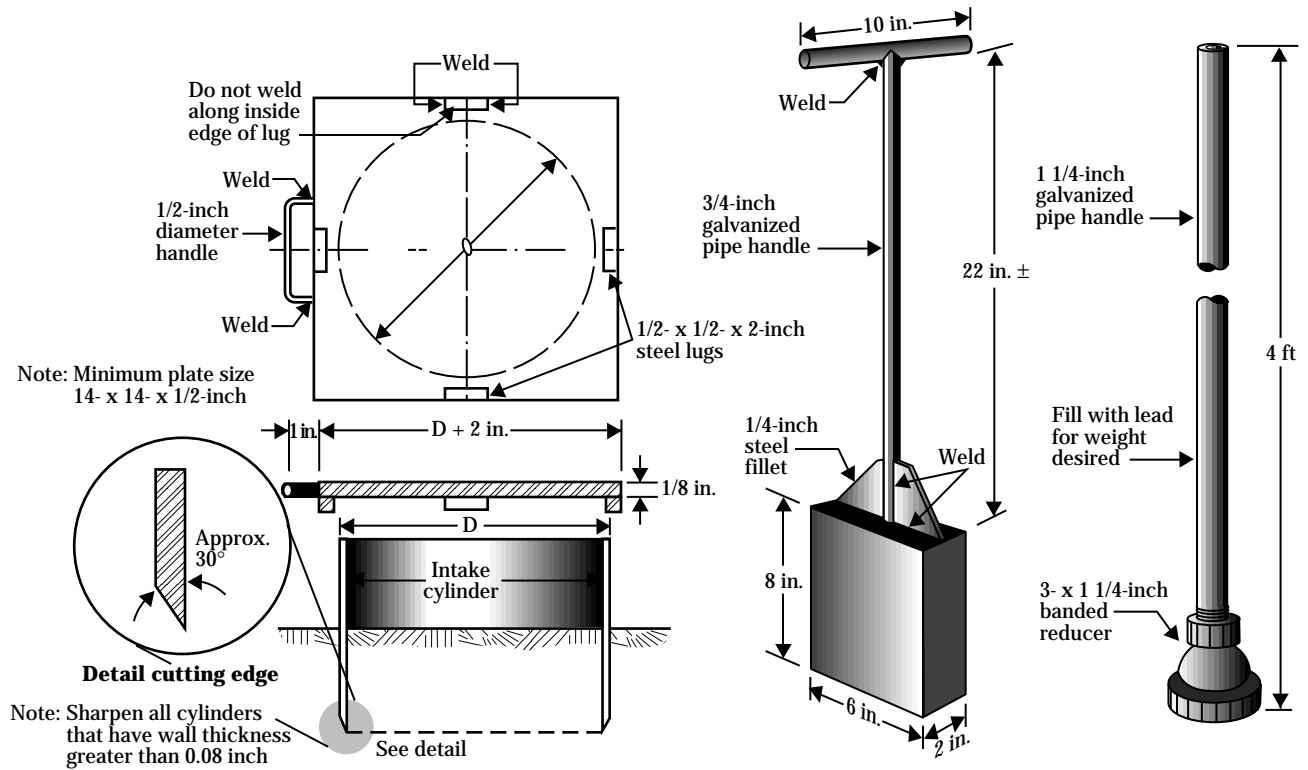
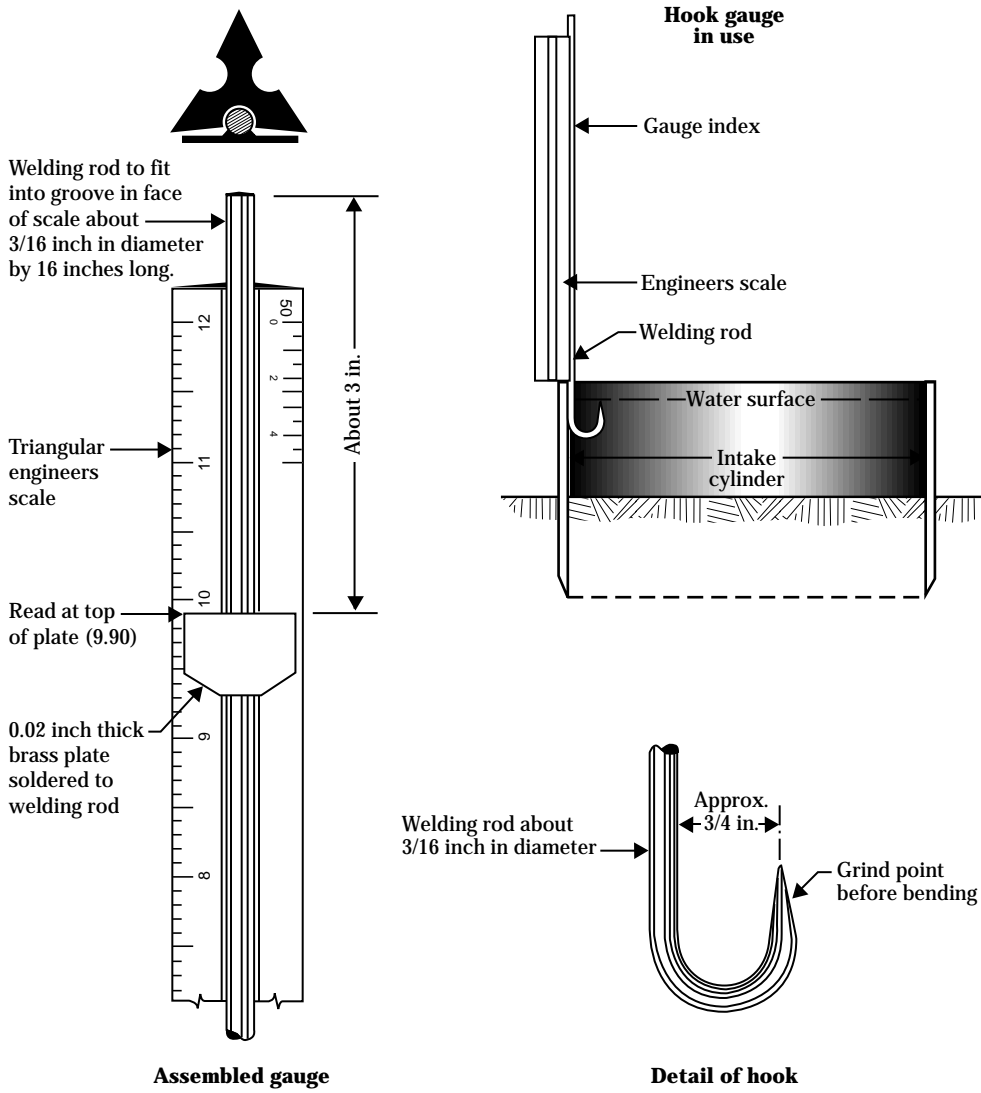

Plate 1: Intake cylinder and driving plate

Plate 2: Driving hammers for intake cylinders

Figure 9-32 Cylinder infiltrometer—Continued



(ii) Site selection—Carefully preselect sites in advance that represent specific kind of soil and crops. Sites in irrigated mature alfalfa that are in need of irrigation are suggested; otherwise, use the crop and soil condition being irrigated. Replicated infiltrometer measurements on a few typical extensive kind of soil provide more reliable information than single measurements on a large number of soil types. With coarse to medium textured soils on readily accessible sites, two people can reasonably run two tests in 1 day. With medium to fine textured soil and slow intake rates, only one test can be reasonably run in a day.

Measurements made on five kinds of soil for each land resource area at carefully selected model sites for each soil are suggested. Three to five cylinder infiltrometers should be used at each site. Test data from one infiltrometer is often extreme compared to the others and is not used. Doing fewer select soils and sites should provide a basis for estimating intake rates for closely related soils.

A soil scientist should identify and correlate soil series and surface texture at each site. The sites should represent average soil conditions for the soil series. For each test site, identify and record distances to field edges or other permanent features near the site. See figure 9–33 for example soil description for test site.

(iii) Performing tests—Tests are performed using the following procedure:

Step 1—Carefully drive rings into the soil keeping them vertical as possible. Avoid obvious rodent holes, rotted roots, and cracks. The soil should be reasonably moist to provide ease of driving and to provide a good seal between soil and infiltrometer walls. Identify rings and reference the point on each ring where hook gauge is to be located. Install outside buffer rings, earth dikes, or use the entire basin as a buffer.

Step 2—Have a supply of water readily available for quick filling of buckets. Open 55-gallon barrels are convenient to use. Have buckets full of water ready to put into infiltrometers. Have hook gauge, scale, and forms located at the measuring location in the infiltrometer ready to measure and record water level. Account for rapidly infiltrating water early in the test, especially with coarse textured soil where a significant amount of the irrigation can infiltrate in the first few

minutes. Also, with some deep cracking fine textured soil, the initial intake can be high and dramatically slow after the cracks are filled and the soil particles swell. Worm activity can cause high initial intake because of preferential flow paths.

Step 3—Place the burlap over soil in the infiltrometers and pour water into infiltrometers. Record hook gauge readings and time. Infiltrometers should be started at successive 1-minute increments, if practical. This gives an opportunity to observe the first 5-minute reading for each infiltrometer in succession. For high intake rate soil, water may need to be added before the first 5 minutes passes. As water is added to maintain near constant levels, hook gauge readings must be made before and after water is added. Times of water addition need not be recorded if they fall between regular reading times. If buffer rings are used, water must be maintained in them also, but measurements need not be recorded. With level basin irrigation systems, the flooded basin can be used as a buffer ring.

Step 4—The first 5 to 10 minutes can be rather frantic on moderately high to high intake rate soil. Record all data on form NRCS-ENG-322. Figure 9–34 is example field data recorded on this form. When readings are taken on the suggested elapsed time intervals as indicated on the form, calculations and plotting are simplified. Soil condition, past cropping history, and tillage practices used by the farmer may be significant in interpreting results.

Step 5—A complete test requires nearly 4 hours of actual running time. Testing low to very low intake rate soil takes longer, and high intake rate soil can take as little as 1 to 2 hours. When accumulated intake is about 6 to 8 inches, the test can be stopped. Erratic data from one or more infiltrometers at a site should be discarded. On low intake soil, a complete test that allows a full irrigation may take 24 hours to complete. Quite often an intake test can be performed for an initial period of 3 to 4 hours, then by plotting on log-log paper and extending the accumulated intake versus time line, infiltration for latter parts of an irrigation is represented. If the line extension is within 10 percent of actual infiltration, performing long duration tests is not justified. Reduced test time is more practical, especially when soil variability is considered.

Figure 9-33 Soil description

U.S. Department of Agriculture
Natural Resources Conservation Service

NRCS-SOILS-2328
Rev. 5-96
File Code Soils-11

Example - Soil Description

Soil	Havre Loam		File No.
Area	McCone Co. MT	Date	7-5-85
Classification	Fine-loamy, mixed (calcareous), frigid ustic torrifluvents		
Location	NE 18 - T26 N - R 44E		
N. veg. (or crop)	Alfalfa hay	Climate	
Parent material	Alluvium derived from sedimentary plains and glaciated uplands		
Physiography	Northern rolling high plains and brown glaciated plains		
Relief	Smooth	Drainage	Well drained
Elevation	2,500	Salt or alkali	—
Slope	0.27	Gr. water	Deep (>6')
Aspect	E	Stoniness	—
Erosion	None	Moisture	Mod. dry
Permeability	Moderate	Root distrib.	(See column below)
Additional notes	Alfalfa stand is 3 years old. Last irrigated 2 weeks ago. Cut 2 days ago.		
		% Clay*	
		% Coarse fragments*	None
		% Coarser than V.F.S.*	

*Control section average

Horizon	Depth	Color		Texture	Structure	Color			Reaction	Boundary	Effervescence	Roots	Pore	Line
		Dry	Moist			Dry	Moist	Wet						
Ap	0-5"	2.5 y 5/2	2.5 y 4/2	L	1, f, pl Parting to 1, f, gr	sh	fr	SS, sp	7.6	cs	es	3, vf & f	—	—
C1	5-18"	2.5 y 6/2	2.5 y 4/2	L with strata of VFSL	1, m, pr parting to 1, m, sbk	sh	fr	SS, sp	8.2	gs	es	3, vf & f	3, vf & f	few threads in pores
C2	18-60"	2.5 y 6/2	2.5 y 4/2	1L with strata of FSL	m	sh	fr	SS, sp	8.2	—	es	2, vf	3, vf & f	few threads in pores

Figure 9-34 Example cylinder infiltrometer test data using form NRCS-ENG-322

U.S. Department of Agriculture
Natural Resources Conservation Service

Cylinder Infiltration Test Data

NRCS-ENG-322
05-96

FARM Joe Example	COUNTY Yellowstone	STATE MT	LEGAL DESCRIPTION NW 1/4 S27, T3N, R28E	DATE 7-24-84
SOIL MAPPING SYMBOL	SOIL TYPE Glenberg loam		SOIL MOISTURE: 0' - 1' - % of available 40% 1' - 2' - % of available 50%	
CROP Alfalfa	STAGE OF GROWTH 1 week after cutting			

GENERAL COMMENTS

Compacted layer between 10 and 14 inches

Elapsed time Min.	Cylinder No. 1			Cylinder No. 2			Cylinder No. 3			Cylinder No. 4			Cylinder No. 5			Average accum. intake
	Time of reading	Hook gauge reading	Accum. intake	Time of reading	Hook gauge reading	Accum. intake	Time of reading	Hook gauge reading	Accum. intake	Time of reading	Hook gauge reading	Accum. intake	Time of reading	Hook gauge reading	Accum. intake	
	Inches			Inches			Inches			Inches			Inches			
0	11:15	1.80	0	11:16	2.10	0	11:18	3.21	0	11:19	4.10	0	11:19	3.56	0	0
5	11:20	2.44	.64	11:22	2.80	.70	11:23	3.56	.35	11:24	5.30	1.20	11:24	3.99	.43	0.66
10	11:25	2.57	.77	11:26	3.05	.95	11:27	3.64	.43	11:28	5.75	1.65	11:29	4.13	.57	0.87
20	11:35	2.76	.86	11:37	3.45	1.35	11:38	3.72	.51	11:39	6.30	2.20	11:40	4.41	.85	1.17
30	11:45	2.95	1.15	11:46	3.80	1.70	11:47	3.82	.61	11:48	6.85	2.75	11:49	4.71	1.15	1.47
45	12:00	3.25	1.45	12:01	4.35	2.25	12:03	3.97	.76	12:04	7.60	3.50	12:05	5.11	1.55	1.90
60	12:15	3.58	1.78	12:17	4.80	2.70	12:18	4.15	.94	12:18	8.20	4.10	12:20	5.46	1.90	2.28
90	12:45	4.05	2.25	12:46	5.50	3.40	12:47	4.51	1.30	12:47	9.20	5.10	12:48	6.26	2.70	2.95
120	13:15	4.50	2.70	13:16	6.10	4.00	13:17	4.91	1.70	13:18	10.10/ 3.90	6.00	13:19	7.26/ 3.68	3.70	3.62
180	14:15	5.30	3.50	14:17	7.50	5.40	14:18	5.71	2.50	14:19	5.6	7.70	14:20	5.88	5.90	5.00
240	15:15	6.20	4.40	15:16	8.80	6.70	15:18	6.61	3.40	15:19	6.9	9.00	15:20	7.98	8.00	6.30

Step 6—Calculate each infiltrometer and average accumulated intake for increments of elapsed time and plot on log-log paper. See example data and the resulting plot in figure 9-35. Draw best fit curve (straight line on log-log paper) through the plotted points (use 2 x 3 cycle logarithmic paper). Many soils match the standard curves. For those not matching, a regression analysis can be made to develop an equation for the curve or line. Compare to figure 9-36 for intake families for border irrigation design. Determine accumulated intake for the curve:

$$\text{Accumulated Intake} = c \times t^n$$

where:

c = y intercept at t = 1 minute

n = linear slope of line

From the plotted line: Using an engineer's scale, determine slope of line (n). The example shows 0.48 inches rise in 1-inch horizontal. Plotted line intercept (c) at 1 minute = 0.134 inches.

$$\text{Accumulated Intake} = (0.134) \times T^{0.48}$$

(iv) Automation of infiltration tests—Use of automatic water supply devices, pressure transducers or strip gauges for water level indication, and continuous water level recorders (data loggers) can substantially reduce labor compared to a manual testing process. Only one person would need to visit the test site periodically during the infiltration test after initial startup. The basic testing process and time of test are the same regardless. Five sets of equipment are needed except one data logger can handle water level data from all five cylinder infiltrometers.

Water level automation within buffer rings or dikes is simple. A water supply barrel, large diameter garden hose, and a float controlled valve can eliminate the need for manually adding water to buffer rings. Float controlled valves should be mounted on a durable stake where each valve can be raised or lowered to adjust the buffer ring water surface at each site.

Figure 9-35 Example cylinder infiltrometer test data accumulated intake for border irrigation design

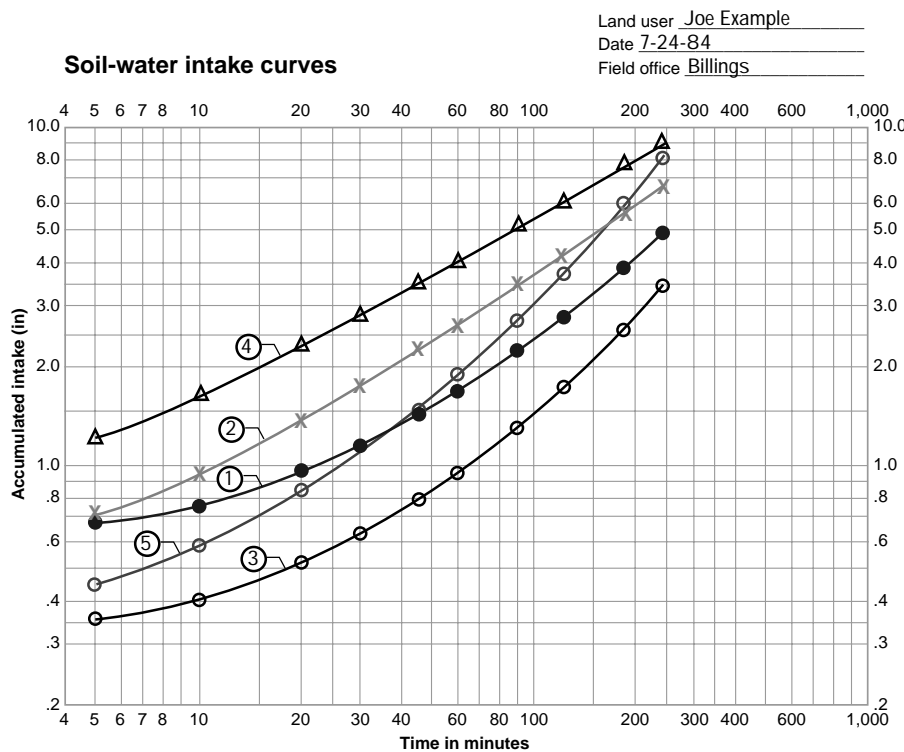
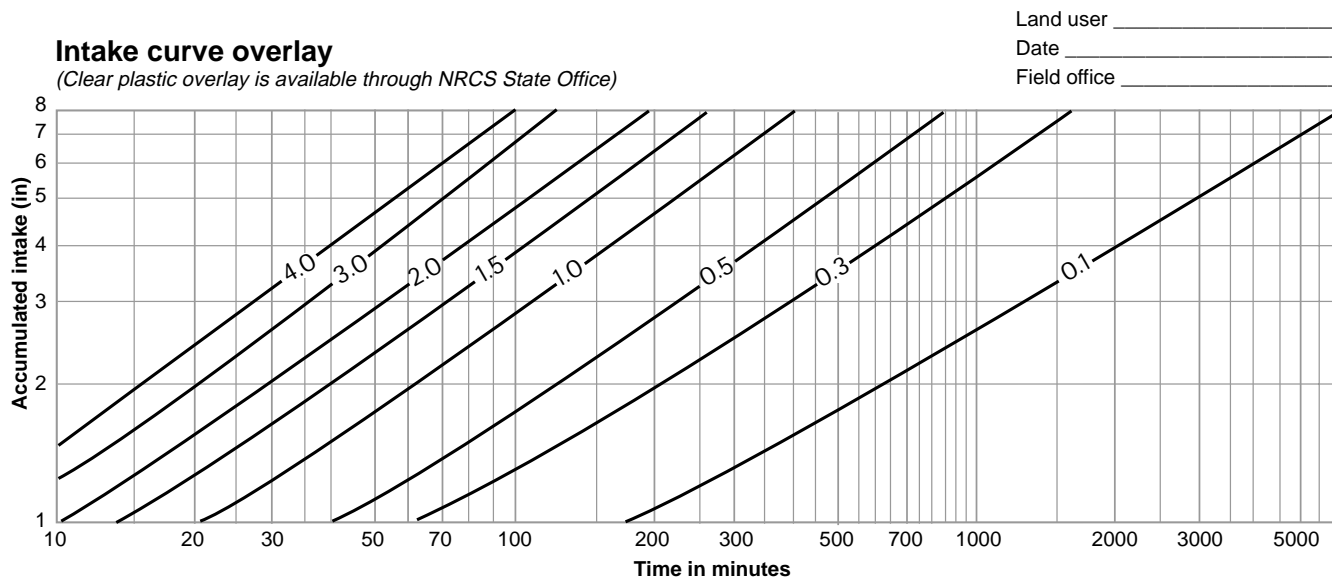

Figure 9-36 Standard intake families for border irrigation design

Intake Grouping for Border Irrigation Design

Instructions

1. Plot data from cylinder intake test on matching logarithmic paper using accumulated intake (inches) as ordinates and elapsed time (minutes) as abscissas. Draw line representing test results.
2. Place overlay over plotted curve, matching the intersection of the lines for 10 minutes time and 1-inch intake. Select the intake family that best represents the plotted curve within the normal irrigation range.

(2) Furrow

Manual procedures for measuring furrow intake rates are described in this part. Refer to NEH Section 15, Chapter 5, Furrow Irrigation, for additional information on inflow-outflow method of furrow intake determination.

(i) Equipment—Equipment needs for furrow inflow-outflow method include:

- Portable water flow measuring devices for determining inflow and outflow in each furrow (small broadcrested v-notch or trapezoidal flumes, v-notch weirs, or orifice plates). Water surface in furrow should not be raised above normal flow conditions by the measuring device.
- Auger, push type sampler, probe, shovel.
- 100-foot tape, lath, or wire flags.
- Level and rod to determine elevations at 100-foot stations down the length of the test furrows.
- Pocket tape and straight edge to measure furrow cross sections at two or three stations.

(ii) Site selection—Carefully preselect sites in advance for specific soil series, soil surface textures, and crop. Replicated measurements on a few typical soil series and surface textures provide more reliable information than single measurements on a large number of soils. On medium to high intake rate soil, two people can reasonably run one test in 1 day. On low intake soil, it may take 24 hours for a complete test that allows a full irrigation. Quite often a furrow intake test can be performed for an initial period of 3 to 4 hours, then by plotting on log-log paper and extending the accumulated intake versus time line, infiltration for latter parts of an irrigation is represented. If the line extension is within 10 percent of actual infiltration, performing long duration tests is not justified.

Measurements made on predominant soil series and surface textures for each land resource area at carefully selected model sites for each soil are suggested. Also, replicated measurements on a few typical dominant soils provide more reliable information than a single measurement on a large number of soils. The data can be projected to other close related soils.

A soil scientist should identify the soil series and surface texture at each furrow evaluation site. (Soil map units may contain inclusions.) Because of the inclusions or local soil series changes in the field, the

test length generally is some portion of the full furrow length (50 to 200 feet recommended). Most testing is to identify infiltration characteristics for a soil series and surface texture, thus that soil series and texture should be measured. Sites should represent average soil conditions for the soil series and surface texture tested. Identify test site with reference to field edges or other permanent features in or near the field.

If field (instead of soil series and surface texture) infiltration characteristics are desired, measure the number of furrows and furrow length that best represents field conditions. Values obtained are good for that field and may represent field conditions for similar conditions and soil series.

(iii) Performing tests—Tests are performed using the following procedure:

Step 1—Set stakes or wire flags at 100-foot stations (use measuring tape), determine elevation at each station (use level and rod), and measure furrow cross sections at two or three stations (use pocket tape and straight edge). A uniform grade for the furrow length is desirable. The full furrow length does not need to be used; any length will work. The minimum evaluation length should be 50 to 100 feet for high intake rate soil and 100 to 200 feet for low intake rate soil. (The evaluator's ability to determine flow rate at each end of the furrow test section determines length.)

Step 2—Three adjacent furrows should be evaluated. Adjacent furrows on each side of the test area should also be irrigated simultaneously. This requires observers to walk either on top of the beds or in the adjacent irrigated furrows themselves. Use the same inflow stream size that the irrigator uses. However, the flow should be large enough to produce a fairly uniform rate of advance through the test section.

Start flow into furrows, record time, adjust streams so that flows into all test furrows are about equal. For advance rate data, record the time water in each furrow reaches each station. Two people are essential to perform tests where inflow rates are high or the soil provides fast advance rates. Periodically check water inflow rate and record time of readings. Inflow should be constant during the test. Record time water starts to flow through the outflow measuring device. Periodically measure and record time for outflow.

With field evaluations, outflow starts gradually and increases to a constant flow rate. It decreases after inflow shut-off and recession starts. Record time of inflow shut-off. Continue to periodically measure outflow and record times until flow stops. If ending the intake evaluation before completion of a full irrigation, take final inflow-outflow readings at the same time. The full irrigation time does not need to be used. The test should run sufficiently long for the outflow to become constant for at least 3 to 4 hours. This indicates infiltration is at a constant rate.

Step 3—Computation and evaluation procedures are described in NEH, Section 15, Chapter 5, Furrow Irrigation. Example of data collected from a field intake test are displayed in figures 5-23 to 5-28. The cumulative intake and associated opportunity time are plotted on log-log paper (fig. 9-37). This information defines the measured intake curve. This curve is then compared to standard intake-family curves in figure 9-38 to determine the most representative intake family. Example displayed indicates intake family for existing site condition, $I_f = 0.5$. Appropriate values of a and b are selected. Graded furrow detail evaluation procedure and example forms are described in section 652.0905(g) (3).

Step 4—Although not needed for the intake test, measuring the wetted bulb is desirable about 24 hours after the irrigation is completed. A probe or push type core sampler can be used to define the boundary line between wet and dry soil. Another method is to excavate a trench perpendicular across the furrow and observe and measure the wetted area. The soil moisture (after 24 hours) immediately below the furrow is generally considered to be field capacity (in medium to fine texture soil).

Often a previously irrigated set with the same soil series and surface texture is used for this purpose. Check wetted depth at 0, 20, 40, 60, 80 and 100 percent of the furrow length for distribution uniformity and adequacy of irrigation, if test is of equal duration to a regular irrigation. Observe root development location and pattern for a better understanding of the actual plant root zone.

Figure 9-37 Furrow accumulated intake versus time

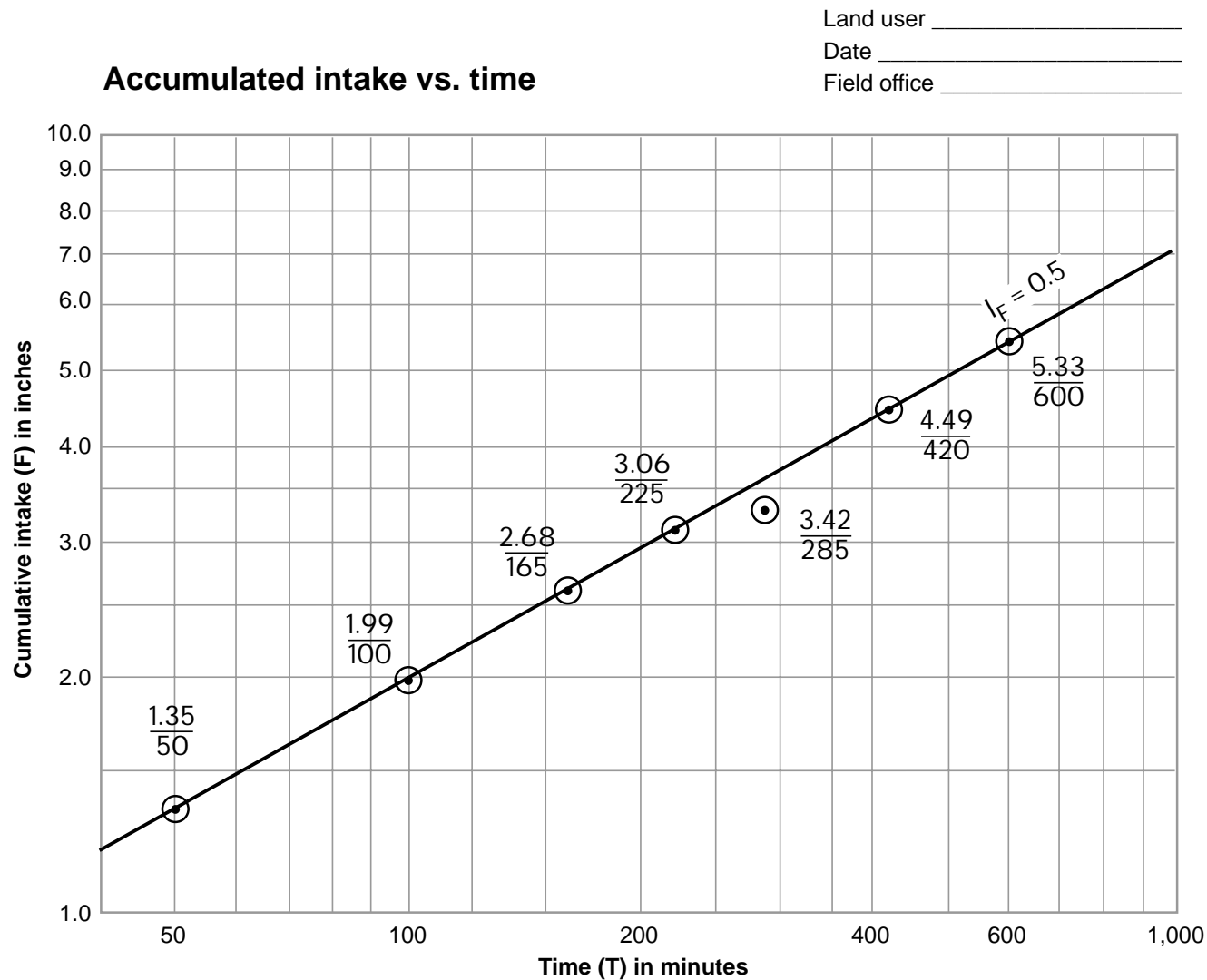

Land user _____
Date _____
Field office _____

Intake families as used with furrow irrigation

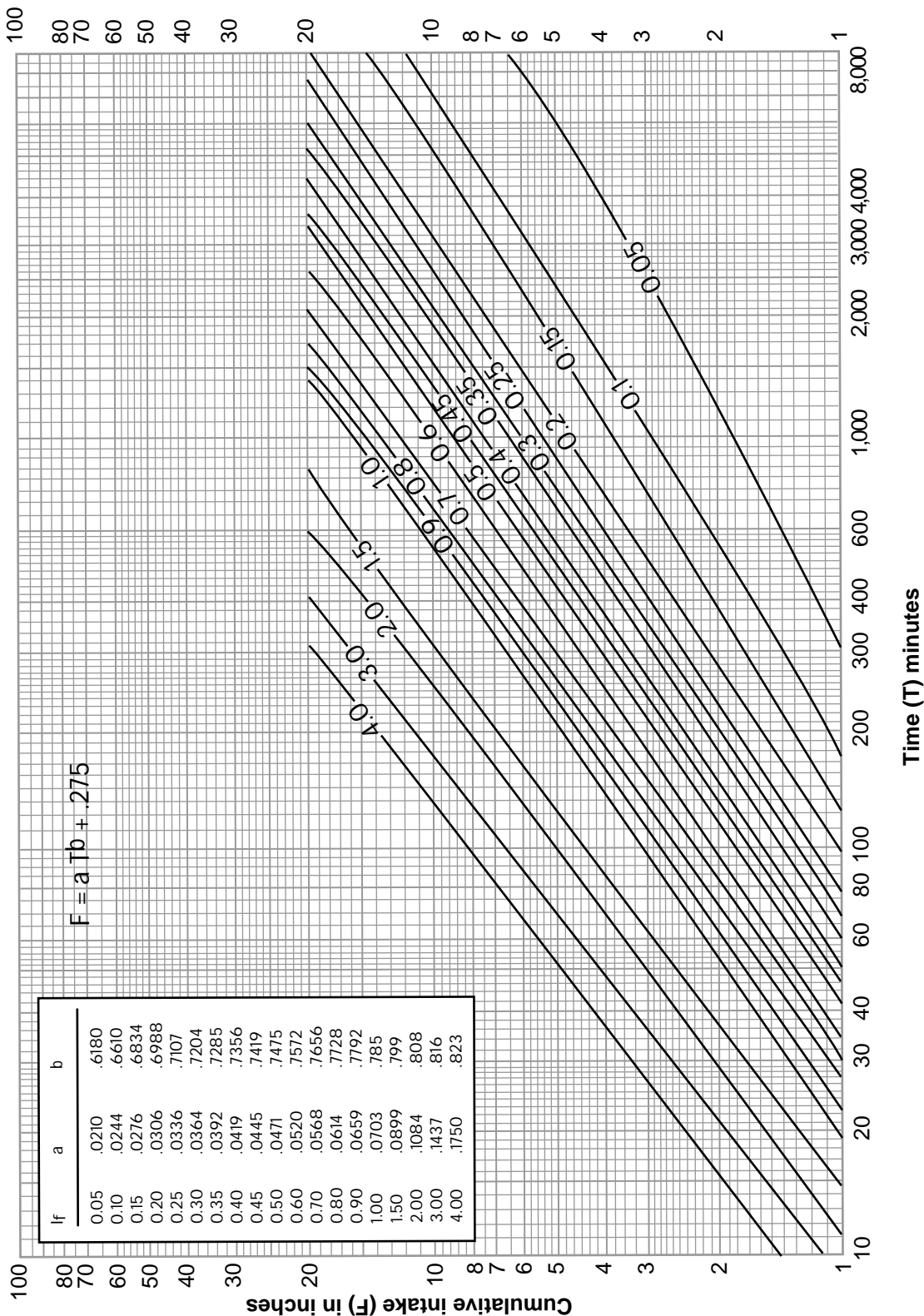

Figure 9-38 Intake families as used with furrow irrigation

(3) Flowing furrow infiltrometer method

(i) Equipment—Equipment needed for flowing furrow infiltrometer method include:

- Auger, probe, push type core sampler, shovel, measuring tape.
- Flowing furrow infiltrometer device consisting of:
 - water supply
 - calibrated vertical sided water supply tank
 - pump for return of furrow outflow
 - upstream flow control valve sump that has measuring flume
 - downstream sump that has float controlled water supply valve
 - two hoses for inflow from water supply and return of furrow runoff to upstream sump.

The required water supply volume can be calculated by knowing the area irrigated by the test, in acres; planned depth of water application during the test, in inches; plus water volume contained in the furrow during the test and miscellaneous losses. Cross sectional area of the water supply tank should be such that the water surface elevation drops at least 2 feet during the test.

(ii) Site selection—Carefully preselect sites in advance for specific soil series and surface texture. Furrows are tested individually. Two people can reasonably run tests at two nearby sites in 1 day for medium to high intake rate soil.

Measurements made on predominant soil series and surface textures for each land resource area at carefully select model sites for each soil are suggested. Also, replicated measurements on a few typical dominant soils provide more reliable information than single measurements on a large number of soils. The data can be projected to other close related soils.

A soil scientist should identify soils series and surface textures at each test site. Each test site is relatively small (30- to 100-foot furrow length) to avoid soil inclusions and have a sufficient water supply. Identify test site with reference to field edges and local features.

(iii) Performing tests—With water from a water supply tank, start flow into the downstream furrow sump via the hose and float controlled valve. Water is immediately pumped (returned) to the upstream sump and measuring device where furrow inflow rate is adjusted with a valve to the planned furrow flow rate or flow rate used by the irrigator. A near study water flow rate into the furrow and a constant furrow water storage volume should be obtained within about 5 minutes. Record the supply tank water surface elevation to start the test. Water lost by infiltration during the test is made up with new water from the water supply tank via hose and float control valve at the downstream pump sump.

Water surface elevation (or stage) in the water supply tank versus time is recorded about every 10 minutes. Although automated data recording may be available, manual recording is generally adequate. After initial set up, one operator should remain at the site throughout the test.

Typically, tests can be discontinued after 3 to 4 hours. If the plotted accumulated intake versus opportunity time can be extended for longer set times within about 10 percent of actual, conducting longer tests is not justified. Soils generally are more variable than additional accuracy obtained by running longer tests.

All data can be measured with small flumes or calibrated cans, pressure transducers, or strip gauges, and recorded using data loggers.

(iv) Calculations—With the cross sectional area of the vertical sided water supply tank known, the volume of water (in acre-inches) applied to the test area (furrow length times the furrow spacing) can be calculated. Accumulated furrow infiltration in acre-inches versus elapsed (opportunity) time can be plotted on log-log paper. Infiltration during the first 15 minutes to 1 hour can be significant when irrigating high intake, cracking or loose soil.

A composite curve for tests performed on the same soil series and surface texture can be plotted manually or a best fit curve can be calculated using all plotted points.

Additional water measurement detail is presented in section 652.0907.

(4) Sprinkler

A brief and generic type infiltration (application) test procedure is described here. Additional details depending on method used and type of application or infiltration test device are described in section 652.0907.

(i) Periodic move or set type sprinkler**Equipment needed:**

- Catch containers or rain gauges.
- 100- to 250-milliliter graduated cylinder.
- Measuring tape, watch, recording forms.
- Stakes, rubber bands, or similar way to support catch containers or rain gauges above crop canopy.
- Miscellaneous sprinkler nozzles or spray heads and tools.
- Operating sprinkler lateral or sprinkler infiltrometer. When using an operating sprinkler lateral, first obtain permission to change sprinkler nozzles (and heads if necessary). Before performing the infiltration test, install valves (ball type preferred) in sprinkler head risers where nozzles and or heads may be changed. Valves in adjacent risers help to minimize getting wet.
- Sprinkler infiltrometer test device. The test device need only wet a small portion of a full circle so operators and observers are working on dry soil. A collection system is necessary to catch and recirculate water from the sprinkler or spray head area when it is not discharging water onto the soil surface. Sharp edged and vertical sided containers work; however, 4-inch or larger diameter sharp edged catch containers are preferred as they can more accurately catch precipitation. If containers are not vertical sided, the catch must be measured volumetrically and converted to depth in inches based on the open area at top of container. With some nozzle trajectory patterns, such as low angle sprinkler heads on short risers, water droplets are moving more horizontal than vertical. This type of sprinkler head presents a challenge, so the results are meaningful.

Site selection:

Carefully preselect sites in advance for specific soil series, surface textures, and crop. Replicated measurements (3 to 5) on a few typical extensive soils provide more reliable information than do a single measure-

ment on a large number of soils. Two people can reasonably run two tests in 1 day if sites are close together and a water supply is relative accessible.

Measurements made on predominant soil series and surface textures for each land resource area at carefully select model sites for each soil are suggested. Also, replicated measurements on a few typical dominant soils provide more reliable information than a single measurement on a large number of soils. The data can be projected to other close related soils.

A soil scientist should identify and correlate soils series and surface texture at each test site. Because a test site is relatively small, inclusions in the field are generally not a problem. However, actual surface texture at the site needs to be known. Identify test site with reference to field edges and local features.

Describe soil surface conditions, such as surface organic debris, surface storage, soil condition, cultivation practices, and crop condition.

Performing tests:

Use the following procedure to measure maximum allowable sprinkler application rate:

Step 1—Catch containers are set in the wetted pattern in groups of three (suggested at 5-foot intervals). Care must be taken to avoid foot traffic in the area around each catch container where infiltration is observed. The observer must be able to see bare soil around each catch container. The maximum application rate typically occurs when soil has become wet and the initial high intake rate has passed. To pre-wet the site before the test is run may be necessary unless a full range of under-to-over application is desired.

When using an existing sprinkler system, increase nozzle size in two adjacent sprinkler heads. Install a valve just below the sprinkler head so discharge can be controlled when setting out, starting and stopping the test, and retrieving the catch containers. Excessive application rate needs to occur somewhere in the sprinkler or spray pattern. This provides a spot or area in the sprinkler pattern that is near the maximum application rate. Set out a linear series of catch containers in this area. Record time of start and stop of catch. Observe soil surface condition in the area around the containers for under application, adequate application, and over application rates.

Step 2—Observations are taken frequently (15 minutes) at each group of catch containers where application rates are categorized into three general classes: under, adequate, or over.

Step 3—At the conclusion of the test, the volume in each catch container is measured and converted to application rates expressed in inches per hour. The maximum allowable application rate based on visual observation can be displayed in table 2-8, Chapter 2, Soils. This value is used when designing fixed set or periodic move sprinkler systems on the kind of soil tested. Factors developed (or affirmed) in the local area are used to adjust the long-term maximum allowable application rate for shorter duration applications made with continuous move sprinkler systems. See continuous move system evaluation procedure.

(ii) Continuous move systems—center pivot or linear move (using catch containers)

Site selection:

Carefully preselect sites in advance for specific soil series, surface texture, and crop. Replicated measurements (3 to 5) on a few typical extensive soil series and surface textures provide more reliable information than a single measurement on a large number of soil series.

Measurements made on predominant soil series and surface textures for each land resource area at carefully select model sites for each soil are suggested. Also, replicated measurements on a few typical dominant soils provide more reliable information than a single measurement on a large number of soils. The data can be projected to other close related soils.

A soil scientist should identify and correlate soil series and surface texture at each test site. Identify test site with reference to span number, field edge, and direction from pivot. Specific location of test sites is not easy to identify until the pivot system has made several rotations and areas of runoff observed.

Soil surface condition must be described as to crop residue on the soil surface and soil surface storage, soil condition, and cultivation practices.

Performing tests:

Use the following procedure to measure maximum allowable sprinkler application rate:

Step 1—Place a minimum of five groups of catch containers or rain gauges (suggest three containers in a group) in a line perpendicular to the lateral in the area of observed maximum application rate. Distance between groups of catch containers depends on spray pattern width. Suggested maximum distance is 10 feet. For low pressure systems, the distance may be relatively short, 4 to 5 feet.

Step 2—Cover all containers. The center group of containers must be directly under the spray head when test is started, with equal groups of containers forward and rearward of the direction of movement.

Step 3—Quickly remove all covers from containers when spray nozzle is directly over the center group of containers. Observe intake characteristics of soil throughout the test.

Step 4—After 5 to 10 minutes of operation, cover containers as quickly as possible.

Step 5—Measure water volume caught in each container and convert to application rate in inches per hour. Average group of three containers into one value. Containers within a group are equal distance from the lateral. The group of containers with the largest quantity will represent the average application rate for that time duration (5 to 10 minutes). This approximates the maximum rate of the soil with a system similarly equipped moving at the given rate.

$$\frac{\text{Depth caught, inches}}{\text{Time of catch, min}} (60 \text{ min/hr}) = \text{___ inches per hour}$$

Step 6—Duplicate tests at other locations along the lateral in the same general area. This tends to eliminate the effect of nozzle pattern and start-stop operation and the effect on application rate.

Step 7—Additional tests may be needed (closer toward the pivot or toward the end) to determine maximum soil intake rate for that site, depending on location of runoff. This point is not necessarily be easy to observe until after some practice. In fact, runoff may not occur at the same location each rotation.

(e) Automation of testing for maximum application rate

Use of a continuous recording rain gauge, such as the standard U.S. Weather Bureau tipping bucket rain gauge, makes the application rate evaluation process much easier. The gauge can be relocated in front of the moving pivot lateral and quickly set up for another test. Setting up one recording gauge is faster than setting out a series of catch containers. Limitations are crop height and elevation of spray or sprinkler heads above the ground. When used to catch the applied water during the entire pass, any increment of time can be used to plot application rate versus time. Because of the short application time with low pressure systems, timely observation of application and runoff is essential. Use of waterproof rain gear is recommended to be close enough to the catch device to make good visual observations at ground surface.

652.0906 Water measurement

(a) General

High irrigation application efficiencies require applying uniform, predetermined amounts of water onto the field at the proper time (irrigation scheduling). Measurement accuracy of applied water needs to be sufficient to make the decision: "When should irrigation change to another area or cease entirely?" Too often, plant water needs are measured or calculated accurately, then water is applied with no thought of measurement.

Refer to Water Measurement Manual, Bureau of Reclamation (1997) for flow characteristics, siting, rating tables, and recommended operation and maintenance of water measuring devices.

(b) Using water measurement

Water measurement has traditionally been used to regulate the division of irrigation water between groups (irrigation organizations, districts, or companies) or individuals. Irrigation districts or organizations in turn use water measuring to portion water between individuals within a district. Thus, water measurement is often perceived as a regulatory action. Water users also view the installation of water measurement devices as a cost and a nuisance with little return on investment.

The benefits of providing onfield water measurement for water management purposes are incalculable. Investment costs are often returned many times during one irrigation season. Typically, at least 10 to 30 percent additional area can be irrigated with the same amount of water. Inversely, 10 to 30 percent less water can be used to irrigate the same area when water is measured. Crop yield or quality of product almost always improves with improved water management. Applying a measured, predetermined amount of water onto a field at the proper time is the basis for good irrigation water management.

Several accurate methods are used to determine plant water needs and available soil water. Combining these two factors determines when and how much irrigation water to apply (irrigation scheduling). Where water supplies are not limited, over irrigation (with associated yield reduction or soil and water resource degradation) is by far the greatest irrigation water management problem. Water measurement onto the field can help avoid over (or under) irrigation.

Successful micro irrigation depends on an accurate knowledge of flow rates. Water measurement devices allow for determination of line or emitter plugging, which then allows for line flushing or chemical treatment. With sprinkler systems, water measurement devices allow for determination of worn and plugged nozzles and excessive gasket leaks. Unexplained changes in flow indicate something in the system has changed and needs attention. A good example may be worn sprinkler nozzles. They provide an opportunity for system flow to increase, especially where the pump can provide additional flow. Overall pump efficiency is often decreased.

(c) Basic hydraulic concepts

Flow measurement is based on specific predetermined hydraulic concepts. Measurement accuracy is strongly influenced by adherence to these concepts. For open channel weirs and flumes, water must pass through critical depth or two flow depths must be measured. With closed conduits the pipeline must be flowing full at the measuring device. This can be accomplished by dropping the pipeline below the hydraulic grade line.

(d) Open channel primary measuring devices

(1) Weirs

- Sharp-crested, triangular, rectangular, and trapezoidal
- Short-crested, such as OG weir
- Cipolletti (sharp crested trapezoidal)
- Broadcrested, trapezoidal, rectangular, and circular

(2) Flumes

- Long-throated (modified broadcrested weir) sometimes called Replogle or Ramp Flume.
- Short-throated, such as Palmer Bowles
- Parshall (no longer recommended for most installations)

(3) Gates and orifices

- Sluice
- Radial
- Armco Meter Gate (no longer in production)
- Orifice plates

(4) Current metering

- Mechanical and electrical

(5) Acoustic meters

- Cross path, transit time, single path, ultra sonic

(6) Other open channel measuring devices

- Vane-deflection
- Volume and weight tanks
- Bucket and stop watch
- Volume drawdown
- Surface velocity/area
- Bubble curtain
- Chemical dilution

(e) Closed-pipeline primary measuring devices

(1) Differential head meters

- Orifice plates, end-cap orifices, etc.
- Ventura meters
- Pitot tubes
- Elbow meters
- Shunt meters

(2) Velocity meters

- Propeller meters
- Turbine meters
- Paddle-wheel turbines
- Electromagnetic

(3) Acoustic meters (fig. 9-39)

- Transit time, diametrical path, 2 or 4 transducers on opposite sides of pipe
- Transit time, diametrical path, reflective, 2 transducers on same side of pipe

- Transit time, chordal path, multiple transducers on opposite sides of pipe
- Doppler reflective type (like radar), ultrasonic

(4) Other closed pipe meters

- Siphon tubes
- Flow from vertical pipe
- Flow from horizontal pipe
- Vortex shedding
- Volume and weigh tanks

(2) Volume totalization

- Totalizing devices
- Integration
- Shunt meters

(3) Data storage and transmission

- Data loggers (mechanical, electronic, digital)
- Communication mechanisms (electronic, infra-red, sonic)

(f) Secondary measuring devices**(1) Head and pressure measurement**

- Water stage recorders
- Pressure transducers
- Bubblers
- Pressure bulbs
- Pressure chambers (i.e. Mariott siphon)
- Weir stick
- Differential stage recorders
- Differential pressure transducers
- Ultrasonic water surface elevation detection

(g) Methods of water measurement

The chosen water measurement method should be sufficiently accurate to make factual water measurement decisions. These decisions include: Should the flow rate change? or, should the flow cease entirely?

Figure 9-39 Transit-time acoustic flowmeters: diametrical path, diametrical path reflective, and chordal path transducer configuration

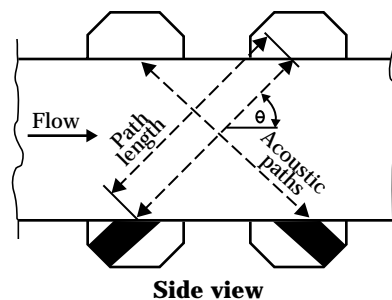
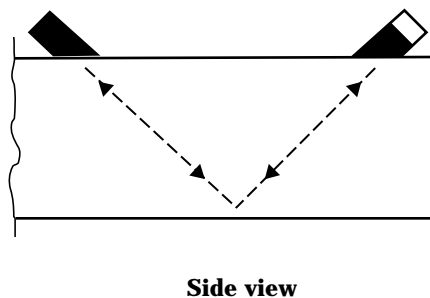
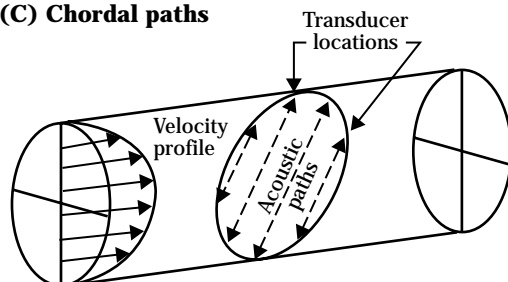
**(A) Diametrical path
w/ 4 transducers****(B) Diametrical path-reflective
w/ 2 transducers****(C) Chordal paths**

(h) Measuring method categories

Flow meters for pipe and open channel flows can be grouped into devices that primarily measure rate or volume of flow and those that primarily measure rate of flow. All fluid meters consist of two distinct sub-units:

- The primary element that interacts with the fluid.
- The secondary element that translates the interaction into flow quantities (volumes, weights) or flow rates (quantity per unit time) that can be observed and acted on by an operator or by control equipment.

Basically all flow meters, whether for irrigation or industrial pipe flows, use at least one of a few basic physical principles and properties of fluids. These include fluid mass, weight, volume, viscosity, and mixing types of properties, as well as the electrical, magnetic, thermal, optical, and acoustical types. Force, momentum, and energy principles (including force-velocity effects on floats) are commonly used, as well as energy conversions (kinetic to potential or potential to kinetic), heat, or electromagnetic energy.

Other physical principles include electromagnetic or acoustical wave transmission, distortion, or refraction; reflection by the fluid or tracer particles in the fluid; unclear magnetic resonance behavior of certain polar-fluid molecules; and fluid such behaviors as wall clinging and vortex formations by shaped flow cavities and obstructions in the conduit. Representatives of these groups are in table 9-5.

Sometimes classifying a particular flow metering system is a problem when it is perceived to use more than one principle, or even the wrong principle. For example, ultrasonic doppler meters use ultrasonic waves as a type of radar system that detects the velocity of moving particles in a flow. Thus, it depends on the force-velocity effects of the fluid on suspended particles.

Almost all recent claims for new flow measuring techniques are improvements in the readout format or in the detection of some primary interaction with water flow. Such is the case with ultrasonic flow meters.

Meter classification, while giving a general framework and understanding of flow metering promises and limitations, is somewhat subjective. Variations occur between classifiers; thus the classification used in table 9-5 is not sacred, but is convenient for comparisons.

Table 9-5 Types and characteristics of flow meters

Meter type or method	Standard accuracy	Usual ratio max:min	Remarks
Flow rate meters			
Variable head and area (also see table 10-2)			
Weirs (thin plate)	1-5% of actual	>100:1	Lab calibrated
Weirs (short-crest)	1-5% of actual	>100:1	Lab calibrated
Flumes (short)	2-7% of actual	55:1	Lab calibrated
Flumes (long)	2-5% of actual	>35:1	Computable
Differential head			
Venturi	1%, full scale	5:1	Low head loss; tolerates slurries
Pitot tubes	1%, full scale	5:1	Point velocities
Orifice	0.5-1.5%, full scale	5:1	Low to high head loss; many shapes
Elbow	3-10%, full scale	3:1	Adds no further losses in line
Force-velocity meters			
Tracers, salts/dyes	1-2% of actual	20:1	Indicates flow velocity
Floats	5% of actual	10:1	Indicates flow velocity
Ultrasonic doppler	5-10%, full scale	10:1	Works best in dirty water
Special metering methods			
Electromagnetic	1% full scale	20:1	Conductive liquids
Ultrasonic, transmission	1% full scale	20:1	Only clean liquids
Vortex-shedding	1% of actual	100:1	No moving parts
Tracer dilution	2% of actual	100:1	Needs no flow area
Flow quantity meters			
Gravimetric			
Weigh tank	0.1% of actual	100:1	Good lab standard
Volumetric (quantity)			
Volume tank	1% of actual	10:1	Field and lab uses
Tipping bucket	1% of actual	100:1	Used on rain gages
Propeller	1% of actual	15:1	Can be rate meter
Paddle wheel	3% of actual	15:1	Can be rate meter
Turbine	0.5-1% of actual	15:1	Many blades
Positive displacement	1% of actual	20:1	Used for ag. chem

(i) Suitable measurement methods for irrigation and drainage

For irrigation delivery systems and drainage systems, open-channel flow measuring devices dominate. Therefore, this guide deals mostly with flumes and weirs. The classification of flumes and weirs, sometimes listed as part of the variable head and area group of flow meters and sometimes as part of the differential head group, convert potential energy to kinetic energy to cause critical flow. If enough potential energy is not converted because of a high downstream water surface elevation, the device becomes a Venturi flume. The general Venturi flume operates on the same theory as a Venturi meter in pipe flows. Because the pressure differences generally are small, their use requires two depth measurements of high precision, one upstream and one in the throat region. These precise measurements generally are not practical in the field. General Venturi flumes are not commonly used for this reason. Critical-flow flumes are a special case of the Venturi flume where the critical condition eliminates the need for the throat measurement.

Flumes and weirs can be subdivided into sharp-crested weirs, short-crested weirs, broadcrested weirs, short-throated flumes, and long-throated flumes. A summary of their general characteristics is shown in table 9-6.

(1) Sharp-crested weirs

Sharp-crested weirs are one of the oldest open channel flow measuring devices. Head-discharge equations were derived from laboratory ratings. They are influenced by the flow bending in the crest region. The location of upstream sidewalls and floor elevations, as well as the condition of sharpness at the sharp edge, are part of the calibration.

For usual open channel applications, the difference in water surface elevation between upstream and downstream must be large enough to allow complete free overfall. An exception may be sharp crested V-notch weirs where 30 to 40 percent submergence can sometimes be tolerated. The usual recommendation is that the downstream water surface be at least 2 inches (50 mm) below the crest of the weir opening. Adequate aeration of the nappe (between downstream weir wall and backside water surface) must be available.

(2) Short-crested weirs

The most common example of short-crested weirs is the V-notch weir sill. A V-notch, thick-sill weir has triangular openings with sides formed by slopes as flat as 10 horizontal to 1 vertical. A common format is to construct weirs as vertical retaining walls about 1.5 inches (40 mm) thick with the top edge receiving a prescribed bevel upstream and downstream of 3 horizontal to 1 vertical. The resulting edge has a horizontal portion that is about 4 inches (100 mm) wide.

(3) Broadcrested weirs

A wide variety of shapes can be included under broadcrested weirs, and a wide variety of discharge coefficients will be encountered. Most broadcrested weirs offer no advantage over flat-plate, sharp-crested weirs for measuring flows. As a result, broadcrested weirs are seldom used for measuring purposes. This does not imply that they cannot be used as accurate flow measuring devices because in some cases they are desirable. For example, if difficulty is expected in maintaining a flat-plate weir in good condition because of rusting, impact, or abrasion, a broadcrested weir should be used. If possible, the crest shape should conform to the shape of some other structure or model for which the coefficient of discharge has been experimentally determined. If this is not practicable, the crest must be calibrated either by field tests on the actual structure or by model studies of it.

(4) Movable weirs and adjustable weirs

Movable weirs are weir assemblies mounted in metal and timber frames that can be moved from one structure to another. The frames fit freely into slots provided in the structures and are not fastened in place. Adjustable weirs are weir assemblies mounted in metal frames permanently fastened to the structures. The weir blades in both the movable and the fixed frames can be raised or lowered to the desirable elevations, usually by threaded stems and hand wheels.

A sufficiently large pool must be provided upstream from the weir to slow and quiet the flow as it approaches the notch in the weir. A fixed head gauge is not generally useful for flow measurement if the weir is to be moved up or down because the zero of the gauge does not coincide with the elevation of the weir crest.

Table 9-6 Major operational characteristics of flumes and weirs

Operational characteristics	
Weirs	
Sharp-crested weirs (lab calibrated) Rectangular Triangular Cipolletti (trapezoidal) Circular	Easily constructed, well defined lab-calibrated history; high head-drop required (<100%); poor tolerance to submergence; primary accuracy ± 1 to 3% is intended.
Short-crested weirs (lab calibrated) V-notch, thick-sill weir Triangular profile flat-V (crump type)	Poor tolerance to submergence; high head-drop needed; primary accuracy, ± 3 to 5%.
Broadcrested weirs Square edge Approach ramp or rounded	Poor tolerance to submergence; high head-drop needed; primary accuracy, ± 3 to 5%.
Flumes	
Short-throated (lab calibrated) Cutthroat flume Parshall flumes ^{1/} H-flumes	Moderate tolerance to submergence; predictable, reliable flow limit is 60 to 70%; careful field construction needed; two head readings required to extend limit to about 90% primary accuracy is ± 3 to 5%.
Long-throated (computer calibrated) Rectangular Triangular Calibrations Circular Complex Palmer-Bowles	Good tolerance to submergence; predictable, reliable flow limit is about 85 to 90%; reliable computable ratings; primary accuracy is $\pm 2\%$; single head readings required; liberal construction tolerances. Trapezoidal can be based on as-constructed dimensions.
Long-throated (computable) modified broadcrested weir, Replogle or Ramp flumes	Good tolerance to submergence with very low head-drop required (< 1 inch for most irrigation flows) single head reading, easily constructed, one level critical surface, $\pm 2\%$ primary accuracy, computable as built ratings.

^{1/} The Parshall flume has 10 critical surfaces that must be accurately constructed to meet published accuracy. Meeting this criterion often requires increased labor costs. Other types of flumes are more cost effective and provide similar accuracy.

(5) Short-throated flumes

The streamlines in the short-throated flumes are not as curved or variable as in the sharp-crested weirs. They include flumes with side contractions and bottom contractions (weirs not sharp-crested) with some type of transition section. However, the flow curves enough to again require the use of laboratory calibrations and flow coefficients. Familiar examples are the Parshall flume and the cutthroat flume. Deviations from standard plans may be difficult to evaluate without special field or model ratings.

(6) Long-throated flumes

These flumes are also called the computables because their construction specifications are such that parallel, not curvilinear, flow is produced. This allows accurate prediction of their hydraulic behavior. It also permits estimates of effects of construction anomalies. In these flumes, the streamline curvature is limited by providing gentle contractions from the upstream channel to the throat section. The throat section itself is made long enough (preferably about 1.5 times the maximum expected upstream head reading, referenced to the bottom centerline of the level throat) to provide nearly parallel flow through the control area. The horizontal location of the control section does not need to be precisely known. Its vertical reference is needed for total energy head computations. This vertical reference is most easily handled in the computations if the throat is level in the direction of flow. A 1 percent error in cross slope approximates an additional 1 percent error in accuracy.

(7) Long-throated flumes, modified broadcrested weir, Replogle or Ramp flumes

The modified broadcrested weir, sometimes called a Ramp flume or Replogle flume, has nearly the same operating characteristics as long-throated flumes. By definition, the long-throated flume is a cut-throat flume where the downstream or discharge portion of the flume has been eliminated. It is perhaps the most accurate and easiest to construct of all open channel, low head, flow measuring devices. The weir sill is the only critical surface, which is level. A 1 percent error in cross slope (the level bubble is not visible in the carpenter level site glass) approximates an additional 1 percent error in accuracy. The slope of the ramp up to the sill should approximate three horizontal to one vertical. The long-throated flume requires a short flume (usually less than 10 feet) or lined ditch. The

long-throated flume can be located within any cross area. Computer software has been developed to calculate flow rates through any cross sectional area. Discharge flow rate tables have been developed for standard geometric cross sections.

The Replogle flume can be used as a measuring device in pressure pipelines. Two pressure (head) readings are needed in the pipeline, one in the throat and one upstream. The flume can be oriented in any direction.

Replogle flumes and certain properly dimensioned, broadcrested weirs form the class of computable flumes. These styles can be proportioned so that almost any flow can be measured. Small flows are least accurate to measure because of the difficulty of obtaining precision depth readings. Generally, flows larger than about 150 gallons per minute (10 L/s) can be measured with an error of less than 2 percent in an appropriately dimensioned flume. There is no theoretical upper limit on size. Replogle flumes capable of measuring over 3,000 cubic feet per second (85 m³/s) have been constructed in Arizona.

For a complete treatment of these flumes, see *Flow Measuring Flumes for Open Channel Flow Systems*, by Bos, Replogle, and Clemmens (1991).

(j) Demands made on a measuring device

The actual selection of a flow measuring device type and size depends on its functional requirements, the required accuracy, the desired flow range, debris in water, installation location, and several other considerations discussed below.

(1) Functions of the device

Devices for measuring flow often serve two basic functions in their application. One is to indicate flow rate or volume, and the other is to control the flow rate or volume. In this section we distinguish between the measuring and control functions and emphasize measuring devices for open channel flows.

Good quality flow rate measurement and good quality control are best achieved with two separate devices. However, dual function devices are used. An example is a variable area orifice meter, such as an irrigation canal slide gate. Another is the vertically adjustable weir.

Most meters require some head loss to measure flow. Ultrasonic meters cause negligible head loss, but must introduce an outside source of sonic energy. Likewise, a piston pump used as a positive displacement meter can introduce a head gain into the measured flow, and uses power for pumping.

(i) Required head loss for pipe flow meters—

Head loss implications for pipes and open channels differ considerably, as mentioned before. Available head loss in pipes is generally used to determine whether the meter can be successfully incorporated into the system. If not, pressure may need to be increased or another size or type of meter selected.

In pipe flows, available head loss can influence the type of differential head meter selected. Pipe meters vary widely in the pressure drop imposed. For example, the passive type orifice meters produce higher pressure drop than do Venturi meters. Propeller and turbine meters vary according to their special designs. Unfortunately, low head loss propellers and turbines generally trade off accuracy because they achieve their low loss by sampling a limited cross section of the flow. Active meters, including sonic and electromagnetic, introduce negligible head loss, but have generally been expensive.

(ii) Required head drop for open channels—The head loss requirement is particularly important in open channel water measuring devices. Most of these devices depend on creating critical flow at an overfall or channel contraction as is the case with flumes and weirs. This is in contrast to the head loss in pipes that is usually of little importance to the meter function itself, but is more important to the ability of the pipe system to deliver the needed flow rates.

(2) Accuracy of measurement

The accuracy of discharge measured with a particular structure is limited to the accuracy that a measurement can be reproduced. If two identical structures are independently and correctly constructed, then presented with flow at the same upstream sill-referenced head, both flow rates are not likely to be equal. For flumes and weirs constructed as described herein, the difference between the presented flow calibrations and absolute accuracy have been determined to be less than 2 percent.

In addition to the above uncertainty of error in the basic discharge equation, three other types of errors can affect either the primary meter type or the secondary readout device. They are systematic, random, and spurious errors.

(i) Systematic errors—These errors are generally associated with dimensional problems, such as gauge zero settings or area changes resulting from plant growths or soil deposits on the channel or pipe walls, or to structural deflections. Systematic errors can be corrected if they are known.

(ii) Random errors—If several people read a wall mounted gauge or dial and record a flow rate from a chart, the variation in flow readings should be randomly distributed about the true average. These errors are subject to statistical treatment.

(iii) Spurious errors—These errors invalidate the measurements because of human mistakes, recording equipment malfunction, or obstructions of normal flow.

In selecting a measuring device, appropriate precision and accuracy should be carefully specified. The purposes of the flow measurement should dominate this specification. For usual irrigation management processes, accuracies of about 5 percent are suitable. Accuracy needs to be sufficient to make a decision, such as to change flow rate or cease irrigation entirely. If one were trying to determine seepage losses by measuring inflow and outflow in a reach of canal, then plus or minus 1 percent may not be sensitive enough.

(3) Sediment discharge capability

Besides transporting water, almost all open channels transport some sediment and debris. Bedload sediment is generally the most difficult to accommodate in measuring devices. The ability of various long-throated flumes to carry sediment depends, among other things, on the absolute velocity of the water, the density and size of the sediment particles, and the sediment concentration. A general discussion is presented in *Flow Measuring Flumes for Open Channel Systems*, by Bos, Replogle, and Clemmens (1991).

A major condition appears to be the throat width. The flume or weir throat width should be as wide as, or wider than, the approach channel delivering the sediment (e.g., sills in trapezoidal channels). This is based

on the observation that sediment moves in response to the water velocity immediately upstream. The slope of the ramp appears to play a small role in retarding sediment movement, particularly if it is on a slope of 3 or 4 horizontal to 1 vertical. This contradicts former practices that recommended leaving a continuing channel floor for sediment transport and constructing flumes with only side contractions.

(i) *Passing of floating and suspended debris*—Open channels transport various kinds and amounts of floating or suspended debris. To avoid catching debris, the staff gauge or recorder housing should be located to one side of the flow pattern. Most long-throated flumes are streamlined enough to avoid debris trapping unless the debris is larger than the throat. Parallel installations should have rounded piers that are at least 12 inches (300 mm) wide. Sharp-nosed and narrow piers tend to catch debris.

Most pipeline meters do not tolerate debris well, especially moss. Trash screens and racks should be used to keep debris out of the pipeline if it adversely affects the measuring device. Venturi, magnetic, sonic, and other meters that can handle suspended debris are described in a later section.

(k) Getting the most from open channel measuring devices

Most users desire to get the maximum performance and functions from a given gate, weir, meter, or metering system. This encourages attempts to try measuring and controlling flow with the same device. This is not generally recommended because it results in degraded measurement and degraded control. One exception might be the vertically movable flume. When adequately automated, it can measure flows with the precision of flumes and also control to the precision of the selected automation equipment. Equipment costs and labor may not compete with a fixed flume and regulating gate, which could also be automated. Another exception is the vertical moving sharp-crested weir. The weir is a cut-out in the upper part of a standard irrigation canal slide gate. Fluctuations in the water surface in the canal create a degraded measurement and require frequent operator control and monitoring.

(l) Matching requirements and meter capabilities

Selections of the measuring site and the appropriate measuring device are closely related. Some devices or structures are more appropriate for certain sites than others. Some sites require a certain device or structure. Site consideration, particularly for open channels, must be given to the exact location, elevation, and upstream and downstream flow conditions. This information is needed in addition to the general location and the structural shape.

In pipe flows, pipe pressures and head loss generally receive only passing attention. In open channel flows, head loss may be the prime consideration because of the sensitive relationships among the water surface, total energy, and flow rate.

The measuring method must be compatible with the water delivery method and purpose of the delivery. If flow rate is the needed information, then rate meters are usually appropriate. For open channel flows, rate meters generally are less expensive than totalizing meters. Pipeline meters that totalize from some kind of rotating impeller are less expensive than flow rate meters. For billing purposes, totalizing meters are usually specified.

Pipe flows, because of their fixed flow area, can accommodate many meter styles that basically provide a flow velocity that is combined with the inside pipe diameter to obtain flow rate. Open-channel flow meters add the complication of variable flow area.

(m) Open channel flow measurements

This section describes the design, selection, and installation of weirs and flumes in open channels. Frequency and duration of measurements determine whether to select a portable, temporary, or permanent measuring device or structure. A variety of portable structures are described in Bos, et al. (1991). Often permanent measuring structures, such as Replogle flumes, can be installed at all sites for equal or little increased cost over that required for installing mounting brackets at each site and purchasing portable flow measuring devices.

(1) Designing for open-channel flow measurements

The process of designing a flume or weir consists of three steps: selection of site, selection of head measurement technique, and selection of an appropriate structure. Design is a process between these steps. The order and importance of these steps depend on specific conditions encountered. If a structure to measure or regulate the flow rate is to function well, it must be selected properly. All demands that will be made on the structure should be listed and matched with the properties of known structures. Broadly speaking, these demands or operational requirements originate from four sources: hydraulic performance, construction and/or installation cost, ease with which the structure can be operated, and cost of maintenance.

(2) Locating and selecting the measuring site and device

All structures for measuring or regulating the rate of flow should be located in a channel reach where an accurate value of head can be measured. Also, sufficient head loss must be created to obtain a unique flow rate versus head relation (modular flow). The survey of a channel to find a suitable location for a structure should also provide information on a number of relevant factors that influence the performance of a future structure. These factors are described in the following paragraphs.

Upstream of the potential site, the channel should be straight and have a reasonably uniform cross-section for a length equal to about 10 times its average width. If a bend is closer to the structure, water elevations along the sides of the channel become different. Reasonably accurate measurements can be made (added error about 3%) if the upstream straight channel has a length equal to about two times its width. In this case the water level should be measured at the inner bend of the channel.

The channel reach should have a stable bottom elevation. In some channel reaches, sedimentation occurs in dry seasons or periods of low water. The sediment may be eroded again during the wet season. Such sedimentation can change the approach velocity toward the structure or may even bury a flow measuring structure. Erosion may undercut the foundation of the structure.

Water level in the channel generally should be predictable. Water surface elevations are affected by channel discharge, downstream confluences with other channels, operation of gates, and reservoir operation. Channel water surface elevations greatly influence the sill height to obtain modular flow through a measuring structure.

Based on channel water surface elevations and the required sill height in combination with the flow versus head relation of the structure, the possible inundation of upstream surroundings should be assessed. These inundations cause sedimentation because of the subsequent reduction in approach flow velocities.

Soil conditions at the site can influence the tendency for leakage around and beneath the measuring structure caused by the head differential. Excess leakage must be prevented at reasonable costs. Also, a stable foundation, without significant settling is important.

To avoid sedimentation upstream of the structure, sufficient head must be available in the selected channel reach to control flow velocities. For more details on sediment handling, see Bos, et al. (1991).

(3) Measurement of head

As discussed above, the accuracy of a flow measurement depends strongly on the true determination of the upstream, sill-referenced head. The success of a measuring structure often depends entirely on the effectiveness of the gauge or recorder used and desires of the operator.

A sill-reference head refers to the effective hydraulic control section. With broadcrested weirs and flumes, this section is located on the weir crest or flume throat, a distance of about one-third the length upstream of the downstream edge of the sill. The top of the sill (weir crest or invert of flume throat) must be level in the direction of the flow. If minor undulations are on the sill crest, it is recommended that the average level at the effective control section be used rather than the average level of the entire sill. See figure 9-40.

With sharp-crested weirs, hydraulic control occurs immediately upstream of the weir crest. Distance varies relative to approach velocities. Actual location can be observed by the light reflection pattern on the flowing water surface. See figure 9-41.

(4) Location of head measurement

The gauging or head-measuring station should be located sufficiently upstream to avoid detectable water surface drawdown, but close enough for the energy losses between the gauging station and approach section to be negligible. Typically, this distance varies between two and four times the total head loss upstream of the weir crest.

(5) Head measurement method

The head generally is measured either in the channel itself or in a stilling well located to one side of the channel. The stilling well is connected to the channel by a small pipe (to dampen head fluctuations). Many methods can be used to detect water surface elevation. Some use the electromagnetic properties of water and of the water-air interface. Other methods depend on reflecting a sonic wave from the water surface. Still other methods detect water depth with a variety of pressure sensing devices and deduce the head from that information. The most frequently encountered methods are vertical and sidewall mounted staff gauges in the canal or in a stilling well, or both, and float-operated recorders placed in a stilling well. Digital recorders and data logging devices are readily available and have typically replaced the continuous recording devices on rotating drums (ink pens and paper rolls).

(i) Stilling wells—Stilling wells facilitate the accurate reading of the water level at a gauging station where the water surface is disturbed by wave action. It can also house the float for a recorder system or other water surface detecting equipment. The size of the stilling well depends on the method used to measure

the head. The diameter, if circular-shaped, ranges from a recommended minimum size of 4 inches (0.1 m) for hand-inserted dipsticks to over 20 inches (0.5 m) to accommodate large diameter floats. The pipe connecting the stilling well to the canal should be large enough to allow the stilling well to respond quickly to water level changes. In most cases the pipe diameter is about one-tenth the diameter of the stilling well. Further details on stilling wells are in Bos, et al. (1991).

(ii) Staff gauges—Periodic readings on a calibrated staff gauge can be adequate when continuous information on the flow rate is not required. Examples are canals where the fluctuation of flow is gradual. The gauge should be placed so the water level can be read from the canal bank. Staff gauges are commonly used where quick readings can be taken without entering a locked house to read a continuous recorder. The surface of the staff gauge should be kept clean.

For concrete-lined canals, the gauge can be mounted directly on the canal wall. The value, read on the sloping walls of trapezoidal-shaped canals, must be appropriately converted by scale or table to vertical head values before entering discharge tables. Tables are made for stilling well use or vertical gauge applications. For unlined canals, the gauge can be mounted onto a vertical support.

Most permanent gauges are enameled steel, cast aluminum, or some type of plastic resin. Enameled linear scales marked in English or metric units are available from commercial sources. Important flow rates can be noted on these scales by separate markings to avoid the need for tables to be always at hand.

Figure 9-40 Profile of long-throated flume (from Bos, Replogle, Clemmens)

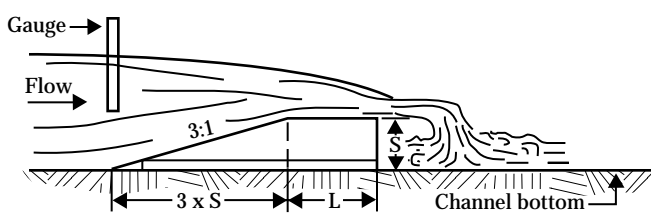
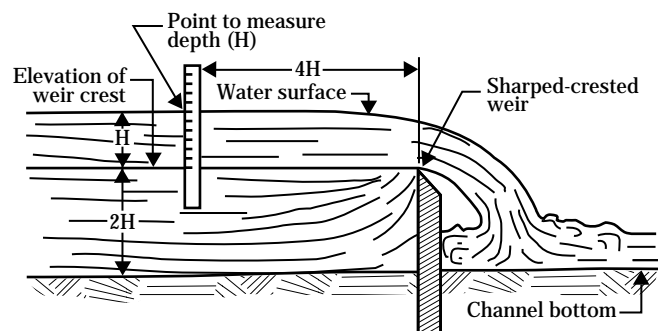

Figure 9-41 Profile of sharp-crested weir



Within an irrigation district or farm, it is frequently desirable to use a limited number of standard sized structures. The gauges of these structures can be conveniently marked directly in discharge units rather than in head or depth units.

(6) Selection of head-measurement device

The success or failure a water measuring structure and the value of the collected data depend closely on proper selection of a suitable head measurement device. The three most important factors that influence this selection are frequency of discharge measurement, allowable error in the head detection, and type of measurement structure under consideration.

(7) Gauge placement and zero-setting

The most important factor in obtaining accurate discharge measurements is the accurate determination of the sill referenced head. The upstream sill referenced head can be measured by a gauge or recorder only if the observed water level is known with respect to the weir sill (or flume crest) elevation at the control section. The method used to set (zero register) the gauge and recorder depends on the structure size, type, flow rate in the channel during the setting procedure, and available equipment. Standard surveying techniques are practical for accurate setting of most wall or staff gauges.

The canal side slopes only approximate the intended slope. To compensate partly for this, the gauge can be mounted so that a selected scale reading from the most frequently used range of the gauge coincides with the corresponding elevation for that reading. Thus, greatest reading errors occur in the flow ranges that are seldom used. If this procedure causes the zero end of the scale to be displaced by more than about 1/4 inch (5 mm), the actual side slope should be determined for adjustments to the calibration. This also should be done if accuracy over the full flow range is required.

Several methods are available for zeroing a water level recorder; three are particularly suitable. The recorder can be set when the canal is dry, when water is ponded over the flume, or when water is flowing through the flume. These zero-setting methods assume that the sill referenced elevation can be determined during the procedure. This is not always practical, especially on wide structures. A stable and permanent surveying benchmark should be added to these struc-

tures. The benchmark can be a metal rod or cap placed in concrete. Its elevation should have been previously established relative to the sill elevation. More detailed information on zero-setting procedures is in Bos, et al. (1991).

(8) Determining structure dimensions

Long-throated flumes and broadcrested weirs operate by using a channel contraction to cause critical flow. If there is not enough contraction, critical flow does not occur. Flow is then nonmodular, and gauge readings become meaningless. If there is too much contraction, the water surface upstream may be raised excessively and cause canal overtopping or other problems. The challenge facing the designer is to select the shape of the control section, or throat, so that critical flow occurs throughout the full range of discharges to be measured. Also, the designer must provide acceptable sensitivity and accuracy while not causing too much disruption in upstream flow conditions (sediment deposition, canal overtopping). This appears to be a difficult task, but existing design aids and rating tables make this task more manageable.

Flumes and weirs constructed of wood can be used. However, until flow through a wood structure begins, it must be weighted down or be well anchored to prevent flotation. If a wood structure floats after flow begins, the flume or weir is said to be submerged, thus unusable. A different size or structure should be installed.

(n) Pipeline flow meters and applications

Flow meters for pipelines are frequently used for irrigation water management decisions, particularly where pumped wells are used. Some flow meters are well established. Other less well known meters are described in some detail herein. The familiar meters are given less treatment because they are either well documented or are judged to be of limited application to irrigation. Yet another group is too new to irrigation to have an extensive history in this application; therefore, they are again given broader treatment.

Some of the newer pipe flow meters have very low head loss. They include vortex shedding meters, magnetic flow meters, and sonic flow meters. The last two meters can operate with no detectable head loss

to the flow because no restrictions or mechanisms are inside the pipe.

(1) Venturi meters

Venturi meters represent one of the older, more reliable flow measuring methods called differential head meters. The head loss is low, and slurries pass readily. In irrigation works, small venturi meters are used for chemical injection applications. Sizes compatible with most irrigation wells generally are considered too costly. The flow range is similar to that of the orifice meters, which are described later in this chapter. These devices are well covered in the literature, and little new information is available. See: *Handbook of Hydraulics*, King and Brater, for a complete description of these meters.

Certain angles of convergence and divergence must be observed for standard venturi meter behavior. The conduit walls should converge relative to the centerline at about 10 degrees and diverge on the downstream side at about 5 to 7 degrees. Low velocity venturi meters have also been constructed from ordinary PVC pipe and fittings. Where throat lengths are at least three times the diameter of the pipe, fitting configuration appears to have little effect. Venture flow meters require two pressure taps, one in the throat and one upstream before convergence. Typically venturi flow meters have low head loss. To keep venturi flow meters to a reasonable size on large pipelines, they are often used as a shunt meter, where a much reduced part of the total flow is actually measured. The ratio must be known to project the measured flow to total pipe flow. Chemical injection systems often use a shunt Venturi.

(2) Pitot tubes

Like venturi meters, pitot tubes are well documented in King and Brater, 1954. The original version is named for Henri Pitot who used a bent glass tube to measure velocities in the River Seine in 1730. Pitot tubes have a narrow range of application similar to venturi meters. A flow-differential version is the standard prandtl tube that incorporates the impact pitot tube within a jacketed concentric outer tube. Holes in the side of this outer tube are used to detect the existing static pressure in the flow region.

The difference between the impact pressure and the static pressure represents the velocity head, from which the point velocity is computed. An impact pitot

tube and a pipe wall piezometer tap are frequently used to accomplish the same thing. Several variations of pitot tube based devices are marketed. Most of the variations depend on careful laboratory calibration. Standard pitot tubes and the prandtl type tubes have a coefficient nearly equal to unity. These tubes are best used for intermittent and attended measurements because they are subject to clogging in all but the cleanest flows.

(3) Orifice meters

Many of the marketed flow meters, for other than residential use, are differential pressure types. Of these the most common type is the sharp-edged orifice plate. Thousands of these meters measure gas, liquid, and mixed fluid streams in pipelines around the world. The modern computer has given these primary measuring devices renewed importance.

Orifice flow meters are frequently used in irrigation applications for measuring well discharges and for injecting agricultural chemicals into irrigation flows. The latter are usually of small diameter and operational details generally are furnished by the manufacturer of the chemical injecting device. Consequently, larger diameter orifice plates in round pipes are primarily dealt with in this guide. Usual rusted pipe conditions and general maintenance for irrigation wells limit field accuracy in irrigation practice to no better than 3 to 5 percent of actual flow.

Most reliable flow meters require fairly stringent installation requirements. The orifice plate is no exception. Because abrupt pressure changes take place at the plate, the orifice plate is generally affected more by disturbed flows than other differential pressure meters. Poor installation of an otherwise properly designed orifice plate can result in 20 percent errors.

Orifice plate standards are based on extensive experimental data and can be applied with a fair degree of confidence. Anomalies still exist, however, and some of which will be discussed later.

Advantages of the orifice plate are its simplicity and the ability to select a proper calibration on the basis of the measurements of the geometry. Disadvantages of the orifice plate include the long, straight pipe length requirements and the complication of extending the measuring range beyond a ratio of about one to three.

The operating flow range can be changed by substituting an orifice plate with a different hole size. Tap locations based on pipe diameter rather than orifice diameter make this feasible because the same tap locations can be used for all orifice plate sizes. The pressure tap is located about one pipe diameter upstream of the orifice plate. In a continuous pipeline, the downstream pressure tap is located at the vena-contracta (immediately downstream and adjacent to the orifice plate).

The orifice plate should be mounted in such a way that inspecting at least the orifice plate and preferably the adjacent piping is possible. Portable orifice plate meters can be attached to the downstream end of discharge pipelines. Care should be taken to install the meter level and have the appropriate straight pipe length upstream of the orifice plate (generally a part of the meter).

(4) Rectangular sharp edged orifice/open channel applications

Rectangular orifices formed by a partly open, irrigation canal gate are frequently used as flow indicating devices. Accuracy of the primary opening, not including the errors of secondary detection of depth, can be within 5 percent of actual. Every gate should be calibrated for specific onsite conditions.

Early day miners in the West developed a flow term called *miners inches* where a rectangular orifice (2 inches high and up to 12 inches wide) was cut through a 2-inch wooden plank. Thus, a 2-inch by 10-inch orifice would deliver 20 miners inches. How to measure the standard 6-inch hydraulic head on the orifice varies between geographical areas. If the 6-inch head is measured from the horizontal center of the orifice to the upstream water surface, 1.0 miners inches = 1/40 cubic foot per second or 11.25 gallons per minute (applicable in Northern California, Arizona, Montana, Nevada, and Oregon). Where the 6-inch head is measured above the lower edge of the orifice, 1 miners inch = 1/50 cubic foot per second, or 9.0 gallons per minute (applicable in Southern California, Idaho, Kansas, New Mexico, North Dakota, South Dakota, Nebraska, and Utah). In Colorado, 38.4 miners inches = 1 cubic foot per second.

(5) Elbow meters

Elbow flow meters are made by drilling pressure taps midway along the bend centerline on the inside and the outside of the elbow bend (Spink 1967). This corresponds to 45 degree tapping for a 90 degree elbow bend. If the radius of the inside bend is accurately determined by plaster casting or other means, the discharge equation can be estimated to within 3 percent of actual. The differential pressure across the inside and outside taps is produced by velocity differential and by the centrifugal force of fluid in the elbow; velocity responds to about the square-root of the head differential.

(6) Current meters, propeller meters, and cuptype meters

Propeller meters are commonly used in open channel flows to measure velocities at various points in the channel cross-section. Cup type rotors are also used. The choice depends on whether the user wishes to detect velocities in the direction that the meter is pointing (propeller) or whether all velocities in the flow plane are to be detected, regardless of flow direction (cup type). Accurately determining cross-sectional area (especially depth), particularly with earth, grass lined, or cobbly bottom canals, is a major problem with open channel applications. Another is velocity distribution effects. The technician generally divides the channel into about 10 equally spaced, vertical sections. If standard flow profiles can be assumed, a single measurement at 0.6 of the depth from the surface gives reasonable results. This depth is typically used in shallow flows. When depths permit, 0.2 and 0.8 locations generally give more reliable results. In fixed section channels, well-trained operators using well-maintained equipment can expect results with errors less than plus or minus 5 percent of the actual flow rate.

A short, smooth, level concrete section is often constructed in the open channel where long-term measurements are made. This is done to reduce opportunities for errors. If a variety of flows over a wide flow depth for any stable cross section can be measured, the section can be rated. A staff gauge can then be used to measure depth and, with a rating table, converted to gallons per minute, cubic feet per second, or acre-inches per day. Occasionally, flow measurements are taken to check the rating table. USGS, state water resource agencies, and local irrigation organizations use this method to measure larger flows in canals and

streams. Installation of a long-throated flume at these locations should be considered.

As mentioned, major errors with the current metering method may be with the cross-section area determination rather than velocity detection. For example, if a flow of 17-inch depth and 3-foot width is attempted in a grass-lined channel, an uncertainty of the flow depth and width may be greater than 1 inch (30 mm) or over 10 percent error in flow area. This uncertainty must be combined with velocity errors.

(7) Propeller meters

Propeller meters are frequently used in irrigation pipelines, particularly for flows from irrigation wells and at farm deliveries. Propeller meters offered for irrigation service generally stress ruggedness and durability over accuracy. Secondary readout devices are usually mechanical. Recently, electronic readouts have been offered. Most have less than plus or minus 3 percent error when installation specifications are followed. Errors in field installations frequently exceed plus or minus 5 percent because some of the pipe length requirements are hard to meet when retrofitting older piping installations. Vanes can be used to minimize nonstandard installation conditions.

The main difference between a propeller and a turbine meter is fewer blades on a propeller and the absence of a blade tip ring for blade stability. Propellers are often built with a swept-back design on two, three, or four blades so they tend to shed debris. Some pipe propellers are restrained by the nose with a long sweeping shaft so that the mounting also sheds trash.

(8) Turbine meters

Turbine meters are used extensively in the gas and petroleum industries. They are especially applicable to flows in high pressure lines. More often the related full-pipe diameter or part-pipe diameter blade is used.

Several problems are associated with the use of turbine meters. Unlike simpler meter types, turbine meters are viscosity-sensitive. Meters calibrated in water, for instance, give different meter-factor curves when used in another fluid. The reasons are complex and are associated with the combination of lift, drag, and friction forces affecting the rotor and the bearings differently. Turbine meters are also sensitive to installation conditions.

(i) Paddle wheel turbines—Although not really a propeller, a small paddle wheel turbine is widely used in large diameter irrigation pipelines and supply wells. It samples only the flow near the pipe wall. This velocity is converted to average flow velocity using general expectations about flow velocity profiles in pipes. This method of flow measurement is sensitive to velocity changes across the pipeline cross-section.

(9) Vortex-shedding flow meter

The vortex-shedding meter is a relative newcomer to pipeline flows. It is expected to essentially replace the orifice meter. Application in irrigation pipelines, particularly water delivered from wells, is a likely application. The most common form of the vortex-shedding flow meter is a strut or bluff body placed in a turbulent stream. Periodic vortices generated, travel several pipe diameters downstream in the mean velocity of the stream.

The phenomenon is demonstrated by air flowing past a flagpole, which generates vortices that alternate on either side of the flag causing it to wave. Applied to a flow meter, the rate of vortices generated (the rate of vortex reversals) when flow strikes the blunt obstruction, or bluff body, is sensed as a measure of passing flow. Passing vortices cause pockets of low pressure in the flow stream and allow for a variety of measurement techniques in commercial flow meters, including ultrasonic, thermal, mechanical, strain gauge, and differential pressure devices.

Little research has been reported on critical dimensions in the design of the bluff body (blunt obstruction) to enhance strength of vortices. One study was conducted in the United Kingdom by Lucas and Turner (1985). They developed the critical dimension of a T-shaped bluff body that optimizes measure accuracy. The response is linear with range abilities on the order of 100:1. The T-shaped buff body used has fast response capabilities with good accuracy, repeatability, and stable calibration conditions.

The major disadvantage of the T-shaped buff body is the need to have sufficient flow rate to create vortices. However, the device can be used at low flow rates without special detection methods. Other known problems are associated with pipe vibrations. Outside vibration sources, such as from pump machinery, appear to interfere with vortex generation and detection.

Head loss across a vortex shedding flow meter is typically two pipe velocity heads, although this depends on the blockage caused by the particular bluff body. Fluid velocities of up to 150 feet per second can be handled; however, high flow rate limitations do exist. In liquids these would be dictated by the onset of cavitation at the meter. Despite these limitations, vortex shedding flow meters may eventually replace orifice plates at comparable cost.

(10) Magnetic flow meters

Magnetic, or electromagnetic, flow meters offer an excellent solution to problems of flow measurement in conductive liquids. In recent years they have become widely accepted in industry because of their many advantages. Some advantages are no moving parts, head loss equal to that of a similar length of pipe, and accurate measurements over a wide flow range.

The measuring principle is based on Faraday's law of electromagnetic induction. Essentially, electrically conductive liquid flowing through a magnetic field induces a voltage at right angles to the magnetic field and in the direction of flow. If the flux density is a constant, the pipe diameter is fixed, and the pipe is flowing full, then the induced voltage is proportional to the velocity of the flowing liquid. The voltage generated can be AC or DC, depending on the electrical source used to excite the coils that produce the magnetic field. Completing this system is a transmitter, which is a specially designed voltmeter, or more recently may include a microprocessor. The transmitter converts the low-level generated voltage to a usable output signal for flow-rate indication, totalization, or control.

In practice, voltage is sensed by two electrodes mounted in the same plane, but directly across an electrically insulated section of pipe. Since its invention in the late 1930s, the electromagnetic flow meter has been extensively developed. The developments include DC coil energization and weighted magnetic fields. More recent emphasis has been on coil design to reduce the size and power consumption of the flow meters, which has been about 20 to 30 watts.

Electromagnetic flow meters typically provide accuracy of between 0.5 and 1.0 percent of actual over a wide range. As long as a minimum electrical conductivity is present in the measured fluid, volumetric flow rate is measured without interference from entrapped solids.

(11) Ultrasonic flow meters

Ultrasonic meters, like many modern meters, were initially oversold. A particular problem is convincing users that the two basic systems using ultrasonic waves, the Doppler and the transit time meters, operate on completely different principles. The modern clamp-on transit-time meter can indicate flow rate to better than plus or minus 2 percent of actual, depending on design. The Doppler meters usually indicate plus or minus 5 percent. A major advantage of ultrasonic methods is the negligible head loss and the ability to install either portable or dedicated systems without line shutdown.

As mentioned, ultrasonics are applied to flow metering in two basic ways. This results in two basic meter types: transmission and reflection (Doppler). The transmission type establishes a sound path through the liquid in the pipe or channel. The reflection type depends on particles in the fluid that can reflect sound to the receiver, and is really just another way to detect particles in the flow. Sonic signals are about 100,000 cycles per second.

A major disadvantage of externally mounted ultrasonic meters is the need to know exact inside pipe diameter and inside wall surface condition. Ultrasonic meters work best on noncorrosive pipe materials unless the corrosion or built-up material (scale) can be determined. Calibration on a similar pipeline and known flow rate is recommended to compensate for these uncertainties.

Proper operation of both transit time and Doppler ultrasonic flow meters require:

- Acoustic contact between transducer face and pipe so the ultrasonic signal can be injected into the pipe. Machine grease or silicon grease can be used, or silicon rubber can be used if the device is to be permanently installed.
- The system should not be used with partially full pipes. The sensed velocity may be correct, but the flow area generally is wrong.
- The mounting of the transducer must be parallel to the axis of flow. The extreme top or bottom of horizontal pipe walls should not be used. This helps avoid problems with bubbles (top) or bedload sediment (bottom).

(i) Ultrasonic transit time (time-of-flight) meters—The ideal flow meter is one that can be installed on the outside of a pipe, but can give the performance of the best flow meters installed inside the line. Ultrasonic transit time meters have been developed toward these apparently conflicting but demanding criteria. Multiple beam, single path, systems have been installed on many pipelines, the most notable of which is the Alaskan oil pipeline. Single path transit time ultrasonic meters require a transmitter/receiver on opposite sides of a pipeline. With double path meters, only one side of the pipeline is used. A reflective path (one-sided) ultrasonic transit time meter reflects the sonic signal off the opposite inside wall of the pipeline. With both types, good contact must be made between the transmitter/receiver and outside pipeline wall. Both types send a sonic signal across the flow area at a 20 to 45 degree angle to the flow velocity.

These meters are popular for measurement of flows in large pipelines. Many transit time meters can be used on pipelines as small as 2 inches in diameter. They have also been used in some open canal systems. The flow must be relatively free of suspended materials that could reflect and spread the sonic energy. In pipes that are more than 3 feet in diameter, four paths across the full pipe are commonly used. The meters are relatively expensive and require an electric power source and trained technicians for assured operation.

Ultrasonic transit time flow meters require at least two transmitters and two receivers. Two sound paths are established in the fluid, usually along the same diagonal path, but in opposite directions. On one path, the sound travels with the direction of fluid flow (at an angle across the flow). On the other, the sound moves against the direction of fluid flow. The motion of the fluid causes a frequency or phase shift in each path, which is measured and converted to fluid velocity.

(ii) Ultrasonic, reflective type Doppler meter—The Doppler, or reflective type, meter developed to measure effluent flow also works on a frequency shift principle. The frequency shift occurs in the sound reflected from particles that are presumed to be moving at the same velocity as the fluid itself. Latest versions claim to operate with particle sizes below 100 micron and at a concentration of 100 parts per million or less. With the Doppler reflective type meter, only one transmitter and one receiver located on the same

side of the pipeline are used. The sonic signal is reflected off the opposite inside pipeline wall. Sonic flow path is perpendicular to the pipeline centerline.

Doppler theory in this application is based on the assumption that the doppler shift is inversely proportional to the velocity of the particles in the liquid.

(iii) Ultrasonic meter for irrigation flow measurements—A particular exception to high cost and lack of ruggedness usually associated with ultrasonic transit time flow meters may be a recently introduced device designed for measuring both flow rate and total flow in irrigation pipelines that are flowing full. Badger Meter, Inc., sold the particular units observed to the New Magma Irrigation District, Central Arizona Irrigation and Drainage District, and Maricopa-Standfield Irrigation District, all in Arizona. They were put into service during the fall of 1986. (Use of brand names is for the reader's reference and information and does not constitute endorsement by the author or USDA, NRCS.)

Called the Model 4420 Compusonic meter, it is a transit time, single path, ultrasonic flow meter. It uses battery power with solar panel recharging, and is microprocessor controlled to allow a sleep/wake-up mode to conserve power. It has two LCD displays, one three-digit display for flow rate and a six-digit display for totalized flow volume. It is programmable in BASIC to particular units. A serial communications port allows accumulated flow data to be dumped to a data logger. The meter has two internal totalizers. One cannot be reset and is displayed continuously. The other totalizer can be temporarily displayed in its place and can be reset to zero. Flow rate readings can be obtained by manual activation. Because of pipeline flow turbulence, 3 to 5 readings averaged over a 10-minute are recommended for best accuracy.

Sonic sensors are installed about 100 feet downstream from circular slide gates in pipes that are about 2 feet in diameter. Most of the pipelines are slightly curved. Sonic sensors are premounted on a stainless steel circular band that is inserted into the pipe immediately upstream of the outlet. The outlet is installed below the grade of the farm lateral it supplies, so the irrigation district pipeline stands full of water between deliveries. This should inhibit growth of crystals on the sensor faces. Sensors sample a single horizontal path across the pipe for 16 seconds every 15 minutes,

or when manually activated. Best accuracy is claimed for flow velocities in excess of 0.5 foot per second, but detection of flow is practical at velocities as small as 0.1 foot per second. The angle of the single path beam is at 22 degrees across the pipe. Field checks against Replogle broadcrested weirs showed good agreement within less than plus or minus 3 percent for the four locations tested.

(12) Other measuring devices

Other meters or measuring devices having limited application to measuring irrigation flows are available. They are mentioned primarily as examples that meters exist using one or more of the common physical principles. Others are so uncomplicated as to require little explanation. For example a volume meter, which can consist of a calibrated container and stopwatch, can be used to measure flows from sprinkler heads, siphon tubes, or other small diameter conduits that have water flowing in a free-fall condition. Rotameters are sometimes used to monitor chemicals being metered into irrigation flows, such as for chemigation with pressurized irrigation systems. Many of these simple measuring procedures are described with applicable irrigation system evaluation procedures earlier in this chapter. Several open channel measuring devices are commercially manufactured in reduced sizes to provide small portable flow measuring devices for small channels or furrows. These devices include orifice plates, v-notch weirs, Replogle flumes, v-notch flumes, H-flumes, and Palmer-Bowles flumes.

652.0907 State Supplement

Irrigation Water Management

Irrigation system application is based on managing the proper amount of water to the plant in order to: meet crop needs, apply amounts adequate for the soil, and avoid runoff while maintaining or improving water quality.

Water quality is also covered in Part 652, Chapter 13 and other NRCS references.

Water Needs of Crops

Chapter 4 of this guide discussed the crop water use requirements for your location. This information is based on past weather data calculations from crop water use equations. The crop water requirements are normally given in 3 ways - inches per day for the peak period of use; monthly use rates during the irrigation season; and for the entire irrigation season.

The relationship between the daily, monthly and yearly water use rates for a location is used to calculate the peak flow rate of the system (gpm) and the amount of water required to irrigate for the season (acre feet).

Example

From Chapter 4, Crops, the crop water use was calculated using IWR for grain corn in Prosser, WA. The peak consumptive use rate was in July and is 0.31 inches per day. Using the attachment in chapter 4, the daily peak use rate can be calculated from the following equation:

$$U_p = 0.034 * (U_m)^{1.09} * (I)^{-0.09}$$

U_p – Daily peak consumptive use rate – in/day

U_m – Monthly peak consumptive use rate – in/month

I – Net irrigation application in inches

In Prosser, WA, the peak month is July at 9.99 inches. From the example in Chapter 4, the net

irrigation application is 1". The daily peak from the attachment in Ch 4 is:

$$U_p = 0.034 * (9.99)^{1.09} * (1)^{-0.09}$$

$$U_p = 0.42 \text{ inches per day}$$

System Flow Rate

The flow rate for the system to apply this amount (0.42 in/day) can be calculated using the following equation;

$$Q T = D A$$

Q - flow rate in cfs

T - time in hours

D – depth in inches

A – area in acres

The system flow rate for the above example on a 75 acre field operating 24 hours a day would be:

$$Q = 0.42 * 75 / 24$$

$$Q = 1.31 \text{ cfs}$$

This is the net amount of flow required. Each type of irrigation system has uniformity problems. Center pivots have variations in application along the pivot. Wind drift and evaporation from the crop also cause variation. Surface irrigation systems have high application rates near the source and lower rates as the water moves across the field. Runoff and deep percolation can also be a problem with surface irrigation systems. The lack of uniform applications results in needing to apply more water than the net amount above to overcome the inherent system limits. This is called the efficiency of the system. Typical application efficiencies are listed in Chapter 6 Irrigation System Design - Table WA6-2.

The net amount of flow required would be increased based on the efficiency of the planned system. In the example, assume that a pivot is

going to be used. From Table WA6-2, the average efficiency would be 85%. The gross amount of water required would be the net divided by the efficiency.

Gross Flow Rate = Net Flow Rate / Eff

Gross Flow Rate = 1.31 cfs / 85%

Gross Flow Rate = 1.54 cfs

This is the flow required at the center pivot to meet the crop need during the peak use rate. This means that during less water use periods (spring and fall) the system does not need to be operated continuously to meet the crop water use. Monitoring soil and plant water levels can provide information on both watering frequency and amounts.

Management Allowed Depletion

Not all of the water in the soil is available to the crop. The management allowed depletion (MAD) was explained in Chapter 3, Crops and is found in Table 3-3 for most crops. For the example above using grain corn the MAD is 50%.

The rooting depth of the crop is needed to determine how much of the soil profile is used. Table 3-4 provides some rooting depth for crops. For grain corn the rooting depth is 3-4 ft (Table 3-4), for this example use depth of 36".

In Chapter 2 Soils section 652.0204 (c), we found that the water holding capacity (WHC) of the soil (gross) in the example was 4.7 inches for the 36" soil depth.

The net amount of water to be replaced during each irrigation is the gross WHC times the MAD.

Net Irrigation = Gross WHC * MAD

Net Irr = 4.7 inches * 50%

Net Irr = 2.35 inches

This net irrigation amount is the *maximum* amount of water that the crop can use before yield reduction or plant quality can be affected.

Frequency

The frequency of irrigation is based on the net irrigation requirement and the daily consumptive use rate. The frequency of irrigations is the net irrigation divided by the peak daily use rate.

Frequency of Irr = Net Irr / Peak Daily Use Rate

Frequency of Irr = 2.35" / 0.42 in/day

Frequency of Irrigations = 5.6 days

Since the daily peak use rate was used to determine the frequency, the 5.6 days is the maximum time between irrigations during the hottest time of the year. Longer frequencies can be used during lower daily use rates, when the crop is small or during cooler times of the year.

Solid set systems (including hand lines and wheelines) use the frequency to determine cycle rates, system total flow, and design. The irrigator must cover the field in the frequency to ensure adequate water applications.

On continuous move system (linear and pivots) the system speed can be adjusted, the application time, and amount of water per irrigation can be changed. These types of systems can have a frequency that is adjustable. Therefore the frequency is generally not a concern on these types of system. The flow rate is more of a concern – to meet the daily peak use rate by the system.

Summary

On the 75 acre field of corn in Prosser, the pivot system must apply 0.42 inches per day. Assuming that water is available for 24 hours with a system efficiency of 85%, the flow rate is 1.54 cfs. The pivot must apply 0.42 inches in

one day (or 0.84 inches in 2 days). The frequency of irrigations on pivots is generally a management decision. Longer frequency can usually reduce the effect of surface evaporation and get more water into the soil. However it is very possible that runoff will occur on the outer end of the pivot when long frequencies are used, especially during early stages of crop growth.

In this example the maximum frequency is 5.6 days between irrigations. At this frequency, the amount of water needed to be applied would be 2.35 inches.

As mentioned above, system application rates for pivots can be a problem on the outer end where the soil intake may not be adequate to absorb the water. Table 2-6, in Chapter 2, provides some soil intake ranges by soil texture.

The National Engineering Handbook (NEH) Section 15, Irrigation, has chapters to work through application rates by system. Refer to Chapter 4 for surface irrigation, Chapter 7 for Micro Irrigation systems, and Chapter 11 for Sprinkler systems for more details on application rates.

Water measurement

Due to the number of measuring devices available and the fact that most were described in Part 652.0704 and 652.0906, additional descriptions were not considered necessary. The exception is the Ramp flume, which has been developed fairly recently and therefore is included to provided the reader with new knowledge. Software for use with the Ramp flume can be found on the NRCS computer. It is also available from the NRCS Water and Climate Center web site at:

<http://www.wcc.nrcs.usda.gov/nrcsirrig/>

Example

A typical ramp flume design is as follows:

Estimated flow at site: 12 cfs
Ditch cross section is rectangular
Width 6 ft
Channel Depth 2 ft
Elevation top wall 101.2
Bottom channel 99.2

Ramp flume dimensions

Ramp length 4 ft
Slope on ramp 2.67:1
Level section width 1.5 ft
Level section height 1.5 ft

Table of flows

Depth	0.3'	0.6'	0.7'	0.8'
Flow	3cfs	8.7cfs	11cfs	13.4cfs



Figure WA9-1 Ramp Flume on the Sequim Prairie headgate Sequim, WA

Chapter 10

Conservation Management Systems and Irrigation Planning

Contents:	652.1000	General	10-1
	652.1001	Objectives of an irrigation plan	10-2
		(a) Written plans	10-2
		(b) Degree of planning	10-2
	652.1002	The planning process	10-3
		(a) Determining problems and objectives	10-5
		(b) Resource inventory and analysis of data	10-5
		(c) Formulate and evaluate alternatives	10-10
		(d) Decisions and implementation	10-11
	652.1003	Irrigation system, operation, and water management plan	10-11
		(a) Conservation plan for crops, pasture, or hayland	10-11
		(b) Irrigation system application plan	10-12
		(c) Irrigation water management plan	10-12
		(d) Installation	10-13
		(e) Maintenance	10-13
		(f) Followup and evaluation	10-13
	652.1004	Planning aids	10-14
	652.1005	State supplement	10-28

Figure	Figure 10-1	Irrigation planning process	10-4
---------------	--------------------	-----------------------------	------

Exhibits	Exhibit 10-1	Environmental effects for resource management plan	10-8
	Exhibit 10-2	Irrigation system inventory worksheet	10-15
	Exhibit 10-3	Irrigation planning worksheet	10-21
	Exhibit 10-4	Irrigation plan map	10-23
	Exhibit 10-5	Irrigation water management plan for sprinkler irrigation system	10-24
	Exhibit 10-6	Guide for estimating soil moisture conditions using feel and appearance method	10-27

652.1000 General

The material in chapter 10 is intended to help the consultant assist users of irrigated land plan conservation management systems that maintain productivity of the soil, water, air, plant, and animal (SWAPA) resource base as well as take into account human considerations (social, economic, and cultural). Conservation management systems consider the total farm or ranch environment, including the watershed, airshed, and environment in which it exists. Conservation management can involve one or more resource management systems. Irrigation system planning must consider the potential interactive effect on SWAPA resources plus how an action may affect the onsite and offsite human environment. **An irrigation system plan is a component of an overall farm conservation plan.** Irrigation system planning includes:

- Sustaining or improving soil condition (includes productivity)
- Maintaining or improving surface and ground water quality and quantity
- Wise use of limited water supplies
- Providing a condition healthful for growing plants without degrading other resources
- Consideration of domestic animals and wildlife
- Impacts on soil erosion and deposition
- Consideration of human needs

Conservation irrigation planning requires the development of conservation management systems. A conservation management system is a combination of conservation practices that when installed and maintained will protect the SWAPA resource base. Included are meeting tolerable soil losses, maintaining acceptable water quality, conserving limited water supplies, providing equal or greater returns, and maintaining acceptable ecological and management levels for the selected use. Conservation management systems also include conservation practices that improve the quality of the environment and standard of living of those living on the land. To an irrigator this can mean reducing water and energy use, controlling erosion, improving crop yield, improving product quality, and maintaining productivity of the land.

The art and science of planning involve working closely with the irrigation decisionmaker to understand objectives and concerns and to identify resource problems. This requires a resource inventory to develop the foundation on which to base alternative conservation management systems. Alternatives must be presented to the user in such a way that details can be easily understood and informed decisions can be made. Implementation requires quality and detailed plans. Installation of an irrigation system and components should be completed according to these plans. Daily management, operation, and maintenance of the irrigation system must be included in the plan with costs and benefits identified.

Planning is a continuing process, not an end product in itself. Planning has value only if implemented. A cooperator's objectives change as do economic conditions. Follow-up assistance may be required to address these changes and to make adjustments in conservation resource management. Even with detailed planning and design, most irrigation related recommendations are estimates and must be adjusted under actual field conditions. The management plan must take these factors into account.

652.1001 Objectives of an irrigation plan

The irrigation plan helps implement the irrigation component of an overall farm conservation resource management. The plan is the result of a joint effort between the consultant, owner, operator, and the irrigation decisionmaker in which technical knowledge and experience are pooled. An irrigation plan follows the nine steps of planning (NRCS National Planning Procedures Handbook) and encompasses all aspects of planning on irrigated land. The plan includes determining the water user's objectives and problems, SWAPA resource inventories, alternative analysis, and decisionmaking. Irrigation system operation and maintenance plans are a part of irrigation system planning. Coordination with cropping system plans, irrigation system plans, drainage plans, irrigation water management plans, and follow-up plans is essential.

(a) Written plans

Written documentation is essential for use by the decisionmaker. Documentation of the irrigation plan should be used in decisionmaking processes and as a guide to carry out the plan. Irrigation plan documentation may be presented as one document or, more likely, as several documents over a period of time depending on the stage of planning.

Written documentation should be thoroughly discussed with and understood by the decisionmaker. The type and amount of information that must be presented and when the information is needed have a bearing on the form of written documentation. The minimum content of the plan is up to the professional judgment of the persons (consultant and decisionmaker) preparing the plan. The desires of the decisionmaker should always be reflected. As a minimum, the plan should identify irrigation scheduling methods and the chosen method, the irrigation system to be used, and an operation and maintenance plan.

The individual(s) preparing the plan must decide the amount of detail that planning should involve and the

content of written plan documents. Information given to the decisionmaker must be clearly understood, usable, and not cluttered with unneeded material.

(b) Degree of planning

Irrigation planning can be complex, involving environmental assessments and impacts, agronomy, soil, animal husbandry, engineering, economics, ecology, and farm and ranch management. On the other hand, it can be direct, addressing only one concern and its effect on the environment. Plan preparation and content should be based on the irrigation decisionmaker's needs and identified resource concerns.

An conservation planning process considers the farm, ranch, or community as a whole even if the decisionmaker is interested in only one field or practice. This can ensure that delivery system components of pipelines and ditches are an adequate size and elevation to service all the unit. Should operators choose not to size a pipeline or ditch for the expanded system, they should understand the pipeline or ditch may need to be enlarged or supplemented when the current irrigation system is expanded. The conservation planning process also helps assure the irrigation operation fits into the rest of the farm or ranch operation. The total farm water supply (rate, volume, and availability) should be inventoried to help assure proper irrigation in the selected area.

Implementation of the irrigation plan may begin with one field, one ditch, or one pipeline and may continue for several years. Revisions may be needed because of the constantly changing farm economy and changing client objectives.

Clients may have strong feelings about certain irrigation methods or systems. Even so, they deserve information on the best available systems and management techniques that will meet both their needs and those of the site. Pros and cons, including labor and economic considerations, of the best fit systems need to be provided. The decisionmaker can then make an informed choice from alternatives presented.

Often the irrigation water user wants technical help, cost share, or both, on a single practice. A planner's skill is reflected in how well the opportunity is used to

promote conservation of primary soil and water resources, and how well NRCS consultants work with the water user to plan a sound conservation management system for irrigated land.

652.1002 The planning process

The planning process involves nine basic steps in the development of a total conservation management system. They involve:

- Irrigation system and components
- Soils, crops, and tillage management
- Irrigation system operation and maintenance
- Water management

Planning process steps are:

Step 1 Identify the problem including resources of concern—Water source, quality, and quantity; soil erosion; labor; energy.

Step 2 Determine objectives—Water user's desires and needs, community resources of concern, and other such information.

Step 3 Inventory the resources—Soils, water, air, plant, and animal resources, including drainage, salinity, existing irrigation system, and labor available.

Step 4 Analyze resource data—Consider the effect each resource has on the others.

Step 5 Formulate alternatives—Irrigation method, system, components. Include irrigation scheduling methods appropriate for the user.

Step 6 Evaluate alternatives—Consider potential environmental impacts, costs, and on-farm labor and skill availability.

Step 7 Water user decision—Which irrigation method, system, and components to use; and, overall water management desires.

Step 8 Water user implements irrigation plan.

Step 9 Followup—Evaluating results of plan implementation, onsite and offsite. Revise plan as needed.

See NRCS National Planning Procedures Handbook (NPPH) for more detailed information on the NRCS planning process. A flowchart illustrating this process is displayed in figure 10-1.

Figure 10-1 Irrigation planning process

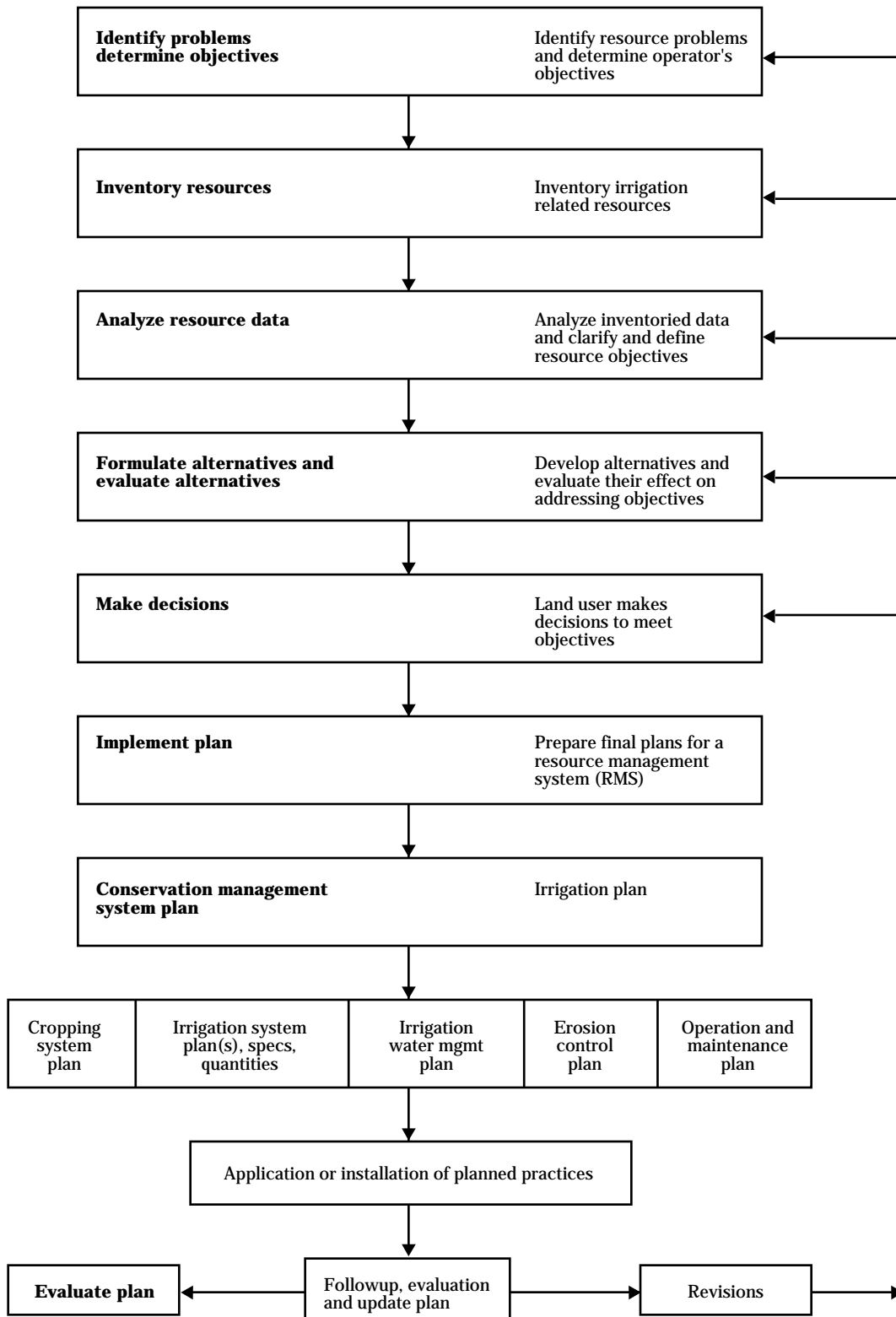

(a) Determining problems and objectives

One of the most important steps in the planning process is to determine the water user's objectives and concerns. One of the best ways to do this is to walk the fields to be planned with the user. Look around, look at the next field, dig or auger some holes, use a probe, check root development of previous crops, talk about what you see, and **listen**. Expand the inquiry beyond the boundary of the original request for assistance. If the request was for a specific practice or irrigation system component, what thought was given to how the practice fits into overall resource conservation operations?

Ask the water user what the objectives, concerns, and problems are. (Problems may be real or perceived.) Consider how individual actions within one resource impact other resources, both onsite and offsite. Identify planning objectives for each resource of concern. Encourage the user to make these objectives a part of the irrigation plan. Objectives can include:

- Protecting the soil from excessive erosion
- Maintaining or improving community water quality
- Reducing dependency upon selected farm chemicals
- Sustaining productivity of soil to grow plants
- Conserving water where supply is limited, and wise use of water where supply is not limited
- Promoting fish and wildlife habitat
- Reducing energy use
- Identify the true decisionmaker involved in day-to-day (and perhaps hourly) decisions concerning operation of the irrigation system. The decisionmaker can be the owner, operator, or the irrigator. Typically all three (even if one person fills all three roles) are involved and should be a part of the planning process.

(b) Resource inventory and analysis of data

The soil, water, air, plant, and animal resource inventory is an information collection process. It provides information needed to prepare the irrigation plan. The first phase, the resource inventory, is performed during the field visit as part of the previous step. Then data must be analyzed. Some of the more important

resource data required for planning are soils, crops, topography, water supply, existing physical features, existing irrigation systems, water table presence, existing drainage systems, environmental factors, present farm operation, skill and labor available, operators desires and concerns, and energy resources.

(1) Soils

The soil survey, where available, is a prime source for soils information. The survey gives a good indication of what can be expected in a specific field; however, it generally is not in great enough detail to provide all information needed for detailed planning and design on irrigated cropland, hayland, or pasture land. Additional field investigation is generally necessary to identify actual surface soil texture(s) and plant root zone volume.

On alluvial fans the action of flowing water has resulted in many soil inclusions and variations within fields. Observation of crops and soil color sometimes gives a clue as to soil differences. The irrigator may be able to identify some of the soil problems. With use of a hand auger, and a little experience, planners can gain enough information about soils based on their own field investigations to do an adequate job of planning.

Never assume a plant root zone depth. Excavate a 12- to 18-inch-deep pit or use a soil auger to observe (and measure) onsite root development patterns and depths.

Nearly all soils are affected by field equipment caused compaction. Compaction, especially tillage pans, can limit plant root development and water measurement. Overirrigation can also limit root development patterns. An otherwise deep soil responds as a shallow soil if root zone volumes are limited by cultural practices on that field. Onsite cultural practices often limit root development to the soil volume above a tillage pan.

Critical data, such as available water capacity and intake rates, may require taking tests on soils in specific fields. These parameters vary even within the same soil series. Judgment must be used by the planner in determining how reliable existing data are and if additional detail surveying and testing are needed. Other basic considerations include crop rooting depths, soil salinity and sodicity, soil acidity, presence of a water table, drainage problems, erosion and sedimentation problems, and soil condition.

(2) Crops

Crops most likely to be grown should be identified and peak crop evapotranspiration (ET_c) by these crops determined. Net irrigation requirement and frequency of irrigation need to be determined based on soils and crops grown and the amount of risk the owner wishes to assume. Determine what crop yields and product quality have been typical in the past. Find out from the water user what cultural practices have been used. They may include cultivation sequence, equipment used, width of equipment (cultivators, haying equipment), crop varieties, fertilizer usage and time of application, crop rotations, and planting and harvest dates. Discuss crops and cultural practices that might be used in a planned cropping system.

(3) Topography

Determine high and low points in each field and the direction of irrigation for surface irrigation and surface drainage. Simple bench level surveys may be required to obtain spot elevations. A detailed topographic or grid survey is expedient for selecting alternatives for detailed planning and design of specific irrigation systems and determining if intensive land leveling or reorganization is needed. A detailed topographic map is often necessary for planning and designing micro and low pressure sprinkler irrigation systems. Small changes in elevation can have large effects on irrigation uniformity when using low pressure irrigation systems.

(4) Water supply

Determine flow rate (when available), source location, and elevation of water supply. Water quality, including chemical content, sediment, and debris loads also need to be determined. Quality of runoff water from upstream irrigators can determine its suitability for use on certain crops. Runoff water may contain certain pesticides and their metabolites, nutrients (i.e., phosphorous) and sediment.

Tailwater recovery and reuse should be a consideration where allowed by local water regulations. It may be necessary to obtain laboratory tests for chemical content and to measure water supply flow rates.

If an irrigation company or district is involved, determine their delivery schedule. Amount of lift (depth to water table with drawdown) and costs while pumping are factors when using wells. Water costs and pumping costs can be major factors in any cost-benefit analysis.

(5) Existing physical features

Determine access to all parts of the irrigated area and location of access roads, aboveground utilities, buried utilities, and other physical features. Depth to buried utilities may control excavation location and depths. Aboveground utilities may limit the use and layout of sprinkler systems (pivot and linear move systems, side-roll wheel lines, traveling gun types). Use aerial photographs and maps as plan base maps and add sketches or overlays.

(6) Existing irrigation systems

An analysis of the existing irrigation method and system, including management, helps to determine if the present system is appropriate for the resources involved. Improving management using the existing system is always the first component of improved water application. Too often the perception exists that to improve water application a new or different irrigation system must be installed. Installing a new irrigation system to improve water application efficiency is not only costly, but often unnecessary. Water application efficiency improvements are usually limited to 5 to 10 percent increase over using proper water management with the existing system. Using proper water management with the existing system often results in increasing water application efficiency more than 30 percent.

After a thorough analysis of water management practices used, make an inventory of the existing system. Gather data on equipment brands, models, and capacities. Perform a simple irrigation system analysis or a detailed system analysis if needed. The water user may have some strong feelings about certain irrigation methods and systems. Users deserve information on the best available method and systems that meet their needs and are most suitable for the site. Pros and cons, including labor requirement and costs of a best fit system, need to be provided.

(7) Water table presence

Determine availability, depth, duration, type of buried conduit system (where it exists), water quality, and if the water table can provide either part or all the crop water needs.

(8) Existing drainage systems

Analyze existing surface and subsurface drainage facilities. Include condition of existing ditches and underground drains, sources of water, and problems created by poor drainage. Determine if poor drainage is the result of mismanagement or natural causes. Overirrigation is by far the greatest water management problem where water supplies are adequate.

(9) Environmental factors

Among many resources, wetland areas within the planning area must be identified and assessed. Possible water pollution sources need to be identified, and floodplain hazard needs to be evaluated. This inventory process and environmental effects can be facilitated by use of exhibit 10-1, environmental effects for resource management plan (Exhibit 5, Part 600.7, NRCS National Planning Procedures Handbook).

(10) Present farm operation

Find out about the overall mix of farm enterprises and how the irrigated crops fit into the total farm management system. Determine the amount and skill of labor available. As irrigation systems become more automated and computerized, higher level of operation and management skills are necessary. Observe the level of present farm management. It is unlikely a less than adequate manager will suddenly assume high management skills and desires.

(11) Operator's desires and concerns

Determine operator's objectives, desires, and concerns. Ask the water user about desires and concerns, and **listen** to the answers. Are desires based on fact, perception, or what the neighbor has?

(12) Energy resources

Determine the availability and unit costs of electrical power. This should include power company policies concerning new installations, standby charges, demand charges, and minimum charges. Diesel, natural gas, or gasoline engines for powering pumps can be more cost effective especially where most or part of the seasonal crop water requirements is met by precipitation. Estimate efficiency of the existing power equipment. Consider the need for total pumping plant evaluations. Investigate the potential for gravity flow systems.

Exhibit 10-1 Environmental effects for resource management plan ^{1/}

U.S. Department of Agriculture
Natural Resources Conservation Service

Page 1 of 2

Environmental Effects Worksheet for Resource Management Plans

NAME _____ DATE _____ PREPARED BY _____

DISTRICT _____ COUNTY _____ ENG. JOB CLASS _____

Purpose: This form summarizes effects of the practices/systems. It also provides summary documentation for environmental evaluation of the planned actions.

Instructions: Complete the evaluation of each conservation management system (CMS). Short term refers to installation period and; long-term refers to the effects during the life span of the practice or systems. Effect codes: += beneficial; - = adverse; 0= none. For Quality criteria columns, check yes or no. Effects are to be quantified where possible.

Resource considerations*	Effects		Effects notes	Meets Q criteria				Quality criteria notes
	Short	Long		Benchmark		Planned		
				No	Yes	No	Yes	
Soil								
Erosion								
Condition								
Deposition								
Water								
Quantity								
Quality								
Air								
Quality								
Condition								
Plant								
Suitability								
Condition								
Management								
Animal								
Habitat (domestic)								
Habitat (wildlife)								
Management								

* May be amplified, if appropriate, by subcategories such as sheet erosion, wind erosion, gully erosion.

See continuation on reverse page.

Exhibit 10-1 Environmental effects for resource management plan—Continued

<p>U.S. Department of Agriculture Natural Resources Conservation Service</p>	<p>Page 2 of 2</p>																																																																																			
<p>Environmental Effects Worksheet for Resource Management Plans—Continued</p>																																																																																				
<p>NAME _____ DATE _____ PREPARED BY _____</p>																																																																																				
<table border="1" style="width: 100%; border-collapse: collapse;"> <tr> <th style="width: 30%;">Human considerations</th> <th style="width: 10%;">No</th> <th style="width: 10%;">Yes</th> <th style="width: 50%;"></th> </tr> <tr> <td>Economics</td> <td></td> <td></td> <td rowspan="7" style="vertical-align: top;">Notes:</td> </tr> <tr> <td>Cost effectiveness</td> <td></td> <td></td> </tr> <tr> <td>Financial condition</td> <td></td> <td></td> </tr> <tr> <td>Markets available</td> <td></td> <td></td> </tr> <tr> <td>Client input (mgt., labor)</td> <td></td> <td></td> </tr> <tr> <td>Base acreage maintained</td> <td></td> <td></td> </tr> <tr> <td>Sustainability</td> <td></td> <td></td> </tr> <tr> <td>Social</td> <td></td> <td></td> <td rowspan="5" style="vertical-align: top;">Notes:</td> </tr> <tr> <td>Public health and safety</td> <td></td> <td></td> </tr> <tr> <td>Social values</td> <td></td> <td></td> </tr> <tr> <td>Client characteristics</td> <td></td> <td></td> </tr> <tr> <td>Client tenure considered</td> <td></td> <td></td> </tr> </table>	Human considerations	No	Yes		Economics			Notes:	Cost effectiveness			Financial condition			Markets available			Client input (mgt., labor)			Base acreage maintained			Sustainability			Social			Notes:	Public health and safety			Social values			Client characteristics			Client tenure considered																																												
Human considerations	No	Yes																																																																																		
Economics			Notes:																																																																																	
Cost effectiveness																																																																																				
Financial condition																																																																																				
Markets available																																																																																				
Client input (mgt., labor)																																																																																				
Base acreage maintained																																																																																				
Sustainability																																																																																				
Social			Notes:																																																																																	
Public health and safety																																																																																				
Social values																																																																																				
Client characteristics																																																																																				
Client tenure considered																																																																																				
<p>Cultural resources: (If response to the following questions is "No" implementation may proceed when documentation is complete.)</p>																																																																																				
<p>1. Do the planned alternatives include undertakings defined by NRCS GM 420-401? (Practices that may damage cultural resources.) If "Yes," see below.</p> <p>2. Are cultural resources present? If "Yes," document the resource(s) on the site and determine impacts following NRCS GM 420-401.</p>	<table style="width: 100%;"> <tr> <td style="width: 50%;"></td> <td style="width: 25%; text-align: center;">No</td> <td style="width: 25%; text-align: center;">Yes</td> </tr> <tr> <td></td> <td style="text-align: center;"><input type="checkbox"/></td> <td style="text-align: center;"><input type="checkbox"/></td> </tr> <tr> <td></td> <td style="text-align: center;"><input type="checkbox"/></td> <td style="text-align: center;"><input type="checkbox"/></td> </tr> </table>		No	Yes		<input type="checkbox"/>	<input type="checkbox"/>		<input type="checkbox"/>	<input type="checkbox"/>																																																																										
	No	Yes																																																																																		
	<input type="checkbox"/>	<input type="checkbox"/>																																																																																		
	<input type="checkbox"/>	<input type="checkbox"/>																																																																																		
<p>Special environmental concerns: If yes to any of the following, explain in notes section or on attachment.</p>																																																																																				
<table border="1" style="width: 100%; border-collapse: collapse;"> <thead> <tr> <th rowspan="2" style="width: 40%;">Consideration</th> <th colspan="3">Present</th> <th colspan="3">Effect</th> </tr> <tr> <th>No</th> <th>Yes</th> <th>Unknown</th> <th>No</th> <th>Yes</th> <th>Unknown</th> </tr> </thead> <tbody> <tr><td>Prime and unique farmland</td><td></td><td></td><td></td><td></td><td></td><td></td></tr> <tr><td>Threatened and/or endangered plant</td><td></td><td></td><td></td><td></td><td></td><td></td></tr> <tr><td>Threatened and/or endangered animal</td><td></td><td></td><td></td><td></td><td></td><td></td></tr> <tr><td>Visual resources</td><td></td><td></td><td></td><td></td><td></td><td></td></tr> <tr><td>Coastal zone management area</td><td></td><td></td><td></td><td></td><td></td><td></td></tr> <tr><td>Natural area</td><td></td><td></td><td></td><td></td><td></td><td></td></tr> <tr><td>Wild and scenic river</td><td></td><td></td><td></td><td></td><td></td><td></td></tr> <tr><td>Wetlands</td><td></td><td></td><td></td><td></td><td></td><td></td></tr> <tr><td>Riparian areas</td><td></td><td></td><td></td><td></td><td></td><td></td></tr> <tr><td>Special aquatic sites</td><td></td><td></td><td></td><td></td><td></td><td></td></tr> </tbody> </table>	Consideration	Present			Effect			No	Yes	Unknown	No	Yes	Unknown	Prime and unique farmland							Threatened and/or endangered plant							Threatened and/or endangered animal							Visual resources							Coastal zone management area							Natural area							Wild and scenic river							Wetlands							Riparian areas							Special aquatic sites							
Consideration		Present			Effect																																																																															
	No	Yes	Unknown	No	Yes	Unknown																																																																														
Prime and unique farmland																																																																																				
Threatened and/or endangered plant																																																																																				
Threatened and/or endangered animal																																																																																				
Visual resources																																																																																				
Coastal zone management area																																																																																				
Natural area																																																																																				
Wild and scenic river																																																																																				
Wetlands																																																																																				
Riparian areas																																																																																				
Special aquatic sites																																																																																				
<table border="1" style="width: 100%; border-collapse: collapse;"> <thead> <tr> <th style="width: 40%;"></th> <th>No</th> <th>Yes</th> <th>Met</th> </tr> </thead> <tbody> <tr><td>404 permit required</td><td></td><td></td><td></td></tr> <tr><td>State, county, local requirements</td><td></td><td></td><td></td></tr> <tr><td>Mitigation planned required</td><td></td><td></td><td></td></tr> </tbody> </table>		No	Yes	Met	404 permit required				State, county, local requirements				Mitigation planned required																																																																							
	No	Yes	Met																																																																																	
404 permit required																																																																																				
State, county, local requirements																																																																																				
Mitigation planned required																																																																																				
<p>Degree of public interest/potential controversy _____</p>																																																																																				
<p><input type="checkbox"/> This is not a Federal action that will have significant effect on the quality of the human environment.</p> <p><input type="checkbox"/> This may be a major Federal action that will have significant effect on the quality of human environment</p>																																																																																				

1/ Source: National Planning Procedures Handbook, part 600.7, exhibit 5, United States Department of Agriculture, Natural Resources Conservation Service, 1993.

(c) Formulate and evaluate alternatives

The planner needs to consider all alternative conservation management systems that meet the needs of the water user, address resource concerns, and solve resource problems. Work through the most promising alternatives just to the extent needed to determine feasibility. Refine the most feasible alternatives, and document them in enough detail that water user can select the alternative that best meets the defined needs and desires. The most promising alternatives generally require at least a cost estimate and may require an economic analysis. The alternatives must be thoroughly discussed with the water user at the time documentation is presented and discussed.

Alternatives considered should meet all requirements of an conservation management system, the FOTG, and the objectives of the water user. An conservation management system on irrigated land may include one or more of the following practices and measures:

Irrigation method:

- Surface—Level and graded systems including border, basin, furrow, rill, corrugation, contour levee, contour furrow, and contour ditch.
- Sprinkle—Periodic move, fixed (solid) set, gun type, and continuous (self) move (center pivot or linear move including LEPA and LPIC, and gun type).
- Micro—Line source, point source, basin bubbler, and minispray.
- Subirrigation—Water table control.

Irrigation water management:

- How will the need to irrigate (when and how much) be determined?
- What irrigation system adjustments can be made to increase or decrease application?

Irrigation system distribution components:

- Irrigation field ditches
- Pipelines (surface and buried)
- Structure for water control (including measuring devices)
- Irrigation water conveyance, ditch, and canal lining
- Irrigation system tailwater recovery and reuse
- Irrigation land leveling, grading, and smoothing
- Irrigation pit or regulating reservoir
- Irrigation storage reservoir
- Water table control
- Well

Drainage system:

- Controlled drainage
- Subsurface drain
- Surface drainage
- Irrigation tailwater disposal

Conservation cropping sequence:

- Crop residue use
- Conservation tillage
- Pasture and hayland management
- Field windbreaks
- Nutrient management
- Pest management
- Pumping plant for water control
- Wildlife wetland habitat management

Other:

- Access road
- Field arrangement
- Obstruction removal

Water budget or balance

A representative or specific water budget or balance taken from the FOTG or developed for the specific farm can be displayed in table or graph form. A water budget is a planning or predictive tool. Water balance is most often a daily operational tool. A water balance for any period can show:

- When and how much water is used by the crop(s).
- When and how much water is available or applied for crop use—from ground water, precipitation, irrigation, or a combination of these.
- When and how much water is available for deep percolation below the plant root zone, and to runoff.

A water budget is a useful planning tool in comparing effects of different irrigation systems and levels of management of what water goes where, on a monthly and yearly basis. Where daily crop water use data are available, the more detailed water balance can display effects of water availability, nutrient and pesticide application, and management. For design and management purposes, the field water balance can be written mathematically as:

$$F_g = ET_c + D_p + SDL + RO - P - GW - \Delta SW$$

where:

- F_g = gross water required during the period
- ET_c = crop evapotranspiration during the period
- D_p = deep percolation from the crop root zone during the period
- SDL = spray and drift losses from irrigation water in air and evaporation from plant canopies during the period
- RO = surface runoff that leaves the field during the period
- P = total precipitation during the period
- GW = ground water contribution to the crop root zone during the period
- ΔSW = change in soil water in the crop root zone during the period (this may be plus or minus)

Note: The above equation provides for all losses when computing F_g . If net application (F_n) is used instead of gross application (F_g), then losses would be estimated by using overall irrigation efficiency (IE).

(d) Decisions and implementation

After decisions are made by the water user, they need to be documented. Technical assistance required for implementation and followup can be tentatively identified. Definite decisions for irrigation method and type of system, system components, and operation and management practices are essential, but timing of implementation is sometimes not totally predictable.

652.1003 Irrigation system, operation, and water management plan

Once decisions are made regarding the irrigation method and system to be used, a detailed irrigation system installation plan along with operation and management plans can be prepared. These parts of the overall irrigation plan may include engineering drawings, specifications, resource data, quantity estimates, and other data needed by the water user to implement, operate, maintain, and properly manage the selected irrigation system. Some major detailed plan segments are:

- Conservation plan for crops, pasture, or hayland
- Irrigation system application plan
- Irrigation water management plan
- Installation
- Maintenance
- Followup and evaluation

(a) Conservation plan for crops, pasture, or hayland

This plan should provide recorded decisions for crops to be grown, crop rotation, varieties, planting depth and rates, nutrient and pesticide management, weed control, residue management, establishing crops, and cultivation and harvest procedures. It may include such practices as:

- Conservation cropping sequence
- Crop residue use
- Conservation tillage system
- Mulching
- Chiseling and subsoiling
- Cover and green manure crops
- Toxic salt reduction
- Contour farming
- Nutrient management
- Pest management

(b) Irrigation system application plan

Details relating to the installation of the irrigation system (including method of handling tailwater and drainage) are translated into drawings, specifications, quantity and cost estimates, and operation and maintenance procedure details. As in other parts of the overall irrigation plan, irrigation system improvements are often designed and installed in stages. When this is the case, enough design must be done initially on the overall system to assure that all the subsequently installed components operate satisfactorily when the complete system is installed and operating.

Construction drawings and specifications should be tailored to the user to some degree. Drawings should be neat, complete, and professional. Depending on skill and construction experience of the water user or contractor, more detail, including more drawings, may be needed on how to do the job.

Details of the drawings and specifications must be reviewed with each water user at the time the plans and specifications are provided. This will help ensure that there is full understanding of what is to be installed and how it is to be done. The water user can also be an important part of the construction inspection process where NRCS or a consultant does not provide full time inspection.

An irrigation system operations plan is a part of every irrigation system applications plan. The operating plan should detail how the system is to be operated including: charging and draining the system, opening and closing valves, winterizing motors, engines, and pumps, and making application rate changes.

(c) Irrigation water management plan

The irrigation water management plan covers the details needed to manage the irrigation system. Such details may include the following information.

- How fast the soil absorbs water (intake and application rates), including how to determine when adjustments are necessary and how to make the needed adjustments.

- The operations plan should detail how they system is to be operated including: changing and draining the system operating and closing valves; winterizing motors, engines, and pumps; and making application rate changes.
- The method for determining when (frequency) and how much water (normal depth of application per irrigation) to apply. This information is based on peak period use rate and on soil water content or plant water use (stress) levels. The peak period use rate should include enough water to meet the use rate for all months during the irrigation season. The following basic equation is applicable:

$$Q T = D A$$

where:

- Q = flow rate (ft³/s)
- T = time (hr)
- D = depth of application (in)
- A = area (acres)

A useful relationship for converting flow rate to depth of application is:

$$1 \text{ ft}^3/\text{s for 1 hr} = 1 \text{ in depth over 1 acre}$$

or

$$1 \text{ ft}^3/\text{s} = 24 \text{ ac-in/d}$$

or

$$1 \text{ ft}^3/\text{s} = 2 \text{ ac-ft/d}$$

- Know the relationship between gross irrigation depth and the net irrigation depth for each field.
- Recommend design flow rates, how to measure flows, effects of advance times, how to make adjustments, and irrigation set times for borders, levees, furrows, sprinklers, and micro system emitters, bubblers, or hose. For example, misapplying adjustment in flow and set time for eliminating or reducing runoff may inadvertently increase deep percolation. Flow measurement is a primary management tool along with being a regulation tool.
- Details of irrigation scheduling method and how to prepare a day to day schedule, accounting for effective precipitation, automation setting and adjustment, and computerized scheduling.
- How to check field for adequacy of irrigation.
- Guidelines for self-evaluation of irrigation effectiveness.
- Know cost of each irrigation and anticipated benefits.

Management aspects of irrigation should be discussed throughout the planning process. Different irrigation scheduling methods, soil-water content determination procedures, flow measurement procedures, and pros and cons of different set times should all have been thoroughly discussed and perhaps demonstrated. The final written management plan should contain details on procedures selected by the irrigation decisionmaker. All irrigation application amounts, set time, and scheduling periods are estimates. Procedures must be provided for making adjustments in frequency, quantities, and times of application. Every water user has a different learning level, operation and management desire, and skill level. The planner must develop an accurate feel for the level of irrigation water management appropriate for the individual water user. Remember a below average manager will seldom become an above average manager overnight.

(d) Installation

Installations of the irrigation system, system components, and agronomic practices need technical support. Planning and design are of no value if practices are not installed, operated, and managed properly. Sufficient time for technical assistance needs to be provided to ensure that the job is done right. Consider all sources of installation technical assistance including farm consultants, irrigation dealers, and private engineers.

Operation and management of irrigation by the water user are much easier and less time consuming if planning was thorough. This includes working closely with the water user to assure documentation is complete and has been thoroughly explained and discussed.

(e) Maintenance

Maintenance of the irrigation system and all components is essential for satisfactory long-term economical operation. Maintenance items need to be presented and discussed in the irrigation plan. This includes:

- Annual (or between crops) laser leveling or grading of surface irrigated fields
- Maintenance of pump, well, valves, and pipeline
- Replacement of worn or malfunctioning sprinkler/spray nozzles and heads, and micro emitter devices.

(f) Followup and evaluation

Planned followup is essential for an irrigation plan because soil, water, and crop conditions change. Adjustments must be made in management of the system. Data and technical design procedures rely upon best available and average values, which are never fully accurate, to make absolute predictions of how irrigation systems will function. Typically, some technical help is needed to make adjustments. All sources of followup and evaluation technical assistance should be considered. The need for adjustments during system use needs to be fully explained to the water user during the planning process.

652.1004 Planning aids

Worksheets can aid in planning and documentation; however, they should be used only if they facilitate the planning effort. Other methods of documenting the planning processes should be used if they better serve the planner and water user. Many computer assisted irrigation planning and design software programs provide a summary of irrigation system design or evaluation.

Irrigation Inventory Worksheet—A step-by-step process in recording needed resource inventory data is necessary. Exhibit 10-2 provides an example inventory of resource data. It is not all inclusive and should be supplemented with other records as needed. Only information on those items that apply and are needed should be collected and recorded. See chapter 15 of this guide for a copy of blank example worksheets.

Irrigation Planning Worksheet—Soil and crop evapotranspiration data and irrigation system capacity requirements can be recorded and computed using the worksheet shown in exhibit 10-3. See chapter 15 of this guide for a copy of blank example worksheets.

Irrigation Plan Map—Exhibit 10-4 displays an example plan of a simplified irrigation system. The plan should be only as detailed as is necessary to display pertinent features of the irrigation system. Things to show include delivery facilities, structures, pump, mainlines, laterals, ditches, ponds, and methods of irrigation.

Irrigation Water Management Plan—An example irrigation water management plan for a sprinkler irrigation system is displayed in exhibit 10-5. Exhibit 10-6, Guide for Estimating Soil Moisture for Plant Use (Feel and Appearance Method), is included as a part of the IWM plan. See chapter 15 of this guide for a copy of blank example worksheets.

Exhibit 10-2 Irrigation system inventory worksheet

U.S. Department of Agriculture
Natural Resources Conservation Service

Page 1 of 6

Irrigation System Inventory Worksheet

OWNER/OPERATOR _____ FIELD OFFICE _____

JOB DESCRIPTION _____

LOCATION _____

ASSISTED BY _____ DATE _____

(Collect and fill out only portions of this form that apply and are needed)

Area irrigated _____ acres

Crops

Crops now grown			
Typical planting date			
Typical harvest date			
Typical yield (unit)	()	()	()
Age of planting			
Cultivation and other cultural practices			

Water

Water source(s)				
irrigation organization				
Water available (ft ³ /sec, gpm, miners inches, mg/da)				
Seasonal total water available (ac-ft, million gal)				
Water availability	continuous	demand	rotation	fixed schedule
Typical water availability times (schedule and ordering procedure)				
Method of determining when and how much to irrigate:				
Is flow measuring device maintained and used?				
Method of measuring water flow rate				
Water quality:	Sediment		Debris, moss	
	Electrical conductivity	mmhos/cm	SAR	
Comments				

Exhibit 10-2 Irrigation system inventory worksheet—Continued

U.S. Department of Agriculture
Natural Resources Conservation Service

Page 2 of 6

Example Irrigation System Inventory Worksheet—Continued

NAME _____ DATE _____ PREPARED BY _____

Soils (principal soil in field)

Soil # 1

Map symbol		Soil series & surface texture		
Percentage of field (%)		Area (acres)		
Depth	Texture	AWC (in/in)	AWC (in)	Cum AWC (in)
Depth to water table or restrictive layer ¹				
Intake family/intake group/max application rate				
Comments				

Soil # 2

Map symbol		Soil series & surface texture		
Percentage of field (%)		Area (acres)		
Depth	Texture	AWC (in/in)	AWC (in)	Cum AWC (in)
Depth to water table or restrictive layer ¹				
Intake family/intake group/max application rate				
Comments				

Soil # 3

Map symbol		Soil series & surface texture		
Percentage of field (%)		Area (acres)		
Depth	Texture	AWC (in/in)	AWC (in)	Cum AWC (in)
Depth to water table or restrictive layer ¹				
Intake family/intake group/max application rate				
Comments				

¹ If restrictive for root development or water movement

Exhibit 10-2 Irrigation system inventory worksheet—Continued

<p>U.S. Department of Agriculture Natural Resources Conservation Service</p>	<p>Page 3 of 6</p>																					
<p>Irrigation System Inventory Worksheet—<i>Continued</i></p>																						
<p>NAME _____ DATE _____ PREPARED BY _____</p>																						
<p>Water supply and distribution system Supply system to field (earth ditch, lined ditch, plastic pipeline, etc.):</p>																						
<table border="1" style="width: 100%; border-collapse: collapse;"> <tr><td>Type</td></tr> <tr><td>Size</td></tr> <tr><td>Capacity (ft³/sec, gpm, miners inches, mgal/day)</td></tr> <tr><td>Pressure/Elevation at head of field or turnout (lb/in²) (ft)</td></tr> <tr><td>System condition</td></tr> <tr><td>Estimated conveyance efficiency of supply system (%)</td></tr> </table>		Type	Size	Capacity (ft ³ /sec, gpm, miners inches, mgal/day)	Pressure/Elevation at head of field or turnout (lb/in ²) (ft)	System condition	Estimated conveyance efficiency of supply system (%)															
Type																						
Size																						
Capacity (ft ³ /sec, gpm, miners inches, mgal/day)																						
Pressure/Elevation at head of field or turnout (lb/in ²) (ft)																						
System condition																						
Estimated conveyance efficiency of supply system (%)																						
<p>In-field distribution system (earth or lined ditch, buried pipe, surface portable pipe, lay flat tubing):</p>																						
<table border="1" style="width: 100%; border-collapse: collapse;"> <tr><td>Type</td></tr> <tr><td>Size</td></tr> <tr><td>Capacity</td></tr> <tr><td>Total available static head (gravity) (ft)</td></tr> <tr><td>System condition</td></tr> <tr><td>Estimated efficiency of delivery system (%)</td></tr> <tr><td>Comments</td></tr> <tr><td> </td></tr> <tr><td> </td></tr> </table>		Type	Size	Capacity	Total available static head (gravity) (ft)	System condition	Estimated efficiency of delivery system (%)	Comments														
Type																						
Size																						
Capacity																						
Total available static head (gravity) (ft)																						
System condition																						
Estimated efficiency of delivery system (%)																						
Comments																						
<p>Water application system Existing sprinkler system (attach design and/or system evaluation, if available):</p>																						
<table border="1" style="width: 100%; border-collapse: collapse;"> <tr><td>Type system (center pivot, sidewheel-roll, hand move, traveler, big gun)</td></tr> <tr><td> </td></tr> <tr><td>Manufacturer name and model</td></tr> <tr><td>Tower spacing (pivot or linear) (ft) End gun (pivot)?</td></tr> <tr><td>Wheel size (sidewheel-roll) diameter</td></tr> <tr><td>Type of drive</td></tr> <tr><td>Pressure at lateral entrance (first head) (lb/in²)</td></tr> <tr><td>Mainline diameter/length</td></tr> <tr><td>Lateral diameter/length</td></tr> <tr><td>Lateral spacing (S₁) Sprinkler head spacing (S_m)</td></tr> <tr><td>Sprinkler make/model</td></tr> <tr><td>Nozzle size(s) by type</td></tr> <tr><td>Design nozzle pressure (lb/in²) Wetted diameter (ft)</td></tr> <tr><td>(Attach sprinkler head data for pivot)</td></tr> <tr><td>Maximum elevation difference: Along lateral</td></tr> <tr><td>Between sets</td></tr> <tr><td>Application efficiency low 1/4 (E_q) (%) (Estimated or attach evaluation)</td></tr> <tr><td>Wind - Prevailing direction and velocity</td></tr> <tr><td>Comments</td></tr> <tr><td> </td></tr> <tr><td> </td></tr> </table>		Type system (center pivot, sidewheel-roll, hand move, traveler, big gun)		Manufacturer name and model	Tower spacing (pivot or linear) (ft) End gun (pivot)?	Wheel size (sidewheel-roll) diameter	Type of drive	Pressure at lateral entrance (first head) (lb/in ²)	Mainline diameter/length	Lateral diameter/length	Lateral spacing (S ₁) Sprinkler head spacing (S _m)	Sprinkler make/model	Nozzle size(s) by type	Design nozzle pressure (lb/in ²) Wetted diameter (ft)	(Attach sprinkler head data for pivot)	Maximum elevation difference: Along lateral	Between sets	Application efficiency low 1/4 (E _q) (%) (Estimated or attach evaluation)	Wind - Prevailing direction and velocity	Comments		
Type system (center pivot, sidewheel-roll, hand move, traveler, big gun)																						
Manufacturer name and model																						
Tower spacing (pivot or linear) (ft) End gun (pivot)?																						
Wheel size (sidewheel-roll) diameter																						
Type of drive																						
Pressure at lateral entrance (first head) (lb/in ²)																						
Mainline diameter/length																						
Lateral diameter/length																						
Lateral spacing (S ₁) Sprinkler head spacing (S _m)																						
Sprinkler make/model																						
Nozzle size(s) by type																						
Design nozzle pressure (lb/in ²) Wetted diameter (ft)																						
(Attach sprinkler head data for pivot)																						
Maximum elevation difference: Along lateral																						
Between sets																						
Application efficiency low 1/4 (E _q) (%) (Estimated or attach evaluation)																						
Wind - Prevailing direction and velocity																						
Comments																						

Exhibit 10-2 Irrigation system inventory worksheet—Continued

U.S. Department of Agriculture
Natural Resources Conservation Service

Page 4 of 6

Irrigation System Inventory Worksheet—Continued

NAME _____ DATE _____ PREPARED BY _____

Existing surface system (attach system evaluation if available)

Type of system (graded border, level border, graded furrow, level furrow, contour levee, contour ditch, wild flooding)			
Leveled fields:	Field slope:	In direction of irrigation	ft/ft
	Cross slope		ft/ft
Smoothness:	<input type="checkbox"/> Rough	<input type="checkbox"/> Smooth	<input type="checkbox"/> Very smooth
	Laser equipment used		<input type="checkbox"/> yes <input type="checkbox"/> no
Border or levee width	ft	Furrow/corrugation/rill spacing	in
Length of run:	Minimum	ft	Maximum
		ft	Average
			ft
Number of furrows or borders per set			
Border or levee dike heights			
Application efficiency, low 1/4 (E _q)		% (Estimated or attach evaluation)	
General maintenance of system			

Drainage, tail water reuse facility

Method for collection and disposal of field runoff (tailwater, precipitation)
Final destination of runoff water
Surface/subsurface drainage system
Environmental impacts of existing drainage system

Existing micro irrigation system (Attach design or system evaluation if available)

Type of system:	<input type="checkbox"/> Drip emitters	<input type="checkbox"/> Mini spray/sprinklers	<input type="checkbox"/> Line source
Spacing between discharge devices along distribution laterals	(ft, in)		
Laterals - diameter, length			
Main lines and submains - diameter, length, etc.			
Spacing between distribution laterals	(ft, in)		
Average application device discharge pressure (lbs/in ²)			
Are pressure compensating devices required?	<input type="checkbox"/> yes	<input type="checkbox"/> no	
Are pressure compensating devices used?	<input type="checkbox"/> yes	<input type="checkbox"/> no	
Average application device discharge (gph, gpm)			
Area irrigated by one irrigation set (acres)			
Typical irrigation set time (hr, min)			
Maximum elevation difference with one irrigation set (ft)			
Type and number of filters used			
Irrigation is initiated by:	<input type="checkbox"/> manual control	<input type="checkbox"/> programmed timer	<input type="checkbox"/> clock timer <input type="checkbox"/> soil moisture sensing device
Comments:			

Exhibit 10-2 Irrigation system inventory worksheet—Continued

U.S. Department of Agriculture
Natural Resources Conservation Service

Page 5 of 6

Irrigation System Inventory Worksheet—Continued

NAME _____ DATE _____ PREPARED BY _____

Existing subsurface irrigation system

Water table control type and number of system or segments	
Water table control devices	<input type="checkbox"/> flashboard <input type="checkbox"/> float
Buried laterals	<input type="checkbox"/> diameter <input type="checkbox"/> spacing <input type="checkbox"/> depths
Water table elevation(s): Existing	Planned

Month	Elevation	Depth below surface

Pumping plant

Pump

(Attach pump characteristic curves and/or pump system analysis if available)			
Pump elevation above mean sea level (approx) (ft)			
Pump type: <input type="checkbox"/> centrifugal <input type="checkbox"/> turbine <input type="checkbox"/> submersible <input type="checkbox"/> Propeller <input type="checkbox"/> axial flow			
Make		Model	
Electric motor RPM		Engine operating RPM	
Pump design discharge		gpm @	ft or lb/in ²
Impeller size	Impeller diameter	Number of impellers	
Pressure at outlet of pump or inlet to pipeline		lb/in ²	date
Discharge	gpm	How measured	date
Valves, fittings			

Power unit

Rated HP	at RPM
----------	--------

Gear or belt drive mechanism

Type (direct, gear, belt)	
RPM at driver	RPM at pump
Energy (A pump evaluation is required to get this data)	
Energy input (from evaluation) (KW) (gal/hr) (mcf)	
Pumping plant efficiency (from evaluation) (%)	
Energy cost per acre foot (from evaluation)	
General condition of equipment, problems	

Exhibit 10-2 Irrigation system inventory worksheet—Continued

U.S. Department of Agriculture
Natural Resources Conservation Service

Page 6 of 6

Irrigation System Inventory Worksheet—Continued

NAME _____ DATE _____ PREPARED BY _____

Irrigation management

Irrigation scheduling method(s)
Typical number of irrigations per season
Typical time between irrigations
Set times or time per revolution
Method of determining soil moisture
Typical water application per (set, revolution, pass)
Source, availability and skill of irrigation labor

Comments about management of the existing system and reasons for improvement. What are the objectives of the irrigation decisionmaker?

What management level is planned?

Other observations and comments

Exhibit 10-3 Irrigation planning worksheet

U.S. Department of Agriculture
Natural Resources Conservation Service

Page 1 of 2

Irrigation Planning Worksheet

OWNER/OPERATOR _____ FIELD OFFICE _____

JOB DESCRIPTION _____

LOCATION _____

ASSISTED BY _____ DATE _____

Soil—Data for limiting soil

Soil series	Percent of area (%)	Cumulative AWC					Depth to restrictive layer ¹	Intake fam., grp. max. rate
		1 ft (in)	2 ft (in)	3 ft (in)	4 ft (in)	5 ft (in)		

¹Actual observed depth in the field

Maximum time between irrigations for any method/system based on peak crop ET

Crop	Management root zone (ft)	Total AWC (in)	MAD percent (in)	Maximum net replacement		Peak daily crop ET (in/d)	Maximum irrigation frequency (days)
				(in/d)	(days)		

Minimum system flow requirement for irrigation system

System description	Depth of irrigation application			Peak daily crop ET (in/d)	Max. irrig. frequency (days)	Minimum system flow requirement total flow	
	Net (F _n) (in)	Efficiency (%)	Gross (F _g) (in)			(gpm)	(ft ³ /s)

Minimum dependable flow available to system _____ gpm, ft³/s, inches, etc.

Total irrigated area _____ acres. Total operating hours per day _____.

Exhibit 10-4 Irrigation plan map

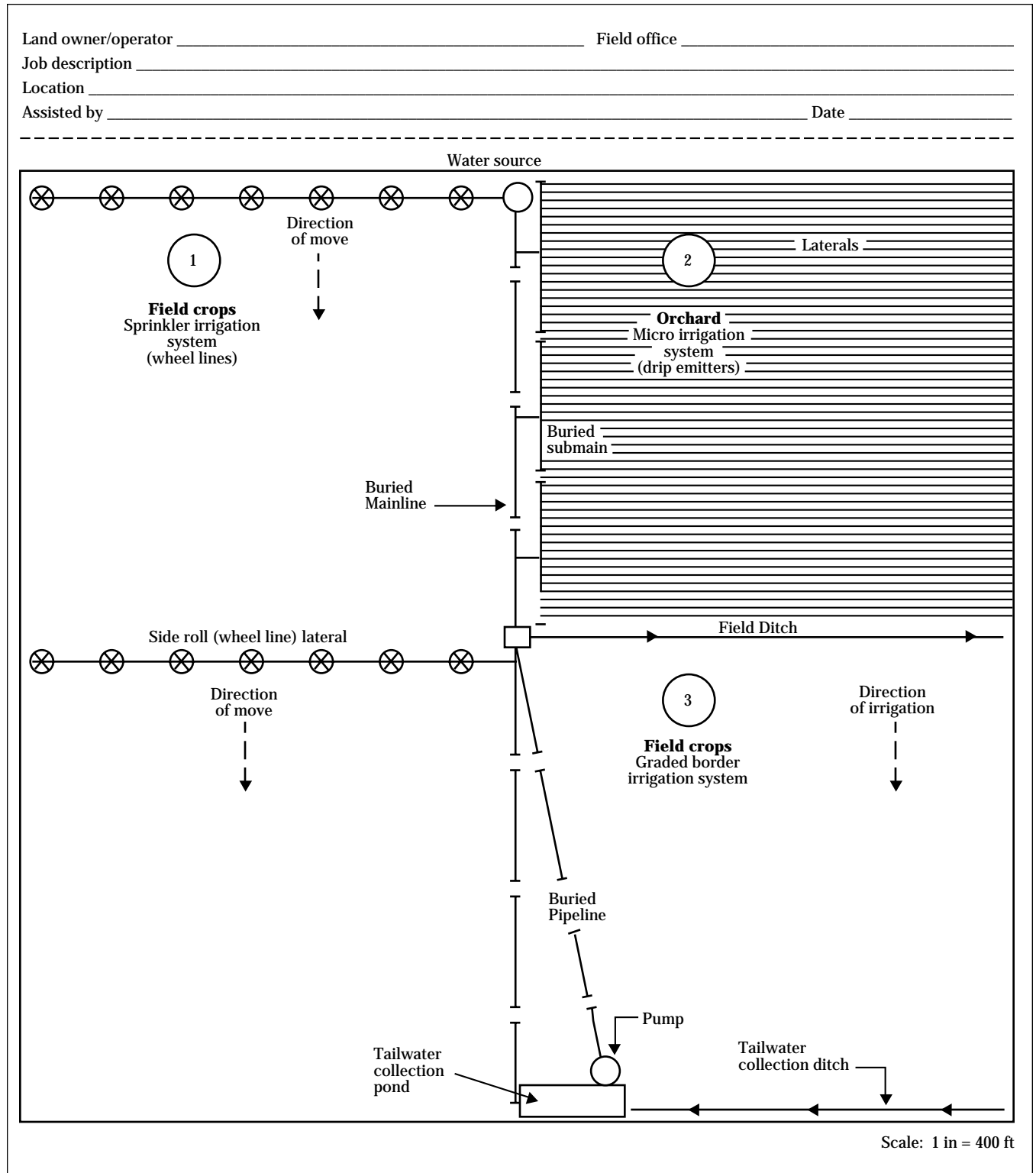

Exhibit 10-5 Irrigation water management plan for sprinkler irrigation systemU.S. Department of Agriculture
Natural Resources Conservation Service

Page 1 of 3

Irrigation Water Management Plan—Sprinkler Irrigation System

NAME J.P. Farmer DATE 12/14/94 PREPARED BY Joe Technician
 DISTRICT Lower Power COUNTY Eagle Point ENGR JOB CLASS _____

Resource inventory**Crop information**

Field number(s)					#1
Crop irrigated					Pasture Grass
Acres Irrigated (acres)					30 ac
Normal rooting depth (feet, inches)					30 in
Management allowable depletion (MAD) (percent, inches)					50%
Peak daily crop requirements (ac-in/day)					0.22 ac-in/da
Average annual net irrigation requirements (ac-in/ year)					22 ac-in/yr

Soil Information

Soils series and surface texture	Jackson Silt Loam- 33A (0-1% slope)		
Capability class	II (irrigated)		
Allowable soil loss (T=tons per-acre per year)	T = 5		
Wind Erodibility Group (WEG)	WEG=4		
Actual on-site (observed and measured) average root zone depth	48 in		
Total available water capacity (AWC) of soil plant root zone	9.6 in		
Soil intake (Maximum application rate for sprinkler system)	0.35 in/hr		
Available water capacity (AWC) for crop rooting depth:	Depth (inches)	AWC	
		(inch/inch)	(total inches)
	0-24	0.20	4.8

Irrigation system management information

Irrigation system	Periodic move side roll wheel line sprinkler
Source of water	well
Delivery schedule	continuous
Estimated overall irrigation efficiency	60%
Management allowable depletion for pasture	50%
Irrigation set time to apply full irrigation and replace full MAD	11.5 hours
Gross application	4.0 inches
Net application	2.4 inches
Actual gross sprinkler application rate	0.35 in/hr
Irrigation system flow capacity requirement for full time irrigation, Q (gpm)	216 gpm

Exhibit 10-5 Irrigation water management plan for sprinkler irrigation system—ContinuedU.S. Department of Agriculture
Natural Resources Conservation Service

Page 2 of 3

Irrigation Water Management Plan— Sprinkler Irrigation System—*Continued*NAME J.P. Farmer DATE 12/14/94 PREPARED BY Joe Technician**Irrigation scheduling Information**

Month	Monthly net ¹ irrigation requirement (inches)	Crop evapo- transpiration use rate (in/day)	Irrigation frequency needed (days)	Average ² number of Irrigations needed
April	1.0	0.03	30	0
May	2.8	0.09	26	1
June	4.0	0.13	18	2
July	6.5	0.21	11	3
August	5.0	0.16	15	2
September	2.1	0.07	30	1
October	0.5	0.03	30	0
Total	21.9			9

¹ Net irrigation requirement (NIR) represents crop evapotranspiration less effective rainfall.² Assuming a full soil profile at start of season. Check soil moisture before irrigating. Account for rainfall that can replace soil moisture depletion. If soil moisture depletion is less than 50% wait for a few days and check it again.

Warmer than "average" months will typically require additional irrigation water; cooler than "average" months will typically require less irrigation water; months with more than "average" effective rainfall will typically require less irrigation water.

Only operate the system when needed to furnish water for crop needs. The preceding irrigation schedule can be used as a guide to determine when to irrigate. It is a guide only for average month and year conditions. Optimizing use of rainfall to reduce unnecessary irrigations during the growing season is a good management practice. In semi-humid and humid areas, it is recommended to not replace 100 percent of the soil moisture depletion each irrigation. Leave room in the plant root zone for containing water infiltration from rainfall events. This will vary with location, frequency, and amount of rainfall occurring during the growing season. It should be approximately 0.5 to 1.0 inches.

Maintaining to a higher soil moisture level (MAD) typically does not require more irrigation water for the season, just more frequent smaller irrigations. This is especially true with crops such as root vegetables, potatoes, onions, garlic, mint, and sweet corn.

The attached chart for evaluating soil moisture by the feel and appearance method can be used to help determine when to irrigate. Other common methods to monitor crop water use and soil moisture include: plant signs (crop critical moisture stress periods), atmometer, evaporation pan (applying appropriate factors), tensiometers, electrical resistance blocks (moisture blocks), and crop water stress index (CWSI gm).

NRCS (SCS) - SCHEDULER computer software is available to provide calculations of daily crop evapotranspiration when used with local daily weather station values. On-site rainfall data is necessary to determine effective rainfall, whereas local weather station rainfall data is not sufficiently accurate due to spatial variability. Current rainfall and soil moisture data can be input manually or electronically to assist in predicting when irrigation is needed.

Exhibit 10-5 Irrigation water management plan for sprinkler irrigation system—Continued

U.S. Department of Agriculture
Natural Resources Conservation Service

Page 3 of 3

Irrigation Water Management Plan—Sprinkler Irrigation System—Continued

NAME J.P. Farmer DATE 12/14/94 PREPARED BY Joe Technician

A properly operated, maintained, and managed sprinkle irrigation system is an asset to your farm. Your system was designed and installed to apply irrigation water to meet the needs of the crop without causing erosion, runoff, and losses to deep percolation. The estimated life span of your system is 15 years. The life of the system can be assured and usually increased by developing and carrying out a good operation and maintenance program.

Pollution hazards to ground and surface water can be minimized when good irrigation water management practices are followed. Losses of irrigation water to deep percolation and runoff should be minimized. Deep percolation and runoff from irrigation can carry nutrients and pesticides into ground and surface water. Avoiding spills from agricultural chemicals, fuels, and lubricants, will also minimize potential pollution hazards to ground and surface water.

Leaching for salinity control may be required if electrical conductivity of the irrigation water or soil water exceeds plant tolerance for your yield and quality objectives. If this condition exists on your field(s), a salinity management plan should be developed.

The following are system design information and recommendations to help you develop an operation and maintenance plan (see irrigation system map for layout):

- average operating pressure = 38 lb/in² (use a pressure gage to check operating pressure)
- nozzle size = 13/64 inch (use shank end of high speed drill bit to check nozzle wear)
- average sprinkler head discharge 7.2 gpm
- sprinkler head rotation speed should be 1 - 2 revolutions per minute
- sprinkler head spacing on lateral = 40 ft; outlet valve spacing on main line 50 ft
- lateral, number(s) 2, 1,280 ft, 4 inch diameter side roll wheel line
- main line = 2,600 ft 6 inch diameter, type PVC, class 160 lb/in²
- pump = 30 hp electric, 475 gpm @ 175 ft Total Dynamic Head (TDH)

Make sure that all measuring devices, valves, sprinkler heads, surface pipeline, and other mechanical parts of the system are checked periodically and worn or damaged parts are replaced as needed. Always replace a worn or improperly functioning nozzle with design size and type. Sprinkler heads operate efficiently and provide uniform application when they are plumb, in good operating condition, and operate at planned pressure. Maintain all pumps, piping, valves, electrical and mechanical equipment in accordance with manufacturer recommendations. Check and clean screens and filters as necessary to prevent unnecessary hydraulic friction loss and to maintain water flow necessary for efficient pump operation.

Protect pumping plant and all associated electrical and mechanical controls from damage by livestock, rodents, insects, heat, water, lightning, sudden power failure, and sudden water source loss. Provide and maintain good surface drainage to prevent water pounding around pump and electrical equipment. Assure all electrical/gas fittings are secure and safe. Always replace worn or excessively weathered electric cables and wires and gas tubing and fittings when first noticed. Check periodically for undesirable stray currents and leaks. Display appropriate bilingual operating instructions and warning signs as necessary. During non-seasonal use, drain pipelines and valves, secure and protect all movable equipment (i.e. wheel lines).

If you need help developing your operation and maintenance plan, contact your local USDA Natural Resources Conservation Service office for assistance.

Exhibit 10-6 Guide for estimating soil moisture conditions using feel and appearance method

Available soil moisture (%)	Texture			
	Coarse fine sand loamy fine sand	Mod coarse sandy loam fine sandy loam	Medium sandy clay loam loam, silt loam	Fine clay loam silty clay loam
	Available water capacity (in/ft)			
	0.6 – 1.2	1.3 – 1.7	1.5 – 2.1	1.6 – 2.4
0 – 25	Dry, loose, will hold together if not disturbed; loose sand grains on fingers.	Dry, forms a very weak ball ^{1/} , aggregated soil grains break away easily from ball.	Dry, soil aggregations break away easily, no moisture straining on fingers, clods crumble with applied pressure.	Dry, soil aggregations easily separate, clods are hard to crumble with applied pressure.
25 – 50	Slightly moist, forms a very weak ball with well defined finger marks, light coating of loose and aggregated sand grains remain on fingers.	Slightly moist, forms a weak ball with defined finger marks, darkened color, no water staining on fingers.	Slightly moist, forms a weak ball with rough surfaces, no water staining on fingers few aggregated soil grains break away.	Slightly moist, forms a weak ball, very few soil aggregations break away, no water stains clods flatten with applied pressure.
50 – 75	Moist, forms a weak ball with loose and aggregated sand grains remain on fingers, darkened color, heavy water staining on fingers, will not ribbon ^{2/} .	Moist, forms a ball with defined finger marks, very light soil-water staining on fingers, darkened color, will not slick.	Moist, forms a ball, very light water staining on fingers, darkened color, pliable, forms a weak ribbon between thumb and forefinger.	Moist, forms a smooth ball with defined finger marks, light soil water staining on fingers, ribbons between thumb and forefinger.
75 – 100	Wet, forms a weak ball, loose and aggregated sand grains remain on fingers, darkened color, heavy water staining on fingers, will not ribbon.	Wet, forms a ball with wet outline left on hand, light to medium water staining on fingers, makes a weak ribbon between thumb and forefinger.	Wet, forms a ball with well defined finger marks, light to heavy soil water coating on fingers, ribbons between thumb and forefinger.	Wet, forms a ball, uneven medium to heavy soil water coating on fingers ribbons easily between thumb and forefinger.
Field capacity (100)	Wet, forms a weak ball, light to heavy soil-water coating on fingers, wet outline of soft ball remains on hand	Wet, forms a soft ball, free water appears briefly on soil surface after squeezing or shaking medium to heavy soil water coating on fingers.	Wet, forms a soft ball, free water appears briefly on soil surface after squeezing or shaking, medium to heavy soil water coating on fingers.	Wet, forms a soft ball free water appears on soil surface after squeezing or shaking thick soil water coating on fingers, slick and sticky.

1/ Ball is formed by squeezing a hand full of soil very firmly with one hand.

2/ Ribbon is formed when the soil is squeezed out of the hand between thumb and forefinger.

652.1005 State supplement

WA652.1005 State Supplement

Irrigation Water Management Plan

Irrigation water management (IWM) plans are needed to give the operator the basics - application, operation, and maintenance of their system. There are example plans contained in this chapter with blank copies of the IWM form in Chapter 15.

The following spread sheets are examples of center pivot and solid set IWM plans that have been developed locally. The soils, crop, and system information can be loaded into the spread sheet with a summary of the system, crop water use, and other operation information produced. Included in this printout is information on scheduling irrigations based on soil moisture monitoring.

Soil Moisture Monitoring

There are several methods available to monitor soil moisture. The purpose of monitoring is to determine when to irrigate the soil based on how the crop has used water. Although the water use rate by the crop varies daily depending on a host of variables that can be calculated, the monitoring of the soil is a fairly common and accurate method.

Numerous methods and devices are available, as listed in the example plans. Local sources or internet searches will provide you with many options. An example of the graphical printout from a soil moisture monitoring field is also included after the IWM plans.

Example Irrigation Water Management Plan

- Center Pivot System
- Solid Set System

Chapter 11

Economic Evaluations

Contents:	652.1100	Forward	11-1
	652.1101	General	11-1
	652.1102	Economics of installing a new irrigation system	11-2
		(a) Benefit analysis	11-2
		(b) Cost analysis	11-4
		(c) Benefit-to-cost analysis	11-11
	652.1103	Economics of operating an existing system	11-12
		(a) Benefit analysis	11-12
		(b) Operating costs	11-13
		(c) Benefit-to-cost analysis	11-14
	652.1104	Maximizing net returns	11-15
		(a) Marginal cost and marginal return	11-15
		(b) Water-yield relationships	11-15
		(c) Production function	11-17
	652.1105	Pipeline installation and pumping costs evaluation	11-20
	652.1106	State supplement	11-24

Tables	Table 11-1	Present value factors for single payment	11-7
	Table 11-2	Cost factors (amortization)	11-7
	Table 11-3	Developing water use-yield relationship	11-16
	Table 11-4	Marginal cost - marginal return relationships	11-18
	Table 11-5	Typical energy consumption	11-24
	Table 11-6	Equivalent energy annual cost escalation factors	11-24

Figures	Figure 11-1	Product yield vs. water applied—irrigated corn	11-17
	<hr/>		
Exhibits	Exhibit 11-1	Gross benefits worksheet	11-3
	Exhibit 11-2	Ownership (or fixed) costs	11-5
	Exhibit 11-3	Increased ownership cost worksheet	11-9
	Exhibit 11-4	Increased operating costs worksheet	11-10
	Exhibit 11-5	Feasibility worksheet	11-11
	Exhibit 11-6	Gross benefits worksheet	11-12
	Exhibit 11-7	Increased operating costs worksheet	11-13
	Exhibit 11-8	Benefit-to-cost analysis	11-14
	Exhibit 11-9	Format for developing a partial budget	11-19
	<hr/>		
Examples	Example 11-1	Pipeline installation and pumping costs evaluation	11-21
	Example 11-2	Calculating annual energy savings	11-23

652.1100 Forward

The material in chapter 11 is intended to be self help instructional material and reinforce formal training activities on the economics of irrigation. It is intended primarily to illustrate for field office personnel the use of economic principles and evaluation procedures. These principles and procedures should be helpful when working with land users analyzing the economics of irrigation. Additional help is available from technical specialists. For an expanded discussion of economic evaluations, see *The Handbook of Economics for Conservation*, Natural Resources Conservation Service (NRCS), April 1992, and *Farm Management Course Notebook*, NRCS and American Society of Farm Managers and Appraisers, 1994.

652.1101 General

Decisions are made daily whether to purchase an item or which item to purchase. Economics is the process of deciding where and how we spend our money ranging from pennies to thousands of dollars. Therefore, what factors do we analyze in deciding how to spend our money? Normally we compare the benefits of the purchase or investment to its cost. Someone considering the purchase of a new car might see better gas mileage and fewer repairs as benefits. Costs might include higher car payments and higher insurance premiums. Someone wanting a new computer might be comparing benefits that a new computer would give them in business and at home to the cost of giving up other activities or items currently enjoyed.

Farmers, when deciding whether to purchase an irrigation system, go through much the same thought process. They may ask, "Should I continue my dryland farming operation or should I irrigate? If I decide to irrigate, how much water should be applied to get the greatest profit? Will the greatest profit be realized at the point of maximum yield? Will the increase in yield more than pay the increase in costs?"

These questions can be asked when contemplating whether to replace an existing irrigation system. What are the proposed changes? What are the costs? What are the benefits? Is there a better alternative? For example:

- Improved water management with the existing irrigation system, or
- Improved precipitation storage in the soil resulting from improved soil condition, better crop residue use, changed (usually reduced) number and type of tillage operations, performing farming operations on the contour, or
- A combination of 1 and 2.

The need for change should be based on using the existing irrigation system along with proper water, soil, and plant management. Too often a poorly managed surface irrigation system is compared to a properly managed sprinkler or micro irrigation system. Assumed level of management can be guided by observing the irrigation decisionmakers current irrigation water management and other farm management

practices. If the water user is an average surface irrigation system manager, chances are he/she will be an average sprinkler or micro irrigation system manager. Automated systems typically require higher levels of management.

Existing irrigation systems should be checked for both management and system operational efficiencies. The basis for change should include an economic evaluation of annual costs and benefits. Included are annual operating cost, labor availability and cost, annual cost of installing the existing irrigation system, and annual net income using the existing irrigation system.

The decision to purchase an irrigation system is often based on an inadequate economic analysis. Data are usually available or can be easily obtained to answer questions in paragraph two of this section. The management ability and performance of the operator are probably the most important factors in determining the feasibility of irrigation or making a change in an existing irrigation system. Good water management is essential to realize the full benefit of irrigation. Under poor management a farmer will be paying the full cost of irrigation, but realizing only part of the benefit.

A perception among many irrigators is that to do a better job irrigating, a different irrigation method or system must be used; i.e., convert from surface irrigation method to the sprinkle method. Often, however, greater benefits can be derived with improved water management (includes irrigation scheduling and system maintenance using the existing irrigation system). All irrigation methods (surface, sprinkle, micro, and subsurface) can distribute an amount of water uniformly across a field. However, site conditions for some irrigation systems can be quite limiting and labor requirements high. **The first increment of change should always be to optimize the use of precipitation and irrigation water applied using the existing irrigation system (if one exists).**

Each NRCS employee should be aware of the economics of irrigating in the general area and be familiar with the procedure used in analyzing data to determine feasibility.

This chapter provides tools necessary to evaluate the feasibility of installing an irrigation system. These tools, or principles, can also be used to evaluate other types of conservation investments.

652.1102 Economics of installing a new irrigation system

An Economic Analysis consists of a Benefit Analysis, Cost Analysis, and a Benefit-to-Cost Analysis. A Marginal Cost - Marginal Return Analysis can be made to show the relationship per increment of change. For example, per bushel of yield return or per inch of water applied. Each of these components will be described in this chapter.

(a) Benefit analysis

Before installing an irrigation system, a *benefit analysis* should be completed to determine management requirements and profitability of such an investment. An irrigation system should be recommended only if it:

- Improves the net income of the operator.
- Reduces or favorably changes the amount, timing, or type of labor required.
- Has positive benefits on soil, water, air, plant and animal resources.

Since there are four irrigation methods and many different irrigation systems to apply water by these methods, the decision becomes extremely critical in selecting an irrigation method and system that will maximize profits while protecting the environment. To help make this determination, the water user or consultant should **employ economic tools as a part of the planning process to provide best management and system alternatives for a given water user's situation.**

The beneficial evaluation of an irrigation system is usually based on the premise that production, crop quality, or both, will increase as a result of making irrigation management and system changes. This assumption is made with the knowledge that physical, chemical, and biological properties of the soil, or seasonal variation of temperature and the timing and availability of irrigation water are not a hindrance to increased production or quality potential.

Gross benefits from an irrigation system are fairly easy to identify as compared to benefits from a grassed waterway or terrace system. Sufficient data have been obtained, either by research or actual field conditions, to develop a reliable relationship between available water and yield. In reality, benefits, in addition to increased yields, will probably be included in the evaluation. These benefits can involve higher unit prices for improved quality, reduced cost of operation per unit of product produced, and with improved water management reduced water use per unit of product produced. Average yields rather than maximum yields are recommended for cost benefit analysis. Maximum yields do not reflect negative impacts from weeds, insects, wildlife, or cool growing seasons that can occur.

The site selected for the following example has an average annual effective rainfall of 19.3 inches, of which 10 inches is considered available (effective) for plant use most years. Average dryland corn yield on the example farm is 40 bushels per acre. Well managed neighboring farms, also on deep silt loam soils, apply

16 inches of irrigation water to get an average of 170 bushel per acre yield. Supporting data in section I of the FOTG support these numbers. In the example one alternative will be evaluated, while in reality, several alternatives would most likely be evaluated. Alternative systems could consist of different irrigation methods, different irrigation systems, automated versus manual system operation, costs, and benefits.

The example alternative to be evaluated is a proposed 130-acre center pivot sprinkler irrigation system to supplement natural precipitation (dryland farming). At 75 percent irrigation application efficiency, about 12.5 inches of the 16.7 inches applied plus 10 inches of growing season precipitation is available for plant use. Crop budgets show that the increase in gross return will be \$347.10 per acre, rounded to \$347. This is calculated from the 130 bushel yield increase at a price of \$2.67 per bushel.

In summary, it can be said that the average annual benefits, excluding the cost and operation of the irrigation system and the increased variable production costs of corn, is \$347 per acre per year. Exhibit 11-1 may be helpful in determining gross benefits.

Exhibit 11-1 Gross benefits worksheet (using example 130-acre site)

U.S. Department of Agriculture Natural Resources Conservation Service		
Gross Benefits Worksheet		
Crop	<u>Corn</u>	Date ^{1/} _____
		Year of price base ^{2/} _____
Existing irrigation system	<u>none</u>	Planned irrigation system <u>center pivot sprinkler</u>
Gross value per acre of expected increase from irrigation:		
<u>130 bu/ac</u> yield increase x	<u>\$2.67</u> per unit (i.e. bu, etc.) =	<u>\$347.10</u> (rounded to <u>\$347</u>)
<p><small>1/ Date—For future reference, it is helpful to show the date the estimates were made. 2/ Year of price base—The price base is normally the current year prices.</small></p>		

(b) Cost analysis

The next step in an economic analysis is a *cost analysis*. The average annual cost per acre to own and operate the irrigation system and the increased annual production costs must be determined so that the benefits and costs can be compared.

One of the most difficult tasks in performing a cost analysis is to include all costs. Costs associated with any enterprise can be diverse and thereby easily overlooked. For this reason farm decisionmakers should try to follow guidelines such as those in this chapter. Farm decisionmakers and economists categorize costs as fixed and variable to assist in both long-term and short-term financial decisions. These two categories together constitute total costs.

Costs are generally classified as being either ownership costs (fixed costs) or operating costs (variable costs). Ownership costs are those costs incurred even if no production takes place. These costs are also independent of changes in yield. Examples of ownership costs are depreciation, insurance, taxes, interest,

housing, and some maintenance. These costs must be paid each year the equipment is owned, even if the equipment sits idle. Actual loan amortization is an annual ownership cost consideration, typically shorter than the life of purchased equipment.

Operating costs, commonly called variable costs, are those costs that occur as production takes place. Typical operating costs are seed, fuel, fertilizer, power for irrigation systems, and labor. If production does not take place, operating cost items are not needed.

The decision to purchase, rent, or lease irrigation equipment is extremely important. Fixed cost, variable costs, and total cost should all receive some attention. Once the purchase has been made, however, the decision to use it in any given year is linked closely to variable costs.

(1) Ownership (fixed) costs

The estimated cost of the proposed 130 acre center pivot irrigation system is shown in exhibit 11-2.

Exhibit 11-2 Ownership (or fixed) costs (using example 130-acre site)

Ownership Costs	
Center pivot sprinkler system installed with concrete pad at pivot, system completely set up	\$ 41,000
Well, 400 feet of steel well casing, installed with gravel pack, located at pivot	14,000
Installed pump (head, bowls and column) with yield of 1,000 gal/min at 80 lb/in ²	13,000
Electric motor (125 hp range) installed	5,500
Install 0.25-mile underground electric wire, control panel at pump	<u>14,000</u>
Subtotal	<i>\$ 87,500 for 130 ac = \$673/ac</i>
Contingencies at 10 percent	8,750
Subtotal	96,250
Sales Tax at 4 percent ^{1/}	<u>3,850</u>
Total estimated cost of irrigation system	<i>\$ 100,100</i>
(Rounded for capital investment analysis)	<i>\$100,000 for 130 ac = \$769/ac</i>

1/ This is a conservative number. Items that require payment of sales tax vary by state.

The \$100,000 installation cost must now be converted to an average annual cost. This conversion is necessary so that both the benefits and costs are expressed in comparable terms, that is, average annual dollars. Exhibit 11-3 can help determine the average annual ownership costs per acre.

Note: The following information is helpful in using the worksheet:

Date—For future reference, it is helpful to show the date the estimates were made.

Year of price base—The price base will normally be the current year prices.

Equipment or irrigation system—Identify the equipment or irrigation system represented in the analysis. In this case a center pivot sprinkler irrigation system.

Life span—The number of years the equipment or irrigation system is expected to be used in an operation or business. It may be the age at which time the item is completely worn out, or the period may be shorter if the equipment is expected to be sold or replaced while retaining some of its original value. Life span for individual components varies. See table 5-2, Chapter 5, Selecting an Irrigation Method.

Maintenance costs usually increase with age and use of the equipment. The cost of maintenance may also be used to determine the useful life of equipment.

When annual maintenance cost exceeds the annual cost of purchasing new equipment, then the economic life has been exceeded. The farm manager may still use it if a major investment cannot possibly be afforded at this time, or the manager has become personally attached to a specific piece of equipment; i.e., an old tractor that still functions satisfactorily.

If the purchase was made with borrowed funds, the owner for cash flow purposes may also want to make an analysis using the years of loan repayment as the year life, even though the equipment may physically last longer. In this example all irrigation equipment has been assigned a 15-year life. (A more detailed economic evaluation would assign different life expectancies to each major system component. A separate analysis would be completed for each component.)

Acres annual use—The number of acres the equipment will be used annually. In this example, the center pivot will be used on 130 acres; 30 acres in field corners will remain dryland.

Interest rate—Use either (a) actual loan rate if funds are borrowed, or (b) a representative, competitive market rate or opportunity cost if producer provides funds (not borrowed).

New cost—The purchase price plus installation cost. For this example the initial cost is \$100,000.

Salvage value—This is usually the salvage value or remaining value at the time of replacement. This value may be zero if it is completely worn out and has no scrap value or will never be sold. Equipment that is expected to be replaced after a given period of time and with some remaining operational use should be assigned a trade-in value. The system in this example is expected to have a remaining value of \$5,000, 15 years hence.

The annual value or cost of the salvage value will be the present value times an interest rate represented by the opportunity cost or the cost of borrowed money. If one's own money is used to purchase the equipment, use the opportunity cost. This would be the interest rate one could get by investing the money in alternative investments having similar risk and time frames. If funds are borrowed, use the interest rate being charged for the use of those funds. In this example, 12 percent has been selected. The \$5,000 salvage value is discounted to present value (see table 11-1 for present value factors) and then amortized over the 15-year period. The \$5,000 represents the value of the equipment 15 years hence, or at the end of 15 years.

$$\begin{aligned} & \$5000 \times \text{Present value of 1, 15 years hence} \\ & @ 12\% (0.18270) = \$914 \end{aligned}$$

Amortization—Amortization involves prorating the initial cost, less salvage value of equipment over its useful life, in this case \$99,086 over a 15-year period. See table 11-2 for amortization factors. The value of equipment decreases each year through wear, deterioration, or obsolescence, and that value should correspond to the amount of amortization taken each year. The net investment is converted to an average annual cost by amortization. Amortization, also called capital recovery, is the extinguishing of a financial obligation in equal installments over time.

Amortization, as used in this example, will convert the net capital (investment) cost into an annual cost, which also includes the interest or opportunity cost. Using an interest rate of 12 percent and a life of 15 years, find the appropriate amortization factor (0.14682) from table 11-2 or an average annual cost table. The present value of a salvage value 15 years

hence (in this example, $\$5,000 \times 0.18270 = \914) is subtracted from the investment cost (in this example, $\$100,000 - \$914 = \$99,086$). The factor 0.14682 times $\$99,086 = \$14,548$. The $\$14,548$ is the average annual cost of ownership associated with the amortization of the irrigation equipment over the life span of the equipment.

Table 11-1 Present value factors for single payment

Borrowing interest (%)	Cost factors at various expected years of loan							
	6 yr	8 yr	10 yr	12 yr	15 yr	18 yr	20 yr	25 yr
7.0	.66634	.58201	.50835	.44401	.36245	.29586	.25842	.18425
8.0	.63017	.54027	.46319	.39711	.31524	.25025	.21455	.14602
9.0	.59627	.50187	.42241	.35553	.27454	.21199	.17843	.11597
10.0	.56447	.46651	.38554	.31863	.23939	.17986	.14864	.09230
11.0	.53464	.43393	.35218	.28584	.20900	.15282	.12403	.07361
12.0	.50663	.40388	.32197	.25668	.18270	.13004	.10367	.05882
13.0	.48032	.37616	.29459	.23071	.15989	.11081	.08678	.04710
14.0	.45559	.35056	.26974	.20756	.14010	.09456	.07276	.03779
15.0	.43233	.32690	.24718	.18691	.12289	.08081	.06110	.02038

Table 11-2 Cost factors (amortization)

Borrowing interest (%)	Cost factors at various expected years of loan							
	6 yr	8 yr	10 yr	12 yr	15 yr	18 yr	20 yr	25 yr
7.0	.20980	.16747	.14238	.12590	.10978	.09941	.09439	.08581
8.0	.21632	.17401	.14903	.13270	.11683	.10670	.10185	.09368
9.0	.22292	.18067	.15582	.13965	.12406	.11421	.10955	.10181
10.0	.22961	.18744	.16275	.14676	.13147	.12193	.11746	.11017
11.0	.23638	.19432	.16980	.15403	.13907	.12984	.12558	.11874
12.0	.24323	.20130	.17698	.16144	.14682	.13794	.13388	.12750
13.0	.25015	.20839	.18429	.16899	.15474	.14620	.14235	.13643
14.0	.25716	.21557	.19171	.17667	.16281	.15462	.15099	.14550
15.0	.26424	.22285	.19925	.18448	.17102	.16319	.15976	.15470

Interest costs—When capital is borrowed to make the initial purchase, interest cost is a fixed cost. However, unlike amortization, interest or opportunity cost varies with the size of the initial obligation without consideration of salvage value. Purchasing irrigation equipment ties up capital (money); therefore, it has an opportunity cost. This opportunity cost is the interest cost. If a farmer purchases a sprinkler irrigation system for a farm and finances through the owner or bank on a contract, he/she agrees to repay the principal amount in a certain number of years. In addition to the repayment of the principal, the borrower must also pay an interest charge each year. Borrowed capital is often repaid in a time period less than the life span of equipment and materials purchased. Farm decision-makers can choose to use this shorter time period to amortize the initial investment, recognizing salvage value at the end of the amortized period could be substantial. However, money is still tied up in the irrigation equipment, and opportunity cost (interest) still applies.

Taxes—Some states levee a property tax on equipment or farm machinery. In this example taxes were assumed to be \$2,000 per year.

Insurance—This is an annual charge to cover the loss of equipment from fire, theft, windstorm, or any liability coverage. It is estimated to be \$2,000 per year in this example.

Standby (fixed) charges for electricity—Providing electrical power availability is generally passed on as a fixed cost. Standby charges are paid even if the irrigation system is not used. In this example the standby charge was \$24.84 per acre or \$3,230 per year. These charges set by the electric utility company are payable every year. In some areas standby charges are called demand charges.

Ownership cost per year—This is the sum of the annual ownership costs of the irrigation system. In this example it is \$21,278.

Ownership cost per acre—This is the total annual ownership cost prorated over the number of acres the system is benefiting. In this example the system is benefiting 130 acres, so the annual ownership cost is \$21,278 divided by 130 acres, or \$168 per acre.

Most of the ownership costs have now been accounted for and determined to be \$168 per acre per year. Total annual costs consist of ownership (fixed) costs and operating (variable) costs. With the total annual costs known, it can be compared to the total annual benefits. Notice the break even cost is now \$168 per acre greater than before the irrigation system was installed. This difference can only be recovered by increased outputs (plant yield or biomass) or reduced inputs (labor, tillage).

Exhibit 11-3 Increased ownership cost worksheet (see text for explanation of terms)U.S. Department of Agriculture
Natural Resources Conservation Service**Increased Ownership Cost Worksheet**Crop Corn Date ^{1/} _____ Year of price base ^{2/} _____Equipment or irrigation system Center pivot sprinkler irrigation systemLife span 15 years, Acres annual use 130 ac, Interest rate 12%**Ownership Costs**

New cost		\$ 100,000	
Salvage value		5,000	
Present value	\$5,000 at 12% for 15 years		
	$\$5,000 \times (.18270)$	914	
Net investment	$\$100,000 - 914$	99,086	
Amortization	\$ 99,086 @ 12% for 15 years		
	$\$ 99,086 \times (.14682)$		\$ 14,548
Taxes			2,000
Insurance			2,000
Standby (fixed) charges for electricity			3,230
Ownership cost per year			<u>\$ 21,778</u>

$\frac{\$21,778}{130} = \167.52

Increased ownership (fixed) cost per acre
= \$168 per acre

1/ Date—For future reference, it is helpful to show the date the estimates were made.

2/ Year of price base—The price base is normally the current year prices.

(2) Operating (variable) costs

In the example, operating costs of the center pivot sprinkler irrigation system and the increased corn production costs are estimated in exhibit 11-4. The format in this exhibit can help develop these costs.

Exhibit 11-4 Increased operating costs worksheet

U.S. Department of Agriculture
Natural Resources Conservation Service

Increased Operating Cost Worksheet

Crop Corn Date ^{1/} _____ Year of price base ^{2/} _____

Irrigation system equipment Center Pivot Sprinkle Irrigation System

Increased yield per acre (bu, ton, bale, etc.) 130 bu

Increased operating costs	Increased cost per acre	Increased cost per bushel
Electric power for <u>16</u> acre inches of water applied per acre at <u>\$4.50</u> per acre-inch ^{3/}	\$ 72	\$ 0.55
Repair and maintenance of irrigation system: <u>\$1,560</u> a year divided by <u>130</u> acres benefiting ^{3/}	12	0.09
Increased costs of fuel, oil, seed, fertilizer, harvest, interest, chemicals, labor, water required to obtain the <u>130</u> bushel increase in yield ^{3/}	66	0.51
Total increased operating costs per acre ^{4/}	\$ 150	\$ 1.15

^{1/} Date—For future reference, it is helpful to show the date the estimates were made.

^{2/} Year of price base—The price base is normally the current year prices.

^{3/} Field Office Technical Guide, Section I.

^{4/} This figure is used in table 11-2, section 652.1104.

(c) Benefit-to-cost analysis

Basic data for a benefit-to-cost analysis has now been completed. Benefits and increased ownership and operating costs are on an average annual per acre basis and can be analyzed to determine system feasibility. Exhibit 11-5 can help put these items in perspective.

Observation: From the example benefit-to-cost analysis, we can conclude that the irrigation system is a good investment. The system will pay its own way and produce an additional \$29 annual income per acre. The break-even point can also be calculated. We know that the average annual increase in costs associated with the irrigation system is \$318 (\$168 + \$150) per acre. At a price of \$2.67 per bushel, it would take a 119 bushel (\$318 divided by \$2.67) per acre increase in yield, or a total yield of 159 bushels to break even. Break-even price for 170 bushel yield would be:

$$\frac{\$318}{(170-40) \text{ bu}} = \$2.45 \text{ per bu}$$

Exhibit 11-5 Feasibility worksheet

U.S. Department of Agriculture
Natural Resources Conservation Service

Feasibility Worksheet

Crop Corn Date ^{1/} Year of price base ^{2/}

Irrigation system equipment Center Pivot Sprinkle Irrigation System

Increased yield per acre (bu, ton, bale, etc.) 130 bu

	Costs	Benefits
Gross value per acre of expected increase (from exhibit 11-1)		\$ 347
Average annual ownership cost per acre of irrigation system (from exhibit 11-3)	\$ 168	
Average annual operating cost increase per acre (from exhibit 11-4)	<u> 150 </u>	
Total average annual cost increase per acre	\$ 318	<u> 318 </u>
Expected average annual increase in net income per acre		\$ 29

1/ Date—For future reference, it is helpful to show the date the estimates were made.
2/ Year of price base—The price base is normally the current year prices.

The procedure used in this analysis illustrates steps that can be used to evaluate similar investments. Regardless of the system being evaluated, general procedures and principles remain the same:

1. Using crop budgets, identify and calculate annual gross benefits resulting from the change.
2. Identify and calculate increased costs on an annual basis.
3. Compare annual benefits to annual costs for feasibility.

Decisions made from these calculations are extremely important, and the magnitude of ownership (fixed) and operating (variable) costs in relation to the benefits is the deciding factor. They can also affect the decision to purchase, rent, or lease equipment.

Partial budgeting can be used when calculating and comparing several alternatives. With partial budgeting, only costs that change with each alternative are considered. Crop budgets prepared by university farm commodity and other specialists should always be considered.

652.1103 Economics of operating an existing system

Once an irrigation system has been purchased, the decision to use it in any given year is linked closely to the variable costs. This section shows why this is true and illustrates a procedure that can be used in the analysis.

(a) Benefit analysis

The process to determine the benefits of continuing to use an existing irrigation system is the same as that used for the analysis of a new system. The same format may also be used (exhibit 11-6).

Summary: In this example, it can be said that if irrigation takes place and anticipated benefits do occur, estimated gross benefits will be \$347 per acre. Costs incurred to obtain these gross benefits need to be determined.

Exhibit 11-6 Gross benefits worksheet

U.S. Department of Agriculture
Natural Resources Conservation Service

Gross Benefits Worksheet

Crop Corn Date ^{1/} _____ Year of price base ^{2/} _____

Gross value per acre of expected increase from irrigating the crop:

130 bu/ac yield increase x \$ 2.67 per unit (bu, lb, ton, bale, etc.) = \$ 347.10

rounded to \$347 per acre.

^{1/} Date—For future reference, it is helpful to show the date the estimates were made.

^{2/} Year of price base—The price base is normally the current year prices.

(b) Operating costs

Since the system is already installed and the ownership costs (\$164 per acre per year) are obligated, the decision to irrigate or not depends on the anticipated increase in income being greater than the cost of operating the system (pumping costs, repairs) plus increased costs of production (seed, fertilizer, chemicals, labor). Exhibit 11-7 may be helpful in calculating these costs.

Exhibit 11-7 Increased operating costs worksheet

U.S. Department of Agriculture
Natural Resources Conservation Service

Increased Operating (Variable) Cost Worksheet

Crop Corn Date ^{1/} _____ Year of price base ^{2/} _____

Irrigation system equipment Center Pivot Sprinkle Irrigation System

Operating costs of item:	Increased cost per acre
Electric power, <u>16</u> acre inches of water applied at <u>\$4.50</u> per acre inch	\$ 72
Repair and maintenance of irrigation system: <u>\$1,560</u> a year divided <u>130</u> acres benefiting	12
Increased costs of fuel, oil, seed, fertilizer, harvest chemicals, labor, water, etc. required to obtain the <u>130</u> bu/ac (bu, ton, bale, etc.) increase in yield	66
Increased operating (variable) costs per acre	\$ 150

^{1/} Date—For future reference, it is helpful to show the date the estimates were made.

^{2/} Year of price base—The price base is normally the current year prices.

(c) Benefit-to-cost analysis

Irrigation should take place if additional income from the increased yield resulting from irrigating is greater than increased production costs plus the cost of operating the system. This is especially true in the short term even if additional income does not completely cover ownership costs (principle, taxes, insurance, interest). These costs will occur even when the system is setting idle. In the long term, other considerations may need to be made. Example 11-8 illustrates why one would irrigate as long as operating costs are covered. In reality, operating cost per acre will usually increase with increased yield to additional water, fertilizer weed control, and harvest costs.

Summary: Exhibit 11-8 shows that if the additional income will not cover the additional operating cost, it is economically feasible to leave the system idle. Once operating costs are covered, it is probably best to run the irrigation system and partly or completely recover ownership costs. Profits will be realized when additional income exceeds the sum of ownership and operating costs. Being aware of a close profit margin can stimulate farm decisionmakers to look at other areas where costs can be reduced; i.e., reduced tillage, proper irrigation scheduling, soil management practices to capture a greater portion of rainfall during the growing season. In this example, operating costs were kept constant. In reality, the cost of producing additional yield can increase, such as using additional seed and applying more fertilizer and water. Improved water management can also increase.

Exhibit 11-8 Benefit-to-cost analysis

Increased ownership cost \$/ac	Increased operating cost \$/ac	Additional yield/income		Net gain or loss \$/ac	Notes
		bu/ac	\$/ac		
168	None	0	0	-168	System is idle, lose only the ownership costs.
168	150	25	7	-251	Ownership and operating costs not covered, better off left as dryland.
168	150	50	133	-185	Covered operating costs and some ownership costs. Probable better left as dryland.
168	150	75	200	-118	Covered operating costs and some ownership cost. Lose \$118/ac.
168	150	100	267	-51	Covered operating costs and most ownership costs. Lose only \$51/ac.
168	150	119	318	0	Break even, ownership, and operating costs covered.
168	150	125	334	+16	Gain \$16/ac.
168	150	150	400	+82	Gain \$82/ac.

652.1104 Maximizing net returns

If profits are to be maximized, existing irrigation systems must be checked for operational efficiency and proper management. The management ability and desire of the operator are probably the most important factors in determining the feasibility of irrigation. Good water management is essential to realize the full benefit of irrigation. Under poor management a farmer will be paying the full cost of irrigation, but realizing only a portion of the benefits. Too often yields are reduced with poor water management (improper amount, timing, or both). A good manager seeks out answers to questions, such as *How much water should be applied to realize the greatest profit? Will the greatest profit be realized at the point of maximum yield? Will the increase in yield pay more than the expense of irrigation?* The following procedure can help answer these questions.

(a) Marginal cost and marginal return

The previous analysis in this chapter has been concerned with the feasibility of investment in an irrigation system. The question analyzed was: *Should I switch from a dry cropland system to an irrigation cropland system of crop production?*

Once the question has been analyzed and answered and the irrigation system installed, the optimal amount of irrigation water to apply needs to be considered. The optimal amount of water to apply is where the marginal cost is equal to the marginal return for applying an additional 1.0 acre-inch per acre of water.

It is easiest to think in terms of increments. Each 1.0 acre-inch per acre of water applied will produce an associated increment of costs and an associated increment of dollar return. In the relevant range of production, the incremental cost will increase while the incremental return will decrease. Production should occur where the two increments are equal.

Ownership costs of existing systems are unimportant. The per increment cost (marginal cost) and what that increment produces (marginal return) are important. Increments can be per acre-inch of water applied, per pound of fertilizer applied, or per pesticide application.

The marginal cost in this example is the additional cost of irrigation incurred when an additional acre-inch of water is applied. Marginal return is the additional net return resulting from the added acre-inch of water. Profits are maximized when the marginal cost is equal to the marginal return. In the example, the variable input, water, should be added in increments until the cost of adding the last increment (in this case an acre-inch of water) is equal to the net return resulting from the addition of the increment.

(b) Water-yield relationships

Required in any marginal cost to marginal return economic analysis, and to continue the example analysis, is the physical output resulting from the various increments (acre-inches of irrigation water) applied. Table 11-3 shows a water-yield relationship.

Table 11-3 Developing water use-yield relationship

--- Total water --- applied ^{1/} (in)	deficit ^{2/} (in)	Reduction in ET ^{3/} (%)	Reduction in yield ^{4/} (%)	----- Corn ----- loss ^{5/} (bu)	yield ^{6/} (bu)	-- Water applied -- net ^{7/} (in)	gross ^{8/} (in)	Marginal yield ^{9/} (bu/ac-in)
10	16	61.5	76.9	130.8	40.0	0	0	
11	15	57.7	72.1	122.6	47.4	1	1.3	7.4
12	14	53.8	67.3	114.4	55.6	2	2.6	8.2
13	13	50.0	62.5	106.2	63.8	3	4.0	8.2
14	12	46.2	57.8	98.1	71.9	4	5.3	8.1
15	11	42.3	52.9	89.9	80.1	5	6.6	8.2
16	10	38.5	48.1	81.7	88.3	6	8.0	8.2
17	9	34.6	43.3	73.6	96.4	7	9.3	8.1
18	8	30.8	38.5	65.4	104.6	8	10.6	8.2
19	7	26.9	33.7	57.2	112.8	9	12.0	8.2
20	6	23.7	28.8	49.0	121.0	10	13.3	8.2
21	5	19.2	24.0	40.9	129.1	11	14.6	8.1
22	4	15.4	19.2	32.7	137.3	12	16.0	8.2
23	3	11.5	14.4	24.5	145.5	13	17.3	8.2
24	2	7.7	9.6	16.3	153.7	14	18.6	8.2
25	1	3.8	4.8	8.2	161.8	15	20.0	8.1
26	0	0	0	0	170.0	16	21.3	8.2
27	0	2	2.5 ^{10/}	4.3	165.7	17	22.7	-4.3
28	0	4	5.0	8.5	161.5	18	24.0	-8.5
29	0	6	7.5	12.7	157.2	19	25.3	-12.8
30	0	8	10.0	17.0	153.0	20	26.7	-17.0

1/ Normal rainfall at this site is 19.3 inches. Approximately 10 inches is considered available for plant use most years. 1-inch increments are added to this base.

2/ The annual potential evapotranspiration (ET) value for this crop, at this location, is 26 inches net. This column lists the average annual shortage.

3/ ET deficit divided by 26 inches net ET requirement x 100 = percentage reduction in ET. Reduction in yield because of overapplication of water based on limited research and field observation. Actual yield reduction depends on climate, soils, residual soil moisture, and cropping history.

4/ Percent reduction x 1.25. From Food and Agricultural Organization Irrigation and Drainage Paper No. 33—Yield Response to Water or Analysis of Land Treatment Practices for Water Conservation, published in the proceedings of the National Workshop on Planning and Management of Water Conservation Systems in the Great Plains States, October 21-25, 1985, Midwest National Technical Center, Natural Resources Conservation Service, Lincoln, NE.

5/ Percent reduction in yield x 170 (170 is assumed to be the average potential yield in this area).

6/ Maximum yield - loss in bushels. Use actual yield (i.e., 40 bu) if available and adjust subsequent values. In this example, assumed yield increase versus water applied function is approximately 8 bu/ac for each 1 ac-in water applied, with a maximum yield of 170 bu/ac.

7/ Net acre inches of irrigation water supplied at 75 percent irrigation application efficiency.

8/ Gross acre-inches of irrigation water applied.

9/ Marginal occurs at approximately half the rate as does a corresponding moisture deficit. For this reason, growers often schedule irrigations on the wet side of optimum. There is about half the risk of adversely affecting yields.

10/ On the average, a reduction in yield occurs as additional water is applied.

(c) Production function

Once the yield data (output) are developed for each increment of the variable input (water), a total production curve can be developed. Product yield versus water applied for the example farm is plotted as figure 11-1. From this production curve we can also develop the relationship between the marginal cost and marginal return to determine at what level of water application the profits will be maximized (table 11-4).

The first example demonstrated the gross decision process for whether to irrigate. Also important is an incremental decision regarding what is the economic effect per increment of input. In this case once irrigation is chosen, a decision must be made on how much water is applied. The information in table 11-4 is based on:

Corn @ \$2.67 per bushel - \$150 per acre ÷ 130 bushel per acre (variable or increased cost per total increased yield) = \$1.15. (From exhibit 11-4, \$150 per acre is the increased variable cost to produce 130 bushels per acre of corn.) Net income for the 130 bu/ac increase = \$2.67 - \$1.15. Marginal cost - marginal return analysis is an analysis of affects created by adding increments of input—in this example, 1 acre-inch per acre of water. It is a separate process, and not a part of other cost to benefit analysis.

From table 11-4, we see that each time 1 net inch of water is applied, the cost is increased \$6.00. We also see that each inch of water, from 1 through 16, increases the net return by \$12 to \$13. This example as presented uses the same increased costs as additional water is applied. In reality, costs increase as yield increases because of additional seed, fertilizer, harvesting, trucking, and storage. Often when water is purchased from an irrigation organization, water costs increase as additional water is applied above a basic rate. **To know what each increment of water applied is costing and buying is necessary.**

Summary: Under the conditions set forth in this example profits will be maximized at the application rate of 16 inches net, or 20 inches gross, irrigation water applied. Even if the water and its application were free, it would not be rational to apply more than 16 inches. One can also see that if there is a change in the cost of water and its application or in the price of corn, or both,

this relationship shifts and thus a change occurs at the point where profits are maximized.

One of the dangers of an analysis of this type is that assumptions need to be made concerning costs and returns of the enterprise. Anytime a change occurs in the costs or prices, the cost-price relationship changes and a new point of profit maximization is established. The procedure, however, should be useful regardless of the relationships and assumptions that exist.

Note: Marginal cost - marginal return analysis does not apply when growing crops where quality of the product is more important than yield. Providing adequate irrigation water at critical growth periods is paramount for desirable product quality, such as for fresh vegetables, potatoes, melons, berries, fruits, and sweet corn. Reduced or even increased water application without knowing what the result is can mean potential total crop failure; i.e., unable to produce and sell an acceptable quality product. Other local needs, such as frost protection, temperature control, chemigation, and seed germination, may require additional water over that necessary for desirable crop production. For annual crops, such as truck crops, a marginal cost - marginal return analysis can be done, but by using planted acreage as the variable where the product yield is held constant. With most truck crops, adequate soil moisture for the full growing season must be available to obtain desirable yield and product quality. Good water management is where applied water can serve two purposes—crop cooling and crop water needs. However, this may not always be the case. For example, frost protection typically occurs when winter carryover soil moisture is high and crop evapotranspiration has not started yet.

Figure 11-1 Product yield vs. water applied—irrigated corn

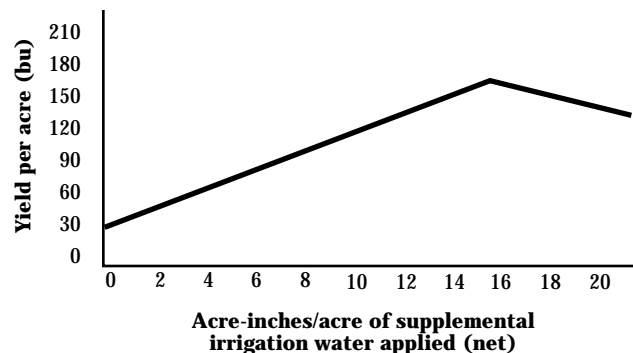

Table 11-4 Marginal cost - marginal return relationships

--- Water applied ^{1/} --- gross (ac-in)	net (ac-in)	Total yield ^{2/} (bu/ac)	Change in yield ^{3/} (bu/ac)	Incremental change ^{4/} (ac-in)	Water cost ^{5/}	Returns above variable costs ^{6/}
0	0	40.0 ^{7/}				
1.3	1	47.4	7.4	1	\$ 6.00	\$ 11.25
2.6	2	55.6	8.2	1	6.00	12.46
4.0	3	63.8	8.2	1	6.00	12.46
5.3	4	71.8	8.1	1	6.00	12.31
6.6	5	80.1	8.2	1	6.00	12.46
8.0	6	88.3	8.2	1	6.00	12.46
9.3	7	96.4	8.1	1	6.00	12.31
10.6	8	104.6	8.2	1	6.00	12.46
12.0	9	112.8	8.2	1	6.00	12.46
13.3	10	121.0	8.2	1	6.00	12.46
14.6	11	129.1	8.1	1	6.00	12.31
16.0	12	137.3	8.2	1	6.00	12.46
17.3	13	145.5	8.2	1	6.00	12.46
18.6	14	153.7	8.2	1	6.00	12.46
20.0	15	161.8	8.1	1	6.00	12.31
21.3	16	170.0	8.2	1	6.00	12.46 ^{8/}
22.7	17	165.7	-4.3	1	6.00	-11.48
24.0	18	161.5	-8.5	1	6.00	-22.70
25.3	19	157.2	-12.8	1	6.00	-34.18
26.7	20	153.0	-17.0	1	6.00	-45.39

1/ Gross and net inches of irrigation water applied at 75% application efficiency (from table 11-3).

2/ Corn yield at various amounts of irrigation water applied, assuming an increase of 1 acre-inch water application represents about an 8-bushel increase in yield (from table 11-3).

3/ Change in yield divided by net inches of water applied; i.e.:

$$46.7 - 40.0 = \frac{6.7}{1} = 6.7$$

$$55.2 - 40.0 = \frac{15.2}{2} = 7.6$$

4/ Incremental change in net irrigation water applied.

5/ Cost of applying one additional acre-inch (net) of water by irrigation with an application efficiency of 75%; i.e., 1.33 ac-in x \$4.50/ac-in = \$5.99, use \$6.00.

6/ The additional net return resulting from applying that last acre-inch (net) of irrigation water. Increased variable costs = \$2.67/bu - \$1.15/bu = \$1.52/bu of net income because of increase, or 7.4 bu x \$1.52/bu = \$11.25.

The \$6.00 per acre-inch cost of water is included in the \$66.00 increased operating cost used in exhibit 11-7.

7/ Actual yield.

8/ Decrease in returns is the result of less than adequate irrigation scheduling on an average year.

A format for an example partial budget is displayed in exhibit 11-9. In this example a quick economic analysis is made to determine the feasibility of owning a combine rather than using custom services. As the example shows, owning the combine is more costly. Factors other than up front costs enter into the decision of owning a combine (or any piece of equipment) rather than fitting into the schedule of a custom service, such as the timeliness of when harvesting could be done.

Exhibit 11-9 Format for developing a partial budget

Proposed Change: Purchasing combine to replace custom harvesting	
Additional cost (\$)	Additional income (\$)
Fixed costs:	None
Depreciation	\$ 5,000
Interest	1,600
Taxes	50
Insurance	50
Variable costs:	
Repairs	800
Fuel, oil	600
Additional labor	500
Reduced income (\$)	Reduced costs (\$)
None	Custom combining charge \$ 8,000
(A) Total annual additional costs and reduced income	(B) Total annual additional income and reduced costs
\$ 8,600	\$ 8,000
	→ - \$ 8,600
	Net change in profit (B minus A) - \$ 600

652.1105 Pipeline installation and pumping costs evaluation

The purchase and installation of an irrigation pipeline can be a big investment for a land user. It is an investment, the cost of which can be spread over several years covering the life of the loan or the life of the pipeline and appurtenances. Yet, too often pipeline materials are purchased and installed based only on first cost without adequate economic considerations. A good engineering design attempts to optimize materials and power costs for the expected life of the project or loan term.

The method of analysis described here includes average annual pipeline installation cost plus annual energy costs to determine the lowest annual cost for a given flow and total pumping pressure head condition. An example is the best way to demonstrate the process (example 11-1). Electric energy is used to demonstrate this process in this example. The process is the same for any type energy fuel used since the basis for pumping costs comparison is dollars.

Example 11-1 Pipeline installation and pumping costs evaluation

The landowner wants to install a new electric powered pump and buried mainline to provide water to a center pivot covering 150 acres. Keeping the installation cost as low as possible is desired, but it is not known if this will be the most economical way over the life of the pipeline.

Given:

- Pipeline length is 2,000 feet from pump to center of pivot
- Flow is 1,000 gpm (2.23 ft³/s)
- Operating head not including delivery pipeline friction loss = 43 lb/in² (100 ft)
- Pump operates 1,000 hours per year
- Expected life of pump and pipeline is 20 years
- Electric power rates are \$.04 per kwh with an estimated 7% annual rate increase

Solution:

1. Pipeline hydraulics: Use PVC irrigation pipe (IPS, class 125), 1,000 gpm

Pipeline hydraulics analysis

Pipe diam. (in)	Friction ^{1/} loss for 100 ft (ft)	Total loss loss for 2,000 ft (ft)	Operating head required (ft)	Total dynamic head (ft)	Velocity ^{2/} (ft/s)
6	4.8	96.0	100	196.0	11.3
8	1.3	26.0	100	126.0	6.4
10	0.45	9.0	100	109.0	4.1
12	0.2	4.0	100	104.0	2.8

1/ Calculated using Hazen-Williams equation with C = 150.

2/ Nominal diameter used for velocity calculation.

2. Find fixed cost: Pipeline installation

Fixed costs - pipeline materials and installation

Pipe diam. (in)	Install ^{1/} cost (\$/ft)	Install total cost (\$)	Average annual cost ^{2/} (\$/yr)
6	3.35	6,700.00	733.98
8	5.60	11,200.00	1,226.96
10	8.75	17,500.00	1,917.12
12	12.25	24,500.00	2,683.97

1/ Includes pipe and installation, 1994 costs.

2/ Amortized over 20 years at 9% interest, (multiplying factor = 0.10955). To determine annual cost, multiply installed total cost by amortization factor.

Example 11-1 Pipeline installation and pumping costs evaluation—Continued**3. Find variable costs:** Energy required for pumping**Variable costs - energy**

Pipe diam. (in)	Total head req. (ft)	--- Energy required ---		Annual energy requirement (kwh) ^{3/}	Annual energy cost (\$/yr) ^{4/}	Average annual energy cost (\$/yr) ^{5/}
		(bhp) ^{1/}	(kwh) ^{2/}			
6	196	70.7	94.8	94,800	\$3,792	\$5,360
8	126	45.5	61.0	61,000	2,440	3,449
10	109	39.3	52.7	52,700	2,108	2,979
12	104	37.5	50.3	50,300	2,112	2,935

1/ Calculated from equation, $bhp = \frac{gpm \times head}{3,960 \times Eff}$ (with overall pumping plant efficiency = 70%).

2/ Calculated from equation, 0.746 bhp = 1 kw.

3/ Energy required multiplied by 1,000 hr/yr.

4/ Annual energy requirement multiplied by energy cost @ \$ 0.04 per kwh.

5/ Annual energy cost multiplied by factor 1.41341 (represents an estimated 5% yearly energy cost escalation at 10.5 interest rate for 20-year evaluation period).

4. Most economical pipe size: Using annual cost method**Most economical pipe comparison**

Pipe diam. (in)	Total fixed annual cost (\$/yr)	Average annual energy cost (\$/yr)	Total annual cost (\$/yr)
6	\$ 734	\$ 5,360	\$ 6,094
8	1,227	3,449	4,676
10	1,917	2,979	4,896
12	2,684	2,985	5,669

← most economical size

Conclusion: The 8-inch diameter pipe is the most economical size for the given conditions of pipe installation cost and pumping cost. However, annual cost for 10-inch diameter is not much higher. If energy costs escalate higher than estimated, 10-inch diameter would have been the best choice. Because of the cost variability in PVC pipe, it may be worthwhile to evaluate other class pipe; i.e., class 100 or 85 (with necessary pressure control devices). Where competitive priced energy fuels are available, it may also be worthwhile to compare pumping plants using different energy sources. Typically, the most economical pipe size has velocities in the range of 4 to 6 feet per second. Other costs, such as sales tax for purchasing pipe materials and annual maintenance for pipeline, can be included at option of the consultant. This analysis can be used to compare benefits of converting from a high pressure system to a low pressure system. The only item that needs changing is the column, *Operating head requirement*, in the pipeline hydraulics analysis tabular information in solution 1 of the example.

A simple economic analysis for calculating annual energy savings with a pressure reduction can also be used. When everything remains constant except changing the operating pressure, the following equation can be used. This equation does not account for escalating energy costs, but the factor from table 11-6 can be used as a multiplier to estimate the average annual energy costs for a desired period of evaluation time.

Energy savings:

$$\text{kWh} = \frac{(A) \times (\text{ac-inch/ac/yr}) \times (\text{lb/in}^2) \times (0.2)}{E}$$

Where:

- kWh = seasonal energy savings, in kilowatt hours per year
- A = area of the field, in acres
- ac-in/ac = water applied per season, in ac-in/ac/yr
- lb/in² = pressure reduction at sprinkler, in lb/in²
- 0.2 = units conversion
- E = overall pumping plant efficiency, as a decimal

Example 11-2 Calculating annual energy savings

Given:

- An irrigation system for 40 acres.
- Operation pressure presently is 55 lb/in². After conversion operating pressure will be 35 lb/in².
- Seasonal gross irrigation application is 18 inches.
- Pumping plant overall estimated efficiency is 70%.
- Electric energy cost is \$.04 per kWh.

Solution:

$$\begin{aligned} \text{kWh} &= \frac{(A) \times (\text{ac-inch/ac/yr}) \times (\text{lb/in}^2) \times (0.2)}{E} \\ &= \frac{40 \times 18 \times 20 \times 0.2}{.70} \\ &= 4,114 \text{ kWh per year} \end{aligned}$$

Dollars saved at \$0.04 per kWh:

$$4,114 \text{ kWh} \times \$.04 / \text{kWh} = \$165 \text{ per year}$$

Table 11-5 Typical energy consumption

Energy source	----- Consumption per unit of fuel -----	
	Whp-hrs	Bhp-hrs ^{1/}
Electric	0.9 per kWh	1.18 per kWh
Gasoline	8.7 per gallon	11.3 per gallon
Diesel	11.0 per gallon	14.8 per gallon
Propane	6.9 per gallon	8.9 per gallon
Natural gas	6.7 per 100 ft ³	8.5 per 100 ft ³

^{1/} Calculated based on a reasonable operating efficiency.

652.1106 State supplement
Table 11-6 Equivalent energy annual cost escalation factors

Borrowing interest (%)	No. of years	----- Energy cost escalation rate -----		
		5.0%	7.0%	9.0%
7.0	5	1.09788	1.13970	1.18311
	10	1.22416	1.33069	1.44838
	15	1.35331	1.53928	1.75795
	20	1.48369	1.76451	2.11595
9.0	5	1.09591	1.13685	1.17934
	10	1.21520	1.31715	1.42960
	15	1.33140	1.50456	1.70734
	20	1.44221	1.69553	2.01020
10.5	5	1.09445	1.13476	1.17658
	10	1.20869	1.30733	1.41599
	15	1.31580	1.47988	1.67145
	20	1.41341	1.64783	1.93738
12.0	5	1.09303	1.13271	1.17387
	10	1.20237	1.29780	1.40279
	15	1.30091	1.45639	1.63734
	20	1.38659	1.60357	1.87003

Chapter 12

Energy Use and Conservation

Contents:	652.1200	General	12-1
	652.1201	Reducing pump energy requirements	12-2
		(a) Increase pumping plant efficiency	12-2
		(b) Increase irrigation efficiency	12-3
		(c) Proper irrigation scheduling	12-3
		(d) Reduce pressure requirements	12-3
		(e) Conversion from pump to gravity	12-3
		(f) Changing to another irrigation method or system	12-3
	652.1202	Energy source	12-4
		(a) Energy use criteria	12-4
		(b) Nebraska pumping plant performance criteria	12-4
		(c) Reading watt-hour meters	12-11
	652.1203	Irrigation pumping plant design considerations	12-11
		(a) Pump characteristic curves	12-12
		(b) Pumping plant installations	12-18
		(c) Electric motors	12-18
		(d) Internal combustion engines	12-20
		(e) Pump installation	12-20
	652.1204	Pipeline efficiency	12-27
	652.1205	Alternative energy reduction devices	12-29
	652.1206	Other energy sources for pumping water	12-30
	652.1207	State supplement	12-30

Tables

Table 12-1	Sprinkler irrigation system vs. surface irrigation system water use and losses	12-1
Table 12-2	Nebraska pumping plant performance criteria	12-5
Table 12-3	Nebraska performance criteria vs. overall efficiency	12-5
Table 12-4	Comparative fuel use	12-6
Table 12-5	Comparison of energy sources	12-6
Table 12-6	Practical static suction lift	12-14
Table 12-7	Electrical current phase required for standard electric motor sizes	12-18
Table 12-8	Nominal efficiencies for standard and high efficiency electric motors	12-19
Table 12-9	Pipe friction loss comparison table for welded steel, aluminum, and plastic pipe	12-28

Figures

Figure 12-1	Energy requirements for an efficient irrigation pumping plant	12-7
Figure 12-2	Electric power costs to pump an acre-foot of water against a head of 1 foot	12-8
Figure 12-3	Horsepower saved converted to dollars saved in a year using electrical energy	12-9
Figure 12-4	Horsepower saved converted to dollars saved in a year using diesel fuel	12-10
Figure 12-5	Single speed centrifugal pump	12-13
Figure 12-6	Multispeed centrifugal pump	12-15
Figure 12-7	Vertical turbine pump	12-16
Figure 12-8	Vertical mixed flow pumps	12-17
Figure 12-9	Installation considerations for centrifugal pumps	12-21

Figure 12-10 Priming arrangements for centrifugal pumps 12-24

Figure 12-11 Sump dimensions versus flow for vertical propeller pump installation 12-26

Figure 12-12 Nomenclature for sump dimensions and pump arrangement for vertical propeller pump installation 12-27

Figure 12-13 Ratio of pump characteristics to pump rpm 12-29

Example

Example 12-1 Change of performance rules 12-25

652.1200 General

Energy cost for operating an irrigation pumping plant is a major concern to most irrigation decisionmakers. Many are taking a close look at their pumping installations to find ways to reduce operating costs. Some irrigators consider converting from medium to high pressure sprinkler back to surface irrigation systems to reduce or eliminate energy costs. Generally, this leads to a considerable reduction in water application uniformity with increased runoff, deep percolation, or both. Typically more water must be applied with graded surface irrigation systems than for sprinkler irrigation systems, and where the water is pumped from wells, an energy reduction by converting may not be realized.

To maintain an efficient operating pumping plant, modifications to the pump are generally necessary to reduce pressure head and increase flow. Many irrigators who use center pivot or linear move sprinkles are converting to low pressure application devices on their systems to reduce energy costs. Flow being pumped to the system remains the same, but pressure head is reduced. This may also require a modification to the pump. Reducing pressure by installing a valve between the pump and sprinkler heads does not reduce energy.

Because energy is an immediate cost, the irrigator is often more interested in reducing readily apparent energy costs than solving other important problems, such as poor water management for the full irrigation season or high seepage losses in the on-farm distribution system. Table 12-1 demonstrates typical seasonal water use and losses of sprinkler irrigation systems versus surface irrigation systems.

Properly designed and operated surface irrigation systems can provide good irrigation efficiencies. For example, adequately designed, operated, and well-managed level basin irrigation systems can have irrigation efficiencies of 85 to 90 percent. To maintain a high total farm water use efficiency using level basins, laser controlled field leveling, lined head ditches with good water control structures, adequate flow rate, and proper water and system management should be available and used. Properly designed, operated, and properly managed Low Energy Preci-

sion Application (LEPA) systems, can reach irrigation efficiencies of 90 to 95 percent. To obtain this efficiency with LEPA systems, adequate water management and cultural practices should be used to provide complete water infiltration where the system is used; i.e., no water translocation.

Although energy conservation is not a specific NRCS objective, it is a national objective assigned to other water conservation activities that are NRCS objectives. Finding ways to reduce energy consumption in conjunction with soil and water conservation measures can be a major selling point when recommending conservation measures.

Many irrigation pumping installations were designed and installed when energy costs were lower. Typically, the original installation was not as efficient as those installed today. Some installations were poorly designed or improperly installed in the first place. Many pumping plants have not been maintained properly and have significantly lower efficiencies than when originally installed. Length of irrigation sets, and thus pumping times, is frequently governed more by the irrigators schedule than by the needs of the crop. This leads to many pumping plant installations being much less efficient because of management than they could be.

Table 12-1 Sprinkler irrigation system vs. surface irrigation system water use and losses

	Moderate pressure sprinkler irrig. system (ac-in/ac)	Surface irrigation system (ac-in/ac)
Crop water requirement	20	20
Misc. spray losses @ 15%	4	0
Ditch seepage losses @ 15%	0	5.9
Surface system- DP & RO losses @ 40%	0	13.4
Sprinkler system- DP losses @ 10%	2.7	0
Total	26.7	39.3

Finding the most economical solution to these problems requires a multidisciplinary team approach. The irrigation decisionmaker is the most important member of the team. Pump and equipment dealers and manufacturers should be involved. Electric power companies and public utility districts are interested in electrical energy conservation. Electrical power conserved is new power not generated. The Extension Service has an energy conservation objective. Their team members have considerable specialized information and expertise that should be used to the fullest. NRCS needs to work closely with other members of the team using the planning process to provide good energy conservation alternatives.

Several manufacturers are named in the information in this chapter. NRCS endorsement is not implied. Names are used for illustration only.

652.1201 Reducing pump energy requirements

The major considerations for ways to reduce pumping energy are:

- Increase pumping plant efficiency
- Increase irrigation efficiency
- Proper irrigation scheduling (amount and timing)
- Reduce pressure (energy) requirements
- Conversion from pump to gravity
- Changing to another irrigation method or system

(a) Increase pumping plant efficiency

Pumping plant efficiency is the ratio of the amount of work done (output) by a pumping plant (pump and power unit) to the amount of energy required to do the work (input). A procedure to check pumping plants is included in Chapter 15, Planning and Evaluation Tools.

Pumps and many engines and motors are designed to operate under a narrow range of conditions. They should be operated within this range for best efficiency. Pumps and power units are subject to wear, so close attention to maintenance is required to sustain desirable pumping efficiency.

High efficient electric motors are designed to operate under a wide range of conditions (half to full load) with less than 1 percent spread in nominal efficiency. Typical nominal efficiency range is 94.5 to 95.0 percent under half to full load of a 3,600 rpm, 50 hp, high efficient electric motor. (See table 12-8.) Most manufactures are more than willing to provide performance information on their engines and motors.

(b) Increase irrigation efficiency

Irrigation efficiency can be increased in several ways. A well designed and managed irrigation system, should meet crop water design requirements, typically full crop ET across most of the field with minimum deep percolation and runoff. Distribution across the field should be uniform. Conveyance losses can be minimized by installing a ditch lining or pipelines. Leaks of any kind should be promptly repaired. The delivery system should be properly maintained to operate according to original design. The water user should strive for application efficiencies in excess of 80 percent with all irrigation methods. Chapters 5, 9, and 15 provide details on irrigation system evaluations.

(c) Proper irrigation scheduling (amount and timing)

Proper irrigation scheduling is applying water at the right time and in the amount to meet water needs. Needs can be for crop water needs or other uses, such as improved crop quality, crop heating or cooling, salinity management, or chemigation. Where the water supply is not limited, the greatest waste of water (and energy) is usually over irrigation. Excess water application reduces plant yield or biomass, limits the ability of soil to grow crops, wastes nutrients, and increases the potential for surface or ground water pollution.

In some areas, irrigation water managers are using up to 5 times as much water as locally published crop ET amounts indicate is adequate. Even a simple program of irrigation scheduling can greatly reduce this excessive use. Chapter 9, Irrigation Water Management, provides details on irrigation scheduling methods.

(d) Reduce pressure (energy) requirements

Low pressure sprinkler or spray heads are being used on most new center pivot installations. This saves energy. Some older systems are being retro-fitted to use low pressure heads. Conversion should be done with careful design to maintain overall efficiency. In many cases the pump must be modified or replaced to assure optimum energy use; i.e., trim the impellers to reduce pressure head. If the water source is a deep well, reducing pressure at the sprinkler nozzle may

reduce total energy requirements very little. Too often pressure (and perhaps irrigation equipment) is changed without an associated change in management. This results in an even lower irrigation application efficiency. For example, installing LEPA sprinkler nozzles without making appropriate changes in soil, water, and plant management often reduces application uniformity. Energy requirements typically stay the same if a valve is used to reduce operating pressures on the sprinkler system. The pressure upstream of the valve is the same as before; therefore, total pressure head is the same.

Modifying pipe size, changing from high friction loss pipe to low friction loss pipe, changing field configuration, and using valves and fittings that reduce friction loss can reduce total pressure head requirements. This cost can be weighed against the savings in energy, recognizing that energy costs will most likely increase in future years.

(e) Conversion from pump to gravity

Many opportunities occur to wholly, or in part, convert from pump to gravity supplied pressure for sprinkler systems. Ditches generally must be replaced with pipelines; therefore, this is costly. However, long-term savings with energy used for pumping can be substantial. Each foot of elevation provides 0.433 pounds per square inch of pressure (or $1 \text{ lb/in}^2 = 2.31 \text{ ft of head}$). In computing available head, pipeline friction loss must be subtracted from the elevation head. An additional benefit may be from the reduction of ditch seepage losses, improved water control, reduced labor, etc.

(f) Changing to another irrigation method or system

Changing the present irrigation method or system to another method or system can increase energy efficiency. An example is changing from a handmove sprinkler system to an automated furrow or border system. With proper site conditions, design, and management, surface systems can equal or exceed sprinkler system efficiencies. Detailed design and economic analysis generally are required to compare irrigation methods and systems.

652.1202 Energy source

Most pumping plants use electric motors, diesel engines, or natural gas engines as power sources. Occasionally liquid propane or gasoline engines are used. Most of the following information deals with electric and diesel powered units. If adequate electric power sources are located at or within a reasonable distance from the water source, electric power generally is the least costly form of energy. However, in rural areas where electrical power is generated from local coal fired, fuel oil or natural gas generators, natural gas engines are typically less costly to operate. In Southern States, natural gas is readily available in most rural areas.

Electric phase converters are available that allow three-phase motors over 10 horsepower to operate on single-phase power supply. However, they are costly to install and require some power to operate. The company furnishing electric power should be consulted before installation. Annual hours of use; i.e., irrigating only part season or when supplementing precipitation, need to be considered.

(a) Energy use criteria

Performance standards for an irrigation pumping plant can be expressed as performance standards or water horsepower-hours (wHp-hr) per unit of energy. These standards can be used to compare the cost of energy, as used in an efficient irrigation pumping plant, by different energy sources. Dollars per wHp-hr can also be used. With both, the energy cost for pumping an equal amount of water can be compared for various energy sources. For instance between a natural gas and an electric powered pump, if electric power is available.

Other nonenergy performance units include acre inches of water per unit of crop produced (water use efficiency), i.e., ac-in/ton of hay. Pumping cost per unit of crop produced, i.e., \$/bale of cotton, and cost per water horsepower, i.e., \$/wHp-hr, can also be used.

(b) Nebraska pumping plant performance criteria

Personnel at the University of Nebraska developed a set of performance standards for pumping plants (table 12-2). Comparison to the Nebraska criteria indicates how well the pumping plant is performing and can determine if excess energy is being used. Depending on the amount of energy used, a decision can be made regarding adjustments, repairs or replacement.

Nebraska pumping plant performance criteria represents the performance level that can be expected from a properly designed and maintained pumping system. It is a compromise between the most efficient pumping plant possible and the average pumping plant. Therefore, some pumping plants will exceed the criteria.

Nebraska criteria are expressed as the water horsepower (wHp) produced from a unit of fuel for 1 hour and can be represented in the units wHp-hr/unit of fuel. The performance of any pumping plant is represented by the same units. Performance is calculated by dividing the water horsepower produced by the fuel consumption of the pumping plant.

Water horsepower is a function of water volume output, pressure, lift or suction and pipe friction losses. It is the true work being accomplished by the pump. (More detail on horsepower calculations is contained in NEH, Part 623 (Section 15), Chapter 8, Irrigation Pumping Plants. Water horsepower, which does not include pumping plant efficiency, can be calculated by:

$$\text{whp} = \frac{(\text{flow, in gpm}) \times (\text{TDS, in ft})}{3,960}$$

where:

$$\text{TDH (total dynamic head, in ft)} = (\text{lift, in ft}) + (\text{pipe friction loss, in ft}) + (\text{pressure head, in ft}) + (\text{velocity head, in ft})$$

Note: Pipe friction loss includes column or lift pipe losses in addition to friction losses from pipe and fittings downstream from well head.

$$\text{pressure head, (ft)} = (\text{lb / in}^2) \times (2.31 \text{ ft / lb / in}^2)$$

$$\text{pressure head, in ft} = (2.31) \times (\text{Pressure, in psi})$$

$$\text{velocity head, (ft)} = \frac{V^2}{2g}$$

where:

- V = velocity of flow in pipeline, ft/s
- g = acceleration of gravity at 32.2 ft/s/s
- gpm = total pumping quantity, in gal/min
- 3,960 = units conversion, where gpm units are used

By comparing the pumping plant's performance to the criteria, a percentage rating results. This is accomplished by dividing the performance of the pumping plant by the performance criteria. For example, a diesel producing 75 wHp and burning 6 gallons per hour would have a performance of 12.5 wHp-h/gal (75 wHp/6 gal/hr).

Table 12-2 Nebraska pumping plant performance criteria

Energy source	bhp-h ^{1/} per unit of energy	wHp-h ^{2/} per unit of energy ^{3/}	Energy units
Diesel	16.66	12.5	gallon
Gasoline	11.5 ^{4/}	8.66	gallon
Liquid Propane	9.20 ^{4/}	6.89	gallon
Natural gas	82.2 ^{5/}	61.7	1,000 cubic feet
Electricity	1.18 ^{6/}	0.885 ^{7/}	kilowatt-hour

1/ bhp-h (brake horsepower-hours) is the work being accomplished by the power unit (engine or motor) with only drive losses considered.

2/ wHp-h (water horsepower-hours) is the work being accomplished by the pumping plant, engine, or motor and pump.

3/ Based on 75 percent pump efficiency.

4/ Taken from Test D of Nebraska Tractor Test Reports. Drive losses are accounted for in the data. Assumes no cooling fan.

5/ Manufacturer's data corrected for 5 percent gear head drive loss with no cooling fan. Assumes natural gas energy content of 925 Btu per cubic foot. At 1,000 Btu per cubic foot, energy content uses 88.9 Hp-h per 1,000 cubic feet for natural gas. Btu per cubic feet can vary from season to season and from winter to summer.

6/ Assumes 88 percent electric motor efficiency.

7/ Direct connection, assumes no drive loss.

Comparing this to the diesel criteria of 12.5 wHp-h/gal results in a rating of 100 percent:

$$\frac{(\text{12.5 wHp-h/gal from pumping plant})}{(\text{12.5 wHp-h/gal from criteria})} = 1.0 \text{ or } 100\%$$

This pumping plant has met the criteria. On the other hand if this plant had been consuming 8 gallons per hour of diesel, its performance would be 9.4 wHp-h/gal (75 wHp/8 gal/hr) and its performance rating would be 75 percent, (9.4 wHp-h/gal) divided by (12.5 wHp-h/gal). In this case the pumping plant would be performing below the criteria, using unnecessary fuel (2 gal/hr).

(1) Criteria versus overall efficiency

The performance rating should not be confused with the pumping plant's overall efficiency. They are not the same. Overall efficiency is the ratio of the energy output of the pump (water horsepower) compared to the energy used; whereas, the performance rating is the ratio of the performance level of a pump compared to the standard performance criteria. The performance rating from the criteria does, however, relate to overall efficiency of the pump. For diesels, a pumping plant with a performance rating of 100 percent equates to an overall efficiency of 23 percent (table 12-3). The above diesel pumping plant had a performance rating of 75 percent, however, it is not 75 percent efficient. Rather, if one wishes to base the performance on overall efficiency, the pumping plant would be considered 17 percent efficient (0.75 x 23% = 17%).

Table 12-3 Nebraska performance criteria vs. overall efficiency ^{1/}

Energy type	Unit of energy	wHp-h per unit of energy	Performance rating (%)	Overall efficiency (%)
Diesel	gal	12.5	100	23
Propane	gal	6.89	100	18
Natural Gas	mcf	61.7	100	17
Electric	kWh	0.885	100	66 ^{2/}
Gasoline	gal	8.66	100	17

1/ Efficiency given for electricity is *wire to water* efficiency, which is calculated at the pump site. Liquid or gas fuel is based on average Btu values.

2/ Overall efficiencies vary from 55 percent for 5 horsepower to 67 percent for 100 horsepower.

Remember, performance criteria are basically an index so that pumping plants can be compared to one another. The performance rating can be used to rate the pumping plant on a scale of 1 to 100 with 100 meaning the criteria have been met. For those pumping plants that exceed the criteria, the index goes beyond 100.

(2) Using criteria to determine excess fuel consumption

Performance criteria are also useful for determining excess fuel consumption of a pumping plant. The operational pump performance rating is simply subtracted from 100, divided by 100, and multiplied by the present fuel consumption. The result is the fuel being used in excess of what the criteria recommend. For example, the diesel pumping plant illustrated earlier had a performance rating of 75 percent and was consuming 8 gallons of fuel per hour. The excess fuel consumption per hour would be 2 gallons per hour.

$$(100 - 75/100) \times (8 \text{ gal/hr}) = 2 \text{ gal/hr excess}$$

Table 12-4 shows comparative fuel use at various performance ratings. The criteria can also be used to determine what the fuel consumption would be for a new pumping plant designed to meet the criteria.

Water horsepower of the pumping plant is simply divided by the performance criteria to get the fuel consumption per hour. For example, suppose a new diesel-powered deep well turbine pumping plant is designed to meet the criteria and pump 1,000 gallons per minute from 150 feet with a discharge pressure of 80 pounds per square inch. The horsepower output would be 85 water horsepower. The calculated fuel use would be (85 wHp divided by 12.5 wHp-h/gal = 6.8 gal/hr). Fuel consumption can also be calculated for other design pressures to compare operating costs between different irrigation systems, such as high or low pressure center pivot. The criteria can even be used to compare the operating costs between different energy sources. Table 12-5 is a direct comparison, using this example for fuel consumption and with various fuels, of hourly costs for different energy sources.

Table 12-4 Comparative fuel use

Performance rating (%)	Multiplier for fuel use in excess of criteria
100	1.0
90	1.11
80	1.25
70	1.43
60	1.67
50	2.0
40	2.5
30	3.33
20	5.0
10	10.0

Table 12-5 Comparison of energy sources

	Fuel costs (\$)	Hourly cost (\$)
Diesel	1.00 / gal	6.80
Diesel	1.25 / gal	8.50
Natural Gas	2.70 / mcf	3.72
Natural Gas	3.00 / mcf	4.13
Natural Gas	3.50 / mcf	4.82
Natural Gas	4.00 / mcf	5.51
Electric	.04 / kWh	3.84 ^{1/}
Electric	.06 / kWh	5.76 ^{1/}
Electric	.08 / kWh	7.68 ^{1/}

^{1/} Monthly demand charges may be in addition to direct electrical energy use and will vary widely depending on electrical company.

Figure 12-1 displays the energy requirements for an efficient irrigation pumping plant for flows above 250 gallons per minute comparing various energy sources. It is shown as an example that an efficient pumping plant discharging 1,000 gallons per minute against a total lift of 300 feet requires about 85 kilowatt hours of

electric energy. A diesel engine would use 6.9 gallons of fuel per hour, a propane engine 10.8 gallons per hour, natural gas engine 112.5 cubic feet per hour, and a gasoline engine 8.6 gallons per hour. Local fuel unit costs can then be applied to compare alternative energy uses.

Figure 12-1 Energy requirements for an efficient irrigation pumping plant (source: Bulletin 637, Cooperative Extension Service, University of Wyoming)

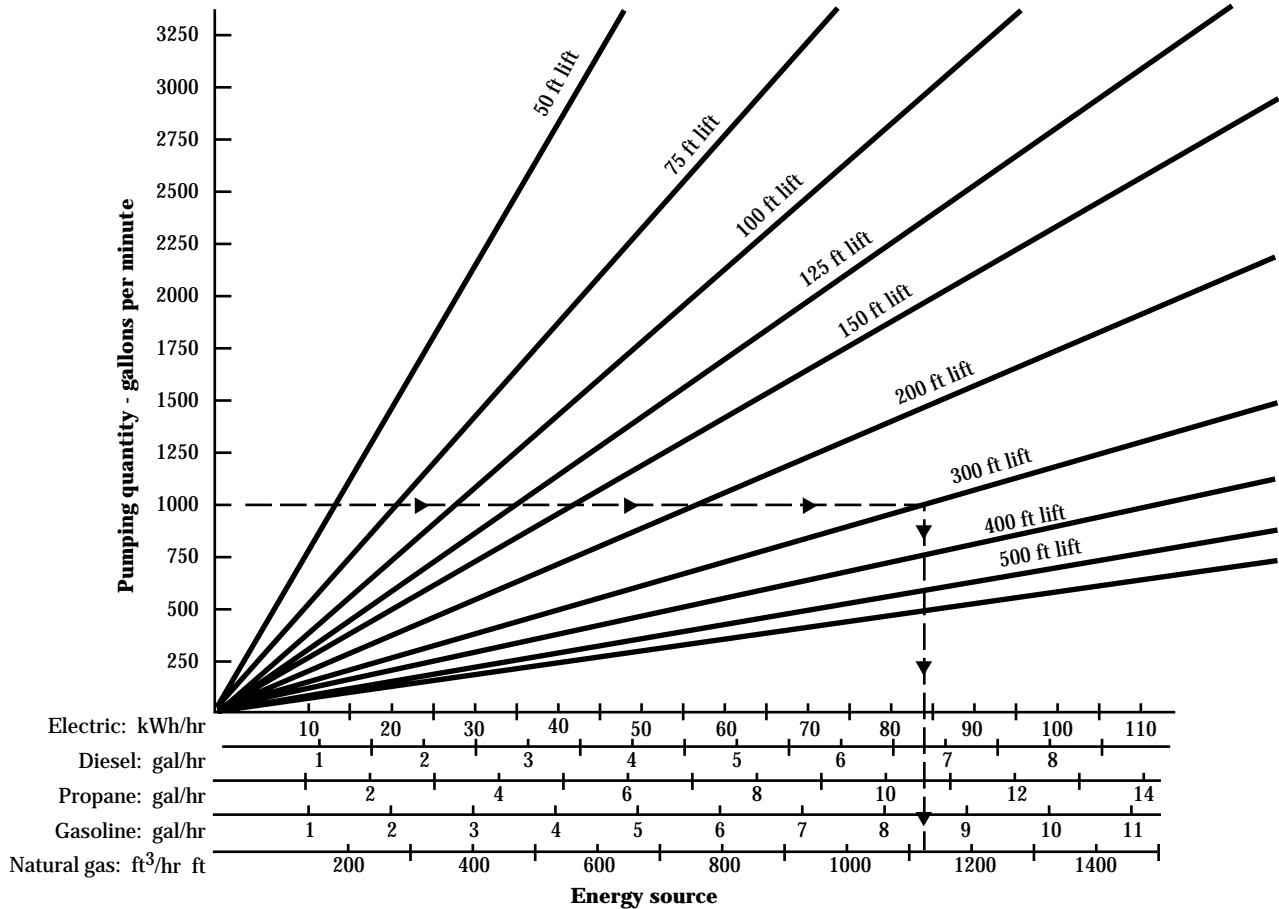
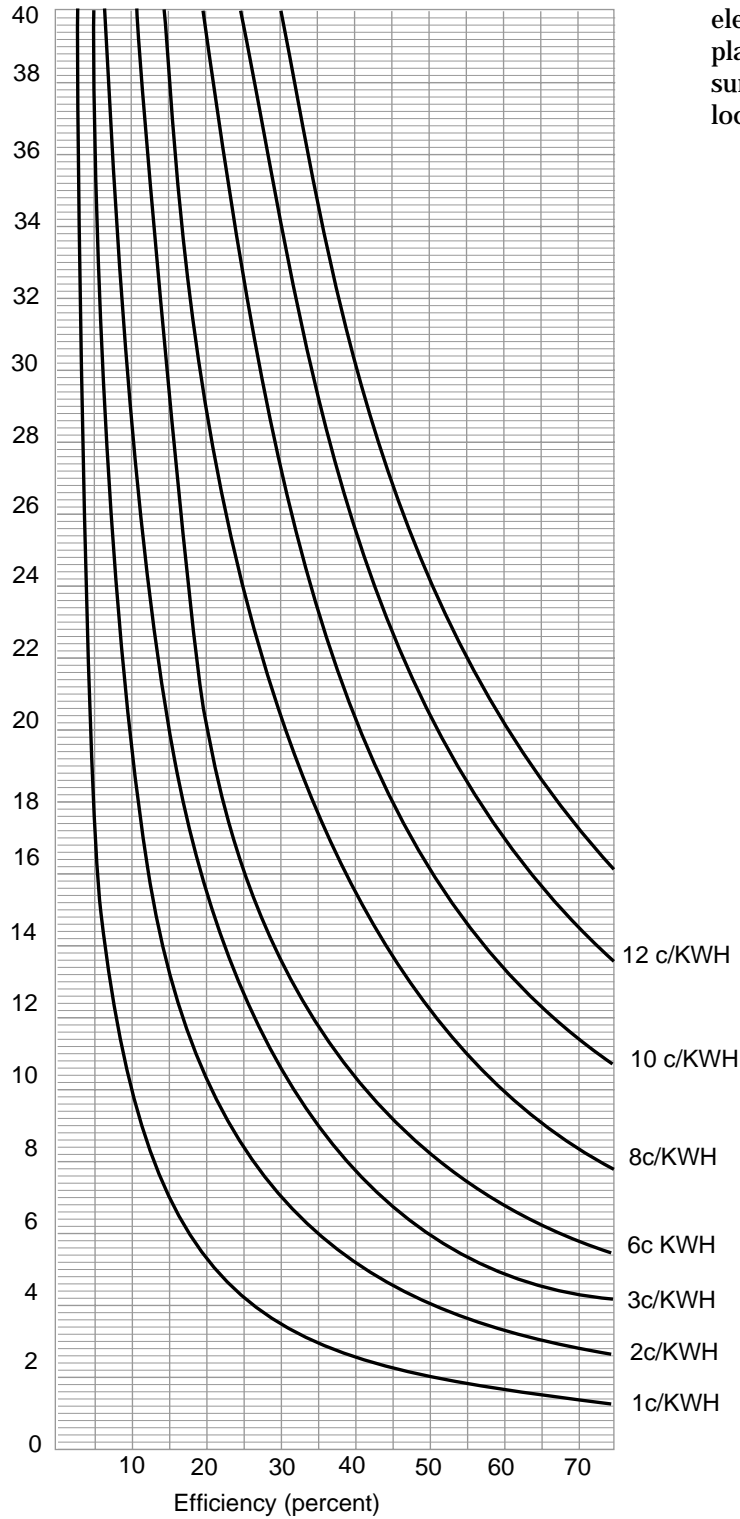

Figure 12-2 Electric power costs to pump an acre-foot of water against a head of 1 foot

Figure 12-2 shows relationship of electric pumping plant efficiency versus cost (cost per acre-foot per foot of head in dollars or cents) of pumping for various electrical rates. It vividly displays effect of a pumping plant operating at poor efficiency. It does not include surcharges, such as for demand charge, applied by local electric companies.



Figures 12-3 and 12-4 display effects of decreased horsepower requirements resulting from reducing total pressure head requirements. This may be from decreased pumping lift, reduced friction losses with modifications to the pipelines (i.e., suction pipe,

mainlines, submains, and lateral) and fittings (i.e., elbows, reducers, enlargers, valves), or decreased operating pressure (i.e., conversion from high pressure to low pressure).

Figure 12-3 Horsepower saved converted to dollars saved in a year using electrical energy (courtesy of Cornell Pump, Portland, OR)

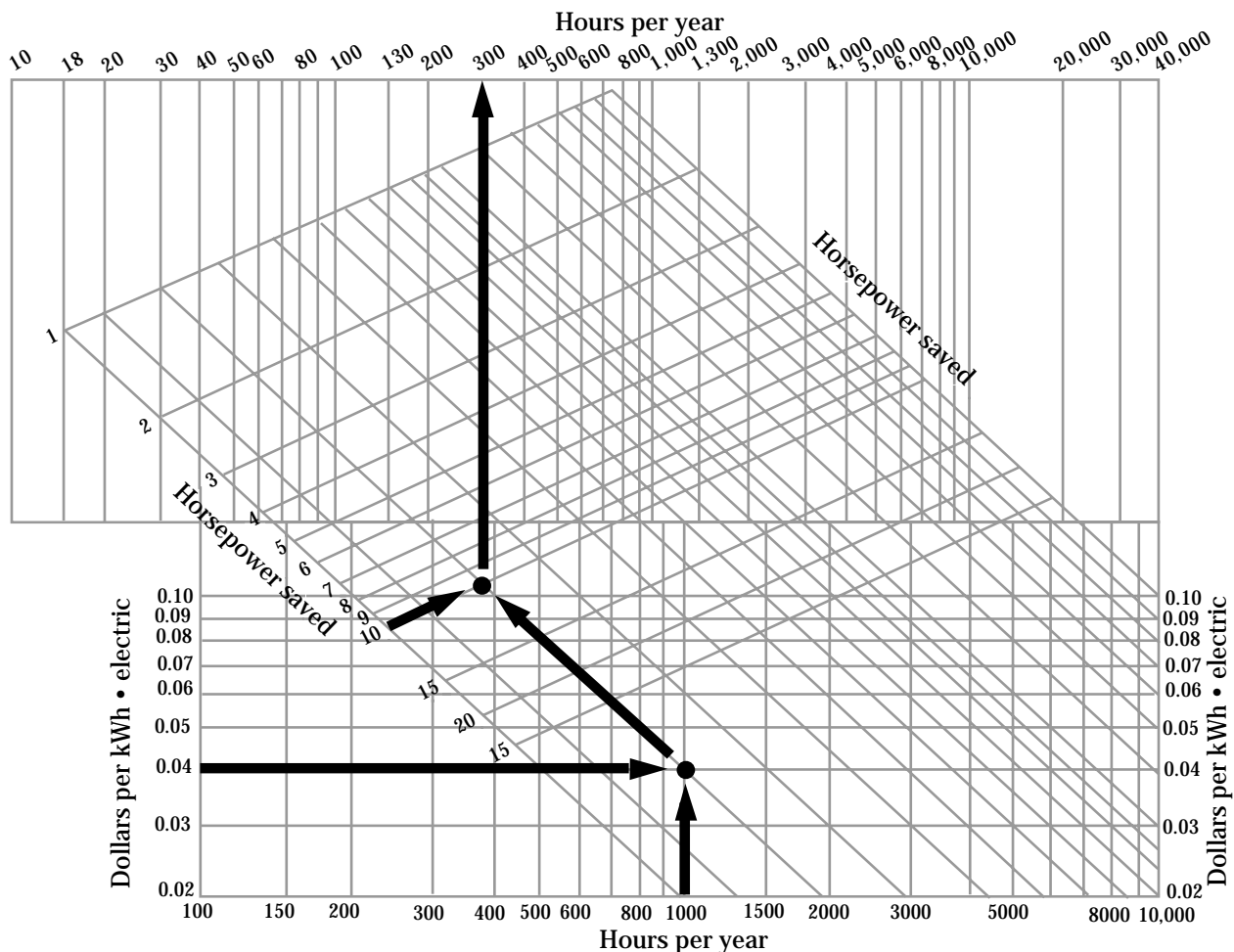

Example:

Cost of electric power = \$.04 / kWh
 Hours of pumping, annually = 1,000 hr
 Calculated horsepower saved = 10 hp

Therefore:

Savings of \$300 per year would result in pumping plant operation.

Figure 12-4 Horsepower saved converted to dollars saved in a year using diesel fuel (courtesy of Cornell Pump Company, Portland, OR)

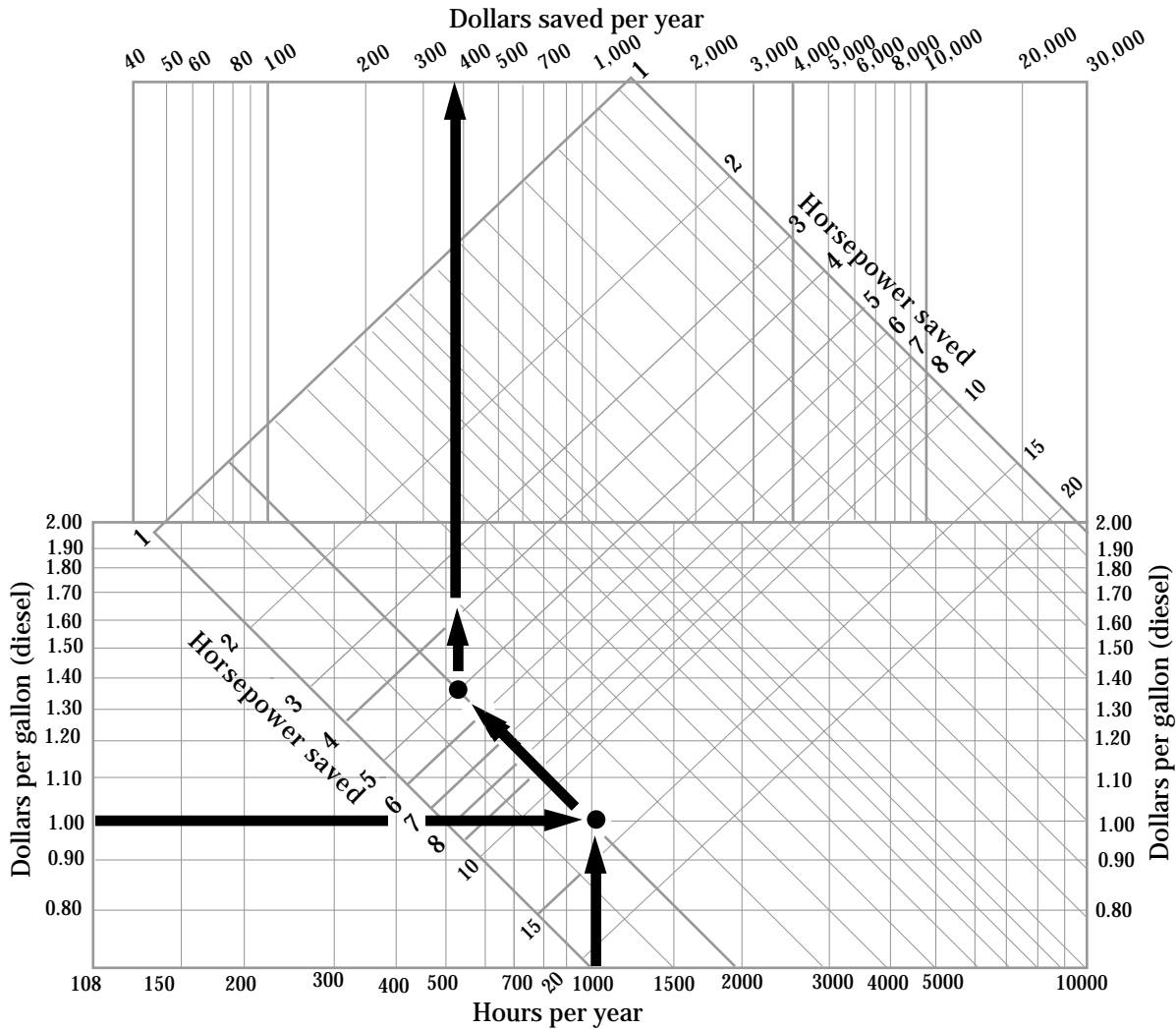

Example:

Diesel fuel cost = \$1.00/gal
 Hours of pumping, annually = 1,000 hr
 Calculated horsepower saved = 5 HP

Therefore:

Savings of \$380 per year would result in pumping plant operation

(c) Reading watt-hour meters

A quick and easy way to determine energy input to an electric pump is to use revolutions per unit time of the small revolving disc on the watt-hour meter and calculate horsepower usage. The formula at the bottom of this page is used to convert meter readings to kilowatt energy use and horsepower. These multipliers may vary, depending on local application, and checking with local electric company is necessary.

652.1203 Irrigation pump- ing plant design consider- ations

Irrigation pumps are commonly used to lift water from one elevation to a higher elevation or to add pressure to the water. Handy information bulletins to determine energy use, methods to reduce energy use from pumping plants, selection of pumps, and pump performance are readily available from pump manufacturers and many university Cooperative Extension Services.

Pump and power unit should be carefully matched to the irrigation system flow requirements and Total Dynamic Head (TDH). Both characteristics should be accurately determined. This may involve measuring flows in an existing system. A detailed description of pump characteristics and hydraulic calculation procedures are contained in NEH Section 15, Chapter 8, Irrigation Pumping Plants.

$$\text{kW} = \frac{(3.6) \times (\text{meter disc revolutions}) \times (\text{meter constant, Wh}) \times (*)}{(\text{time, in seconds})}$$

$$\text{hp} = \frac{\text{kW}}{0.746}$$

where:

kW = kilowatts used by the electric motor

Wh = watt-hour meter constant, used to convert to kilowatt hours used

hp = horsepower

* = Where installations use a high rate of electrical energy, the electric company will install meters that only put a small part of the energy used through the meter. Current Transformer Ratio (CTR) of 200:5 (40 multiplier), 400:5 (80 multiplier), 800:5 (160 multiplier), or 1,600:5 (320 multiplier) can be used. A Potential Transformer Ratio (PTR) of 5:1 (5 multiplier) can also be used. **Note:** Both CTR and PTR can be used at the same installation. Ratios are multiplied by the observed kW calculation to determine the correct kW, as follows:

$$\text{actual kW} = (\text{observed kW}) \times (\text{CTR}) \times (\text{PTR})$$

Almost all pumps have moving parts that require some type of lubrication to prevent wear. In some instances the bearings are lubricated and sealed at the time of manufacture. In others oil or grease must be added periodically or continuously, and even water itself may be used as the lubricant. Where water is pumped from wells using oil lubricated shafts, a layer of oil several inches thick often accumulates on the water surface.

Sediment in irrigation water causes wear of any pump. Propeller and centrifugal pumps handle a reasonable amount of sediment, but require periodic replacement of impellers and volute cases. Turbine pumps are more susceptible to damage because of the sediment in the water. Deep well turbine pumps can be costly to inspect for excessive wear. Positive displacement pumps must be used only with sediment-free liquids. Fertilizer and chemical injection pumps are typically positive displacement pumps and can provide the required accurate control of injected chemicals.

(a) Pump characteristic curves

Pump characteristic curves, sometimes called pump performance curves or head capacity curves, display the relationship between head (pressure) produced and the water volume pumped. Because of their mechanical nature, pumps have certain well defined operating properties. Pump characteristic or performance curves are available and essential for determining pumping plant requirements.

Data for these curves are developed by testing a number of pumps of a specific model. A set of curves or tables is prepared that represents the specific operating condition for each impeller and pump model. Field offices rarely have copies of all possible pump curves for all pumps used in their area. Generally, though, the majority of pumps in an area are of few makes, types, and models that are handled by local dealers. An effort should be made to obtain pump curves for these pumps from suppliers or from the manufacturer. Typically, they are readily available.

Performance of pumps changes with time. Since they are mechanical devices, they wear, and the rate of wear is dependent on the amount and kind of sediment pumped. Replacement of the impeller, wear rings, or even the entire bowl assembly may be required when wear has become excessive. The best way to evaluate an installed pump's performance is to do a field pump test described in Chapter 9, Irrigation Water Management. The field test should provide information needed for decisions on pump repair or energy reduction.

Performance curves are typically available for every make, model, and size pump commercially manufactured. However, it may be difficult to obtain performance curves for older pumps and for pumps where the impellers are used in the same pump, a performance curve is prepared for each size impeller. With multiple impellers (i.e., deep well turbine pumps), head developed by each impeller (stage) is accumulated. Speed of rotation also affects impeller performance.

A prerequisite to selecting the right pump or analyzing an existing pump is knowing how to read pump characteristic curves. Each manufacturer's curve looks a little different, and each type of pump has a slightly different set of curves. Most common characteristic curves provided by manufacturers and typically included on most pump performance curves are:

- Total dynamic head (ft) versus discharge (gpm)
- Efficiency (%) versus discharge (gpm)
- Input power (bhp) versus discharge (gpm)
- Net positive suction head (ft) versus discharge (gpm)

Normally, the NRCS technician only provides a head/capacity requirement, i.e., 900 gpm at 150 foot head, for dealer and owner pump selection. More detailed information is provided for better understanding, and to allow specific pump evaluation.

The following section illustrates how to read typical pump performance curves for each major type pumps used to pump irrigation water.

(1) Single speed centrifugal pump

Figure 12-5 illustrates a set of curves for a single speed centrifugal pump. This type pump is driven by a 1,760 rpm electric motor. Four factors, all related to discharge capacity in gallons per minute, are shown on the chart. They are:

- total dynamic head
- pump efficiency
- brake horsepower
- net positive suction head

The first three curves display the effect of different impeller diameters. For example, if a pump was required to deliver 900 gpm at 150 feet of TDH, read the chart as follows:

Enter the left side with TDH of 150 feet and the bottom at 900 gallons per minute. The intersection of these two is just above the 12 3/4-inch diameter impeller curve. Therefore, the next larger impeller must be used, which is 13 1/4-inch diameter. At a TDH of 150 feet, this pump puts out about 1,040 gallons per minute. If pump discharge is limited with a valve to 900 gallons per minute, TDH raises to 170 feet of head, and efficiency is read at 900 gallons per minute on the efficiency curve as about 78 percent (read left efficiency scale). If pump discharge is not limited with a valve, efficiency for 1,040 gallons per minute is read as 77 percent. Brake horsepower is about 50. Maximum allowable net positive suction head (NPSH) is about 6 feet. (Suction head exceeding this causes operation problems and loss of efficiency.) If the increased TDH is unacceptable, exact head/discharge can be obtained by trimming the impeller diameter. Energy used will reduce accordingly.

Figure 12-5 Single speed centrifugal pump (courtesy of Berkeley Pump Company)

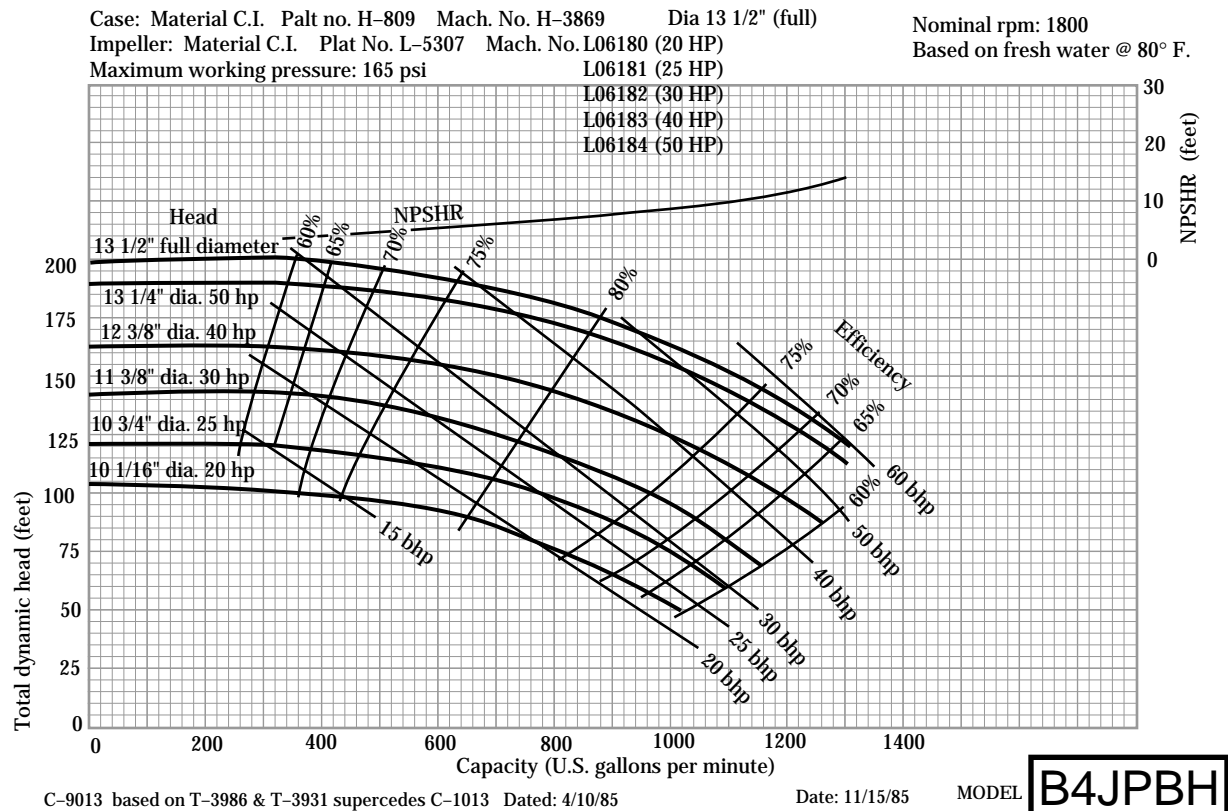

If the higher flow rate is selected, friction loss in the pipeline also increases. Recalculation of friction losses is necessary. An Irrigation System Performance Curve (friction loss vs. capacity) can be plotted or overlaid onto the pump characteristic curve. The pumping plant operates where the two curves cross (intersect).

Pumps shown in the curve are for standard 30-, 40-, and 50-horsepower sizes. If the brake horsepower require is slightly over a standard size motor, consult the motor manufacturer to see if overload is acceptable. Otherwise, use the next larger motor.

A flow of 1,040 gallons per minute is not the design flow of 900 gallons per minute. You must now decide to accept this or look at the alternatives. The alternatives are:

- Use the next size smaller pump and accept lower flow.
- Look for another brand or model pump that better fits the conditions.
- Reduce TDH to about 137 feet by increasing pipe sizes or reducing output pressure, then go to the smaller 40-horsepower pump.
- Increase the TDH by closing a valve slightly until a discharge of 900 gallons per minute is reached. This action is not energy efficient; however, it can be most practical where discharge is to be limited.

Pump selection is always a select, recalculate, and retry compromise to find the most efficient pump that best fits the desired conditions.

(2) Multispeed centrifugal pumps

Figure 12-6 illustrates a set of curves for a single impeller size multispeed centrifugal pump. Multispeed pumps are generally driven by an internal combustion engines. Curves shown are head, brake horsepower, and pump efficiency versus capacity curves.

Design head/discharge should be located to the right of peak pump efficiency. As wear occurs, pump efficiency increases giving a higher life span efficiency than if designed for absolute peak efficiency initially. For example, if a pump is to deliver 1,100 gallons per minute at 60 feet TDH, find the rotations per minute and horsepower required.

Enter the left side with TDH of 60 feet and the bottom with 1,100 gpm. Read required shaft speed of pump as slightly above 1,800 rpm, bhp as about 21 horsepower, and efficiency as about 80 percent. Note that this performance is based on a suction lift of 15 feet. Less suction lift should be used at higher elevation to maintain performance. Table 12-6 displays practical static suction lift.

Total suction lift equals static lift plus friction loss in suction pipe, elbows, and foot valve plus velocity head. The example is for 900 gallons per minute with 6-inch diameter welded steel suction pipe, elbow, foot valve; a 5,000-foot elevation, and maximum water temperature of 80 °F.

Given:

Static lift (water surface to eye of pump inlet)	= 15.4 ft
Friction loss (calculated)	= 5.2 ft
Velocity head (calculated)	= .6 ft
Total	= 22.18 ft

Table 12-6 Practical static suction lift

Elevation (ft)	Maximum theoretical suction lift 1/ (ft)	--- Practical static suction lift 2/ --- at various water temperatures			
		60 °F (ft)	70 °F (ft)	80 °F (ft)	90 °F (ft)
Sea level	34.0	23.4	23.2	23.0	22.6
500	33.4	23.0	22.8	22.5	22.2
1,000	32.7	22.4	22.4	22.0	21.8
1,500	32.1	22.0	21.9	21.6	21.4
2,000	31.5	21.6	21.5	21.2	20.9
3,000	30.3	20.8	20.6	20.4	20.1
4,000	29.2	20.0	19.9	19.6	19.3
5,000	28.1	19.2	19.1	18.8	18.6
6,000	27.0	18.5	18.3	18.1	17.8

1/ Maximum theoretical lift of water at 50 °F and lower.
2/ 70 percent of theoretical maximum.

Figure 12-6 Multispeed centrifugal pump (courtesy of Berkeley Pump Company)

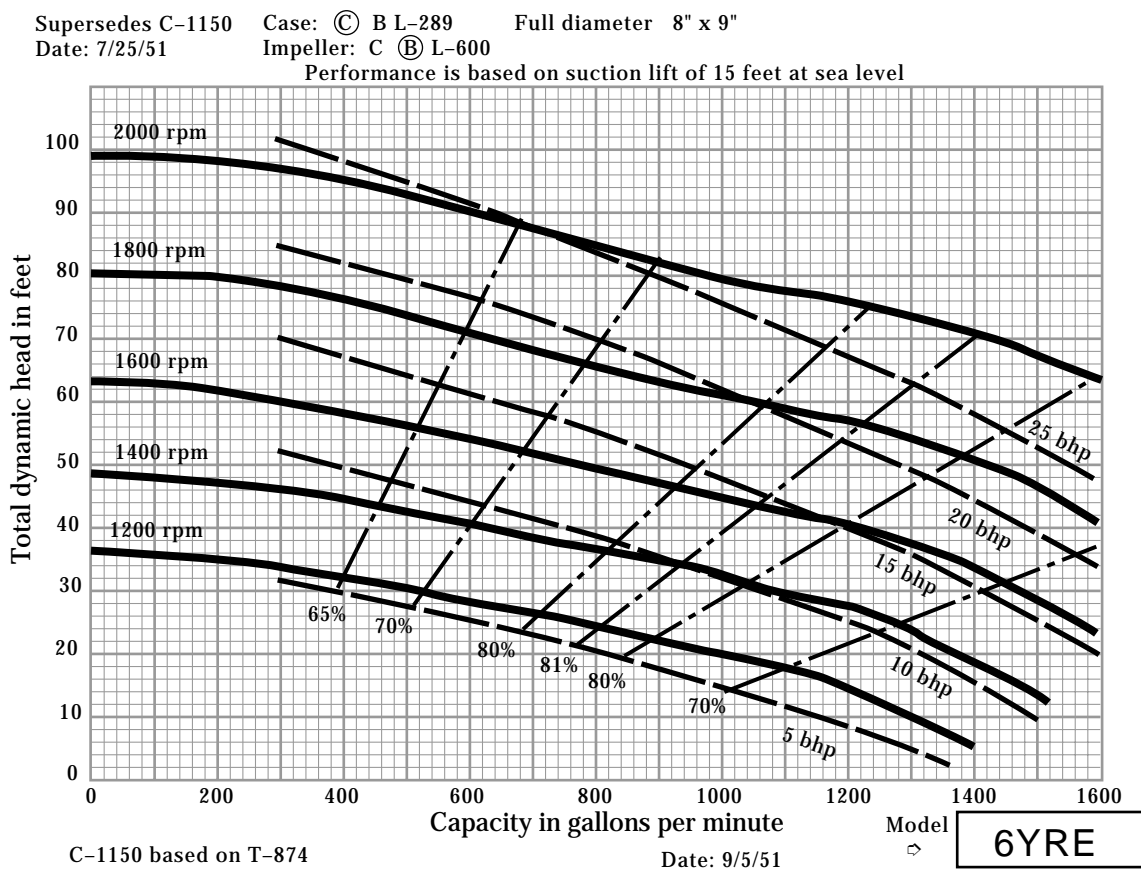

Reference to table 12-6 indicates maximum practical suction lift for 5,000-foot elevation equals 18.8 feet. Therefore, the pump will probably not operate properly and cavitation would probably occur. Alternatives include:

- Lower pump to reduce static lift.
- Enlarge suction pipe and improve configuration of elbows and foot valve to reduce friction loss.
- Reduce discharge.

Alternative considerations and procedures are similar to those described under single speed centrifugal pump.

(3) Vertical turbine pump

Figure 12-7 illustrates a set of three curves for a single stage of a single size enclosed impeller turbine. This pump is driven by an electric vertical motor at 1,770 rpm. Total dynamic head, brake horsepower, and pump efficiency are shown on the chart. Also shown is a chart giving factors to change efficiency as stages are added.

Often, a single-stage pump does not produce enough head to overcome the required lift or discharge pressure of an irrigation system. Vertical turbine pump stages (bowls) can be added in series. By doing this, the head capability is increased. The head-capacity curves and horsepower capacity curves are additive at a given discharge. Head and horsepower are doubled if a second bowl is added to a first bowl; three stages would triple the head produced and horsepower required.

Figure 12-7 Vertical turbine pump (courtesy of Berkeley Pump Company)

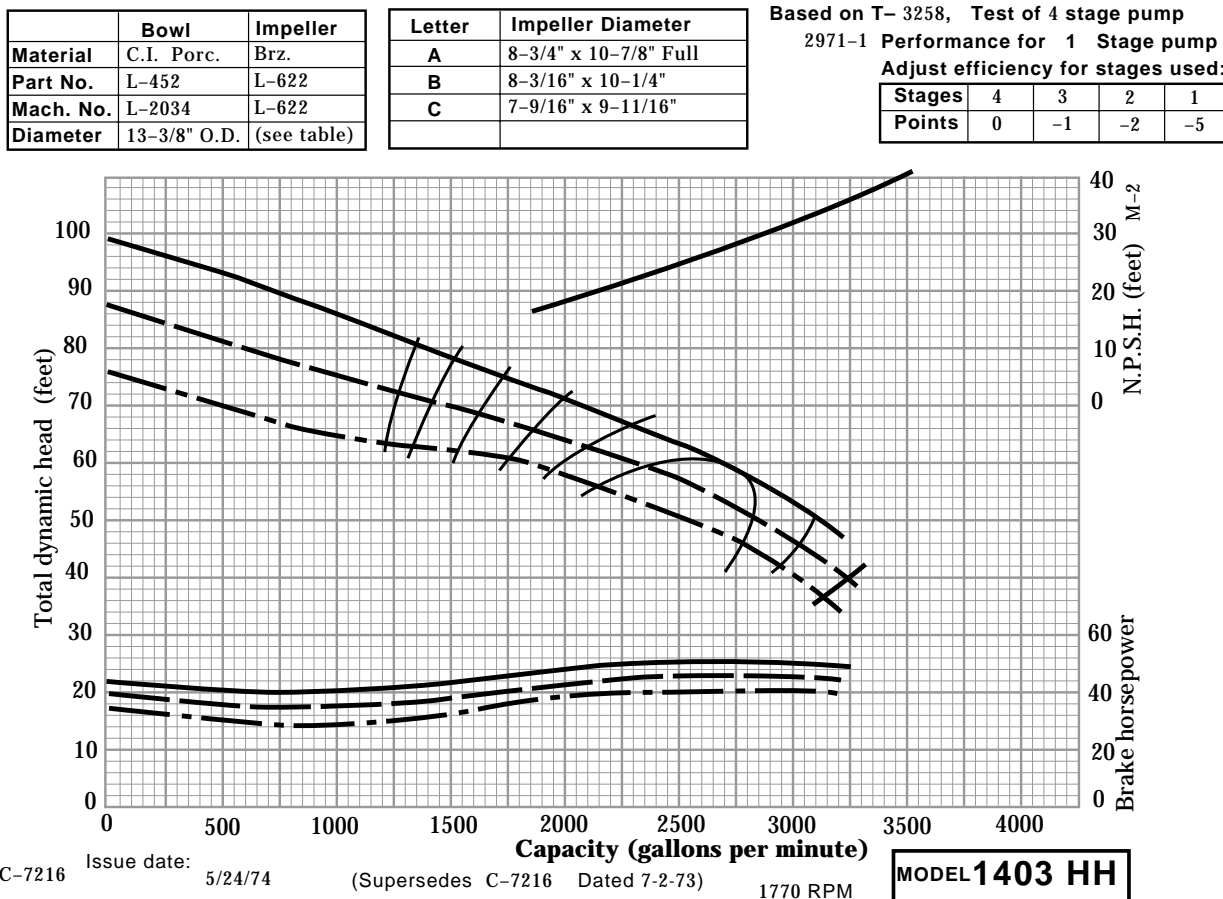

Staging turbine pumps can change efficiency. Efficiency corrections are shown in a table on the curve. In figure 12-7 the peak efficiency of the pump is given as 82 percent. According to the correction chart, a one-stage pump would be corrected by 5 percentage points ($82-5 = 77\%$), and a three-stage pump would have -1 correction ($82-1 = 81\%$).

Procedures for reading curves are otherwise the same as for the centrifugal pumps.

(4) Vertical mixed flow pumps

Figure 12-8 illustrates a curve for a 1,180-rpm electric motor driven, low-head, mixed-flow, pump. This pump is often used for lifting water from a stream to a ditch, one ditch to another, or boosting from a ditch into a surface system pipeline. Total dynamic head, brake horsepower, pump efficiency, and minimum submergence curves are shown.

The impeller (cross between propeller and turbine type) can be obtained in several configurations or pitches (7.5 to 24 degrees). Different pitches provide different head/capacity characteristics. Generally, the steeper the propeller pitch, the more brake horsepower required. Pitches are shown as five TDH and BHP curves.

Maintaining minimum pump intake submergence is critical. Therefore, sump (pump well) characteristics become critical with this pump. See figure 12-12 for recommended pump sump dimensions. Follow the manufacturer's recommendations carefully when designing the sump.

Pump performance curves are read the same as centrifugal pump curves.

Figure 12-8 Vertical mixed flow pumps (courtesy of Berkeley Pump Company)

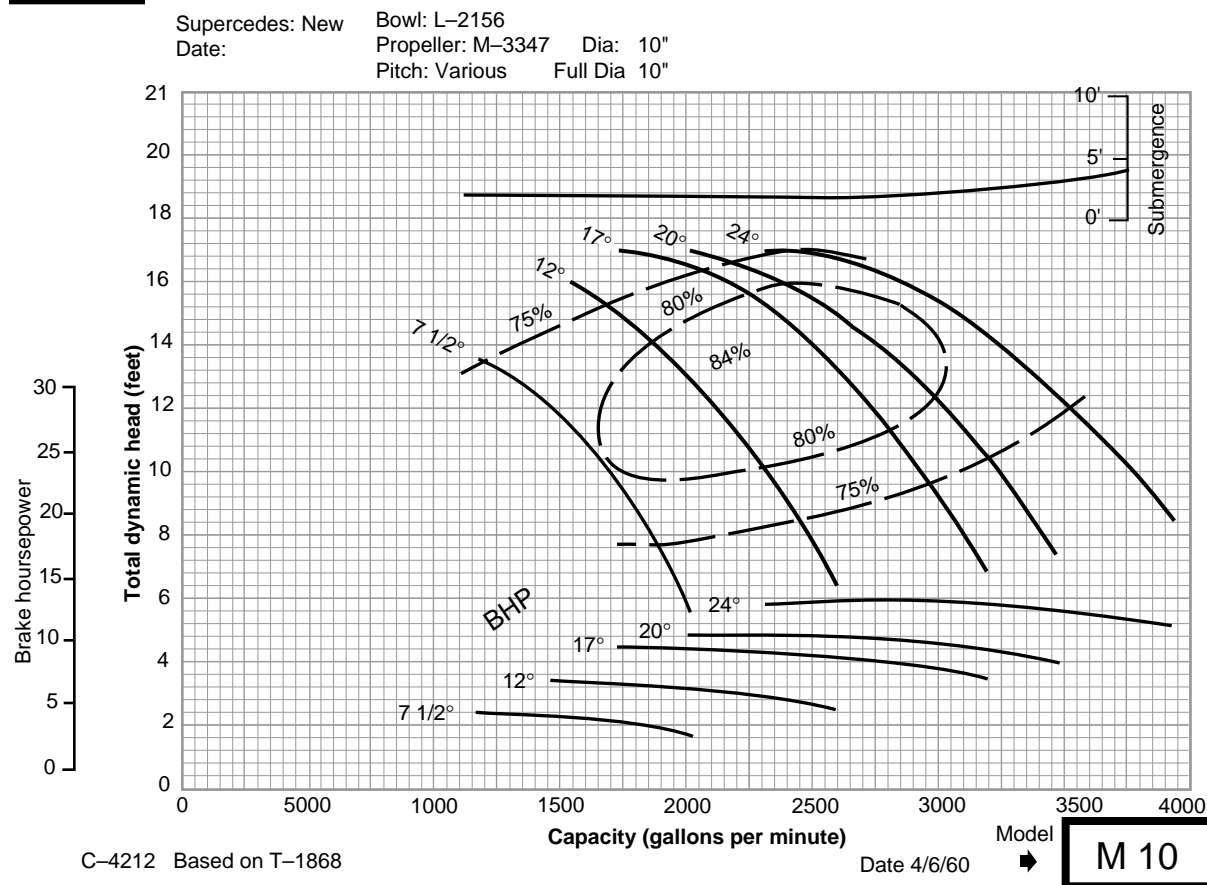

(b) Pumping plant installations

Pumps, motors, engines, and all appurtenances should be installed on a raised, firm foundation and be adequately shaded. All electrical cable, fittings, and control panel should be tight and adequately grounded, and the area should be free from standing water. For gasoline, diesel, natural gas, and propane powered engines, all hose connections should be tight with zero leaks.

For centrifugal pumps, installations should provide:

- Concrete slab foundation for a solid support of motor and pump and allow proper alignment of drive shaft. Do not secure pump and motor to the foundation. Allow the unit to seek its own position.
- Supports for suction and discharge pipes close to the pump.
- Adequate size pipe and fittings to prevent cavitation and minimize friction losses.

For vertical turbine pumps, installations should provide:

- Concrete slab foundation around the well head and pump base to provide support for gear head, engine, or motor and allow proper alignment of pump drive shaft.
- Maintain proper lubricant levels in gear head and pump shaft.
- Provide for adequate pump impeller submergence.
- Adequate size discharge pipe in the well.
- Adequate well capacity

For submersible pumps, installations should provide:

- Corrosion resistant cable support for pump motor, electric cable, and pipeline.
- Adequate size discharge pipe in the well.
- Adequate pump impeller submergence.
- Adequate well capacity.
- Proper size electric wire or cable from motor to control box.

Safety control devices should be considered standard installation items. Lightning protection devices are considered and installed according to manufacturer's recommendations. Pressure control switches should be provided to allow pumping plant shut-off should sudden pressure drop at downstream side of pump occur. Typical examples are a break in a pipeline or a control valve failure. Water level control sensors in

pump sumps can provide pump shut-off should the water source be interrupted. This device prevents pumps from operating with no water. Electric surge protectors should be considered to help protect electric panels and motors from lightening

(c) Electric motors

Electric motors should be carefully matched between load and electrical supply conditions. To do otherwise results in wasted power and higher than required initial installation and maintenance costs.

Table 12-7 lists standard electric motor sizes and speeds available, and electric current phase used to operate 10 horsepower or larger three-phase motors with single-phase current.

Table 12-7 Electric current phase required for standard electric motor sizes^{1/}

Motor hp	3,600 rpm	1,800 rpm	1,200 rpm	900 rpm	720 rpm	600 rpm
1	1,3	1,3	1,3			
1.5	1,3	1,3	1,3			
2	1,3	1,3	1,3			
3	1,3	1,3	1,3			
5	1,3	1,3	1,3	1,3		
7.5	1,3	1,3	1,3	3		
10	1,3	1,3	3	3		
15	3	3	3	3		
20	3	3	3	3		
25	3	3	3	3		
30	3	3	3	3		
40	3	3	3	3	3	3
50	3	3	3	3	3	3
60	3	3	3	3	3	3
75	3	3	3	3	3	3
100	3	3	3	3	3	3
125	3	3	3	3	3	3
150	3	3	3	3	3	
200	3	3				
250	3	3				
300	3	3				

1/ 1 = single-phase electric current, 1φ
3 = three-phase electric current, 3φ.

(1) Maximum size

Motors are designed and constructed at either single- or three-phase electric current. In most areas, a 10-horsepower motor is the maximum size that can be powered directly with single-phase current. Local utility companies may further limit the maximum size to 7.5 horsepower.

(2) Phase converters

Single-phase motors can be used to operate larger horsepower motors if a phase converter is used. Two most common types of converters are an auto transformer-capacitor converter (for horsepower to 100) and a rotary converter (for up to 200 horsepower motors or groups of motors). Converters are expensive, and a 2 percent or greater energy loss occurs when using them.

Rural electric power companies generally limit converter size because of the limited power line capacity the amount of current required during startup. Electric motors require three to five times running amperage for startup. Maximum motor size may be limited to 15 horsepower in some cases. A check with the local electrical company will address these concerns.

(3) Three-phase electric motors

Electric motors are rated according to their brake horsepower. Typically, this is the horsepower output that can be continuously delivered, as rated by the manufacturer. Electric motors can develop more horsepower than shown on the nameplate; however, loading above the nameplate horsepower can cause excess motor heating. Heat reduces motor life because heat accelerates the breakdown of motor insulation and other components. Three-phase motors do not require a starting mechanism; thus, they have fewer moving parts than do single-phase motors.

Some motors have a service factor (SF). Most three-phase motors used for irrigation have a service factor of 1.15. The service factor allows short-term loading above the brake horsepower rating without seriously affecting motor life, as long as good heat dissipation is maintained. Generally, service factor loading should not be used for continuous power. It is intended to be a safety factor.

An electric motor is not 100 percent efficient. Some energy is lost in converting electrical energy into mechanical energy. Electric motor efficiency is typically 80 to 95 percent. Larger motors are more efficient than smaller motors. Also a small motor's efficiency is highest at 3/4 load. Table 12-8 displays nominal efficiencies for standard and high efficient motors. To avoid overloading, it may be advantageous to use the next larger electric motor. Operating any electric motor below its rated load capacity decreases the electric to mechanical energy efficiency.

Table 12-8 Nominal efficiencies for standard and high efficiency electric motors (courtesy of Marathon Electric, Wausau, Wisconsin)

Horsepower	Standard efficiency motor nominal efficiency (%)			High efficiency motor nominal efficiency (%)		
	full load	3/4 load	1/2 load	full load	3/4 load	1/2 load
3,600 rpm, 460 volt						
5	84.0	86.0	84.5	89.5	89.5	88.5
10	84.0	85.0	82.0	91.7	92.4	91.7
20	86.5	86.5	83.5	92.4	92.4	92.4
30	87.5	87.5	85.5	93.6	94.1	93.6
40	91.0	91.0	89.0	94.1	94.1	93.6
50	91.7	91.7	91.0	94.5	95.0	94.5
75	93.6	93.6	92.4	95.0	94.5	95.0
100	94.1	94.1	93.0	95.4	95.4	95.0
150	93.6	93.0	91.7	95.4	95.4	95.0
1,800 rpm, 460 volt						
5	85.5	83.5	81.5	—	—	—
10	87.5	88.5	87.5	—	—	—
20	89.5	90.2	89.0	92.4	93.0	93.0
30	89.5	88.5	80.5	94.1	94.1	94.1
40	90.2	89.5	88.0	94.5	94.5	94.5
50	91.0	91.0	90.2	94.5	95.0	94.5
75	93.0	93.0	91.7	95.4	95.8	95.8
100	92.4	93.0	92.4	95.8	95.8	95.8
150	94.1	93.6	92.4	96.2	96.2	95.8

Motor speed (rpm) is rated at no load and full load. The difference between no load and full load speeds for three-phase motors is small. For example: 1,800 rpm at no load and 1,760 rpm at full load. Motor speed is controlled by cycles per second of alternating current.

(d) Internal combustion engines

Engines generally operate more efficiently when used at 75 to 100 percent of their continuous rated horsepower. The manufacturer's recommendation for loading should be followed. If internal combustion engines are to operate efficiently, a good maintenance program should also be followed.

The horsepower rating applicable to a pump engine is the continuous horsepower available at the output shaft. It is common practice for engine manufacturers to list power ratings without cooling fans (and other required accessories), which can consume 5 to 8 percent of engine power. When a radiator cooled engine is used, this loss or extra power use must be taken into account. Attachments can be obtained that circulate irrigation water to cool the engine and thus eliminate fan energy loss. Engine efficiency can be changed as much as 5 percent with some engine modifications.

Altitude, humidity, and air temperature affect engine power output. For naturally aspirated (nonturbocharged) engines, it is standard industry practice to derate engine power output by 3.5 percent for each 1,000 feet above a 500-foot altitude and 1.0 percent for each 10 °F above 85 °F.

(e) Pump installation

A flow meter, or other water measuring device, and a properly operating pressure gauge should be installed at each pump site to monitor pump operation. This information can be invaluable for determining when pump efficiency is starting to drop so that corrective actions can be taken. Typically a 5 percent drop in pressure or volume output is a signal that pump (or well) maintenance should be considered. A sudden drop in line pressure could indicate a break in the pipeline or other abrupt change in system. A position change of the distribution or application system can also cause a pressure variation at the pump; i.e., a pivot lateral mov-

ing from a downhill position to an uphill position. A flow (rate and volume) meter can be of great value for making some water management decisions.

Foot valves on suction pipelines prevent backflow from occurring when the pump is shut off. Without a foot valve, the suction pipe is drained each time the pump is shut off, allowing the pipe to be filled with air. When air enters the suction side of the pipeline, generally due to improper installation, flow is restricted. Air in the pump can also cause cavitation to accelerate pump wear. Higher velocities (3 to 5 ft/s) tend to move suspended air through the pipeline. Backflow prevention valves and air-vacuum release valves located just downstream of pump discharge should also be considered. They help prevent reverse flows through the pump and potential collapse of discharge pipelines, especially where pumping uphill. All these devices just discussed should be considered a part of any pump installation.

How a pump is installed can significantly affect overall operating efficiency. Unfortunately many installations are not adequately installed. The following specific information relates to individual pump types.

(1) Centrifugal pumps

Centrifugal pump suction pipeline must be free of air leaks and must not have high points that can cause air accumulation or restricted flow. Also pump priming is difficult when suction pipeline air leaks are excessive. Figure 12-9 illustrates pump installation considerations. Figure 12-10 illustrates priming arrangements and foot valve needs for centrifugal pumps.

Figure 12-9 Installation considerations for centrifugal pumps (courtesy of Cornell Pump Company)

Discharge piping—Good practice

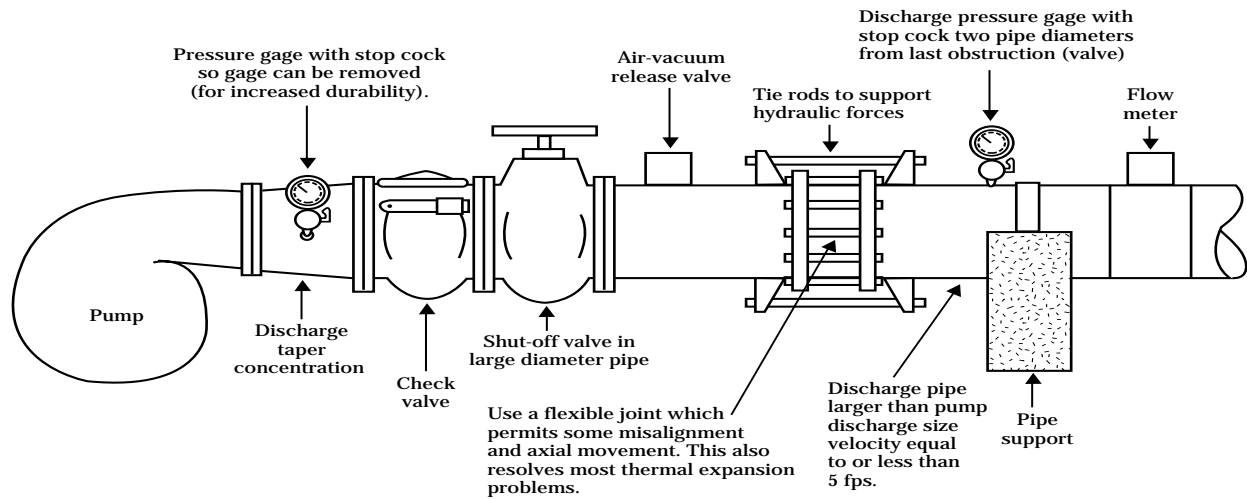

Note: A vacuum gage on the pump suction side can indicate whether the intake screen is becoming plugged. A pressure gage will not work since pressure on the pump suction side is negative.

Figure 12-9 Installation considerations for centrifugal pumps—Continued

Discharge piping—Poor practice

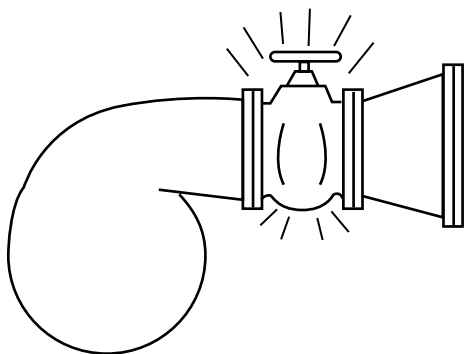

Do not design a system to operate with the discharge valve partly closed.

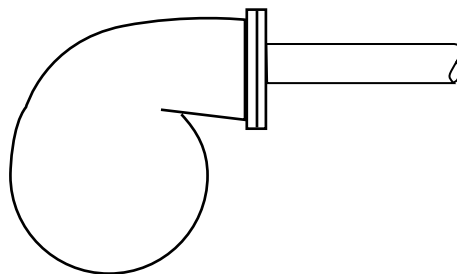

Do not use small discharge valves, piping and fittings. This adds to friction loss.

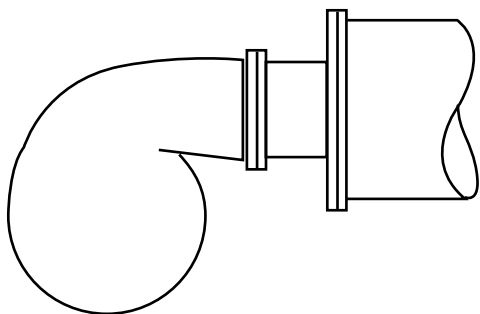

Valve on small diameter pipe

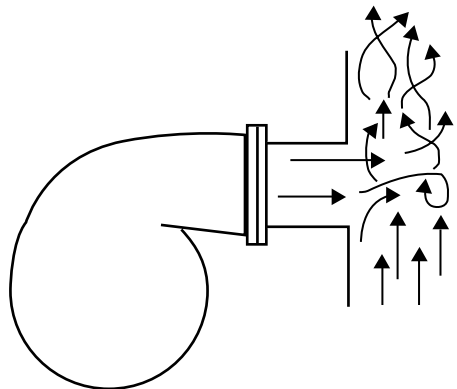

Avoid discharging at a right angle into a manifold flow. A Y connection in the direction of flow is preferred.

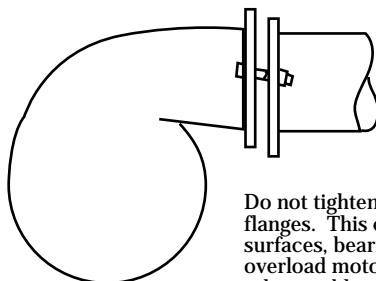
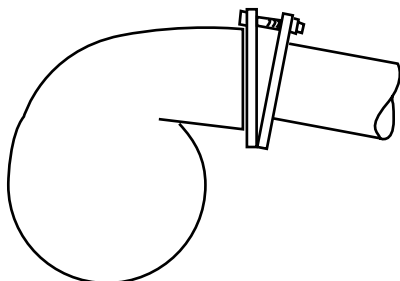

Do not tighten bolts on misaligned flanges. This can damage wear surfaces, bearings, coupling, and overload motor, and can create other problems.

Figure 12-9 Installation considerations for centrifugal pumps—Continued

Discharge and suction fittings—Good practice

Discharge fittings**Suction fittings**

Figure 12-10 Priming arrangements for centrifugal pumps (courtesy of Cornell Pump Company)

Vacuum priming

In a manually cycled system, the discharge valve must be closed before priming.

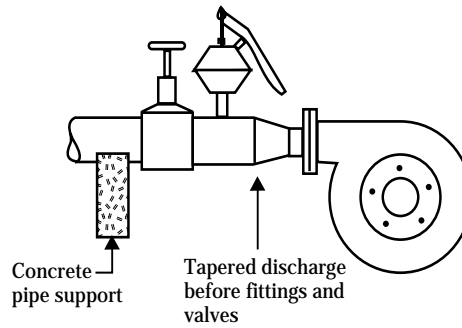
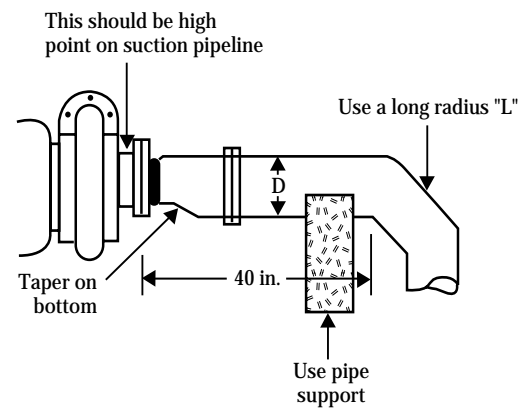
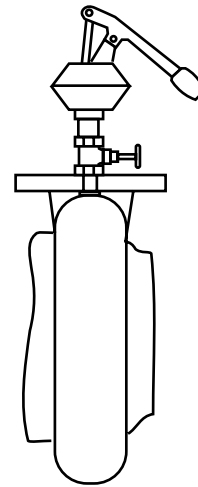
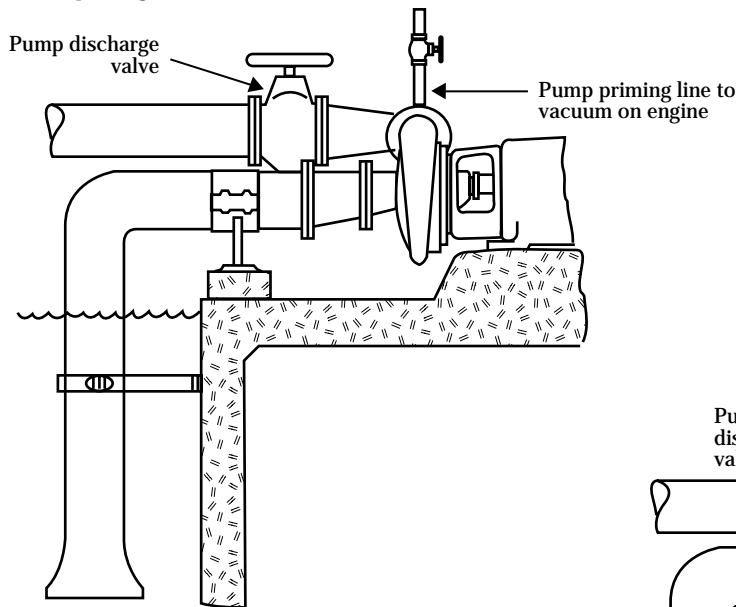

Hand primer

Prime the pump before start-up.

Foot valve

Use an auxiliary supply line to fill the pump and suction pipe. The system should have a foot valve. If the discharge valve is closed, be sure the air is vented off during filling. Close vent and supply valves before the pump is started.

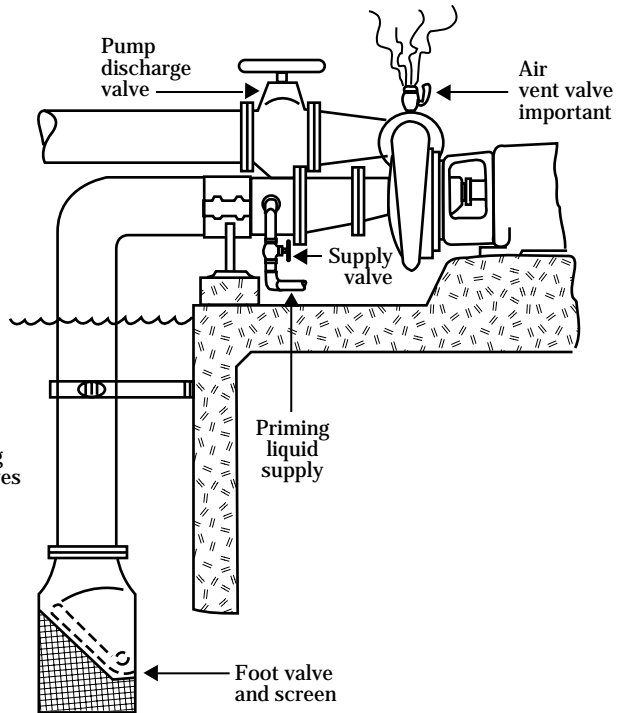

(i) Change of performance—Altering the speed or impeller diameter of a centrifugal pump changes the performance of the unit. Rules relating performance with change in speed and for change in diameter apply for all types of centrifugal pumps. Example 12-1 illustrates these rules.

A constant diameter impeller:

- Pump capacity varies directly as speed.
- Head varies as the square of the speed.
- Horsepower input varies as the cube of the speed.

At constant speed:

- Capacity varies directly with the impeller diameter.
- Head varies as the square of the impeller diameter.
- Horsepower varies as the cube of the impeller diameter.

Rules for impeller diameter are used in a similar way. By computing the performance of the pump at a number of points along its characteristic curve, a new set of curves can be plotted. These curves typically agree fairly close with actual pump performance curves and can be sufficient for planning purposes.

Standard diameter impellers for centrifugal pumps can be trimmed (reducing impeller diameter) to meet a specific head requirement. Impellers are trimmed to reduce operating pressure and energy requirements. Trimming is more cost effective than replacing the pump. However, the amount of impeller trim which occur and still maintain good pump performance is limited. Manufacturers can provide performance curves for the newly trimmed impeller.

Although horizontal shaft centrifugal pumps are most common, a vertical shaft, or vertical shaft and submerged pump volute can be used. Submerged vertical shaft centrifugals operate similar to vertical turbines.

Example 12-1 Change of performance rules

Given:

A pump delivering 500 gpm at 1,150 rpm and 50 ft head requires 10 hp.

Determine:

Capacity, head, and power input of this unit if motor speed is increased to 1,750 rpm.

Solution:

New capacity is in the same ratio as the speeds:

$$\frac{1,750}{1,150} \times 500 \text{ gpm} = 760 \text{ gpm}$$

New head is in the same ratio of the speeds squared:

$$\frac{1,750^2}{1,150^2} \times 50 \text{ ft} = 116 \text{ ft}$$

New horsepower is the ratio of the speeds cubed:

$$\frac{1,750^3}{1,150^3} \times 10 \text{ hp} = 35 \text{ hp}$$

(2) Propeller/mixed flow pumps

The sump in which a propeller or mixed flow pump is installed must be a part of the pumping plant design and installation. Figure 12-11 displays important sump dimensions versus flow. Figure 12-12 displays sump dimensions nomenclature and pump arrangement.

The sump entrance must be large enough to pass the design discharge to the pump(s) without restrictions. Velocities within the sump from the entrance toward the pump should be less than 1 foot per second. The shape and dimensions of the sump should be such to supply an even distribution of flow to the suction

intake of the pump(s). Improperly designed or installed sumps (pump wells) can seriously affect pump performance. Improper sump design can result in the formation of vortexes, turbulence, and high or misdirected velocities—any of which can seriously affect performance. Vibration, excessive noise, surging, cavitation, excessive wear on shaft and bearings, reduced capacity, and excessive load on the pump motor can result. See NEH, Part 623 (Section 15, Irrigation), Chapter 7, Irrigation Pumps, for additional information and example layouts including sump dimensions versus flow for single and multiple pump installations.

Figure 12-11 Sump dimensions versus flow for vertical propeller pump installation

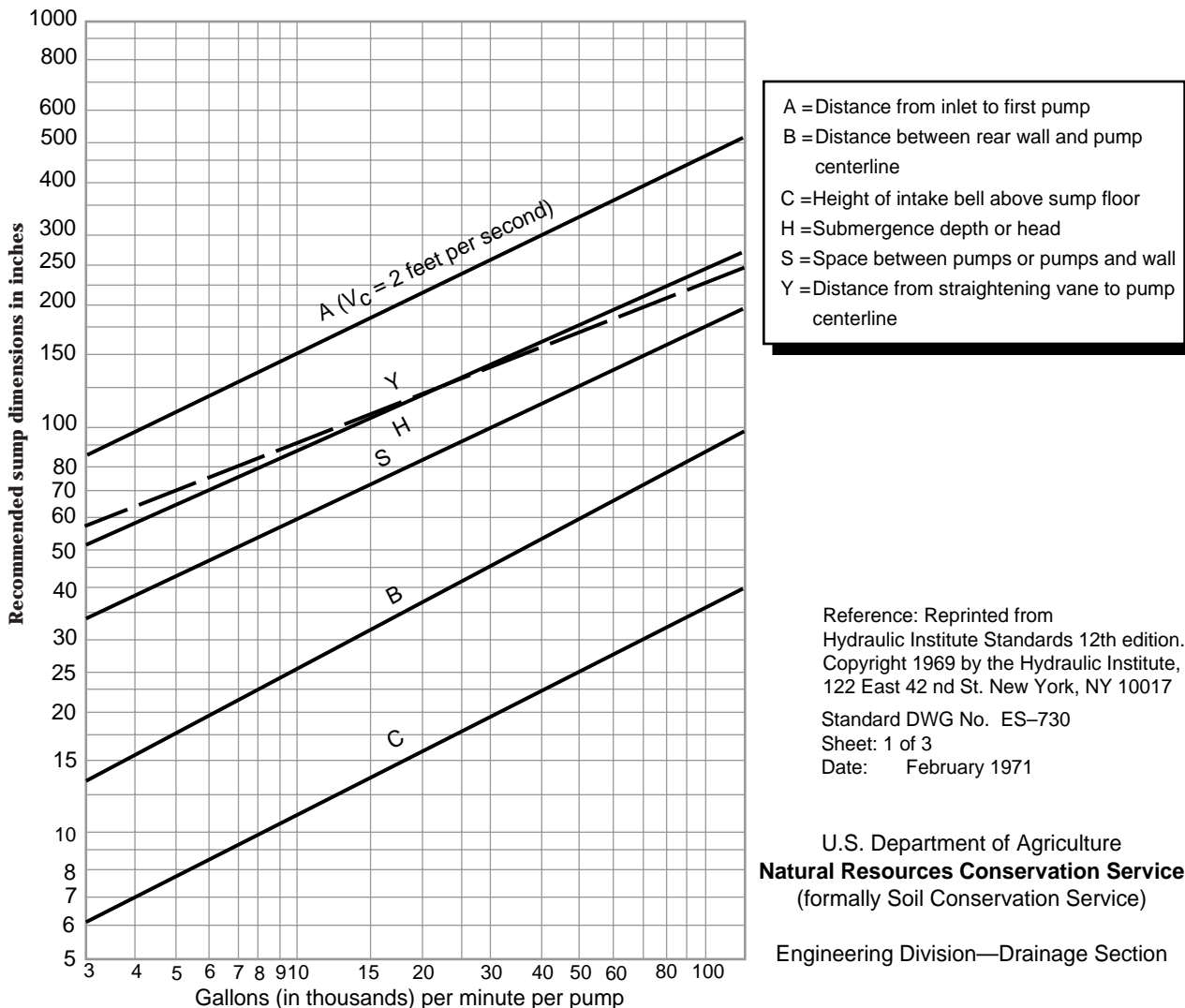
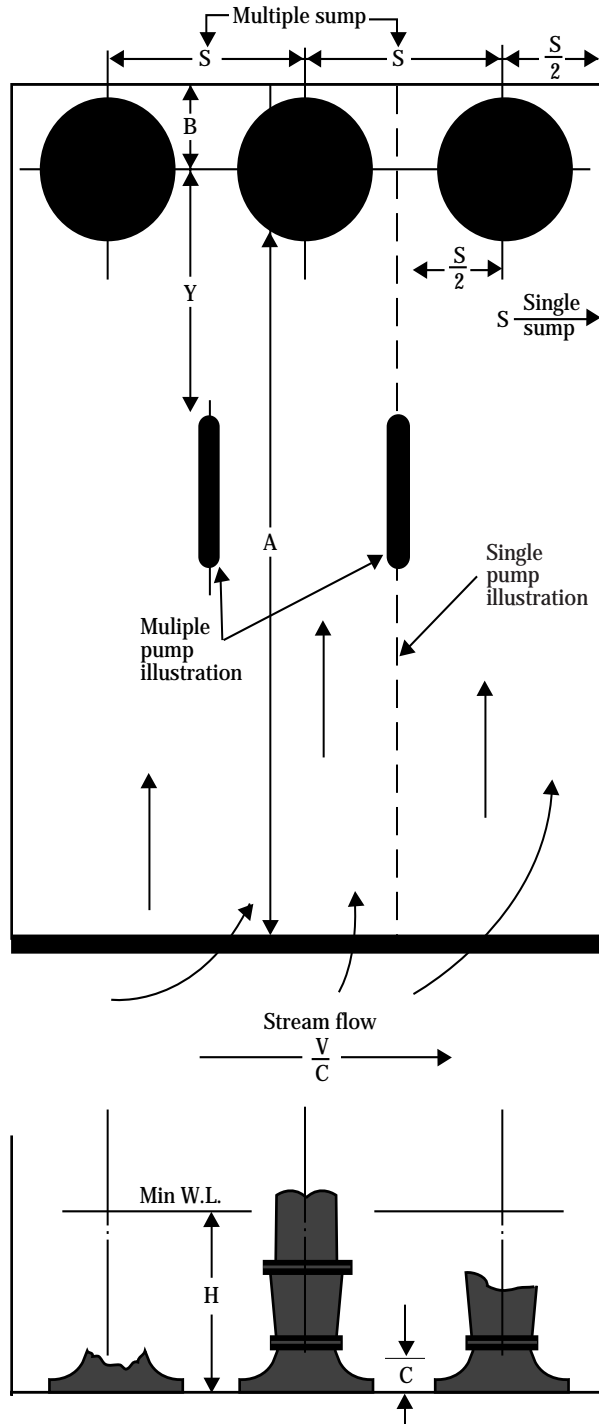

Figure 12-12 Nomenclature for sump dimensions and pump arrangement for vertical propeller pump installation



652.1204 Pipeline efficiency

Energy is required to offset friction loss in a pipeline. Friction loss in a pipeline increases approximately in proportion to the square of the pipeline water velocity. Flow rate and pipe size both affect velocity. Pipe material also affects friction loss. Energy required can be reduced by increasing pipe size, reducing flow rate, changing pipe material, or any combination of these.

Table 12-9 displays estimated friction loss for various combinations of pipe sizes (4- to 12-inch diameter), flow rates (100 to 2,000 gpm), and pipe material (steel, aluminum, and plastic). If a more accurate friction loss is necessary, use tables that provide for varying inside diameters, wall thickness and varying friction coefficients.

Table 12-9 Pipe friction loss comparison table for welded steel, aluminum, and plastic pipe

Gallons per minute	Pipe (ft/100-ft of pipe)														
	4-inch			6-inch			8-inch			10-inch			12-inch		
	steel	alum.	plas.	steel	alum.	plas.	steel	alum.	plas.	steel	alum.	plas.	steel	alum.	plas.
100	1.25	.81	.55	.17	.11	.08									
150	3.00	1.73	1.18	.36	.23	.16	.09	.06							
200	4.39	3.65	2.01	.62	.42	.28	.15	.10	.07	.05					
300	9.47	6.35	4.27	1.32	.92	.60	.32	.21	.14	.11	.07	.05	.05	.05	
350		8.32	5.43	1.73	1.16	.79	.43	.28	.19	.14	.09	.06	.06		
400		10.74	7.39	2.31	1.50	1.02	.55	.37	.25	.18	.12	.09	.08	.05	
450			9.24	2.77	1.85	1.27	.69	.45	.32	.23	.15	.11	.10	.06	
500			11.55	3.47	2.31	1.55	.83	.55	.39	.28	.18	.13	.12	.08	.05
550				4.11	2.66	1.85	.99	.66	.46	.33	.22	.16	.13	.09	.06
600				4.85	3.19	2.19	1.18	.79	.54	.39	.25	.18	.17	.11	.07
650				5.54	3.70	2.54	1.39	.90	.63	.46	.30	.21	.19	.13	.09
700				6.47	4.27	2.89	1.62	1.04	.72	.53	.35	.24	.22	.15	.10
750				7.39	4.85	3.35	1.80	1.16	.82	.60	.39	.28	.25	.16	.11
800				8.32	5.54	3.70	2.02	1.27	.89	.68	.42	.31	.28	.18	.13
850				9.24	6.12	4.16	2.31	1.50	1.03	.76	.51	.35	.32	.21	.15
900				10.16	6.93	4.62	2.54	1.67	1.16	.84	.55	.39	.35	.23	.16
950				11.55	7.39	5.20	2.82	1.85	1.35	.95	.61	.43	.39	.25	.18
1000					8.32	5.66	3.07	2.02	1.40	1.06	.65	.48	.43	.28	.19
1050					9.01	6.24	3.35	2.25	1.50	1.12	.74	.51	.46	.31	.21
1100					9.93	6.93	3.70	2.54	1.65	1.24	.81	.56	.51	.33	.23
1200					11.55	8.09	4.39	2.72	1.96	1.46	.95	.66	.60	.39	.27
1300						9.24	5.08	3.44	2.28	1.69	1.11	.76	.71	.46	.31
1400						10.51	5.89	3.81	2.59	1.96	1.25	.88	.81	.52	.37
1500							6.58	4.39	2.93	2.19	1.47	1.00	.92	.60	.42
1600							7.39	4.97	3.29	2.54	1.60	1.12	1.04	.67	.46
1700							8.32	5.54	3.70	2.77	1.85	1.27	1.16	.76	.52
1800							9.24	6.12	4.13	3.10	2.08	1.39	1.29	.84	.57
1900							10.16	6.81	4.62	3.47	2.31	1.55	1.46	.95	.65
2000							11.32	7.39	5.08	3.80	2.54	1.70	1.59	1.04	.69

652.1205 Alternative energy reduction devices

(This section was from information in Irrigation Pumping Plants, University of California, Davis, CA, 1994.)

When it is desirable to reduce total dynamic head and pump discharge, using the existing motor and pump, variable or adjustable frequency drives for electric motors are available. These devices allow the rotations per minute (rpm), or speed, of the motor to be reduced. Horsepower is also reduced. The drive consists of a converter that changes AC power to DC power and an inverter that changes DC power into adjustable frequency AC power. As the frequency of the power is decreased, the power to the motor and the motor rpm are both reduced. This decrease in motor rpm can substantially reduce the pump horsepower demand since the pump horsepower demand is proportional to the pump rpm cubed. A small change in rpm then causes a significant change in pump horsepower demand. Figure 12-13 shows that reducing the rpm by about 20 percent reduces horsepower demand by about 50 percent. Reducing the rpm from 1,770 down to 1,400, for example, decreases the horsepower demand of a 100-horsepower pump to 50 horsepower.

The pump output, capacity, and the total dynamic head, is also determined by the rpm. The capacity is proportional to the rpm, while the total head is proportional to the rpm squared. Figure 12-13 also illustrates these relationships. For example, a 20 percent reduction in rpm decreases the pump capacity by 20 percent and the total head by nearly 38 percent.

Because of these relationships, adjusting the pump rpm may not yield the same total dynamic head and discharge capacity obtained under a throttled (partly closed valve downstream of pump) condition. The actual total head and capacity at a particular rpm depend on the impeller design, which defines the relationship between total head and pump capacity.

Variable frequency drives must be protected from adverse environmental conditions, including dampness, dust, and extremes in temperature and altitude. One manufacturer recommends installations where

ambient air temperature is maintained between 14 and 122 degrees Fahrenheit, humidity is maintained below 90 percent, and the elevation is below 3,300 feet.

Variable frequency drives can also affect the efficiency of the pumping plant. The lower the rpm, the less efficient the motor and the variable frequency drive. Down to about 50 percent of the maximum rpm, the drive efficiency may decrease only slightly, but at lower rpm's the efficiency of the drive falls dramatically. Manufacturers can supply characteristic curves for specific diameter and width impellers at reduced rpm's.

Variable speed drives eliminate energy waste caused by a throttled pump by producing a discharge similar to that of a throttled pump, but at a lower horsepower. The economic affect of these devices depends on the decrease in horsepower demand, operating time, electric energy costs, and cost (purchase, installation and maintenance) of the variable speed drive. The benefit of the variable speed drive is the savings in annual electric energy cost, which amounts to the difference in energy costs between the constant rpm operation and the reduced speed operation. Permanent required pressure (energy) is less costly and preferred.

Figure 12-13 Ratio of pump characteristics to pump rpm

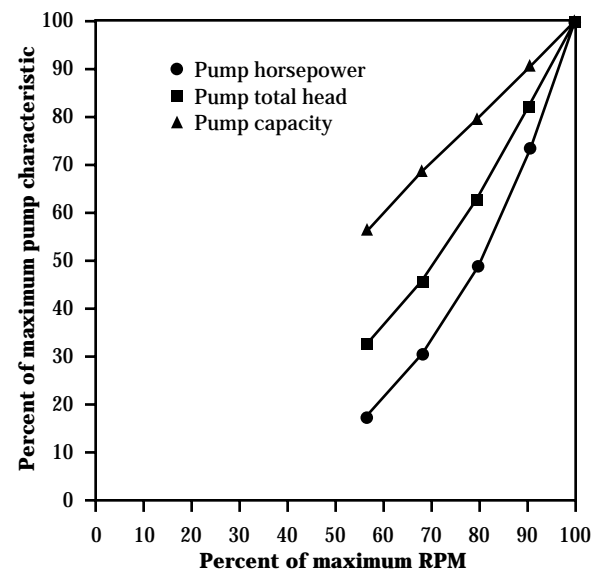

652.1206 Other energy sources for pumping water

Wind has been widely used for many years as a power source to provide domestic and livestock water. It can also be used for direct pumping of irrigation water or to generate electric energy to power electric motors for pumping. Where wind is intermittent, water can be pumped to storage reservoirs where it can then be available for irrigation when needed. Area and crops irrigated should be balanced against total water supply available including conveyance and storage losses.

Solar energy using photoelectric cells can be used to charge batteries for electric motor operation or can be used to directly operate electric motors. The size of the energy generation system for both wind and solar power can vary widely depending on requirements for water capacity and operating head.

Hydraulic rams (sometimes called hydro-ram pumps) are devices for pumping water using the water's kinetic energy. Typically, a smaller flow rate (delivery) is raised to a higher elevation by using kinetic energy from a higher flow rate (supply). Maintenance is generally low, and the useful life is long. However, only a few manufacturers produce these devices.

Air pumps can be used to raise water. Intermittent bubbles of air are released at the inlet of a vertical small diameter pipeline. As the bubble rises to the surface, a small quantity of water is carried above the bubble.

652.1207 State supplement

WA652.1207 State Supplement

Energy Use and Conservation

Energy loss from leaks does add up. As an example of the power cost caused by a leak, calculate the cost with and without the loss. Assume an electric pump with a total flow of 800 gpm and a head of 100 ft. The power required to pump this is:

$$Hp = Q \text{ gpm} * \text{Head ft} / 3960$$

$$Hp = 800 \text{ gpm} * 100 \text{ ft} / 3960$$

$$Hp = 20.2$$

The pump efficiency varies by flow rate and manufacturers. The pump curve for the make and model would be the first source of this. Assume the overall efficiency of the pump and motor is 70%. This means that the horse power needed at the pump would be:

$$Hp_{\text{required}} = 20.2 / 0.70$$

$$Hp_{\text{required}} = 28.86$$

Assuming the system operates for 1500 hours during the season the hp-hrs would be:

$$Hp\text{-hrs} = 28.86 * 1500$$

$$Hp\text{-hrs} = 43285.7$$

To convert to Kilowatts multiply the Hp-hrs by 0.746. The Kw-hrs would be:

$$Kw\text{-hrs} = 43285.7 * .746$$

$$Kw - \text{hrs} = 32291.1$$

The location is a site with energy costs of 0.04 \$/kw-hr.

The annual cost to operate the pump would be:

$$\text{Seasonal cost} = 32291.1 \text{ kw-hr} * 0.04 \text{ $/kw-hr}$$

$$\text{Seasonal Cost} = \$ 1291.65$$

Now if there was a leak in the system that is flowing at a rate of 8 gpm (1% of the total flow), what would the increase in seasonal power cost be?

The increase in pumping cost would be 1% of 1291 or \$12.91. This is fairly small, but 8 gpm is a very tiny leak. The point is that even a small flow adds up, over the time of irrigation per season. Depending on the overall leak amount, there could also be a loss in distribution uniformity in the irrigation system resulting in a decrease in crop yield and/or quality.

Monitor the irrigation during the season to determine changes in the flow. This could be done with a flow meter, pressure gauge, or if necessary, the power meter. Reading changes with any or all of the above would show potential leaks or plugging of nozzles or outlets.

Chapter 13

Quality of Water Supply

Contents:	652.1300	General	13-1
	652.1301	Effect of water quality on irrigation system, soil, and crops	13-2
	(a)	Salinity and sodicity	13-2
	(b)	Infiltration and permeability	13-11
	(c)	Toxicity	13-11
	(d)	Sediment	13-12
	(e)	Agricultural, industrial, and municipal wastes	13-12
	(g)	Miscellaneous	13-15
	652.1302	State supplement	13-18

Tables	Table 13-1	Irrigation water quality guidelines	13-3
	Table 13-2	Determinations normally required to evaluate irrigation water quality problems	13-4
	Table 13-3	Salt tolerance of selected crops	13-6
	Table 13-4	High salt-tolerant plants	13-17

Figures	Figure 13-1	Divisions for classifying crop tolerance to salinity	13-5
	Figure 13-2	Threshold values of sodium adsorption ratio of topsoil and electrical conductivity of infiltrating water associated with the likelihood of substantial losses in permeability	13-11

652.1300 General

When determining water availability for irrigation, information is required on its quality. Water quality must be evaluated on its suitability for the intended use. Often water (and effluent) use is based on the desires of the decisionmaker and not the crop. Specific uses can have different water quality needs. The irrigator must know the quality of water used for irrigation. If contaminants are present, the type and concentration must be determined.

Irrigation water used for agriculture can contain undesirable contaminants, such as dissolved salts (salinity and sodicity), suspended sediment, gypsum, naturally occurring toxic elements, nematodes, and water borne diseases. Tailwater (runoff) from surface irrigation systems can be reused as a water supply, but can also contain contaminants, such as sediment, agricultural fertilizers, pesticides, and organic material. Discharge from subsurface drainage systems, treated municipal sewage, industrial wastes, agricultural food processing, and wastes from confined livestock and fish feeding operations can also be used to supplement existing supplies.

Disposal of wastes on cropland as plant nutrients and soil amendments is encouraged by regulatory agencies. Naturally occurring microbial activity helps break down (metabolize) organic solids and contaminants. Caution must be exercised, however, when applying treated municipal sewage and industrial wastes to cropland. Depending on treatment level, these sources can contain pathogens, viruses, coliforms, salts, toxic metals, or acids. Geothermal (hot) water can also be used for irrigation, but generally must be cooled by sprinkling or storage before being applied to crops. It can also contain elements toxic to soils and plants (i.e., boron, chloride, sodium, sulfur, and toxic metals). Cold water can retard plant growth for short periods of time.

Good quality water promotes maximum yield if good soil and water management practices are used. With lesser quality water, soil and cropping problems can be expected, unless appropriate management practices are adopted. It may be desirable to use low quality water for irrigation of specific crops in specific areas rather than allow low quality water to discharge

into public surface water. However, high quality water may be required for irrigating certain specialty crops because of required crop quality or soil contaminant standards or to meet interstate transportation and marketing requirements. Nursery potted plants is one example.

Typically lesser quality water can be used to irrigate growing crops than is required for germination and sprouting. Generally poor quality water should not be mixed with high quality water. On the surface, mixing high quality water with low quality water may seem to improve the low water quality. In reality a poor water quality still exists, and using it can allow contaminants (i.e., salts) to accumulate in the soil profile throughout the irrigation season. As an example, with proper salinity management, poorer quality water can be used to grow many crops during most of the growing season. The high quality water is then available for germination, sprouting, and leaching of accumulated salts, as well as meeting plant water needs for low salt-tolerant crops.

Annual leaching can be eliminated by growing crops less tolerant to toxic elements early in the crop rotation following leaching. As toxic elements accumulate (usually in the soil profile), more salt-tolerant crops are grown. Leaching is performed following the last crop in the rotation. Crop rotation examples are:

- beans, corn, wheat, and barley
- lettuce, cantaloupe, sorghum, and cotton
- beans, cauliflower, cucumber, broccoli, and squash

Physical contaminants and organic particles can adversely affect some irrigation systems. They also present challenges for design of screening devices that will satisfactorily remove contaminants. Physical contaminants include suspended debris, moss, and submersed aquatic plants. Algae and bacterial slimes are organic particles.

Particulates, including small aquatic organisms, can plug nozzles and orifices in sprinkle and micro irrigation systems. Floating trash and debris may cause trouble in systems that discharge water through larger gates or openings. Small aquatic organisms including snails, freshwater clams, and other invertebrates can plug pump screens if large numbers congregate at the intake. Different sizes and types of screening and filtration devices are required to prevent these problems.

Suspended and floating debris in irrigation water can cause malfunction of flow meters, measuring devices, plugging of siphon tubes, and gates in gated pipe. Debris can also accumulate within and potentially plug almost any water control structure. Good irrigation water management requires complete control of water delivery.

Water suitability for irrigation is determined by the potential to cause soil, plant, or management problems. Appropriate management practices should be selected to avoid unacceptable levels of biomass or yield reduction. Suitability must be evaluated at the farm level for specific use and potential hazard to crops and personal health. Available farm management and the farm situation must be considered. Removing larger sized floating debris by irrigation organization facilities (trash racks, rotating screens) may be desirable.

Water quality is a major consideration when selecting irrigation method. Adequate data on water quality is essential in the selection process. All irrigation water contains some dissolved solids (salts). Significant build-up of these salts can occur without proper irrigation method selection, operation, and management. The leaching capability of the irrigation method is a consideration. It becomes increasingly important as salt content of the irrigation water increases.

652.1301 Effect of water quality on irrigation system, soil, and crops

Suitability of water for irrigation depends on the total amount and kind of salts, ions and other toxic elements in the water. Suitability must also consider crops grown, irrigation water management, cultural practices, and climate factors. Guidelines for evaluating water quality for irrigation are given in table 13-1. These guidelines are limited to water quality parameters that are normally encountered and that materially affect crop production. Laboratory determinations and calculations needed to use the guidelines are displayed in table 13-2.

Additional information and details on effects of specific ions are provided in the National Engineering Handbook (NEH), Part 623, Chapter 2, Irrigation Water Requirements. Also see American Society of Civil Engineers (ASCE) Report 71, Agricultural Salinity Assessment and Management.

(a) Salinity and sodicity

Salinity or sodicity relates to water quality if the total quantity of salts in the irrigation water is high enough that salts accumulate in the crop root zone or on the plant and to the extent that crop growth and yield are affected. Where excessive soluble salts accumulate in the root zone, plants have increasing difficulty in extracting water from the soil profile. Reduced water uptake by the plant can result in slow or reduced growth. This can cause the appearance of a drought condition (i.e., plant wilting) even with relative high soil moisture conditions. Crops have different salinity and sodicity tolerance levels, plus effects of salinity and sodicity can vary with growth stage. Tolerance to salinity or sodicity can be very low at germination and small seedling stage, but usually increases as the plant grows and matures.

Table 13-1 Irrigation water quality guidelines ^{1/}

Potential irrigation water quality problem	Describing parameter	----- Degree of restriction on use -----		
		None	Slight to moderate	Severe
Salinity (affects crop water availability)				
	EC _i ^{2/} , mmho/cm or TDS ^{3/} , mg/L	< 0.7 < 450	0.7 – 3.0 450 – 2,000	> 3.0 > 2,000
Infiltration (affects water infiltration rate— evaluated by using EC _i and SAR together) ^{4/}				
	SAR		EC _i , mmho/cm	
	0 – 3	> 0.7	0.7 – 0.2	< 0.2
	3 – 6	> 1.2	1.2 – 0.3	< 0.3
	6 – 12	> 1.9	1.9 – 0.5	< 0.5
	12 – 20	> 2.9	2.9 – 1.3	< 1.3
	20 – 40	> 5.0	5.0 – 2.9	< 2.9
Specific ion toxicity (affects sensitive crops)				
Sodium (Na) ^{5/}				
	surface irrigation	SAR	< 3	3 – 9
	sprinkler irrigation	meq/L	< 3	> 3
Chloride (Cl) ^{5/}				
	surface irrigation	meq/L	< 4	4 – 10
	sprinkler irrigation	meq/L	< 3	> 3
Boron (B) ^{6/}				
		meq/L	< 0.7	0.7 – 3.0
Miscellaneous effects (affects susceptible crops)				
Bicarbonate (HCO ₃) (overhead sprinkling only)				
		meq/L	< 1.5	1.5 – 8.5

1/ Adapted from Ayers and Westcot (1985), FAO 29, revision 1.

2/ EC_i means electrical conductivity of the irrigation water reported in mmho/cm at 77 °F (25 °C).

3/ TDS means total dissolved solids reported in mg/L.

4/ SAR means sodium adsorption ratio. At a given SAR, infiltration rate increases as water salinity increases.

5/ For surface irrigation—Most tree crops and woody plants are sensitive to sodium and chloride, so the values shown should be used. Because most annual crops are not sensitive, the salinity tolerance values in table 2-34 should be used. For chloride tolerance of selected fruit crops, see table 2-35 in NEH, Part 623, Chapter 2, Irrigation Water Requirements. With overhead sprinkler irrigation and low humidity (<30%), sodium and chloride may be absorbed through the leaves of sensitive crops. For crop sensitivity to absorption, see table 2-36 in NEH, part 623, chapter 2.

6/ For boron tolerances see tables 2-37 and 2-38 in NEH, Part 623, Chapter 2, Irrigation Water Requirements.

Electrical conductivity of the irrigation water (EC_i) is used as a measure of salinity. Electrical conductivity of the saturated soil extract (EC_e) is a measure of soil water salinity which affects the availability of water for plant growth. The electrical conductivity of irrigation water plus infiltrated precipitation water (EC_{aw}) affects the saturated soil extract. Figure 13-1 displays divisions for classifying crop tolerance to salinity. Table 13-3 displays salinity tolerance of selected crops and projected yield decline. See discussion of salinity, sodicity, and leaching in NEH, Part 623, Chapter 2, Irrigation Water Requirements.

SAR is used as a measure of sodium affected water and soil. A permeability problem occurs when the soil or water is relatively high in sodium, and low in calcium. Where exchangeable sodium is excessive, soil permeability is reduced for a given salinity level of the infiltrating water and soil pH. Low salinity and high pH also decrease soil permeability as much as sodium.

Table 13-2 Determinations normally required to evaluate irrigation water quality problems ^{1/}

Determination	Symbol	Valence	Unit of measure ^{2/}	Atomic weight	Usual range in irrigation water
Total salt content					
Electrical conductivity	EC	—	mmho/cm	—	0-3
Concentration or total dissolved solids	TDS	—	mg/L	—	0-2000
Sodium hazard					
Sodium adsorption ratio ^{3/}	SAR	—	—	—	0-15
Constituents					
Cations: Calcium	Ca	+2	meq/L	40.1	0-20
Magnesium	Mg	+2	meq/L	24.3	0-5
Sodium	Na	+1	meq/L	23.0	0-40
Anions: Bicarbonate	HCO ₃	-1	meq/L	61.0	0-10
Sulfate	SO ₄	-2	meq/L	96.1	0-20
Chloride	Cl	-1	meq/L	35.3	0-30
Trace elements					
Boron	B	—	mg/L	10.8	0-2
Acid/basic	pH	—	1-14	—	6.0-8.5

1/ Adapted from Ayers and Westcot (1985).

2/ Millimhos/cm (1 mmho/cm) referenced to 77 °F (25 °C).
mg/L = milligram per liter ≈ parts per million (ppm).
meq/L = milliequivalent per liter (mg/L ÷ equivalent weight = meq/L).

3/ SAR is calculated by the following equation, with each concentration reported in meq/L.

$$SAR = \frac{Na}{\sqrt{\frac{(Ca + Mg)}{2}}}$$

Figure 13-1 Divisions for classifying crop tolerance to salinity

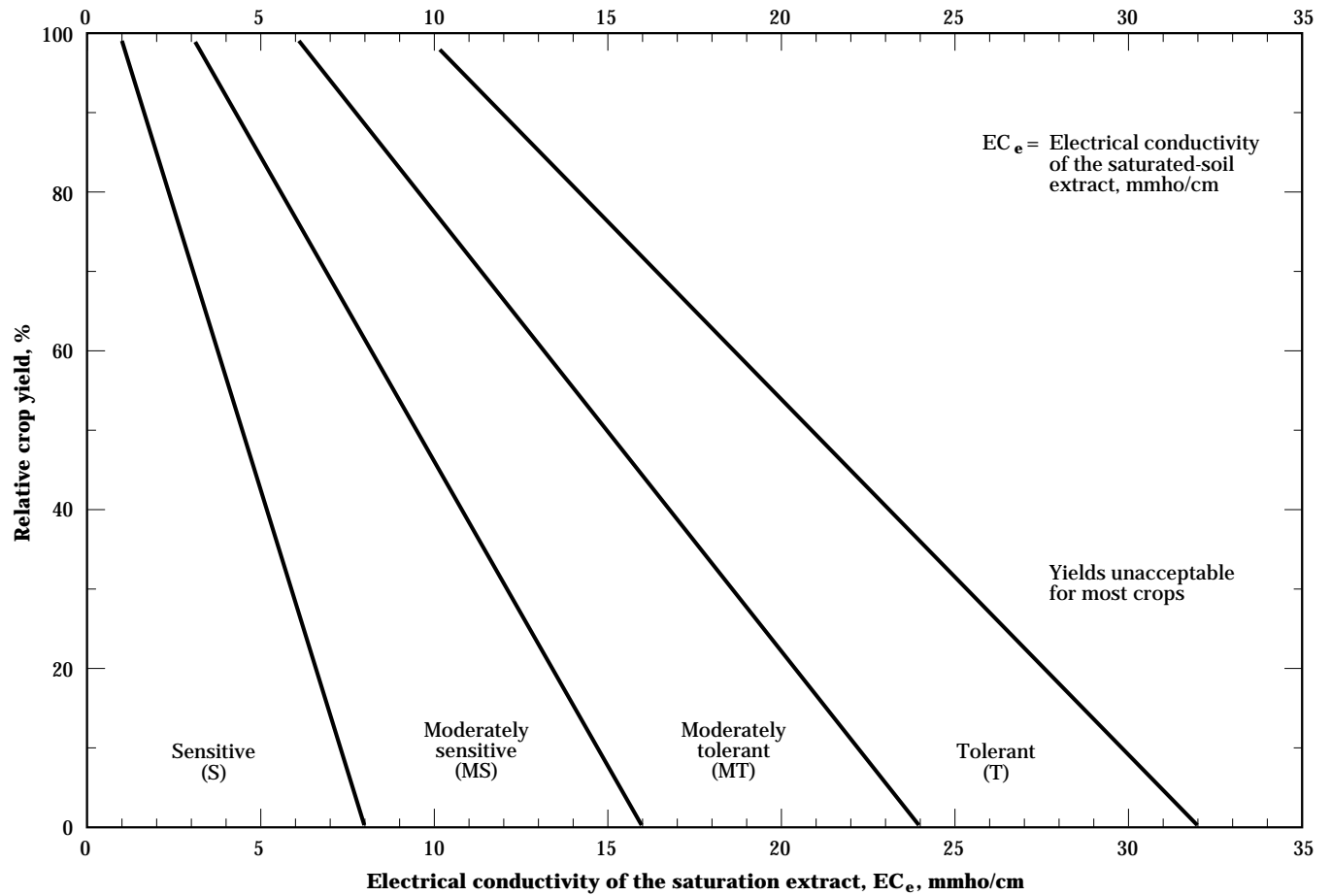

Table 13-3 Salt tolerance of selected crops ^{1/}

Common name	Botanical name	Salt tolerance threshold ^{2/}	Yield decline ^{3/}	Qualitative salt tolerance rating ^{4/}
		(EC _d)	(Y _d)	
		mmho/cm	% per mmho/cm	
Field crops				
Barley	<i>Hordeum vulgare</i>	8.0	5.0	T
Bean	<i>Phaseolus vulgaris</i>	1.0	19	S
Broad bean	<i>Vicia faba</i>	1.6	9.6	MS
Corn	<i>Zea Mays</i>	1.7	12	MS
Cotton	<i>Gossypium hirsutum</i>	7.7	5.2	T
Cowpea	<i>Vigna unguiculata</i>	4.9	12	MT
Flax	<i>Linum usitatissimum</i>	1.7	12	MS
Guar	<i>Cyamopsis tetragonoloba</i>	8.8	17.0	T
Millet, foxtail	<i>Setaria italica</i>	—	—	MS
Oats	<i>Avena sativa</i>	—	—	MT
Peanut	<i>Arachis hypogaea</i>	3.2	29	MS
Rice, paddy ^{5/}	<i>Oryza sativa</i>	3.0	12	S
Rye	<i>Secale cereale</i>	11.4	10.8	T
Safflower	<i>Carthamus tinctorius</i>	—	—	MT
Sesame	<i>Sesamum indicum</i>	—	—	S
Sorghum	<i>Sorghum bicolor</i>	6.8	16	MT
Soybean	<i>Glycine max</i>	5.0	20	MT
Sugar beet	<i>Beta vulgaris</i>	7.0	5.9	T
Sugarcane	<i>Saccharum officinarum</i>	1.7	5.9	MS
Sunflower	<i>Helianthus annuus</i>	—	—	MS
Triticale	<i>x Triticosecale</i>	6.1	2.5	T
Wheat	<i>Triticum aestivum</i>	6.0	7.1	MT
Wheat (semidwarf)	<i>T. aestivum</i>	8.6	3.0	T
Wheat, durum	<i>T. turgidum</i>	5.9	3.8	T
Grasses and forage crops				
Alfalfa	<i>Medicago sativa</i>	2.0	7.3	MS
Alkaligrass, nuttall	<i>Puccinellia airoides</i>	—	—	T
Alkali sacaton	<i>Sporobolus airoides</i>	—	—	T
Barley (forage)	<i>Hordeum vulgare</i>	6.0	7.1	MT
Bentgrass	<i>Agrostis stolonifera palustris</i>	—	—	MS
Bermudagrass	<i>Cynodon dactylon</i>	6.9	6.4	T
Bluestem, angleton	<i>Dichanthium aristatum</i>	—	—	MS
Brome, mountain	<i>Bromus marginatus</i>	—	—	MT
Brome, smooth	<i>B. inermis</i>	—	—	MS
Buffelgrass	<i>Cenchrus ciliaris</i>	—	—	MS
Burnet	<i>Poterium sanguisorba</i>	—	—	MS
Canarygrass, reed	<i>Phalaris arundinacea</i>	—	—	MT

See footnotes at end of table.

Table 13-3 Salt tolerance of selected crops^{1/}—Continued

Common name	Botanical name	Salt tolerance threshold ^{2/}	Yield decline ^{3/}	Qualitative salt tolerance rating ^{4/}
		(EC _d)	(Y _d)	
		mmho/cm	% per mmho/cm	
Grasses and forage crops (continued)				
Clover, alsike	<i>Trifolium hybridum</i>	1.5	12	MS
Clover, berseem	<i>T. alexandrinum</i>	1.5	5.7	MS
Clover, hubam	<i>Melilotus alba</i>	—	—	MT
Clover, ladino	<i>Trifolium repens</i>	1.5	12	MS
Clover, red	<i>T. pratense</i>	1.5	12	MS
Clover, strawberry	<i>T. fragiferum</i>	1.5	12	MS
Clover, sweet	<i>Melilotus</i>	—	—	MT
Clover, white Dutch	<i>Trifolium repens</i>	—	—	MS
Corn (forage)	<i>Zea mays</i>	1.8	7.4	MS
Cowpea (forage)	<i>Vigna unguiculata</i>	2.5	11	MS
Dallisgrass	<i>Paspalum dilatatum</i>	—	—	MS
Fescue, tall	<i>Festuca elatior</i>	3.9	5.3	MT
Fescue, meadow	<i>F. pratensis</i>	—	—	MT
Foxtail, meadow	<i>Alopecurus pratensis</i>	1.5	9.6	MS
Gramma, blue	<i>Bouteloua gracilis</i>	—	—	MS
Hardinggrass	<i>Phalaris tuberosa</i>	4.6	7.6	MT
Kallar grass	<i>Diplachne fusca</i>	—	—	T
Lovegrass	<i>Eragrostis sp.</i>	2.0	8.4	MS
Milkvetch, cicer	<i>Astragalus cicer</i>	—	—	MS
Oatgrass, tall	<i>Arrhenatherum, Danthonia</i>	—	—	MS
Oats (forage)	<i>Avena sativa</i>	—	—	MS
Orchardgrass	<i>Dactylis glomerata</i>	1.5	6.2	MS
Panicgrass, blue	<i>Panicum antidotale</i>	—	—	MT
Rape	<i>Brassica napus</i>	—	—	MT
Rescuegrass	<i>Bromus unioloides</i>	—	—	MT
Rhodesgrass	<i>Chloris gayana</i>	—	—	MT
Rye (forage)	<i>Secale cereale</i>	—	—	MS
Ryegrass, Italian	<i>Lolium italicum multiflorum</i>	—	—	MT
Ryegrass, perennial	<i>L. perenne</i>	5.6	7.6	MT
Saltgrass, desert	<i>Distichlis stricta</i>	—	—	T
Sesbania	<i>Sesbania exaltata</i>	2.3	7.0	MS
Siratro	<i>Macroptilium atropurpureum</i>	—	—	MS
Sphaerophysa	<i>Sphaerophysa salsula</i>	2.2	7.0	MS
Sudangrass	<i>Sorghum sudanense</i>	2.8	4.3	MT
Timothy	<i>Phleum pratense</i>	—	—	MS
Trefoil, big	<i>Lotus uliginosus</i>	2.3	19	MS
Trefoil, narrowleaf birdsfoot	<i>L. corniculatus tenuifolium</i>	5.0	10	MT
Trefoil, broadleaf birdsfoot	<i>L. corniculatus arvensis</i>	—	—	MT

See footnotes at end of table.

Table 13-3 Salt tolerance of selected crops^{1/}—Continued

Common name	Botanical name	Salt tolerance threshold ^{2/}	Yield decline ^{3/}	Qualitative salt tolerance rating ^{4/}
		(EC _d)	(Y _d)	
		mmho/cm	% per mmho/cm	
Grasses and forage crops (continued)				
Vetch, common	<i>Vicia angustifolia</i>	3.0	11	MS
Wheat (forage)	<i>Triticum aestivum</i>	4.5	2.6	MT
Wheat, durum (forage)	<i>T. turgidum</i>	2.1	2.5	MT
Wheatgrass, standard crested	<i>Agropyron sibiricum</i>	3.5	4.0	MT
Wheatgrass, fairway crested	<i>A. cristatum</i>	7.5	6.9	T
Wheatgrass, intermediate	<i>A. intermedium</i>	—	—	MT
Wheatgrass, slender	<i>A. trachycaulum</i>	—	—	MT
Wheatgrass, tall	<i>A. elongatum</i>	7.5	4.2	T
Wheatgrass, western	<i>A. smithii</i>	—	—	MT
Wildrye, Altai	<i>Elymus angustus</i>	—	—	T
Wildrye, beardless	<i>E. triticooides</i>	2.7	6.0	MT
Wildrye, Canadian	<i>E. canadensis</i>	—	—	MT
Wildrye, Russian	<i>E. junceus</i>	—	—	T
Vegetable and fruit crops				
Artichoke	<i>Helianthus tuberosus</i>	—	—	MT
Asparagus	<i>Asparagus officinalis</i>	4.1	2.0	T
Bean	<i>Phaseolus vulgaris</i>	1.0	19	S
Beet, red	<i>Beta vulgaris</i>	4.0	9.0	MT
Broccoli	<i>Brassica oleracea botrytis</i>	2.8	9.2	MS
Brussels sprouts	<i>B. oleracea gemmifera</i>	—	—	MS
Cabbage	<i>B. oleracea capitata</i>	1.8	9.7	MS
Carrot	<i>Daucus carota</i>	1.0	14	S
Cauliflower	<i>B. oleracea botrytis</i>	—	—	MS
Celery	<i>Apium graveolens</i>	1.8	6.2	MS
Corn, sweet	<i>Zea mays</i>	1.7	12	MS
Cucumber	<i>Cucumis sativus</i>	2.5	13	MS
Eggplant	<i>Solanum melongena esculentum</i>	1.1	6.9	MS
Kale	<i>B. oleracea acephala</i>	—	—	MS
Kohlrabi	<i>B. oleracea gongylodes</i>	—	—	MS
Lettuce	<i>Lactuca sativa</i>	1.3	13	MS
Muskmelon	<i>Cucumis melo</i>	—	—	MS
Okra	<i>Abelmoschus esculentus</i>	—	—	S
Onion	<i>Allium cepa</i>	1.2	16	S
Parsnip	<i>Pastinaca sativa</i>	—	—	S
Pea	<i>Pisum sativum</i>	—	—	S
Pepper	<i>Capsicum annuum</i>	1.5	14	MS
Potato	<i>Solanum tuberosum</i>	1.7	12	MS

See footnotes at end of table.

Table 13-3 Salt tolerance of selected crops^{1/}—Continued

Common name	Botanical name	Salt tolerance threshold ^{2/}	Yield decline ^{3/}	Qualitative salt tolerance rating ^{4/}
		(EC _d)	(Y _d)	
		mmho/cm	% per mmho/cm	
Vegetable and fruit crops (continued)				
Pumpkin	<i>Cucurbita pepo pepo</i>	—	—	MS
Radish	<i>Raphanus sativus</i>	1.2	13	MS
Spinach	<i>Spinacia oleracea</i>	2.0	7.6	MS
Squash, scallop	<i>Cucurbita pepo melopepo</i>	3.2	16	MS
Squash, zucchini	<i>C. pepo melopepo</i>	4.7	9.4	MT
Strawberry	<i>Fragaria sp.</i>	1.0	33	S
Sweet potato	<i>Ipomoea batatas</i>	1.5	11	MS
Tomato	<i>Lycopersicon lycopersicum</i>	2.5	9.9	MS
Turnip	<i>Brassica rapa</i>	0.9	9.0	MS
Watermelon	<i>Citrullus lanatus</i>	—	—	MS
Woody crops				
Almond	<i>Prunus dulcis</i>	1.5	19	S
Apple	<i>Malus sylvestris</i>	—	—	S
Apricot	<i>P. armeniaca</i>	1.6	24	S
Avocado	<i>Persea americana</i>	—	—	S
Blackberry	<i>Rubus sp.</i>	1.5	22	S
Boysenberry	<i>Rubus ursinus</i>	1.5	22	S
Castor bean	<i>Ricinus communis</i>	—	—	MS
Cherimoya	<i>Annona cherimola</i>	—	—	S
Cherry, sweet	<i>Prunus avium</i>	—	—	S
Cherry, sand	<i>P. besseyi</i>	—	—	S
Currant	<i>Ribes sp.</i>	—	—	S
Date palm	<i>Phoenix dactylifera</i>	4.0	3.6	T
Fig	<i>Ficus carica</i>	—	—	MT
Gooseberry	<i>Ribes sp.</i>	—	—	S
Grape	<i>Vitis sp.</i>	1.5	9.6	MS
Grapefruit	<i>Citrus paradisi</i>	1.8	16	S
Guayule	<i>Parthenium argentatum</i>	8.7	11.6	T
Jojoba	<i>Simmondsia chinensis</i>	—	—	T
Jujube	<i>Ziziphus jujuba</i>	—	—	MT
Lemon	<i>C. limon</i>	—	—	S
Lime	<i>C aurantiifolia</i>	—	—	S
Loquat	<i>Eriobotrya japonica</i>	—	—	S
Mango	<i>Mangifera indica</i>	—	—	S
Olive	<i>Olea europaea</i>	—	—	MT
Orange	<i>C. sinensis</i>	1.7	16	S
Papaya	<i>Carica papaya</i>	—	—	MT

See footnotes at end of table.

Table 13-3 Salt tolerance of selected crops^{1/}—Continued

Common name	Botanical name	Salt tolerance threshold ^{2/}	Yield decline ^{3/}	Qualitative salt tolerance rating ^{4/}
		(EC _t)	(Y _d)	
		mmho/cm	% per mmho/cm	
Woody crops (continued)				
Passion fruit	<i>Passiflora edulis</i>	—	—	S
Peach	<i>Prunus persica</i>	1.7	21	S
Pear	<i>Pyrus communis</i>	—	—	S
Persimmon	<i>Diospyros virginiana</i>	—	—	S
Pineapple	<i>Ananas comosus</i>	—	—	MT
Plum; prune	<i>Prunus domestica</i>	1.5	18	S
Pomegranate	<i>Punica granatum</i>	—	—	MT
Pummelo	<i>Citrus maxima</i>	—	—	S
Raspberry	<i>Rubus idaeus</i>	—	—	S
Rose apple	<i>Syzygium jambos</i>	—	—	S
Sapote, white	<i>Casimiroa edulis</i>	—	—	S
Tangerine	<i>Citrus reticulata</i>	—	—	S

1/ Adapted from Maas and Hoffman (1977) and Maas (1990). Data serve as a guide to relative tolerances. Absolute tolerances depend upon climate, soil conditions, and cultural practices. Note: 1 mmho/cm = 1 dS/m.

2/ Salt tolerance threshold (EC_t) is the mean soil salinity at initial yield decline. Salinity expressed as EC_e in mmho/cm referenced to 77 °F (25 °C).

3/ Percent yield decline (Y_d) is the rate of yield reduction per unit increase in salinity beyond the threshold.

4/ Qualitative salt tolerance ratings are sensitive (S), moderately sensitive (MS), moderately tolerant (MT), and tolerant (T) as shown in figure 2-32.

5/ Values are for soil-water while plants are submerged. Less tolerant during seedling stage.

(b) Infiltration and permeability

Permeability problems occur when the soil or the irrigation water is relatively high in sodium and low in calcium. Infiltration rate can decrease to the point that sufficient water cannot infiltrate to adequately supply the crop. Sodium causes soil particles to disperse, resulting in a massive soil structure with low permeability. Where exchangeable sodium is excessive, soil permeability is reduced in low calcium level soils. Low salinity and high pH can also decrease soil permeability as much as sodium. Sodium Adsorption Ratio (SAR) is most often used to define infiltration and permeability problems; however, a combination of SAR and EC_i may be more indicative of problems. See figure 13-2 for threshold values of a combination of SAR and EC_i for potential infiltration and permeability hazards. Adjusted SAR is used where bicarbonates are present. Often, gypsum (calcium) is added to the soil to improve infiltration and permeability.

(c) Toxicity

Crop toxicity problems occur when certain elements are available in the soil-water solution and taken up by the plants. Toxic elements can accumulate in amounts that result in reduced crop yield or quality. Toxicity normally results when certain ions are absorbed by the plant with soil water, move with the plant transpiration stream, and accumulate in the leaves at concentrations that cause plant damage. This is usually related to one or more specific ions available in irrigation water, i.e., boron, chloride, and sodium. Not all crops are sensitive to these ions. White deposits on leaves or other plant parts may indicate the presence of salt. White deposits can occur on fruit or leaves as a result of sprinkler irrigation where water with high bicarbonate concentration is used. Toxicity often accompanies or complicates a salinity or infiltration problem. It may appear even when salinity is low.

Certain other highly toxic elements occur in irrigation water, especially drainage system discharge in some soils. Most of these elements, i.e., selenium, arsenic, and mercury, are not necessarily toxic to plants, but in small concentrations are toxic to animal life.

Figure 13-2 Threshold values of sodium adsorption ratio (SAR) of topsoil and electrical conductivity of infiltrating water (EC_i) associated with the likelihood of substantial losses in permeability

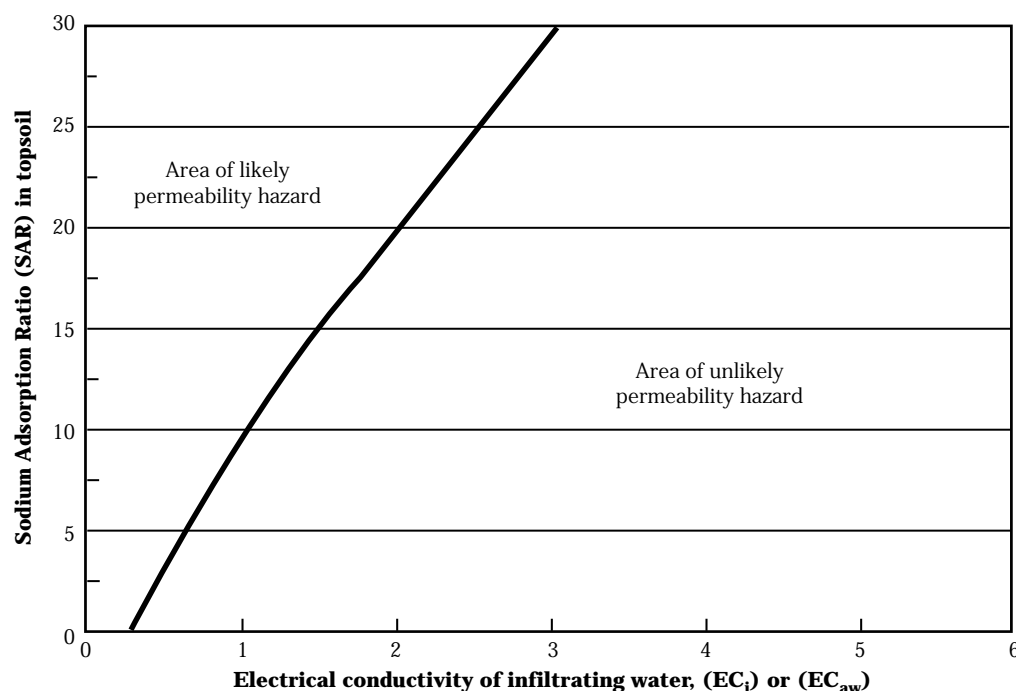

(d) Sediment

Suspended sediment and bedload material in an irrigation water supply can be a problem. Bedload material settles when transport energy is reduced. Sediment can plug water control structures in open and closed conveyance systems. Suspended sediment can be beneficial, however, for sealing coarse soils in open channel conveyance systems, on-farm ponds, and some irrigated soils. As sediment is deposited with each irrigation and as tillage takes place, additional fines accumulate in the tillage depth. Soil available water capacity (AWC) also increases in the surface layer within the tillage depth.

Suspended sediment that reduces soil intake rates on coarse textured soils improves distribution uniformity with surface irrigation systems (i.e., furrows and borders). Intake rates can be reduced under sprinkler systems, causing surface water translocation and runoff. Sediment in the water supply can cause wear on pump impellers and sprinkler nozzles. In some extreme cases, sprinkler nozzles and bearings must be replaced annually, or more often. Increased nozzle discharge resulting from wear and abrasion must be considered when making water management decisions. A twist drill shank can be used to check nozzle wear. A nozzle is considered worn when a twist drill shank 1/64-inch larger than the stamped size on the nozzle can be inserted.

When irrigation water contains suspended sediment, additional settling, screening, and filtering is necessary for most micro irrigation systems, perhaps to the point that makes management of micro irrigation impractical. Settling basins of substantial size and cyclone sand separators can be used to reduce the size and cost of filtering systems, especially when using sand media filters. See Chapter 6, Irrigation System Design, for additional information on filtration and treatment requirements for micro systems.

(e) Agricultural, industrial, and municipal wastes

Land application of municipal, industrial, and agricultural wastes requires careful planning. The goal should be to recycle nutrients in waste material as fertilizer, in amounts that can be used by the crop, and as a soil amendment that will not degrade soil, water, plant, and air resources. In addition, the soil in the upper part of the profile is an ideal environment for microbiological activity to breakdown many undesirable contaminants.

Because elements and nutrients can occur in high concentrations, it is advisable to use these wastes as supplemental irrigation water in a total water management program. Adequate plant biomass and water must be present to use applied nutrients. The irrigation decisionmaker should know the total chemical and nutrient content of applied wastes and know the amount being applied with each application. For example, most organic and agricultural wastes contain nitrates (NO_3), phosphates (P_2O_5), potash (K_2O), and, in the case of agricultural wastes, high amounts of organic material. All these nutrients are essential for good crop growth. However, when applying agricultural wastes from dairy and other livestock operations to crops that don't use all of these nutrients annually, accumulation in the soil profile can occur. This accumulation of excess nutrients can be a potential source of surface and ground water contamination especially when excess irrigation water is applied or when excess precipitation occurs. Waste from food processing operations can contain high volumes of salt, organic material, and other chemicals used in processing and bacteria control. Waste from confined livestock feeding also contains salts from urine.

A properly designed and operated sprinkler irrigation system can provide uniform waste application; however, to achieve proper irrigation water management, a separate application system may be required for irrigation. The type of application system depends upon the consistency of the waste and physical site conditions. Size of solids contained in waste affects application patterns for each type of system. During pumping, the concentration of solids may change with time. In some cases, agitation or dilution of wastes before or during pumping may be required.

Manure and wastewater effluents containing less than 5 percent solids are considered liquids. With proper screening these wastes can be applied with almost any sprinkler or surface irrigation system. Application uniformity is a prime consideration. Pump intake screens should be sized with openings no larger than the smallest sprinkler orifice. Slurries containing 5 to 15 percent solids require special pumping equipment and sprinklers with large nozzles (gun types). Slurries can be transported by either tank wagon or pump and pipeline. The viscosity and specific gravity of a slurry or liquid are dependent on the type and amount of solids in suspension. Effects by variations in specific gravity should be evaluated on an individual basis. Waste containing trash, abrasives, bedding, or stringy material is not suitable for sprinkle application unless it is preconditioned by chopping or grinding.

Where practical and suitable for soil conditions, it is recommended slurries be diluted to a liquid consistency before application. Consult NEH, Part 651, Agricultural Waste Management Field Handbook (AWMFH), for quantities of water required to achieve specific dilution requirements. Waste with 10 to 22 percent solids content (semi-solid) can be transported and spread using box type spreaders and dump trucks. Manure with more than 20 percent solids must be handled as a solid waste. Separators can be used to remove solids from the liquid fraction. The liquids can then be applied through most sprinkler systems. The amount of water applied needs to be considered as a part of the total water budget. This is specially the case with liquids and slurries. For more information see the AWMFH.

Organic solids in liquid waste cause a decrease in specific gravity, but a higher viscosity relative to that for clean water. Changes in these fluid properties require net additional energy to overcome the effects of turbulence, velocity head, and pipe friction. The result is an increase in friction head and horsepower requirements. However, pipe friction typically reduces with time. For liquid waste, AWMFH recommends using the same friction factors as those for water, but to increase the power requirement by at least 10 percent.

The effects of viscosity are most pronounced in pipelines when velocities are slow, solids content is high, or long pipelines are involved. Under these conditions, a higher total dynamic head (TDH) is required than

when pumping clean water. The overall effect is similar to a throttling valve on the inlet pipeline at the pump. For centrifugal pumps designed for water, the motor will not overload because the decrease in flow rate tends to decrease horsepower requirement. However, with an increase in viscosity, cavitation is more likely to occur because of the higher required net positive suction head (NPSH). Cavitation occurs when NPSH available is less than required, leading to the formation of vapor pockets in the liquid, typically near the eye of an impeller or around sharp obstructions in the suction pipeline. The collapse of these pockets causes the noise associated with cavitation (sounds like gravel moving through a pump or steel pipeline). Cavitation can damage the pump. The damaged area appears as corrosion.

Generally, where fluid velocities are greater than 3.5 feet per second and solids content less than 7 percent, pipe friction can be assumed to be the same as that for water. Any increase in fluid viscosity, however, creates a higher required NPSH than for water. For pumping slurries, the pump dealer must be provided the percent solids as well as the desired flow rate and pumping head. NPSH should be evaluated for the most viscous fluid condition encountered during the pumping operation. Pipe friction can be evaluated for the average condition. Appropriate specialty pumping handbooks are recommended as a design aid to estimate pipe friction for slurry flow and to calculate available NPSH.

If the same pump is used for pumping clean water and water containing solids, the pump will operate at a different efficiency for each liquid. Selecting the most efficient pump for dual application depends on determining: total volume of clean water, total volume of wastewater, solids content of the wastewater, desired flow rate, and total dynamic head. Knowing these factors allows the pump engineer or dealer to select a pump that has the highest average efficiency for the two conditions.

(1) Application rates and amounts

To avoid excessive runoff or ponding, application rates cannot exceed the soil intake rate and soil surface storage. Under sprinkler systems, exceeding the soil intake rate and soil surface storage decreases application uniformity resulting from translocation of water on the ground surface. The result is low areas receive disproportionate amounts of water and nutri-

ents, and deep percolation probably occurs in these areas. Design application rates should be guided by local experience and the maximum clean water application rate values displayed in chapter 2 of this guide. Soil intake characteristics for clean water and water containing waste are different.

Application of organic solids, contained in municipal, industrial, and agricultural wastes reduces soil infiltration rates. Appropriate management and associated cultural practices should be used to offset this effect on most soils.

Maximum quantities of waste application should be based upon the seasonal crop nutrient requirement. In addition, waste applications should be timed such that the applied nutrients are available when needed by the crop. When the field receiving waste is irrigated, total water applied (wastewater + effective precipitation + irrigation) should not exceed available soil-water storage in the crop root zone. This avoids excess leaching and runoff.

Water and nutrient budgets can be used as planning tools in evaluating this aspect. Crop evapotranspiration and net irrigation requirements for various crops are displayed in chapter 3. A nutrient analysis of the waste and the knowledge of how much of each nutrient is being applied are highly recommended to the irrigator. How the waste is handled, stored, and applied somewhat dictates the availability of nitrates. Nitrates can be easily lost to volatilization and denitrification, whereas through careful handling and application, more of the nitrates can be made available for crop use.

(i) *Sprinkle irrigation systems*—Both gun types and conventional sprinkler heads can be used for application of liquid agricultural wastes. Large nozzle gun types are also well suited to application of waste slurries. Slurry application uniformity can be a problem. Application systems can be continuous or periodic move. Screening is necessary when using conventional set type sprinkler systems, generally because the nozzles used are smaller. With any system, lower flow rates (slower velocities) near the ends of laterals can lead to the settling of solids. Pumping clean water for 10 to 15 minutes following waste application helps to minimize this problem. Handmove systems are not

recommended for waste application because of the physical contact with effluent. Pipelines should be drained or protected from freezing during cold weather.

(ii) *Surface irrigation systems*—Surface irrigation systems, typically furrows and borders, can be used to apply waste if good application uniformity of both waste and water is obtained. Runoff and ponding must be prevented. Runoff containing waste can contaminate surface and ground water.

(iii) *Micro irrigation systems*—Screening and filtration requirements typically render micro irrigation systems unsuitable for most waste applications.

(2) Major management concerns

Waste should be applied uniformly and in a manner that prevents runoff or excessive deep percolation. Nutrients in applied waste should not exceed crop usage with allowance for application losses; i.e., denitrification. Proper application rates and timing are essential to meet these considerations. These concerns should be addressed in the selection and design of the irrigation application system and in the operation and maintenance plan.

Where the goal is to maximize the utilization of nitrogen, applying the waste in the first half of the irrigation application period helps to incorporate the nitrogen and decrease denitrification losses. Where the goal is to protect ground water or surface water supplies from excess nitrogen, applying clean irrigation water before the waste increases volatilization losses and maintains nitrogen in the upper part of the plant root zone. Both cases require good water management. Apply only the amount of water the soil can hold within the plant root zone. Allow for expected precipitation.

Odors from animal waste (manure) and some municipal or industrial waste being applied through sprinkler systems can be a major problem. Where possible, select locations downwind from neighbors or heavily traveled roadways. Avoid application on hot or humid days or when the wind direction is toward these areas. Visiting with the neighbors regarding the least offensive time for applications is a good management practice.

Sprinkler applications of manure and wastewater should be followed with at least a 10- to 15-minute flush of clean water to clear solids from the pipelines. Deposited solids can reduce flow capacity and accelerate corrosion of aluminum and steel pipelines. Deposited solids can also dislodge during subsequent applications to cause clogging of even the largest sprinkler nozzles. Clean water flushing also washes solids off plant leaves, preventing ammonia burn during hot weather.

The following management strategies may be appropriate for protection of ground water from excess deep percolation of nitrates:

(i) Deficit irrigation—During the irrigation in which waste is applied, deficit irrigation (not completely filling the plant root zone) is a good management practice. This reduces opportunity for deep percolation because of application nonuniformity. To use this strategy, the operational flexibility of the irrigation system must accommodate a shorter time between irrigation applications. The amount of deficit irrigation should be based upon local precipitation patterns, crop rooting depth, and water holding capacity of the soil.

(ii) Reduced application—Apply only part of the waste allowed for a single application, reserving the rest for a later application, but within the period in which the plants take up nitrogen and other nutrients. The sum of nitrates and other nutrients for all the applications should not exceed the crop uptake after losses are considered.

(iii) Irrigation water before wastewater—Apply irrigation water before wastewater, reserving enough clean water for a 10- to 15-minute flush of pipelines. This helps keep nitrates in the upper part of the plant root zone.

(3) Other management considerations

Provide timely and correct maintenance of equipment is a good management practice. Application of wastewater is frequently done during the non-irrigation season. Winter storage and maintenance are crucial factors in assuring that the system functions throughout the next season. Rodents nesting in open pipes or control boxes, plugged pipelines, and undrained pipes that have frozen and burst are common problems.

See NEH, Part 651, Agricultural Waste Management Field Handbook, Chapter 11, Land Utilization, for land application of agricultural wastes through irrigation systems.

For planning and design of land application of municipal wastewater through irrigation systems, see the United States Environmental Protection Agency's (USEPA) publication, Process Design Manual, Land Treatment of Municipal Wastewater. October 1981 (including Supplement on Rapid Infiltration and Overland Flow, October 1984), EPA 625/1-81-013 and 013a. Additional local design procedures and regulations may also apply.

(g) Miscellaneous

Other water quality problems that may arise in specific locations need to be considered when planning irrigation systems. They can include:

- Extreme temperature water
- Tailwater
- Drainage effluent
- Pesticides
- Toxic ions (i.e., salts), heavy metals, and other elements not normally found in waste effluent

(1) Extreme temperature (hot or cold) water

Geothermal water can generally be used without cooling when using a moderate to high pressure sprinkle irrigation system. Water that is sprayed through the air will be close to or below ambient air temperature when it strikes the ground surface or crop canopy. When applying hot water through a low pressure sprinkler, micro, or surface irrigation system, the hot water generally must be cooled so that the plant crown and tubers close to ground surface are not cooked. Pump design should consider water temperature where it is above 90 degrees Fahrenheit.

Geothermal water may also contain undesirable chemicals, such as boron, chloride, sodium, sulfur, and heavy metals. Therefore, a water quality test is necessary before using it for irrigation purposes. Some of these chemicals can be toxic to a wide variety of plants, animals, and humans.

Irrigating soils with extreme cold water (or excess amounts of water) can delay soil warm-up, thereby retarding plant growth. In some areas glacier melt or

snow melt is available during most of the growing season. A 4 to 8 degree Fahrenheit decrease in soil temperature in the upper 6 to 8 inches of the soil profile have been measured after applying 3 inches of 54 degree Fahrenheit water with surface systems. This temporary drop in soil temperature may be short (4 to 16 hours), but it can retard plant growth during the cool down period. Sprinkle irrigation can help warm cold water if ambient air temperature is higher than the temperature of the water. Applying too much irrigation water early in the growing season (or for frost protection when the ground surface is bare) can retard plant growth because of excess soil surface evaporation and excessive water in the plant root zone.

(2) Tailwater (surface runoff)

Where the opportunity exists and is legal, tailwater from irrigated fields can be reused as a water supply or to supplement existing supplies. Runoff water from irrigation can contain nutrients, sediment, pesticides, and in some areas nematodes. Use of water containing these contaminants may be restricted. For example, runoff from a field irrigation system used to apply fertilizers and pesticides cannot be used on fresh vegetables, but can be used on many field crops. It is preferred to reuse this water for irrigation of field crops rather than allow it to return to public water. Tailwater reuse can improve onfarm irrigation efficiency and reduce use of high quality water.

Sediment in tailwater, often resulting from irrigation induced erosion on highly erosive soils, can degrade downstream surface water for public recreation, municipal water supply, wildlife, and fishery uses. It may also be undesirable for irrigation purposes because of sediment deposition problems in conveyance systems. Technically, tailwater reuse on the same or downslope field should be a part of every surface irrigation system. Except for closed level basin, border, or furrow systems, runoff is necessary for best irrigation uniformity. Blocked ends can improve application uniformity on nearly level fields where ponded water covers the lower fourth to third of the field. On steeper fields, blocking furrows and borders to limit runoff generally increases deep percolation. Level furrows and basins in arid areas typically have no runoff.

(3) Drainage effluent

Internal drainage and removal of drainage water used for leaching (for salinity control) are essential. However, disposal of effluent can be a problem. Disposal alternatives include:

- Discharge into salt sinks (ocean, salt basins, underground saline aquifers)
- Discharge into a waste disposal operation.
- Reuse on cropland by irrigating high salt-tolerant plants.
- Discharge into an onfarm evaporation pond
- Reclaim salt(s) for use in the United States salt market (livestock feed, food processing for human consumption, industrial).

By far the best solution is good onsite water management to minimize the amount of effluent to be disposed, but yet maintain proper soil salinity control in the plant root zone. Drainage effluent can contain naturally occurring soil elements. Some of these elements (i.e., boron, selenium) can be toxic to wildlife.

Drainage effluent from salinity control irrigation management can contain high concentrations of salts and is unsuitable for reuse on most common crops. It has been demonstrated, however, that drainage effluent from fields with intensive salinity control can be used for irrigation of very high salt-tolerant plants (agroforestry). Incorporating crop residue containing salt returns the salt to the soil, perhaps with very little, if any, net salt removal. Some of these plants are commercially useful and can be grown economically and irrigated with very high salt concentration drainage effluent. When irrigating high salt-tolerant plants, good internal drainage and removal of excess water used for leaching for salinity management are also essential. The final, smaller volume of drainage effluent with a very high salt concentration is typically discharged into an onfarm evaporation pond. The remaining salts can then be mined. High salt-tolerant plants are listed in table 13-4.

Research has also demonstrated that certain trees and halophytes are useful in the uptake of selenium from the soil water. The trees include:

- Eucalyptus
- Casuarina
- Athel

The halophytes include:

- Quail bush (atriplex)
- Iodinebush
- Fivehook bassia
- Jose tall wheatgrass

(4) Pesticides

Pesticides and their metabolites can be highly toxic to humans and wildlife. Some are persistent and mobile in water. Excessive irrigation water application and precipitation that leaches below the plant root zone can carry these contaminants into ground water. Tailwater (surface runoff) containing these contaminants may be suitable for reuse to irrigate many crops, but even small concentrations may be hazardous to fish, water fowl, wildlife, domestic animals, and humans. Operating irrigation systems is difficult without coming in physical contact with the irrigation water or without having small areas of standing water within or near irrigation operations. Surface water attracts wildlife in a wide range of species and sizes.

Table 13-4 High salt-tolerant plants

Plant	Notes
Tolerance level: $EC_i = 8$ to 10 mmho/cm	
Eucalyptus trees	Used as biomass for organic fuel fired power generating plants.
Casuarina trees	Is not frost tolerant.
Athel	Used in windbreak plantings.
Tolerance level: $EC_i = 20$ to 35 mmho/cm	
Fivehook bassia	
Saltgrass	Useful as ground cover in windbreaks or for erosion control.
Jose tall wheatgrass	
Cordgrass	
Fat-hen	
Red sage	
Tolerance level: $EC_i = > 40$ mmho/cm	
Iodinebush	
Quail bush (atriplex)	

652.1302 State supplement

WA652.1302 State Supplement

Quality of Water Supply

Other sources of water quality information can be found at:

- NEH, Part 623, Chapter 2, Irrigation Water Requirements

<http://www.info.usda.gov/CED/ftp/CED/neh15-02.pdf>

- NEH Part 651, Ag Waste Management Field Handbook

<http://www.info.usda.gov/CED/ftp/CED/neh651-ch1-11.pdf>

- USGS web site

<http://co.water.usgs.gov/projects/index.html>

- Washington DOE web site

<http://www.ecy.wa.gov/search.html>

Chapter 14 Environmental Concerns

Contents:	652.1400	General	14-1
	652.1401	Environmental impacts	14-1
		(a) Transport of chemicals	14-1
		(b) Consumptive use by plants	14-2
		(c) Pollution hazards by chemicals	14-2
		(d) Impacts to wildlife	14-2
	652.1402	Irrigation water management	14-3
	652.1403	Pollution delivery process	14-3
		(a) Availability	14-3
		(b) Detachment	14-4
		(c) Transport	14-4
	652.1404	Type of pollutants	14-7
	652.1405	Conservation practices for pollution control and reduction	14-8
		(a) Pollution control	14-8
	652.1406	Conservation management plan development	14-11
	652.1407	Benefits	14-11
	652.1408	Costs and benefits	14-14
	652.1409	State supplement	14-15

Table	Table 14-1	Common pollutants	14-7
--------------	-------------------	-------------------	------

Figure	Figure 14-1	Pathways for transportation of substances to receiving water	14-6
---------------	--------------------	--	------

Exhibits	Exhibit 14-1	Factors affecting chemical pollutant availability, detachment, and transport	14-5
-----------------	---------------------	--	------

	Exhibit 14-2	Example of identified concerns	14-12
--	---------------------	--------------------------------	-------

652.1400 General

Irrigation brings many benefits to individuals, communities, and regions, but it also brings environmental concerns. Many environmental concerns are local. Some are larger in scope; such as coastal zones, river basins, and regional and even international. Irrigation planners and decisionmakers need to have a basic understanding of the general processes by which irrigation water can affect soil, water, air, plant, and animal resources. Human considerations (social, cultural, and economic) should involve both present and future conditions.

Most farmers are good environmentalists. They are faithful stewards of soil, water, air, plant, and animal resources, and truly desire to help maintain a good overall environment and quality of life. Others, many of whom recognize only one or a few specific resources, should have concerns for environmental quality and long-term farm production.

652.1401 Environmental impacts

Negative and positive environmental impacts are caused by irrigation. These impacts include:

- Transport of chemicals
- Consumptive use by plants
- Pollution hazards by fertilizers, pesticides, fuels, and other contaminants
- Obstructed wildlife migration patterns

Negative irrigation impacts to the environment can be insignificant or large. Water pollution problems from individual irrigated farms may appear small, but when combined with adjacent farms, the problem can be large. With new project development or major changes to existing systems, mitigation may be necessary. Providing an environmental assessment as part of the irrigation system planning process can identify both negative and positive impacts. Farmer's irrigation decisions should be based on knowing potential impacts and how much they affect the environment. See chapter 15 for planning tools including environmental assessment aids.

(a) Transport of chemicals

Water can transport chemicals through the soil and off the field. Inefficient and nonuniform onfarm irrigation can provide excess surface water runoff (tailwater) and deep percolation. For best uniformity, some deep percolation is generally required.

Runoff water from irrigation can carry sediment from soil erosion, nutrients, pesticides, animal waste, and other soil surface pollutants into surface water. Runoff from irrigation can augment surface water flows to provide water for fish, wildlife, irrigated areas, and other downslope land uses, such as wetlands. However, in most cases quality of water from irrigation runoff is lower than that of the original supply. Pollutants can result in damages to other downslope irrigated areas, to fish, wildlife habitat, cities, and industries.

Proper soil, water, and plant management can minimize these effects. Runoff from irrigated cropland is designated by EPA as a nonpoint source pollutant; therefore, discharges do not require a discharge permit. Deep percolation can carry nutrients and pesticides that have become a part of the soil-water solution to local ground water aquifers. Certain chemicals contained in ground water can become hazardous when consumed by humans and livestock. Irrigation water can help metabolize wastes applied to land into plant usable nutrients and soil amendments.

(b) Consumptive use by plants

Water consumptively used by plants is not available for other instream uses. To understand the impacts on instream flows, ground water, and springs, consumptive use, nonconsumptive use, and local water right laws must be understood as they apply to mining and to agricultural, municipal, and industrial uses.

(c) Pollution hazards by chemicals

Care in handling and storage of fertilizers, pesticides, fuels, lubricants, and solvents is necessary to avoid polluting ground and surface water. This applies to both commercial and on-farm operations. Care must be taken to prevent chemical and fuel spills at chemical and fuel storage facilities, chemical mixing areas, chemical application equipment wash areas, and especially at the irrigation pumping plant site. Spills of these materials onto the ground surface can infiltrate the soil or be flushed off the surface with irrigation water or precipitation.

(d) Impacts to wildlife

Some open channel irrigation water conveyance systems can obstruct normal wildlife migration patterns. Large concrete lined canals are hazardous to some wildlife (also humans and domestic pets) unless precautions are planned and incorporated so that they can exit once they have entered (by choice or accidentally). This is a concern in arid areas where the canal water may be the only water available for some distance.

In some areas, canal seepage and deep percolation in fields can dissolve naturally occurring toxic soil elements, such as salts and selenium. The toxic elements in the soil-water solution can then move into ground and surface water.

652.1402 Irrigation water management

Proper irrigation water management is essential to minimize negative irrigation caused impacts to the environment. Even the best irrigation system can be mismanaged. Well planned and fully implemented irrigation water, animal waste, pest, and nutrient management plans reduce or help prevent ground water and surface water quality pollution problems associated with irrigation. Proper irrigation water management includes:

- An irrigation system that is suitable to the site.
- Good irrigation system operation techniques that optimize distribution uniformity.
- Proper irrigation scheduling and adequate irrigation system maintenance.

652.1403 Pollution delivery process

The process by which a pollutant is detached and delivered to ground or surface water (and into air) takes place in three basic stages: availability, detachment, and transport. A water pollution hazard exists **only** when a pollutant is **available** in some form at the field site, becomes **detached**, and is **transported** to a receiving water body.

Pollution concerns from irrigation activities result from using an unsuitable irrigation system, using poor operation techniques, or making poor irrigation water management decisions, especially when matching irrigation applications to pesticide and fertilizer applications. However, if excess fertilizers and persistent pesticides are available, a potential pollution opportunity exists even when good irrigation water management is practiced.

(a) Availability

Pollutant materials must be available in a form that has the potential to become a concern. The quantity and nature of the material influence its availability. For example, soil is usually available to provide sediment downstream, either as deposition or suspended particles. Chemicals, fertilizers, and pesticides vary not only in quantity, but in degree of their availability. Availability is often measured in half life (half life is when 50 percent of the original chemical is still available).

The amount and placement of chemicals (availability) at the time a runoff or deep percolation event occurs are significant. The partitioning of a chemical between water and soil determines its availability to be carried by soil erosion, by deep percolation, or by some other pathway.

Phosphate placed on the soil surface can be present in surface runoff. If placed below the soil surface, phosphates are typically not available except when severe soil erosion takes place. Nitrates that have leached below the plant root zone are available for deep percolation. Manure left on the soil surface is available as a

downstream pollutant when surface runoff occurs. Pesticides with a short half-life are available for a shorter time than more persistent (longer half-life) compounds, such as chlorinated hydrocarbons.

(b) Detachment

Pollutant materials must be detached from their original location (or made mobile) before they can become a pollutant in receiving water. The detachment process is either physical or chemical. Chemical pollutants are grouped into three basic categories based on their sorption characteristics: strongly sorbed, moderately sorbed, nonsorbed. Sorption refers to absorbed and adsorbed chemicals.

Absorption, dissolving and detachment of chemicals in the soil mass and water, is dependent on:

- Type of chemical and concentration in soil water solution
- Strength of ionic bonding to soil particles
- Quality of irrigation water and soil-water solution as to type and concentration of chemicals (salinity, pH), soil texture, organic matter content, soil erodibility, temperature, biological activity, pesticide persistence

The negative impact of applying chemicals (and water) can be minimized by using a suitable irrigation system with good operation techniques and proper irrigation water management. Suitability generally refers to how uniform a planned amount of water can be applied across a field.

Highly soluble chemicals are easily detached (by dissolving or being released) by surface runoff and by water percolating through the soil. Because of strong ionic bonding to soil particles, phosphorus moves primarily with soil particles in surface runoff. The quantities and kinds of chemicals adsorbed to sediment are affected by soil chemistry, amount and availability of chemical(s), and amount of soil erosion that occurs. Solid particles are physically detached by sprinkler droplets (and raindrops) and by surface runoff (shear stress). Coarse soil materials are easily detached, but do not transport readily except on steeper slopes. Manure on the soil surface is easily detached. Fine soil materials are more resistant to detachment, but once detached are readily transported.

(c) Transport

With respect to irrigation, agricultural pollutants are typically transported in water as surface runoff or deep percolation. However, some substances are lost through wind drift and volatilization when using sprinkle irrigation systems for chemigation or application of liquid waste or manure slurry. Manure on the soil surface can be transported in field runoff as solid particles in suspension or as part of the water solution. The particular pathway by which a pollutant leaves the field depends on the soil, hydrology of the field, irrigation system used, and level of irrigation water management. Timing and rates of fertilizer and pesticide application (including the relationship to irrigation applications) and the interaction of the applied chemical with water and soil are also important.

Pollutants are generally transported to receiving water by surface runoff and deep percolation. Practicing good water management provides little opportunity for applied and naturally occurring chemical and organic wastes to move with surface runoff or through the soil profile to ground water. Some runoff from graded furrow and border irrigation systems is necessary to make the most uniform application of irrigation water to all parts of the field.

In practice, deep percolation and lateral translocation can occur with all irrigation methods and systems except subirrigation where water movement is primarily upward. Where operation and management of the system are poor, excess deep percolation and runoff probably have the best opportunity to occur with surface irrigation methods. However, it should be strongly emphasized that when adequately designed, operated, maintained and managed, surface irrigation systems can provide good uniformity and low pollution potential. A poorly designed, operated, maintained, and managed micro or sprinkle irrigation system also has high potential for providing excess deep percolation and runoff.

Deep percolation carries dissolved substances, such as nitrates or pesticides in original form or in a metabolized form. The metabolized form of some chemicals can have a much longer half-life than the original chemical and may be either less or more toxic or mobile in the soil-water solution.

Exhibit 14-1 displays the factors affecting chemical pollutant availability, detachment, and transport. Figure 14-1 displays the pathways through which substances are transported from irrigated cropland to become water pollutants

Exhibit 14-1 Factors affecting chemical pollutant availability, detachment, and transport

Availability	Soil, land use, substance input, management practices.
Detachment	Irrigation application rate, furrow and border inflow stream rates, soil erodibility, soil bonding of chemicals, and surface condition (cover, residue, clodiness, surface depressions).
Transport	Runoff energy, runoff volume, sediment particle size and specific gravity, organic matter of surface soil, water holding capacity of upper soil profile and vadose zone, infiltration of soil surface, hydraulic conductivity characteristics of soil profile and vadose zone, and chemical properties of soil profile and vadose zone.
Site	Undulating topography, vegetation in flow path, distance of flow path to surface stream and/or depth to water table, concentration in water of particulate, organic and inorganic materials.

Figure 14-1 Pathways for transportation of substances to receiving water

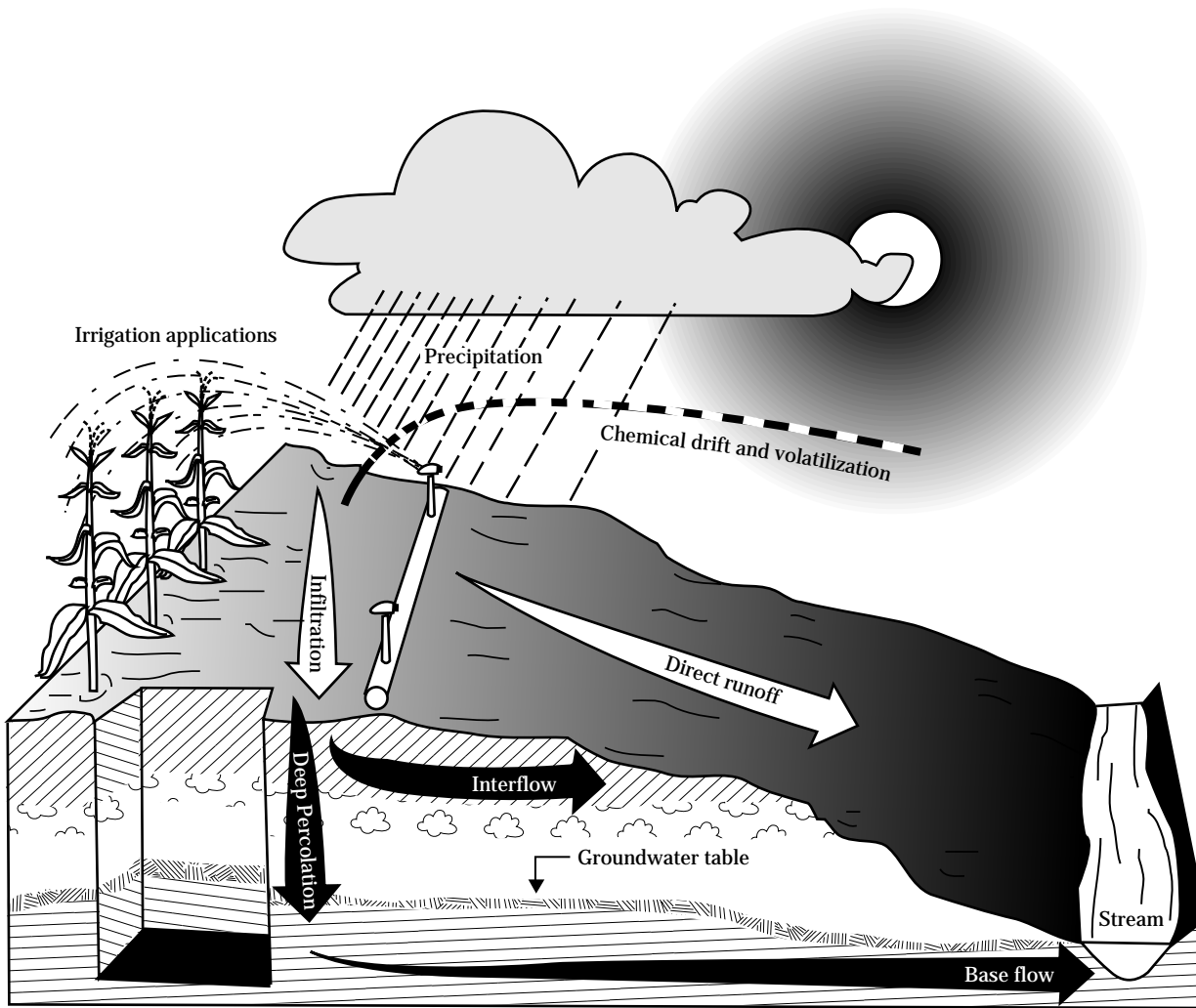

652.1404 Type of pollutants

Pollutants can be put into three basic categories—particulates, organics, and inorganics. Table 14-1 displays examples of the more common pollutants. All can be transported by water, and a few can be transported by air. Odors associated with organic and inorganics are definitely problems to people, and irrigation activities (both water and air) can be the carrier. Examples include sprinkle application of animal waste, sprinkle and aerial application of pesticides, volatilization of nitrogen in urea, and ammonia forms from animal waste and fertilizers.

At a soil-water nitrogen concentration of 20 ppm (20 mg/L), each acre-inch of deep percolation represents about 5 pounds of nitrate-nitrogen lost per acre. Applying fertilizer in excess of plant needs, along with over irrigation on all or parts of a field, is perhaps the greatest cause of ground water and surface water pollution. Where ground water is used as an irrigation water source, it can also be a valuable source for supplying nitrate needs for crop growth. With an annual irrigation application rate of 24 inches per acre, and 20 ppm, this resource can provide approximately 120 pounds of nitrate-nitrogen per acre. Water should not be used for human consumption at nitrate concentrations of more than 10 ppm (10 mg/L).

Table 14-1 Common pollutants

Particulates	Organics	Inorganics
<p>Sediment sand silt clays</p>	<p>Livestock waste manure bedding and litter material spilled and undigested feed fecal coliform</p> <p>Plant residue</p>	<p>Chemicals fertilizers—nitrates, phosphorus, potassium pesticides—herbicides, insecticides, fungicides, miticides, nematicides</p> <p>Salts sodium, calcium, magnesium, potassium, carbonates, bicarbonates, sulfates, chlorides</p> <p>Other boron, arsenic, selenium, heavy metals, engine fuel, lubricants, pumping engine exhausts</p>

652.1405 Conservation practices for pollution control and reduction

Potential pollutants can be controlled or eliminated by:

- Reducing or eliminating the source
- Reducing availability
- Decreasing detachment or transport process

The role irrigation water management plays in the movement of contaminants by excess deep percolation and surface runoff on irrigated cropland cannot be overstressed. An adequately designed, operated, maintained, and managed irrigation system is essential for minimizing pollution potential. Applying the correct amount of water according to crop needs is a necessary part of proper irrigation water management for controlling pollution.

(a) Pollution control

(1) Reduction of source

Source reduction is reducing availability of chemicals through proper nutrient and pest management.

(i) Nutrient management—Less fertilizer is generally applied if a nutrient management plan is followed. A soil testing program can show residual amounts of fertilizer available, thereby avoiding overapplication. This reduces the *extra* that was historically applied to account for *losses* and helps balance the total fertilizer needs and availability (including residual amounts in the soil profile) for average crop yield, not maximum yield.

(ii) Pest management—Less pesticide is generally applied if a pest management plan is followed. Evaluation of soil, site conditions, application methods, and the choice of pesticide is stressed to reduce hazards of potential pollution. Application of pesticides should be coordinated with irrigation applications to allow necessary time to be effective in controlling pests without being washed from the surface of leaves by spray. Better control and timing of application typically results in less pesticide use with chemigation.

Field scouting techniques and proper pesticide application timing and rates based on pest threshold levels can reduce potential for leaching and runoff.

Using SCS SCHEDULER software, or some other technique, to calculate growing degree days can reduce the amount of pesticide applied by more accurately predicting insect hatch and propagation.

(2) Reduction of availability

The irrigation decisionmaker can optimize nutrient availability by:

- Managing fertilizer through proper rates and timing
- Monitoring the buildup of available nutrients in the crop root zone
- Incorporating fertilizers
- Using proper irrigation water management

Where excess nitrates have accumulated in the soil profile below normal rooting depths for shallow rooted crops normally grown, then salvage crops with deep rooting characteristics should be grown until the accumulation of nitrates is consumed. Minimization of deep percolation losses is essential.

(3) Reduction in detachment

The loss of nutrients and pesticides by detachment of soil particles (i.e., erosion) is important for inorganic chemicals whose major environmental chemical forms are strongly or weakly held by soil particles. Phosphorus is tightly bonded to soil particles; therefore, it is not readily detachable except where soil is detached by water erosion. Phosphorus becomes part of the surface water pollution process mostly as a result of precipitation, runoff, irrigation related soil erosion, sediment deposition, and suspended sediment in surface water.

Increased soil organic matter decreases the potential for detachment of nutrients and pesticides. Decreasing deep percolation losses can decrease nitrate movement. Inorganic forms of nitrogen are not tightly bonded to soil particles. They dissolve easily and readily become part of the soil-water solution. Nitrates are very mobile and move readily with deep percolation as part of the soil-water solution.

Erosion control is an essential component of a resource plan. If quality criteria are met for erosion control, irrigation induced erosion, sediment trans-

port, and water leaving the field should be at acceptable levels to prevent significant loss of nutrients or pesticides.

(4) Reduction in transport

The importance of the transport process in the loss of pollutants (including salts) from irrigated cropland is a function of the affinity of the chemical form of the nutrient or pesticide for soil particles. Chemicals that dissolve readily are transported easily with excess irrigation water. Reducing deep percolation by using adequately designed, operated, maintained, and managed irrigation systems is essential to reducing transport potential. Chemigation near the end of an irrigation application helps keep chemicals near the soil surface.

Phosphorus typically is transported with detached and transported soil particles in surface runoff because of strong bonding with soil particles. Reduced irrigation induced soil erosion on the field and opportunity for off-field transport of sediment are essential. Onfield soil erosion with furrow irrigation systems can be controlled by:

- Using proper furrow inflow streams, reducing irrigation grades
- Maintaining crop residue on the soil surface with adequate crop rotations and conservation tillage methods and equipment
- Reducing tillage operations

Where onsite erosion control practices are adequate, off-field sediment movement can be reduced with vegetative filter strips at the lower end of fields and by installing and maintaining sediment collection basins. On highly erosive soil, often the only solution to eliminate irrigation induced erosion and resulting pollution may be changing to permanent vegetative crops (grass, alfalfa-grass, and clover-grass) or collecting and redistributing sediment. Almost all soils contain some clay particles. Colloidal clays stay in suspension much longer than do silts and sands; therefore, overflow from sediment ponds can contribute to downstream suspended sediment pollution.

Maintaining ground cover to filter potential pollutants and prevent soil erosion can provide a reduction of chemical availability, detachment, and transport. Implementing necessary component practices identified in resource plans, such as conservation tillage helps maintain crop residue on soil surface and im-

prove soil condition. Vegetative cover and water management practices can reduce or eliminate irrigated related soil erosion. Plant and maintain vegetative filter strips at lower end of irrigated fields to reduce water velocity and to filter sediment. Also consider using sediment collection basins at lower end of fields as a best management practice.

(5) Controlling pollution from animal waste

Animal waste (manure) is a valuable resource for crop production. It contains not only nutrients, but also organic material. A basic principle is that if animal waste is used to the maximum extent possible, few pollutants are discharged to receiving water. Animal waste is applied as liquids, slurries, or solids.

A properly designed, operated, maintained, and managed waste management system reduces or eliminates deep percolation and surface runoff of applied nutrients. A properly designed, operated, maintained, and managed irrigation system is often a part of waste management systems. In some cases, two separate systems may be necessary.

Runoff from waste application should be nonexistent. Vegetative filters at the lower end of fields efficiently trap water transported waste particles with attached nutrients and allow more time for infiltration of runoff. Filter strips must be used in combination with other applied practices.

Little (if any) reduction in water soluble nutrients and chemicals is experienced by surface water passing through and leaving a filter strip. Water quality problems related to animal waste application sites can be effectively solved by using water management practices that reduce the availability of pollutants for transport during runoff events. These practices include:

- Providing a suitable site (crop, soils, and slope)
- Applying waste with a suitable irrigation system
- Not exceeding soil intake rate(s)
- Providing proper timing of waste application
- Providing uniform waste and water applications

(i) Application rates—The rate at which animal waste is applied should be based on soil nutrient levels, nutrient needs of the crop, and available nutrients in the waste. Both nitrate and phosphorous requirements should be considered in determining proper application rates.

Soil infiltration rates using effluents are generally less than the infiltration rate for clean water. Waste effluent should be applied at a rate less than that of the soil infiltration (plus surface storage) rate for the effluent being applied. Split application also helps.

(ii) Timing of waste applications—To maximize plant use and reduce potential for deep percolation and runoff losses, applications of animal waste should coincide as nearly as possible with crop needs. Sufficient water must be available to optimize plant use of applied waste.

Rate and timing of waste applications with an irrigation system can be controlled by the kind and amount of nutrients in the waste or by the amount of water applied. Typically waste application should occur near the end of the irrigation set. Waste applications during nongrowing seasons should be controlled by the capacity of the soil profile containing plant roots to store both the applied nutrients and water. Surface incorporation of wastes also helps.

(iii) Frequency of waste application—The frequency of waste applications can vary considerably. During the irrigation season, waste applications should coincide with planned irrigations. Liquid waste high in phosphates should be applied in the first part of the irrigation application period to allow infiltration. Animal waste high in nitrates should be applied near the end of the irrigation set. Clear water should pass through the system for 5 to 15 minutes following waste application to purge the irrigation system of waste material and to wash off plants. In either case, the amount of applied water should not exceed the capacity of the soil to store applied water within the plant root zone.

(6) Tools for planning and followup

Portable state-of-art test kits and instruments for field use are readily available. They can be extremely useful as planning and application tools that provide almost instantaneous information. Examples of field instruments and uses are:

- Determining soil and irrigation water salinity levels; i.e. electrical conductivity of soil-water extract (EC_e) and irrigation water (EC_i).
- Determining nitrogen content of animal waste.
- Quick readings of in situ soil moisture; i.e., neutron moisture gauges (probes), tensiometers, TDR probes, electrical resistance blocks, feel and appearance of soil, and Speedy Moisture Meter.
- Determining sediment concentration in surface runoff using Imhoff cones.
- Quickly and easily determining stream flow using digital current meters.
- Measuring stream flow depth using resistance tapes or pressure transducers.
- Collecting, storing, and transferring field data using data loggers.
- Providing on-the-spot analysis and information using laptop computers and portable printers.

652.1406 Conservation management plan development

The objective of conservation management planning is to assist farmers in protecting the soil, water, air, plant, animal, and human resource base. The irrigation planner must consider resource interrelationships when planning irrigation systems, and as part of the environment. A broader planning scheme is particularly important with water quality concerns. Impacts of irrigation activities can be either onsite or offsite. The NRCS National Planning Policy and National Planning Procedures Handbook provide direction for all planning activities.

Development of alternatives, selection of practices, and consideration of all costs associated with those practices must be weighed against benefits received.

An evaluation tool, such as the example in exhibit 14-2, can be used to identify and assess concerns and their level of significance during the scoping process. Intensity of the scoping of environmental concerns varies with location, problems involved, people involved, and size of planning unit (individual farm, group of farms, watershed). The scoping process should involve multidiscipline professionals.

For project level planning, the scoping process should involve landowners, public, community leaders, agencies at all government levels, and interested technical people. Concerns having less importance can be scoped out early. Institutionalized concerns should be addressed. Scoping helps to determine the level of information needed. The scoping process also helps identify significant problems or concerns on which to focus.

652.1407 Benefits

Environmental and socioeconomic benefits from irrigation can include contributions to:

- Local and national economies
- Livestock capacity
- Alternative use of potential pollutants
- Utilization of agricultural and municipal wastes
- Activities involving small farm ponds
- Activities involving large storage reservoirs
- Ground water and wet areas
- Local climate and aesthetics
- Wind erosion prevention

Irrigated cropland contributes much to local and national economies and the well being of people. Irrigation water and the resulting area of irrigated cropland provide a basis for development of communities, businesses, industry, and export. In semiarid, subhumid, and humid areas, supplemental irrigation helps assure an economic crop yield and quality during periods of less than adequate precipitation. In arid areas, most crops cannot be economically grown without irrigation water. Irrigation can reduce the potential for pollution in subhumid and humid areas by maintaining plant growth during periods of less than adequate precipitation.

Ranch livestock capacity and associated economic operations are often controlled by quantity and quality of feed harvested from irrigated fields.

Irrigation of high salt tolerant plants with high saline (or sodic) subsurface drainage effluent provides a wise alternative use of an otherwise potential pollutant. Irrigation systems can transport and apply agricultural and municipal wastes for disposal on irrigated cropland, landscaping, or turf. A larger volume of wastes can be used by irrigated crops than nonirrigated crops because of the higher use of nutrients. A better microbiological environment is provided in the upper part of the soil profile as a result of applied irrigation water.

Exhibit 14-2 Example of identified concerns

Environmental concerns	Concern	Significance	Remarks
Water quality in streams	Very high	Very high	Poor water quality results in several negative impacts.
Sedimentation	Medium	Medium	High rates of sedimentation in streams are noted.
Streambank erosion	Medium	Medium	75 percent of streambanks are unstable and eroding.
Seasonal peak flows	High	High	High peak flows prevent riparian restoration.
Low summer flows	High	High	Insufficient to allow fish to migrate.
High summer water temps	High	High	High temperatures are lethal to trout (cold water fish).
Lack of streamside vegetation	High	High	Shading of stream decreases water temperature.
Lack of wildlife & fish	High	High	Fish population is lowest on record.
Threatened and endangered species	Medium	Medium	No known threatened and endangered species are in the area.
Water rights	Very high	Very high	Pending in-stream water needs, water right holders are concerned about options to use existing available water or to develop additional water.
Watershed condition	High	High	Concern as to continued deterioration.
Weeds	Medium	Medium	Certain weeds are multiplying at an alarming rate.
Cropland erosion	Medium	Medium	Conservation practices are essential to maintain long-term productivity.
Cultural resources	Medium	High	Significant buildings and sites in upper watershed.
Private property rights	Very high	Very high	Landowners fear loss of property rights.
Wetlands	Low	Low	Limited amount in watershed and adjacent areas.
Human health and safety	Low	Low	Resource problems do not impact human health and safety.
Important agricultural lands	Low	Low	Local zoning laws protect important farm lands.
Highly erodible lands	Low	Low	Erodible lands are currently protected by CRP.
CRP contract expiration	High	High	Cropland erosion rates could increase upon expiration of contracts if annual farming is again commenced.
Other items			Include all necessary items that need scoped.

On-farm irrigation systems often incorporate collection and regulation ponds either at the upper or lower end of the farm. These ponds can provide water for many other uses including family recreation, stock water, wildlife use, fishing, and fish production. On-farm ponds are valuable assets when fighting fires in rural areas.

Large multiple purpose storage reservoirs that provide for irrigation storage can also provide many other public benefits. Benefits include water-based recreation (boating, swimming, fishing, bird watching, water fowl hunting, etc.), water for wildlife, habitat for waterfowl, flood protection, hydro power, fire protection, waterway transportation, and municipal and industrial water supply. However, large reservoirs can also prevent historical normal migration patterns of wildlife and anadromous fish and can impact cultural resources. These effects should be considered during the planning process.

Irrigation water conveyance systems (open channels) provide open water and adjacent habitat for wildlife. Canals and laterals with high seepage rates help to develop and maintain ground water and wet areas. Where water sources to ground water and wet areas are eliminated by canal linings, mitigation may be necessary. Irrigation pipelines and lined channels can reduce water lost to deep percolation.

Many irrigation organizations that deliver water in open channels also use regulating reservoirs to facilitate delivery rates, amounts, and schedules. Regulating reservoirs can provide water for many benefits besides irrigation purposes.

Large areas of irrigated cropland in arid areas can affect local climate, such as increased humidity. Higher humidity can be good to the human body. It can also be uncomfortable, especially during high crop water use periods. Air movement influences the degree of comfort relating to humidity. Irrigated cropland creates a green oasis in an otherwise barren desert. Green irrigated areas attract people and wildlife in both an urban and rural environment.

Adequate plant growth can reduce or prevent wind erosion during high wind periods on erosion prone soils. Irrigation aids plant growth during high wind periods, but only during the plant growing season. Applying water for preventing wind erosion, as a single practice to provide a wet surface to increase erosion resistance, is short lived. Soil at the surface dries rapidly under windy conditions. With an erodible soil and warm, windy conditions, a continuously moving center pivot irrigation system cannot keep the surface wet enough to prevent wind erosion.

652.1408 Costs and benefits

Economic and environmental guidelines should be used in the evaluation and selection of ecosystem based resource management systems for conservation and pollution control. An analysis of expected costs and benefits of irrigation and waste management system and associated conservation practices are frequently sufficient for the decisionmaking effort. See Chapter 11, Economics, for discussion of terms and principles used in cost analysis. Costs consist of:

- Actual cost of installing irrigation and waste management systems and associated conservation practices
- Cost of operation and maintenance of systems and practices.
- Cost of capital (money used) used to purchase, install, and operate systems. Interest on borrowed money or money diverted from other investments is a project cost.

The number of years each system will be effective with reasonable maintenance and the rate of interest to be used are required to express the total costs in average annual terms. Typically, borrowed money for system installation is for a much shorter period than the estimated life of the system or system components. The two should not be confused.

The monetary value of benefits derived from reduction of irrigation related pollutants and improved water quality is generally difficult to determine. Cost effectiveness of each practice or a combination of practices can be used. Monetary value of cumulative effects is typically more difficult to determine.

Irrigation system improvements, improved irrigation water management, and proper nutrient and pesticide management can typically relate to:

- Decreased water requirement, which equates to reduced diversion requirements reduced pumping costs, reduced water purchased, and reduced system capacity requirement.
- Decreased use of fertilizers.
- Decreased use of pesticides.
- Increased yield or higher product quality, or both.

Decreased irrigation induced soil erosion relates to:

- Maintaining long-term soil productivity.
- Decreased maintenance costs for removal of deposited sediment in runoff collection drains, ponds, roadside ditches, and in water conveyance systems.
- Decreased use of fertilizer.
- Decreased use of pre-emergence herbicides.

652.1409 State supplement

Chapter 15

Resource Planning and Evaluation Tools and Worksheets

Contents:	652.1500	General	15-1
	652.1501	Water quality, water management, and irrigation evaluation tools	15-1
	652.1502	Irrigation system selection, design, costs, and evaluation tools	15-2
	652.1503	Irrigation system planning, design, and evaluation worksheets	15-3
	652.1504	Blank worksheets	15-5
		Irrigation Planning Worksheet	15-7
		Irrigation System Inventory Worksheet	15-9
		Sprinkler Irrigation System Planning/Design Worksheet	15-15
		Irrigation Water Management Plan–Sprinkler Irrigation System	15-21
		Soil Water Holding Worksheet	15-25
		Worksheet, Soil-Water Content	15-26
		Determination of Soil Moisture and Bulk Density (dry) Using Eley	15-27
		Volumeter and Carbide Moisture Tester	
		Typical Water Balance Irrigation Scheduling Worksheet	15-28
		Surface Irrigation System Detailed Evaluation Graded Border	15-29
		Worksheet	
		Profile and Cross Section	15-37
		Cylinder Infiltrometer Curves	15-38
		Cylinder Infiltrometer Test Data	15-39
		Advance and recession curves	15-40
		Cylinder Infiltrometer Curves	15-41
		Depth infiltrated curve	15-42
		Surface Irrigation System Detailed Evaluation Level Border	15-43
		and Basins Worksheet	
		Soil Water Intake Curves	15-49
		Surface Irrigation System Detailed Evaluation Graded	15-51
		Furrow Worksheet	
		Surface Irrigation System Detailed Evaluation Furrow Worksheet	15-57
		Advance and recession curves	15-61
		Flow volume curves	15-62
		Soil water intake curves	15-63
		Surface Irrigation System Detailed Evaluation Contour Ditch	15-65
		Irrigation System Worksheet	

Soil Water Intake Curves	15-71
Cylinder Infiltrometer Test Data	15-72
Sprinkler Irrigation System Detailed Evaluation Periodic Move and	15-73
Fixed Set Sprinkler System	
Lateral move system catch can data	15-79
Sprinkler Irrigation System Detailed Evaluation Center Pivot	15-81
Lateral Worksheet	
Center pivot lateral evaluation, distribution profile of catch	15-88
Sprinkler Irrigation System Detailed Evaluation Contonuous Move,	15-89
Large Sprinkler Gun Type	
Micro Irrigation System Detailed Evaluation Worksheet	15-95
Pumping Plant Detailed Evaluation Worksheet	15-99
Pump performance curve	15-104
Soil Description	15-105
Cylinder Infiltrometer Test Data	15-106
Soil water intake curves	15-107
Intake curve overlay	15-108
Accumulated intake vs. time	15-109
Intake families as used with furrow irrigation	15-110
652.1505 Estimating Soil Moisture by Feel and Appearance	15-111

652.1500 General

Chapter 15 lists and describes resource planning and evaluation tools and worksheets commonly used by the Natural Resources Conservation Service (NRCS). These tools and worksheets can assist the irrigation planner in:

- Addressing irrigation related environmental concerns relating to soil, water, air, plants, and animals.
- Providing technical assistance to the farmer and irrigation decisionmaker in irrigation system—planning, design, cost analysis, evaluation, and management.
- Providing technical assistance for evaluating and planning river basin, watershed, and project activities.

652.1501 Water quality, water management, and irrigation evaluation tools

Computer software programs and models include:

NRCS (SCS) Scheduler—NRCS Scheduler is a computer assisted method to predict up to 10 days ahead when irrigation will be needed. Predictions are based on daily climatic data from a weather station and calculated plant water use. Periodic calibration to actual soil moisture is used to maintain accuracy. Developed by Michigan State University with support from NRCS.

FIRI—Farm Irrigation Rating Index is used to evaluate effects of existing irrigation systems and management, and to evaluate changes. Changes can be improvements or reversals in management techniques and system condition. Developed by NRCS West National Technical Center.

SIDESIGN—Subsurface Irrigation Design program involves an analysis of providing water table control for irrigation through buried conduits. Developed by Michigan State University with support from NRCS.

NLEAP—Nitrate Leaching and Economic Analysis Package. The model provides site specific estimates of nitrate leaching potential under agricultural crops and impacts on associated aquifers. Irrigations are included as precipitation events. This model is generally used as a planning tool. Developed by the Agricultural Research Service (ARS), Water Management Research Laboratory, Fort Collins, Colorado.

CREAMS—A field scale model for Chemical, Runoff, and Erosion from Agricultural Management Systems. This mathematical model evaluates nonpoint source pollution from field-size areas. Developed by ARS laboratories in Chickasha, OK, West Lafayette, IN, and Athens, Georgia.

GLEAMS—Groundwater Loading Effects of Agricultural Management Systems. GLEAMS uses CREAMS technology to evaluate surface chemical response, hydrology, and erosion. It provides a water budget of precipitation, crop evapotranspiration, runoff, deep percolation, soil moisture, and irrigation applications. Crop evapotranspiration is checked and adjusted for localized conditions. Developed by University of Georgia in cooperation with ARS, Southeast Watershed Laboratory, Tifton, Georgia.

WEPP—Water Erosion Prediction Program is proposed to provide an analysis of precipitation and irrigation related erosion and sediment deposition. When complete, WEPP will include furrow and border surface irrigation and periodic move, fixed, and continuous move sprinkle irrigation systems. The FUSED, RUSLE, and SPER programs are available for field use until WEPP is validated and available. Being developed by ARS, National Erosion Laboratory, (Purdue University), West Lafayette, Indiana; and (University of Nebraska), Lincoln, Nebraska.

SWRRB—This basin scale water quality model process considers surface runoff, return flow percolation, evapotranspiration, transmission losses, pond storage, sedimentation, and crop growth. Crop evapotranspiration must be checked and may need to be localized. Developed by ARS, Temple, Texas.

EPIC—Process considers climate factors, hydrology, soil temperature, erosion, sedimentation, nutrient cycling, tillage, management, crop growth, pesticide and nutrient movement with water and sediment, and field scale costs and returns. Crop evapotranspiration is checked and adjusted for local conditions. Developed by ARS, Temple, Texas.

DRAINMOD—An evaluation tool for analysis of water table control for subsurface drainage systems. Included is an estimated value for upward water movement (upflux) based upon specific soil series. Developed by North Carolina State University with support from NRCS.

Instream Water Temperature Model—The model provides a process to predict instream water temperature based on either historical or synthetic hydrological, meteorological parameters, streamside vegetation, and stream channel geometry.

652.1502 Irrigation system selection, design, costs, and evaluation tools

Many programs are available from commercial sources and Universities. Most need to be purchased, but some are available as *cooperative agency programs*. A few require site licenses to use multiple program copies at several locations at one time. Several irrigation programs are available from ARS, universities, and the U.S. Bureau of Reclamation. Some of the more common programs available include:

- REF-ET—Reference crop Evapotranspiration model, from Utah State University.
- SIRMOD—Surface Irrigation Model includes surge and conventional analysis for furrow irrigation, from Utah State University.
- CPNOZZLE—Center Pivot Nozzling and surface storage program, from University of Nebraska.
- SPACE—Sprinkler Profile And Coverage Evaluation program evaluates all sprinkler heads manufactured and currently available, from California Agricultural Technology Institute, California State University.
- SRFR—Surface irrigation simulation program uses zero inertia and kinematic wave relationships to model surface irrigation, from ARS, Phoenix, Arizona.
- AGWATER—Surface irrigation system (furrow, border) model using measured advance time and field specific information for management improvements (inflow, time of set, length of run), from California Polytechnic State University.
- PUMP—Centrifugal pump selection program, from Cornell Pump Company, Portland, Oregon.
- CATCH3D—Sprinkler pattern overlap evaluation and 3D plot program, from Utah State University.
- Water Management Utilities, Interactive Simulation of One-Dimensional Water Movement in Soils, IRRIGATE—An irrigation decision aid, potential evapotranspiration, citrus irrigation scheduling.
- CMLS—Chemical Movement in Layered Soils, from University of Florida.
- Flowmaster—Open channel flow and pressure pipeline design program, from Haestad Methods, Inc., Waterbury, Connecticut.
- KYPIPE2—Pipe network flow analysis program, from Haestad Methods, Inc., Waterbury, Connecticut.

652.1503 Irrigation system planning, design, and evaluation worksheets

Example evaluations and blank worksheets are included at the back of this chapter. They may be copied and used as needed. They include:

Irrigation Planning

- Irrigation Planning
- Irrigation System Inventory

Irrigation System Design

- Sprinkler Irrigation System Planning/Design

Irrigation System Evaluation

- Walk Through Sprinkler Irrigation System Analysis

- Sprinkler Irrigation Systems Evaluation

- Periodic Move Sprinkler—Side Wheel-roll, Lateral Tow, Hand Move and Fixed (Solid) Set Systems
 - Continuous/Self Move Sprinkler—Pivot System

- Pumping Plant Evaluation

- Electric Motor Powered
 - Natural Gas Engine Powered

- Micro Irrigation Systems Evaluation

- Surface Irrigation Systems Evaluation

- Graded Borders
 - Basins, Level Border
 - Graded Furrows
 - Level furrows

Irrigation Water Management

- Irrigation Water Management Plan
- Soil Moisture—Feel and Appearance Method, Speedy Moisture Meter and Eley Volumeter
- Crop and Soil Data for Irrigation Water Management
- Checkbook Method of Irrigation Scheduling
- Pan Evaporation Method of Irrigation Scheduling

652.1504 Blank worksheets

Irrigation Planning Worksheet

OWNER/OPERATOR _____ FIELD OFFICE _____
 JOB DESCRIPTION _____
 LOCATION _____
 ASSISTED BY _____ DATE _____

Soil—Data for limiting soil

Soil series	Percent of area (%)	Cumulative AWC					Depth to restrictive layer ¹	Intake fam., grp. max. rate
		1 ft (in)	2 ft (in)	3 ft (in)	4 ft (in)	5 ft (in)		

¹ Actual observed depth in the field

Maximum time between irrigations for any method/system based on peak crop ET

Crop	Management root zone (ft)	Total AWC (in)	MAD percent (in)	Maximum net replacement		Peak daily crop ET (in/d)	Maximum irrigation frequency (days)
				(in/d)	(days)		

Minimum system flow requirement for irrigation system

System description	Depth of irrigation application			Peak daily crop ET (in/d)	Max. irrig. frequency (days)	Minimum system flow requirement total flow	
	Net (F _N) (in)	Efficiency (%)	Gross (F _G) (in)			(gpm)	(ft ³ /s)

Minimum dependable flow available to system _____ gpm, ft³/s, inches, etc.

Total irrigated area _____ acres. Total operating hours per day _____ .

Irrigation Planning Worksheet—Continued

NAME _____ DATE _____ PREPARED BY _____

Weighted monthly crop evapotranspiration

The following process is used where more than one crop is grown under the same irrigation system; i.e., several fields, farm group, district.

Crop	Acres (ac)	Monthly crop evapotranspiration - ET _C							
		Depth ¹ (in)	Volume ² (ac-in)	Depth ¹ (in)	Volume ² (ac-in)	Depth ¹ (in)	Volume ² (ac-in)	Depth ¹ (in)	Volume ² (ac-in)
Total									
Weighted average crop ET ³									

Computed peak daily crop evapotranspiration⁴

Net irrigation depth applied (f _n) (in)	Highest weighted monthly average crop ET (in)	Peak period average daily crop ET (in)

¹ Calculated monthly crop ET, inches.

² Calculated volume of water needed monthly crop ET = ac x ET_C = _____ acre-inches.

³ Calculated weighted monthly crop ET = Total Volume/ Total Area = _____ inches.

⁴ Determined from table 2-55, Part 623, Chapter 2, Irrigation Water Requirements, or from formula:

$$ET_d = 0.034 ET_m^{1.09} F_n^{-0.09}, \quad \text{Where: } ET_d = \text{average daily peak crop ET}$$

$$ET_m = \text{average crop ET for peak month}$$

$$F_n = \text{net depth of water application per irrigation}$$

Irrigation System Inventory Worksheet

OWNER/OPERATOR _____ FIELD OFFICE _____

JOB DESCRIPTION _____

LOCATION _____

ASSISTED BY _____ DATE _____

(Collect and fill out only portions of this form that apply and are needed)

Area irrigated _____ acres

Crops

Crops now grown			
Typical planting date			
Typical harvest date			
Typical yield (unit)	()	()	()
Age of planting			
Cultivation and other cultural practices			

Water

Water source(s)				
irrigation organization				
Water available (ft ³ /sec, gpm, miners inches, mg/da)				
Seasonal total water available (ac-ft, million gal)				
Water availability	continuous	demand	rotation	fixed schedule
Typical water availability times (schedule and ordering procedure)				
Method of determining when and how much to irrigate:				
Is flow measuring device maintained and used?				
Method of measuring water flow rate				
Water quality: Sediment			Debris, moss	
Electrical conductivity		mmhos/cm	SAR	
Comments				

Example Irrigation System Inventory Worksheet—Continued

NAME _____ DATE _____ PREPARED BY _____

Soils (principal soil in field)

Soil # 1

Map symbol		Soil series & surface texture		
Percentage of field (%)		Area (acres)		
Depth	Texture	AWC (in/in)	AWC (in)	Cum AWC (in)
Depth to water table or restrictive layer ¹				
Intake family/intake group/max application rate				
Comments				

Soil # 2

Map symbol		Soil series & surface texture		
Percentage of field (%)		Area (acres)		
Depth	Texture	AWC (in/in)	AWC (in)	Cum AWC (in)
Depth to water table or restrictive layer ¹				
Intake family/intake group/max application rate				
Comments				

Soil # 3

Map symbol		Soil series & surface texture		
Percentage of field (%)		Area (acres)		
Depth	Texture	AWC (in/in)	AWC (in)	Cum AWC (in)
Depth to water table or restrictive layer ¹				
Intake family/intake group/max application rate				
Comments				

¹ If restrictive for root development or water movement

Irrigation System Inventory Worksheet—*Continued*

NAME _____ DATE _____ PREPARED BY _____

Water supply and distribution system

Supply system to field (earth ditch, lined ditch, plastic pipeline, etc.):

Type
Size
Capacity (ft ³ /sec, gpm, miners inches, mgal/day)
Pressure/Elevation at head of field or turnout (lb/in ²) (ft)
System condition
Estimated conveyance efficiency of supply system (%)

In-field distribution system (earth or lined ditch, buried pipe, surface portable pipe, lay flat tubing):

Type
Size
Capacity
Total available static head (gravity) (ft)
System condition
Estimated efficiency of delivery system (%)
Comments

Water application system

Existing sprinkler system (attach design and/or system evaluation. if available):

Type system (center pivot, sidewheel-roll, hand move, traveler, big gun)
Manufacturer name and model
Tower spacing (pivot or linear) (ft) End gun (pivot)?
Wheel size (sidewheel-roll) diameter
Type of drive
Pressure at lateral entrance (first head) (lb/in ²)
Mainline diameter/length
Lateral diameter/length
Lateral spacing (S ₁) Sprinkler head spacing (S _m)
Sprinkler make/model
Nozzle size(s) by type
Design nozzle pressure (lb/in ²) Wetted diameter (ft)
(Attach sprinkler head data for pivot)
Maximum elevation difference: Along lateral
Between sets
Application efficiency low 1/4 (E _q) (%) (Estimated or attach evaluation)
Wind - Prevailing direction and velocity
Comments

Irrigation System Inventory Worksheet—Continued

NAME _____ DATE _____ PREPARED BY _____

Existing surface system (attach system evaluation if available)

Type of system (graded border, level border, graded furrow, level furrow, contour levee, contour ditch, wild flooding)			
Leveled fields:	Field slope:	In direction of irrigation	
		ft/ft	
Cross slope		ft/ft	
Smoothness:	<input type="checkbox"/> Rough	<input type="checkbox"/> Smooth	<input type="checkbox"/> Very smooth
			Laser equipment used <input type="checkbox"/> yes <input type="checkbox"/> no
Border or levee width		Furrow/corrugation/rill spacing	
	ft	in	
Length of run:	Minimum	Maximum	Average
	ft	ft	ft
Number of furrows or borders per set			
Border or levee dike heights			
Application efficiency, low 1/4 (E _q)		% (Estimated or attach evaluation)	
General maintenance of system			

Drainage, tail water reuse facility

Method for collection and disposal of field runoff (tailwater, precipitation)
Final destination of runoff water
Surface/subsurface drainage system
Environmental impacts of existing drainage system

Existing micro irrigation system (Attach design or system evaluation if available)

Type of system:	Drip emitters	Mini spray/sprinklers	Line source
Spacing between discharge devices along distribution laterals		(ft, in)	
Laterals - diameter, length			
Main lines and submains - diameter, length, etc.			
Spacing between distribution laterals		(ft, in)	
Average application device discharge pressure (lbs/in ²)			
Are pressure compensating devices required?		<input type="checkbox"/> yes	<input type="checkbox"/> no
Are pressure compensating devices used?		<input type="checkbox"/> yes	<input type="checkbox"/> no
Average application device discharge (gph, gpm)			
Area irrigated by one irrigation set		(acres)	
Typical irrigation set time		(hr, min)	
Maximum elevation difference with one irrigation set		(ft)	
Type and number of filters used			
Irrigation is initiated by: <input type="checkbox"/> manual control <input type="checkbox"/> programmed timer <input type="checkbox"/> clock timer <input type="checkbox"/> soil moisture sensing device			
Comments:			

Irrigation System Inventory Worksheet—Continued

NAME _____ DATE _____ PREPARED BY _____

Existing subsurface irrigation system

Water table control type and number of system or segments	
Water table control devices	<input type="checkbox"/> flashboard <input type="checkbox"/> float
Buried laterals	<input type="checkbox"/> diameter <input type="checkbox"/> spacing <input type="checkbox"/> depths
Water table elevation(s): Existing	Planned

Month	Elevation	Depth below surface

**Pumping plant
 Pump**

(Attach pump characteristic curves and/or pump system analysis if available)			
Pump elevation above mean sea level (approx) (ft)			
Pump type: <input type="checkbox"/> centrifugal <input type="checkbox"/> turbine <input type="checkbox"/> submersible <input type="checkbox"/> Propeller <input type="checkbox"/> axial flow			
Make		Model	
Electric motor RPM		Engine operating RPM	
Pump design discharge		gpm @ _____ ft or lb/in ²	
Impeller size	Impeller diameter	Number of impellers	
Pressure at outlet of pump or inlet to pipeline		lb/in ²	date
Discharge	gpm	How measured	date
Valves, fittings			

Power unit

Rated HP	at RPM
----------	--------

Gear or belt drive mechanism

Type (direct, gear, belt)	
RPM at driver	RPM at pump
Energy (A pump evaluation is required to get this data)	
Energy input (from evaluation) (KW) (gal/hr) (mcf)	
Pumping plant efficiency (from evaluation) (%)	
Energy cost per acre foot (from evaluation)	
General condition of equipment, problems	

Irrigation System Inventory Worksheet—Continued

NAME _____ DATE _____ PREPARED BY _____

Irrigation management

Irrigation scheduling method(s)
Typical number of irrigations per season
Typical time between irrigations
Set times or time per revolution
Method of determining soil moisture
Typical water application per (set, revolution, pass)
Source, availability and skill of irrigation labor

Comments about management of the existing system and reasons for improvement. What are the objectives of the irrigation decisionmaker?

What management level is planned?

Other observations and comments

Sprinkler Irrigation System Planning/Design Worksheet

NAME _____ DATE _____ PREPARED BY _____

DISTRICT _____ COUNTY _____ ENGR JOB CLASS _____

Inventory

Water source _____ Amount available _____ ft³/sec _____ gpm _____ acre-ft _____ Seasonal variation _____

Power source: Electric _____ volts, _____ phase; Internal combustion engine _____ fuel type; Other _____

Soils Data

Design Soil Series	Available water capacity, AWC (in/ft depth)					Depth to ¹		Sprinkler intake rate (in/hr)
	0-1	1-2	2-3	3-4	4-5	Inhibiting layer (ft)	Water table (ft)	

¹ Actual observed depth in the field.

Crop Evapotranspiration (Monthly)

Crops	Acres	Month		Month		Month	
		Depth (in)	Volume (ac-in)	Depth (in)	Volume (ac-in)	Depth (in)	Volume (ac-in)
Totals (1)		(2)		(3)		(4)	

Crop Weighted Evapotranspiration (Monthly) (Note: Maximum Monthly Total ET is greatest of nos. 2, 3, or 4 above)

ET, depth = $\frac{\text{Maximum Total Monthly ET, ac-in/mo}}{\text{Total Acres, A (1)}}$ = _____ = _____ in /mo

Irrigation Requirements

Crops	Root zone depth ² (ft)	Total AWC (in)	Management allowed depletion (%)	Max Net replacement (in)	Peak daily ET (in)	Max freq @ peak E T @ max net (days)

² Use weighted peak monthly ET and net irrigation to determine weighted peak daily E T.

Sprinkler Irrigation System Planning/Design Worksheet—Continued

NAME _____ DATE _____ PREPARED BY _____

Design Data — (Based on weighted crop ET, _____ % irrigation efficiency)

	Application		Weighted ² peak daily crop ET (in)	Frequency, F (days)	System requirements	
	Net, D (in)	Gross F _g (in)			Total gpm, Q	gpm/ac

² Use weighted peak monthly ET and net irrigation to determine weighted peak daily E T.

Q = system requirements—gpm
 H = Total operating hours/day
 (suggest using 23 hours for one move per day)
 (suggest using 22 hours for two moves per day)

$$Q = \frac{453 A D}{F H \text{ Eff}/100} = \text{_____ gpm} = \text{_____ gpm}$$

Sprinkler head spacing, (S_L) _____ ft, Lateral spacing on mainline (S_M) _____ ft, Minimum Required wetted diameter = _____ ft

Sprinkler head: make _____; model _____; nozzle size _____; lb/in² _____ gpm _____; wetted dia _____ ft

Application rate _____ in/hr, Application time _____ hr/set. Net application = (_____ in/hr) (_____ eff) (_____ hr/set) = _____ in

Maximum irrigation cycle = Net application _____ in/peak ET in/d = _____ days

Minimum number of laterals = _____ number of lateral sites _____
 (irrigation frequency, _____ days) (moves/day, _____)

Designed laterals: Number _____, Diameter _____ in, Type _____, Moves/day _____

Total number of sprinkler heads = (number of laterals) (number of heads/lateral) = _____

System capacity = (Total number of sprinkler heads _____) (gpm/head _____) = _____ gpm

Lateral design

Allowable pressure difference along lateral = 0.2 (sprinkler head operating pressure in lb/in²) = _____ lb/in²

Actual head loss (worst condition) _____ lb/in²

Pressure required at mainline: P = (sprinkler head lb/in² _____) + (0.75) (Lateral friction lb/in² _____) +/- (ft elev) / (2) (2.31) = _____ lb/in²

(plus for uphill flow in lateral, minus for downhill flow). Use sprinkler head lb/in² only if elevation difference along lateral is = or > 0.75 (lateral friction loss lb/in²)

(2.31). Under this condition, flow regulation may be required at some sprinkler heads to maintain proper sprinkler head operating near the mainline.

Sprinkler Irrigation System Planning/Design Worksheet—Continued

NAME _____ DATE _____ PREPARED BY _____

Mainline Design

Mainline material _____ (IPS, PIP, SDR, CLASS) lb/in² rating _____, other description, _____

Friction factor used _____. Formula (check one) Hazen-Williams Manning's Darcy-Weibach Other (name) _____

Station		Diameter pipe (in)	Flow (gpm)	Velocity (fps)	Distance (ft)	Friction loss (ft/100 ft)	Friction loss this section (ft)	Accumulated friction loss (ft)	Remarks
From	To								

NOTE: desirable velocities—5 ft/sec or less in mainlines, 7 ft/sec or less in sprinkler laterals.

Determination of Total Dynamic Head (TDH)

Pressure required at main _____ lb/in² _____ ft

Friction loss in main _____ lb/in² _____ ft

Elevation raise/fall in main _____ lb/in² _____ ft (2.31 feet = 1 psi pressure)

Lift (water surface to pump) _____ lb/in² _____ ft

Column friction loss _____ lb/in² _____ ft

Miscellaneous loss _____ lb/in² _____ ft

Total (TDH) _____ lb/in² _____ ft (NOTE; TDH must be in feet for horsepower equation)

$$\text{Approximate brake horsepower} = \frac{\text{TDH (ft)} \times \text{Q (gpm)}}{3960 \times \text{Eff} / 100} = \frac{\text{_____ ft} \times \text{_____ gpm}}{3960 \times \text{_____ \%} / 100} = \text{_____ HP}$$

Mean sea level elevation of pump _____ ft (NOTE: check required versus available NPSL for centrifugal pumps)

Pump curve data attached yes no , If not, pumping plant efficiency assumed = _____% (recommended using 65-75%)

Bill of materials attached yes no

Sprinkler Irrigation System Planning/Design Worksheet—Continued

NAME _____ DATE _____ PREPARED BY _____

Other Design Considerations

Item	Evaluation performed	NOT needed	Location	Size
Measuring device				
Expansion couplers				
Reducers				
Enlargers (expanders)				
Manifolds				
Bends & elbows				
Tees				
Valved outlets				
Surge facilities (valves, chambers)				
Control valves				
Check non-return flow valves				
Pressure relief valves				
Air-vacuum valves				
Drain facilities				
Thrust blocks				
Anchors				
Pipe supports				
Other				

Remarks

Special drawing(s) attached _____

Irrigation system design by _____ Date _____

Reviewed and approved by _____ Date _____

Sprinkler Irrigation System Planning/Design Worksheet—Continued

NAME _____ DATE _____ PREPARED BY _____

Irrigation System Location and Layout Map

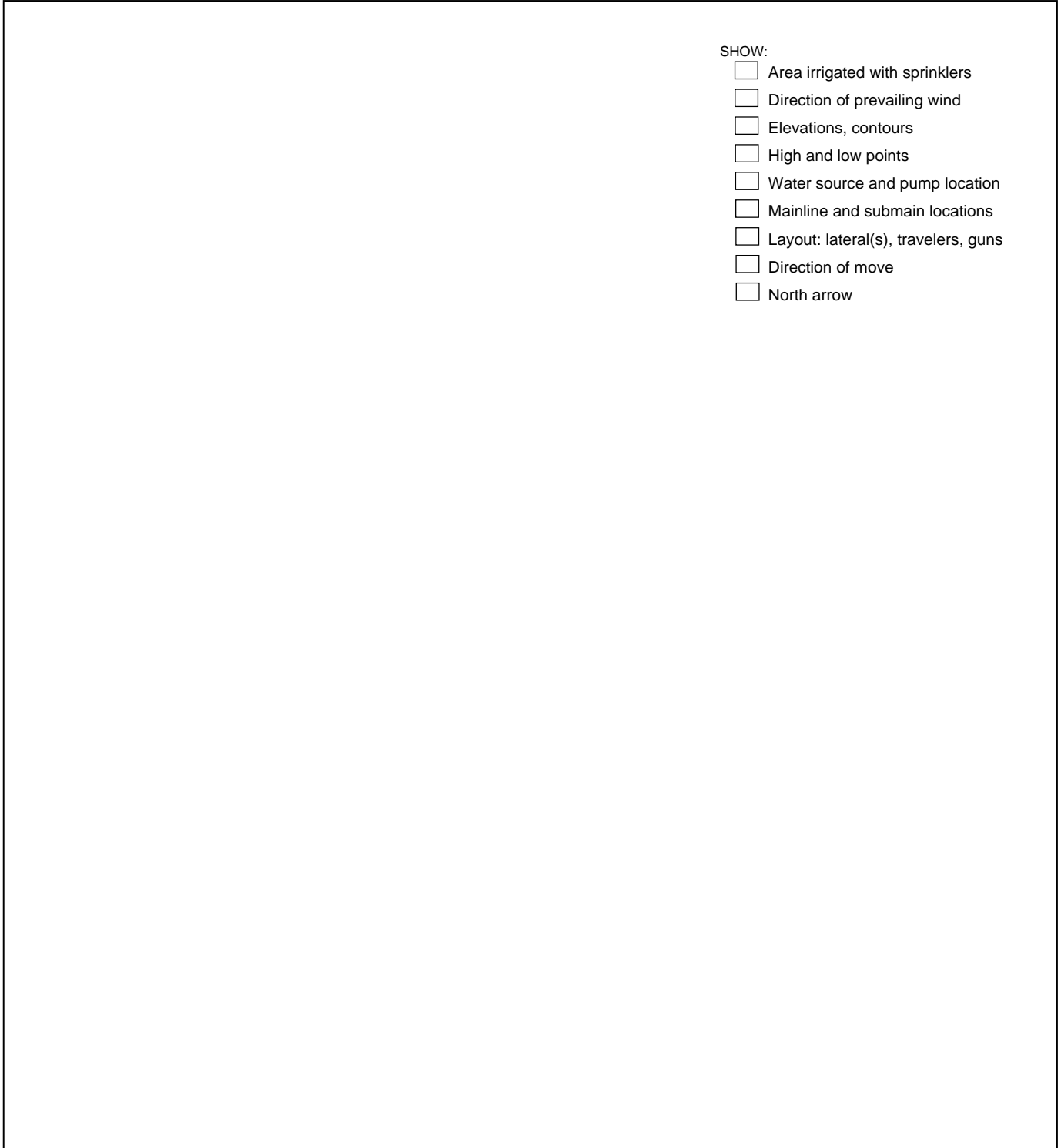

SHOW:

- Area irrigated with sprinklers
- Direction of prevailing wind
- Elevations, contours
- High and low points
- Water source and pump location
- Mainline and submain locations
- Layout: lateral(s), travelers, guns
- Direction of move
- North arrow

Scale	Community	Section	Township	Range
-------	-----------	---------	----------	-------

Irrigation Water Management Plan—Sprinkler Irrigation System

NAME _____ DATE _____ PREPARED BY _____
 DISTRICT _____ COUNTY _____ ENGR JOB CLASS _____

Crop information

Field number(s)				
Crop irrigated				
Acres Irrigated (acres)				
Normal rooting depth (feet, inches)				
Management allowable depletion (MAD) (percent, inches)				
Peak daily crop requirements (ac-in/day)				
Average annual net irrigation requirements (ac-in/ year)				

Soil Information

Soils series and surface texture		
Capability class		
Allowable soil loss (T=tons per-acre per year)		
Wind Erodibility Group (WEG)		
Actual on-site (observed and measured) average root zone depth		
Total available water capacity (AWC) of soil plant root zone		
Soil intake (Maximum application rate for sprinkler system)		
Available water capacity (AWC) for crop rooting depth:	Depth (inches)	AWC
		(inch/inch) (total inches)

Irrigation system management information

Irrigation system
Source of water
Delivery schedule
Estimated overall irrigation efficiency
Management allowable depletion for pasture
Irrigation set time to apply full irrigation and replace full MAD
Gross application
Net application
Actual gross sprinkler application rate
Irrigation system flow capacity requirement for full time irrigation, Q (gpm)

Irrigation Water Management Plan— Sprinkler Irrigation System—*Continued*

NAME _____ DATE _____ PREPARED BY _____

Irrigation scheduling Information

Month	Monthly net ¹ irrigation requirement (inches)	Crop evapo- transpiration use rate (in/day)	Irrigation frequency needed (days)	Average ² number of Irrigations needed
April				
May				
June				
July				
August				
September				
October				
Total				

¹ Net irrigation requirement (NIR) represents crop evapotranspiration less effective rainfall.

² Assuming a full soil profile at start of season. Check soil moisture before irrigating. Account for rainfall that can replace soil moisture depletion. If soil moisture depletion is less than 50% wait for a few days and check it again.

Warmer than “average” months will typically require additional irrigation water; cooler than “average months will typically require less irrigation water; months with more than “average” effective rainfall will typically require less irrigation water.

Only operate the system when needed to furnish water for crop needs. The preceding irrigation schedule can be used as a guide to determine when to irrigate. It is a guide only for average month and year conditions. Optimizing use of rainfall to reduce unnecessary irrigations during the growing season is a good management practice. In semi-humid and humid areas, it is recommended to not replace 100 percent of the soil moisture depletion each irrigation. Leave room in the plant root zone for containing water infiltration from rainfall events. This will vary with location, frequency, and amount of rainfall occurring during the growing season. It should be approximately 0.5 to 1.0 inches.

Maintaining to a higher soil moisture level (MAD) typically does not require more irrigation water for the season, just more frequent smaller irrigations. This is especially true with crops such as root vegetables, potatoes, onions, garlic, mint, and sweet corn.

The attached chart for evaluating soil moisture by the feel and appearance method can be used to help determine when to irrigate. Other common methods to monitor crop water use and soil moisture include: plant signs (crop critical moisture stress periods), atmometer, evaporation pan (applying appropriate factors), tensiometers, electrical resistance blocks (moisture blocks), and crop water stress index (CWSI gm).

NRCS (SCS) - SCHEDULER computer software is available to provide calculations of daily crop evapotranspiration when used with local daily weather station values. On-site rainfall data is necessary to determine effective rainfall, whereas local weather station rainfall data is not sufficiently accurate due to spatial variability. Current rainfall and soil moisture data can be input manually or electronically to assist in predicting when irrigation is needed.

Irrigation Water Management Plan—Sprinkler Irrigation System—Continued

NAME _____ DATE _____ PREPARED BY _____

A properly operated, maintained, and managed sprinkle irrigation system is an asset to your farm. Your system was designed and installed to apply irrigation water to meet the needs of the crop without causing erosion, runoff, and losses to deep percolation. The estimated life span of your system is 15 years. The life of the system can be assured and usually increased by developing and carrying out a good operation and maintenance program.

Pollution hazards to ground and surface water can be minimized when good irrigation water management practices are followed. Losses of irrigation water to deep percolation and runoff should be minimized. Deep percolation and runoff from irrigation can carry nutrients and pesticides into ground and surface water. Avoiding spills from agricultural chemicals, fuels, and lubricants. will also minimize potential pollution hazards to ground and surface water.

Leaching for salinity control may be required if electrical conductivity of the irrigation water or soil water exceeds plant tolerance for your yield and quality objectives. If this condition exists on your field(s), a salinity management plan should be developed.

The following are system design information and recommendations to help you develop an operation and maintenance plan (see irrigation system map for layout):

- average operating pressure = _____ lb/in² (use a pressure gage to check operating pressure)
- nozzle size = _____ inch (use shank end of high speed drill bit to check nozzle wear)
- average sprinkler head discharge _____ gpm
- sprinkler head rotation speed should be 1 - 2 revolutions per minute
- sprinkler head spacing on lateral = _____ ft; outlet valve spacing on main line _____ ft
- lateral, number(s) _____, _____ ft, _____ inch diameter _____
- main line = _____ ft _____ inch diameter, type _____, class _____
- pump = _____, _____ gpm @ _____ ft Total Dynamic Head (TDH)

Make sure that all measuring devices, valves, sprinkler heads, surface pipeline, and other mechanical parts of the system are checked periodically and worn or damaged parts are replaced as needed. Always replace a worn or improperly functioning nozzle with design size and type. Sprinkler heads operate efficiently and provide uniform application when they are plumb, in good operating condition, and operate at planned pressure. Maintain all pumps, piping, valves, electrical and mechanical equipment in accordance with manufacturer recommendations. Check and clean screens and filters as necessary to prevent unnecessary hydraulic friction loss and to maintain water flow necessary for efficient pump operation.

Protect pumping plant and all associated electrical and mechanical controls from damage by livestock, rodents, insects, heat, water, lightning, sudden power failure, and sudden water source loss. Provide and maintain good surface drainage to prevent water pounding around pump and electrical equipment. Assure all electrical/gas fittings are secure and safe. Always replace worn or excessively weathered electric cables and wires and gas tubing and fittings when first noticed. Check periodically for undesirable stray currents and leaks. Display appropriate bilingual operating instructions and warning signs as necessary. During non-seasonal use, drain pipelines and valves, secure and protect all movable equipment (i.e. wheel lines).

If you need help developing your operation and maintenance plan, contact your local USDA Natural Resources Conservation Service office for assistance.

Soil Water Holding Worksheet

Field _____ Location in field _____
 Year _____ By _____
 Crop _____
 Planting data _____ Emergence data _____
 Soil name if available _____

Factor	Season	
	1st 30 days	Remainder of season
Root zone depth or max soil depth - ft		
Available water capacity AWC - in		
Management allowed deficit MAD - %		
Management allowed deficit MAD - in		

(Note: Irrigate prior to the time that SWD is equal to or greater than MAD - in)

Estimated irrigation system application efficiency _____ percent

Data obtained during first field check					Data obtained each check		
(1) Depth range (in)	(2) Soil layer thickness (in)	(3) Soil texture	(4) Available water capacity (AWC) (in/in)	(5) AWC in soil layer (in)	(6) Field check number	(7) Soil water deficit (SWD) (%)	(8) Soil water deficit (SWD) (in)
					1		
					2		
					3		
					4		
					5		
					6		
					7		
					8		
					1		
					2		
					3		
					4		
					5		
					6		
					7		
					8		

Total AWC for root zone depth of _____ ft=

Total AWC for root zone depth of _____ ft=

$AWC(5) = \text{layer thickness}(2) \times AWC(4)$

$SWD(8) = \frac{AWC(5) \times SWD(7)}{100}$

SWD summary		
Check number	Check date	SWD totals
1		
2		
3		
4		
5		
6		
7		
8		

Worksheet
Soil-Water Content
(Gravimetric Method)

Land user _____ Date _____ Field office _____

Taken by _____ Field name/number _____

Soil name (if available) _____ Crop _____ Maximum effective root depth _____ ft

Depth range inches	Soil layer thickness inches d	Soil texture	Sample			Tare weight g Tw	Net dry weight g Dw	Volume of sample cc Vol	Moisture per-centage % Pd	Bulk density g/cc Dbd	Soil-water content in/in SWC	Layer water content inches TSWC
			Wet weight g WW	Dry weight g DW	Water loss g Ww							

Dry weight (Dw) of soil = DW - TW = _____g Weight of water lost (Ww) = WW - DW = _____g Bulk density (Dbd) = $\frac{Dw(g)}{Vol (cc)}$ = _____g/cc

Percent water content, dry weight Pd = $\frac{Ww}{Dw} \times 100 =$ _____% Soil-water content (SWC) = $\frac{Dbd \times Pd}{100 \times 1} =$ _____in/in

Total soil-water content in the layer (TSWC) = SWC x d = _____inches

**Determination of Soil Moisture and Bulk Density (dry)
 Using Eley Volumeter and Carbide Moisture Tester**

Farm _____ Location _____ SWCD _____
 Crop _____ Soil type _____ Date _____ Tested by _____

(1)	(2)	(3)	(4)	(5)	(6)	(7)	(8)	(9)	(10)	(11)	(12)	(13)	
Texture	Thickness of layer	Volumeter							Bulk density (g/cc)	Soil-water content (in)	Soil-water content at field capacity	Soil-water deficit (in)	
		Reading before (cc)	Reading after (cc)	Volume (cc)	% Wet wt.	% Dry wt.	% Wilting point	% Soil-water					
	d			V	W _p	P _d	P _w	SWC _p	Db _d	SWC	AWC	SWD	
Wet weight of all samples in grams unless otherwise shown.										Totals			

$$Db_d = \frac{26}{\frac{V(1 + P_d)}{100}}$$

$$SWC = \frac{Db_d \times SWC_p \times d}{100 \times 1}$$

$$SWC_p = P_d - P_w$$

Typical Water Balance Irrigation Scheduling Worksheet

Grower _____ Field ID _____ Crop _____
Planting date _____ Full cover date _____ Harvest date _____
Soil water holding capacity (in/ft) _____ ; _____ ; _____ ; _____ Rooting depth _____
Management allowable depletion _____ Minimum soil-water content _____

Date	Daily crop ET (in)	Forecast crop ET (in)	Cum total ET (in)	Rainfall (in)	Irrigation applied (in)	Cumulative total irrigation (in)	Allowable depletion balance (in)	Soil-water content (in)	Predicted irrigation date

**Surface Irrigation System
 Detailed Evaluation Graded Border Worksheet**

Land user _____ Field office _____

Field name/number _____

Observer _____ Date _____ Checked by _____ Date _____

Field Data Inventory:

Field area _____ acres

Border number _____ as counted from the _____ side of field

Crop _____ Root zone depth _____ ft MAD _____ %

Stage of crop _____

Soil-water data for controlling soil:

Station _____ Moisture determination method _____

Soil series name _____

Depth	Texture	AWC (in)*	SWD (%)*	SWD (in)*
_____	_____	_____	_____	_____
_____	_____	_____	_____	_____
_____	_____	_____	_____	_____
_____	_____	_____	_____	_____
Total		_____	_____	_____

MAD, in = $\frac{\text{MAD, \%} \times \text{total AWC, in}}{100}$ = _____ = _____ in

Comments about soils: _____

Typical irrigation duration _____ hr, irrigation frequency _____ days

Typical number of irrigation's per year _____

Annual net irrigation requirement, NIR (from irrigation guide) _____ in

Type of delivery system (gated pipe, turnouts, siphon tubes) _____

Delivery system size data (pipe size & gate spacing, tube size & length, turnout size) _____

Border spacing _____, Strip width _____, Wetted width _____, Length _____

Field Observations:

Evenness of water spread across border _____

Crop uniformity _____

Other observations _____

NOTE: MAD = Management allowed deficit AWC = Available water capacity SWD = Soil water deficit

**Surface Irrigation System
 Detailed Evaluation Graded Border Worksheet**

Data: Inflow _____ Outflow _____

Type of measuring device _____

Clock ^{1/} time	Elapsed time (min)	Δ T (min)	Gage H (ft)	Flow rate (gpm)	Average flow rate (gpm)	Volume ^{2/} (ac-in)	Cum. volume (ac-in)
Turn on							
Turn off							

Total volume (ac-in) _____

Average flow rate =

Total irrigation volume (ac-in) x 60.5 = _____ = _____ ft³/s Inflow time (min)

Unit flow:

$q_u = \frac{\text{Average flow rate}}{\text{Border strip spacing}} = \text{_____} = \text{_____} \text{ ft}^3/\text{s}/\text{ft}$

1/ Use a 24-hour clock reading; i.e., 1:30 p.m. should be recorded as 1330 hours.

2/ Flow rate to volume factors:

Find volume using ft³/s: Volume (ac-in) = .01653 x time (min) x flow (ft³/s)

Find volume using gpm: Volume (ac-in) = .00003683 x time (min) x flow (gpm)

Surface Irrigation System Detailed Evaluation Graded Border Worksheet

Graded border advance recession data

Station (ft)	Advance time			Recession time			Opportunity time (T _o)
	Clock* time	Δ T (min)	Elapsed time (min)	Clock* time	T (min)	Elapsed time ^{1/} (min)	

Use a 24-hour clock reading; i.e., 1:30 p.m. would be recorded as 1330 hours.

1/ Time since water was turned on.
 2/ Inflow time = turn off time - turn on time.

**Surface Irrigation System
 Evaluation Graded Border Worksheet**

Depth infiltrated

Station	Opportunity time ^{1/} T _Q (min)	Typical intake curve		Adjusted intake curve	
		Depth ^{2/} infiltrated (in)	Ave. depth infiltrated (in)	Depth ^{3/} infiltrated (in)	Ave. depth infiltrated (in)
Sum of ave. depths					

- ^{1/} Difference in time between advance and recession curve.
- ^{2/} From "typical" cumulative intake curve.
- ^{3/} From "adjusted" cumulative intake curve.

Average depth infiltrated (typical)
 = $\frac{\text{Sum of depths (typical)}}{\text{Length (hundreds of feet-extended)}}$ = _____ = _____ in

Extended border area (acres)
 = $\frac{\text{Extended border length} \times \text{wetted width}}{43,560}$ = $\frac{\text{_____}}{43,560}$ = _____ acres

Actual average depth applied to extended border length
 = $\frac{\text{Ave inflow (ft}^3/\text{s)} \times \text{duration (hr)}}{\text{Extended border area (acres)}}$ = _____ = _____ in

Average depth infiltrated (adjusted)
 = $\frac{\text{Sum of depths (adjusted)}}{\text{Length (hundreds of feet - extended)}}$ = _____ = _____ in

Note: Should be close to actual depth applied.

**Surface Irrigation System Detailed Evaluation
 Graded Border Worksheet**

Average depth infiltrated low 1/4 (LQ):

Low 1/4 strip length = $\frac{\text{Actual strip length}}{4} = \frac{\text{Actual strip length}}{4} = \text{_____} \text{ ft}$

LQ = $\frac{(\text{Depth infiltrated at begin of L1/4 strip}) + (\text{Depth infiltrated at the end of L1/4 strip})}{2}$

= $\frac{\text{_____}}{2} = \text{_____} \text{ in}$

Areas under depth curve:

- 1. Whole curve _____ sq in
- 2. Runoff _____ sq in
- 3. Deep percolation _____ sq in
- 4. Low quarter infiltration _____ sq in

Actual border strip area:

= $\frac{(\text{Actual border length, ft}) \times (\text{Wetted width, ft})}{43,560} = \frac{\text{_____}}{43,560} = \text{_____} \text{ acres}$

Distribution uniformity low 1/4 (DU):

DU = $\frac{\text{Low quarter infiltration area} \times 100}{(\text{Whole curve area} - \text{runoff area})} = \text{_____} \%$

Runoff (RO):

RO, % = $\frac{\text{Runoff area} \times 100}{\text{Whole curve area}} = \text{_____} \%$

RO = $\frac{\text{Total irrigation volume, ac-in} \times \text{RO, \%}}{\text{Actual strip area, ac} \times 100} = \text{_____} \text{ in}$

Deep percolation, DP:

DP = $\text{Deep percolation area} \times 100 = \text{_____} \%$

DP = $\frac{\text{Total irrigation volume, ac-in} \times \text{DP, \%}}{\text{Actual strip area, ac} \times 100} = \text{_____} \text{ in}$

**Surface Irrigation System
 Detailed Evaluation Graded Border Worksheet**

Evaluation computations, cont:

Gross application, F_g :

$$F_g = \frac{\text{Total irrigation volume, ac-in}}{\text{Actual strip area, ac}} = \underline{\hspace{4cm}} = \underline{\hspace{2cm}} \text{ in}$$

Application efficiency, E_a :

(Average depth stored in root zone = Soil water deficit (SWD) if entire root zone depth will be filled to field capacity by this irrigation, otherwise use F_g , in - RO, in)

$$E_a = \frac{\text{Average depth stored in root zone} \times 100}{\text{Gross application, in}} = \underline{\hspace{4cm}} = \underline{\hspace{2cm}} \%$$

Application efficiency low 1/4, E_q :

$$E_q = \frac{DU \times E_a, \%}{100} = \underline{\hspace{4cm}} = \underline{\hspace{2cm}} \%$$

Average net application, F_n

$$F_n = \frac{\text{Total irrigated volume, ac-in} \times E_a, \%}{\text{Actual strip area, ac} \times 100} = \underline{\hspace{4cm}} = \underline{\hspace{2cm}} \%$$

Time factors:

Required opportunity time to infiltrate soil water deficit of _____ in

$$T_o = \underline{\hspace{2cm}} \text{ min (} \underline{\hspace{2cm}} \text{ hr - } \underline{\hspace{2cm}} \text{ min)}$$

Estimated required irrigation inflow time from adv.-recession curves;

$$T_{in} = \underline{\hspace{2cm}} \text{ min (} \underline{\hspace{2cm}} \text{ hr - } \underline{\hspace{2cm}} \text{ min)}$$

At inflow rate of:

$$Q = \underline{\hspace{2cm}} \text{ ft}^3/\text{s per border strip}$$

**Surface Irrigation System Detailed Evaluation
 Graded Border Worksheet**

Present management:

Estimated present average net application per irrigation _____ inches

Present gross applied per year = $\frac{\text{Net applied per irrigation} \times \text{number of irrigations} \times 100}{\text{Application efficiency } (E_a)^{1/}}$

= _____ = _____ in

^{1/} Use the best estimate of what the application efficiency of a typical irrigation during the season may be. The application efficiency from irrigation to irrigation can vary depending on the SWD, set times, etc. If the irrigator measures flow during the season, use that information.

Potential management:

Annual net irrigation requirement _____ inches, for _____ (crop)

Potential application efficiency (E_{pa}) _____ percent (from irrigation guide, NEH or other source)

Potential annual gross applied = $\frac{\text{Annual net irrigation requirement} \times 100}{\text{Potential application efficiency } (E_{pa})}$

= _____ = _____ in

Total annual water conserved

= $\frac{(\text{Present gross applied} - \text{potential gross applied}) \times \text{area irrigation (ac)}}{12}$

= _____ = _____ acre feet

Annual cost savings:

Pumping plant efficiency _____ Kind of fuel _____

Cost per unit of fuel _____ Fuel cost per acre foot \$ _____

Cost savings = Fuel cost per acre foot x acre feet conserved per year

= _____ = \$ _____

**Surface Irrigation System
Detailed Evaluation Graded Border Worksheet**

Potential water and cost savings, cont.

Water purchase cost

= Cost per acre foot x acre feet saved per year = _____

= \$ _____

Cost savings = pumping cost + water cost = _____ = \$ _____

Recommendations

Profile and Cross Section

Land user _____
Date _____
Field office _____

Cross Section at sta. _____

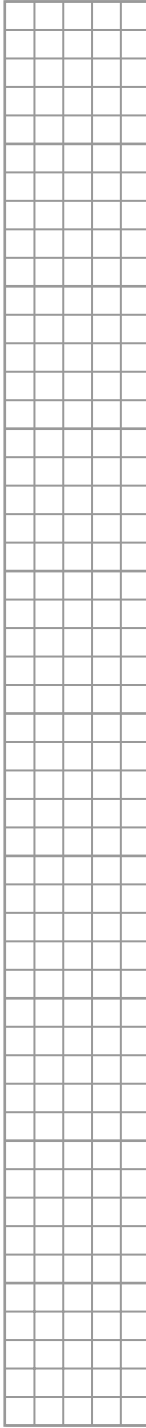

Distance - feet

Profile

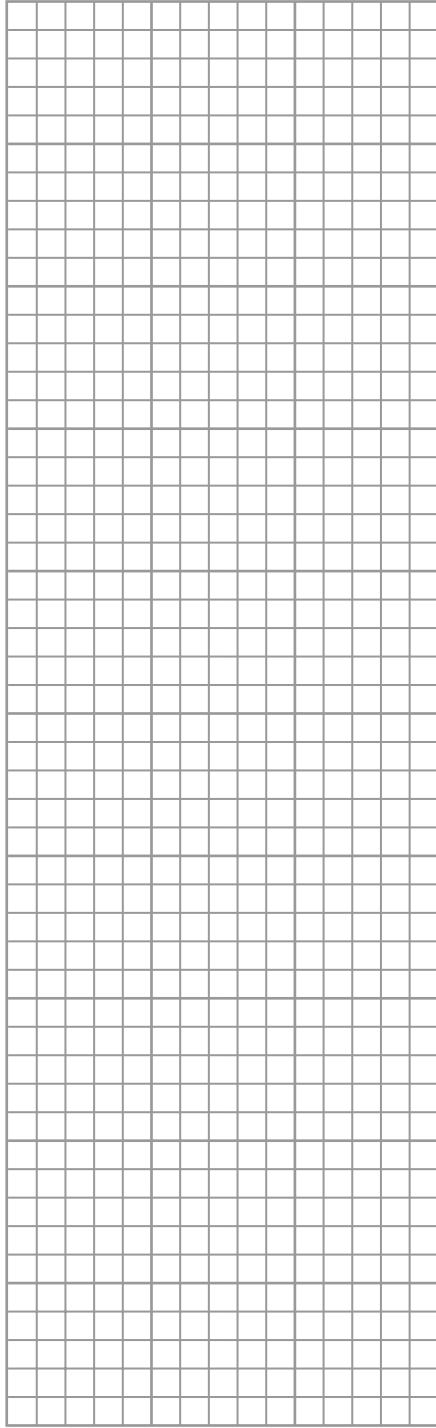

Distance (stations) - feet x 100

Rod Reading or elevation - feet

Cylinder Infiltrometer Curves

Land user _____
Date _____
Field office _____

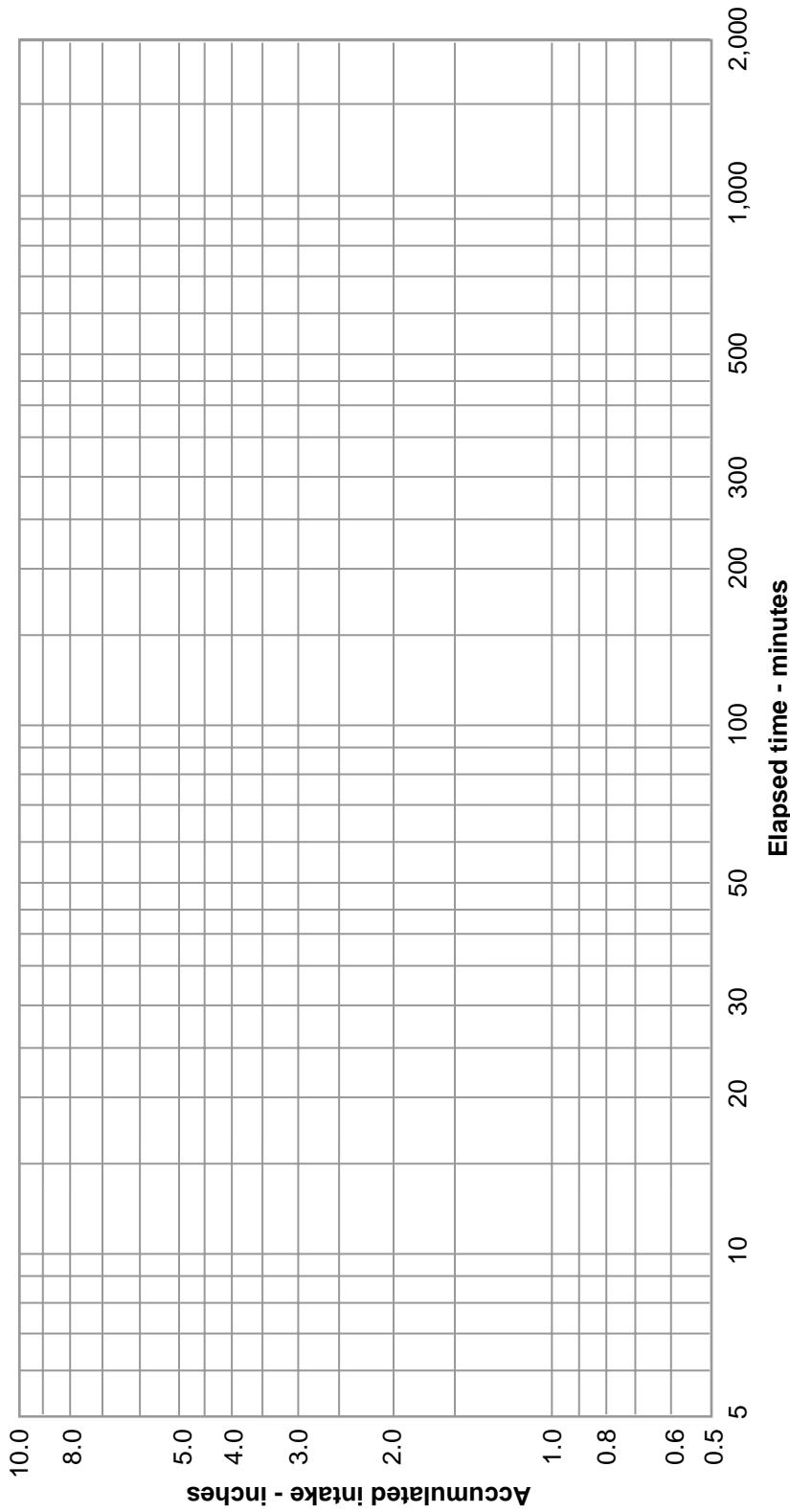

U.S. Department of Agriculture
National Resources Conservation Service

Cylinder Infiltrometer Test Data

-322
 02-96

FARM	COUNTY	STATE	LEGAL DESCRIPTION	DATE
SOIL MAPPING SYMBOL	SOIL TYPE	SOIL MOISTURE:		
CROP	STAGE OF GROWTH			

GENERAL COMMENTS

Elapsed time	Cylinder No. 1			Cylinder No. 2			Cylinder No. 3			Cylinder No. 4			Cylinder No. 5			Average accum. intake
	Time of reading	Hook gage reading	Accum. intake	Time of reading	Hook gage reading	Accum. intake	Time of reading	Hook gage reading	Accum. intake	Time of reading	Hook gage reading	Accum. intake	Time of reading	Hook gage reading	Accum. intake	
	Min.	Inches		Min.	Inches		Min.	Inches		Min.	Inches		Min.	Inches		

Land user _____
Date _____
Field office _____

Advance and recession curves

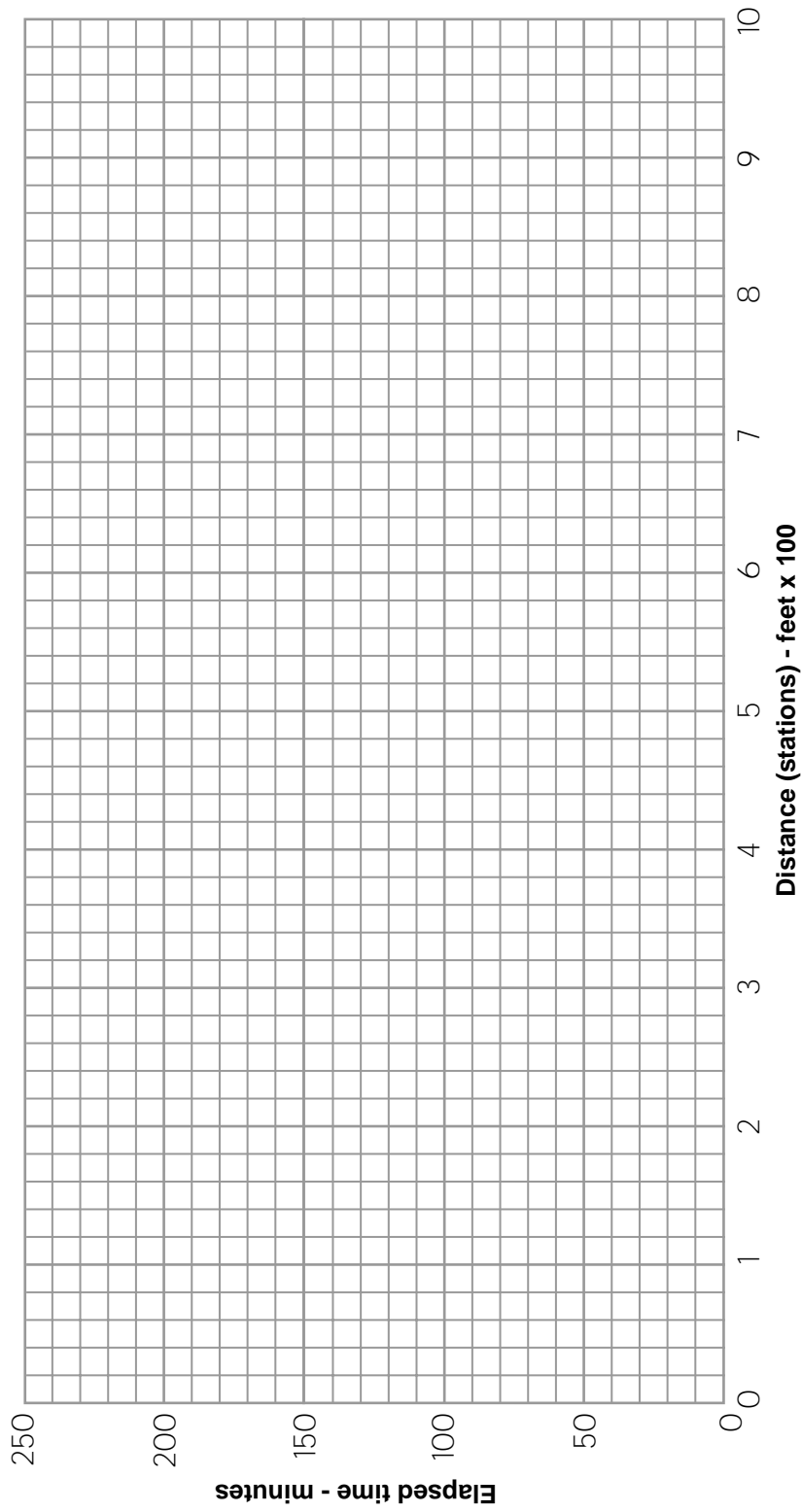

Cylinder infiltrometer Curves

Land user _____

Date _____

Field office _____

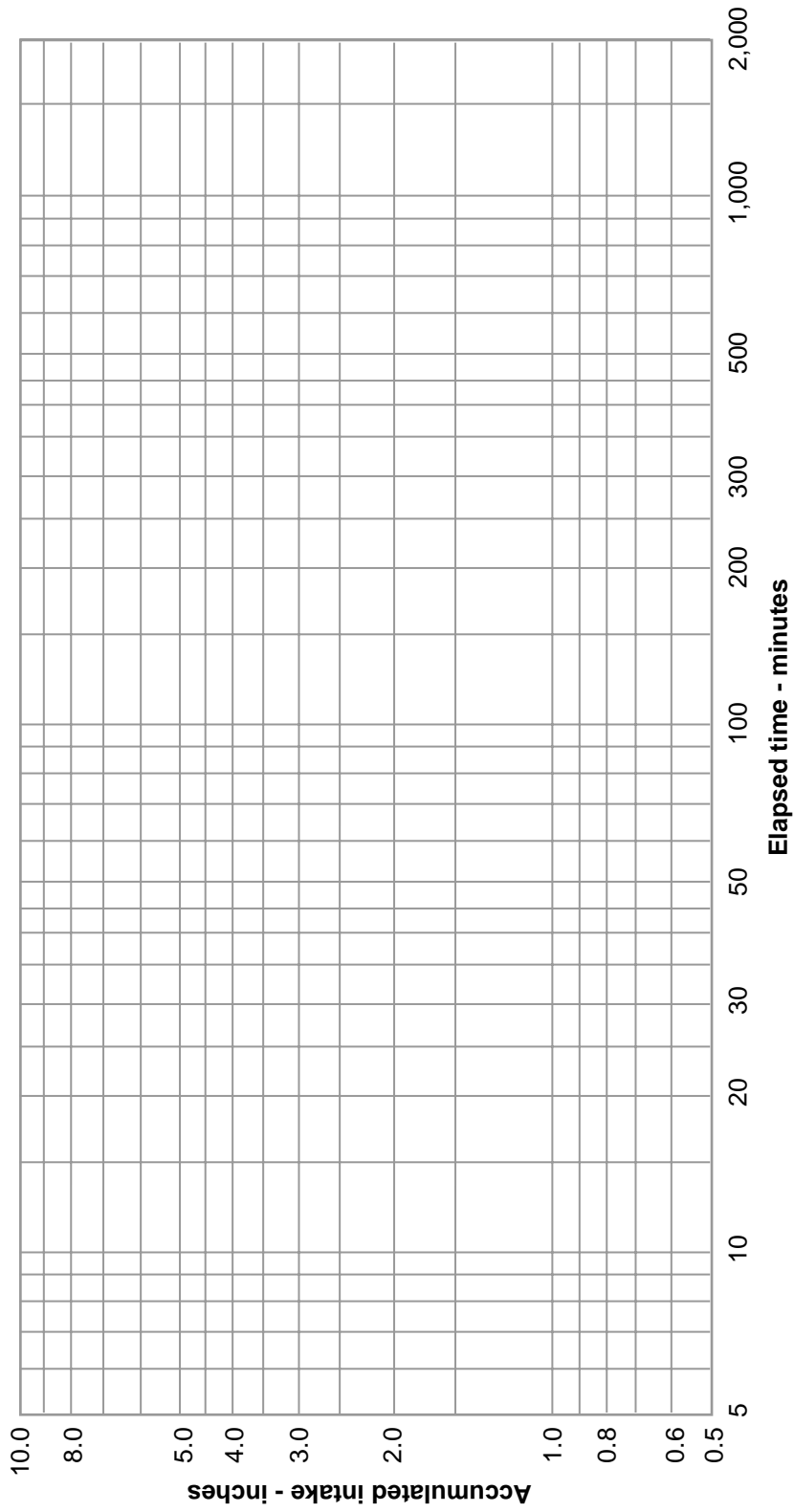

Land user _____
Date _____
Field office _____

Depth infiltrated curve

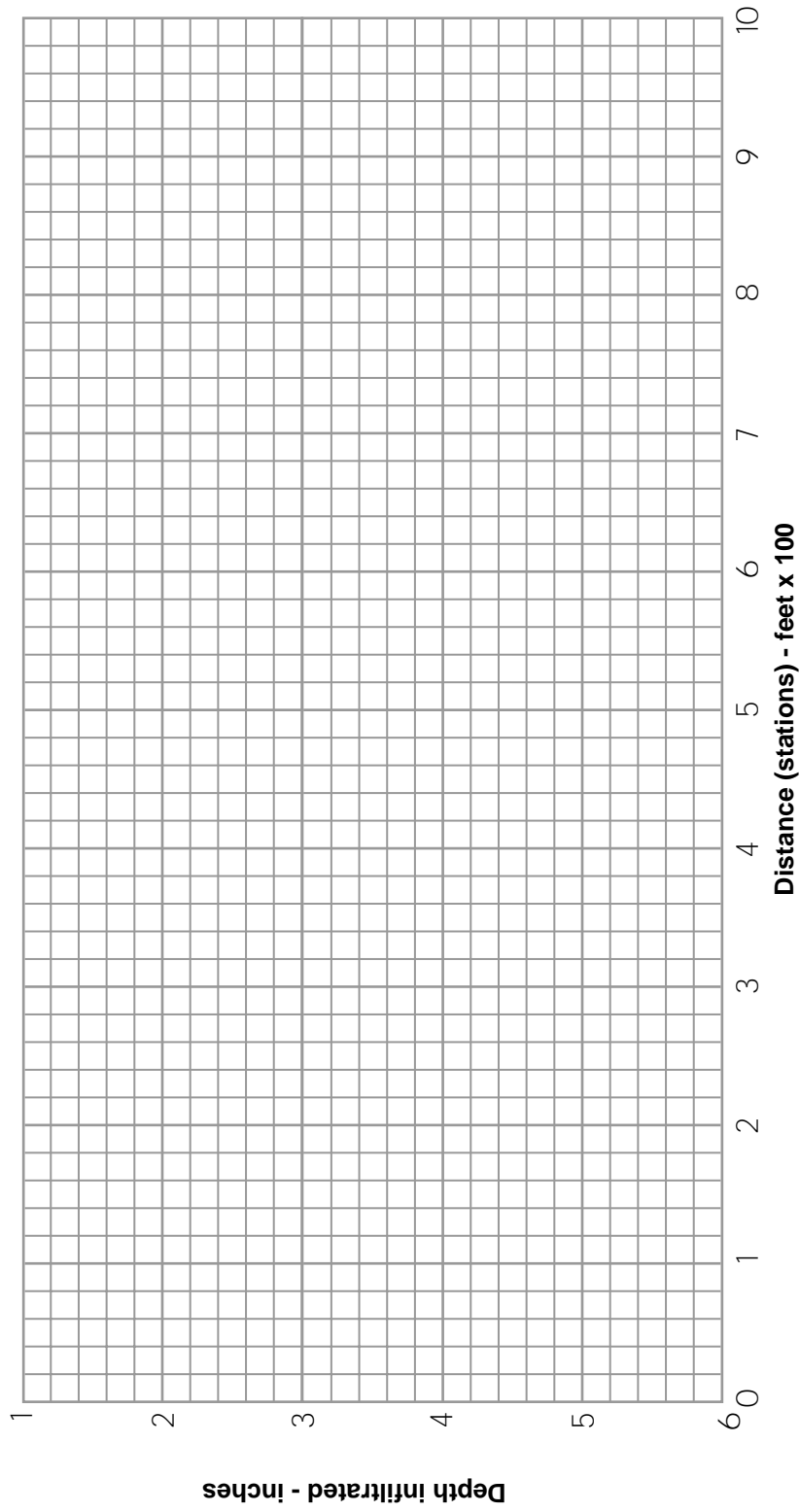

**Surface Irrigation System
 Detailed Evaluation Graded Border Worksheet**

Land user _____ Field office _____

Field name/number _____

Observer _____ Date _____ Checked by _____ Date _____

Field Data Inventory:

Field area _____ acres

Border number _____ as counted from the _____ side of field

Crop _____ Root zone depth _____ ft MAD _____ %

Stage of crop _____

Soil-water data for controlling soil:

Station _____ Moisture determination method _____

Soil series name _____

Depth	Texture	AWC (in)*	SWD (%)*	SWD (in)*
_____	_____	_____	_____	_____
_____	_____	_____	_____	_____
_____	_____	_____	_____	_____
_____	_____	_____	_____	_____
Total		_____	_____	_____

MAD, in = $\frac{\text{MAD, \%} \times \text{total AWC, in}}{100}$ = _____ in

Comments about soils: _____

Typical irrigation duration _____ hr, irrigation frequency _____ days

Typical number of irrigation's per year _____

Annual net irrigation requirement, NIR (from irrigation guide) _____ in

Type of delivery system (gated pipe, turnouts, siphon tubes) _____

Delivery system size data (pipe size & gate spacing, tube size & length, turnout size) _____

Border spacing _____, Strip width _____, Wetted width _____, Length _____

Field Observations:

Evenness of water spread across border _____

Crop uniformity _____

Other observations _____

NOTE: MAD = Management allowed deficit AWC = Available water capacity SWD = Soil water deficit

**Surface Irrigation System
 Detailed Evaluation Level Border and Basins Worksheet**

1. Basin area (A):

$$A = \frac{\text{Length} \times \text{Width}}{43,560} = \frac{\quad \times \quad}{46,560} = \quad \text{acres}$$

2. Gross application, F_g , in inches:

$$F_g = \frac{\text{Total irrigation volume, in ac-in}}{A, \text{ ac}} = \quad = \quad \text{in}$$

3. Amount infiltrated during water inflow, V_i :

$$V_i = \text{Gross application} - \text{Depth infiltrated after turnoff} = \quad = \quad \text{in}$$

4. Deep percolation, DP, in inches:

$$DP = \text{Gross application} - \text{Soil water deficit, SWD} = \quad = \quad \text{in}$$

$$DP, \text{ in \%} = \frac{\text{Soil water depletion, DP in inches} \times 100}{\text{Gross application, } F_g} = \quad = \quad \%$$

5. Application efficiency, E_a :

Average depth of water stored in root zone = Soil water deficit, SWD, if the entire root zone average depth will be filled to field capacity by this irrigation.

$$E_a = \frac{\text{Average depth stored in root zone, } F_n \times 100}{\text{Gross application, } F_g} = \quad = \quad \%$$

6. Distribution uniformity, DU:

$$\begin{aligned} \text{Depth infiltrated low } 1/4 &= \frac{(\text{max intake} - \text{min intake}) + \text{min intake}}{8} \\ &= \frac{\quad + \quad}{8} = \quad \end{aligned}$$

$$DU = \frac{\text{Depth infiltrated low } 1/4}{\text{Gross application, } F_g} = \quad = \quad$$

7. Application efficiency, low 1/4, E_q :

$$E_q = \frac{DU \times E_a}{100} = \quad = \quad \%$$

**Surface Irrigation System
 Detailed Evaluation Level Border and Basins Worksheet**

1. Present management

Estimated present average net application per irrigation = _____ inches

Present annual gross applied = $\frac{\text{(net applied per irrigation)} \times \text{(number of irrigations)} \times 100}{\text{Application efficiency, low } 1/4, E_q}$

= _____ x 100 = _____ inches

2. Potential management

Recommended overall irrigation efficiency, E_{des} _____

Potential annual gross applied = $\frac{\text{Annual net irrigation requirements} \times 100}{E_{des}}$

= _____ = _____ inches

3. Total annual water conserved:

= $\frac{\text{(resent gross applied, in - potential gross applied, in)} \times \text{area irrigated, acres}}{12}$

+ _____ = _____ ac-ft

4. Annual potential cost savings

From pumping plant evaluation:

Pumping plant efficiency _____ Kind of fuel _____

Cost per unit of fuel _____ Fuel cost per acre-foot \$ _____

Cost savings = (fuel cost per acre foot) x (water conserved per year, in ac-ft)

= _____ x _____ = \$ _____

Water purchase cost per acre-foot, per irrigation season _____

Water purchase cost savings = (Cost per acre-foot) x (water saved per year, in acre-feet)

= _____ = \$ _____

Potential cost savings = pumping cost + water purchase cost = _____ = \$ _____

**Surface Irrigation System
 Detailed Evaluation Level Border and Basins Worksheet**

Inflow Data

Type of measuring device _____

Clock ^{1/} time	Elapsed time (min)	Δ T (min)	Gage H (ft ³ /s)	Flow rate (ft ³ /s)	Average flow rate (ft ³ /s)	Volume (ac-in) ^{2/}	Cum. volume (ac-in)
Turn on							

Turn off _____
 Total volume (ac-in) _____

Average flow:
 Average flow = $\frac{\text{Total irrigation volume, in ac-in}}{\text{Inflow time, in minutes}} \times 60.5 = \text{_____} = \text{_____} \text{ ft}^3/\text{s}$

Unit:
 $q_u = \frac{\text{Average inflow rate, in ft}^3/\text{s}}{\text{Border spacing}} = \text{_____} = \text{_____} \text{ ft}^3/\text{s}/\text{ft}$

1/ Use a 24-hour clock reading; i.e., 1:30 p.m. is recorded as 1330 hours.
 2/ Flow rate to volume factors:

To find volume using ft³/s: volume (ac-in) = .01653 x time (min) x flow (ft³/s)
 To find volume using gpm: volume (ac-in) = .00003683 x time (min) x flow (gpm)

**Surface System
 Detailed Evaluation Level Border and Basins Worksheet**

Advance - Recession Data

Station (ft)	Elevation (ft)	Advance time ^{1/} (hr: min)	Recession time ^{1/} (hr: min)	Opportunity time To (min)	Intake ^{2/} (in)	Minimum maximum intake (in)
Total						

Water surface elevation at water turnoff _____ ft ^{3/}

Average field elevation = $\frac{\text{elevation total}}{\text{no. of elevations}}$ = _____ = _____ ft

Depth infiltrated after water turnoff
 = (water surface at turnoff - average field elev) x 12
 = (_____ - _____ x 12 = _____ in

Average opportunity time = $\frac{\text{total opportunity time}}{\text{no. of sample locations}}$ = _____ = _____ min

1/ Use 24-hour clock time. As a minimum, record times at upper end, mid point.
 2/ Obtain intake from plotted intake curve.
 3/ Water surface elevation should be read to nearest 0.01 ft.

Land user _____

Date _____

Field office _____

Soil Water Intake Curves

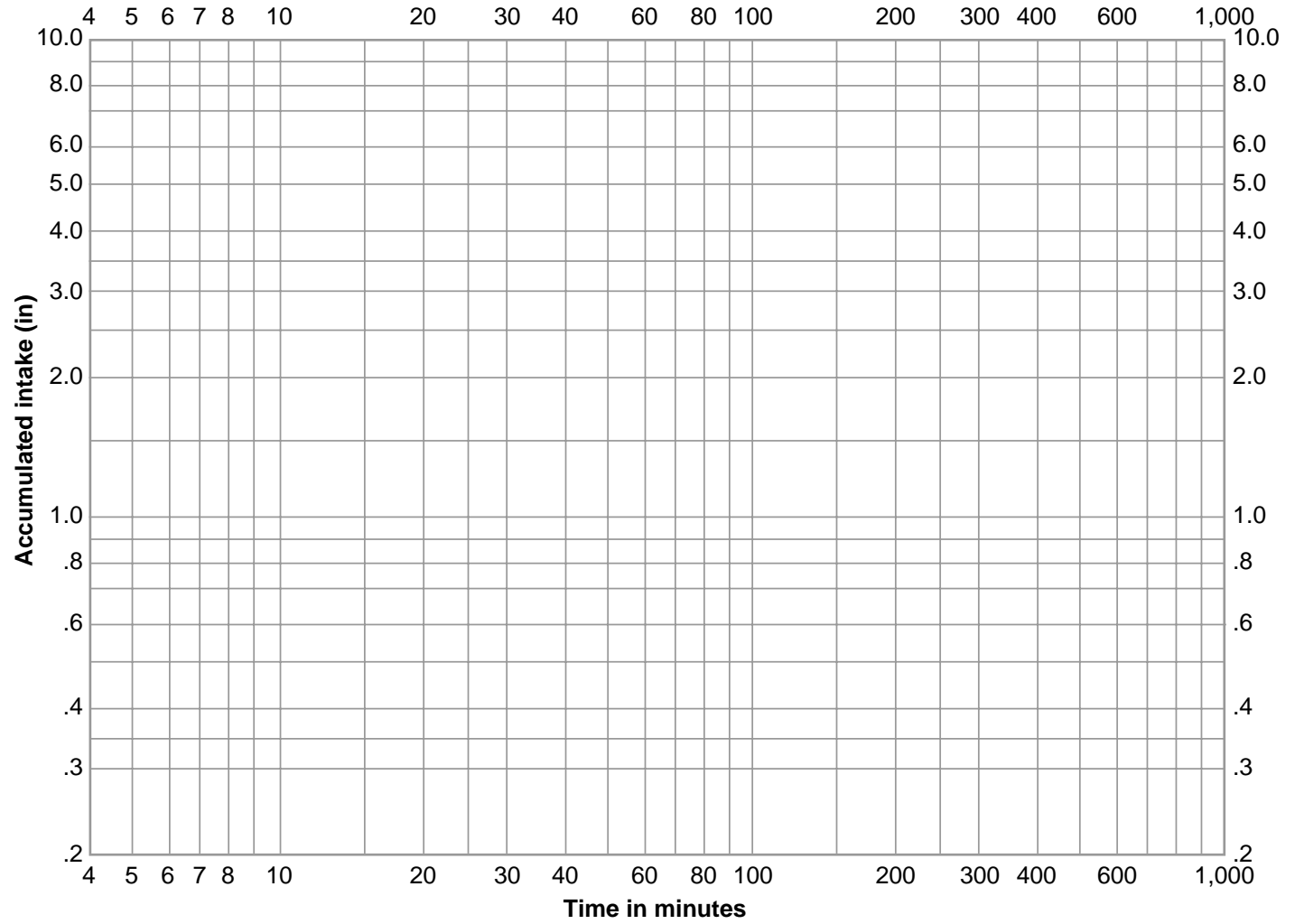

**Surface Irrigation System
 Detailed Evaluation Graded Furrow Worksheet 1**

Land user _____ Field office _____
 Field name/number _____
 Observer _____ Date _____ Checked by _____ Date _____

Field Data Inventory:

Show location on evaluation furrows on sketch or photo of field.

Crop _____ Actual root zone depth _____ MAD [†]/ _____ % MAD _____ in
 Stage of crop _____ Planting date (or age of planting) _____
 Field acres _____

Soil-water data:

(Show location of sample on soil map or sketch of field)

Soil moisture determination method _____
 Soil mapping unit _____ Surface texture _____

Depth	Texture	AWC (in) ^{1/}	SWD (%) ^{1/}	SWD (in) ^{1/}
_____	_____	_____	_____	_____
_____	_____	_____	_____	_____
_____	_____	_____	_____	_____
_____	_____	_____	_____	_____
_____	_____	_____	_____	_____
Total				_____

Comments about soils: _____

Typical irrigation duration _____ hours, Irrigation frequency _____ days
 Typical number of irrigations per year _____
 Crop rotation _____

Field uniformity condition (smoothed, leveled, laser leveled, etc., and when) _____

1/ MAD = Management allowable depletion AWC = Available water capacity SWD = Soil water deficit

**Surface Irrigation System
 Detailed Evaluation Graded Furrow Worksheet 2**

Cultivation no.	Date	Crop stage	Irrigate?
1	_____	_____	_____
2	_____	_____	_____
3	_____	_____	_____
4	_____	_____	_____
5	_____	_____	_____

Delivery system size (pipe diameters, gate spacing, siphon tube size, etc.) _____

Field observations

Evenness of advance across field _____

Crop uniformity _____

Soil condition _____

Soil compaction (surface, layers, etc.) _____

Furrow condition _____

Erosion and/or sedimentation: in furrows _____
 head or end of field _____

Other observations (OM, cloddiness, residue, plant row spacing, problems noted, etc.) _____

Furrow spacing _____ inches

Furrow length _____ feet

Irrigations since last cultivation _____

Furrow profile (rod readings or elevations at each 100 foot. station):

Furrow cross section:

Station: _____

Station: _____

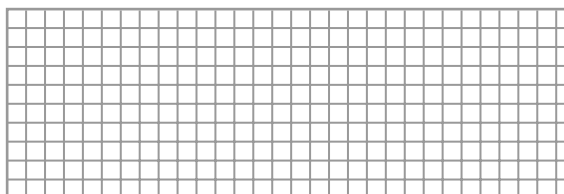
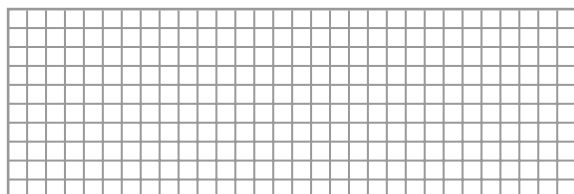

**Example - Surface Irrigation System Detailed Evaluation
 Graded Furrow Worksheet 3**

Furrow data summary:

Evaluation length _____ Slope _____ Average _____

Section through plant root zone:

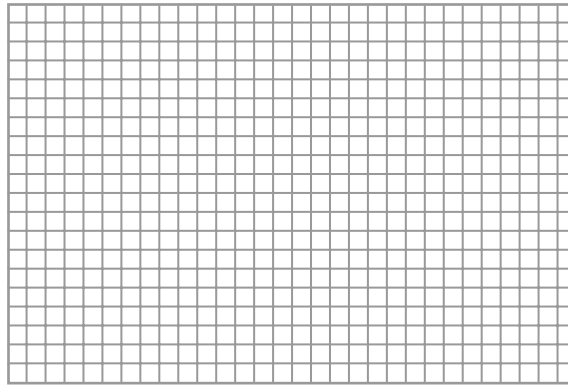

Evaluation computations

Furrow area, A = $\frac{\text{(furrow evaluation length, L, ft)} \times \text{(furrow spacing, W, ft)}}{43,560 \text{ ft}^2/\text{acre}}$

A = _____ = _____ acre

43,560

Present gross depth applied, $F_g = \frac{\text{Total inflow volume, gal.} \times .0000368}{\text{Furrow area, A, in acres}}$ (Total inflow from worksheet 7)

$F_g =$ _____ = _____ inches

Minimum opportunity time, $T_{ox} =$ _____ min at station _____ (from field worksheet 10)

Minimum depth infiltrated, $F_{min} =$ _____ inches (from worksheet 10)

Average depth infiltrated, $F_{(0-1)} =$ _____ (from calculations on worksheet 10)

Distribution uniformity, $DU = \frac{\text{Minimum depth infiltrated, inches}}{\text{Average depth infiltrated, inches}} \times 100 = \frac{F_{min} \times 100}{F_{ave}}$

= _____ = _____ %

Example - Surface Irrigation System Detailed Evaluation Graded Furrow Worksheet 4

$$\text{Runoff, RO\%} = \frac{\text{Total outflow volume, gal} \times 100}{\text{Total inflow volume, gal}} = \underline{\hspace{2cm}} = \underline{\hspace{2cm}} \% \text{ (Total outflow, worksheet 8)} \\ \text{(Total inflow, worksheet 7)}$$

$$\text{RO, in} = \frac{\text{Total outflow volume, gal} \times .0000368}{\text{Evaluation furrow area, A, in acres}} = \underline{\hspace{2cm}} \times 0.0000368 = \underline{\hspace{2cm}} \text{ in (Furrow area, worksheet 3)}$$

Deep percolation, DP, in = Average depth infiltrated - Soil moisture deficit, SMD (Ave. depth worksheet 10 and SMD worksheet 1)

$$\text{DP} = \underline{\hspace{2cm}} = \underline{\hspace{2cm}} \text{ in}$$

$$\text{Deep percolation, DP, \%} = \frac{\text{Deep percolation, DP, in} \times 100}{\text{Gross depth applied, } F_g, \text{ inches}} = \underline{\hspace{2cm}} = \underline{\hspace{2cm}} \%$$

Application efficiency, E_a

$$E_a = \frac{\text{Ave depth stored in root zone}^* \times 100}{\text{Gross application, } F_g, \text{ inches}} = \underline{\hspace{2cm}} = \underline{\hspace{2cm}} \%$$

*Average depth of water stored in root zone = SWD if entire root zone depth is filled to field capacity by this irrigation. If irrigation efficiency is to be used in place of application efficiency, use average depth of water beneficially used (i.e., all infiltrated depths less than or equal to SWD) plus any other beneficial uses.

Example - Surface Irrigation System Detailed Evaluation Graded Furrow Worksheet 5

Potential water and cost savings

Present management

Estimated present gross net application, F_g per irrigation = _____ inches (F_g from worksheet 3)

Present gross applied per year = Gross applied per irrigation, F_g x number of irrigations

= _____ = _____ inches

Potential management

Annual net irrigation requirement _____ inches, for _____ (crop)

Potential application efficiency, E_{pa} = _____%

Potential annual gross applied = $\frac{\text{Annual net irrigation req.} \times 100}{\text{Potential application efficiency, } E_{pa}}$

= _____ = _____ inches

Total annual water conserved = $\frac{(\text{present gross applied} - \text{potential gross applied}) \times \text{area irrigated, ac}}{12}$

= _____ = _____ acre feet

**Surface Irrigation System
Detailed Evaluation Graded Furrow Worksheet 6**

Annual cost savings

Water cost

= Cost per acre foot x acre feet saved per year = _____

= \$ _____

Cost savings = Pumping cost + water cost = _____ = \$ _____

Fuel cost savings = (fuel cost per ac-ft) x (ac-ft conserved per year) = _____ = _____

Recommendations _____

**Surface Irrigation System
 Detailed Evaluation Furrow Worksheet 7-8**

Data: Furrow number _____ Inflow _____ Outflow _____

Type of measuring device _____

Clock ^{1/} time	Elapsed time (min)	Δ T (min)	Gage H (ft)	Flow rate (gpm)	Average flow rate (gpm)	Volume ^{2/} (gal)	Cum. volume (gal)
Turn on							
Total volume							

1/ Use a 24-hour clock reading; i.e., 1:30 p.m. is recorded as 1330 hours.
 2/ Volume = Δ T x average flow rate

Average flow rate = $\frac{\text{Total irrigation volume, gallon}}{\text{Elapsed time, minute}}$ = _____ = _____ gpm

**Surface Irrigation System Detailed Evaluation
 Furrow Worksheet 9**

Intake Curve Plotting Data

Opportunity time at time "T"						Intake at time "T"			
Clock time		Inflow time		Outflow time		Opportunity time T_o ^{5/}	Cumulative inflow volume ^{6/} V_{in} (gal)	Cumulative Outflow volume ^{6/} V_{out} (gal)	Intake F_{0-1} ^{7/} (in)
(hr-min) ^{1/}	T (hr)	Start ^{2/} (hr)	T1 ^{3/} (hr)	Start ^{2/} (hr)	T2 ^{4/} (hr)				

- 1/ Use a 24-hour clock reading for collection of field data; i.e., 1:30 p.m. is 1330 hours. Use decimal hours for inflow and outflow times.
- 2/ Time at which inflow or outflow starts in decimal hours (worksheet 7-8)
- 3/ Inflow time: $T1 = "T" - \text{inflow start time (worksheet 7)}$
- 4/ Outflow time: $T2 = "T" - \text{outflow start time (worksheet 8)}$
- 5/ Opportunity time (minutes): $T_o = 30 (T1 + T2)$
- 6/ Cumulative inflow and outflow volumes (worksheet 7-8). If data were not recorded for time T, interpolate the inflow or outflow.

Surface storage and wetted perimeter for length of furrow with water in it.

L = length of furrow with water in it, ft (worksheet 3) = _____

S = average furrow slope, ft/ft (worksheet 3) = _____

n = Mannings "n" (usually 0.04 for furrows, 0.10 for corrugations) = _____

Q_{av} = average inflow rate, gpm (worksheet 7) = _____

Surface storage: $V_s = L \left[0.09731 \left(\frac{Q_{av} \times n}{S^5} \right)^{.7567} + 0.00574 \right]$ = _____

Wetted perimeter: $P = 0.2686 \left(\frac{Q_{av} \times n}{S^5} \right)^{.4247} + 0.7462$ = _____

7/ Intake plotting point:

V_{in} = Cumulative inflow (gal) from worksheet 7

V_{out} = Cumulative outflow (gal) from worksheet 8

V_s = Surface storage (gal) in length of furrow with water in it

$$F_{0-1} = \frac{1.604 (V_{in} - V_{out} - V_s)}{L \times P}$$

**Surface Irrigation System Detailed Evaluation
 Furrow Worksheet 10**

Furrow advance/recession data

Station (ft)	Advance time			Recession time			Total elapsed time ^{3/}	Opportunity time (T _o) ^{2/} (min)	Intake in wetted perimeter (in) ^{4/}	Intake in furrow width (in)
	Clock time ^{1/}	Δ T (min)	Elapsed time T _t (min)	Clock time ^{1/}	Δ T (min)	Elapsed time T _r (min)				
				Turn off				Inflow T		
	Turn on				Lag					
Totals										

1/ Use a 24-hour clock reading; i.e., 1:30 p.m. is 1330 hours.
 3/ Time since water was turned on.

2/ $T_o = T_i - T_t + T_r$
 4/ Interpolated from graph, furrows volume curve

Average opportunity time = $\frac{\text{total opportunity time}}{\text{number of stations}}$ = _____ = _____ minutes

Average depth infiltrated in wetted perimeter, F_{wp} :
 $F_{wp} = \frac{\text{total intake in wetted perimeter}}{\text{number of stations}}$ = _____ inches

Average depth infiltrated in tested length of furrow, F_{0-1} :
 $F_{0-1} = \frac{F_{wp} \times P}{W}$ = _____ inches

**Surface Irrigation System Detailed Evaluation
Furrow Worksheet 11**

A large grid of graph paper, consisting of 30 columns and 40 rows of small squares. The grid is intended for detailed data entry and calculations related to the surface irrigation system evaluation.

Land user _____

Date _____

Field office _____

Advance and recession curves

Time - minutes

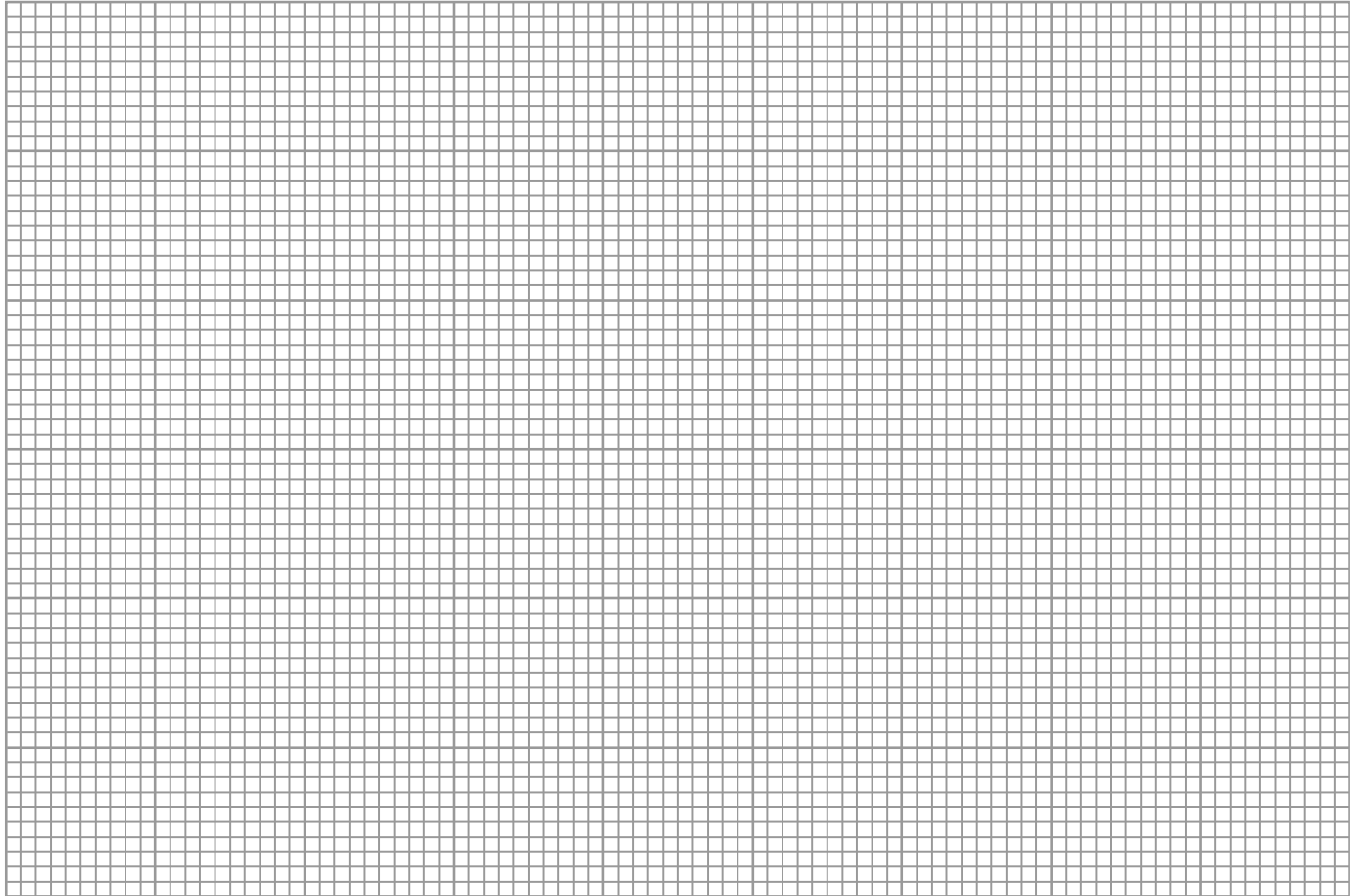

Distance (stations) - feet x 100

Land user _____

Date _____

Field office _____

Flow volume curves

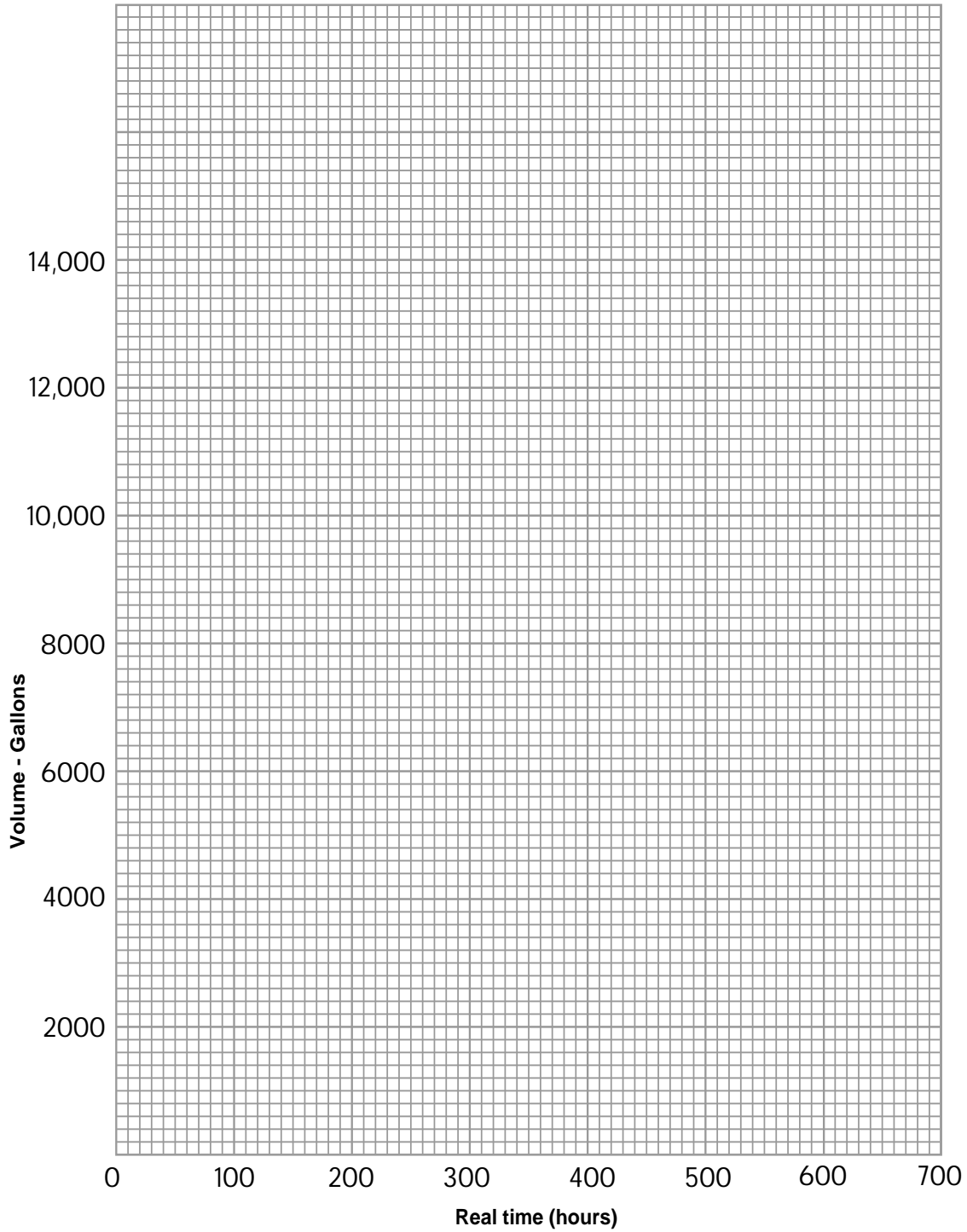

Land user _____

Date _____

Field office _____

Soil water intake curves

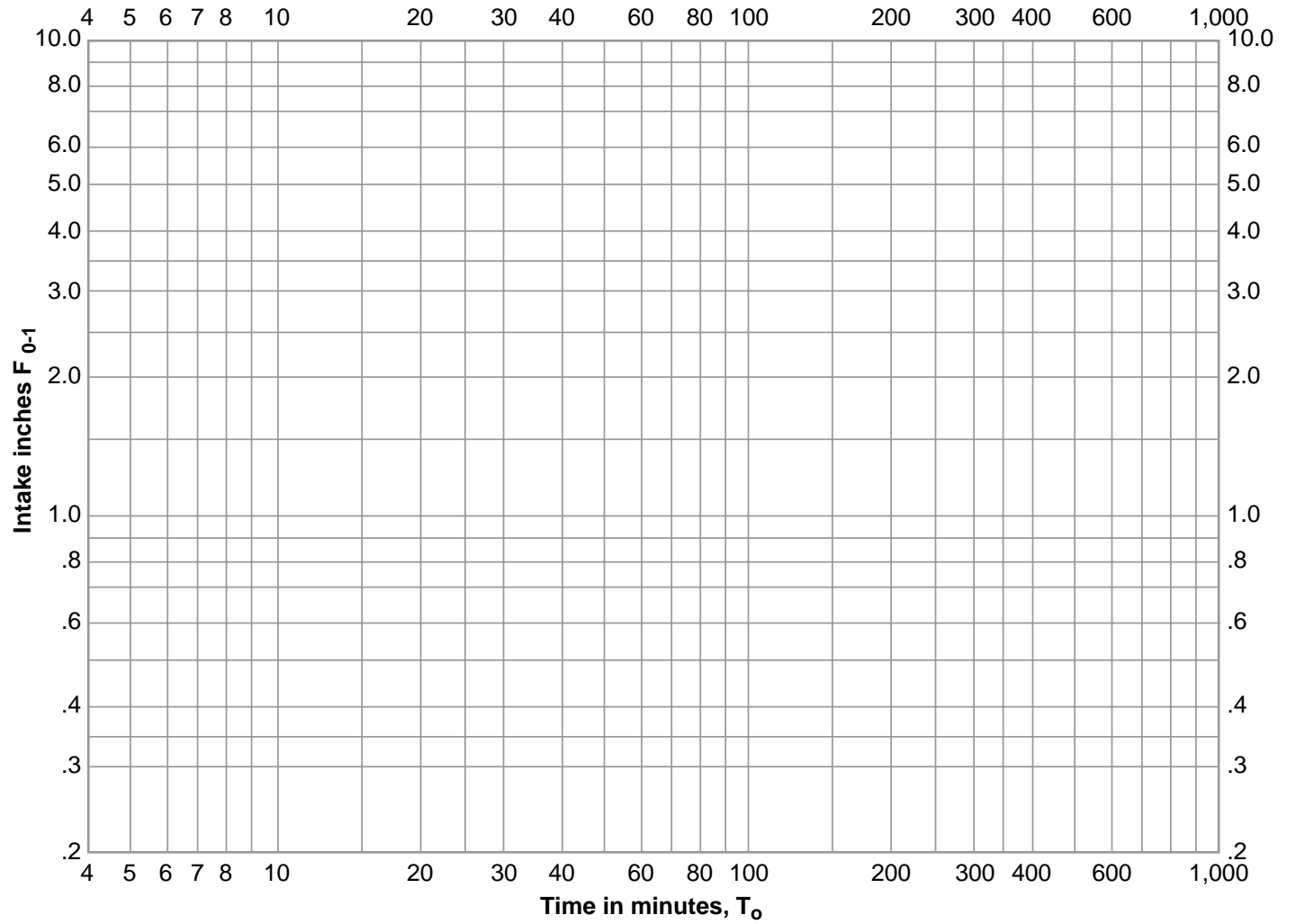

**Surface Irrigation System
 Detailed Evaluation Contour Ditch Irrigation System Worksheet**

Land user _____ Field office _____
 Field name/number _____
 Observer _____ Date _____ Checked by _____ Date _____

Field Data Inventory:

Field size _____ acres
 Crop _____ Root zone depth _____ ft MAD ^{1/} _____ % MAD ^{1/} _____ in
 Stage of crop _____

Soil-water data:

(Show location of sample on grid map of irrigated area.)

Soil moisture determination method _____

Soil series name _____

Depth	Texture	AWC ^{2/} (in)	SWD ^{3/} (%)	SWD ^{3/} (in)
_____	_____	_____	_____	_____
_____	_____	_____	_____	_____
_____	_____	_____	_____	_____
_____	_____	_____	_____	_____
Total				_____

Comments about soils: _____

Typical irrigation duration _____ hr, irrigation frequency _____ days
 Typical number of irrigations per year _____

Type of delivery system, (earth ditch, concrete ditch, pipeline) _____

Method used to turn water out (shoveled opening, wood box turnout, siphon tubes, portable dams, concrete checks with check boards, etc.) _____

1/ MAD = Management allowable depletion
 2/ AWC = Available water capacity
 3/ SWD = Soil water deficit

**Contour Ditch Irrigation System
Detailed Evaluation Worksheet**

Field observations

Crop uniformity _____

Wet and/or dry area problems _____

Erosion problems _____

Other observations _____

Evaluation computations

Irrigated test area (from grid map) = (_____ in²) x (_____ in²/ac) = _____ ac

Actual total depth infiltrated, inches:

Depth, inches = $\frac{(\text{Irrigated volume, ac-in}) - (\text{Runoff volume, ac-in})}{(\text{Irrigated area, acres})}$

Depth, inches = _____ = _____ in

Gross application, F_g, inches:

F_g = $\frac{(\text{Total inflow volume, ac-in})}{(\text{Irrigated area, acres})}$ = _____ = _____ in

Distribution uniformity low 1/4 (DU):

DU = $\frac{(\text{Average depth infiltrated (adjusted) low 1/4, inches})}{(\text{Average depth infiltrated (adjusted), inches})}$

DU = _____ = _____

Runoff, RO, inches:

RO, inches = $\frac{(\text{Runoff volume, ac-in})}{(\text{Irrigated area, ac})}$ = _____ = _____ in

RO, % = $\frac{(\text{Runoff depth, inches}) \times 100}{(\text{Gross application, F}_g, \text{ inches})}$ = _____ = _____ %

**Contour Ditch Irrigation System
Detailed Evaluation Worksheet**

Deep percolation, DP, inches:

DP, inches = (Gross applic. F_g , inches) - (Runoff depth, RO, inches) - (Soil water deficit, SWD, inches)

DP, inches = _____ = _____ inches

DP, % = $\frac{\text{(Deep percolation, DP, inches)}}{\text{(Gross application, } F_g, \text{ inches)}} \times 100 = \text{_____} = \text{_____}\%$

Application efficiency (E_a):

(Average depth replaced in root zone = Soil water deficit, SWD, inches)

$E_a\% = \frac{\text{(Average depth replaced in root zone, inches)}}{\text{(Gross application, } F_g, \text{ inches)}} \times 100 = \text{_____} = \text{_____}\%$

Potential water and cost savings

Present management:

Estimated present average net application per irrigation = _____ inches

Present gross applied per year = $\frac{\text{(Net applied per irrigation, inches)} \times \text{(no. of irrigations)}}{\text{(Application efficiency, } E_a, \text{ percent)}} \times 100$

Present gross applied per year = _____ = _____ inches

Potential management

Annual net irrigation requirement: _____ inches, for _____ (crop)

Potential application efficiency, E_{pa} : _____ % (from irrigation guide or other source)

Potential annual gross applied = $\frac{\text{(annual net irrigation requirement, inches)} \times 100}{\text{(Potential application efficiency, } E_{pa}, \text{ percent)}}$

Potential annual gross applied = _____ = _____ inches

Total annual water conserved:

= $\frac{\text{(Present gross applied, inches)} - \text{(Potential gross applied, inches)}}{12} \times \text{Area irrigated, ac}$

= $\left(\frac{\text{_____}}{12} \right) \times \left(\text{_____} \right) = \text{_____}$ acre-feet

**Contour Ditch Irrigation System
Detailed Evaluation Worksheet**

Cost savings:

Pumping plant efficiency _____ percent, Kind of energy _____

Cost per unit of fuel _____ Fuel cost per acre foot _____

Cost savings = (Fuel cost per acre foot) x (Acre inches conserved per year)

= _____

Water purchase cost:

= (Cost per acre foot) x (Acre feet saved per year) =

= (_____) x (_____) = _____

Cost savings = (Pumping cost) + (Water cost) = (_____) + (_____) = _____

Recommendations

**Contour Ditch Irrigation System
 Detailed Evaluation Worksheet**

Inflow _____ Outflow _____

Type of measuring device _____

Clock 1/ time	Elapsed time (min)	Δ T (min)	Gauge H (ft)	Flow rate (ft ³ /s)	Average flow rate (ft ³ /s)	Volume 2/ (ac-in)	Cum. volume (ac-in)
Turn on							

Total volume (ac-in) _____

Average flow = $\frac{\text{Total irrigation volume in (ac-in)}}{\text{Flow factor} \times \text{elapsed time (min)}}$ = _____ = _____ ft³/s

1/ Use a 24-hour clock reading; i.e., 1:30 p.m. is recorded as 1330 hours.

2/ Flow rate to volume factors:

To find volume using ft³/s:

Volume (ac-in) = .01653 x time (min) x flow (ft³/s)

To find volume using gpm:

Volume (ac-in) = .00003683 x time (min) x flow (gpm)

Land user _____

Date _____

Field office _____

Soil Water Intake Curves

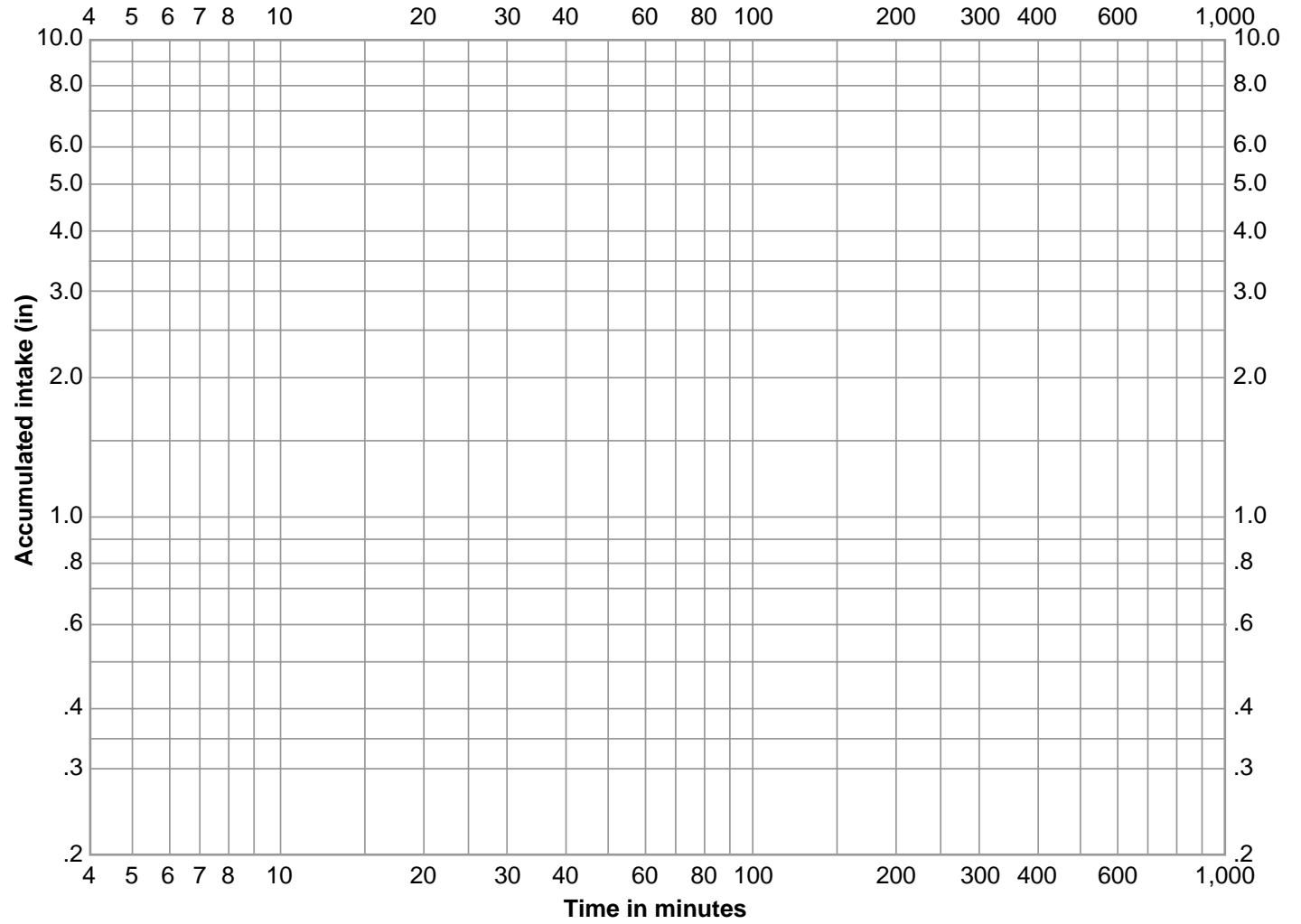

U.S. Department of Agriculture
Natural Resources Conservation Service

Cylinder Infiltrometer Test Data

NRCS-ENG-322
 02-96

FARM	COUNTY	STATE	LEGAL DESCRIPTION	DATE
SOIL MAPPING SYMBOL	SOIL TYPE		SOIL MOISTURE:	
CROP	STAGE OF GROWTH			

GENERAL COMMENTS

Elapsed time	Cylinder No. 1			Cylinder No. 2			Cylinder No. 3			Cylinder No. 4			Cylinder No. 5			Average accum. intake
	Time of reading	Hook gage reading	Accum. intake	Time of reading	Hook gage reading	Accum. intake	Time of reading	Hook gage reading	Accum. intake	Time of reading	Hook gage reading	Accum. intake	Time of reading	Hook gage reading	Accum. intake	

Sprinkler Irrigation System Detailed Evaluation Periodic Move and Fixed Set Sprinkler System

Land user _____ Prepared by _____
 District _____ County _____ Engineer job class _____

Irrigation system hardware inventory:

Type of system (check one) : Side- roll _____ Handmove _____ Lateral tow _____ Fixed set _____
 Sprinkler head: make _____, model _____, nozzle size(s) _____ by _____ inches
 Spacing of sprinkler heads on lateral, S_1 _____ feet
 Lateral spacing along mainline, S_m _____ feet, total number of laterals _____
 Lateral lengths: max _____ feet, minimum _____ feet, average _____ feet
 Lateral diameter: _____ feet of _____ inches, _____ feet of _____ inches
 Manufacturer rated sprinkler discharge, _____ gpm at _____ psi giving _____ feet wetted diameter
 Total number sprinkler heads per lateral _____, lateral diameter _____ inches
 Elevation difference between first and last sprinkler on lateral (=/-) _____ feet
 Sprinkler riser height _____ feet, mainline material _____
 Spray type: _____ fine (>30psi), _____ coarse (<30psi)

Field observations:

Crop uniformity _____
 Water runoff _____
 Erosion _____
 System leaks _____
 Fouled nozzles _____
 Other observations _____

Field data inventory & Computations:

Crop _____, root zone depth _____ feet, MAD 1/ _____ %, MAD 1/ _____ inches
 Soil-water data (typical):
 (Show locations of sample on soil map or sketch of field)
 Moisture determination _____
 Soil series and surface texture _____

Depth	Texture	AWC ^{1/} (in)	SWD ^{1/} (%)	SWD ^{1/} (in)
_____	_____	_____	_____	_____
_____	_____	_____	_____	_____
_____	_____	_____	_____	_____
_____	_____	_____	_____	_____
Totals		_____	_____	_____

1/ MAD = Management allowable depletion, AWC = Available water capacity, SWD = Soil water deficit

Sprinkler Irrigation System Detailed Evaluation Periodic Move and Fixed Set Sprinkler System

Comments about soils (including restrictions to root development and water movement): _____

Present irrigation practices:

Typical irrigation duration _____ hr, irrigation frequency _____ days

Typical number irrigations per year _____

Distance moved per set _____ ft, Alternate sets? _____

Measured nozzle diameters (using shank of high speed drill bit)

Sprinkler no. _____

Diameter _____

Size check _____

(state whether t = tight, m = medium, l = loose)

Actual sprinkler pressure and discharge data:

Sprinkler number on test lateral

1st

end

Initial pressure (psi) _____

Final pressure (psi) _____

Catch volume (gal) _____

Catch time (sec) _____

Discharge (gpm) _____

Test:

Start _____ stop _____ duration _____ = _____ hours

Atmospheric data:

Wind: Direction: Initial _____ during _____ final _____

Speed (mph): initial _____ during _____ final _____

Temperature: initial _____ final _____ Humidity: _____ low _____ med _____ high

Evaporation container: initial _____ final _____ loss _____ inch

Sprinkler Irrigation System Detailed Evaluation Periodic Move and Fixed Set Sprinkler System

Lateral flow data:

Flow meter reading _____ gpm

Average discharge of lateral based on sprinkler head discharge

$$= [1\text{st gpm} - .75 \text{ times } (1\text{st gpm} - \text{last gpm})] \text{ times } (\text{number of heads})$$

$$= \text{_____} = \text{_____ gpm (ave flow per head)}$$

$$= \text{_____ heads} \times \text{_____ gpm/head} = \text{_____ gpm}$$

Calculations:

$$\text{Gross application per test} = \frac{(\text{flow, gpm}) \times (\text{time, hr}) \times 96.3}{(\text{lateral length}) \times (\text{lateral spacing})}$$

$$= \frac{(\text{_____ gpm}) \times (\text{_____ hours}) \times 96.3}{(\text{_____ feet}) \times (\text{_____ feet})} = \text{_____ inches}$$

$$\text{Gross application per irrigation} = \frac{(\text{gross application per test, in}) \times (\text{set time, hour})}{(\text{time, hour})}$$

$$= \frac{(\text{_____ inches}) \times (\text{_____ hour})}{(5.95 \text{ hour})} = \text{_____ inches}$$

Catch container type _____

_____ cc (mL) or in, measuring container = _____ inches in container

Total number of containers _____

$$\text{Composite number of containers} = \frac{\text{Total number of containers}}{2} = \text{_____} = \text{_____}$$

Total catch, all containers = _____ cc (mL) = _____ inches
 cc/in

$$\text{Average total catch} = \frac{\text{Total catch}}{\text{composite no. containers}} = \text{_____} = \text{_____ inches}$$

$$\text{Number of composite containers in low } 1/4 = \frac{\text{composite no. containers}}{4} = \text{_____} = \text{_____}$$

Total catch in low 1/4 composite containers = _____ cc(mL) = _____ inches
 cc/in

Sprinkler Irrigation System Detailed Evaluation Periodic Move and Fixed Set Sprinkler System

$$\text{Average catch of low 1/4 composite containers} = \frac{\text{total catch in low 1/4}}{\text{no. composite low 1/4 containers}}$$

$$= \frac{\text{_____}}{\text{_____}} = \text{_____ inches}$$

$$\text{Average catch rate} = \frac{\text{Average total catch, inches}}{\text{Test time, hour}} = \frac{\text{_____}}{\text{hour}} = \text{_____ inch/hour}$$

NOTE: Average catch rate is application rate at plant canopy height.

Distribution uniformity low 1/4 (DU):

$$\text{DU} = \frac{\text{Average catch low 1/4 composite containers}}{\text{Average total catch}} \times 100 = \frac{\text{_____ inches}}{\text{_____ inches}} \times 100 = \text{_____ \%}$$

Approximate Christiansen Uniformity (CU):

$$\text{CU} = 100 - [0.63 \times (100 - \text{DU})] = 100 [0.63 \times (100 - \text{_____})] = \text{_____ \%}$$

Effective portion of applied water (R_e):

$$R_e = \frac{\text{Average total catch, inch}}{\text{Gross applications/test, inches}} = \frac{\text{_____ inches}}{\text{_____ inches}} = \text{_____ inches}$$

Application efficiency of low 1/4 (E_q):

$$E_q = \text{DU} \times (R_e) = \text{_____} \times \text{_____} = \text{_____ \%}$$

NOTE: Use for medium to high value crops.

Approximate application efficiency low 1/2 (E_h):

$$E_h = \text{CU} \times (R_e) = \text{_____} \times \text{_____} = \text{_____ \%}$$

NOTE: Use for lower value field and forage crops.

Sprinkler Irrigation System Detailed Evaluation Periodic Move and Fixed Set Sprinkler System

Application efficiency, (E_a):

$$F_n = \frac{(\text{gross application per irrigation})}{100} \times E_q = \left(\frac{\text{inches}}{100} \right) \times \text{_____} = \text{_____ inches}$$

$$E_a = \frac{(\text{water stored in root zone})}{(\text{gross application per irrigation})} \times 100 = \left(\frac{\text{inches}}{\text{inches}} \right) \times 100 = \text{_____ \%}$$

Losses = (runoff, deep percolation) = gross application per irrigation minus SWD

$$= (\text{_____}) = \text{_____ inches}$$

Potential Water and Cost Savings:

Present management:

Gross applied per year = (gross applied per irrigation) x (number of irrigations) =

$$= (\text{_____ inches}) \times (\text{_____}) = \text{_____ inches/year}$$

Potential management:

Annual net irrigation requirement _____ inches/year, for _____ (crop)

Potential application efficiency (E_q or E_h) _____ % (from NEH, Part 623, Ch 11)

Potential annual gross applied = $\frac{(\text{annual net irrigation requirement})}{\text{Potential } E_q \text{ or } E_h} \times 100$

$$= (\text{_____ inches}) \times 100 = \text{_____ inches}$$

Total annual water conserved

$$= \frac{(\text{Present gross applied} - \text{potential gross applied}) \times (\text{area irrig. (ac)})}{12} = \text{_____ acre/feet}$$

$$= \left(\frac{\text{_____ inches} - (\text{_____ inches}) \times (\text{_____ acres})}{12} \right) = \text{_____ acre/feet}$$

Sprinkler Irrigation System Detailed Evaluation Periodic Move and Fixed Set Sprinkler System

Cost savings:

Pumping plant efficiency _____ Kind of fuel _____

Cost per unit of fuel \$ _____ Fuel cost per acre/foot \$ _____

Cost savings = (fuel cost per acre-foot) x (acre-feet conserved per year) = \$ _____

= (_____) x (_____) = \$ _____

Water purchase cost:

= (Cost per acre-foot) x (acre-feet saved per year) = _____ x _____ = \$ _____

Cost Savings:

= Pumping cost + water cost = _____ + _____ = \$ _____

Recommendations: _____

Sprinkler Irrigation System Detailed Evaluation Center Pivot Lateral Worksheet

Land user _____ Field office _____

Observer _____ Date _____ Checked by _____ Date _____

Field name/number _____

Center pivot number _____ pivot location in field _____

Acres irrigated _____

Hardware inventory:

Manufacturer: name and model _____

Is design available? _____ (attach copy) Number of towers _____ Spacing of towers _____

Lateral: Material _____, Inside diameter _____ inches

Nozzle: Manufacturer _____

Position _____ Height above ground _____

Spacing _____

Is pressure regulated at each nozzle? _____ operating pressure range _____

Type of tower drive _____

System design capacity _____ gpm, system operating pressure _____ psi

Nozzle data, design:	Pivot	Pivot	Pivot	Pivot	end
Sprinkler position number	_____	_____	_____	_____	_____
Manufacturer	_____	_____	_____	_____	_____
Model	_____	_____	_____	_____	_____
Type (spray, impact, etc.)	_____	_____	_____	_____	_____
Nozzle or orifice size	_____	_____	_____	_____	_____
Location	_____	_____	_____	_____	_____
Wetted diameter (ft)	_____	_____	_____	_____	_____
Nozzle discharge (gpm)	_____	_____	_____	_____	_____
Design pressure (psi)	_____	_____	_____	_____	_____
Operating pressure	_____	_____	_____	_____	_____

End gun make, model _____ (when continuously used in corners)

End gun capacity _____ gpm, Pressure _____ psi, boosted to _____ psi

End swing lateral capacity _____ gpm, pressure _____ psi

Field observations:

Crop uniformity _____

Runoff _____

Erosion _____

Tower rutting _____

System leaks _____

Elevation change between pivot and end tower _____

Sprinkler Irrigation System Detailed Evaluation Center Pivot Lateral Worksheet

Wind: Speed _____ mph Direction (from) _____
 Line direction: From center to outer tower _____ moving _____
 Time of day _____, Humidity: _____ low _____ med _____ high, Air temp _____
 Evaporation: start depth _____ inches, end depth _____ inches, Evaporation _____ inches
 Crop _____, Root zone depth _____ foot, MAD^{1/} _____ %, MAD _____ inches

Soil-water data (typical): (show location of sample site on soil map or sketch of field)

Moisture determination method _____
 Soil series name, surface texture _____

Depth	Texture	*AWC (in) ^{1/}	*SWD (%) ^{1/}	*SWD (in) ^{1/}
_____	_____	_____	_____	_____
_____	_____	_____	_____	_____
_____	_____	_____	_____	_____
_____	_____	_____	_____	_____
_____	_____	_____	_____	_____
Totals		_____	_____	_____

Comments about soils:

Present irrigation practices:

Typical system application:

Crop	Stage of growth percent	Hours per ^{2/} revolution	Speed setting	Net application (in)
_____	_____	_____	_____	_____
_____	_____	_____	_____	_____
_____	_____	_____	_____	_____

Hours operated per day _____ hours
 Approximate number of pivot revolutions per season _____

1/ MAD = Management allowed depletion, AWC = Available water capacity, SWD = Soil water deficit
 2/ To calculate the hours per revolution around the field, first calculate the average speed the end tower moves per cycle (start to start) = distance in feet divided by time in seconds.

Then: hours per revolution =
$$\frac{2 \text{ (distance to end tower in feet)} \times \pi}{\text{(end tower speed in ft/s)} \times 3,600 \text{ seconds per hour}}$$

Sprinkler Irrigation System Detailed Evaluation Center Pivot Lateral Worksheet

System data:

Distance from pivot point to : end tower _____ ft, wetted edge _____ ft

* End tower speed: Distance between stakes _____

Time at first stake _____, Time at second stake _____

Time to travel between stakes _____ min

* This method is satisfactory for a continuous moving system, but need to allow for moving in start-stop cycles.

Recommend using end tower move distance and from start to star. Typically, percent speed setting for end tower represents, 60% = 36 seconds of each minute, 72 seconds of each 2 minutes, etc.

Measured system flow rate _____ gpm, method _____

Calculations: _____

Evaluation computations:

Circumference of end tower:

$$\text{Distance to end tower} \times 2\pi = \frac{(6.2832)}{2} \times \text{Distance to end tower} = \text{_____ ft}$$

End tower speed:

$$\frac{\text{Distance traveled (ft)} \times 60}{\text{Time in minutes}} = \text{_____} \times 60 = \text{_____ ft/hr}$$

Hours per revolution:

$$\frac{\text{Circumference at end tower (ft)}}{\text{End tower speed (ft/hr)}} = \text{_____} = \text{_____ hr}$$

Area irrigated:

$$\frac{(\text{Distance to wetted edge})^2 \times \pi}{43,560 \text{ square feet/acre}} \times \frac{(3.1416)}{43,560} = \text{_____} \times 3.1416 = \text{_____ ac}$$

Gross application per irrigation:

$$\frac{\text{Hours per revolution} \times \text{gpm}}{435 \times \text{acres irrigated}} = \frac{\text{_____}}{453 \times \text{ac}} = \text{_____ in}$$

Weighted system average application:

$$\frac{\text{Sum of: catch x factors}}{(\text{Sum of: factors}) \times \text{number of containers}} = \text{_____} = \text{_____ cc (ml)}$$

Sprinkler Irrigation System Detailed Evaluation Center Pivot Lateral Worksheet

Convert cc (ml) in measuring cylinder to inches depth in catch container:

_____ cc (ml) = 1 inch in catch container

Average application = $\frac{\text{Average catch (cc)}}{\text{cc/inch}}$ = _____ = _____ in

Weighted low 1/4 average application:

$\frac{\text{Sum of low 1/4 catch x factors}}{(\text{Sum of low 1/4 factors}) \times \text{number of low 1/4 containers}}$ = _____ = _____ cc (ml)

Low 1/4 average application = $\frac{\text{Average low 1/4 (cc)}}{\text{cc/inch}}$ = _____ = _____ in

Distribution uniformity low 1/4 a (DU):

DU = $\frac{\text{Weighted low 1/4 average applic.}}{\text{Weighted system average application}}$ = _____ = _____ %

Approximate Christiansen uniformity (CU):

CU = 100 - [0.63 x (100 - DU)] = 100 - [0.63 x (100 - _____)] = _____ %

Effective portion of water applied (R_e):

$R_e = \frac{\text{Weighted system average application (in)}}{\text{Gross applicaiton (in)}}$ = _____ = _____

Application efficiency of low 1/4 (E_q):

$E_q = DU \times R_e =$ _____ = _____ %

(Use for medium to high value crops)

Approximate application efficiency low 1/2 (E_h):

$E_h = DU \times R_e =$ _____ = _____ %

(Use for low value field and forage crops)

Sprinkler Irrigation System Detailed Evaluation Center Pivot Lateral Worksheet

Application:

$$\frac{\text{Gross application x hours operated per day x } (E_q \text{ or } E_h)}{\text{Hours per revolution x 100}}$$

= _____ = _____ in/day

Maximum average application rate:

$$\frac{\text{Maximum catch inches x 60}}{\text{Time containers are uncovered in minutes}} = \text{_____} = \text{_____ in/hr}$$

Pivot revolutions required to replace typical annual moisture deficit:

(Based on existing management procedures)

Annual net irrig. requirement _____ in, for _____ (crop)

Pivot revolutions required:

$$\frac{\text{Annual net irrig. requirement x 100}}{(E_q \text{ or } E_h) \times \text{gross applic. per irrig.}} = \text{_____} = \text{_____}$$

Potential water and cost savings

Present management::

Gross applied per year = gross applied per irrig x number of irrig

= _____ = _____ in/yr

Potential management:

Potential application efficiency (E_{pq} or E_{ph}) _____ percent (from irrigation guide, NEH Sec 15, Ch 11, or other source)

$$\text{Potential annual gross applied} = \frac{\text{Annual net irrig. requirement x 100}}{\text{Potential } E_{pq} \text{ or } E_{ph}}$$

= _____ = _____ inches

Sprinkler Irrigation System Detailed Evaluation Center Pivot Lateral Worksheet

Total annual water conserved:

$$= \frac{(\text{Present gross applied} - \text{potential gross applied}) \times \text{area irrig. (acre)}}{12}$$

$$= \frac{\text{_____}}{12} = \text{_____ acre feet}$$

Cost savings:

Pumping plant efficiency _____ kind of fuel _____

Cost per unit of fuel _____ fuel cost per acre foot \$ _____

Cost savings = fuel cost per acre foot x acre foot conserved per year

$$= \text{_____} = \$ \text{_____}$$

Water purchase cost:

$$= \text{Cost per acre foot} \times \text{acre feet saved per year} = \text{_____}$$

$$= \$ \text{_____}$$

$$\text{Cost savings} = \text{pumping cost} + \text{water cost} = \text{_____} = \$ \text{_____}$$

Recommendations:

Center pivot lateral evaluation, distribution profile of catch

$E_h =$ _____

$E_q =$ _____

Land user _____

Date _____

Field office _____

Container catch (inches)

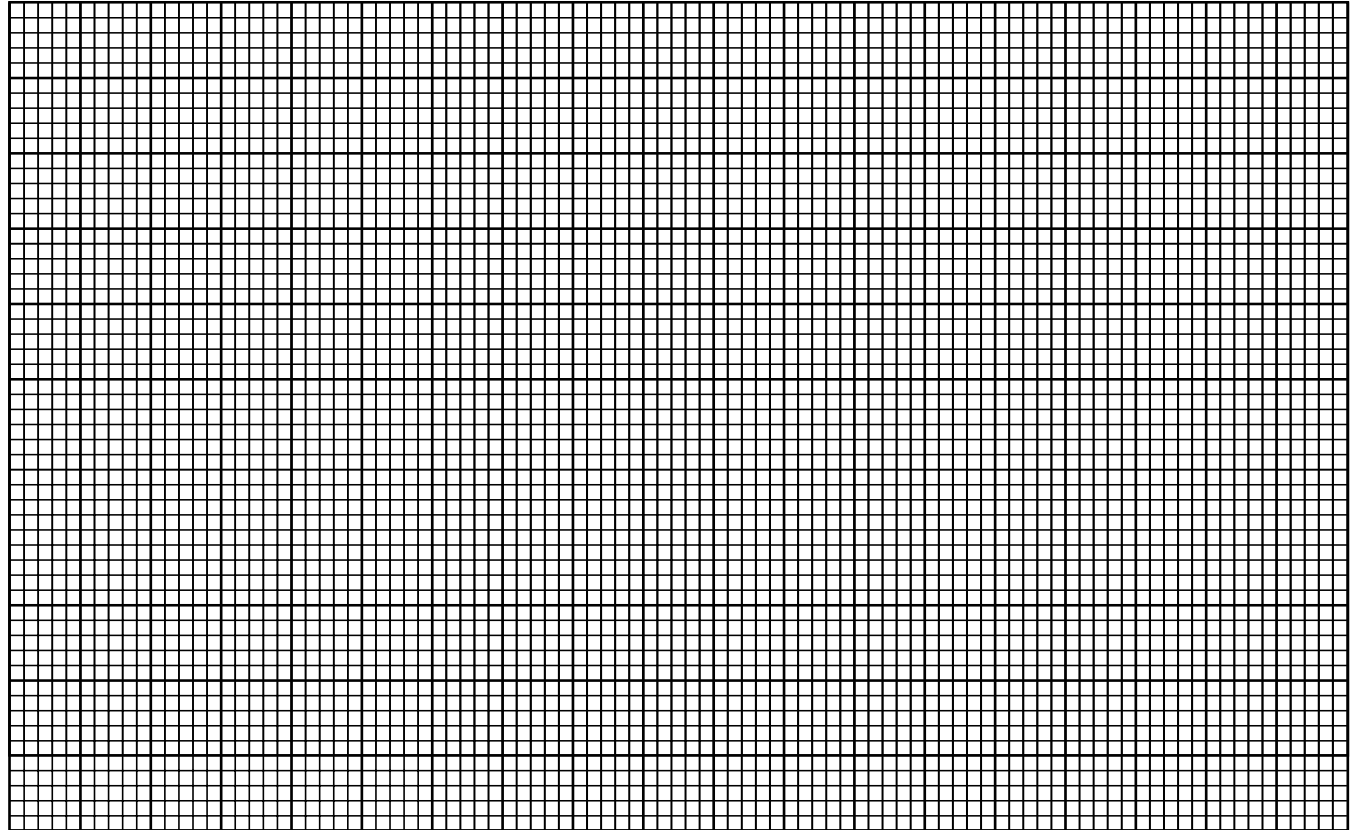

Container number

Sprinkler Irrigation System Detailed Evaluation Continuous Move, Large Sprinkler Gun Type

Land user _____ Date _____ Prepared by _____
 District _____ County _____ Eng job class _____

Irrigation system hardware inventory:

Sprinkler gun make _____, model _____, nozzle type _____
 Nozzle: size _____ inches, _____ mm
 Manufacturer rated discharge, _____ gpm at _____ psi giving _____ ft wetted diameter
 Hose: length, _____ ft, diameter _____ inches
 Towpath: spacing _____ ft
 Elevation difference between first and last location on towpath (+/-) _____ ft or _____ % slope
 Gun: height _____ ft
 Mainline: material _____ diameter _____ inches

Field observations:

Crop uniformity _____
 Water runoff _____
 Erosion _____
 System leaks _____
 Wind drift _____
 Other observations _____

Field data inventory and computations:

Crop _____, root zone depth _____ ft, MAD ^{1/} _____ %, MAD ^{1/} _____ inches

Soil-water data (typical):

(Show locations of sample on soil map or sketch of field)

Moisture determination method _____				
Soil series and surface texture _____				
Depth	Texture	AWC (in) ^{1/}	SWD (%) ^{1/}	SWD (in) ^{1/}
_____	_____	_____	_____	_____
_____	_____	_____	_____	_____
_____	_____	_____	_____	_____
_____	_____	_____	_____	_____
_____	_____	_____	_____	_____
Totals		_____	_____	_____

Comments about soils and soil condition: _____

^{1/} MAD = Management Allowable depletion, AWC = Available water capacity, SWD = Soil water deficit

Sprinkler Irrigation System Detailed Evaluation Continuous Move, Large Sprinkler Gun Type

Present irrigation practices:

Typical irrigation duration _____ hr, irrigation frequency _____ days

Typical number of irrigations per year _____

Test:

Start _____, Stop _____, Duration _____ = _____ hour

Atmospheric data;

Wind: Direction: Initial _____, during _____, final _____

Speed (mph): Initial _____, during _____, final _____

Temperature: initial _____ final _____, humidity: _____ low _____ med _____ high

Evaporation container: initial _____, final _____, loss _____ inches

Pressure: _____ psi, at start of test

_____ psi, at end of test

Measured flow into the system _____gpm

Sprinkler travel speed:

at beginning _____ ft _____ min = _____ ft/min

at test site _____ ft _____ min = _____ ft/min

at terminal end _____ ft _____ min = _____ ft/min

average _____ ft/min

Calculations:

Gross average depth of water applied = $\frac{(\text{gun discharge, gpm}) \times (1.605)}{(\text{tow path spacing, ft}) \times (\text{travel speed, ft/min})}$

= $\left(\frac{\text{gpm}}{\text{ft}} \right) \times (1.605) = \text{_____ in}$

Average overlapped catches

System = $\frac{(\text{sum all catch totals _____ in})}{(\text{number of totals _____})} = \text{_____ in}$

Low 1/4 = $\frac{(\text{sum of low 1/4 catch totals _____ in})}{(\text{number of low 1/4 catches _____})} = \text{_____ in}$

Average application rate = $\frac{(\text{Flow, gpm}) \times (13,624)}{(\text{tow path spacing, ft}) \times (\text{wet sector, deg.})}$

= $\left(\frac{\text{gpm}}{\text{ft}} \right) \times (13,624) = \text{_____ in/hr}$

Maximum application rate = (average application rate, in/hr) x (1.5)

Sprinkler Irrigation System Detailed Evaluation Continuous Move, Large Sprinkler Gun Type

Container test data

Catch can type _____, _____ cc (mL)/in

Left Right

Note part circle operation
 and the dry wedge size in degrees

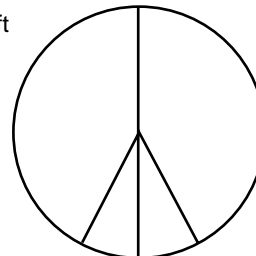

← 4, 3, 2, 1 Container catch row 1, 2, 3, 4 →

Path spacing (ft)	Container catch volume				Right plus left side catch totals	
	Left side of path		Right side of path		mL	inches
	Catch no.	Catch (mL)	Catch no.	Catch (mL)		
330	1		33			
320	2		32			
310	3		31			
300	4		30			
290	5		29			
280	6		28			
270	7		27			
260	8		26			
250	9		25			
240	10		24			
230	11		23			
220	12		22			
210	13		21			
200	14		20			
190	15		19			
180	16		18			
170	17		17			
160	18		16			
150	19		15			
140	20		14			
130	21		13			
120	22		12			
110	23		11			
100	24		10			
90	25		9			
80	26		8			
70	27		7			
60	28		6			
50	29		5			
40	30		4			
30	31		3			
20	32		2			
10	33		1			

Sum of all catch totals _____

Sum of low 1/4 catch totals _____

Sprinkler Irrigation System Detailed Evaluation Continuous Move, Large Sprinkler Gun Type

Potential water and cost savings:

Present management:

Gross applied per year = (Gross applied per irrigation) x (number of irrigation) = _____ in/yr
 + (_____ in) x (_____) = _____ in/yr

Potential management:

Annual net irrigation requirement _____ in/yr, for _____ (crop)

Potential application efficiency (E_q or E_h) _____ % (estimated at 55 - 65%)

Potential annual gross applied = $\frac{\text{(annual net irrigation requirement)}}{\text{Potential } E_q \text{ or } E_h} \times 100 = \text{_____ in}$

= (_____ in) x 100 = _____ inches

Total annual water conserved

= $\frac{\text{(Present gross applied, inches - potential gross applied, inches)}}{12} \times \text{(area irrigated, ac)} = \text{_____ ac-ft}$

= $\frac{\text{(_____ in) - (_____ in)} \times \text{(_____ ac)}}{12} = \text{_____ ac-ft}$

Cost savings:

Pumping plant efficiency _____ kind of energy _____

Cost per unit of energy \$ _____ energy cost per ac-ft \$ _____

Cost savings = (energy cost per ac-ft) x (ac-ft conserved per year) = \$ _____

= (_____) x (_____) = \$ _____

Water purchase cost:

= (Cost per ac-ft) x (ac-ft saved per year) = \$ _____ x _____ = \$ _____

Cost savings:

= Pumping cost + water cost = _____ + _____ = \$ _____

Micro Irrigation System Detailed Evaluation Worksheet

Land user _____ Date _____ Prepared by _____

District _____ County _____

Crop: _____ age _____ plant and row spacing _____

Soil: mapping unit _____ surface texture _____

actual depth _____ AWC _____ inches/feet

Irrigation: duration _____ frequency _____ MAD _____ % _____ inches/feet

Irrigation system hardware:

Filter: pressure at: inlet _____ psi, outlet _____ psi, loss _____ psi

Emitter: manufacturer _____ type _____ spacing _____

Rated discharge per emitter (emission point): _____ gph at _____ psi

Emission points per plant _____ giving _____ gallons per plant per day

Later: diameter: _____ material _____ length _____ spacing _____

Sketch of micro irrigation system layout:

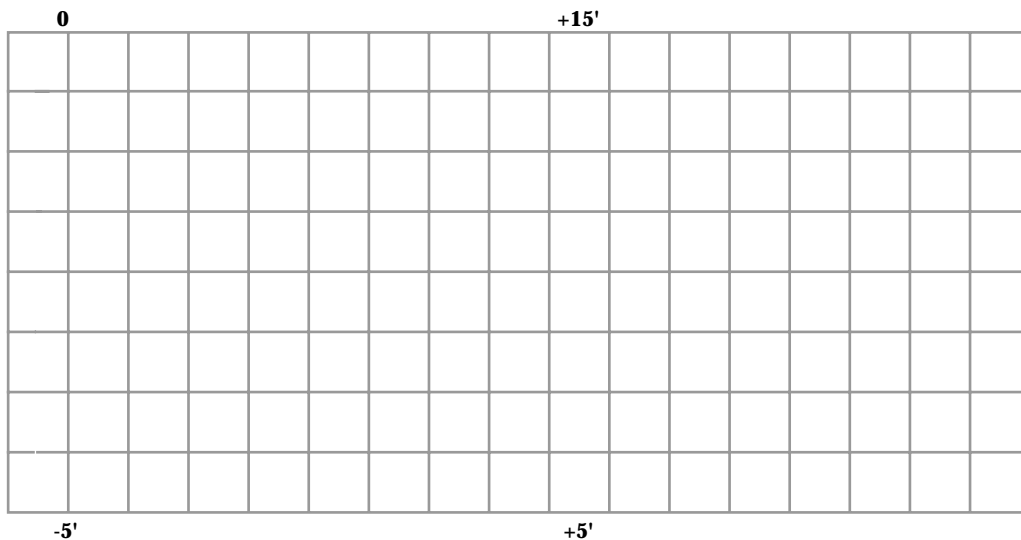

Micro Irrigation System Detailed Evaluation Worksheet

System discharge: _____ gpm, number of manifolds _____ and blocks _____

Average test manifold emission point discharges at _____ psi

Manifold = $\frac{(\text{sum of all averages } \text{gph})}{(\text{number of averages})} = \text{_____ gph}$

Low 1/4 = $\frac{(\text{sum of low 1/4 averages } \text{gph})}{(\text{number of low 1/4 averages})} = \text{_____ gph}$

Adjusted average emission point discharges at _____ psi

System = (DCF _____) x (manifold average _____) = _____ gph

Low 1/4 = (DCF _____) x (manifold low 1/4 _____) = _____ gph

Discharge test volume collected in _____ minutes (1.0 gph = 63 ML/min)

Outlet location on lateral		Lateral location on the manifold							
		inlet end		1/3 down		2/3 down		far end	
		mL	gph	mL	gph	mL	gph	mL	gph
inlet end	A								
	B								
ave									
1/3 down	A								
	B								
ave									
2/3 down	A								
	B								
ave									
far end	A								
	B								
ave									

Micro Irrigation System Detailed Evaluation Worksheet (cont.)

Lateral: inlet pressure _____ psi _____ psi _____ psi _____ psi
 far end pressure _____ psi _____ psi _____ psi _____ psi
Wetted area per plant _____ ft² _____ ft² _____ ft² _____ ft²
 _____ % _____ % _____ % _____ %

Estimated average SMD in wetted soil volume _____

Minimum lateral inlet pressures, MLIP, on all operating, manifolds:

Manifold ID: Test _____ _____ _____ _____ _____ _____ _____ _____ Ave.
pressure, psi _____ _____ _____ _____ _____ _____ _____ _____

Discharge correction factor, DCF, for the system is:

$$DCF = \frac{2.5 \times (\text{average MLIP} \quad \text{psi})}{(\text{average MLIP} \quad \text{psi} + (1.5 \times \text{test MLIP} \quad \text{psi}))} = \quad \text{psi}$$

or if the emitter discharge exponent, x = _____ is known,

$$DCF = \frac{(\text{average MLIP} \quad \text{psi})}{(\text{test MLIP} \quad \text{psi})} \times \text{-----} = \quad \text{psi}$$

Comments: _____

Pumping Plant Detailed Evaluation Worksheet

Land user _____ Field office _____
Observer _____ Date _____ Checked by _____ Date _____
Field name or number _____ Acres irrigated _____

Hardware Inventory:

Power plant:

Electric motor(s):	<u>Main pump</u>	<u>Booster (if used)</u>
Make	_____	_____
Model	_____	_____
Rated rpm	_____	_____
Rated hp	_____	_____

Internal combustion engine:

Make _____
Model _____
Continuous rated hp at output shaft _____ hp at _____ rpm
Comments about condition of power plant _____

Gear or belt drive mechanism:

Type: (check one) direct drive _____ gear drive _____ belt drive _____
_____ rpm at driver _____ rpm at pump

Pumps

Type: (centrifugal, turbine, submers.)	_____	_____
Make	_____	_____
Model	_____	_____
Impeller diameter	_____	_____
Number of impellers	_____	_____
Rated flow rate (gpm)	_____	_____
at head of (ft)	_____	_____
at rpm	_____	_____

Pump curves: Attached _____ (yes or no)

Comments about condition of equipment _____

Pumping Plant Detailed Evaluation Worksheet

Land user _____ Field office _____

Existing suction or turbine column set-up (sketch showing dimensions)

Existing discharge set-up (sketch showing dimensions)

Data and computations:

Total Dynamic Head (TDH):

Elevation difference - water surface to pump outlet _____ feet

Pressure reading at pump outlet _____ psi

Pressure at pump inlet (where supply is pressurized) _____ psi

Estimated friction loss in suction pipe or pump column _____ feet

Miscellaneous friction loss _____ feet

TDH = (elevation difference between water source and pump discharge) + (discharge pressure - pressure at inlet) times 2.31 + (estimated suction pipe friction loss) + miscellaneous =

_____ = _____ feet

Flow rate:

Flow meter:

Flow rate = _____ gpm

Velocity meter:

Pipe ID _____ inches

Velocity _____ feet/second

Flow rate, Q, in gpm = (Velocity, in feet/second) x (2.45) x (pipe ID²) =

= _____ = _____ gpm

Pumping Plant Detailed Evaluation Worksheet

Land user _____ Field office _____

Water horsepower:

$$\text{whp} = \frac{(\text{flow rate, in gpm}) \times (\text{TDH, in feet})}{3960} = \text{_____ hp}$$

Energy input

Electric:

Disk revolutions _____

Time: min _____ sec _____ = _____ sec

Meter constant (Kh) _____

PTR (power transformer ratio - usually 1.0)^{1/} _____

CTR (current transformer ratio - usually 1.0)^{1/} _____

$$\text{KW} = \frac{(3.6) \times (\text{disk rev}) \times (\text{Kh}) \times (\text{PTR}) \times (\text{CTR})}{(\text{time, in seconds})} = \text{_____ (kwh/h)}$$

Diesel or gasoline:

Evaluation time: hours _____ minutes _____ = _____ hours

Fuel use _____ gallons (a small quantity of fuel may also be weighed, at 7.05 lb/gal for diesel and 6.0 lb/gallon for gasoline)

$$\frac{(\text{fuel use, in gallons})}{(\text{time, in hours})} = \text{_____} = \text{_____ gallons/hour}$$

Propane:

Evaluation time: hours _____ minutes _____ = _____ hours

Fuel use _____ lb (weigh fuel used from small portable tank)

$$\frac{(\text{fuel use, in lb})}{(4.25 \text{ lb/gal}) \times (\text{time, in hr})} = \text{_____} = \text{_____ gallon/hours}$$

Natural gas:

Evaluation time: hours _____ minutes _____ = _____ hours

Meter reading: End _____ minus Start _____ = _____ mcf

$$\frac{(\text{fuel used, in mcf})}{(\text{time, in hr})} = \text{_____} = \text{_____ mcf/hr}$$

^{1/} Some power companies use a type of meter that requires a PTR or CTR correction factor. Check with local power company.

Pumping Plant Detailed Evaluation Worksheet

Land user _____ Field office _____

In the next step, the efficiency of the power plant and pump, as a unit, is compared to the Nebraska Standards for irrigation pumping plants. The Nebraska standard for a good condition, properly operated plant. If the comparison comes out less than 100%, there is room for improvement.

Nebraska performance rating:

Nebraska pumping plant performance criteria _____

Pump and Power Plant

Energy source	Whp-h/unit of energy	Energy unit
Diesel	12.5	gallon
Propane	6.89	gallon
Natural gas	61.7	mcf
Electricity	0.885	kW=kwh/hr
Gasoline	8.66	gallon

The Nebraska standards assume 75% pump and 88% electric motor efficiency.

Percent of Nebraska performance rating

$$= \frac{\text{(whp)} \times (100)}{\text{(energy input)} \times \text{(Nebraska criteria, in whp-h/unit)}} =$$

$$= \text{_____} = \text{_____} \%$$

Horsepower input:

Electric:

$$\frac{\text{(input kW)}}{(0.746 \text{ kW/bhp})} = \text{_____} = \text{_____} \text{ bhp}$$

Diesel:

$$(16.66) \times \text{(energy input, in gal/hr)} = \text{_____} = \text{_____} \text{ bhp}$$

Propane:

$$(9.20) \times \text{(energy input, in gal/hr)} = \text{_____} = \text{_____} \text{ bhp}$$

Natural gas:

$$(82.20) \times \text{(energy input, in mcf/hr)} = \text{_____} = \text{_____} \text{ bhp}$$

Pump performance curve

Case: Material C.I. Patt. No. H-689 Mach. No. H-689 3600 NOMINAL R.P.M. 60 Cycles
 Impeller: Material BRZ Patt. No. M-3380 Mach. No. M-3380 Dia. 9" FULL T.D.B.L. for fresh water at sea level 80° F max.
 M-1 M-2
 MAXIMUM WORKING PRESSURE 215 PSI

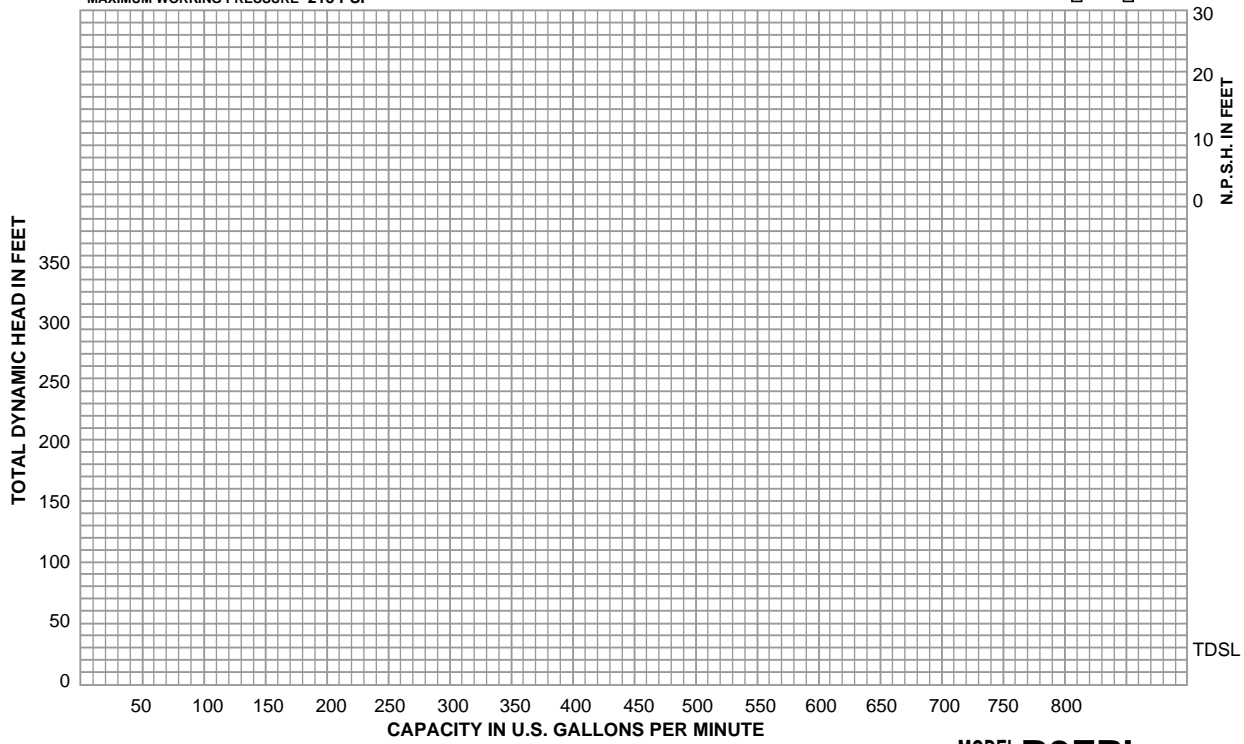

Based on T-3184

Superaades C-5006 Dated 10-30-64

Date 5-19-71

MODEL **B3ZPL**

Soil Description

Soil			File No.		
Area		Date		Stop No.	
Classification					
Location					
N. veg. (or crop)				Climate	
Parent material					
Physiography					
Relief		Drainage		Salt or alkali	
Elevation		Gr. water		Stoniness	
Slope		Moisture			
Aspect		Root distrib.		% Clay*	
Erosion		% Coarse fragments*		% Coarser than V.F.S.*	
Permeability					
Additional notes					

*Control section average														
Horizon	Depth	Color		Texture	Structure	Color			Reaction	Boundary	Effervescence	Roots	Pore	Line
		Dry	Moist			Dry	Moist	Wet						

Land user _____

Date _____

Field office _____

Soil water intake curves

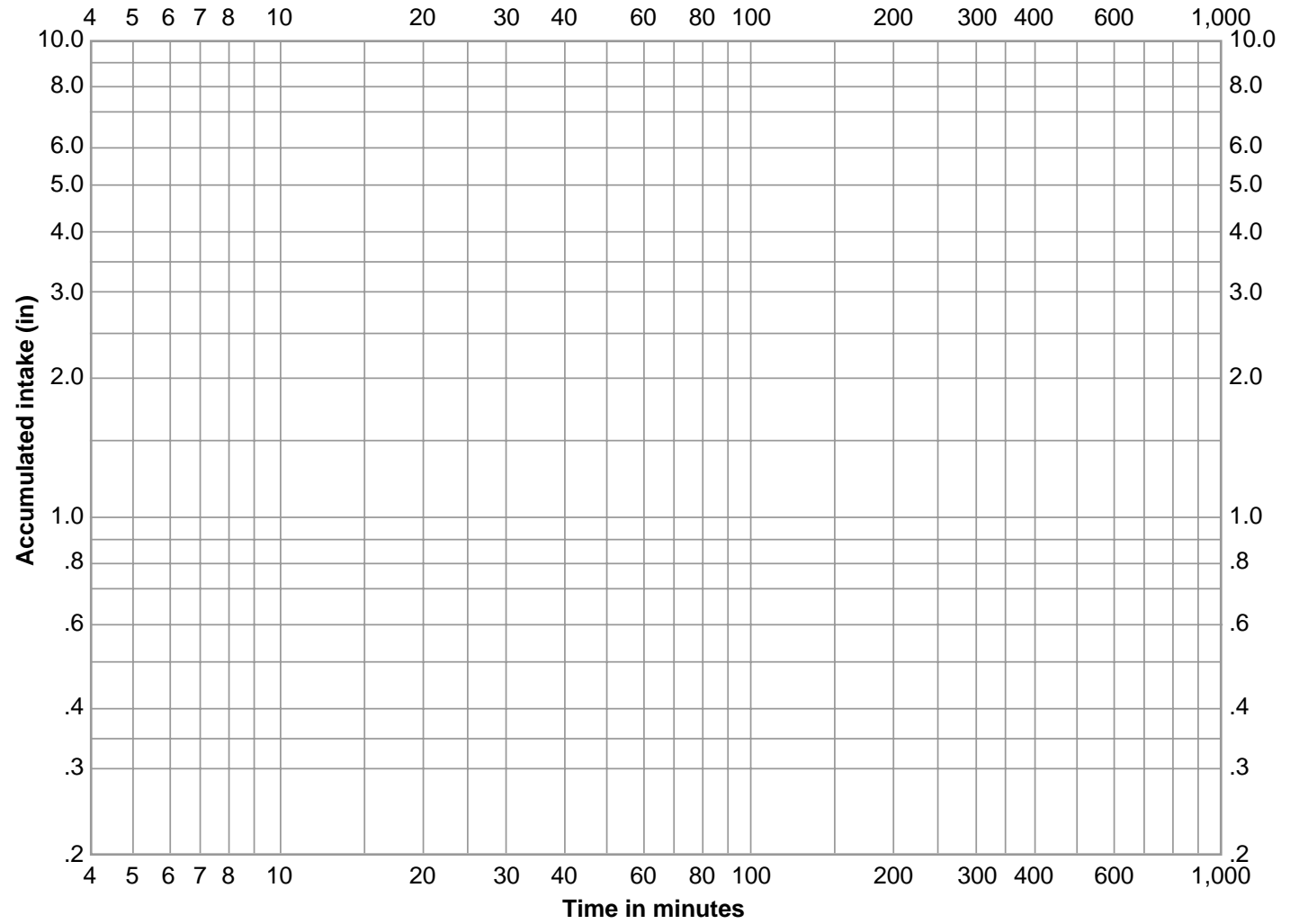

Intake curve overlay

(Clear plastic overlay is available through NRCS State Office)

Land user _____

Date _____

Field office _____

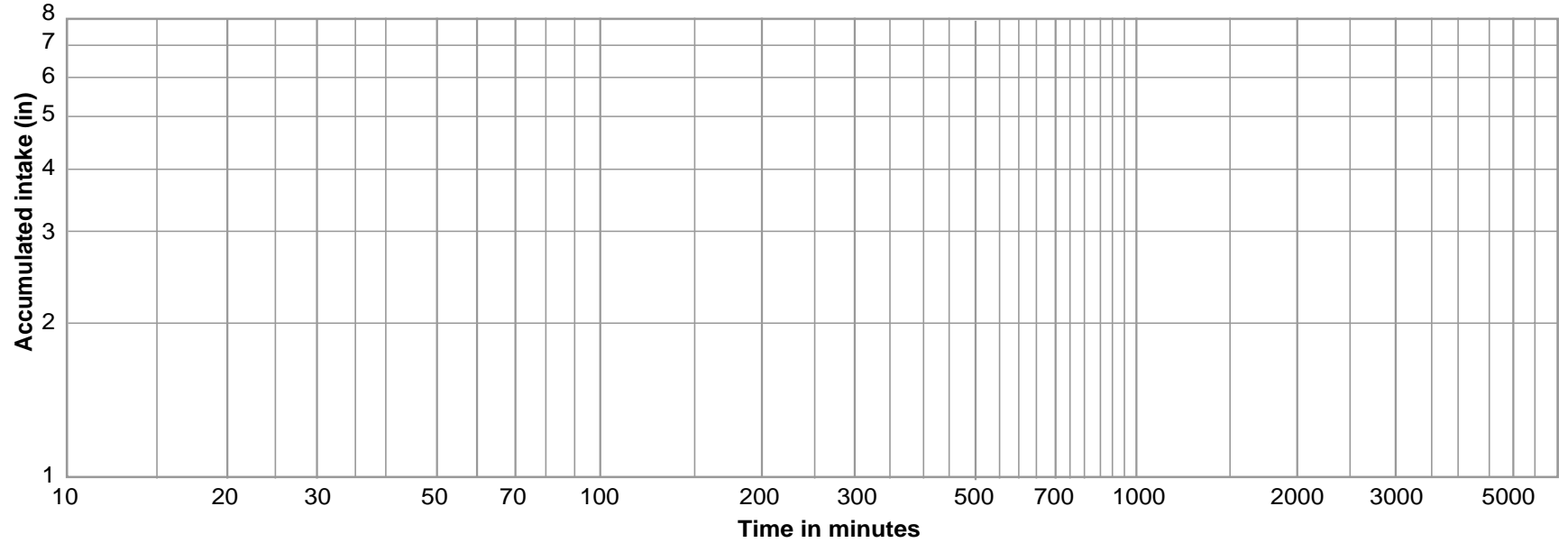

Intake Grouping for Border Irrigation Design

Instructions

1. Plot data from cylinder intake test on matching logarithmic paper using accumulated intake (inches) as ordinates and elapsed time (minutes) as abscissas. Draw line representing test results.
2. Place overlay over plotted curve, matching the intersection of the lines for 10 minutes time and 1 inch intake. Select the intake family that best represents the plotted curve within the normal irrigation range.

Land user _____

Date _____

Field office _____

Accumulated intake vs. time

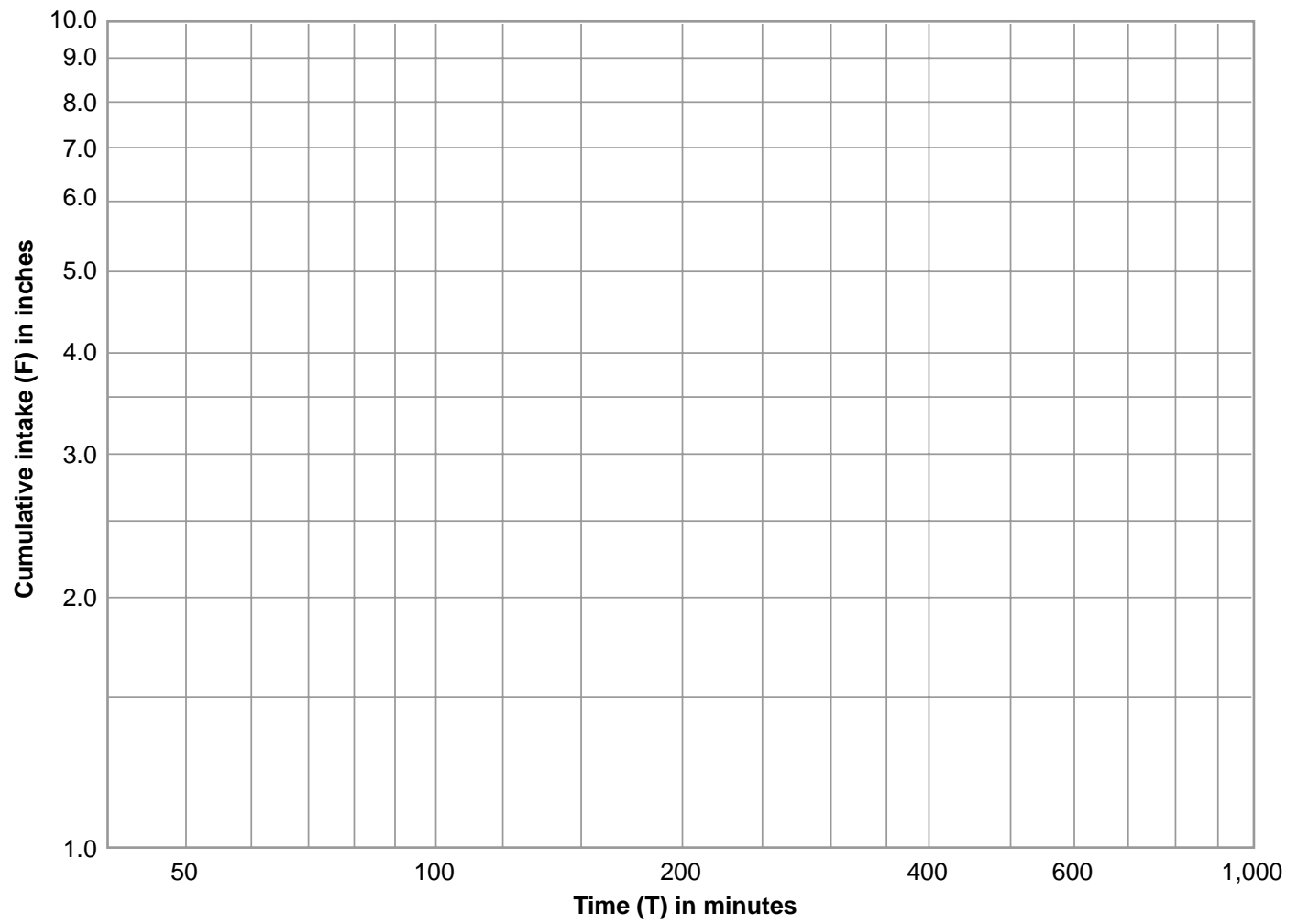

Land user _____
Date _____
Field office _____

Intake families as used with furrow irrigation

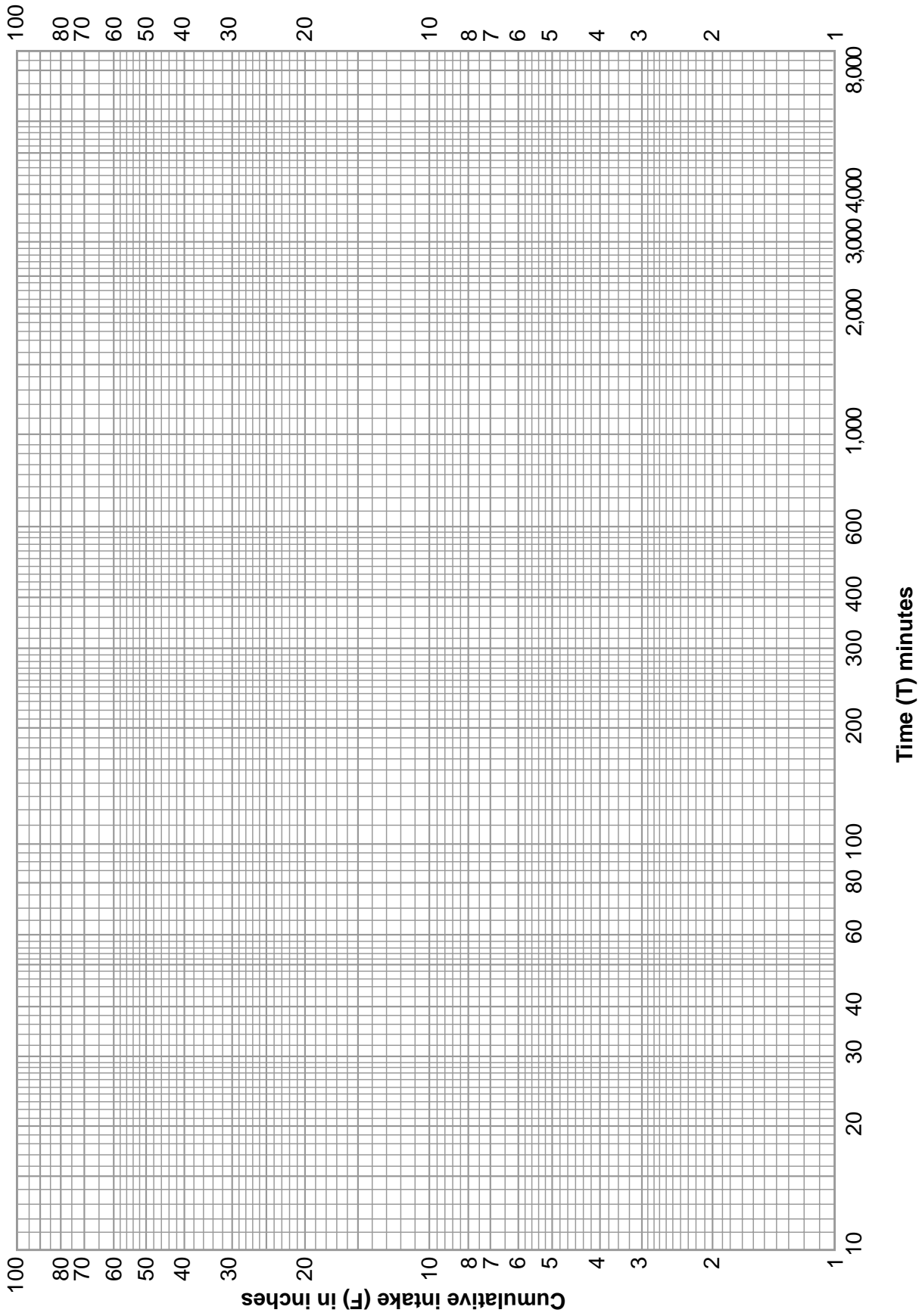



Natural
Resources
Conservation
Service

Estimating Soil Moisture by Feel and Appearance

Irrigation Water Management (IWM) is applying water according to crop needs in an amount that can be stored in the plant zone of the soil.

The feel and appearance method is one of several irrigation scheduling methods used in IWM. It is a way of monitoring soil moisture to determine when to irrigate and how much water to apply. Applying too much water may cause excessive runoff and/or deep percolation. As a result, nutrients and chemicals may be lost or leached into the ground water.

In applying this method, you determine the amount of irrigation water needed by subtracting water in soil storage (estimated using the feel and appearance method) from the available water capacity (AWC) of the soil. (See the example computation below.)

The feel and appearance of soil varies with texture and moisture content. Water available for plant use can be estimated, with experience, to an accuracy of about 5 percent. Soil moisture is typically sampled in

1-foot increments to the root depth of the crop at three or more sites per field. You vary the number of sample sites and depths according to: crop, field size, soil texture, and soil stratification. For each sample the feel and appearance method involves:

1. Obtaining a soil sample at the selected depth using a probe, auger, or shovel;
2. Squeezing the soil sample firmly in your hand several times to form an irregularly shaped ball;
3. Observing soil texture, ability to ribbon, firmness and surface roughness of ball, water glistening, loose soil particles, soil/water staining on fingers, and soil color;
4. Comparing observations with photographs and/or chart to estimate percent water available. (Note: A very weak ball disintegrates with one bounce of the hand. A weak ball disintegrates with 2 to 3 bounces.)

Example for a uniform soil

Sample depth (inches)	Zone (inches)	USDA texture	Field capacity* (percent)	AWC for layer (inches)	Water available (inches)	Water need (inches)
6	0-12	sandy loam	30	1.4	.42	.98
18	12-24	sandy loam	45	1.4	.63	.77
30	24-36	loam	60	2.0	1.20	.80
42	36-48	loam	75	2.0	1.50	.50
				6.8	3.75	3.05

* Determined by feel and appearance method



Summary of estimation

	(inches)
AWC in 48" root zone at 100% field capacity	6.8
Actual water available for plant use	3.7
Net irrigation requirement or need	3.1

Fine sand and loamy fine sand soils

Appearance of fine sand and loamy fine sand soils at various soil moisture conditions.



Available water capacity 0.6–1.2 inches/foot

Available Soil Moisture	Description	Illustration
0-25	Appears dry, will hold together if not disturbed, loose sand grains on fingers.	
25-50	Slightly moist, forms a very weak ball with well-defined finger marks, light coating of loose and aggregated sand grains remain on fingers.	
50-75	Moist, forms a weak ball with loose and aggregated sand grains on fingers, darkened color, light uneven water staining on fingers.	
75-100	Wet, forms a weak ball, loose and aggregated sand grains remain on fingers, darkened color, heavy water staining on fingers, will not ribbon.	
100 (field capacity)	Wet, forms a weak ball, light to heavy soil/water coating on fingers, wet outline of soft ball remains on hand.	

Sandy loam and fine sandy loam soils



Appearance of sandy loam and fine sandy loam soils at various soil moisture conditions.

Available Water Capacity 1.3–1.7 inches/foot

Available Soil Moisture	Description	Illustration
0-25	Appears dry, forms a very weak ball, aggregated soil grains break away easily from ball.	
25-50	Slightly moist, forms a weak ball with defined finger marks, darkened color, no water staining on fingers.	
50-75	Moist, forms a ball with defined finger marks, very light soil/water staining on fingers, darkened color, will not slick.	
75-100	Wet, forms a ball with wet outline left on hand, light to medium staining on fingers, makes a weak ribbon.	
100 (field capacity)	Wet, forms a soft ball, free water appears briefly on soil surface after squeezing or shaking, medium to heavy soil/water coating on fingers.	

Sandy clay loam and loam soils



Appearance of sandy clay loam and loam soils at various soil moisture conditions.
 Available Water Capacity..... 1.5–2.1 inches/foot

Available Soil Moisture	Description	Illustration
0-25	Appears dry, soil aggregations break away easily, no staining on fingers, clods crumble with applied pressure.	
25-50	Slightly moist, forms a weak ball with rough surfaces, no water staining on fingers, few aggregated soil grains break away.	
50-75	Moist, forms a ball, very light staining on fingers, darkened color, pliable, forms a weak ribbon.	
75-100	Wet, forms a ball with well defined finger marks, light to heavy soil/water coating on fingers, ribbons between thumb and forefinger.	
100 (field capacity)	Wet, forms a soft ball, free water appears briefly on soil surface after squeezing or shaking, thick soil/water coating on fingers.	

Clay, clay loam and silty clay loam soils

Appearance of clay, clay loam and silty clay loam soils at various soil moisture conditions.

Available Water Capacity 1.6–2.4 inches/foot

Available Soil Moisture	Description	Illustration
0-25	Appears dry, soil aggregations separate easily, clods are hard to crumble with applied pressure.	
25-50	Slightly moist, forms a weak ball, very few soil aggregations break away, no water stains, clods flatten with applied pressure.	
50-75	Moist, forms a smooth ball with defined finger marks, light staining on fingers, ribbons between thumb and forefinger.	
75-100	Wet, forms a ball, uneven medium to heavy soil/water coating on fingers, ribbons easily.	
100 (field capacity)	Wet, forms a soft ball, free water appears on soil after squeezing or shaking, thick soil/water coating on fingers, slick and sticky.	

Chapter 16

Special Use Tables, Charts, and Conversions

Contents:	652.1600	General	16-1
	652.1601	English conversion units	16-1
	652.1602	Metric conversion units	16-3

Exhibits	Exhibit 16-1	Irrigation related units conversion factors	16-1
	Exhibit 16-2	Units of area, length, weight, volume, pressure, flow, velocity, temperature, yields, and rates	16-3

Chapter 16

Special Use Tables, Charts, and Conversions

652.1600 General

This chapter contains commonly used tables, charts, and conversions that were not included in the major parts of the guide, but do provide a definite use. Tables and charts can be added as needed. This chapter will vary in size and scope.

652.1601 English conversion units

Throughout this guide, English units generally are used followed with metric units in parenthesis. Exhibit 16-1 displays commonly used conversion factors relating to irrigation.

Exhibit 16-1 Irrigation related units conversion factors

Volume, weight, and flow units

1 gallon (gal)	= 231 cubic inches (in ³) = 0.13368 cubic feet (ft ³)
1 gallon of water weighs	= 8.345 pounds (lb)
1 million gallons (mg)	= 3.0689 acre-feet (ac-ft) = 133,700 cubic feet (ft ³)
cubic foot water	= 1728 cubic inches (in ³) = 7.48 gallons
1 cubic foot of water weighs	= 62.4 pounds (lb)
1 acre-foot (ac-ft)	= amount of water to cover 1 acre 1 foot deep = 43,560 cubic foot (ft ³) = 325,850 gallons = 12 acre-inches (ac-in)
1 acre-inch per day (ac-in/da)	= 18.7 gallons per minute (gpm)
1 million gallons (mg)	= 3.0689 acre-feet (ac-ft)
1 million gallons per day (mgd)	= 1.547 cubic feet per second (ft ³ /s), = 695 gallon per minute (gpm)
1 cubic foot per second	= 448.83 (typically rounded to 450) gallons per minute (gpm) = 7.48 gallons per second = 0.646 million gallons per day (mgd) = 0.992 (typically rounded to 1) acre-inch per hour (ac-in/hr) = 1.983 (typically rounded to 2) acre-feet per day (ac-ft/d) = 40 miners inches (11.25 gpm)—AZ, CA, MT, NV, OR = 50 miners inches (9 gpm)—ID, KA, NE, NM, ND, UT = 38.4 miners inches—CO

Exhibit 16-1 Irrigation related units conversion factors—Continued**Pressure units**

1 atmosphere (1 bar)	= 14.697 pounds per square inch (lb/in ²) = 2116.3 pounds per square foot (lb/ft ²) = 33.93 feet of water = 29.92 inches of mercury
1 pound per square inch	= 144 pounds per square foot = 2.31 feet of head of water
1 pound per square foot	= 48 Pa = .0048 kPa
1 foot head of water (ft)	= 0.433 pounds per square inch = 0.0295 atmospheres (bars)

Energy units

1 hp	= 0.746 kw
1 kw	= 1.3405 hp

Soil and water chemistry units

1 meq/liter = 1 mg/liter/equiv. weight	1 mg/L = 1 ppm
	1 ml water = 1 cc water
	1 ml water = 1 mg

Element	Equivalent weight	Element	Equivalent weight
Ca	2.0	CO ₃	30
Mg	12.2	HCO ₃	61
Na	23	SO ₄	48
Cl	35.4	NO ₃ -N	14

Common conversion units pertaining to water quality

10 ppm Nitrate – Nitrogen	= 27 lb/ac-ft of water = 2.25 lb/ac-in of water
---------------------------	--

652.1602 Metric conversion units

Where metric units are used in this guide, they generally are presented in SI Units (International System of Units); however, other more common units may be used for ease of use, display, or conversion. Exhibit 16-2 displays commonly used conversion factors relating to irrigation.

Basic SI units are:

unit	metric unit	SI unit designation
length	meter	m
mass	kilogram	kg
time	second	s
time	hour	hr
time	day	d
temperature	degree Celsius	°C
pressure	Pascals	Pa

Exhibit 16-2 Units of area, length, weight, volume, pressure, flow, velocity, temperature, yields, and rates

Area							
Units	m ²	ha	km ²	in ²	ft ²	acre	
1 square meter	= 1	.0001	—	1550	10.764	—	
1 hectare	= 10,000	1	.01	—	1.1 x 10 ⁵	2.4711	
1 square kilometer	= 1.0 x 10 ⁶	100	1	—	1.1 x 10 ⁷	247.1	
1 square foot	= .0929	9.3 x 10 ⁻⁶	—	144	1	—	
1 acre	= 2.6 x 10 ⁶	.4047	.0040	—	43,560	1	
1 square mile	= —	—	2.6	—	—	—	

Length							
Units	mm	cm	m	km	in	ft	mi
1 millimeter	= 1	.1	.001	—	.0394	.033	—
1 centimeter	= 10	1	.01	—	.3937	.0328	—
1 meter	= 1000	10	1	.001	39.37	3.2808	—
1 kilometer	= —	—	1000	1	—	3280.8	.6214
1 inch	= 25.40	2.54	.0254	—	1	—	—
1 foot	= 304.8	30.48	.3048	—	12	1	—
1 mile	= —	—	1609.3	1.6093	—	5280	1
1 yard	= —	—	.9	—	—	—	—

Exhibit 16-2 Units of area, length, weight, volume, pressure, flow, velocity, temperature, yields, and rates—Continued**Weight**

Units		mg	g	kg	met ton	lb	ton
1 milligram	=	1	.001	—	—	—	—
1 gram	=	1000	1	.001	—	—	—
1 kilogram	=	—	1,000	1	.001	2.2046	—
1 metric ton	=	—	—	1,000	1	2,204.6	1.102
1 pound	=	—	453.6	.4536	—	1	.0005
1 ton	=	—	—	907.18	.9072	2,000	1

Volume

Units		L	m ³	qt	gal	ft ³
1 liter	=	1	.001	.9081	.2270	.0358
1 cubic meter	=	1,000	1	—	264.2	35.31
1 quart	=	1.1012	—	1	.25	.0389
1 gallon	=	3.785	—	4	1	.1337
1 cubic foot	=	28.316	.02832	25.714	7.48	1
1 acre foot	=	—	1233	—	—	43,560
1 cubic yard	=	—	.80	—	—	—

Flow

Units		L/s	m ³ /s	gpm	ft ³ /s	ac-ft/d	mg/d
1 liter per second	=	1	.001	15.85	.03531	.004419	—
1 cubic meter per second	=	1,000	1	15,850	35.31	70.04	22.82
1 gallon per minute	=	.0631	—	1	—	—	—
1 cubic foot per second	=	28.32	.02832	448.8	1	1.983	.6463
1 acre-foot per day	=	14.28	.01428	226.3	.5042	1	.3259
1 million gallons per day	=	43.81	.04381	694.4	1.547	3.069	1

Exhibit 16-2 Units of area, length, weight, volume, pressure, flow, velocity, temperature, yields, and rates—Continued**Velocity**

Units		m/s	km/h	ft/s	mph
1 meter per second	=	1	3.6	3.281	2.237
1 kilometer per hour	=	.2778	1	.9113	.6214
1 foot per second	=	.3048	1.097	1	.6818
1 mile per hour	=	.447	1.609	1.467	1

Yield and rate

Units		kg/ha	met ton/ha	lb/ac	L/ha	gal/ac
1 kilogram per hectare	=	1	—	.893	—	—
1 metric ton per hectare	=	—	1	893	—	—
1 pound per acre	=	1.12	.00112	1	—	—
1 liter per hectare	=	—	—	—	1	.107
1 gallon per acre	=	—	—	—	9.35	—

Pressure conversions

1 atmosphere (1 bar)	=	100	kilopascal (kPa)	
1 foot of water (ft)	=	2.9890	"	
1 meter of water (m)	=	9.8064	"	
1 millibar	=	0.100	"	
1 pound per square foot (lb/ft ²)	=	.04788	"	= 47.8 Pascals
1 pound per square inch (lb/in ²)	=	6.8948	"	

Exhibit 16-2 Units of area, length, weight, volume, pressure, flow, velocity, temperature, yields, and rates—Continued

Temperature			
°C	°F	°F	°C
-10	14	32	0
-5	23	34	1.1
0	32	36	2.2
		38	3.3
2	36	40	4.4
4	39		
6	43	42	5.6
8	46	44	6.7
10	50	46	7.8
		48	8.9
12	54	50	10.0
14	57		
16	61	52	11.1
18	64	54	12.2
20	68	56	13.3
		58	14.4
22	72	60	15.6
24	75		
26	79	62	16.7
28	82	64	17.8
30	86	66	18.9
		68	20.0
32	90	70	21.1
34	93		
36	97	72	22.2
37	98.6	74	23.3
38	100	76	24.4
40	104	78	25.6
		80	26.7
45	113		
50	122		
55	131	82	27.8
60	140	84	28.9
65	149	86	30.0
70	158	88	31.1
		90	32.2
75	167		
80	176		
85	185	92	33.3
90	194	94	34.4
95	203	96	35.6
100	212	98	36.7
		100	37.8

Advance time	<ol style="list-style-type: none">(1) Time required for a given surface irrigation stream of water to move from the upper end of a field to the lower end.(2) Time required for a given surface irrigation stream to move from one point in the field to another.
Algicide	Any substance that will kill or control algae growth.
Alkali soil	See sodic soil.
Allowable depletion	That part of soil moisture stored in the plant root zone managed for use by plants, usually expressed as equivalent depth of water in acre inches per acre, or inches.
Alternate set irrigation	A method of managing irrigation whereby, at every other irrigation, alternate furrows are irrigated or sprinklers are placed midway between their locations during the previous irrigation.
Application efficiency (E_a)	The ratio of the average depth of irrigation water infiltrated and stored in the root zone to the average depth of irrigation water applied, expressed as a percentage. Also referred to as AE.
Application efficiency low half (E_h)	The ratio of the average of the low one-half of measurements of irrigation water infiltrated and stored in the root zone to the average depth of irrigation water applied, expressed as a percentage. Also called AELH. Used as an indication for uniformity of application.
Application efficiency low quarter (E_q)	The ratio of the average of the lowest one-fourth of measurements of irrigation water infiltrated to the average depth of irrigation water applied, expressed as a percentage. Also called AELQ. Used as an indication for uniformity of application.
Application rate, sprinkler application rate	The rate at which water is applied to a given area by a sprinkler system. Usually expressed in inches per hour.
Application time, set time	The amount of time that water is applied to an irrigation set.
Arid climate	Climate characterized by low rainfall and high evaporation potential. A region is usually considered as arid when precipitation averages less than 10 inches (250 mm) per year.
Available soil water	The difference between actual water content of a soil and the water held by that soil at the permanent wilting point.
Available water capacity (AWC)	The portion of water in a soil that can be readily absorbed by plant roots of most crops, expressed in inches per inch, inches per foot, or total inches for a specific soil depth. It is the amount of water stored in the soil between field capacity (FC) and permanent wilting point (WP). It is typically adjusted for salinity (electrical conductivity) and rock fragment content. Also called available water holding capacity (AWHC).

Average annual precipitation	The long-term or historic (generally 30 years or more) arithmetic mean of precipitation (rain, snow, dew) received by an area.
Average daily peak use rate	Calculated or measured water used by plants in 1 day through evapotranspiration, expressed as inches per day.
Backflow prevention device	Safety device that prevents the flow of water from the water distribution system back to the water source.
Basic intake rate	Rate at which water percolates into soil after infiltration has decreased to a nearly constant value.
Basin irrigation	Surface irrigation by flooding areas of level land surrounded by dikes. Generally used interchangeably with level border irrigation. In some areas level borders have tailwater runoff. If used in high rainfall areas, storm runoff facilities are necessary.
Blaney-Criddle Method	An air temperature based method to estimate crop evapotranspiration.
Border irrigation	Surface irrigation by flooding strips of land, rectangular in shape, usually level perpendicular to the irrigation slope, surrounded by dikes. Water is applied at a rate sufficient to move it down the strip in a uniform sheet. Border strips having no down field slope are referred to as level border systems. Border systems constructed on terraced lands are commonly referred to as benched borders.
Broad-crested weir	Any of a group of thick-crested overspill weirs used for flow measurements in open channels. Some broad-crested weirs may have flow transitions, roundings, or plane surface ramps on the upstream side. Thin versions without transitions approach the behavior of sharp-crested weirs. Thick versions with transitions approach the behavior of long-throated flumes. Broad-crested weirs typically operate with very little head loss.
Bubbler irrigation	Micro irrigation application of water to flood the soil surface using a small stream or fountain. The discharge rates for point-source bubbler emitters are greater than for drip or subsurface emitters, but generally less than 1 gallon per minute (225 L/h). A small basin is usually required to contain or control the water.
Bulk density	Mass of dry soil per unit volume, determined by drying to constant weight at 105 °C, usually expressed as gm/cc or lb/ft ³ . Rock fragments 2 mm or larger are usually excluded or corrected for after measurement.
Cablegation	A semiautomatic furrow irrigation system where a gated pipe is used to deliver water to each furrow. A continuous moving plug is attached to a speed control device with a small cable. The moving plug allows flow out of newly passed gates. As the plug moves downstream, the water level drops in upstream gates thereby shutting off flows.

Capillary water	Water held in the capillary, or small pores of the soil, usually with soil water pressure (tension) greater than 1/3 bar. Capillary water can move in any direction.
Carryover soil moisture	Moisture stored in the soil within the root zone during the winter, at times when the crop is dormant, or before the crop is planted. This moisture is available to help meet water needs of the next crop to be grown.
Cation exchange capacity (CEC)	The sum of exchangeable cations (usually Ca, Mg, K, Na, Al, H) that the soil constituent or other material can adsorb at a specific pH, usually expressed in centimoles of charge per Kg of exchanger (cmol/Kg), or milli equivalents per 100 grams of soil at neutrality (pH = 7.0), meq/100g.
Check, check structure	Structure to control water depth in a canal, lateral, ditch, or irrigated field.
Chemigation	Application of chemicals to crops through an irrigation system by mixing them with irrigation water.
Christiansen's uniformity coefficient (CU)	A measure of the uniformity of irrigation water application. The average depth of irrigation water infiltrated minus the average absolute deviation from this depth, all divided by the average depth infiltrated. Also called coefficient of uniformity. Typically used with sprinkle irrigation systems.
Cipolletti weir	A sharp-crested trapezoidal weir with sides inclining outwardly at a slope of 1 horizontal to 4 vertical.
Compensating emitter	Micro irrigation system emitters designed to discharge water at a near constant rate over a wide range of lateral line pressures.
Consumptive use	See Evapotranspiration and Crop evapotranspiration.
Continuous flushing emitter	Micro irrigation system emitters designed to continuously permit passage of large solid particles while operating at a trickle or drip flow, thus reducing filtration requirements.
Contracted weir	A measuring weir that is shorter than the width of the channel and is therefore said to have side or end contractions. Sometimes called a sharp-crested weir.
Control structure	Water regulating structure, usually for open channel flow conditions.
Conveyance efficiency (Ec)	The ratio of the water delivered to the total water diverted or pumped into an open channel or pipeline at the upstream end, expressed as a percentage.
Conveyance loss	Loss of water from a channel or pipe during transport, including losses resulting from seepage, leakage, evaporation, and transpiration by plants growing in or near the channel.

Corrugation irrigation	A surface irrigation system where small ditches, channels, or furrows are used to guide water downslope. Can be used in combination with graded border systems to provide more uniform flow down the border strip.
Crop coefficient (K_c)	A factor used to modify potential evapotranspiration: <ol style="list-style-type: none"> (1) Ratio between crop evapotranspiration (ET_c) and the reference crop (ET_o) when crop is grown in large fields under optimum growing conditions, or $ET_c = K_c$ times ET_o. (2) The ratio of the actual crop evapotranspiration to its potential evapotranspiration.
Crop evapotranspiration (ET_c)	The amount of water used by the crop in transpiration and building of plant tissue, and that evaporated from adjacent soil or intercepted by plant foliage. It is expressed as depth in inches or as volume in acre inches per acre. It can be daily, peak, design, monthly, or seasonal. Sometimes referred to as consumptive use (CU).
Crop growth stages	Periods of like plant function during the growing season. Usually four or more periods are identified: <p>Initial—Between planting or when growth begins and approximately 10 percent ground cover.</p> <p>Crop development—Between about 10 percent ground cover and 70 or 80 percent ground cover.</p> <p>Mid season—From 70 or 80 percent ground cover to beginning of maturity.</p> <p>Late—From beginning of maturity to harvest.</p>
Crop rooting depth	Crop rooting depth is typically taken as the soil depth containing 80 percent of plant roots, measured in feet or inches.
Crop water stress index (CWSI)	An index of moisture in a plant compared to a fully watered plant, measured and calculated by a CWSI instrument. Relative humidity, solar radiation, ambient air temperature, and plant canopy temperature are measured. Improperly called an infrared thermometer (plant canopy temperature is measured by infrared aerial photography).
Crop water use	Calculated or measured water used by plants, expressed in inches per day. Same as ET_c except it is expressed as daily use only.
Cumulative intake	The depth of water absorbed by soil from the time of initial water application to the specified elapsed time.
Cutback irrigation	The reduction of the furrow or border inflow stream after water has advanced partly or completely through the field to reduce runoff and improve uniformity of application.
Cutback stream	Reducing surface irrigation inflow stream size (usually a half or a third) when a specified time period has elapsed or when water has advanced a designated distance down the furrow, corrugation, or border.

Cutthroat flume	Open-channel waterflow measuring device that is part of a group of short-throated flumes that control discharge by achieving critical flow with curving streamlines through contraction. The flume is rectangular in cross section, has two main parts resembling a Parshall Flume with the contracted throat removed or cut out (hence its name), and has a flat floor throughout. Calibrations depend on laboratory ratings.
Cycle time	The length of water application periods, typically used with surge irrigation.
Deep percolation (DP)	Water that moves downward through the soil profile below the plant root zone and is not available for plant use. A major source of ground water pollution in some areas.
Deficit irrigation	An irrigation water management alternative where the soil in the plant root zone is not refilled to field capacity in all or part of the field.
Delivery box	Water control structure for diverting water from a canal to a farm unit often including a measuring device. Also called delivery site, delivery facility, and turnout.
Demand irrigation delivery	Irrigation water delivery procedure where each irrigator may request irrigation water in the amount needed and at the time desired.
Depth of irrigation	(1) Depth of water applied, measured in acre inches per acre. (2) Depth of soil affected by an irrigation event.
Distribution uniformity (DU)	The measure of the uniformity of irrigation water distribution over a field. NRCS typically uses DU of low one-quarter. DU of low one-quarter is the ratio of the average of the lowest one-fourth of measurements of irrigation water infiltrated to the average depth of irrigation water infiltrated, expressed as a decimal. Each value measured represents an equal area.
Distribution system	A network of open canals or pipelines to distribute irrigation water at a specific design rate to multiple outlets on a farm or in a community.
Drip irrigation	A micro irrigation application system wherein water is applied to the soil surface as drops or small streams through emitters. Discharge rates are generally less than 2 gallons per hour (8 L/h) for single outlet emitters and 3 gallons per hour (12 L/h) per meter for line source emitters.
Effective precipitation (P_e)	The portion of precipitation that is available to meet crop evapotranspiration. It does not include precipitation that is lost to runoff, deep percolation, or evaporation before the crop can use it.
Effective rooting depth	The depth from which roots extract water. The effective rooting depth is generally the depth from which the crop is currently capable of extracting soil water. However, it may also be expressed as the depth from which the crop can extract water when mature or the depth from which a future crop can extract soil water. Maximum effective root depth depends on the rooting capability of the plant, soil profile characteristics, and moisture levels in the soil profile.

- Electrical conductivity (EC)** A measure of the ability of the soil water to transfer an electrical charge. Used as an indicator for the estimation of salt concentration, measured in mmhos/cm (dS/m), at 77 °F (25 °C).
 EC_e = Electrical conductivity of soil water extract.
 EC_i = Electrical conductivity of irrigation water.
 ECa_w = Electrical conductivity of applied water.
- Electrical resistance blocks** A block made up of various material containing electrical contact wires that is placed in the soils at selected depths to measure soil moisture content. Electrical resistance, as affected by moisture in the block, is read with a meter.
- Emitter** A small micro irrigation dispensing device designed to dissipate pressure and discharge a small uniform flow or trickle of water at a constant discharge. Also called a dripper or trickler.
Compensating emitter—Designed to discharge water at a constant rate over a wide range of lateral line pressures.
Continuous flushing emitter—Designed to continuously permit passage of small solid particles while operating at a trickle or drip flow, thus reducing filter fineness requirements.
Flushing emitter—Designed to have a flushing flow of water to clear the discharge opening every time the system is turned on.
Line-source emitter—Water is discharged from closely spaced perforations, emitters, or a porous wall along the tubing.
Long-path emitter—Employs a long capillary sized tube or channel to dissipate pressure.
Multi-outlet emitter—Supplies water to two or more points through small diameter auxiliary tubing.
Orifice emitter—Employs a series of orifices to dissipate pressure.
Vortex emitter—Employs a vortex effect to dissipate pressure.
- Energy gradient, energy grade line** A plotted line relating total energy elevations along an open channel or conduit, typically a pressure pipeline. (See Hydraulic grade line).
- Environmental control** Controlling air temperature and humidity or soil moisture conditions to minimize effects of low and high air temperatures on crop quality and quantity.
- Evaporation** The physical process by which a liquid is transformed to the gaseous state, which in irrigation generally is restricted to the change of water from liquid to vapor. Occurs from plant leaf surface, ground surface, water surface, and sprinkler spray.
- Evaporation Pan** (1) A standard U.S. Weather Bureau Class A pan (48-inch diameter by 10-inch deep) used to estimate the reference crop evapotranspiration rate. Water levels are measured daily in the pan to determine the amount of evaporation.
(2) A pan or container placed at or about crop canopy height containing water. Water evaporated from the device is measured and adjusted by a coefficient to represent estimated crop water use during the period.

Evapotranspiration (ET)	The combination of water transpired from vegetation and evaporated from soil and plant surfaces. Sometimes called consumptive use (CU).
Exchange capacity	The total ionic charge of the absorption complex active in the adsorption of ions. See Cation exchange capacity (CEC).
Exchangeable cation	A positively charged ion held on or near the surface of a solid particle by a negative surface charge of a colloid and which may be replaced by other positively charged ions in the soil solution.
Exchangeable sodium percentage (ESP)	The fraction of cation exchange capacity of a soil occupied by sodium ions, expressed as a percentage. Exchangeable sodium (meq/100 gram soil) divided by CEC (meq/100 gram soil) times 100. It is unreliable in soil containing soluble sodium silicate minerals or large amounts of sodium chloride.
Exchangeable sodium ratio (or percentage)	The ratio of exchangeable sodium to all other exchangeable cations, expressed as meq/100 grams of soil or as a percentage.
FAO Blaney-Criddle Method	A method to calculate grass reference crop evapotranspiration (ET _c) based on long-term air temperature data, estimates for humidity, wind movement and sunshine duration, and a correction to ET _c downward for elevations above 1,000 meters above sea level.
Feel and appearance method	A method to estimate soil moisture by observing and feeling a soil sample with the hand and fingers. With experience, this method can be accurate.
Field application duration (irrigation period)	The elapsed time from the beginning of water application to the first irrigation set to the time at which water application is terminated on the last irrigation set of a field.
Field capacity	The amount of water retained by a soil after it has been saturated and has drained freely by gravity. Can be expressed as inches, inches per inch, bars suction, or percent of total available water.
Field slope, grade	The terms field slope and grade are interchangeable. Surface irrigation designers typically refer to elevation differences in the direction of water movement as the irrigation grade. Cross slope refers to the land grade perpendicular to the direction of irrigation.
Final infiltration rate	See Basic intake rate.
Float valve	A valve, actuated by a float, that automatically controls the flow of water.
Flood irrigation, wild flooding	A surface irrigation system where water is applied to the soil surface without flow controls, such as furrows, borders (including dikes), or corrugations.
Flume	<ol style="list-style-type: none"> (1) Open conduit for conveying water across obstructions. (2) An entire canal or lateral elevated above natural ground, or an aqueduct. (3) A specially calibrated structure for measuring open channel flows.

Flushing emitter	A micro irrigation application device designed to have a flushing flow of water to clear the discharge opening each time the system is turned on.
Foot valve	(1) A check valve used on the bottom of the suction pipe to retain the water in the pump when it is not in operation. (2) A valve used to prevent backflow.
Free drainage	Movement of water by gravitational forces through and below the plant root zone. This water is unavailable for plant use except while passing through the soil. (See Deep percolation.)
Frost protection	Applying irrigation water to affect air temperature, humidity, and dew point to protect plant tissue from freezing. The primary source of heat (called heat of fusion) occurs when water turns to ice, thus protecting sensitive plant tissue. Wind machines and heating devices are also used.
Full irrigation	Management of water applications to fully replace water used by plants over an entire field.
Fungicide	Chemical pesticide that kills fungi or prevents them from causing diseases on plants.
Furrow	(1) A trench or channel in the soil made by a tillage tool. (2) Small channel for conveying irrigation water downslope across the field. Sometimes referred to as a rill or corrugation.
Furrow dike	Small earth dike formed in a furrow to prevent water translocation. Typically used with LEPA and LPIC systems. Also used in nonirrigated fields to capture and infiltrate precipitation. Sometimes called reservoir tillage.
Furrow irrigation	A surface irrigation system where water is supplied to small channels or furrows to guide water downslope and prevent cross flow. Called rill or corrugation irrigation in some areas.
Furrow stream	The streamflow in a furrow, corrugation, or rill.
Gate, slide gate	A device used to control the flow of water to, from, or in a pipeline or open channel. It may be opened and closed by screw or slide action either manually or by electric, hydraulic, or pneumatic actuators. In open channels, gates slide on rails and are used to control drainage or irrigation water.
Gated pipe	Portable pipe that has small gates installed at regular intervals along one side for distributing irrigation water to corrugations, furrows, or borders.
Gravimetric (ovendry) method	A method of measuring total soil water content by sampling, weighing, and drying in a oven at 105 °C. Percent water, usually on a dry weight basis, is calculated.
Gravitational water	Soil water that moves into, through, or out of the soil under the influence of gravity.

Gross irrigation	Water actually applied, which may or may not be total irrigation water requirement; i.e., leaving storage in the soil for anticipated rainfall, harvest.
Gross irrigation requirement (Fg)	The total irrigation requirement including net crop requirement plus any losses incurred in distributing and applying water and in operating the system. It is generally expressed as depth of water in acre inches per acre or inches
Gross irrigation system capacity	Ability of an irrigation system to deliver the net required rate and volume of water necessary to meet crop water needs plus any losses during the application process. Crop water needs can include soil moisture storage for later plant use, leaching of toxic elements from the soil, air temperature modification, crop quality, and other plant needs.
Ground water	Water occurring in the zone of saturation in an aquifer or soil.
Growing season	The period, often the frost-free period, during which the climate is such that crops can be produced.
Gypsum block	An electrical resistance block in which the material used to absorb water is gypsum. It is used to measure soil water content in non-saline soils.
Head ditch	Ditch across the upper end of a field used for distributing water in surface irrigation.
Head gate	Water control structure at the entrance to a conduit or canal.
Herbicide	A chemical substance designed to kill or inhibit the growth of plants, especially weeds. Types include: Contact —A herbicide designed to kill foliage on contact. Non-selective —A herbicide that destroys or prevents all plant growth. Post-emergence —A herbicide designed to be applied after a crop is above the ground. Pre-emergence —A herbicide designed to be applied before the crop emerges through the soil surface. Selective —A herbicide that targets specific plants.
Humid climates	Climate characterized by high rainfall and low evaporation potential. A region generally is considered as humid when precipitation averages more than 40 inches (1,000 mm) per year.
Hydrant	An outlet, usually portable, used for connecting surface irrigation pipe to an alfalfa valve outlet.
Hydraulic conductivity	The ability of a soil to transmit water flow through it by a unit hydraulic gradient. It is the coefficient k in Darcy's Law. Darcy's Law is used to express flux density (volume of water flowing through a unit cross-sectional area per unit of time). It is usually expressed in length per time (velocity) units, i.e., cm/s, ft/d. In Darcy's Law, where $V = ki$, k is established for a gradient of one. Sometimes called permeability.

Hydraulic grade line (HGL)	A plotted line relating operational energy elevations along an open channel or closed conduit. With open channel (non-pressure) flow, the HGL is at the water surface. The HGL is the elevation water would rise in an open stand at a given location along a pressure pipeline. (See Energy grade line).
Hydraulic ram	Device that uses the energy of flowing water to lift a portion of the flow to a higher elevation or greater pressure.
Infiltration, infiltration rate	The downward flow of water into the soil at the air-soil interface. Water enters the soil through pores, cracks, wormholes, decayed-root holes, and cavities introduced by tillage. The rate at which water enters soil is called intake rate or infiltration rate.
Infiltrometer	<p>A device for determining the intake rate of soil.</p> <p>Ring infiltrometer—Consists of metal rings that are inserted (driven) into the soil surface and filled with water. The rate at which water enters the soil is recorded.</p> <p>Sprinkler infiltrometer—Consists of a sprinkler head(s) that applies water to the soil surface at a range of rates of less-than to greater-than soil infiltration rates. Maximum infiltration rates are observed and recorded.</p> <p>Flowing infiltrometer—Consists of an inlet device to apply a specific flow rate to a furrow and a collection sump with a pump to return tail water to the inlet device. Water infiltrated by the soil in the test section (typically 10 meters) is replaced with water from a reservoir to keep the flow rate constant. The rate of water infiltrated versus time is observed and plotted. Accumulated infiltration versus time is also plotted. An equation (typically for a curvilinear line) then represents the intake characteristics for that particular soil condition.</p>
Initial intake	Depth of water absorbed by a soil during the period of rapid or comparatively rapid intake following initial application. Expressed in inches per hour.
Instantaneous application rate	The maximum rate, usually localized, that a sprinkler application device applies water to the soil, expressed in inches per hour. Instantaneous application rates of over 30 inches per hour have been measured near the ends of low pressure center pivot irrigation laterals.
Intake family curve, intake characteristic curve	A set of accumulated intake versus time curves grouped into families having similar border or furrow intake characteristics. Intake family curves are unitless and do not represent the average infiltration rate. The infiltration process in borders differs from that in furrows, thus each irrigation system has a different set of intake family curves.
Intake family	A grouping of intake characteristics into families based on field infiltrometer tests on many soils. Used to analyze and design border and furrow irrigation systems.
Intake rate	The rate at which irrigation water enters the soil at the surface. Expressed as inches per hour. (See infiltration.)

Interception	That part of precipitation or sprinkler irrigation system applied water caught on the vegetation and prevented from reaching the soil surface.
Inverted siphon	A closed conduit with end sections above the middle section; used for crossing under a depression, under a highway or other obstruction. Sometimes called sag pipe.
Irrecoverable water loss	Water loss that becomes unavailable for reuse through evaporation, phreatophyte transpiration, or ground-water recharge that is not economically recoverable.
Irrigable area	Area capable of being irrigated, principally based on availability of water, suitable soils, and topography of land.
Irrigating stream	<ol style="list-style-type: none"> (1) Flow for irrigation of a particular tract of land. (2) Flow of water distributed at a single irrigation. Sometimes called irrigating head, normally expressed as a rate or volume.
Irrigation	Applying water to the land for growing crops, reclaiming soils, temperature modification, improving crop quality, or other such uses.
Irrigation check	<ol style="list-style-type: none"> (1) Small dike or dam used in the furrow or alongside an irrigation border to make the water spread evenly across the border. (2) A plastic or canvas tarp dam placed in a field ditch to raise the water level in the ditch for diversion onto a field.
Irrigation company	A semi-public, private group, or commercial enterprise set up to deliver irrigation water.
Irrigation district, company	A cooperative, self-governing semipublic organization set up as a subdivision of a state or local government to deliver irrigation water.
Irrigation efficiency (Ei)	The ratio of the average depth of irrigation water beneficially used to the average depth applied, expressed as a percentage. Beneficial uses include satisfying the soil water deficit, leaching requirement for salinity control, and meeting other plant needs. Generally used to express overall field or farm efficiency, or seasonal irrigation efficiency.
Irrigation frequency, interval	The time, generally in days, between irrigation events. Usually considered the maximum allowable time between irrigation's during the peak ET period.
Irrigation method	One of four irrigation methods used to apply irrigation water: surface, sprinkle, micro, and subirrigation. One or more irrigation systems can be used to apply water by each irrigation method.
Irrigation scheduling	Determining when to irrigate and how much water to apply, based upon measurements or estimates of soil moisture or crop water used by the plant.

Irrigation set	The area irrigated at one time within a field.
Irrigation set time, irrigation period	The amount of time required to apply a specific amount of water during one irrigation to a given area, typically refilling the plant root zone to field capacity minus expected rainfall.
Irrigation slope	Elevation difference along the direction of irrigation expressed as, a percentage (feet per 100 feet) or foot per foot. Sometimes called irrigation grade.
Irrigation system	Physical components (pumps, pipelines, valves, nozzles, ditches, gates, siphon tubes, turnout structures) and management used to apply irrigation water by an irrigation method. All properly designed and managed irrigation systems have the potential to uniformly apply water across a field.
Irrigation water management (IWM)	Managing water resources (precipitation, applied irrigation water, humidity) to optimize water use by the plant. Soil and plant resources must also be considered.
Irrigation water requirement	The calculated amount of water needed to replace soil water used by the crop (soil water deficit), for leaching undesirable elements through and below the plant root zone, plus other needs; after considerations are made for effective precipitation.
Julian day, day of year	Sequential numbering of days starting January 1 as day one and continuing until the end of the year, December 31, as day 365 (leap year day 366).
Kinematic wave	A method of mathematical analysis of unsteady open channel flow in which the dynamic terms are omitted because they are small and assumed to be negligible.
Land leveling, land grading, precision land leveling	Shaping the surface of the soil to planned elevations and grades.
Laser controlled leveling or grading	Land leveling or grading in which a stationary laser transmitter and a laser receiving unit mounted on each earthmoving machine are used for automated grade control.
Leaching fraction	The ratio of the depth of subsurface drainage water (deep percolation) to the depth of infiltrated irrigation water. (See Leaching requirement.)
Leaching requirement	<ol style="list-style-type: none"> (1) The amount of irrigation water required to pass through the plant root zone to reduce the salt concentration in the soil for reclamation purposes. (2) The fraction of water from irrigation or rainfall required to pass through the soil to prevent salt accumulation in the plant root zone and sustain production. (See Leaching fraction.)
Leaching	Removal of soluble material from soil or other permeable material by the passage of water through it.

Length of run	The distance down the furrow, corrugation, or border to the planned end of irrigation, typically the edge of the field.
Limited irrigation	Management of irrigation applications to apply less water than needed to satisfy the soil water deficit in the entire root zone. Sometimes called deficit or stress irrigation.
Line-source emitter	Water is discharged from closely spaced perforations, emitters, or a porous wall along a micro irrigation lateral.
Long-path emitter	Employs a long capillary sized tube or channel to dissipate pressure and discharge water in discrete droplets or seeps.
Long throated flume	Open-channel flow measuring devices of various cross-sections, having three to five main sections. Their operation is based on critical flow occurring in a contracted throat, with parallel walls and level floor, that is long enough to produce nearly parallel flow streamlines. This allows accurate calibration by computational methods. The name usually refers to devices with contractions from the channel sides or from both the sides and bottom. Flumes with bottom-only contractions are traditionally referred to as a type of broad-crested weir, but are hydraulically the same as long-throated flumes.
Low energy precision application (LEPA)	A water, soil, and plant management regime where precision down-in-crop applications of water are made on the soil surface at the point of use. Application devices are located in the crop canopy on drop tubes mounted on low pressure center pivot and linear move sprinkler irrigation systems. Generally limited to circular plantings on less than 1 percent slopes and no translocation of applied water. Furrow dikes, good soil condition, and crop residue are usually required to control water translocation.
Low pressure in canopy (LPIC)	A low pressure in-canopy system that may or may not include a complete water, soil, and plant management regime as required in LEPA. Application devices are located in the crop canopy with drop tubes mounted on low pressure center pivot and linear move sprinkler irrigation systems. Limited water translocation within the field and some minor nonuniformity of water application usually exists.
Lysimeter	An isolated block of soil, usually undisturbed and in situ, for measuring the quantity, quality, or rate of water movement through or from the soil.
Management allowed depletion (MAD)	The planned soil moisture deficit at the time of irrigation. It can be expressed as the percentage of available soil water capacity or as the depth of water that has been depleted from the root zone. Sometimes called allowable soil depletion.
Manufacturer's coefficient of variation	A measure of the variability of discharge of a random sample (of a given make, model, and size) of micro irrigation emitters, pressure regulators and sprinkler nozzles, as produced by the manufacturer and before any field operation or aging has taken place. It is equal to the ratio of the standard deviation of the discharge to the mean discharge of the emitters.

Matric potential	Matric potential is a dynamic soil property and will be near zero for a saturated soil. Matric potential results from capillary and adsorption forces. This potential was formerly called capillary potential or capillary water.
Maximum application rate	The maximum discharge, in inches per hour, at which sprinklers can apply water without causing significant translocation.
Microclimate	Atmospheric conditions within or near a crop canopy.
Micro irrigation	The frequent application of small quantities of water as drops, tiny streams, or miniature spray through emitters or applicators placed along a water delivery line. The micro irrigation method encompasses a number of systems or concepts, such as bubbler, drip, trickle, line source, mist, or spray.
Mixed-flow pump	A centrifugal pump in which the pressure is developed partly by centrifugal force and partly by the lifting action of the impellers in the water.
Moisture deficit, soil moisture depletion	The difference between actual soil moisture and soil moisture held in the soil at the field capacity.
Moisture stake	See Tensiometer
Multi-outlet emitter	Supplies water to two or more points through small diameter auxiliary tubing.
Multi-stage pump	A pump having more than one impeller mounted on a single shaft.
Nappe	Sheet or curtain of unsubmerged water flowing from a structure, such as a weir or dam.
Net irrigation	The actual amount of applied irrigation water stored in the soil for plant use or moved through the soil for leaching salts. Also includes water applied for crop quality and temperature modification; i.e., frost control, cooling plant foliage and fruit. Application losses, such as evaporation, runoff, and deep percolation, are not included. Generally measured in inches of water depth applied.
Net irrigation water requirement	The depth of water, exclusive of effective precipitation, stored soil moisture, or ground water, that is required for meeting crop evapotranspiration for crop production and other related uses. Such uses may include water required for leaching, frost protection, cooling, and chemigation.
Net positive suction head (NPSH)	The head that causes liquid to flow through the suction piping and enter the eye of the pump impeller. Required NPSH is a function of the pump design and varies with the capacity and speed of the pump. It must be supplied by the manufacturer. Available NPSH is a function of the system in which the pump operates and represents the energy level in the water over vapor pressure at the pump inlet. The available NPSH must equal or exceed the required NPSH or cavitation occurs.

Nonpoint source pollution (NPS)	Pollution originating from diffuse areas (land surface or atmosphere) having no well-defined source.
Non-saline sodic soil	A soil containing soluble salts that provide an electrical conductivity of the saturation extract (ECe) less than 4.0 mmhos/cm and an exchangeable sodium percentage (ESP) greater than 15. Commonly called black alkali or slick spots.
Nutrient management	Managing the application rate and timing of fertilizers to optimize crop use and reduce potential pollution of ground and surface water.
Neutron gauge, neutron probe, neutron scattering device	A nondestructive method, used primarily by researchers, to measure in situ soil moisture. High speed neutrons are emitted from the radioactive source. Electronic count of the returning slow speed neutrons (or reflected), primarily affected by hydrogen atoms in the soil, is calibrated to represent total soil-water content. When properly calibrated and used, the neutron moisture gauge is probably the most accurate and repeatable method to measure soil moisture. The equipment is expensive, data collection is time consuming, training and licensing for personnel using the gauge and for storage are required.
Operational spills	Planned or emergency spills made along or at the end of an open ditch (lateral) in a community irrigation water delivery system. Planned spills include the discharge of administrative or carry through water carried in laterals, to allow turnouts to be opened and closed without precision management of lateral flow rates. Emergency spill structures include overflow structures to discharge precipitation runoff water that has entered an irrigation water delivery system, and relief gates to discharge irrigation water in case of ditch or structure failure. Typically planned and emergency spill structures discharge water into a natural watercourse or protected channel.
Opportunity time	The time that water inundates the soil surface with opportunity to infiltrate.
Orifice emitter	A micro irrigation system application device employing a series of orifices to dissipate pressure.
Orifice	An opening with a closed perimeter through which water flows. Certain shapes of orifices are calibrated for use in measuring flow rates.
Overhead irrigation	See Sprinkler irrigation.
Pan coefficient	A factor to relate actual evapotranspiration of a crop to the rate water evaporates from a free water surface in a shallow pan. The coefficient usually changes by crop growth stage.

Parshall flume	Open-channel water flow measuring devices which are a part of a group of short-throated flumes that control discharge by achieving critical flow with curving streamlines in a contracted throat section. The sidewalls of the throat section are parallel, but the floor slopes downward in the direction of flow then rises again in a diverging side wall section. Calibrations are based on laboratory ratings. The flume is used for measuring water flow rates with very small total head loss (also see venturi flume). Ten critical edges and surfaces must be met for construction of an accurate Parshall flume
Peak use rate	The maximum rate at which a crop uses water, measured in inches (acre inches per acre) per unit time; i.e., inches per month, inches per week, inches per day.
Peak period ET	The average daily evapotranspiration rate for a crop during the peak water use period. Sometimes commonly called peak period CU (consumptive use).
Penman-Monteith Method	A (radiation and advection) method used to estimate reference crop evapotranspiration (ET _o) using current climatic data including air temperature, relative humidity, wind speed, and solar radiation.
Percolation	Movement of the water through the soil profile. The percolation rate is governed by the permeability or hydraulic conductivity of the soil. Both terms are used to describe the ease with which soil transmits water.
Permanent wilting point (PWP)	The moisture percentage, on a dry weight basis, at which plants can no longer obtain sufficient moisture from the soil to satisfy water requirements. Plants will not fully recover when water is added to the crop root zone once permanent wilting point has been experienced. Classically, 15 atmosphere (15 bars) or 1.5 mPa, soil moisture tension is used to estimate PWP.
Permeability	<ol style="list-style-type: none"> (1) Qualitatively, the ease with which gases, liquids, or plant roots penetrate or pass through a layer of soil (2) Quantitatively, the specific soil property designating the rate at which gases and liquids can flow through the soil or porous media.
Pest management	Management to control undesirable plants, animals, fungi, or bacteria that are troublesome, annoying, or degrading to crop quantity and quality.
Pesticide	Any chemical agent used to control specific organisms. Includes insecticides, herbicides, and fungicides.
Phreatophyte transpiration	Transpiration from water loving vegetation along streams and water bodies, generally considered a loss for irrigation purposes. Phreatophyte vegetation may be a highly valuable food source and habitat for fish and wildlife.

Potential evapotranspiration (ET_o)	The maximum evapotranspiration that will occur when water is not limiting. In some methods of computing evapotranspiration, it is measured as evaporation of water from a free surface. When used as reference crop evapotranspiration, it is for either well watered short grass or alfalfa. Care should be used in determining which factors are used. Preferred term is reference evapotranspiration.
Project efficiency (E_p)	The overall efficiency of irrigation water use in a project setting that accounts for all water uses and losses, such as crop ET, environmental control, salinity control, deep percolation, runoff, ditch and canal leakage, phreato-phyte use, wetlands use, operational spills, and open water evaporation.
Rainfall management	Managing soil, water, and plant resources to optimize use of rainfall
Rectangular weir	Typically a sharp crested weir that is rectangular.
Reference crop evapotranspiration	The evapotranspiration from thick, healthy, well maintained grass (or alfalfa) that does not suffer any water stress. The reference crop is used to represent the water use of a standard crop in that environment even though that crop may not be physically grown in the area. ET _o is generally used when referring to clipped (2 to 5 inches high) grass as the reference crop. ET _r is used for 8- to 12-inch-high, 2-year-old alfalfa.
Relative humidity	The ratio of the amount of water vapor present in the atmosphere to the amount required for saturation at the same dry bulb temperature.
Replogle flume, ramp flume	A modified broad crested weir located in a short flume, lined ditch or pipeline that causes a drop in the hydraulic grade line, for measuring water flow rates. With open channel flow, there is one critical surface, which is level. With closed pipeline flowing full, the same surface can be oriented in any position parallel to the direction of flow. Very little head loss is required to accurately measure water flow rate.
Return-flow facilities, reuse facilities	A system of ditches, pipelines, pump(s), and reservoirs to collect and convey surface or subsurface runoff from an irrigated field for reuse. Sometimes called tailwater reuse facilities or pumpback facilities.
Reverse grade	A slope or grade on a field surface, crop row, or channel that slopes in the direction opposite to the prevalent or desired grade.
Riparian	<ol style="list-style-type: none"> (1) Typically that area of flowing streams that lies between the normal water line and some defined high water line. (2) Pertaining to the banks of a body of water; a riparian owner is one who owns the banks. (3) A riparian water right is the right to use and control water by virtue of ownership of the banks.
Root zone	Depth of soil that plant roots readily penetrate and in which the predominant root activity occurs. Preferred term is plant root zone.

Rotational delivery system	A management technique used for community irrigation water delivery systems in which water deliveries are rotated among water users often at a frequency determined by water supply availability rather than crop water need. This method of managing water deliveries results in some of the lowest on-farm irrigation water application efficiencies.
Row grade	The slope in the direction of crop rows.
Runoff, runoff loss	Surface water leaving a field or farm, resulting from surface irrigation tailwater, applying water with sprinklers at a rate greater than soil infiltration and surface storage, overirrigation, and precipitation.
Saline soil	A non-sodic soil containing sufficient soluble salts to impair its productivity for growing most crops. The electrical conductivity (EC _e) of the saturation extract is greater than 4 mmhos/cm, and exchangeable sodium percentage (ESP) is less than 15; i.e., non-sodic. The principal ions are chloride, sulfate, small amounts of bicarbonate, and occasionally some nitrate. Actually, sensitive plants are affected at half this salinity, and highly tolerant ones at about twice this salinity.
Saline-sodic soil	Soil containing both sufficient soluble salts and exchangeable sodium to interfere with the growth of most crops. The exchangeable sodium percentage (ESP) is greater than or equal to 15, and electrical conductivity of the saturation extract (EC _e) is greater than 4 mmhos/cm. It is difficult to leach because the clay colloids are dispersed.
Salinity	The concentration of dissolved mineral salt in water and soil on a unit volume or weight basis. May be harmful or nonharmful for the intended use of the water.
Satiation	To fill most voids between soil particles with water.
Saturation	To fill all (100%) voids between soil particles with water.
Seepage, seepage loss, leakage	<ol style="list-style-type: none"> 1. Water escaping below or out from water conveyance facilities, such as open ditches, canals, natural channels, and waterways. 2. Water emerging from the ground along an extensive line or surface as contrasted with a spring where the water emerges from a localized spot.
Semiarid climate	Climate characterized as neither entirely arid nor humid, but intermediate between the two conditions. A region is usually considered as semiarid when precipitation averages between 10 inches (250 mm) and 20 inches (500 mm) per year.
SI units, International System of Units	An international metric system developed by General Conference on Weights and Measures, CGPM. This system provides for an established single unit that applies for each physical quantity. Units for all other mechanical quantities are derived from these basic units. See chapter 16 for complete definitions and conversions for English to metric and metric to English units.

Siphon	A closed conduit used to convey water across localized minor elevation raises in grade. It generally has end sections below the middle section. A vacuum pump is commonly used to remove air and keep the siphon primed. The upstream end must be under the water surface. Both ends must be under water, or the lower end must be closed to prime the siphon.
Siphon tube	Relatively short, light-weight, curved tube used to convey water over ditchbanks to irrigate furrows or borders. The tube is typically between 1 and 4 inches in diameter 4 to 6 feet long.
Slide gate	See Gate.
Sodic soil	A non-saline soil containing sufficient exchangeable sodium to affect crop production and soil structure (including soil intake) under most conditions of soil and plant growth. The lower limit of the saturation extract exchangeable sodium percentage (ESP) of such soils is conventionally set at 15.
Sodium adsorption ratio (SAR)	A relation between soluble sodium and soluble divalent cations that can be used to predict the exchangeable sodium percentage of soil equilibrated with a given solution. It is defined as follows: <div style="text-align: center; margin: 10px 0;"> $\text{SAR} = \frac{\text{Na}}{\left(\frac{\text{Ca} + \text{Mg}}{2}\right)^{\frac{1}{2}}}$ </div> <p>where: Na is sodium, Ca is calcium, and Mg is magnesium. Concentrations, denoted by parentheses, are expressed in moles per liter.</p>
Sodium adsorption ratio, adjusted	The sodium adsorption ratio of a water adjusted for the precipitation or dissolution of Ca ²⁺ and Mg ²⁺ that is expected to occur where a water reacts with alkaline earth carbonates within a soil. Numerically, it is obtained by multiplying the sodium adsorption ratio by the value (1 + 8.4 · pH _c [*]), where pH _c is the theoretical calculation of the pH of water in contact with lime and in equilibrium with soil CO ₂ .
Soil aeration	Process by which air and other gases enter the soil or are exchanged.
Soil crusting	Compaction of the soil surface by droplet impact from sprinkle irrigation and precipitation. Well graded, medium textured, low organic matter soils tend to crust more readily than other soils.
Soil compaction	Consolidation, increase in bulk density, reduction in porosity, and collapse of the soil structure when subjected to surface loads or the downward and shearing action of tillage implement surfaces.
Soil condition	The physical condition of the soil related to farmability, tillage, crop growth, root development, water movement, water intake, structure, organic matter content, fertility, and biological activity.
Soil density	Same as Bulk density.

Soil horizon	A layer of soil differing from adjacent genetically related layers in physical, chemical, and biological properties or characteristics.
Soil moisture tension	See Soil water tension.
Soil organic matter	Organic fraction of the soil, including plant and animal residue in various stages of decomposition, cells and tissues of soil organisms, and substances synthesized by the soil population.
Soil profile	Vertical section of the soil from the surface through all its horizons.
Soil sealing	The orientation and consolidation of soil particles in the intermediate surface layer of soil so that it becomes almost impermeable to water.
Soil series	The lowest category of U.S. System of soil taxonomy. A conceptualized class of soil bodies having similar characteristics and arrangement in the soil profile.
Soil structure	The combination or arrangement of primary soil particles into secondary particles, units, or peds that make up the soil mass. These secondary units may be arranged in the soil profile in such a manner as to give a distinctive characteristic pattern. Principal types of soil structure are platy, prismatic, columnar, blocky, granular, and massive.
Soil texture	Classification of soil by the relative proportions of sand, silt, and clay present in the soil. USDA uses 12 textural classes.
Soil water, soil moisture	All water stored in the soil. See Water holding capacity.
Soil-water content	The water content of a given volume of soil. It is determined by: gravimetric sampling and oven drying field samples (to a standard 105 °C), neutron moisture probes, time domain (TDR) and frequency domain reflectrometry (FDR) devices commonly called RF capacitance probes, tensiometers, electrical resistance blocks, thermal dissipation blocks, and feel and appearance methods.
Soil-water deficit or depletion	Amount of water required to raise the soil-water content of the crop root zone to field capacity. It is measured in inches of water.
Soil-water potential	Expresses the potential energy status of soil water relative to conditions associated with pure, free water. Total soil-water potential consists of osmotic potential, gravitational potential, and matric potential. See Soil-water tension and Matric potential.
Soil-water tension	A measure of the tenacity with which water is retained in the soil. It is the force per unit area that must be exerted to remove water from the soil and is usually measured in bars, or atmospheres. It is a measure of the effort required by plant roots to extract water from the soil. Measurements are made using a tensiometer in the field (limited to 1 atmos) and a pressure plate apparatus in the laboratory.

Solar radiation (R_s)	Radiation from the sun that passes through the atmosphere and reaches the combined crop and soil surface. The energy is generally in a waveband width of 0.1 to 5 microns. Net R_s is incoming minus reflected radiation from a surface.
Spile	A conduit made of lath, pipe, or hose placed through ditchbanks to transfer water from an irrigation ditch to a field.
Spray irrigation	The application of water by a small spray or mist to the soil surface where travel through the air becomes instrumental in the distribution of water. (used with sprinkler and micro irrigation methods).
Sprinkler distribution pattern	Water depth-distance relationship measured from a single sprinkler head.
Sprinkler head	A nozzle or device, which may or may not rotate, for distributing water under pressure through the air. Water is delivered to sprinkler heads by a system of pressurized pipelines.
Sprinkle irrigation	Method of irrigation in which water is sprayed or sprinkled through the air to plant or ground surface. See Sprinkler irrigation system.
Sprinkler irrigation system	<p>Facility used to distribute water by the sprinkle irrigation method. Sprinkler systems are defined in the following general categories:</p> <p>Periodic-move system—A system of laterals, sprinkler heads (gun types), or booms that are moved between irrigation settings. They remain stationary while applying water.</p> <p>Fixed/solid-set system—A system of portable surface or permanently buried laterals totally covering the irrigated area or field. Typically several adjacent laterals or heads are operated at one time. Portable laterals are typically removed from the field at end of germination, plant establishment, or the irrigation season and are replaced the next irrigation season.</p> <p>Continuous/self-move system—A lateral, sprinkler (traveler), or boom that is continuous or self moving while water is being applied. Power for moving the facility is typically provided by electric or hydraulic (water) motors or small diesel engines.</p> <p>Specific types of sprinkler systems under each general category include:</p> <p>Boom—An elevated, cantilevered boom with sprinklers mounted on a central stand. The sprinkler-nozzle trajectory back pressure rotates the boom about a central pivot, which is towed across the field by a cable attached to a winch or tractor. Can be either periodic move or continuous move type system.</p> <p>Center pivot—An automated irrigation system consisting of a sprinkler lateral rotating about a pivot point and supported by a number of self-propelled towers. Water is supplied at the pivot point and flows outward through the pipeline supplying the individual sprinklers or spray heads. A continuous/self-move type system.</p> <p>Corner pivot—An additional span or other equipment attached to the end of a center pivot irrigation system that allows the overall radius to increase or decrease in relation to field boundaries.</p>

Gun type—A single sprinkler head with large diameter nozzles, supported on skids or wheels. Periodically moved by hand or mechanically with a tractor, cable, or water supply hose. When the travel lane (or path) has been irrigated, the sprinkler head is relocated at the far end of the next travel lane and irrigation continues.

Lateral move, linear move—An automated irrigation machine consisting of a sprinkler line supported by a number of self-propelled towers. The entire unit moves in a generally straight path perpendicular to the lateral and irrigates a basically rectangular area. A continuous/self move type system.

Linear move—See Lateral move.

Portable handmove—Sprinkler system moved to the next irrigation set by uncoupling and picking up the pipes manually, requiring no special tools. A periodic move type system.

Side-move sprinkler—A sprinkler system with the supply pipe supported on carriages and towing small diameter trailing pipelines each fitted with several sprinkler heads. A periodic move type system.

Side-roll (wheel line) sprinkler—The supply pipe is usually mounted on wheels with the pipe as the axle and where the system is moved across the field by rotating the pipeline by engine power. A periodic move type system.

Solid-set, fixed-set—System that covers the complete field with pipes and sprinklers in such a manner that all of the field can be irrigated without moving any of the system. Laterals may be permanently buried or portable.

Towed sprinkler—System where lateral lines are mounted on wheels, sleds, or skids and are pulled or towed in a direction approximately parallel to the lateral. Rollers or wheels are secured in the ground near the main water supply line to force an offset in the tow path equal to half the distance the lateral would have been moved by hand. A periodic move type system.

Traveler—A single large, gun type sprinkler head with a large diameter nozzle mounted on a unit that is continuously moved across the field by supply hose or cable. The hose reel may be mounted with the sprinkler head on a trailer or on a separate trailer secured at the water supply main line, which is typically located at or near the center of the field. Sometimes called traveling gun or hosepull.

Static head The potential energy resulting from elevation differences. (See Head.)

Stilling well Pipe, chamber, or compartment having closed sides and bottom except for a comparatively small inlet connected to a main body of water. It buffers waves or surges while permitting the water level within the well to rise and fall with major fluctuations of the main water body. Used with water measuring devices to improve accuracy of measurement.

Stress irrigation Management of irrigation water to apply less than enough water to satisfy the soil-water deficiency in the entire root zone. Preferred term is limited irrigation or deficit irrigation.

Subhumid climate	Climate characterized by moderate rainfall and moderate to high evaporation potential. A region is usually considered subhumid when precipitation averages more than 20 inches (500 mm) per year, but less than 40 inches (1,000 mm) per year.
Subirrigation	Applying irrigation water below the ground surface either by raising the water table or by using a buried perforated or porous pipe system that discharges water directly into the plant root zone. Primary source of water for plant growth is provided by capillary rise of soil water above the water table (up flux) or capillary water movement away from the line source.
Surface irrigation	Broad class of irrigation systems in which water is distributed over the soil surface by gravity flow (preferred term is surface irrigation method).
Surge irrigation	A surface irrigation technique wherein flow is applied (typically to furrows or less commonly borders) intermittently during a single irrigation set.
Tailwater runoff	Surface irrigation system water leaving a field or farm from the downstream end of a graded furrow, corrugation, border. Best surface irrigation distribution uniformity across the field is obtained with 30 to 50 percent tailwater runoff, unless tailwater reuse facilities are used.
Tensiometer	Instrument, consisting of a porous cup filled with water and connected to a manometer or vacuum gauge, used for measuring the soil-water matric potential.
Total dissolved solids (TDS)	The total dissolved mineral constituents of water.
Total dynamic head	Head required to pump water from its source to the point of discharge. Equal to the static lift plus friction head losses in pipes and fittings plus velocity head.
Total suction head	Head required to lift water from a water source to the centerline of the pump impeller plus velocity head, entrance losses, and friction losses in suction pipeline.
Translocation	Movement of water to other area(s) than where it was applied.
Transpiration	The process of plant water uptake and use, beginning with absorption through the roots and ending with transpiration at the leaf surfaces. See Evapotranspiration.
Trapezoidal flume	A calibrated open-channel structure with sidewalls inclined to the horizontal, used to measure flow of water. Measurement is based on the principle of critical flow at a critical section.
Trapezoidal weir	A sharp-crested weir of trapezoidal-shape.
Triangular weir	A sharp-crested V-notch weir. Most common is 90 degree V-notch, but it can be any angle.

Trickle irrigation	A micro irrigation system (low pressure and low volume) wherein water is applied to the soil surface as drops or small streams through emitters. Preferred term is Drip irrigation.
Turnout	See Delivery box.
Unavailable soil water	That portion of water in a soil held so tightly by adhesion and other soil forces that it cannot be absorbed by plants rapidly enough to sustain growth without permanent damage. The soil water remaining at the permanent wilting point of plants.
Valve	<p>A device to control flow that includes:</p> <p><i>Pressurized system:</i></p> <p><i>Air relief valve</i>—Device that releases air from a pipeline automatically without permitting loss of water.</p> <p><i>Air vacuum, air relief valve</i>—Device that releases air from a pipeline automatically without permitting loss of water or admits air automatically if the internal pressure becomes less than atmospheric.</p> <p><i>Backflow prevention valve</i>—A check valve that allows flow in one direction. When closed, air is admitted to the low pressure (supply) side to prevent siphoning or backflow of water and chemicals to a water source.</p> <p><i>Ball valve</i>—A valve in a pipeline used to start or stop flow by rotating a sealed ball with a transverse hole approximately equal to the diameter of the pipeline. Ball rotation is typically 90 degrees for single-port control. With hole modifications, several outlets may be controlled. In this case, only partial rotation of the handle may be used. Ball valves should be opened and closed slowly to avoid high surge pressures. Headloss through a ball valve is very low.</p> <p><i>Butterfly valve</i>—A valve in a pipeline to start or stop flow by rotating a disk 90 degrees. The disk is about the same diameter as the pipeline. Butterfly valves should be opened and closed slowly to avoid high surge pressures (water hammer). Headloss through a butterfly valve is low.</p> <p><i>Check valve</i>—Valve used in a pipeline to allow flow in only one direction.</p> <p><i>Drain valve</i>—(a) Automatic has spring-loaded valve that automatically opens and drains the line when the pressure drops to near zero. (b) Flushing type has a valve on the end of a line to flush out dirt and debris. This may be incorporated into an end plug or end cap.</p> <p><i>Float valve</i>—A valve, actuated by a float, that automatically controls the flow of water.</p> <p><i>Gate valve</i>—A valve in a pipeline used to start or stop water flow. May be operated by hand with or without mechanical assistance or by high or low voltage (solenoid) electric controlled mechanical assistance. Gate valves consist of seated slide or gates operating perpendicular to the flow of water. Head loss through a gate valve is typically less than a globe valve, but more than a ball or butterfly valve.</p> <p><i>Globe valve</i>—A valve in a pipeline used to start or stop water flow. Globe valves stop flow by positioning a disk and gasket over a machined seat about the same diameter as the pipe. Globe valves are limited to smaller sizes because of the high velocities and very high head loss through the valve.</p>

Pressure relief valve—A spring loaded valve set to open at a pressure slightly above the operating pressure, used to relieve excessive pressure and surges.

Solenoid valve—A misused term meaning a low voltage electrically controlled, mechanically actuated valve; typically a gate valve. Often a spring is used to hold the valve in a closed (or open) position when water pressure is low or electric energy is discontinued. (When ignition electric energy for an internal combustion engine or electric energy to a motor is discontinued, a spring closes the valve.)

Vacuum relief valve—Valve used to prevent a vacuum in pipelines and avoid collapsing of thin-wall pipe.

Non-pressure or very low pressure system:

Alfalfa valve—An outlet valve attached to the top of a short vertical pipe (riser) with an opening equal in diameter to the inside diameter of the riser pipe and a adjustable lid or cover to control water flow. A ring around the outside of the valve frame provides a seat and seal for a portable hydrant. Typically used in border or basin irrigation.

Orchard valve—An outlet valve installed inside a short vertical pipe (riser) with an adjustable cover or lid for flow control. Similar to an alfalfa valve, but with lower flow capacity. Typically used in basin irrigation.

Surge valve—A device in a pipe T fitting to provide flow in alternate directions at timed intervals. Used in surge irrigation.

Velocity head The energy head (H) created by water movement. The difference in elevation between the hydraulic grade line (HGL) and energy grade line (EGL). Described as $H = V^2/2g$, where $g = 32.2$ ft/s/s (acceleration of gravity).

Venturi flume Flow measuring device with a contracted throat that causes a drop in the hydraulic grade line as well as an increase in velocity. Used for both open-channel and closed pipe flow measurement.

Vortex emitter A micro irrigation water application device that employs a vortex effect to dissipate pressure.

Water amendment (1) Fertilizer, herbicide, insecticide, or other material added to water for the enhancement of crop production.
(2) A chemical water treatment to reduce drip irrigation system emitter clogging.

Water conveyance efficiency Ratio of the volume of irrigation water delivered by a distribution system to the water introduced into the system.

Water holding capacity Total amount of water held in the soil per increment of depth. It is the amount of water held between field capacity (FC) and oven dry moisture level, expressed in inch per inch, inch per foot, or total inches for a specific soil depth. Soils that are not freely drained because they have impermeable layers can have temporary saturated conditions just above the impermeable layers. This can temporarily increase water holding capacity. Sometimes called Total water holding capacity. See Available water capacity.

Water leveling	A method of landgrading wherein fields are divided into segments and flooded, and the highs are removed until all soil is beneath the water surface. Typically used with rice production.
Water rights	State administered legal rights to use water supplies derived from common law, court decisions, or statutory enactments.
Water spreading	Application of water to lands for the purpose of storing it as ground water for subsequent withdrawal, or A specialized form of surface irrigation accomplished by diverting water runoff from natural channels or water courses and spreading the flow over relatively level areas for soil storage or plant use. Typically does not supply full irrigation needs as they operate only when there is surface runoff from rainfall or snow melt events.
Water table control	Controlling the water table elevation by pumping water into or discharging water from a planned subsurface irrigation or drainage system. The water table is maintained at a nearly constant elevation for each stage of plant growth and maturity.
Water table	The upper surface of a saturated zone below the soil surface where the water is at atmospheric pressure.
Weirs	Any of a group of flow measuring devices for open-channel flow. Weirs can be either sharp-crested or broad-crested. Flow opening may be rectangular, triangular, trapezoidal (cipolletti), or specially shaped to make the discharge linear with flow depth (suro weir). Calibration is based on laboratory ratings.
Wilting point	See Permanent wilting point.
Wind movement, daily wind run, wind speed	Used to calculate reference crop evapotranspiration, usually expressed as wind run (average velocity, mph times time in hr/d).

References

- American Association for Vocational Instructional Materials (AAVIM). 1980. Planning for an irrigation system. 2nd edition.
- American Society of Agricultural Engineers. 1990. Management of farm irrigation systems. ASAE Monograph, G.J. Hoffman, T.A. Howell, K.H. Solomon, editors.
- American Society of Agricultural Engineers. 1993-94. Irrigation related definitions of irrigation efficiency and distribution uniformity. Irrigation & Drainage Task Committee.
- American Society of Agricultural Engineers. Design and operation of farm irrigation systems. ASAE Monograph Number 3, M.E. Jensen, editor.
- American Society of Agricultural Engineers. Soil and water engineering terminology. Standard: ASAE S526.
- American Society of Civil Engineers. 1990. Agricultural salinity assessment and management. Manuals & Reports on Engineering Practice, No. 71.
- American Society of Civil Engineers. 1990. Evapotranspiration and irrigation water requirements. Manuals & Reports on Engineering Practice, No. 70.
- Council for Agricultural Science and Technology (CAST). 1988. Effective use of water in irrigated agriculture. Report 113, Ames, IA.
- Council for Agricultural Science and Technology (CAST). 1992. Water quality, agriculture's role. Report 120, Ames, IA.
- Food and Agriculture Organization of the United Nations, Rome. FAO irrigation and drainage papers. Paper 24, Crop Water Requirements; Paper 29, Water Quality for Agriculture; Paper 33, Crop Yield Response to Water; Paper 45, Guidelines for Designing and Evaluating Surface Irrigation Systems.
- Merriam, John L., and Jack Keller. 1978. Farm irrigation system evaluation: A guide for management. Agric. & Irrig. Eng. Dep., Utah State Univ., Logan, UT.
- Soil Conservation Society of America. 1982. Resource conservation glossary. 3rd ed.
- United States Department of Agriculture, Natural Resources Conservation Service. Engineering Field Handbook (EFH).
- United States Department of Agriculture, Natural Resources Conservation Service. National Engineering Handbook (NEH), Part 623 (Section 15), Irrigation, chapters 1-9, 11, 12; Part 634 (Section 5), Hydraulics; Part 624 (Section 16), Drainage; Part 638 (Section 18), Hydrogeology.
- United States Department of Agriculture, Natural Resources Conservation Service. Technical Release TR-21, Irrigation Water Requirements (Rev. Sep. 1970). In NEH, Part 623, Chapter 2, Irrigation Water Requirements.
- United States Department of Interior, Bureau of Reclamation. 1971 (rev. 1995). Water Measurement Manual. 2nd ed.
- University of Nebraska. 1985. Irrigation pumping plant test procedure manual. Agricultural Engineering Department, Ext. Serv., Univ. Nebraska, Lincoln.
- University of Nebraska, Agricultural Engineering Irrigation Group, Paul E. Fishbach (Ed). 1982. Irrigation pumping plant performance handbook. Agricultural Engineering Department, Ext. Serv., Univ. Nebraska, Lincoln.
- Western Area Power Administration Conservation and Renewable Energy Program. 1985. Revised irrigation pumping plant test procedure manual.

United States
Department of
Agriculture

**Natural
Resources
Conservation
Service**

**Part 652
Irrigation Guide**

**Chapter 1
Introduction**

**Chapter 1
Introduction**

United States
Department of
Agriculture

**Natural
Resources
Conservation
Service**

**Part 652
Irrigation Guide**

**Chapter 2
Soils**

**Chapter 2
Soils**

United States
Department of
Agriculture

**Natural
Resources
Conservation
Service**

**Part 652
Irrigation Guide**

**Chapter 3
Crops**

**Chapter 3
Crops**

United States
Department of
Agriculture
**Natural
Resources
Conservation
Service**

**Part 652
Irrigation Guide**

Chapter 4 Water Requirements

Chapter 4 Water Requirements

United States
Department of
Agriculture

**Natural
Resources
Conservation
Service**

**Part 652
Irrigation Guide**

**Chapter 5
Selecting an Irrigation
Method**

**Chapter 5
Selecting an Irriga-
tion Method**

United States
Department of
Agriculture
**Natural
Resources
Conservation
Service**

**Part 652
Irrigation Guide**

**Chapter 6
Irrigation System
Design**

Chapter 6 Irrigation System Design

United States
Department of
Agriculture

**Natural
Resources
Conservation
Service**

**Part 652
Irrigation Guide**

Chapter 7

**Farm Distribution
Components**

**Chapter 7
Farm Distribution
Components**

United States
Department of
Agriculture
**Natural
Resources
Conservation
Service**

Part 652
Irrigation Guide

Chapter 8

Project and Farm Irrigation Water Requirements

**Chapter 8
Project and Farm
Req.**

United States
Department of
Agriculture
**Natural
Resources
Conservation
Service**

**Part 652
Irrigation Guide**

**Chapter 9
Irrigation Water
Management**

**Chapter 9
Irrigation Water
Management**

United States
Department of
Agriculture

**Natural
Resources
Conservation
Service**

**Part 652
Irrigation Guide**

Chapter 10

Ecosystem-Based Management Systems and Irrigation Planning

United States
Department of
Agriculture
**Natural
Resources
Conservation
Service**

Part 652
Irrigation Guide

Chapter 11 Economic Evaluations

United States
Department of
Agriculture
**Natural
Resources
Conservation
Service**

**Part 652
Irrigation Guide**

Chapter 12

Energy Use and Conservation

**Chapter 12
Energy Use and
Conservation**

United States
Department of
Agriculture

**Natural
Resources
Conservation
Service**

**Part 652
Irrigation Guide**

Chapter 13 Quality of Water Supply

**Chapter 13
Quality of Water
Supply**

United States
Department of
Agriculture

**Natural
Resources
Conservation
Service**

**Part 652
Irrigation Guide**

Chapter 14 Environmental Concerns

**Chapter 14
Environmental
Concerns**

United States
Department of
Agriculture

**Natural
Resources
Conservation
Service**

**Part 652
Irrigation Guide**

**Chapter 15
Resource Planning and
Evaluation Tools and
Worksheets**

United States
Department of
Agriculture
**Natural
Resources
Conservation
Service**

**Part 652
Irrigation Guide**

**Chapter 16
Tables and Charts**

Chapter 16 Special Use Tables, Charts, and Conversions

United States
Department of
Agriculture
**Natural
Resources
Conservation
Service**

**Part 652
Irrigation Guide**

Chapter 17 Glossary and References

**Chapter 17
Glossary and
References**

United States
Department of
Agriculture
**Natural
Resources
Conservation
Service**

Part 652 Irrigation Guide

Index

Index

Index

A

Advance curve 9-38, 9-66,
9-67, 9-102
Advance rate 6-1, 6-2, 6-11, 7-7
Allowable depletion 1-4, 3-7,
3-12, 3-24, 4-7, 6-35, 9-2,
9-6, 9-66, 9-132, 9-164
Application depth 9-34, 9-36,
9-38, 9-42, 9-64, 9-65,
9-79, 9-99, 9-116, 9-120,
9-134, 9-136, 9-137, 9-152,
9-154, 9-169, 9-186
Application efficiency 4-4, 6-7,
6-12, 6-13, 6-14, 6-15,
6-20, 6-27, 6-32, 6-33,
6-58, 6-78, 7-11, 7-18,
8-11, 9-26, 9-30, 9-31,
9-32, 9-36, 9-37, 9-65,
9-66, 9-69, 9-79, 9-80,
9-100, 9-101, 9-103, 9-116,
9-130, 9-131, 9-148, 9-149,
9-150, 9-160, 9-161, 9-170,
9-171, 10-6, 11-3, 11-16,
11-18
Application efficiency low half
9-31
Application efficiency low quar-
ter 9-31
Application rate 1-2, 1-4,
2-20, 2-21, 2-22, 2-25,
2-29, 2-38, 3-16, 5-4, 6-1,
6-25, 6-28, 6-29, 6-33,
6-42, 6-45, 6-47, 6-48,
6-49, 6-50, 6-51, 6-54,
6-56, 6-63, 6-79, 7-24,
9-1, 9-41, 9-42, 9-133,
9-137, 9-146, 9-149, 9-152,
9-160, 9-185, 9-186, 9-189,
9-190, 9-203, 9-204, 9-205,
9-227, 10-12, 11-17
Arid climate 4-4, 4-6, 4-13
Automation 1-1, 1-5, 5-7,
5-8, 5-9, 5-10, 5-11, 6-5,
6-7, 6-8, 6-9, 6-14, 6-75,
6-77, 7-2, 7-15, 7-16,
7-33, 8-4, 8-8, 8-9, 9-196,
9-205, 9-214, 9-227, 10-12
Auxiliary water 4-3, 4-7, 4-13,
8-6, 8-10, 9-188, 9-190

Available water capacity 1-4,
2-1, 2-2, 2-3, 2-4, 2-5,
2-6, 2-7, 2-8, 2-10, 2-16,
2-28, 2-34, 2-37, 4-7, 6-6,
6-8, 6-9, 6-11, 6-35, 6-45,
6-50, 6-51, 7-1, 8-1, 8-6,
9-1, 9-2, 9-4, 9-5, 9-6,
9-8, 9-20, 9-26, 9-228,
10-5, 10-27

Axial flow pump 7-6, 7-12

B

Backflow 7-21, 7-25, 7-34
Basin bubbler 3-15, 6-2, 6-59,
6-63, 6-70, 6-74, 6-91, 10-10
Basin irrigation 2-18, 2-39,
3-16, 10-10
Benefit analysis 8-12, 11-2,
11-12, 11-17, 11-27
Big gun type 6-54, 9-42, 10-10
Blaney-Criddle 4-2, 4-4, 4-5,
4-13
Bubbler 3-15, 5-2, 5-5, 5-10,
6-2, 6-59, 6-63, 6-70,
6-74, 6-91, 10-10, 10-12
Bulk density 2-1, 2-4, 2-5,
2-16, 2-23, 2-28, 3-10,
9-4, 9-5, 9-6, 9-10, 9-12,
9-17, 9-18, 9-19

C

Carryover soil moisture 11-17
Catch container 9-33, 9-34,
9-35, 9-41, 9-42, 9-43,
9-119, 9-120, 9-122, 9-134,
9-135, 9-136, 9-137, 9-147,
9-149, 9-152, 9-153, 9-154,
9-160, 9-164, 9-190, 9-203,
9-204, 9-205
Centrifugal pump 6-52, 6-53,
7-12, 9-184
Checkbook method 9-25, 9-26
Chemigation 1-1, 1-2, 4-1,
4-7, 5-2, 6-34, 6-44, 6-50,
6-52, 7-21, 7-22, 7-25,
7-33, 8-18, 9-33, 9-119,
9-223, 11-17
Consumptive use 4-1, 4-3, 9-171

Continuous move 6-43, 6-52,
9-41, 9-42, 9-152, 9-146,
9-147, 9-148, 9-149, 9-150,
9-151, 9-152, 9-155, 9-156,
9-157, 9-158, 9-159, 9-160,
9-161, 9-162, 9-189, 9-190,
9-204, 9-231, 9-232, 10-10
Contour ditch irrigation 5-12,
6-22, 6-23, 6-24, 6-90,
7-4, 9-103, 9-104, 9-106,
9-107, 9-108, 9-109, 9-110,
9-111, 9-112, 9-113, 9-115,
9-116, 9-117, 9-118, 10-10
Contour levee irrigation 5-12,
6-5, 6-7, 6-8, 7-4
Conveyance 1-2, 7-2, 7-3,
7-5, 8-4, 8-7, 8-8, 8-9,
8-10, 8-11, 8-13, 8-17,
8-18, 8-19, 8-20, 8-25, 10-10
Conveyance efficiency 7-5, 9-31
Cost analysis 6-55, 7-17, 8-13,
8-19, 11-4, 11-11, 11-14,
11-27, 11-28
Crop coefficient 4-2
Crop evapotranspiration 1-4,
3-12, 3-13, 3-23, 4-1, 4-2,
4-3, 4-4, 4-5, 4-6, 4-7,
4-8, 4-13, 6-8, 6-31, 6-35,
8-3, 8-6, 8-11, 9-2, 9-19,
9-21, 9-26, 10-6, 10-11,
10-14, 11-17
Crop growth stage 3-7, 3-18,
3-24, 4-2, 9-21
Crop water use 3-14, 3-18,
4-1, 6-1, 6-21, 6-45, 7-1,
9-2, 9-22, 9-23, 9-25,
9-26, 9-28, 10-11
Cumulative intake 2-17, 9-57,
9-60, 9-65, 9-66, 9-77,
9-98, 9-99, 9-102, 9-113,
9-115, 9-229, 9-189, 9-199
Cutback irrigation 6-15, 6-18,
6-20, 9-38
Cycle time 6-12, 9-25
Cylinder infiltrometer 9-45,
9-46, 9-47, 9-57, 9-61,
9-68, 9-69, 9-103, 9-114,
9-188, 9-190, 9-191, 9-192,
9-193, 9-195, 9-196, 9-229,
9-230

- D**
- Deep percolation 1-2, 1-5, 2-17, 3-13, 4-3, 4-4, 4-8, 4-9, 4-10, 5-4, 6-2, 6-5, 6-7, 6-8, 6-9, 6-11, 6-13, 6-14, 6-15, 6-18, 6-25, 6-27, 6-50, 6-65, 6-75, 7-18, 7-19, 7-21, 8-6, 8-10, 8-11, 8-19, 9-25, 9-26, 9-28, 9-31, 9-38, 9-62, 9-64, 9-79, 9-100, 9-102, 9-116, 9-130, 9-148, 9-149, 9-164, 10-10, 10-11, 10-12
 - Deficit irrigation 6-12, 9-3, 7-19
 - Delivery rate 8-5, 8-8, 9-3
 - Delivery schedule 1-4, 4-4, 5-3, 5-7, 5-8, 5-9, 5-10, 5-11, 6-77, 8-5, 8-7, 8-8, 8-25, 9-1, 9-3, 9-4, 9-23, 9-33, 10-6
 - Demand delivery 3-14, 6-75
 - Distribution uniformity 1-5, 3-13, 5-1, 5-4, 6-1, 6-5, 6-6, 6-9, 6-11, 6-13, 6-14, 6-15, 6-18, 6-20, 6-22, 6-29, 6-31, 6-32, 6-35, 6-42, 6-44, 6-45, 6-50, 6-56, 6-58, 6-65, 9-31, 9-32, 9-35, 9-36, 9-38, 9-64, 9-67, 9-69, 9-79, 9-100, 9-103, 9-116, 9-129, 9-133, 9-148, 9-186, 9-199
 - Distribution uniformity low quarter 9-148
 - Drainage system 3-17, 3-18, 6-6, 6-82, 6-83, 7-2, 7-18, 7-19, 7-33, 9-82, 9-83, 9-210, 10-5, 10-7, 10-10
- E**
- Ecosystem 8-13, 8-16
 - Effective precipitation 4-3, 4-4, 4-10, 8-2, 8-6, 8-10, 8-11, 8-17, 9-23, 9-26, 10-12
 - Electrical conductivity 2-9, 2-10, 2-31, 2-32, 2-39, 3-17, 6-68, 9-186, 9-221
 - Electrical resistance 9-16, 9-17, 9-41
 - Emitter device 6-59, 6-61, 6-62, 6-66, 6-74, 6-75, 6-76, 6-91, 9-43, 10-13
 - Emitter plugging 5-4, 9-206
 - Energy conservation 1-4
 - Environmental impact 8-2, 8-8, 8-12, 10-3
 - Erosion control 1-1, 4-7, 6-6, 6-25, 6-89, 7-16, 7-18
 - Evaporation 3-12, 3-13, 3-14, 3-17, 3-18, 4-2, 4-3, 4-4, 4-9, 5-3, 5-4, 6-2, 6-6, 6-7, 6-22, 6-27, 6-45, 6-48, 6-49, 6-50, 6-51, 6-52, 6-65, 7-2, 7-12, 7-18, 8-10, 8-17, 9-6, 9-21, 9-26, 9-31, 9-42, 9-120, 9-122, 9-129, 9-130, 9-135, 9-136, 9-148, 9-149, 9-153, 9-154, 9-163, 9-170, 9-171, 10-11
 - Evaporation pan 4-2, 9-21
 - Evapotranspiration 1-4, 2-1, 3-2, 3-12, 3-13, 3-23, 4-1, 4-2, 4-3, 4-4, 4-5, 4-6, 4-7, 4-8, 4-13, 6-1, 6-8, 6-31, 6-35, 6-75, 6-78, 8-3, 8-6, 8-11, 8-17, 9-2, 9-19, 9-21, 9-26, 9-28, 9-164, 9-170, 10-6, 10-11, 10-14, 11-16, 11-17
 - Exchangeable sodium percentage (ESP) 2-31
- F**
- FAO Blaney-Criddle 4-4, 4-5, 4-13
 - Fertigation 7-21
 - Fertilizer injector 6-77, 6-78, 7-24, 7-34
 - Filters 5-5, 6-65, 6-70, 6-72, 6-73, 6-74, 6-77, 6-83, 6-90, 9-34, 9-173
 - Filtration 6-8, 6-10, 6-11, 6-13, 6-14, 6-15, 6-18, 6-27, 6-48, 6-49, 6-50, 6-51, 6-52, 6-59, 6-62, 6-63, 6-65, 6-70, 6-72, 6-73, 6-74
 - Fixed set irrigation 5-2, 5-4, 5-5, 5-8, 9-122, 9-123, 9-204, 10-10
 - Flow measurement 6-21, 7-7, 7-8, 7-9, 7-10, 9-1, 9-4, 9-83, 9-120, 9-135, 9-206, 9-210, 9-213, 9-214, 9-215, 9-219, 9-220, 9-221, 9-222, 9-228, 10-12, 10-13
 - Flow meter 6-77, 7-10, 9-36, 9-37, 9-120, 9-134, 9-135, 9-147, 9-153, 9-160, 9-174, 9-181, 9-208, 9-209, 9-210, 9-213, 9-214, 9-217, 9-218, 9-219, 9-220, 9-221, 9-222, 9-228
 - Flow regulator 6-34, 6-47, 6-48, 6-77, 9-132
 - Freeze protection 9-21
 - Frost protection 1-1, 3-16, 4-1, 4-7, 5-3, 6-1, 6-42, 8-2, 8-18, 11-17
- G**
- Graded border irrigation 5-5, 6-2, 6-5, 6-8, 7-16, 9-45, 9-65, 9-188, 10-10
 - Graded furrow irrigation 5-5, 6-8, 6-10, 6-11, 6-12, 6-13, 6-14, 6-18, 6-20, 7-16, 9-82, 9-85, 9-188, 10-10
 - Gravitational water 2-7, 2-16, 2-28, 9-47, 9-70, 9-84, 9-104
 - Gross system capacity 4-4
 - Ground water 1-1, 1-5, 2-29, 3-1, 3-2, 3-19, 5-1, 5-3, 6-13, 6-25, 6-45, 6-65, 7-19, 7-20, 8-2, 8-3, 8-6, 8-10, 8-12, 8-17, 8-19, 9-1, 9-23, 9-30, 10-1, 10-10, 10-11
 - Growing period 4-3, 9-2

H

Humid climate 3-1, 3-12,
3-14, 5-7, 5-9, 5-10, 5-12,
6-1, 6-9, 6-48, 6-83, 7-2,
9-96, 9-100

Humidity 3-12, 3-16, 4-1,
4-2, 4-3, 4-8, 5-3, 6-42,
8-10, 8-17, 9-20, 9-21,
9-28, 9-122, 9-130, 9-136,
9-149, 9-153

Hydraulic conductivity 6-81,
6-82, 6-83

Hygroscopic water 2-4

I

Impermeable layers 6-22, 7-19

Infiltration 2-2, 2-17, 2-20,
2-22, 2-28, 3-1, 3-14, 4-9,
5-4, 5-3, 5-7, 5-8, 5-9,
5-10, 5-11, 6-2, 6-3, 6-6,
6-8, 9-39, 9-45, 9-46,
9-47, 9-60, 9-62, 9-69,
9-77, 9-82, 9-84, 9-115,
9-132, 9-137, 9-173, 9-185,
9-186, 9-187, 9-188, 9-189,
9-190, 9-193, 9-196, 9-198,
9-199, 9-202, 9-203, 9-227,
9-230

Infiltrimeters 9-46, 9-47,
9-57, 9-60, 9-103, 9-104,
9-115, 9-188, 9-193, 9-196

Infrared 7-16, 9-10, 9-20,
9-21, 9-23, 9-25, 9-207

Injection 6-67, 6-68, 7-2,
7-21, 7-22, 7-23, 7-24,
7-25, 7-26, 7-27, 7-28,
7-30, 7-34

Intake families 2-18, 2-19,
2-22, 2-39, 9-185, 9-196,
9-197, 9-201, 9-230

Irrigation efficiency 3-13, 5-4,
6-6, 6-7, 6-22, 7-11, 7-15,
8-2, 8-6, 8-10, 8-11, 9-2,
9-31, 9-32, 9-35, 9-66,
9-100, 9-102, 9-227, 10-11

Irrigation frequency 3-12,
3-23, 4-7, 6-33

Irrigation scheduling 1-1, 1-5,
2-9, 3-2, 3-4, 3-12, 3-14,
4-2, 4-9, 6-5, 6-35, 6-50,
6-63, 6-75, 6-77, 6-78,
7-15, 8-4, 8-5, 8-18, 9-1,
9-2, 9-3, 9-4, 9-22, 9-23,
9-24, 9-25, 9-26, 9-27,
9-28, 9-30, 9-65, 9-68,
9-80, 9-81, 9-101, 9-116,
9-131, 9-150, 9-151, 9-161,
9-162, 9-164, 9-205, 9-206,
9-227, 9-229, 10-2, 10-3,
10-12, 10-13, 11-2, 11-14,
11-18

Irrigation season 2-17, 2-25,
4-8, 5-4, 6-18, 6-47, 6-48,
6-51, 6-52, 7-3, 8-11,
8-18, 9-2, 9-30, 9-67,
9-82, 9-163, 9-164, 9-205,
10-12

Irrigation system evaluation
7-12, 9-33, 9-35, 9-36,
9-45, 9-227

Irrigation water management
1-5, 2-11, 2-16, 3-2, 3-12,
3-13, 3-18, 5-4, 6-5, 6-9,
6-35, 7-9, 7-12, 7-15,
7-18, 8-7, 8-8, 9-1, 9-2,
9-3, 9-4, 9-19, 9-21, 9-22,
9-25, 9-30, 9-34, 9-151,
9-162, 9-205, 9-206, 9-217,
9-227, 10-2, 10-10, 10-11,
10-12, 10-13, 10-14,
10-24, 11-1

Irrigation water requirement
1-1, 1-4, 1-5, 2-31, 3-11,
3-12, 3-13, 3-16, 3-17, 3-19,
4-1, 4-2, 4-3, 4-4, 4-7, 4-8,
4-9, 4-13, 8-1, 8-2, 8-4,
8-6, 8-7, 8-10, 8-23, 8-25

L

Lag time 9-67, 9-102

Laser controlled leveling 6-6,
10-13

Leaching requirement 3-18, 4-7

level basin 2-3, 9-193

Level basin irrigation 2-3, 6-2,
6-5, 6-6, 6-7, 7-16, 9-68,
9-79, 9-193, 10-10

Level furrow irrigation 5-5,
6-8, 7-16, 9-37, 10-10

Line-source emitter 5-4, 6-62,
6-74, 9-43

Lined ditches 6-15, 7-5, 7-4,
7-5, 7-33, 9-212

Long-throated flume 9-210,
9-212, 9-213, 9-214, 9-216,
9-217, 9-220, 9-230

Low energy precision application
(LEPA) 5-2, 5-9, 6-27,
6-44, 6-47, 6-48, 6-49, 6-51,
6-52, 9-42, 9-134, 9-189

Lysimeter 4-1

M

Management allowable
Depletion 1-4, 3-7, 3-12,
3-24, 4-7, 6-35, 9-2, 9-6,
9-66, 9-102, 9-132, 9-164

Manifold 6-73, 6-76, 6-77,
9-164, 9-165, 9-170, 9-172,
9-173

Measuring device 6-35, 6-36,
6-66, 6-74, 6-77, 6-78,
6-82, 7-2, 7-5, 7-6, 7-7,
7-9, 8-4, 8-8, 8-17, 8-20,
9-3, 9-5, 9-7, 9-23, 9-26,
9-30, 9-33, 9-35, 9-37,
9-46, 9-82, 9-83, 9-103,
9-105, 9-198, 9-205, 9-206,
9-207, 9-210, 9-212, 9-213,
9-214, 9-218, 9-223, 9-228,
9-229, 10-10

Measuring flume 7-6, 7-9,
9-83, 9-188, 9-202, 9-212,
9-213

Measuring weir 6-22, 7-7

Micro irrigation 6-25, 6-59,
6-62, 6-63, 6-65, 6-67,
6-68, 6-69, 6-70, 6-72,
6-73, 6-74, 6-75, 6-76,
6-80, 6-89, 7-2, 7-3, 7-15,
7-16, 7-21, 8-7, 9-32,
9-33, 9-34, 9-35, 9-43,
9-163, 9-164, 9-165, 9-166,
9-167, 9-168, 9-169, 9-170,
9-171, 9-172, 9-173, 9-206,
9-230, 9-231, 9-232, 11-1,
11-2

- Microspray 5-2, 5-10, 6-74, 6-76
 Miners inches 7-9, 8-1, 9-219
 Minispray 10-10
 Moisture stress 1-4, 2-5, 2-9,
 2-28, 3-2, 3-3, 3-4, 3-5,
 3-7, 3-12, 3-14, 3-16,
 3-24, 9-1, 9-2, 9-20, 9-21,
 9-22, 9-23, 9-25
- N**
- Net irrigation requirement
 3-12, 3-23, 4-3, 4-4, 6-56,
 8-2, 9-65, 9-80, 9-101,
 9-117, 9-149, 9-150,
 9-161, 10-6
 Net system capacity 4-4
 Net water application 6-9
 Non-saline 5-10
 Nonpoint source 7-20
- O**
- Opportunity time 2-17, 2-29,
 6-6, 6-11, 6-13, 9-37, 9-45,
 9-47, 9-60, 9-65, 9-66,
 9-67, 9-68, 9-69, 9-77,
 9-79, 9-81, 9-96, 9-99,
 9-100, 9-102, 9-103, 9-104,
 9-115, 9-137, 9-186, 9-188,
 9-199, 9-202
- P**
- Parshall flume 7-10, 9-36,
 9-37, 9-206, 9-211, 9-212
 Peak daily evapotranspiration 6-1
 Penman method 4-2
 Penman-Monteith method 4-2
 Perched water table 2-28
- Percolation 1-2, 1-5, 2-17,
 3-13, 4-3, 4-4, 4-8, 4-9,
 4-10, 5-4, 6-2, 6-5, 6-7,
 6-8, 6-9, 6-11, 6-13, 6-14,
 6-15, 6-18, 6-25, 6-27,
 6-50, 6-65, 6-75, 7-18,
 7-19, 7-21, 8-6, 8-10,
 8-11, 8-19, 9-25, 9-26,
 9-28, 9-31, 9-38, 9-62,
 9-64, 9-79, 9-100, 9-102,
 9-116, 9-130, 9-148, 9-149,
 9-164, 10-10, 10-11, 10-12
 Periodic move 2-17, 2-22,
 2-38, 6-27, 6-28, 6-30,
 6-31, 6-42, 6-44, 6-89,
 7-16, 9-40, 9-119, 9-122,
 9-123, 9-124, 9-125, 9-126,
 9-127, 9-128, 9-129, 9-130,
 9-131, 9-132, 9-133, 9-165,
 9-190, 9-204, 9-231
 Permeability 2-2, 2-3, 2-4,
 2-7, 2-16, 2-17, 2-28,
 2-29, 2-32, 2-39, 3-1, 5-11
 Piston pump 9-213
 Pollution 1-1, 1-2, 1-4, 1-9,
 6-13, 6-20, 6-45, 6-81,
 7-21, 7-25, 9-23, 9-30,
 9-31, 10-7
 Precipitation 2-1, 3-1, 3-17,
 4-3, 4-4, 4-8, 4-9, 4-10,
 5-7, 6-1, 6-6, 6-14, 6-48,
 6-49, 6-50, 6-51, 6-65,
 6-68, 6-74, 6-80, 7-11,
 7-12, 7-18, 7-19, 7-20,
 7-33, 8-2, 8-3, 8-6, 8-10,
 8-11, 8-17, 9-23, 9-26,
 9-28, 9-40, 9-186, 9-203,
 10-7, 10-10, 10-11, 10-12
 Preferential flow paths 2-17
 Pressure plate 9-5
 Pressure regulator 6-33, 6-36,
 6-50, 6-52, 6-65, 6-66, 6-77
 Project water requirement 6-1,
 8-2, 8-7
 Puddling 6-30, 6-55, 6-56,
 9-186, 9-190
 Pump characteristic curves 6-34,
 7-17
 Pump impeller 7-9, 7-17, 9-184
 Pump performance curves 6-34,
 7-17, 9-181
- Pump sump 6-20, 9-189, 9-202
 Pumpback system 6-20, 7-11,
 7-12
 Pumping plant efficiency 9-66,
 9-80, 9-101, 9-117, 9-132,
 9-183
 Pumping plants 1-1, 5-3, 6-1,
 7-2, 7-17, 7-33, 9-174,
 9-181, 9-182, 9-183, 9-185,
 9-231, 10-7, 10-10
- R**
- Radiation method 4-2
 Recession curve 9-36, 9-37,
 9-59, 9-60, 9-65, 9-66,
 9-67, 9-69, 9-96, 9-97,
 9-101, 9-102, 9-229
 Recession rate 6-2
 Reference crop evapotranspira-
 tion 4-1, 4-2
 Relative humidity 4-1, 4-2,
 4-3, 4-8, 9-20, 9-28
 Replogle flume 7-9, 7-10,
 9-36, 9-37, 9-206, 9-211,
 9-212, 9-214, 9-223
 Retardance 6-10
 Rill irrigation 10-10
 Riparian areas 6-80
 Root zone 1-2, 1-5, 2-1, 2-3,
 3-1, 3-2, 3-7, 3-8, 3-10,
 3-11, 3-12, 3-13, 3-19,
 4-3, 4-7, 4-8, 4-9, 5-4,
 6-2, 6-6, 6-9, 6-11, 6-15,
 6-48, 6-50, 6-63, 6-65,
 6-66, 6-68, 6-73, 6-75,
 6-81, 7-18, 7-19, 8-10,
 8-11, 9-2, 9-5, 9-6, 9-7,
 9-17, 9-20, 9-22, 9-23,
 9-26, 9-30, 9-31, 9-32,
 9-37, 9-38, 9-43, 9-46,
 9-65, 9-69, 9-79, 9-83,
 9-96, 9-100, 9-102, 9-116,
 9-119, 9-130, 9-134, 9-148,
 9-153, 9-160, 9-163, 9-170,
 9-171, 9-199, 10-5, 10-10,
 10-11
 Rooting depth 1-4, 2-4, 2-28,
 3-8, 3-23, 4-9, 6-6, 6-33,
 6-45, 6-75, 9-1, 9-2, 9-7,
 9-14, 9-34, 10-5

- Runoff** 1-2, 1-5, 2-3, 2-17, 2-20, 2-21, 2-25, 2-26, 2-27, 2-29, 2-38, 3-1, 3-13, 3-14, 4-3, 4-4, 4-8, 4-9, 5-1, 5-3, 5-7, 5-12, 6-2, 6-3, 6-5, 6-6, 6-7, 6-8, 6-9, 6-11, 6-12, 6-13, 6-14, 6-15, 6-18, 6-20, 6-21, 6-22, 6-27, 6-44, 6-45, 6-46, 6-47, 6-48, 6-49, 6-50, 6-51, 6-52, 6-65, 6-69, 7-11, 7-12, 7-13, 7-18, 7-19, 7-20, 7-21, 7-33, 7-34, 8-3, 8-6, 8-7, 8-10, 8-11, 8-18, 9-25, 9-31, 9-33, 9-34, 9-36, 9-38, 9-39, 9-41, 9-42, 9-46, 9-47, 9-59, 9-60, 9-62, 9-64, 9-65, 9-66, 9-67, 9-82, 9-84, 9-100, 9-102, 9-103, 9-104, 9-116, 9-130, 9-133, 9-134, 9-137, 9-148, 9-149, 9-151, 9-152, 9-160, 9-162, 9-186, 9-189, 9-202, 9-204, 9-205, 10-6, 10-10, 10-11, 10-12
- S**
- Saline soil** 2-31, 3-1, 7-19
Salinity 1-1, 1-4, 2-1, 2-3, 2-4, 2-5, 2-7, 2-9, 2-10, 2-23, 2-24, 2-31, 2-37, 2-39, 3-1, 3-17, 3-18, 3-19, 3-23, 4-7, 5-7, 5-8, 5-9, 5-10, 5-11, 6-33, 6-65, 6-66, 6-68, 6-81, 8-1, 8-6, 8-10, 8-17, 9-16, 9-18, 9-20, 9-28, 9-31, 9-39, 9-41, 9-42, 9-43, 9-46, 9-69, 9-82, 9-83, 9-119, 9-134, 9-152, 9-164, 10-3, 10-5
Salinity management 3-18, 4-7, 9-31, 9-82
Salt tolerance 3-17
Screening device 7-2
- Sediment** 1-2, 2-17, 2-23, 5-3, 5-7, 6-1, 6-9, 6-11, 6-20, 6-21, 6-25, 6-26, 6-45, 6-63, 6-65, 6-66, 6-70, 6-73, 6-74, 7-4, 7-6, 7-7, 7-12, 7-13, 7-19, 8-7, 8-12, 8-17, 8-18, 8-19, 9-31, 9-33, 9-34, 9-38, 9-41, 9-46, 9-82, 9-83, 9-135, 9-153, 9-165, 9-172, 9-186, 9-213, 9-214, 9-215, 9-217, 9-221
Seepage losses 6-8, 7-5, 7-33, 8-8, 9-31, 9-213
Semiarid climate 3-1, 5-7, 5-9, 5-10, 5-12, 6-1, 6-9, 6-15, 6-42, 6-48, 6-79
Sideroll wheel line 5-2, 5-4, 7-16, 9-40, 9-119, 10-6
Siphon tube 6-12, 6-20, 6-22, 6-25, 7-4, 7-7, 7-8, 9-33, 9-37, 9-38, 9-82, 9-207, 9-223
Sodic soil 2-31, 2-37, 3-1, 7-19, 9-16
Sodicity 1-4, 2-1, 2-3, 2-4, 2-5, 2-7, 2-17, 2-23, 2-24, 2-31, 3-1, 3-17, 3-18, 3-19, 3-23, 4-7, 5-7, 5-8, 5-9, 5-10, 5-11, 7-18, 8-17, 10-5
Sodium adsorption ratio (SAR) 2-31, 2-32, 2-39, 3-17
Soil erodibility 2-4, 2-29, 2-30, 2-37, 2-38, 8-1
Soil horizon 2-12
Soil properties 1-4, 2-1, 2-2, 2-3, 2-4, 2-29, 2-34, 2-37, 2-38, 2-39, 6-83
Soil survey 1-4, 2-1, 2-2, 2-34, 8-1, 9-46, 9-68, 10-5
- Soil water** 2-4, 2-9, 2-28, 3-1, 3-2, 3-5, 3-7, 3-8, 3-10, 3-13, 3-24, 4-4, 4-8, 6-5, 6-42, 6-65, 6-66, 6-83, 7-15, 9-2, 9-7, 9-8, 9-10, 9-14, 9-17, 9-19, 9-21, 9-23, 9-24, 9-26, 9-28, 9-46, 9-47, 9-57, 9-62, 9-65, 9-66, 9-69, 9-70, 9-79, 9-81, 9-83, 9-84, 9-96, 9-100, 9-102, 9-103, 9-104, 9-113, 9-116, 9-118, 9-188, 9-206, 9-229, 10-11, 10-12, 10-27
Soil-water deficit 3-7, 3-12, 9-6, 9-26, 9-31, 9-36, 9-37, 9-38, 9-40, 9-41, 9-42, 9-43, 9-119, 9-132, 9-134, 9-148, 9-151, 9-153, 9-162
Soil-water potential 3-8, 3-17
Solar radiation 4-1, 4-2, 4-3, 4-8, 5-3, 8-17
Solid set irrigation 5-2, 5-5, 5-8, 6-27, 6-42, 10-10
Specific gravity 2-16
Spray heads 2-20, 3-13, 3-15, 5-2, 5-5, 5-12, 6-30, 6-44, 6-46, 6-48, 6-52, 6-59, 6-63, 6-70, 6-74, 9-43, 9-122, 9-134, 9-163, 9-165, 9-189, 9-190, 9-203, 10-13
Sprinkler irrigation 2-17, 4-9, 5-6, 5-8, 5-9, 5-12, 5-17, 6-1, 6-27, 6-28, 6-33, 6-34, 6-35, 6-42, 6-43, 6-45, 6-52, 6-89, 7-8, 7-15, 7-21, 9-33, 9-119, 9-122, 9-123, 9-124, 9-125, 9-126, 9-127, 9-128, 9-129, 9-130, 9-131, 9-132, 9-133, 9-137, 9-138, 9-139, 9-140, 9-141, 9-142, 9-143, 9-144, 9-145, 9-151, 9-152, 9-155, 9-156, 9-157, 9-158, 9-159, 9-164, 9-231, 9-232, 10-6, 10-14, 10-24, 10-25, 10-26
Static head 9-181
Subhumid climate 4-4, 4-6
Subirrigation 5-2, 5-11, 5-17, 6-83, 8-18, 9-45, 10-10

- Supplemental irrigation 6-56, 7-18
- Surface irrigation 1-2, 5-1, 5-7, 5-12, 5-17, 6-2, 6-3, 6-5, 6-6, 6-7, 6-8, 6-10, 6-12, 6-18, 6-22, 6-27, 6-44, 6-83, 6-89, 6-91, 7-4, 7-15, 7-16, 7-19, 8-4, 8-6, 8-7, 9-33, 9-47, 9-48, 9-49, 9-50, 9-51, 9-52, 9-53, 9-54, 9-55, 9-71, 9-72, 9-73, 9-74, 9-75, 9-76, 9-84, 9-85, 9-86, 9-87, 9-88, 9-89, 9-90, 9-91, 9-92, 9-93, 9-94, 9-35, 9-100, 9-106, 9-107, 9-108, 9-109, 9-110, 9-111, 9-112, 9-185, 9-186, 9-227, 9-231, 10-6
- Surface sealing 2-23, 9-186
- Surface storage 2-20, 2-21, 2-22, 2-25, 2-26, 2-27, 2-28, 2-29, 2-38, 2-39, 3-14, 6-2, 6-9, 6-27, 6-44, 6-45, 6-46, 6-47, 6-48, 6-50, 6-51, 6-52, 9-42, 9-137, 9-151, 9-162, 9-189, 9-203, 9-204
- Surge irrigation 6-10, 6-14, 6-16, 6-18, 6-91, 9-38
- System capacity 2-1, 4-4, 6-1, 6-28, 6-33, 6-46, 6-49, 6-50, 6-51, 6-75, 6-78, 6-89, 8-3, 8-19, 8-25, 9-147, 9-160, 10-14
- T**
- Tailwater recovery 6-20, 6-21, 6-91, 7-2, 7-11, 7-12, 7-13, 7-14, 7-19, 7-33, 10-6, 10-10
- Tensiometer 9-14, 9-15, 9-16, 9-228, 9-229
- Total available water 3-7
- Toxicity 3-18, 3-19, 5-3
- Translocation 2-20, 2-25, 3-13, 6-27, 6-44, 6-45, 6-46, 6-47, 6-48, 6-49, 6-50, 6-51, 6-52, 6-56, 7-19, 9-31, 9-34, 9-39, 9-41, 9-42, 9-133, 9-134, 9-137, 9-151, 9-152, 9-160, 9-161, 9-186, 9-189
- Transpiration 2-1, 3-12, 3-17, 3-18, 4-1, 6-7, 6-65, 9-19, 9-20
- Traveling gun sprinkler 5-2, 5-5, 6-27, 6-54, 6-55, 6-56, 6-57, 9-42, 10-6
- Trickle irrigation 6-34, 6-59, 6-85, 9-163
- Turbine pump 6-34
- U**
- Unsaturated 2-20, 6-5
- Upflux 2-1, 4-8, 6-81, 7-19, 9-22, 9-227
- Upward flow 4-8, 6-83, 9-22
- V**
- Vacuum pump 7-6, 9-14
- Volumetric water content 3-17
- W**
- Wastewater 6-20, 6-26, 7-19, 8-18
- Water balance 8-11, 9-1, 9-4, 9-22, 9-25, 9-26, 9-27, 9-28, 9-227, 9-229, 10-10, 10-11
- Water brake 6-20
- Water budget 1-4, 1-5, 8-10, 8-11, 8-19, 8-25, 8-26, 9-1, 9-4, 10-10
- Water duty 5-4
- Water holding capacity 2-4, 2-37, 9-4, 9-5
- Water measurement 1-4, 2-16, 3-14, 6-1, 7-2, 7-9, 7-33, 8-8, 8-19, 9-4, 9-25, 9-202, 9-205, 9-206, 9-207, 9-228, 9-229
- Water quality 2-1, 2-17, 3-1, 6-2, 6-9, 6-67, 6-70, 6-81, 7-18, 7-20, 7-21, 8-1, 8-10, 8-11, 8-12, 8-19, 8-20, 9-1, 9-2, 9-16, 9-22, 9-45, 9-68, 9-82, 9-135, 9-153, 10-1, 10-5, 10-6
- Water right 5-1, 5-3, 7-9, 8-1, 8-8, 8-12, 8-17
- Water table 2-1, 2-3, 2-4, 2-28, 2-29, 2-34, 2-37, 2-39, 3-10, 5-2, 5-3, 5-11, 6-33, 6-80, 6-81, 6-82, 6-83, 6-84, 6-85, 6-92, 7-18, 7-19, 7-20, 8-1, 8-6, 8-17, 9-1, 9-17, 9-22, 9-26, 9-34, 9-46, 9-69, 9-83, 9-104, 9-119, 9-134, 9-153, 10-5, 10-6, 10-10
- Water table management 6-81, 6-82, 6-83, 6-85, 6-92
- Weather station 9-26, 9-28
- Weir 6-22, 6-81, 6-82, 7-5, 7-7, 7-9, 7-16, 8-10, 9-36, 9-37, 9-68, 9-82, 9-103, 9-188, 9-198, 9-206, 9-207, 9-209, 9-210, 9-211, 9-212, 9-213, 9-214, 9-215, 9-216, 9-217, 9-223, 9-228, 9-230
- Wetted bulb 6-65, 9-38, 9-199
- Wetted front 9-47, 9-70,
- Wetted perimeter 9-99, 9-100, 9-101
- Wheel line 6-29, 6-35, 6-36, 6-52, 6-92, 9-40, 9-41, 9-119, 10-6
- Wilting point 2-4, 2-5, 2-9, 9-4, 9-5, 9-7, 9-10, 9-18, 9-20
- Wind drift 3-13, 4-4, 5-4, 6-27, 6-50, 6-51, 7-21, 9-40, 9-129, 9-135, 9-153, 9-171
- Wind movement 4-2, 4-8