

# *Fishing in Hawai'i*

A Student Manual

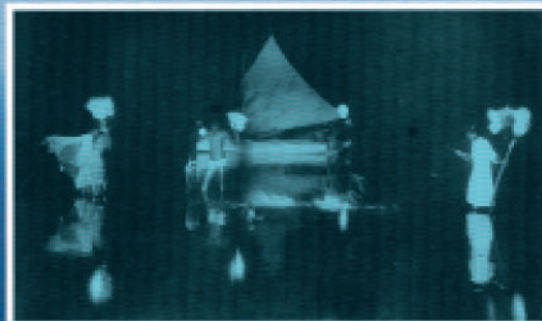



**DIVISION OF AQUATIC RESOURCES**  
Department of Land and Natural Resources  
1151 Punchbowl Street, Room 330  
Honolulu, HI 96813

Written by Randy Honebrink. Boating Safety section written by Pete Hendricks.  
Fish Poisoning material from Hawai'i Dept. of Health publication *Fish Poisoning in Hawaii*.  
Illustrations by Sharon Oetting, except as noted.  
Photos by Randy Honebrink, except pp. 61, 62 (DAR collection).  
Cover photos (clockwise from top): Tai Sing Loo\*, Randy Honebrink, Ray Jerome Baker\*,  
Randy Honebrink, Alonzo Gartley\*, Annette Tagawa. \* Courtesy of Bishop Museum.

*Fishing in Hawai'i: A Student Manual* is produced by the Education Section, Hawai'i Division of Aquatic Resources. Funding is provided in part by the Federal Aid in Sport Fish Restoration Program, through your purchase of fishing equipment and motor boat fuels.





# Contents

|  |           |
|--|-----------|
| <b>Fishing Gear</b> .....                      | <b>1</b>  |
| Bamboo Poles .....                             | 1         |
| Rods and Reels .....                           | 2         |
| Line .....                                     | 10        |
| Knots .....                                    | 13        |
| Hooks .....                                    | 18        |
| Lures and Baits .....                          | 21        |
| Other Tackle .....                             | 24        |
| Tackle Boxes .....                             | 28        |
| <b>Fishing Methods and Techniques</b> .....    | <b>30</b> |
| Angling Methods .....                          | 30        |
| Basic Angling Techniques .....                 | 33        |
| Other Fishing Methods .....                    | 35        |
| Cleaning a Fish .....                          | 37        |
| <b>Fishing Safety</b> .....                    | <b>39</b> |
| Dealing With the Sun .....                     | 39        |
| Shoreline Safety .....                         | 39        |
| Boating Safety .....                           | 40        |
| Hook Removal .....                             | 43        |
| Fish Poisoning .....                           | 44        |
| Dangerous Marine Organisms .....               | 45        |
| <b>Fish Biology and Habitat</b> .....          | <b>49</b> |
| Fish Biology .....                             | 49        |
| Habitat .....                                  | 53        |
| <b>Conservation and Management</b> .....       | <b>57</b> |
| Regulations .....                              | 58        |
| Management by Area .....                       | 59        |
| Habitat Enhancement .....                      | 61        |
| Introduced Species and Stock Enhancement ..... | 63        |
| How You Can Help .....                         | 64        |
| <b>Fish Identification</b> .....               | <b>65</b> |
| <b>Suggested Reading</b> .....                 | <b>79</b> |



# FISHING GEAR

---

There are lots of ways to catch a fish. Different types of nets, spears, and hooks and line have been used in Hawai‘i for centuries, and many are still in use today. Some of these methods will be discussed in the next chapter.

Any type of fishing that's done with a hook is known as *angling* (the old English word for a fish hook was “*angle*”). You don't need a rod and reel to be an angler. You can get by with just a hook and line (for example, *handline* fishing, which is described later). Next to a simple handline, the most basic type of angling gear used in Hawai‘i is the bamboo pole rig.

## Bamboo Poles

---

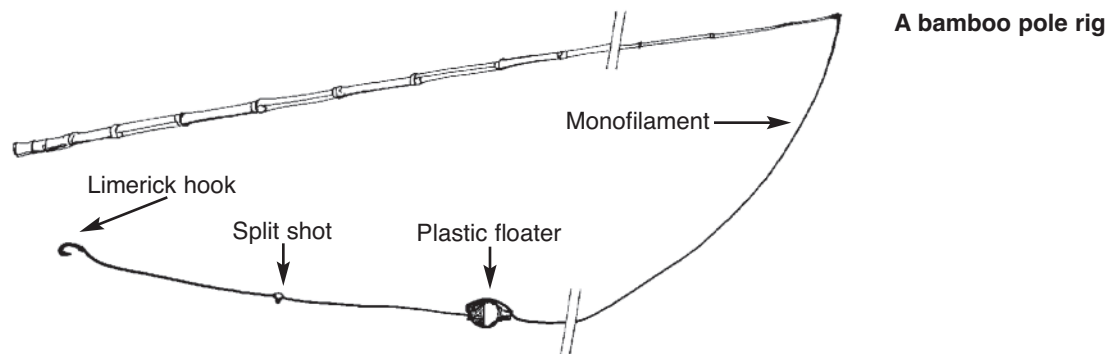

Many kids caught their first fish with just a bamboo pole, line, small hook and bait. Bamboo poles are inexpensive, and great for beginners of all ages. Not only are they easier to use than rods and reels, but they help develop the most basic fishing skills. You'll learn to select line, tie line to hooks and the pole, and choose and present bait. Most importantly, you'll learn how and when to set the hook and bring in a fish. A basic bamboo pole rig is shown above.

Bamboo poles aren't just for beginners. Short ones are the gear of choice for ‘oama fishing; longer bamboo poles are often used to fish for akule and halalū, and reef fish in general. The advantage of bamboo poles is that they provide better control in placing the bait — you can rest the bait on the surface or put it anywhere you see fish. In addition, you're less likely to get your line tangled with those of other anglers, especially if you're on a pier or shoreline that's shoulder-to-shoulder with people during a halalū run.

If you're buying a bamboo pole, get one that has lots of “*knuckles*” on the stalk. The knuckles are the strongest points of the pole. Be sure there are no worm holes or soft spots present, and the skin is a glossy yellowish coloration. The tip should be very small. Most bamboo poles bought in fishing supply stores will have a loop of cotton cord at the tip for attaching the line. If you have a pole without a loop, you can either add one or attach the line behind the first knuckle as shown in the following diagram.

Attaching line to  
a bamboo pole

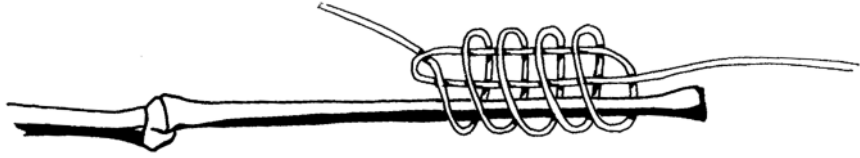

Double line along pole behind last knuckle; take 4 or 5 turns around line and pole, then pass line through loop as shown; pull line to tighten.

## Rods and Reels

---

Fishing with rod and reel is the most popular way to catch a fish. Many anglers would argue that it's also the most sporting method, and the most exciting. There is no sound that compares with the scream of a reel as an unseen fish rips line off your spool, and the fight begins.

All reels have one basic function - to store, pay out and retrieve line. We'll look at the types of reels shortly, but first some reel terminology:

**Spool** — the part of the reel that stores line;

**Drag** — the braking system of the reel, creating friction to slow the rate at which line is pulled off the spool;

**Bail** — on spinning reels only, a half-hoop of metal which revolves to take up line onto the spool; the bail is flipped open for casting;

**Gear ratio** — the ratio of the number of turns of the spool or bail to the number of turns of the handle; for example, a gear ratio of 4/1 means that one complete turn of the handle will turn the spool or bail four times.

Certain types of reels have other unique parts, and they will be described shortly.

The main function of a rod is to act as a spring when casting, and to provide leverage when playing a fish. Different types of rods are used for different types of fishing, but there are certain features common to all. Some rod terminology:

**Shaft** — the main part of the rod;

**Reel seat** — the area where the reel is attached to the rod;

**Ferrules** — joints that hold rod sections together;

**Guides** — the loops through which line passes;

**Butt guide** — the guide closest to the reel;

**Tip top** — the guide at the end of the rod.

Rod shafts are made of various materials, including fiberglass, graphite or boron. Many rods are made of combinations (or *composites*) of these materials. Fiberglass rods are the most rugged, and boron rods are the most sensitive. Graphite rods are more sensitive than fiberglass, and graphite

### Parts of a spinning reel

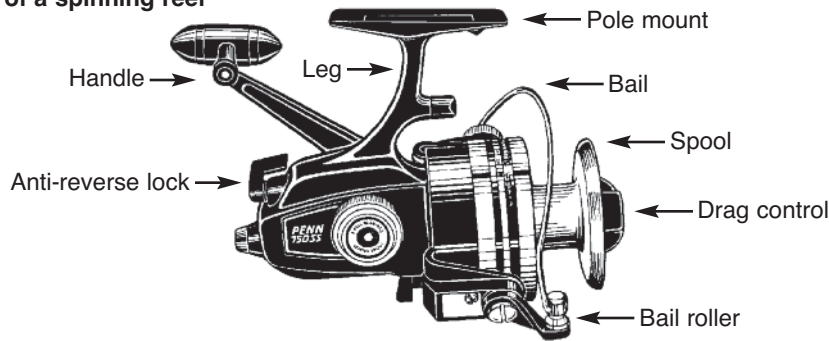

### Parts of a spinning rod

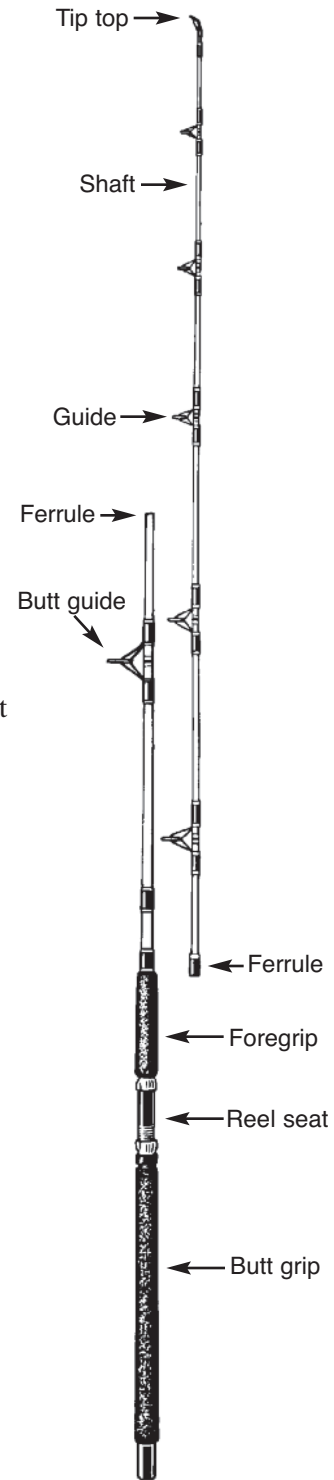

composite rods are very popular. They require more care than fiberglass since they are more easily scratched (a rod will be weakened at the point of a scratch). Both boron and graphite are lighter and thinner than fiberglass and generally more comfortable to use. The handle (or *grip*) is usually made of cork or soft synthetic material, such as hypolon.

There are four basic types of rods and reels, which we will now look at in some detail.

## Spinning Gear

*Spinning reels* are the most popular type used by shoreline fishermen and make excellent all-purpose reels. They can be used in freshwater or salt-water, for small and medium sized fish. The spool of a spinning reel does not revolve (except when a fish is pulling off line). Instead, line is taken up by a revolving bail as the handle is turned. In addition, the spool moves back and forth (or up and down, depending on how you're looking at it) so the line is spooled evenly. When casting, you hold the line with your forefinger, flip open the bail, and release the line at the appropriate point in the cast. Because of the reel's open face design the line flows freely off the spool until the bail is snapped shut, either by hand or by turning the handle. Spinning reels are designed to be mounted and used *below* the rod.

With the right size line and reel, spinning reels can be used for long casts with fairly light lures, which is not possible with other types of reels. In addition, spinning reels are relatively trouble-free and are easy to clean and maintain.

Most spinning reels sold today have a *skirted spool* — the spool surrounds the rotating head of the reel instead of sitting inside it. This design helps keep sand and water out of the housing, and reduces the chances of getting line caught inside the reel.

*Spinning rods* always have a butt guide that is much larger in diameter than any of the other guides. That's because of the reel's design — since line is coming off the spool in large spirals the butt guide must be big enough so as not to constrict the line's motion. Going along the rod the guides become smaller in diameter. The reel seat on a spinning rod does not have a finger grip (as we'll see in baitcasting and spincasting rods); your finger holds on to the leg of the reel. Because the reel sits below the rod, spinning rods are built to flex toward the side on which the guides are mounted. You shouldn't use a spinning rod with a casting reel, and vice versa.

Illustrations on this page courtesy of Penn Fishing Tackle Mfg. Co.

**Casting a spinning reel** (*below*). 1) The proper handhold; 2) Hold line and flip open the bail; 3) Point rod toward target; 4) Bring rod back and begin cast; 5) As rod passes overhead release line; 6) Follow through.

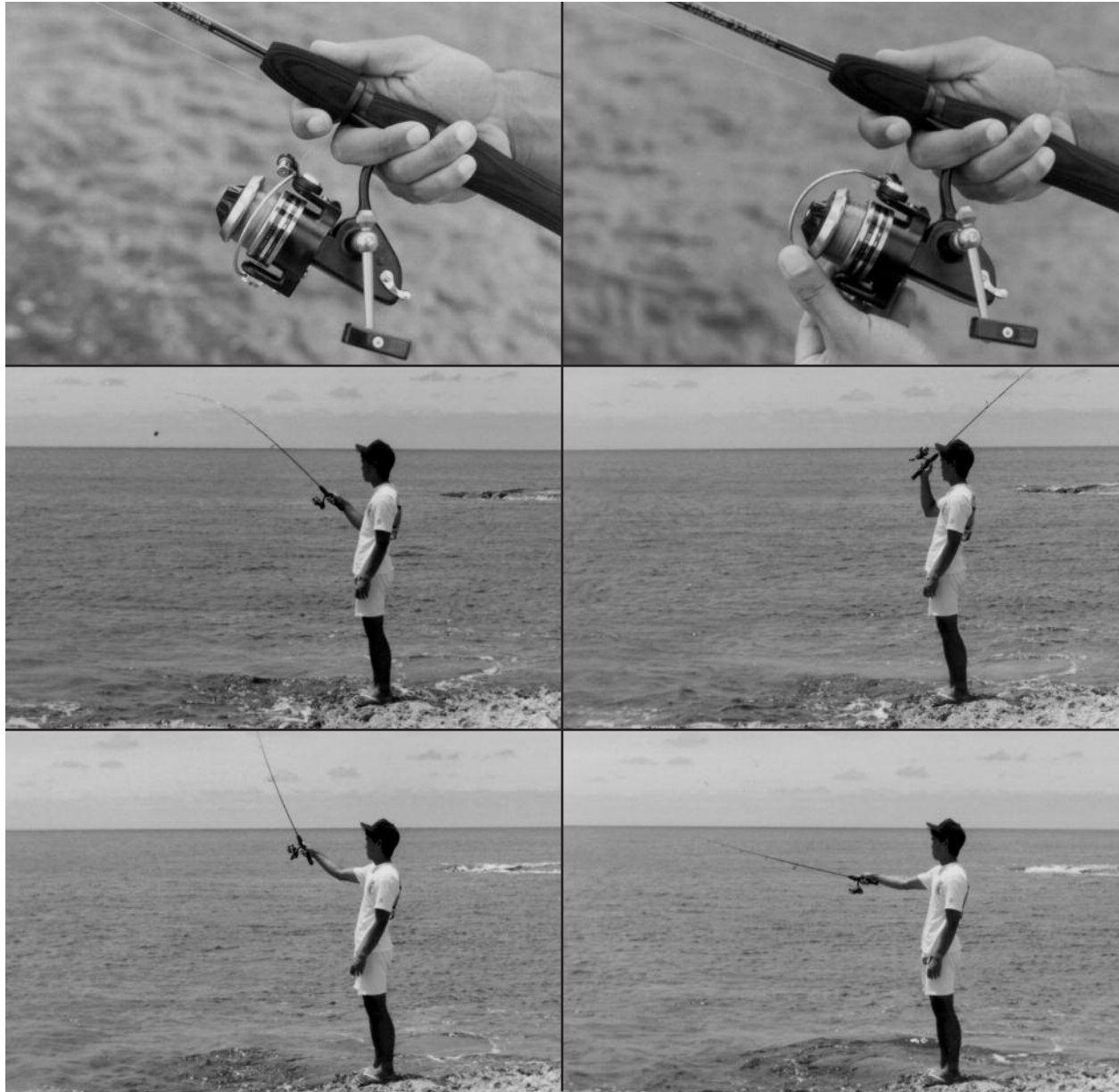

## Conventional Gear

*Conventional reels* are reels in which the spool revolves when casting, and include everything from small *baitcasting* reels through large *surfcasting* reels, and on up to the largest *trolling* reels (although you don't really cast with these). When retrieving line the reel acts as a winch. Conventional reels were the original reel design.

Baitcasting gear is used mostly for freshwater fishing, and surfcasting gear is used primarily for slide-bait fishing (described in the next chapter). We won't say much about trolling reels, but will concentrate instead on baitcasting and surfcasting reels (*casting* reels, in general).



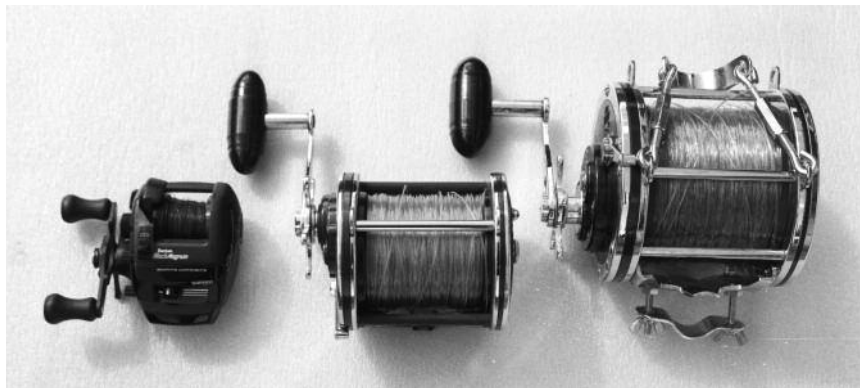

**Conventional Reels** (at left)  
l to r: Baitcasting, surfcasting,  
trolling reels

**Parts of a conventional reel**

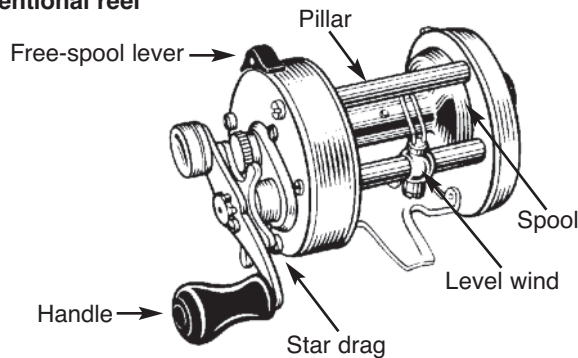

The major disadvantage of casting reels is that the revolving spool tends to keep revolving at the end of a cast, which results in overruns of the line (*backlashes*). Finishing off a cast with a backlash is embarrassing and frustrating, not to mention a tremendous mess. To avoid backlashes you need to apply a small amount of pressure to the spool with your thumb during the cast. (When using surfcasting reels, you'll want to pour fresh water over the spool before casting so the friction doesn't burn your thumb.) Fortunately, the newer casting reels are equipped with *cast controls*, centrifugal brakes that reduce the risk of backlashes. The cast control is adjusted to the weight of the lure or bait.

Many casting reels have a feature known as a *level wind* which tracks side to side in front of the spool, laying the line down evenly on the spool; it disengages when casting. On reels without a level wind the line must be moved across the spool with your thumb to spool evenly.

*Casting rods* are different from spinning rods in several ways. First, the reel is mounted *above* the rod. Because the line comes straight off the reel, large guides are not needed. Baitcasting rods usually have a finger grip under the reel seat for a more secure hold. Rods for the larger surfcasting reels don't have a finger grip. Casting rods are built to flex away from the side on which the guides are mounted.

Since we mentioned trolling reels earlier, a few words about *trolling rods* (boat poles) may be in order. Trolling rods have *roller guides* to reduce the friction between the line and guides when fighting big fish. In addition, the butt of a trolling rod has cross grooves that lock into the boat's rod holder to keep the rod from rotating.

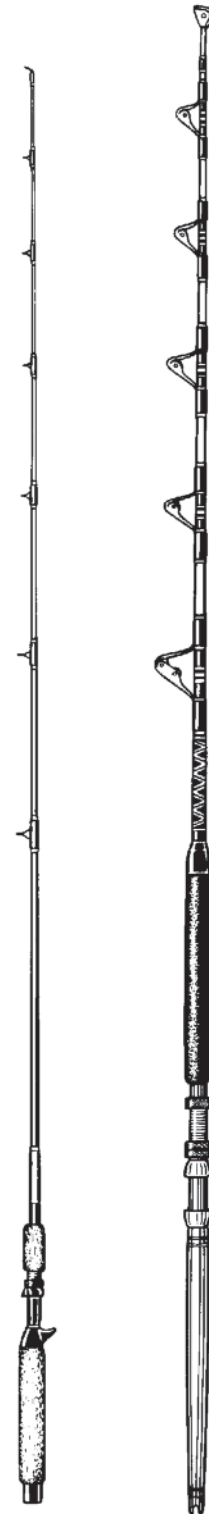

Baitcasting rod    Trolling rod

Illustrations on this page courtesy of  
Penn Fishing Tackle Mfg. Co.

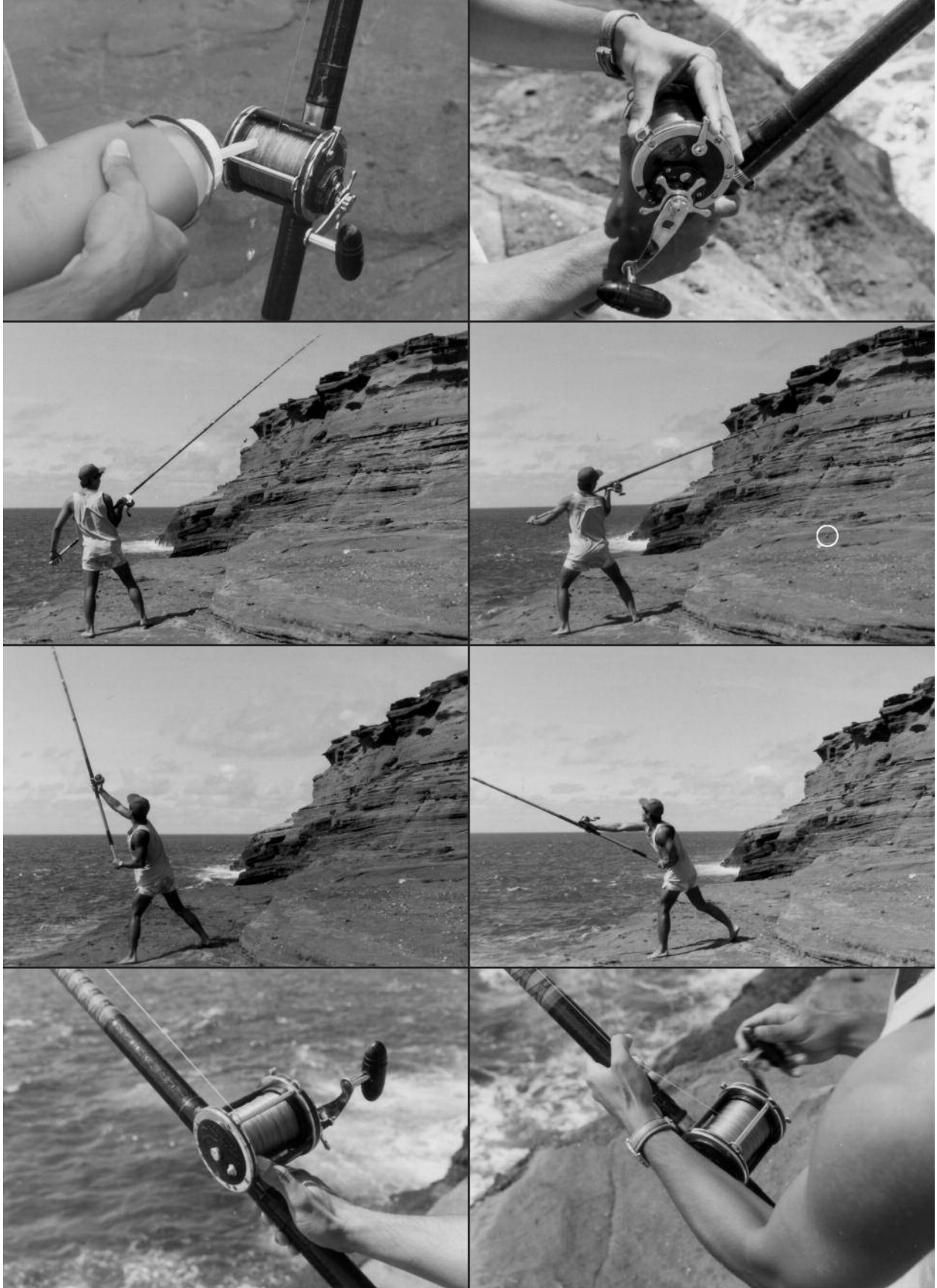

**Casting a surfcasting reel (at left).** 1) Pour water over spool; 2) Move lever to free-spool position; 3) Swing lead to gain momentum; 4) As lead (in circle) moves down and away, begin cast; 5) Release so lead is thrown into air at about a 45 degree angle for greatest distance; 6) Follow through with cast and 7) keep light thumb pressure on spool to avoid birdnest; 8) Use thumb to spool line evenly during retrieve.

## Spincasting Gear

*Spincasting reels* are somewhat similar to spinning reels, especially since the spool does not revolve when casting. However, spincasting reels are *close-faced* with a front cover (or *nose cone*) over the spool. In addition, there is no bail; a pick-up pin inside the cover is used to spool the line. The greatest advantage of spincasting reels is the ease with which they can be cast. All you have to do is push a button on the back of the reel at the beginning of the cast, and release at the proper instant during the cast. One disadvantage is that the line must come through the small hole in the cover, which makes casting with light lures more difficult than with a spinning reel. Also, if your line becomes tangled on the spool, you have to remove the cover to straighten out the mess.

Spincasting gear is very rarely used in Hawai'i. Although it's fine for freshwater fishing, it does not work well for saltwater fishing. The closed face traps saltwater inside the reel, and cleaning becomes a big problem.

*Spincasting rods* are essentially the same as baitcasting rods.

**Casting a spincasting reel (below).** 1) Face target, press and hold thumb button down; 2) Bring rod back and begin cast; 3) As rod passes overhead release thumb button to let line out; 4) Follow through with cast.

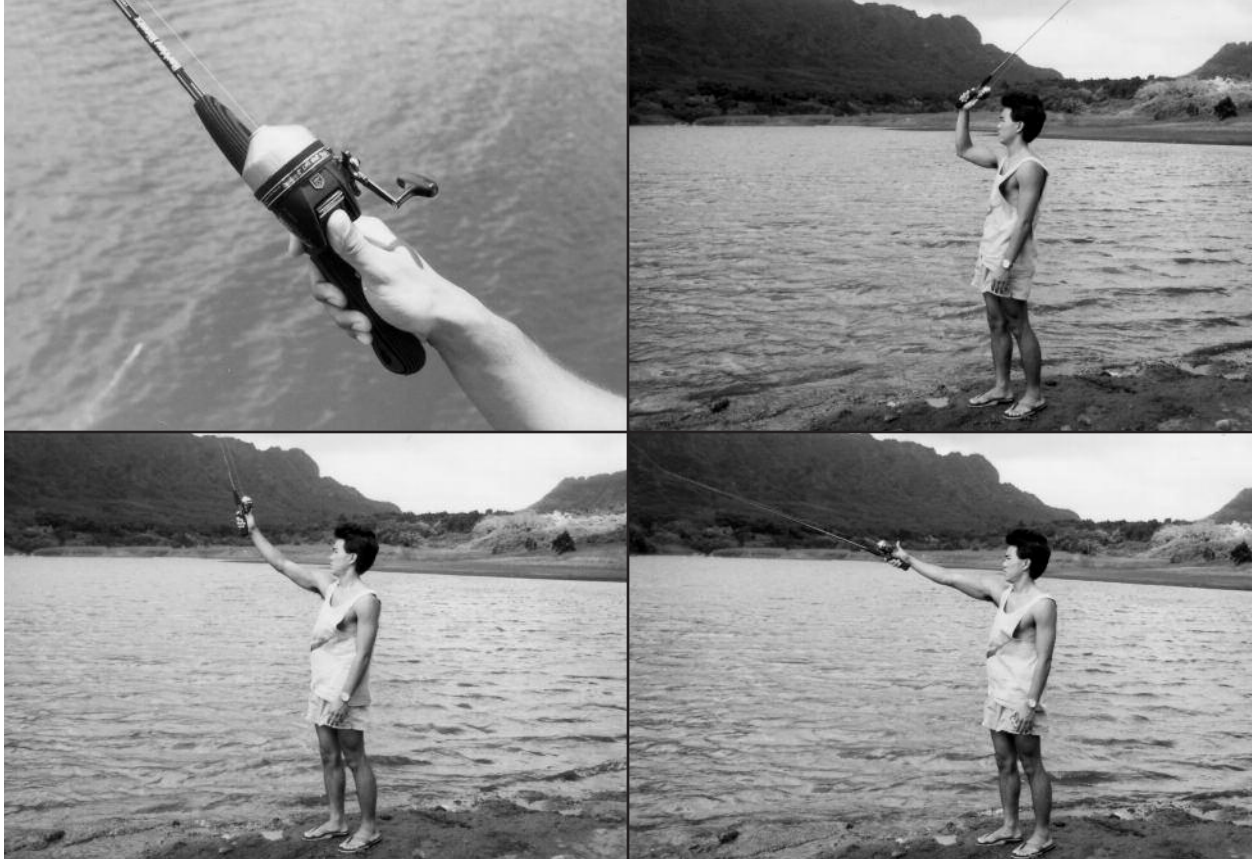



## Flyfishing Gear

*Flyfishing gear* is totally different from any other type of gear with which a lure is cast. *Fly reels* are basically just spools with a handle. The reel is used mostly to store line, and is not involved in the cast. However, the drag helps slow a fish down after it has been hooked. *Flyline* is made of a braided core covered with a plastic coating. It is heavier than other types of line and comes in different weights, tapers and floating characteristics.

In fly casting, it's the heavy line that is cast, and the lure (or fly) just goes along for the ride. To cast flyline you pull line off the reel a little at a time, whipping the rod back and forth to gain momentum and propel the line, then let loose at the proper moment (which is determined only through lots of practice).

*Fly rods* are usually eight to nine feet long, have small diameter guides, and are more flexible than most other types of rods. They are made of various materials, including fiberglass and graphite. A fly reel is mounted at the butt end of the rod, and hangs below it.

A fly reel



Freshwater flyfishing for rainbow trout has been popular on Kaua‘i for some time, and saltwater flyfishing has really caught on recently in Hawai‘i. ‘Ō‘io (bonefish) are the target for most saltwater fly fishers, but ‘ōmilu and other jacks are often hooked. Both put up a terrific fight! Most saltwater fly fishers release fish they have caught. A barbless hook helps facilitate the release with minimal harm to the fish.

## Make Sure it's Balanced

All components of your tackle should match up with each other. You can't cast a light lure off a huge reel with heavy line. Casting a heavy lure off a light rod might snap the rod. All of your gear must be *balanced*. The type of fish you're after will determine the type and size of lure (or bait) and hook you use, as well as the line size. In order to cast effectively the reel size and rod length and action must match the line size and lure weight. That's what's meant by *balanced tackle* — all of the elements are in proper relation to each other.

## Choosing a Rod and Reel

When deciding what kind of rod and reel to buy, you should first consider the type of fish you will be fishing for, the size line and lure (or bait) you'll likely be using, and where you'll be fishing. With rods and reels you generally get what you pay for — the more you spend, the better the quality.

Pick a reel with a spool that has enough capacity for the line you want to use (check the markings on the spool). If it's a spinning reel make sure it has a skirted spool. It should be salt-resistant and have a sturdy construction. The drag should be smooth and adjustable over a fairly wide range. Find out how easy it is to get parts for the reel, since it will break down sooner or later. Talk to other fishermen and find out what they like (and don't like) about the reel. Get one with a good reputation.





Reel markings

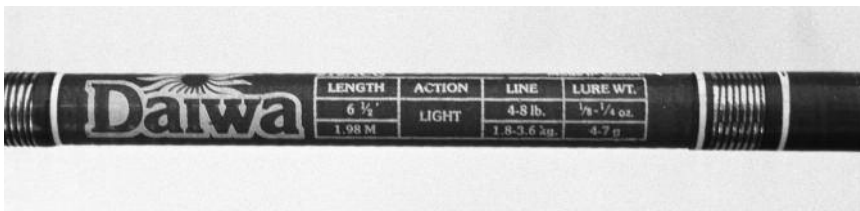

Rod markings

Once you've found the reel of your dreams, picking out a rod is a little easier. Again, you need to consider the type of fishing you'll be doing, especially how much weight you'll be casting. Nearly all rods sold today have markings near the grip that tell you the rod length, action (ultralight through heavy), and recommended line and lure weights. With an ultralight rod and a small reel, catching even little fish becomes a major fight. If you're going after the monsters you'll need something with a heavy action, combined with a bigger reel. If you'll be fishing from cliffs or making long casts, a long rod would be recommended.

Consider what you want your rod to be made of (graphite composites are popular, but more expensive than fiberglass). The guides should not be plain stainless steel, since the line may dig grooves in them. Ceramic or tungsten carbide guides are much better. Check the guides for smoothness and a lack of obvious defects. Holding the rod straight out in front of one eye with the guides straight down so that the rod is directly in the middle of them, make sure the guides are aligned with each other and with the reel seat, and that the rod doesn't curve to the side. Again, the quality of the rod will be reflected in its price.

Many serious fishermen have their rods custom built or build them themselves. They know exactly what they want in a rod and usually feel that the quality of a custom rod can't be matched by one that's commercially made. Still, there are some excellent rods on the market.

## Caring For Your Rod and Reel

There are a few basic rules that should always be followed when using a rod and reel. First of all, never lay a rod and reel down in the sand or on rocks. Getting sand inside a reel can do serious damage to the gears and other moving parts. Sharp rocks can scratch the rod shaft, weakening the rod. They can also put nicks in the guides, spool, bail or bail roller, which will damage your line. A rod lying on the ground is also likely to get stepped on, and you could easily end up breaking it. So lean your rod against a tackle box or on a towel, or whatever else is available.

**Holding the hook:**  
Use only the legs  
and guides

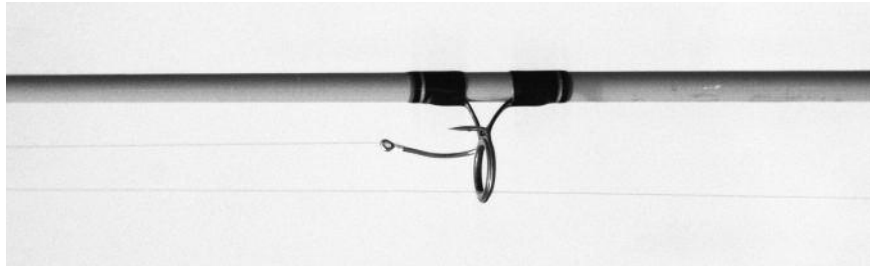

When fishing, you should never immerse a reel in saltwater, since it will be next to impossible to get the salt out again and the reel will start to corrode. Also, use only the legs of the guides (not the eye) to hold your hook. A guide scratched by a hook will damage your line.

After fishing, loosen the drag to avoid deforming the drag washer. Take the spool off and soak it in or spray it with fresh water to remove as much salt as possible. Wash off your reel with fresh water, but don't blast it or soak it. Oil moving parts according to the manufacturer's instructions.

Wash off your rod thoroughly with fresh water, including the ferrules and reel seat. Check the guides for nicks, chips, cracks, etc. (A good way to check the guides is to run a piece of nylon stocking through them; the stocking will snag on any nicks.) Replace any guides that are damaged. Wipe the reel seat and ferrules with an oily rag to keep them slightly lubricated. The better care you take of your rod and reel, the better they'll perform for you, and the longer they'll last.

## Line

---

*Line* is what connects you to your fish, and is probably the most important part of your tackle. There will usually be two parts to your line — the *mainline*, which is the line wrapped around your spool, and the *leader*, which is tied to your hook at one end and attached to the mainline at the other.

There are three basic types of line — *monofilament* (also known locally as *sugi*), *braided line* and *flyline*. Flyline was mentioned briefly in the section on flyfishing gear, and that's about all we'll say about it. Monofilament and braided line are described below. (Information on other leader materials is given later in the chapter.)

### Monofilament

Monofilament line consists of a single strand of nylon. It may be clear, colored, semi-reflective (to make it easier to see your mainline at night), or designed to have reduced visibility (so fish have a

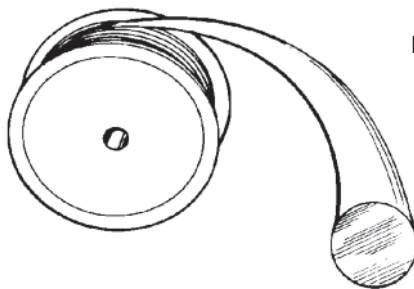

Monofilament — a single strand of nylon

From Pfeiffer & Sosin, *Aquatic Resources Education Curriculum*, ©1987 American Fishing Tackle Manufacturers Association, reprinted by permission of Kendall/Hunt Publishing Co.

harder time seeing it). One of monofilament's greatest advantages is that it stretches. The shock of a strike is absorbed and the chances of the line snapping are reduced. Monofilament is available in a variety of diameters and stiffnesses. In general, a small diameter line works best for long casts. If you are using a spinning reel with a small diameter spool, you'll want to put on line that is fairly limp. "Hard type" monofilament is stiffer, and used mostly for leaders.



**Spools of monofilament**

Like other lines, monofilament comes in a variety of *breaking strengths*, which refers to the amount of weight or force the line can support before breaking. For example, six pound test line breaks at six pounds of force, or pull. Breaking strength is underestimated somewhat on certain types of monofilament, so a ten pound test line may break at between eleven and sixteen pounds of force. Monofilament line used for record fishes must break at the actual line strength, and will usually carry the IGFA (International Game Fish Association) logo somewhere on the label.

Tying a knot in a line weakens the line at that point. *Knot strength* is a rating of line strength at the point where a knot is tied, and is given as a percentage of the line's breaking strength. A knot with a knot strength of 90 per cent tied in a ten pound test line would be expected to hold nine pounds before the knot breaks.

As strong as monofilament is, it will deteriorate with time. Sun, salt, rocks and even water take their toll. You should inspect the last few yards of your mainline whenever you get done fishing, feeling for abrasions. Discard any line that's damaged or you'll increase the chances of losing a fish.

## **Braided Line**

Braided line is fairly heavy limp line made of several strands of dacron. It is usually used with conventional gear (it won't work well for casting with spinning gear), especially at depths below 40 fathoms, and is best for catching big fish. Lighter braided line is used for catching fish like akule and 'ōpelu with handlines. Because it doesn't stretch like monofilament, it makes feeling bites and setting the hook easier. Braided line is more expensive than monofilament, and because it doesn't stretch will tend to break more easily.

## Filling Your Spool

To put line onto a conventional reel:

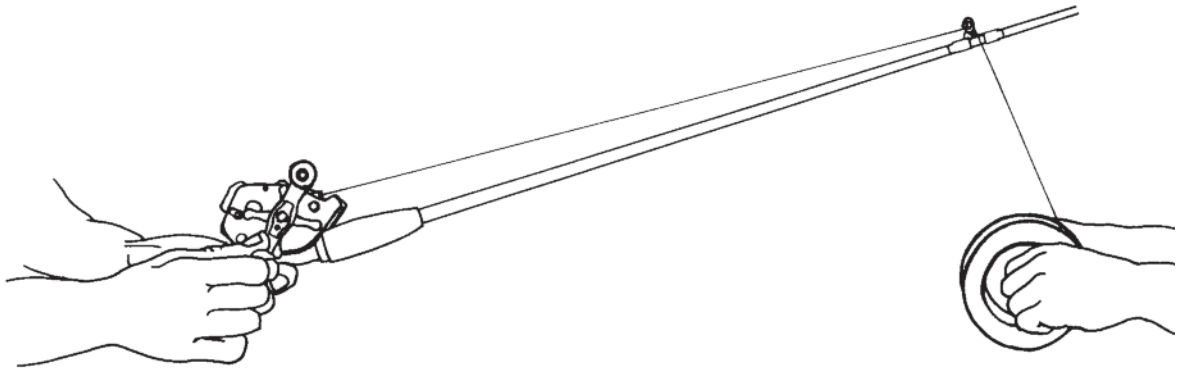

1. Run the line through at least the butt guide of your rod.
2. Tie the line onto the reel spool (a uniknot works well — see section on knots); make sure the line goes through the levelwind, if so equipped.
3. Put a pencil through the center of the supply spool.
4. Keep tension on the supply spool (have a friend hold it or hold it between your feet).
5. Reel in the line from the supply spool.

To fill a spinning reel:

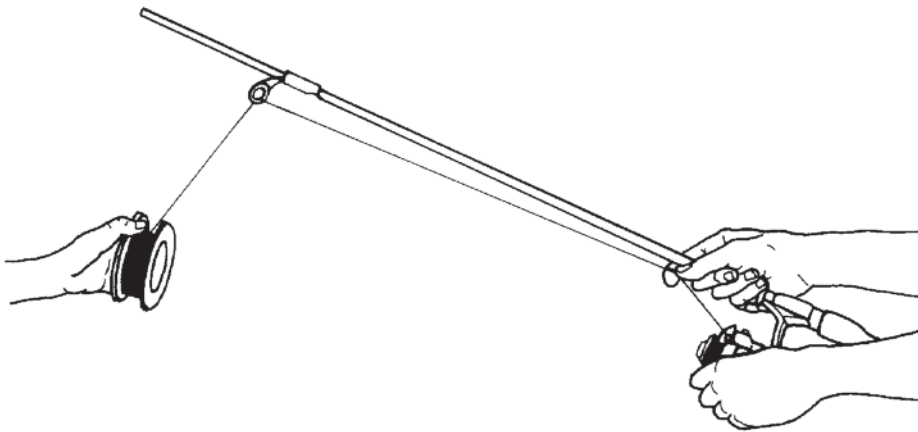

1. Have someone hold the supply spool, or put it on the floor. Pull the line so it spirals off the end of the spool.
2. Run the line through the butt guide of your rod.
3. Flip open the bail, and tie the line onto the reel spool.
4. Hold the rod about three feet away from the supply spool and turn the handle about twenty times.



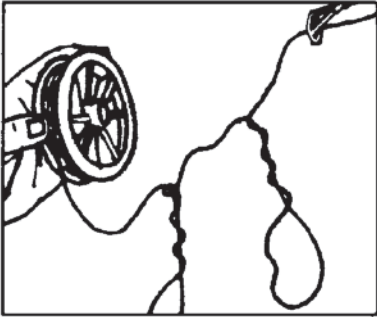

**Wrong**

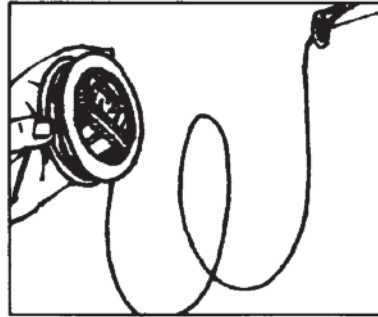

**Right**

Courtesy of DuPont Fishing Products Group

5. Move the rod closer to the supply spool and see if the slack line twists; if it does, flip the supply spool over and continue filling the reel spool.

6. Always keep slight tension on the line by holding it between your thumb and forefinger.

**Note:** Although the above technique is recommended by some line manufacturers, many people prefer to fill a spinning reel using the “pencil technique” described for conventional reels.

It's important not to overfill or underfill a spool. A conventional reel should be filled to the lip, and a spinning reel should be filled to within about 1/8 inch of the edge. After filling it's a good idea to wrap a rubber band around the spool and soak it in warm water for a few minutes to help take the spool memory out of the line.

## Knots

---

You can't tie the types of knots in monofilament that you would in a rope or string — they'll slip and come apart. Some commonly used monofilament knots are illustrated below. In the instructions, *tag end* refers to the free end of the line, and *standing line* is the part of the line that's attached to the reel (or terminal tackle, if the line is a leader).

When tying any kind of knot always start out with plenty of line. It's easier to clip off excess line than it is to go back and start the knot over. Before pulling a knot tight you need to make the line wet (adding saliva is easiest) so it slips properly.

### Tying line to tackle

#### Improved Clinch Knot

An excellent general purpose knot for lines up to about 20 pound test. It has a knot strength of at least 95 percent, and is easy to learn.



Knot illustrations and instructions courtesy of DuPont Fishing Products Group

1. Pass line through eye of hook, swivel or lure. Double back and make five turns around the standing line. Hold coils in place; thread end of line around first loop above the eye, then through big loop as shown.
2. Hold tag end and standing line while coils are pulled up. Take care that coils are in spiral, not lapping over each other. Slide tight against eye. Clip tag end.

### Palomar Knot

Used for tying hooks, lures and swivels to the end of a line. It is generally not used for large plugs, and can't be used to tie a leader to a swivel on the mainline. It is perhaps easier to tie than the improved clinch knot, and offers 100 percent knot strength.

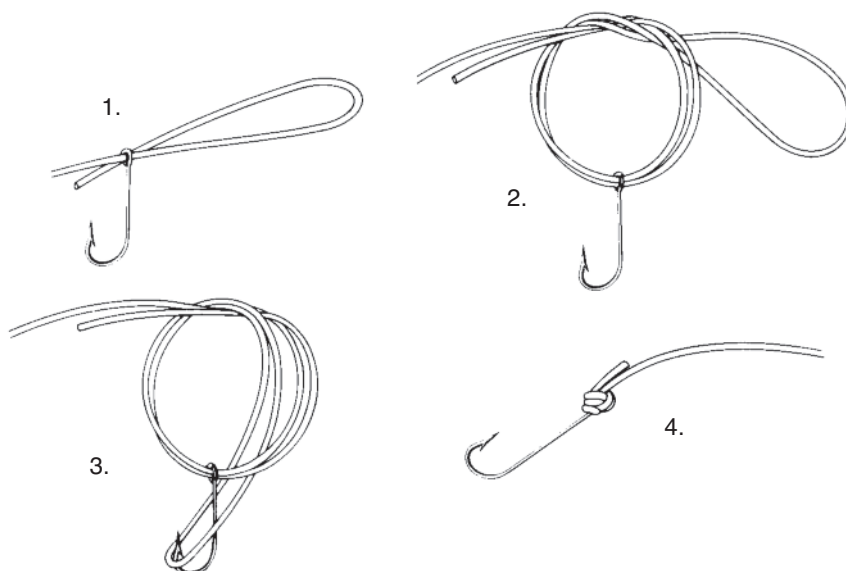

1. Double about four inches of line and pass loop through eye.
2. Let hook hang loose and tie overhand knot in doubled line. Avoid twisting the lines and don't tighten.
3. Pull loop of line far enough to pass it over hook, swivel or lure. Make sure loop passes completely over this attachment.
4. Pull both tag end and standing line to tighten. Clip tag end.

### Japan Knot

Used for tying line to hooks, and can be used with light line on up to about 40 pound test. It's a strong knot, and is a variation of the knot used on snelled hooks.

Pass tag end through eye of hook from the point side. Make a loop ("A") and wrap three or four times over line and shank of hook. Pass tag end through loop "A" and pull tight, then pull standing end tight. Trim tag end fairly close.

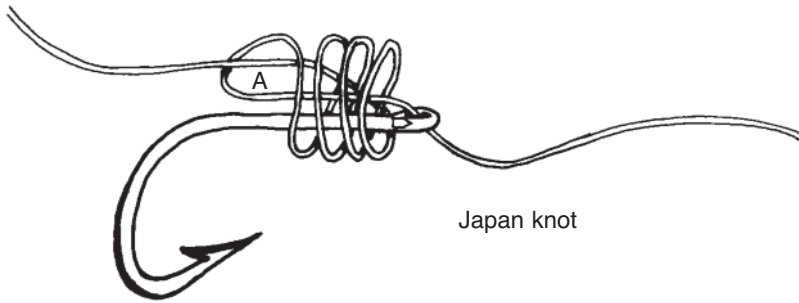

Japan knot

## Uni-Knot

An easy knot for tying to terminal tackle; variations are described later for tying line to a spool and for tying two lines together.

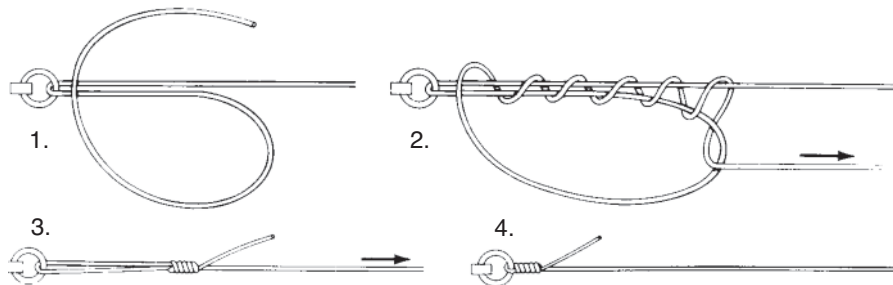

1. Run line through eye of hook, swivel or lure at least six inches and fold to make two parallel lines. Bring end of line back in a circle toward hook or lure.
2. Make six turns with tag end around the double line and through the circle. Hold double line at point where it passes through eye and pull tag end to snug up turns.
3. Now pull standing line to slide knot up against eye.
4. Continue pulling until knot is tight. Trim tag end flush with closest coil of knot.

## Tying line to line

### Surgeon's Knot

Used to splice two lines of different diameters, such as when tying a leader directly to the main-line. It has about 95 percent knot strength.

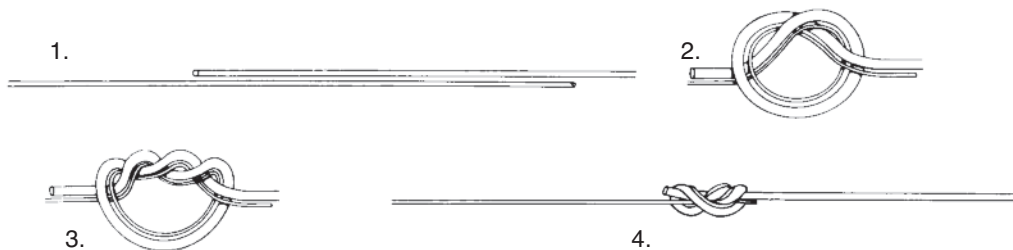

1. Lay line and leader parallel, overlapping six to eight inches.
2. Treating the two like a single line, tie an overhand knot, pulling the entire leader through the loop.
3. Leaving loop of the overhand open, pull both tag end of line and leader through again.
4. Hold both lines and both ends to pull knot tight. Clip ends close to avoid foul-up in rod guides.

### Blood Knot

Used to splice two lines of the same diameter, like when repairing a mainline after removing a "birdnest." Its knot strength is about 95 percent.

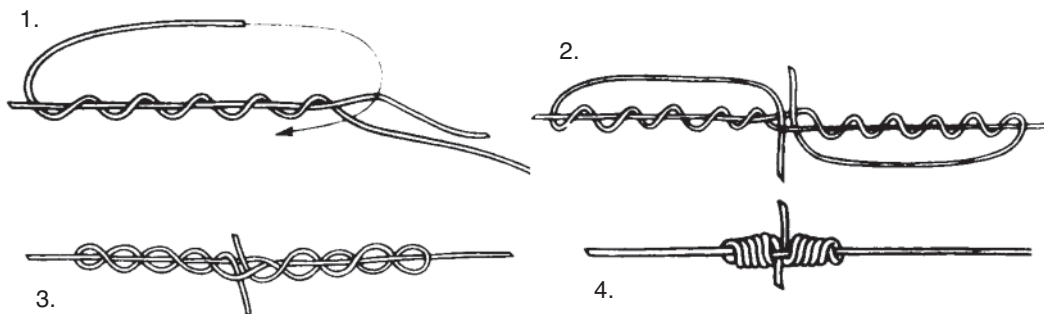

1. Lay ends of lines alongside each other, overlapping about six inches of line. Hold lines at midpoint; take five turns around standing line with tag end and bring end back between the two strands, where they are being held.
2. Hold this part of the knot in position while the other tag end is wound around the standing line in the opposite direction and also brought back between the strands. The two tag ends should protrude from the knot in opposite directions.
3. Pull up slowly on the two standing lines, taking care that the two ends do not back out of their positions; turns will gather into loops as they come together.
4. Pull turns up as tightly as possible and clip ends close to the knot.

### Uni-Knot Splice

Also used to splice two lines of the same diameter.

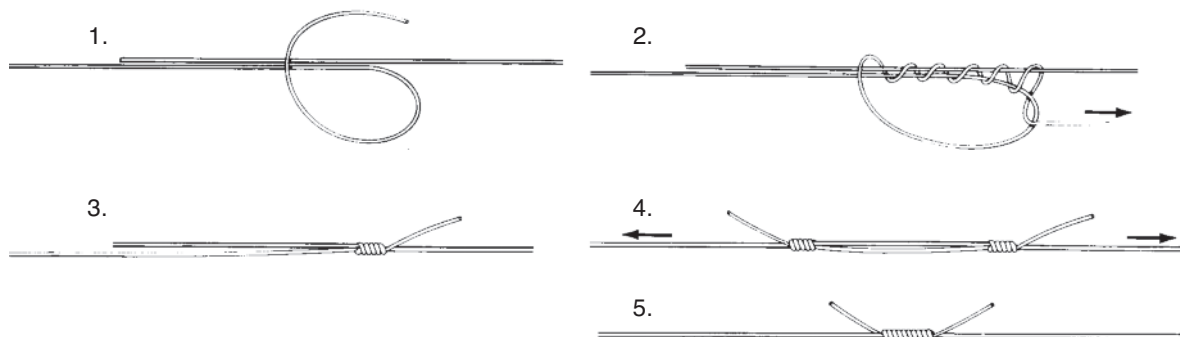



1. Overlap ends of two lines for about six inches. With one end, form Uni-Knot circle, crossing the two lines about midway of overlapped distance.
2. Tie basic Uni-Knot, making six turns around the two lines.
3. Pull tag end to snug knot tight around line.
4. Use loose end of overlapped line to tie another Uni-Knot and snug up.
5. Pull the two standing lines in opposite directions to slide knots together. Pull as tight as possible and snip ends close to nearest coil.

## Tying loops in line

### Surgeon's End Loop Knot

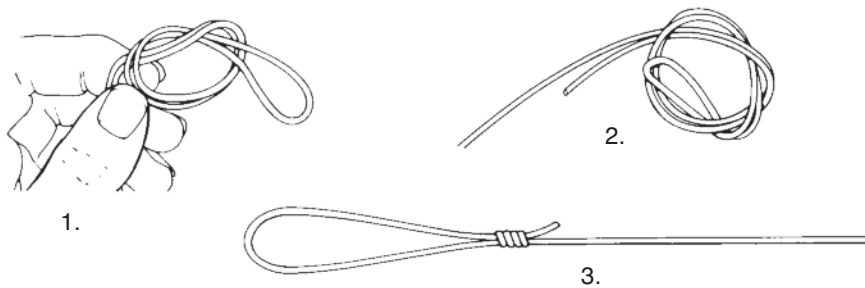

Provides a loop connection for attaching leaders or other terminal tackle.

1. Double end of line to form loop and tie an overhand knot at the base of double line.
2. Leave loop open in knot and bring doubled line through once more.
3. Hold standing line and tag end and pull loop to tighten knot. Size of loop can be determined by pulling loose knot to desired point and holding it while knot is tightened. Clip tag end.

### Dropper Loop Knot

Forms a loop at a right angle to the mainline or leader. It can be used in place of a three-way swivel for attaching sinkers or other rigs away from the line. It is not a particularly strong knot.

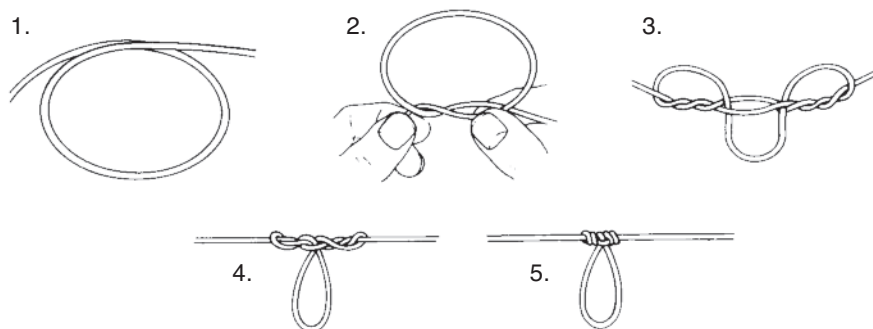

1. Form a loop in the line.
2. Pull one side of the loop down and begin taking turns with it around the standing line. Keep point where turns are made open so turns gather equally on each side.
3. After eight to ten turns, reach through center opening and pull remaining loop through. Keep finger in this loop so it will not spring back.
4. Hold loop with teeth and pull both ends of line, making turns gather on either side of loop.
5. Set knot by pulling lines as tightly as possible. Tightening coils will make loop stand out perpendicular to line.

## Tying line to spool

### Uni-Knot

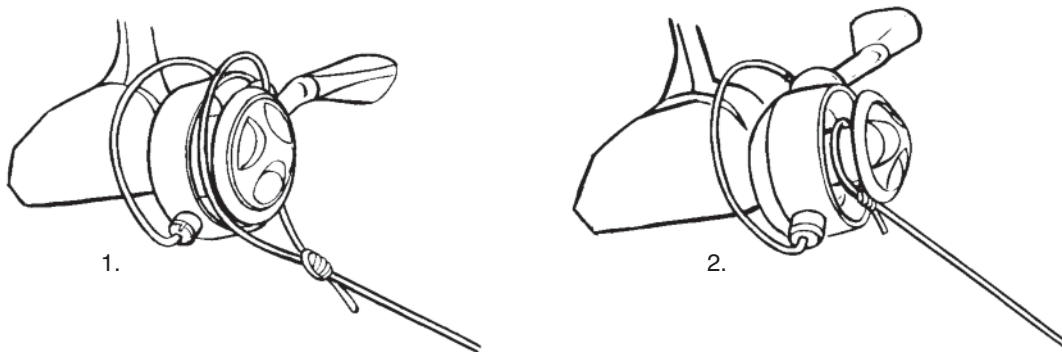

1. Tie loop in end of line with Uni-Knot; only three turns are needed. With bail of spinning reel open, slip loop over spool. (With conventional reel, line must be passed around spool before tying the Uni-Knot.)
2. Pull on line to tighten loop.

It's hard to tie a good knot in monofilament over about 50 pound test. The line isn't limp enough to make tight curves and you'll end up with spaces in the knot. With large line you'll need to use crimped metal sleeves, as described later in the section on leaders.

## Hooks

Parts of a fish hook

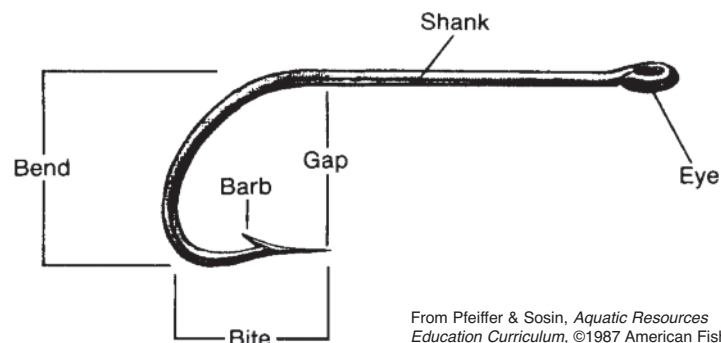

From Pfeiffer & Sosin, *Aquatic Resources Education Curriculum*, ©1987 American Fishing Tackle Manufacturers Association, reprinted by permission of Kendall/Hunt Publishing Co.

Hooks are available in hundreds of shapes, sizes and materials. Zinc coated hooks are best for salt water, and bronze hooks are popular for freshwater fishing. A few of the more commonly used types are shown here.

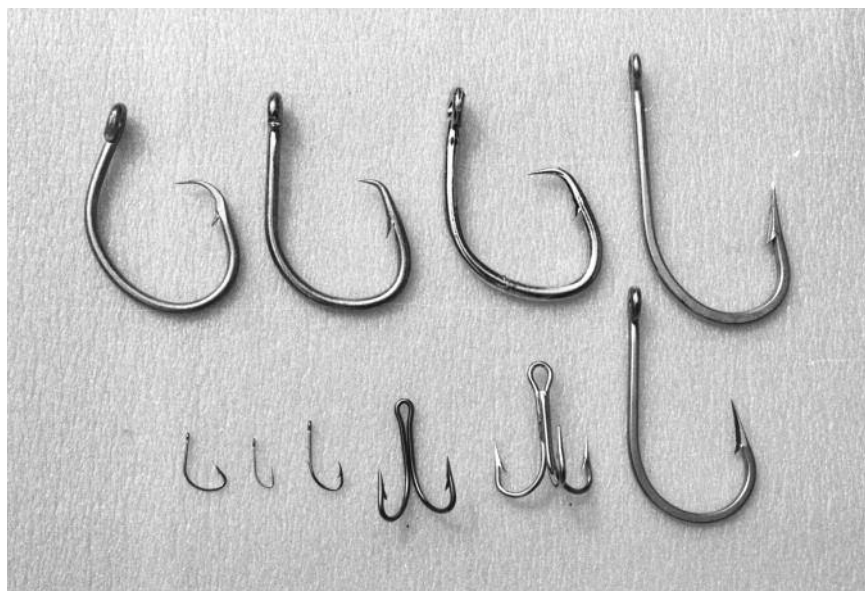

#### **Types of fish hooks**

*Top row (l to r):* Tuna circle, BKN, tankichi, Bait hook;  
*Bottom row (l to r):* MZ, Limerick, Bait holder, Double, Treble, Trolling

One reason there are so many types of hooks is because there is no single good all-around hook. Each design has its own advantages.

**Limerick** — A good hook for small fish, often used with live bait.

**AH, MZ** — Harder for fish to steal bait, or get off hook once set.

**Tankichi, BKN** — Point is bent in so hook won't hang up on rocks; hook virtually sets itself, and fish can't get off.

**Tuna circle** — Similar to BKN, used mostly for bottom fishing.

**Double, Treble (Star)** — Used mostly for lures; more hooks increase chances fish will get caught.

**Bait holder** — Barbs hold bait or plastic lure on shank.

**Bait hook** — Used mostly for slow trolling; point extends outward for easier setting.

**Trolling** — Large strong hooks for big fish, used with bait or lures.

Hook size is given by a number — the bigger the number, the smaller the hook. A no. 22 hook is very small. A no. 2 hook is quite a bit bigger. A no. 1 hook is not the biggest available - from there on hook sizes add a “/0”. The next size up from a no. 1 is a 1/0, then 2/0, 3/0, etc. on up to about 16/0. Tankichi and BKN hooks have their own size numbering system - a bigger number means a larger hook.

There is no uniform standard of hook measurement, which only adds to the confusion. The size number itself doesn't really mean anything, and two hooks of different styles that look like they're the same size might not be. It's pretty hard to tell a hook size just by looking at it until you get lots of practice.

Choosing a hook depends on your target fish. You can catch a big fish on a small hook, but you can't catch a small fish on a big hook. So you'll probably want to use the smallest hook you can get away with. A hook with a small diameter will penetrate easily, but pulling on it may cause the fish's mouth to “buttonhole” around the hook, increasing the chances of the hook coming out.

## Hook sizes

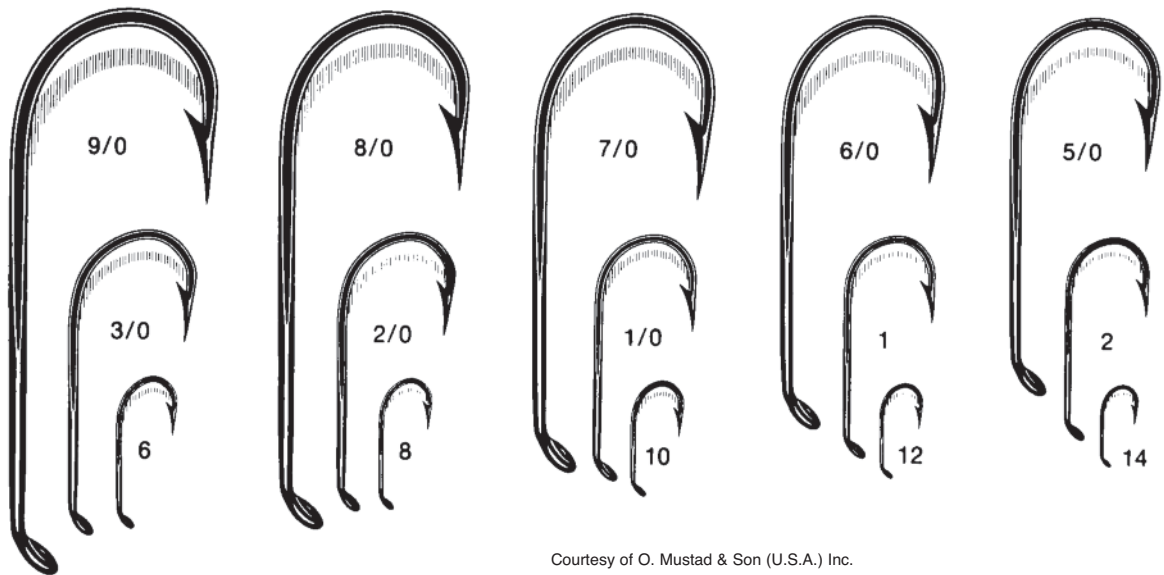

Courtesy of O. Mustad & Son (U.S.A.) Inc.

A hook with a short shank is easier to hide inside the bait, but a long shank might be preferred if the fish has sharp teeth that could bite through the leader.

The *barb* on a hook is designed to help keep the hook from backing out. If you want to catch and release your fish, a barbless hook will make releasing easier and reduce the chances of harming the fish. You can squeeze the barb flat with a pair of pliers.

It's important to keep your hook as sharp as possible. A dull hook is hard to set, but a sharp one penetrates easily. Carry a hook file or sharpening stone in your tackle box, and keep checking the point of your hook when you're fishing, especially if you're getting hung up on coral, rocks or other hard objects. With a hook file always move the file toward the point, and along the flat surfaces (if the hook is large enough to have them). Small battery-operated hook sharpeners are available, and work pretty well.

## Triangular Sharpening Method for Large Hooks



1. Flatten the outside edge of the point using a hook file, beginning with the barb and working toward the point.
2. File one side of the point, beginning at the barb. Remove enough metal so the side is flat and slanted toward the inside of the point.
3. Turn hook and file other side of the point in the same way. When complete, the point should be three-sided.

Courtesy of O. Mustad & Son (U.S.A.) Inc.



Sharpening a small hook

## Lures and Baits

---

The difference between a *lure* and a *bait* is that a lure is artificial, while a bait is natural (either alive or formerly alive). Lures are available in a large number of types, shapes and colors.

A lure is only as good as the angler fishing with it. Part of a lure's *action* (its motion in the water) comes from its design, but much of it is due to the way in which it's retrieved. To be effective a lure must attract attention and behave like something the fish wants to eat. But that's easier said than done. With practice, and by watching good anglers work lures effectively, you can learn how to use a lure with good success.

Selecting a lure is usually a matter of trial and error. A lure that works great one day might not produce any strikes at all the next. You'll want to change lure types and colors, and vary the action until you find the combination that works best. So have an assortment of lures on hand. Some basic types are shown below.



Plugs

*Plugs* are casting lures that resemble a small fish or other animal, and are made of wood, plastic or resin. There are surface and subsurface plugs, medium-running and deep-running plugs. Where a plug runs depends on its weight and shape. *Poppers* (or surface chuggers) are light weight and have a concave face, so that they make a “popping” sound on the surface as they're retrieved, attracting the attention of fish. Deeper running plugs are heavier, and have plastic or metal lips to make them dive as they're retrieved.



### Spoons



*Spoons* are curved tapered metal lures shaped somewhat like a spoon, and resemble small fish. As they are retrieved they wobble or flutter to attract attention.

### Jigs



*Jigs* are lures with a weighted head (usually lead), a solid fixed hook and a body or tail made of plastic, hair, feathers or other material. They are designed to bounce off the bottom with the hook upwards, minimizing the chances of a snag.

### Soft plastics



*Soft plastics* are strips or worm-shaped lures made, obviously, of plastic. (Other shapes, made to resemble frogs or eels, are used for freshwater fishing.) They can be attached to a jighead, as mentioned above, or just put on a regular hook. Soft plastics are available in a rainbow of colors. Some have glitter-like material inside, and some have phosphorescent additives which make them glow in the dark after being “charged” by a light. Soft plastics are very popular for shoreline whipping.



**Spinners** (*top row*) and **Spinnerbaits** (*bottom row*)

*Spinners* and *spinnerbaits* are used for freshwater fishing. A spinner has a thin blade that revolves around a wire shaft to attract attention. Spinnerbaits are used mostly for bass fishing, and are V-shaped with a body on one side and a blade on the other.



**Trolling lures**  
Trolling heads (*top*);  
assembled lure (*bottom*)

Different types of lures and baits are used for fast and slow trolling, as described in the next chapter. The lures pictured above are used in open water fast trolling for fish like aku and ‘ahi, mahimahi, marlin, ono and others. The trolling lure consists of a head made of metal and often resin, through which a line is passed and attached to a hook. A plastic “skirt” surrounds the hook. The head may have additional channel openings to churn up water and attract attention.

## Baits

As with lures, the type of bait you use will depend on your target fish. A bait must reflect the fish's natural diet. A fish that eats algae won't go after a crab. Some baits commonly used for small fish include shrimp, crab, bread and limu (algae). Larger fish go for octopus, eel, aku belly, ‘ōpelu and akule. In fresh water, earthworms and minnows are most commonly used.

## Hooking bait

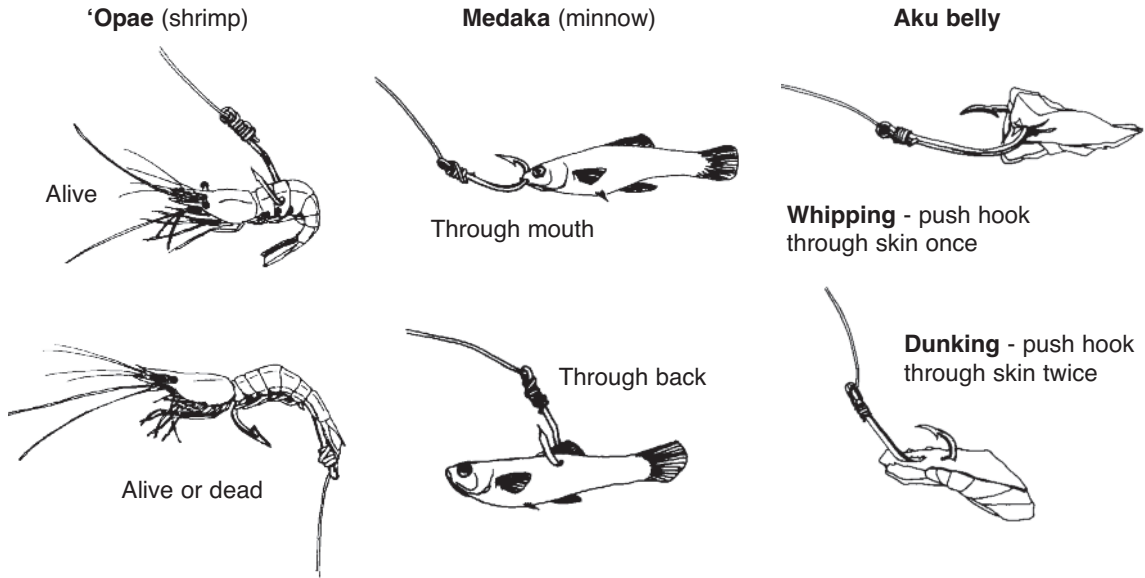

## Other Tackle

### Swivels and Snap Swivels

*Swivels* are used to connect your mainline to a leader. Their main function is to prevent your mainline from twisting due to the action of your lure or bait. A twisted mainline can cause some very disappointing tangles. A number of types of swivels are available, and used for different purposes. The following swivels are often used locally.

**Swivels**  
Top row (l to r): Ball bearing safety snap, Barrel snap, Barrel safety snap, Pigtail, Coastlock;  
Bottom row: Barrel, Three-way



**Barrel swivel** — The basic swivel type, used just to keep line from twisting.

**Ball bearing swivel** — Similar to barrel swivel, but better built for smoother action.

**Snap swivel** — Makes changing terminal tackle easier.

**Safety snap swivel** — Decreases chances of snap coming open under stress.

**Coastlock (French snap swivel)** — Used mostly for trolling, especially with larger lines; less likely to come apart under stress.

**Pigtail swivel** — Used mostly for trolling; easy to change terminal tackle.

**Three-way swivel** — Used mostly for dunking; allows two lines (leader and lead line) to be attached to mainline.

## Sinkers

*Sinkers* are used to add weight to your tackle, whether for casting, dunking or just holding bait below the surface. Some of the more commonly used types are described below.



### Sinkers

*Top row (l to r):* Pyramid, Bottom fishing lead;  
*Bottom row (l to r):* Split shot, Egg, Spoon, Walking, Torpedo, Bank, Wire bank

**Split shot** — Used with bamboo poles, and to keep leader submerged when using a floater.

**Egg sinker** — Used mostly for whipping; doesn't twist line, but will scratch it over time.

**Torpedo (ring) sinker** — Used mostly for whipping; goes through water fast, and should be used with a swivel.

**Spoon lead** — Used for slow whipping or dunking; goes down through water slowly so fish have more time to see bait.

**Walking sinker** — Used when slow drifting; designed to be dragged along bottom without hanging up on rocks, keeps bait above bottom.

**Bank sinker** — Used for dunking in rocky bottom areas.

**Wire bank sinker** — Used for slide-bait fishing; wires get caught on rocks, and may bend straight when pulled hard enough.

**Pyramid sinker** — Used for dunking in sandy bottom areas; digs under sand when set.

**Bottom fishing lead** — Diamond shape helps lead go down through water faster.



## Floaters

*Floaters* are made of wood or plastic, and are used mostly for bait fishing. They are attached directly to the line and float on the surface, so the bait is held at a constant distance below the surface. Floaters also provide weight for casting. The size of the floater should not be so small that it's pulled down by the weight of the bait and sinkers, but if it's too big it won't show much movement when a fish grabs at the bait. Some popular floater types are described below.

**Floaters**  
Top row (l to r): Plastic bobber, Wooden egg, Bubble, Lighted  
Bottom: Pencil



**Plastic bobber** — Used mostly with bamboo or telescopic poles; easy to put on any part of line.

**Wooden egg floater** — Multi-purpose floater that provides weight for casting, and has a popper side for whipping.

**Pencil floater** — Used mostly for mullet and small fish; more sensitive, easier to detect small bites.

**Plastic bubble floater** — Can be filled with water to vary weight; splashes to attract attention, but hard for fish to see.

**Lighted floater** — For night fishing.

## Leaders

*Leaders* are sections of line tied to the end of the mainline. The size of the leader depends on the target fish. You'll want to use a small diameter leader for the more finicky fish, since reducing the visibility of the leader often results in more strikes.

For the cruising predatory fishes you'll probably want to use a leader that's at least as heavy as your mainline, especially if there's a good chance the fish will try to hide among rocks or coral when hooked. In either case, it's good to make the leader as long as practical. A good rule of thumb is to make it about as long as your rod. If you're tying the leader directly to the mainline instead of using a swivel, you can make it quite a bit longer. The leader is the part of your line that will take the most abuse, so it's a good idea to check it frequently for abrasions, and change it whenever necessary.

## Wire Leaders

If you're after a fish with sharp teeth, such as kākū (barracuda) or ono, you'll need to use a wire leader. Otherwise the fish will bite its way right through your line. Cable wire, which consists of strands of wire twisted together, is generally used for this purpose. Needless to say, you can't tie knots in wire leaders. They are attached to the mainline with an endloop that is secured by a crimped metal sleeve.



One special type of leader assembly is the slide-bait rig, consisting of a slide buckle at one end and a hook at the other. The leader is usually made of wire, but heavy monofilament may be used. The entire rig is slid down the mainline, as described in the next chapter.

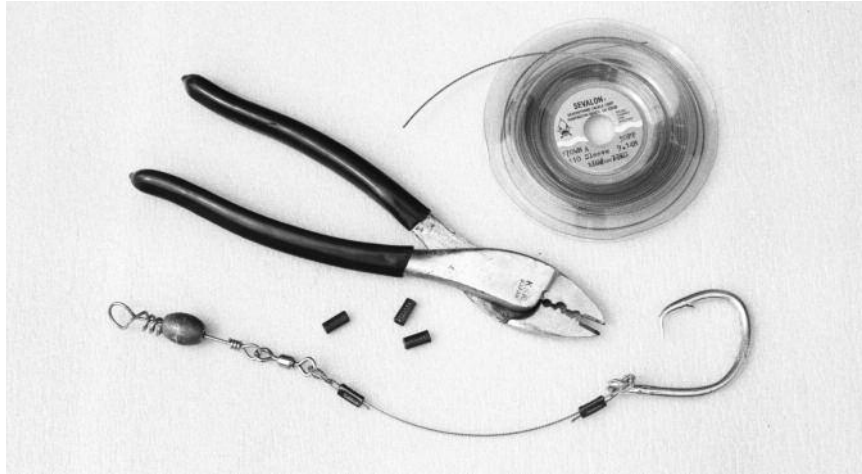

**A slide-bait rig**  
Crimping pliers, wire leader spool, sleeves, and completed rig

## Other Boat Angling Equipment

### Downriggers

A *downrigger* is used to take a lure or bait down to a specific depth, especially for bottomfishing. When a fish strikes, the line is pulled away from the weight of the rig, and the angler can play and reel in the fish. The downrigger is then pulled in separately. Downriggers are used for catching fish like kāhala, ulua, pāpio, ‘ahi, marlin, mahi and ono.

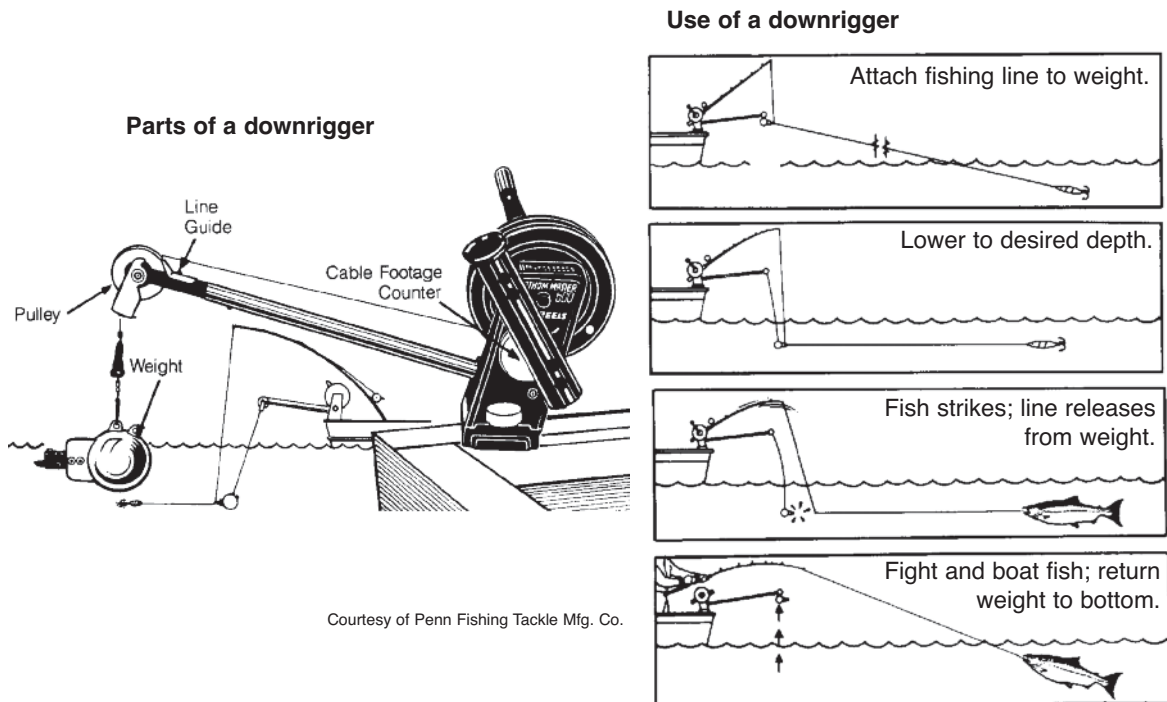

## Outriggers

*Outriggers* are devices used to get fishing lines out away from a boat. There are a couple of advantages to using outriggers. First, they give you room to get more lines in the water. Second, outriggers change the way bait is presented (for example, by keeping the line out of the water and the bait on the surface). A line known as a *stinger* is attached to a cleat on the boat, extends to the end of the outrigger and is attached (by a rubber band or clip) to the mainline of a trolling rod and reel. When a fish strikes, the mainline is pulled away from the stinger, and the fight is on.

### Using an outrigger

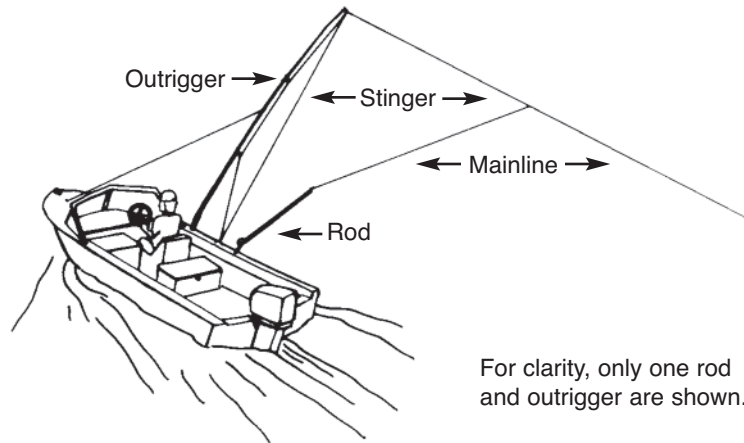

---

## Other Tackle

A *tackle box* is a must for keeping your tackle organized. In general you should use the smallest tackle box you can get away with, just big enough to carry what you need for an average fishing expedition. As you accumulate more tackle, you'll probably want to get another bigger tackle box for storage purposes, but continue to use the small one for fishing trips. Carrying around a big heavy tackle box can get exhausting, and is unnecessary if you'll only end up using a fraction of what's inside. So plan your fishing trip well, and take along only what you need.

### A tackle box and contents



You won't see too many metal tackle boxes in Hawai'i, since saltwater will take a quick toll on them. Get a plastic box with one or two trays, and make sure the lid overlaps the bottom so water doesn't run inside. Also get a small plastic box (with compartments) that will fit inside the bottom of your tackle box. The small box will be used for storing hooks and swivels. Put in whatever sizes you'll need for that day's fishing.

A well stocked tackle box should include a pair of fishing pliers, nail clippers (for cutting line), a hook sharpener, knife (for cutting bait), spools of line of several appropriate sizes, floats and sinkers (whatever type might be needed that day), and various types of lures. It's also a good idea to include a spare bail spring and whatever screwdrivers or wrenches you would need if your reel breaks down. Finally, to make sure you're prepared for just about anything, stash a few quarters in your tackle box for emergency phone calls.

# FISHING METHODS AND TECHNIQUES

In this chapter we'll give a brief overview of ways to catch fish in Hawai'i. When it comes to technique, there is no substitute for experience. Fishing is a learned skill — you learn from your mistakes and your successes, but mostly from other fishermen who know what they're doing. In addition, there are some excellent books and periodicals available which describe in detail methods and techniques for catching Hawai'i's gamefish. These references are listed at the end of this book.

No matter what fishing methods you use, it's important that you fish legally. There are regulations on seasons, minimum sizes, bag limits, mesh sizes for nets of all types, gear restrictions for some species and for certain areas, and other regulations, all designed to help protect fish populations and other aquatic life. The reasoning behind these regulations is discussed in a later chapter. One important piece of “fishing gear” you should always have handy is a current copy of the *Hawai'i Fishing Regulations* booklet.

## Angling Methods

### Whipping

*Whipping* is done almost exclusively with spinning reels, and involves repeatedly casting a lure or bait into the water and retrieving it. Whipping is done from shore or a boat. A basic whipping rig would include a leader that's as long as practical attached to the mainline by a snap swivel, and a soft plastic or popper at the other end. A sinker may be added at or above the swivel to provide weight for casting.

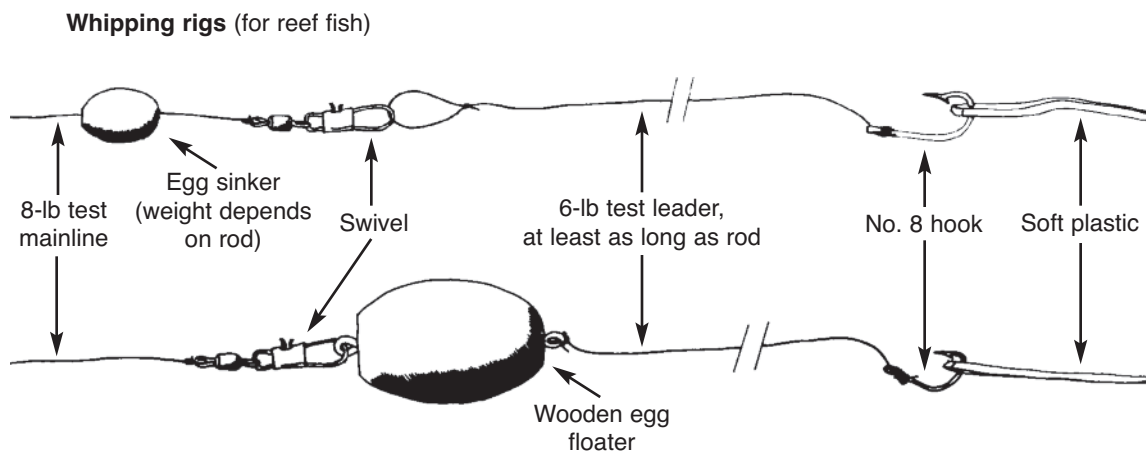

As always, the size of the mainline, leader, lure or bait and hook will depend on what you're trying to catch. When whipping shallow water a floater is often attached to the swivel (no sinkers are used) to avoid snagging the bottom. Adding a floater to a whipping rig also helps attract attention by popping in the water ahead of the lure. Whipping is effective for predatory fishes like pāpio, āholehole, lai and kākū.

## Floating

*Floating* involves suspending a bait a certain distance below the surface. A floater is attached to the mainline, usually by a snap swivel, and a leader of the desired length is attached to the swivel or floater. A split shot may be added to keep the bait down. The split shot would be omitted if you want the bait to stay at the surface (like bread). In this case the floater serves mostly to add weight for casting. You should remove as much slack from the line as possible so you can set the hook more easily. Floating is effective with various reef fishes.

Floating rig (for reef fish)

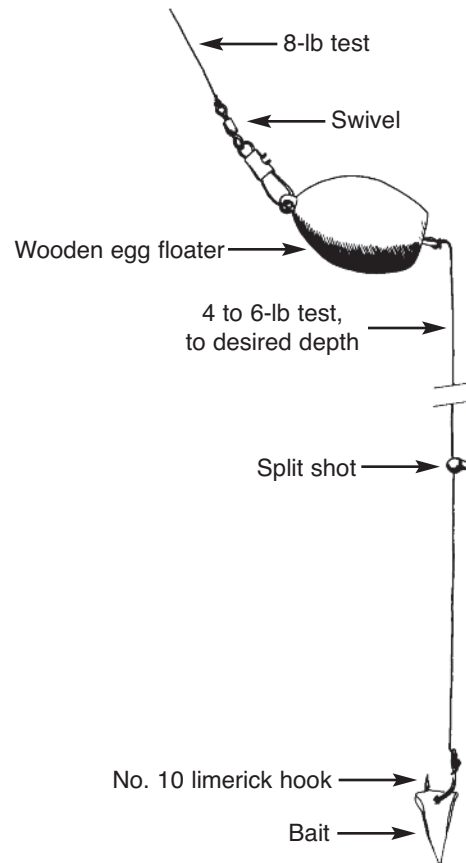

## Dunking

*Dunking* involves putting a bait on or near the bottom. Typically, two lines are attached to the mainline. One line, the leader, is fastened to the hook and bait. The other, the anchorline, is attached to a lead sinker. The anchorline is usually longer than the leader, and has less line strength. The rig is cast out, then slowly reeled in until the sinker catches on something. Because the leader is shorter than the anchorline, the baited hook is suspended just above the bottom. The line must be kept tight with no slack. When a fish strikes and you pull to set the hook, the anchorline will break or pull free and you proceed to fight the fish.

Dunking rig (for reef fish)

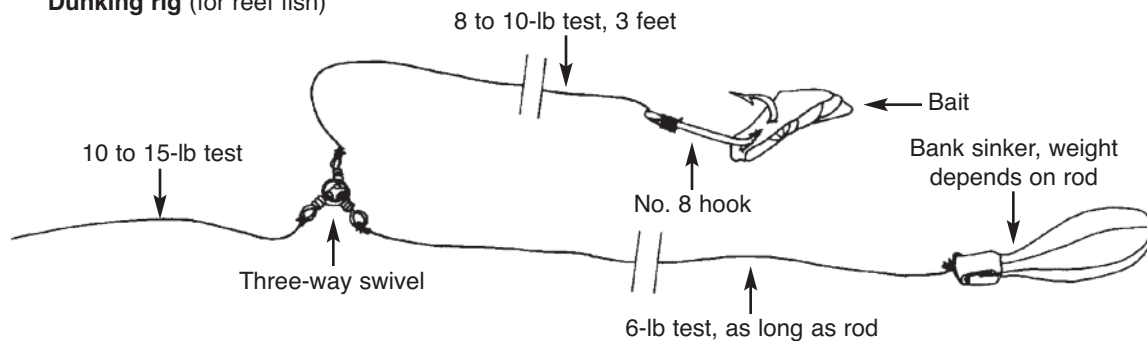

If you just want to lay the bait on the bottom you can get by with the type of rig described above for whipping, with just a sinker above the swivel and a baited hook at the end of a leader. Dunking works well for bottom feeding fishes such as goatfish, 'ō'io and ta'ape.

## Slide-bait Fishing

*Slide-bait fishing* might be considered a special type of dunking. It is done from cliffs using large surfcasting reels and long rods. A line is cast out with a lead weight on an anchorline. Between the anchorline and the mainline is a stop ring assembly. Once the lead is anchored to the bottom, a rig with a sliding swivel and baited hook is slid down the mainline until it gets to the stop ring.



You want the bait suspended high enough above the bottom so moray eels aren't immediately attracted to it. An anchorline of about ten feet usually does the trick. When a fish strikes, pulling on the rod sets the hook and breaks the anchorline. Slide-bait fishing is the most popular method for catching ulua.

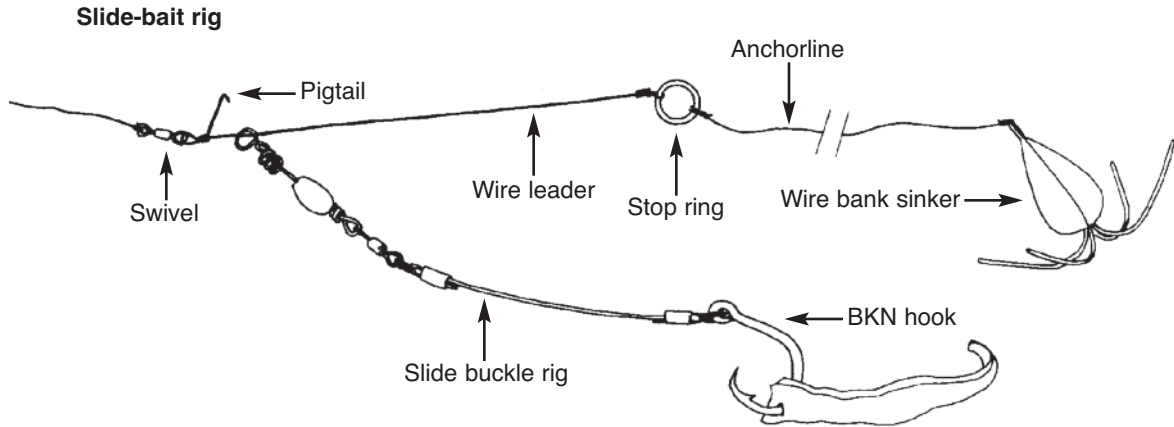

## Trolling

*Trolling* involves trailing a lure or bait behind a moving boat. The bait or lure may be run straight off a rod and reel, or a downrigger or outrigger may be used as described in the previous chapter. Trolling is done inshore for fish like pāpio; deepsea trolling targets fish like marlin, ‘ahi, ono and mahi. Inshore trolling is done slowly, using bait such as ika strips and aku belly, or surface poppers and other small lures. Deep sea trolling is done at higher speeds with heavier tackle. Trolling heads with squid skirts are used as lures, or fish may be used as bait.

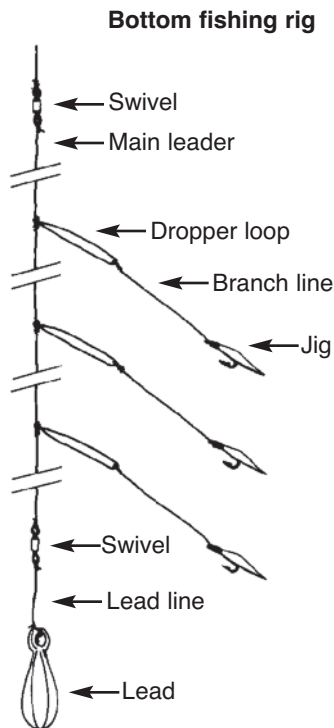

## Bottom Fishing

*Bottom fishing* is done in shallow water for species like goatfish or pāpio, or in deep water for kāhala or ‘ōpakapaka and other deepwater snappers. The basic rig consists of a main leader with several hook leaders (or *branch lines*) and a lead line attached. The branch lines may be attached with three-way swivels or tied to loops in the main leader. The mainline may be a handline or on a reel, and should be stronger than the branch and lead lines.

## Jigging

*Jigging* is an angling technique that involves retrieving a lure in short hops to simulate the motion of natural bait. The lure is cast or lowered into the water and allowed to sink to some desired depth. The erratic motion of the retrieve attracts fish. Since the term “jigging” refers to the retrieve, the technique can be used in combination with different angling methods. Jigging with handline or rod and reel is popular (and effective) when fishing the FAD buoys. Deep-water jigging is used for catching bottom fish. Trollers also jig to vary the speed of the lure.

## Handline Fishing

*Handlining* refers more to a type of gear than a method of angling. Handlines are used from boats; a line is wrapped around a rack or stored in a box or other container. (Even when the line is stored on an electric reel the gear is referred to as “handline.”) The end of the line is rigged with a series of hooks or jigs. Either bait or lures may be used on the hooks. The way the gear is rigged (including the number of hooks used) depends on the target fish.

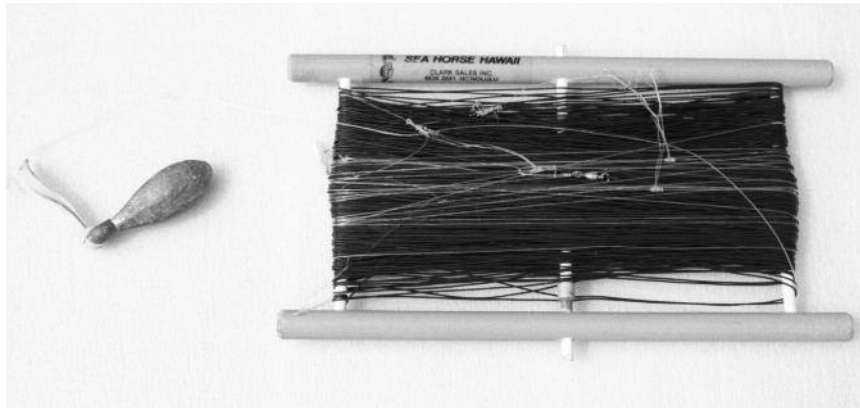

A handline

---

## Basic Angling Techniques

### Chumming

*Chum* is a substance thrown into the water to attract fish. Usually it consists of chopped or ground up fish, something that resembles your target fish's natural diet. Dough or bread may be added to give the chum a more desirable consistency.

Chumming is used to bring fish around to your hook. If fish are not seen, or don't seem to be biting, chumming often makes a big difference. However, there's a line between chumming and feeding. Throwing in too much chum may cause the fish to lose interest in your bait.

### Presentation and Retrieval

In order to get a fish interested in your lure or bait, it must be presented right. The lure or bait should appear as natural as possible. For example, when using bread as bait it's a good idea to leave some fluff in it so it floats on the surface. You'll also want to hide the hook as much as possible, but the point shouldn't be so well covered that it's difficult to set. If a fish senses anything unnatural about the way a lure or bait is presented it will probably not bite.

When retrieving a bait do it slowly enough so fish have a chance to check it out. Let the bait move or drift naturally so it looks like an easy meal. With a lure you want to retrieve faster so the fish has to take a strike at it. If you give a fish time to investigate your lure too closely it won't take long for the fish to realize something's wrong.

*Action* is an important part of lure retrieval. The lure must behave like prey, preferably wounded prey. Giving the lure some erratic movement will attract attention. As mentioned earlier, if you aren't getting strikes vary the action. Or try a different color or type of lure. If fish are around, you'll eventually find a combination that works.

In a way, how you approach fish can be considered part of presentation. If you're on the shore-line, keep a low profile and try not to do anything that would attract a fish's attention to you (they can see out of the water well enough to know you're there). In a boat, avoid dragging tackle boxes along the hull, stomping your feet or doing other things that would transmit noise through the hull and into the water.

## Setting the Hook

How a fish strikes depends on its feeding style. Some fish are nibblers and some are chompers. With practice you'll learn how different fish behave around a hook. Once you think your hook is inside a fish's mouth you must set it by pulling back on the rod to force the hook into the fish's jaw. Timing is everything - if you pull too soon the hook will just be pulled away from the fish; wait too long and your bait may be history. If the fish has a soft mouth (such as 'ōpelu) you can't pull too hard or you'll tear the hook out through its mouth.

## Fighting the Fish

Once the hook is set your fish will run, and that's when the fun starts. Your drag should be set loose enough so the fish can run, but tight enough to keep tension on the line. The drag tension will eventually tire the fish out. Keep your rod tip slightly up while the fish runs, and as it slows down reel it in. Pull the fish toward you by pulling your rod back, then reel as you lower it again. Bringing the fish in involves pumping the rod in this manner, keeping tension on the line at all times. If the fish runs toward you (as 'ō'io often do) reel in line as fast as possible. Slack line always increases the chances of the hook coming out.



## Landing the Fish

How you get the fish out of the water depends on its size and your line strength. Small fish can just be pulled out with your line. Larger fish should be led headfirst into a landing net. Really big fish will need to be gaffed. If you're landing a fish (especially a big fish) in surf, make use of the incoming surge to help you get the fish as close to shore as possible. If you can't land the fish on the first try, wait for the next wave.

## What Next?

By the time you bring a fish in you should have made plans about what to do with it. If you intend to eat it, remove the hook and put the fish on ice as quickly as possible. (Cleaning fish is described at the end of this chapter.) **Keep only fish that you need, and that are of legal size. If the fish is undersized, or you don't want to eat it, let it go — carefully.**

To release a fish, keep it in the water as much as possible and handle it gently. Remove the hook quickly with pliers; if the fish has swallowed the hook cut the line — the hook will eventually be dissolved by the fish's digestive juices. If the fish is unconscious hold it upright in the water and move it back and forth to force water over its gills. Don't hold the fish by its eye sockets, since blindness or death may result. Releasing fish carefully will allow the fish to grow, reproduce and live to fight again.

## Other Fishing Methods

---

### Spear Fishing

Several types of spears are used for fishing in Hawai'i. The most popular is the "Hawaiian sling," which consists of a fiberglass, aluminum or graphite composite shaft with a three-pronged spear at one end and a loop of surgical tubing at the other. The tubing is used to propel the spear. Spear guns, including arbaletes (rubber powered) and pneumatics (air propelled), are more powerful and effective with fast moving fish.



**Spears** (top to bottom):  
"Hawaiian sling,"  
arbalete, pneumatic

The advantage of spear fishing is that you can see the fish. Once the fish is speared it is generally put on a stringer and towed a comfortable (and safe) distance behind the fisherman. Fish targeted by spear fishers include manini and other surgeonfish, uhu, goatfish and menpachi. Advanced spear fishers will target ulua and large blue water fishes.

### Throw Nets

*Throw nets* are circular nets with lead weights around the edge. They are thrown over and around a school of fish. The fisherman then gathers up the bottom of the net to trap the fish (some throw nets have a drawstring to pull the bottom shut). Learning to throw a net takes a great deal of practice. Throw nets are used for inshore schooling fishes such as moi, kala, manini, 'ama'ama and uouoa.

### Use of a thrownet



## Gill Nets

Also known as *lay nets*, *gill nets* are designed to snare fish by their gills. Gill nets are usually about four to six feet high with floats on the upper edge and lead weights on the lower. They may be a hundred or more feet long, and are generally set perpendicular to shore in the late afternoon or evening, often in reef channel areas, then pulled in the next morning. Fish commonly targeted by gill net fishers include moi, mullet, 'omaka, weke and pāpio. From a conservation point of view, a disadvantage of using gill nets is that they are not selective in the fish they catch. Fish are often caught that the fisherman doesn't want, and are essentially just wasted.

### Fish caught in a gill net

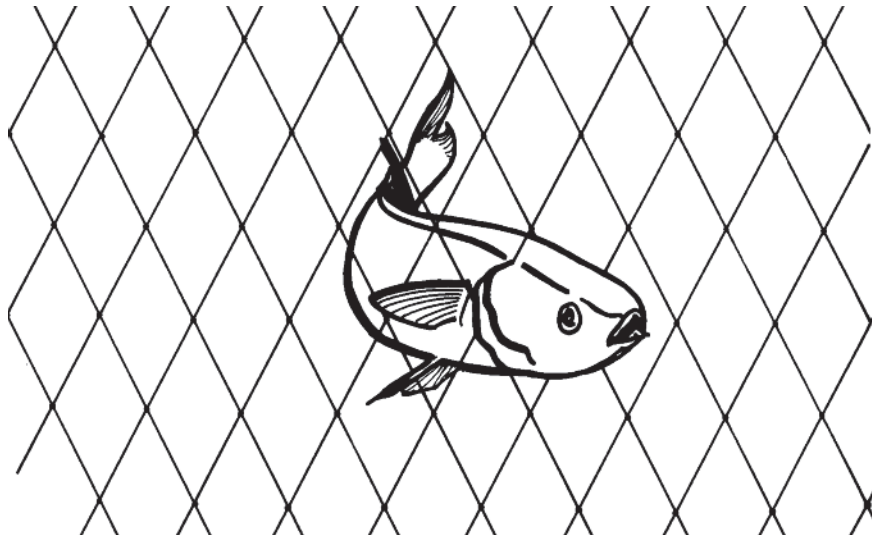

## Torch Fishing

This type of fishing is done on the reef on calm dark nights at low tide. Carrying a lantern, flashlight or other light source, the fisherman walks along the reef looking for fish or octopus, which are taken by spear or with scoop nets, or sometimes with a small throw net. Target species include lobster and fish that “sleep” at night, such as goatfish, uhu and some surgeonfish. (Lobster cannot be speared, and nets have to be of legal mesh size.)



## Cleaning a Fish

There are probably as many ways to clean a fish as there are fishermen. Everybody has his/her own technique. Following the steps outlined below will give you a fish ready to cook. But as with everything else in fishing, you learn the most by watching people who know what they're doing, then practicing until you get it right. Filleting and cleaning large fish are not described in this book, but those procedures are described in other local books on fishing (see references on inside back cover).

**Cleaning a fish** (*below*): 1) Scale the fish, being careful not to cut the skin; 2) With a sharp knife, make a cut from the vent (anus) to the jaw; 3) Cut through the gill region as necessary to remove the gills; 4) Take out the gills and internal organs; 5) Scrape away the kidney (dark area along backbone), and remove any other tissues remaining in the body cavity; 6) The cleaned fish.

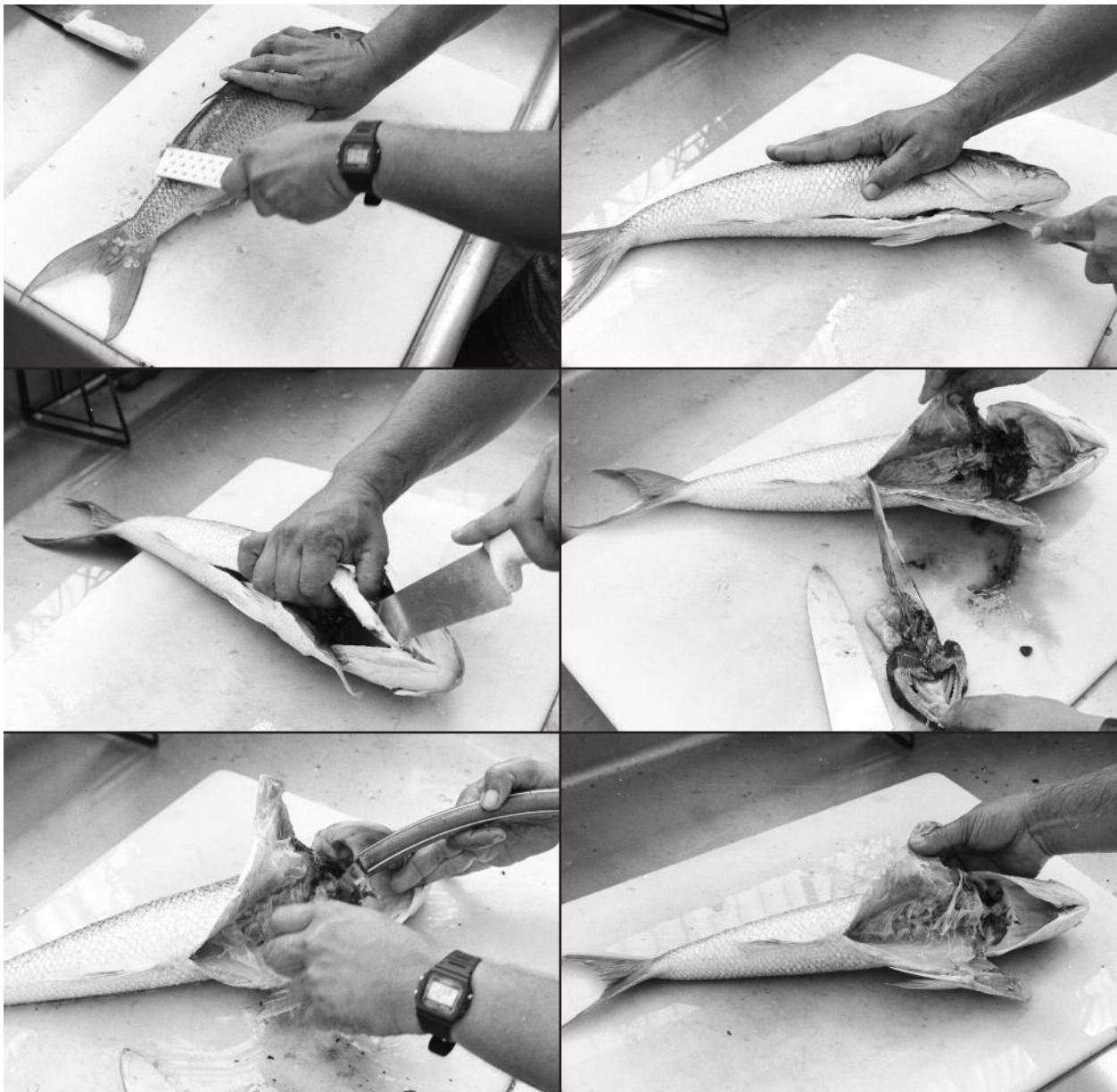

Another way to clean a fish is to *butterfly* it, which involves slicing the fish down the middle and opening it up. Butterflying is done with smaller fishes (akule, ta'ape, weke, etc.) when you want to dry and salt the fish.

**To butterfly a fish (below):** 1) Scale the fish (if scales are small use the edge of a knife), remove scutes if present; 2) Beginning near the tail, make a cut through the back of the fish as deep as the backbone; 3) Continue the cut to the anterior end of the fish, cutting through the bones of the skull; 4) Place the blade along one side of the backbone and continue the cut through the rest of the fish; 5) Remove the internal organs and clean out any remaining tissue; 6) The finished product.

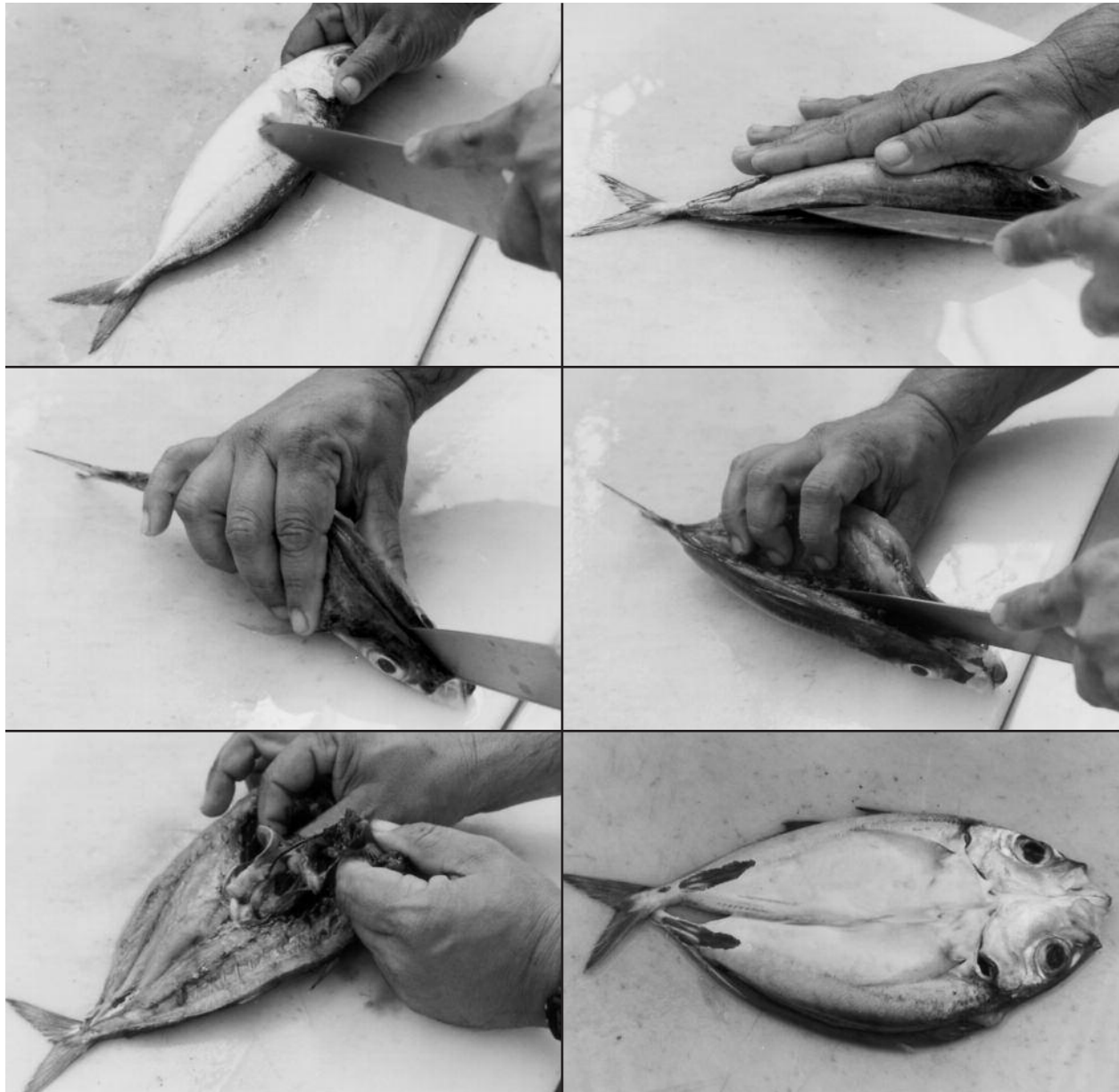

# FISHING SAFETY

---

Fishing is one of the safest outdoor sports, but the fishing environment has its share of hazards. Sun, surf, dropoffs, weather, marine life, fish hooks and other factors need to be considered at all times. By using common sense you can avoid accidents and keep the fun in fishing.

## Dealing With the Sun

---

Whether fishing from shore or a boat, you'll risk sunburn even on cloudy days. To reduce the risk you need to dress properly. Wearing a baseball cap will keep the sun off your nose and face. Although you may want to work on a stunning tan, you should keep a shirt on especially during the peak sun hours. Use a sunscreen with a sun protection factor (SPF) of at least 15.

Polarized sunglasses that filter out ultraviolet (UV) radiation are a great idea for several reasons — the UV filtering will protect your eyes from sun damage, the polarization will help you see through the water's surface to make fish more visible, and the protection of having something in front of your eyes will keep them safe from flying hooks and other objects.

## Shoreline Safety

---

Before fishing from the shoreline or a boat you should check the current weather conditions and forecast, and consult a tide calendar so you know what the water level will be doing. Be sure to take into consideration the time adjustments for the tide at the area you'll be fishing — all tide calendars have a table with that information.

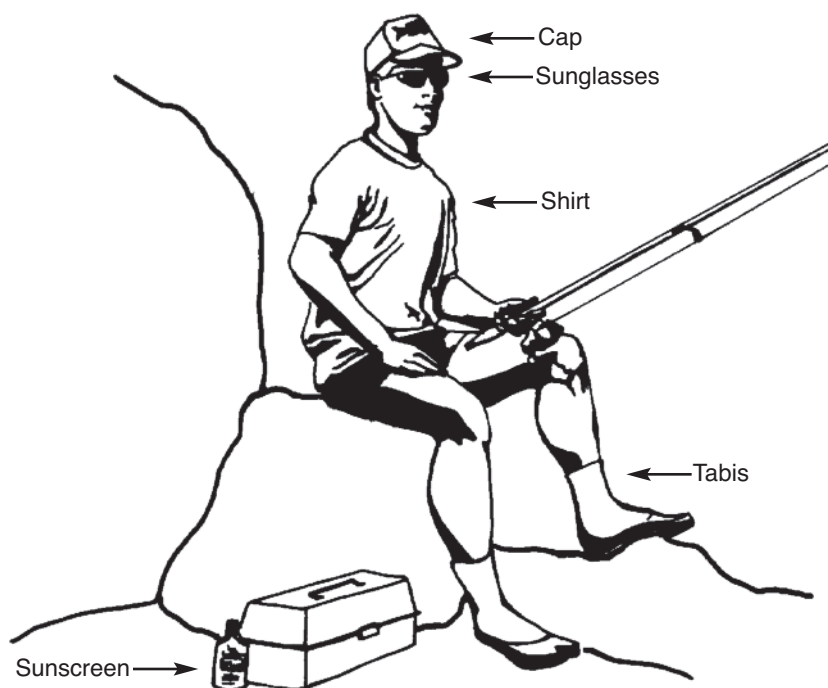

The well-dressed angler

If you're fishing from a rocky shoreline or walking around on the reef be sure to wear the right kind of footwear. Tabis are an excellent choice — they're inexpensive and provide good protection from slipping on wet rocks and against fairly sharp objects on the reef. Old sneakers would be a good second choice, but slippers (zoris) should not be worn because they come off too easily. Check the rocks for wet areas to give you an idea of where the waves are hitting, and stay away from places where you might get pounded by waves. Also look for wet areas from freshwater runoff; these places will often have algae growing which makes the rocks extremely slippery.

It's a good idea to watch the waves for about fifteen minutes or so to get a feel for the wave action. Waves come in sets, and although there may be small waves when you arrive at the scene, a big set may come in a few minutes later. Be aware that surf conditions can change quickly, and that waves generally increase in size as the tide comes in.

Perhaps the most important thing to remember when doing anything at the water's edge is never turn your back on the waves. It's interesting to note that the most deadly marine animal is the lowly 'opihī — more people have drowned picking 'opihī than have died at the “hands” of any other sea creature, simply because they weren't careful about the waves.

Always try to fish with a friend. When fishing from a rocky shoreline it's good to take along a yellow floating rope about fifty feet long. If your fishing buddy happens to end up in the water for any reason you can throw the rope out to him (or her). Tossing out an empty cooler is another possibility — it will provide some flotation until the person can get back to shore.

If you end up in the water you need to be aware of currents, especially rip currents that move water out to sea. Never try to swim against a rip current (nobody can swim faster than a current), but instead swim parallel to shore until you're out of the current, and then swim back in. If you can't swim you should learn how before you spend much time near the ocean.

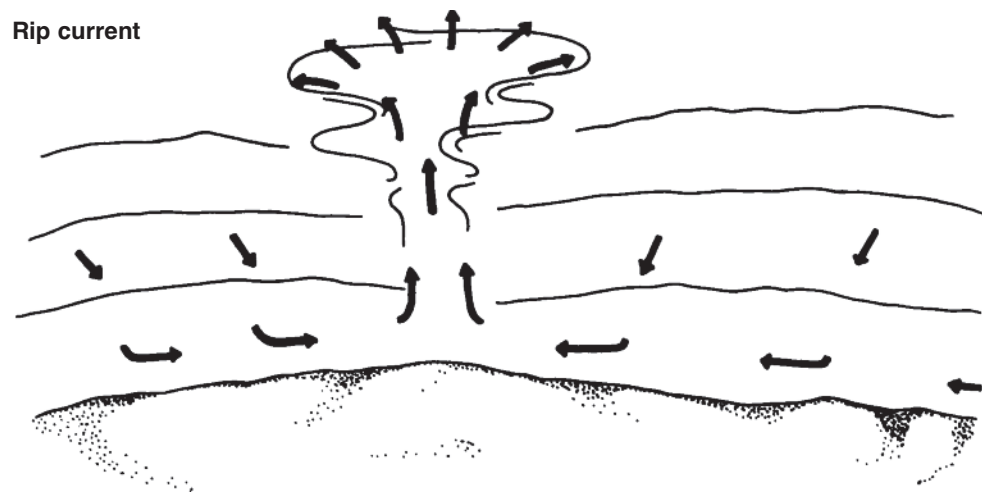

---

## Boating Safety

A boat gives you access to many more fishing areas than the shoreline. Operating a boat, though, is at least as complicated as driving a car, with the additional problem of having the “road” always moving under you. When you fish from a boat you have some added safety concerns. One good way to prepare for boat fishing is to take a free U.S. Coast Guard Auxiliary Boating Skills and Seamanship course.

## Weather

Before going out on any boating trip, the first thing you should do is check the current weather conditions and forecast, including wind and sea information. The National Weather Service has a phone number for recorded forecasts (see your white pages in the U.S. Government section). You can also keep up with weather conditions by listening to the continuous NOAA Weather Radio broadcasts at frequencies of 162.55 MHz or 162.40 MHz. While out on the water check these broadcasts often.

Getting caught in a storm is one of the worst things that can happen to you out on the water, which is why it's so important to be aware of weather conditions. At the first sign of foul weather, put on life preservers and head for shore immediately.

If you can't get off the water before a storm hits, slow your boat down, turn it at about a 45 degree angle to the seas and ride over the waves. Don't point the boat away from the seas, since waves can come crashing over the transom, especially if you lose power. If the water is shallow enough, anchor the boat with a long rope and heavy anchor. If you lose power, it's best to get your bow into the wind by tying on a sea anchor or anything that floats and causes drag.

## The Float Plan

It's good practice to file a *float plan* for any boat trip, much like a flight plan for an airplane. The float plan is just a common sense list of information you give to someone who will take action if you are overdue from a fishing trip. A float plan could save your life because someone on shore knows the description of your boat, the people aboard, your course on the water, destination and estimated return time. The float plan, which can be verbal but is better written, can be left with a family member or friend with instructions to notify authorities if necessary. A sample float plan is shown below.

| FLOAT PLAN   |                  |
|--|------------------|
| Description of Boat:                               | _____            |
| Boat number and/or name:                           | _____            |
| Size _____   | Horsepower _____ |
| Make _____   | Fuel: Gas _____  |
| Capacity _____                                     | Diesel _____     |
| No. Engine _____                                   | Capacity _____   |
| Number of persons aboard:                          | _____            |
| Names and Addresses:                               | _____            |
| First Aid Kit On Board?                            | _____            |
| Radio Equipment _____                              |                  |
| From _____   | To _____         |
| Departure time _____                               |                  |
| Estimated time of arrival _____                    |                  |
| Automobile parked at _____                         |                  |
| Registration Number _____                          |                  |
| I will advise of trip progress:                    | _____            |
| If not at destination by _____ (time) _____ (day), |                  |
| please notify: _____                               |                  |
| _____ and advise                                   |                  |
| of this plan.                                      |                  |
| Signed, _____                                      |                  |
| In Emergency contact Coast Guard at _____ or       |                  |
| local law enforcement officer at _____.            |                  |

Courtesy of the National Safe Boating Council



## Boat Gear

There are minimum boating safety gear requirements under Federal and State laws. Good sources of information are the free Coast Guard brochure “Federal Requirements for Recreational Boats” and the State of Hawai‘i Harbors Division’s “What Everyone Should Know About Boating Safety.” Here is a checklist of basic boating safety gear:

- |  |   |
|--|---|
| <input type="checkbox"/> Personal Flotation Devices* | <input type="checkbox"/> Fire Extinguisher*                               |
| <input type="checkbox"/> Distress Flares*            | <input type="checkbox"/> Whistle or Horn*                                 |
| <input type="checkbox"/> Compass and Nautical Charts | <input type="checkbox"/> Paddles or Oars                                  |
| <input type="checkbox"/> First Aid Kit               | <input type="checkbox"/> Anchor and Anchor Line                           |
| <input type="checkbox"/> Bilge Pump                  | <input type="checkbox"/> Extra Line                                       |
| <input type="checkbox"/> Radio                       | <input type="checkbox"/> Flashlight                                       |
| <input type="checkbox"/> Basic Tool Kit              | <input type="checkbox"/> Flame Arrestor<br>(required for inboard engines) |

\*Required by Federal Law

The above list is a minimum for safety gear. You will probably add more gear to make your fishing trip safe, comfortable and enjoyable.

## Fire Prevention

Fire at sea is a boater's nightmare. If your boat catches fire you will have to handle it yourself. Practice fire procedures, and let new people on the boat know where firefighting gear is located.

Most boat fires are caused by improper fueling practices, but many others are the result of electrical short circuits in faulty wiring. Here are some boating fire prevention tips:

- Use fireproof materials for interior decorating.
- Keep bilges free of oil, gasoline and rags.
- Carry gasoline for outboard boats in acceptable safety containers only, and never store below deck.
- Use approved alcohol or kerosene in pressure stoves for cooking. Never use gasoline or gravity-fed stoves.
- Carry approved fire extinguishers and check them frequently.
- Never fuel at night except under well-lighted conditions.
- Patronize safety-conscious fueling stations.
- Remove portable fuel tanks from boat for refueling. Permanently installed tanks should be fueled only after shutting down all engines, fans and motors, and closing all hatches and doors. Ventilate after fueling and before starting the engine.

## Rules of the Road

There are some basic “rules of the road” on the water, developed over the years through common sense and courtesy. For example, the boat on your right usually has the right-of-way, and you must take action to avoid the other vessel. If you are overtaking another boat it is your responsibility to watch out for that boat. In addition to knowing the rules of the road, you should be familiar with aids to navigation (buoys, lights and shapes). You can get more information from the free Coast Guard and Harbors Division publications mentioned earlier, and through a Coast Guard Boating Safety class.

## Getting Help

If you find yourself in a situation where you need help, Channel 16 VHF/FM and 2182 khz HF/SSB are emergency distress frequencies monitored constantly by the Coast Guard. Use one of these to send a “Mayday” distress call. If you don't have a radio, try to get the attention of someone else on the water (or shore, or in an airplane) by using flares or other signaling devices.

## Fishing While Boating - Some Tips

- Don't overload your boat - look for the manufacturer's “Capacity Plate” for the maximum load.
- Board carefully - small boats capsize easily.
- Stow gear so the boat is in trim (floats level).
- Fish outside boat channels or swimming areas.
- Trolling boats need to be careful of traffic and boats ahead.
- Be careful of weight shifts when fighting and landing fish.
- Watch hooks, knives and sharp objects — store them properly.

Before you “cast off” for boating and fishing: know how to swim, take a boating course, keep your boat well-equipped and in good shape, follow nautical aids to navigation and rules of the road, and know what to do in an emergency.

## Hook Removal

---

Chances are that sooner or later you or somebody you're fishing with will get hooked by a fish hook. If a hook is seriously impaled you should see a physician immediately. But if the accidental hook-up isn't too bad you can remove the hook using one of two methods.

For hooks impaled in loose skin loop a 20 or 30 pound test line around the bend of the hook and grip firmly. Press down on the head of the hook with the thumb of your opposite hand, and pull the hook out. (See diagrams below.)

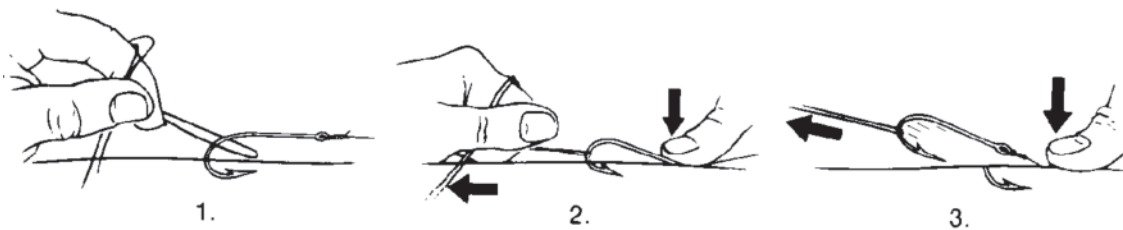

Courtesy of O. Mustad & Son (U.S.A.) Inc.

If the hook is impaled in tight skin you'll need to push the point through in a natural curve until the barb emerges (the worst is over at that point). Cut the hook at the bend and slide the barbless shank back through the wound. (See diagrams on the next page.)

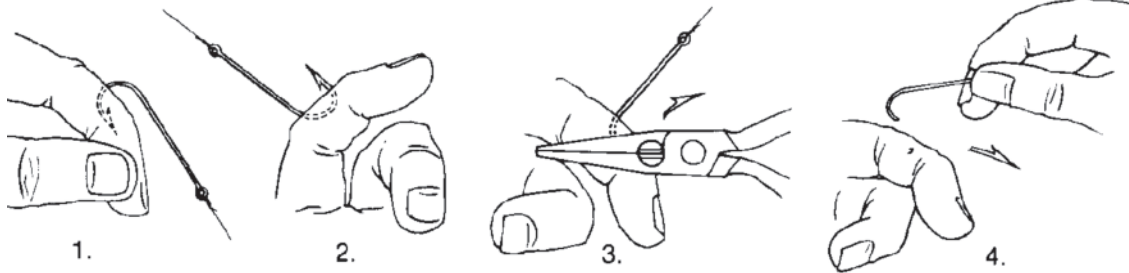

Courtesy of O. Mustad & Son (U.S.A.) Inc.

After the wound has bled freely for a few minutes wash it and cover with a bandage. When you return home soak the wound in an antiseptic solution and put on a fresh bandage. Get a tetanus shot if you haven't been keeping them up to date.

It's smart to take a first aid kit along with you when you fish, just in case. You should also take a first aid class so you're better prepared not just for fishing emergencies, but situations in general. A first aid kit should include at least the following items:

- |   |  |
|---|--|
| <input type="checkbox"/> First aid handbook               | <input type="checkbox"/> Band-aids (6 to 12)             |
| <input type="checkbox"/> Sterile bandage (4 x 4 inches)   | <input type="checkbox"/> Roll of gauze bandages (1 inch) |
| <input type="checkbox"/> Adhesive tape (½ inch x 5 yards) | <input type="checkbox"/> Petroleum jelly                 |
| <input type="checkbox"/> Antiseptic                       | <input type="checkbox"/> Razor blade                     |
| <input type="checkbox"/> Small scissors                   | <input type="checkbox"/> Tweezers                        |
| <input type="checkbox"/> Small mirror                     | <input type="checkbox"/> Aspirin                         |
| <input type="checkbox"/> Alcohol wipes                    | <input type="checkbox"/> Vinegar                         |
| <input type="checkbox"/> Meat tenderizer                  |  |

## Fish Poisoning

If you plan to eat fish that you've caught, you should be aware of the possibility of fish poisoning, which can result from eating spoiled fish or fish that contain toxic substances. There are several types of fish poisoning that occur to some extent in Hawai'i.

*Ciguatera poisoning* is caused by microscopic marine organisms (*dinoflagellates*) that grow on the surface of marine algae. The algae is eaten by herbivorous fish and the toxin produced by the dinoflagellates accumulates in the fish. As other fish higher in the food chain prey on these herbivores, the toxin accumulates in them as well. In fact, these predatory fishes may become even more toxic because the toxin isn't removed from their bodies. Fish such as ulua, kāhala, kole and po'ou have been most frequently implicated in ciguatera poisoning, but other reef fish have also been found to be toxic. Open water fishes such as aku, 'ahi, mahimahi and marlin have not been implicated in ciguatera poisoning.

There is no way to tell from a fish's appearance, smell or taste if it is toxic. The toxin is not removed by cooking, drying, freezing or salting the fish. Although lab tests can determine whether ciguatoxin is present in a fish, these tests are not generally available to the public. A simple testing procedure for home use may not be available for some time. To minimize the risk of being poisoned, never eat the eggs, liver or guts of any reef fish. The toxin becomes concentrated up to 100 times more in these parts of the fish. You might also call the State Department of Health's Epidemiology Branch to find out if there have been reports of ciguatera poisoning from fish caught in the area you're fishing.

Common symptoms of ciguatera poisoning vary greatly from one person to the next, but may include general weakness, diarrhea, muscle pain, joint aches, numbness and tingling around the

mouth, hands and feet, reversal of temperature sensation (hot objects feel cold and cold objects feel hot), nausea, vomiting, chills, itching, headache, sweating and dizziness. Temperature reversal usually doesn't develop until two to five days after eating toxic fish. Illness may last for weeks or months.

*Scombroid poisoning* results from eating spoiled fish, such as tuna, mahimahi and related species, which were not properly refrigerated while at sea. The disease is caused by an overgrowth of bacteria which produce toxic substances. The fish may or may not have a foul odor, but a metallic or peppery taste may be present.

Symptoms of scombroid poisoning usually appear within an hour after eating a spoiled fish, and may include flushing of the face and perhaps the upper body, severe throbbing headache, heart palpitations, abdominal cramps, diarrhea, burning sensation in the throat, dryness of the mouth, difficulty in swallowing and/or breathing, nausea and weakness. Symptoms usually last up to twelve hours. Treatment with antihistamines is usually effective.

*Hallucinogenic fish poisoning* may occur from eating mullet, various goatfishes, nenu and manini. It is seasonal, usually occurring in the summer months. Hallucinations, insomnia, intense dreaming, weakness, dizziness, general malaise, itching and burning of the throat and other symptoms are common, and come on soon after the fish is eaten. Terrifying nightmares may occur when the onset of symptoms happens while asleep. Constrictive chest pains may also occur. This type of fish poisoning is much less common than ciguatera or scombroid poisoning.

*Puffer fish poisoning* may result from eating puffers, blowfish, balloon fish and other related species. Many species of puffer fish contain *tetrodotoxin*, which is a very potent toxin. Onset of symptoms occurs within minutes and may include sweating and tingling of the lips, tongue and fingertips, followed by numbness that spreads throughout the body. Other symptoms include extreme weakness, nausea, vomiting, headache and profuse sweating. In severe cases muscular paralysis may occur, followed by death. The most common puffer fish has been implicated in at least seven deaths in Hawai'i.

If you suspect fish poisoning:







- Call your physician immediately for treatment. If your physician is not available, call the Hawai'i Poison Center. A physician's care is needed to remove unabsorbed toxins from the digestive tract, and to treat symptoms of the illness.
- Do not take any drug or medication without your physician's advice.
- Do not eat any remaining fish that may be toxic.
- Save the remainder of the fish (including the head and guts) in your refrigerator or freezer to be given later to the Department of Health. The department can assist in arranging for laboratory confirmation of suspected fish poisoning.
- Call the Department of Health to report a case of suspected fish poisoning.

## **Dangerous Marine Organisms**







---





Most animals and some plants have natural defense mechanisms, and they will probably try to defend themselves against you. If you're not sure what an animal is or what it might do to you, it's best to just leave it alone.

The following pages describe some dangerous marine organisms and provide information on symptoms, injuries, treatment and prevention. The information on treatment has been reviewed by medical authorities, but it's still a good idea to consult a physician or nurse for their recommendations.

| ORGANISM  | CAUSE OF INJURY   | SYMPTOMS / INJURY  | TREATMENT   | PREVENTION  |
|---|---|--|---|---|
| <p>Coral</p>                 | <p>Sharp edges, stinging cells</p>  | <p>Abrasions, irritation, torn skin, bleeding; possible infection (coral will <u>not</u> grow inside a cut)</p>  | <p>Soak irritated areas in dilute vinegar solution; clean cuts with rubbing alcohol, hydrogen peroxide, or soap and water, apply antiseptic; if cut is deep see a physician</p>   | <p>Wear tabis or sneakers when reef walking; wear gloves when handling coral; avoid shallow rough waters</p>  |
| <p>Portuguese Man-O-War</p>  | <p>Stinging cells in tentacles</p>  | <p>Stinging, burning sensations; severe reactions include irregular breathing and heart-beat</p>   | <p>Remove tentacles from skin; apply full strength vinegar, or paste of vinegar and meat tenderizer (don't use meat tenderizer if victim is allergic to papaya); if reaction is severe get emergency help immediately</p> | <p>Avoid water where sighted (usually blown in from open ocean); avoid walking near washed up Man-O-War on beach</p>                                    |
| <p>Jellyfish</p>            | <p>Stinging cells in tentacles</p>  | <p>Same as Portuguese Man-O-War</p>  | <p>Same as Portuguese Man-O-War</p>   | <p>Avoid areas where sighted; avoid handling jellyfish</p>  |
| <p>Sea anemone</p>         | <p>Stinging cells in tentacles</p>  | <p>Itching and burning, prickly sensation to severe pain; severe reactions may include shortness of breath; not all species will produce a noticeable reaction</p> | <p>Same as Portuguese Man-O-War</p>   | <p>Wear tabis and gloves; avoid contact with skin; don't put hands or fingers into holes or crevices</p>  |
| <p>Hydroids</p>            | <p>Stinging cells</p>   | <p>Itching, burning, rash that may last up to several days; severe allergic reaction in some people</p>  | <p>Same as Portuguese Man-O-War</p>   | <p>Avoid brushing against or grabbing underside of floats, pilings, boat bottoms, submerged lines and other areas to which hydroids may be attached</p> |
| <p>Sponges</p>             | <p>Spicules — supporting structures within sponge which can lodge under skin if handled; fire sponge produces irritating chemical</p> | <p>Burning or itching; fire sponge may cause small blisters</p>  | <p>Same as coral</p>  | <p>Wear gloves; avoid handling sponges</p>  |



| ORGANISM  | CAUSE OF INJURY  | SYMPTOMS / INJURY   | TREATMENT  | PREVENTION   |
|---|--|---|--|--|
| Fireworm<br>           | Sharp bristles which contain toxin   | Burning, itching, stinging, swelling, inflammation  | Vinegar, or treatment for coral; bristles may sometimes be removed with adhesive tape                                | Wear gloves; use care turning over rocks   |
| Sea urchin<br>         | Long brittle spines, some of which are venomous on certain species         | Throbbing pain, puncture wounds; possible infection   | Soak in hot water until pain goes away, apply undiluted vinegar; see a physician for removal of long embedded spines | Wear tabis with thick soles; don't put hands into crevices; avoid handling sea urchins   |
| Cone shell<br>         | Venomous dart-like structure at narrow end of shell, used to paralyze prey | Mild to severe pain, burning, numbness, vomiting; stings by the most toxic species may cause paralysis, respiratory failure, cardiac arrest | Soak in hot water, see a physician; bring shell along for identification if it can be done safely                    | Avoid handling cone shells; if collecting live shells hold only at broad end   |
| Octopus ("squid")<br> | Beak in mouth at base of tentacles; salivary glands contain toxin          | Skin wound, bleeding, stinging pain   | Same as coral; see a physician   | Use care when handling octopus   |
| Crab<br>             | Pinchers   | Shallow to deep wounds, depending on size of crab; possible infection; large crabs can amputate fingers                                     | Wash with soap and water, apply antibiotic; if wound is serious apply pressure to stop bleeding and see a physician  | Use care when handling crabs   |
| Surgeonfish<br>      | Spines at base of tail   | Bleeding, stinging or throbbing pain; possible infection  | Soak in hot water, wash with soap and water, apply antibiotic; see physician if spines are embedded in skin          | Use care when handling surgeonfish   |
| Scorpionfish<br>     | Venomous spines in dorsal fin  | Extreme throbbing pain which may last for hours; in rare severe cases convulsions or cardiac arrest may result                              | Soak in hot water, get medical attention immediately   | Wear protective footwear on reef; be careful where you put hands and feet; avoid handling live scorpionfish; use care handling dead scorpionfish |

| ORGANISM  | CAUSE OF INJURY        | SYMPTOMS / INJURY   | TREATMENT   | PREVENTION  |
|---|------------------------|---|---|---|
| <p>Barracuda</p>   | Sharp teeth            | Torn skin, bleeding; severe bleeding may lead to shock  | Apply pressure and elevate wound to control bleeding; lay victim down if in shock, keep warm, elevate legs if possible; see a physician                             | Use caution when swimming and barracuda is seen, avoid splashing, don't wear reflective jewelry; avoid handling caught barracuda near mouth |
| <p>Needlefish</p>  | Long pointed jaw       | Deep puncture wounds, bleeding; part of jaw may break off; possible infection   | Clean wound with antiseptic solution; do not attempt to remove embedded parts of jaw; get medical attention immediately   | Use caution when night diving or torch fishing since needlefish are attracted to lights   |
| <p>Moray eel</p>   | Sharp teeth            | Torn skin, bleeding; injury to muscle, tendon, ligament, nerve tissue; possible infection   | Clean wound with soap and water and apply antiseptic; if wound is serious apply pressure and elevate wound to control bleeding; see a physician                     | Don't put hands or fingers into crevices on reef; don't provoke moray eels  |
| <p>Shark</p>     | Sharp teeth and scales | Scales can cause abrasions; bites cause severe bleeding and may result in shock; injuries from bites may be mutilating, with amputation or death in the most severe cases | Control bleeding by applying direct pressure and elevating wound; treat for shock by laying victim down and keeping warm; obtain emergency medical help immediately | Avoid swimming in murky water; return to shore if shark is sighted; divers should avoid towing speared fish for long distances              |
| <p>Stingray</p>  | Venomous barb on tail  | Puncture wound or deep laceration, severe pain; injuries in abdomen, chest, head or neck especially serious   | Soak in hot water; if barb is embedded in skin do not touch or attempt to remove; get medical attention   | Shuffle feet when walking in shallow sandy areas  |

Information based on University of Hawai'i Sea Grant Advisory Report UNIH-SEAGRANT-AR-78-01, July 1978, University of Hawai'i Sea Grant College Program; the author and publisher specifically disclaim any liability, loss, or risk incurred as a result of the use and application, either directly or indirectly, of any advice and information presented here. Illustrations: National Oceanic and Atmospheric Administration, Division of Aquatic Resources, Waikiki Aquarium, University of Hawai'i Sea Grant College Program.

# FISH BIOLOGY AND HABITAT

---

The more you understand about fish the more likely you are to catch them. Serious fishermen pride themselves on being able to think like a fish, or at least that's what they'd like you to believe. If you're going to be a successful angler you have to know what and when your fish eats, how it feeds, where it likes to hang out, and other related information. You'll want to know what kinds of habitats are preferred by different fish, and what kinds of fish you're likely to find in a particular location.

As with everything else related to fishing, experience is the best teacher. The concepts presented in this chapter should help you improve your understanding of fish and their environment, and your ability to apply this information to your fishing experiences should affect your success.

## Fish Biology

---

A fish is a cold-blooded vertebrate that lives in water, breathes through gills, has fins and usually has scales. Cold-blooded means that it cannot maintain a constant body temperature, so a fish's body has the same temperature as the water that surrounds it. The water temperature will affect the fish's metabolism. If the water is cold, the fish will be less active than in warmer water.

A vertebrate is an animal that has a backbone, and if you've seen fish skeletons you know they definitely have backbones. Whales and dolphins, which are also vertebrates, are warm-blooded mammals (not fish) that breathe with lungs, have flukes and flippers but no fins, and never have scales.

### External Anatomy

Shown below is a diagram of a hypothetical fish. Fortunately, no real fish looks like this. The drawing shows all the external features you're likely to run into in fish descriptions.

In the diagram, you'll notice that *anterior* is the head end of the fish and *posterior* is the tail end. *Dorsal* is the back surface and *ventral* is the belly surface.

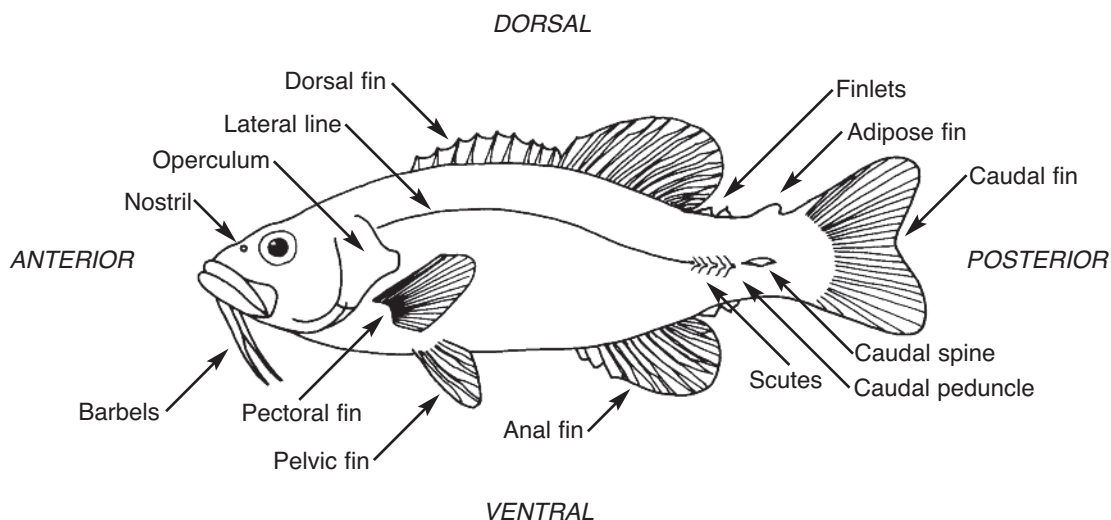

## Fins

Most fish have at least seven fins. Three — the *dorsal*, *caudal*, and *anal* fins — are called *median* fins because they run down the middle of the fish. In addition, there is a total of four *paired* fins - two *pectoral* and two *pelvic* fins, one of each on either side. Some fish have two separate dorsal fins, and some (like trout and catfish) have a fleshy *adipose* fin near the tail. Tunas and some other fast-swimming fish have *finlets* in that area.

How a fish swims



The function of fins is to provide propulsion and control. A fish swims by moving its caudal fin left and right, and fish that are fast swimmers have powerful tail muscles. The other median fins provide stability by keeping the fish from rolling to its side while swimming. The paired fins are used mostly for turning, and when swimming backwards. Finlets help control the flow of water over the tail. Uluu and many of their relatives have *scutes* along the side of the *caudal peduncle* which may serve the same purpose. The function of the adipose fin is uncertain.

## Gills

The *operculum*, or gill cover, is a bony plate that covers and protects the gills. Most fish have four gills on each side. In order to breathe, a fish takes water in through its mouth and forces it over the gills. Oxygen is absorbed from the water, and carbon dioxide and ammonia are excreted. Structures known as *gill rakers* prevent food and other large particles from passing over the gills, directing them toward the fish's throat instead.

## Sense Organs

Several sensory organs can be seen on the outside of the fish. *Nostrils* serve only as smell detectors — fish cannot breathe through them. Fish usually have two nostrils on each side — water goes in through one opening and out through the other. Some fish, like goatfish and catfish, have *barbels* under the chin or around the mouth which can detect touch and taste; the fish probes the bottom with its barbels to locate prey. A fish can also detect taste with its tongue.

Fish have ears, although you can't see them. They're buried on either side of the head, and receive sounds transmitted through the skin, flesh and bones of the head. A fish's sense of hearing is well developed.

Fish have one sensory organ that no other animal possesses — the *lateral line*. It functions somewhat like an ear. It's sensitive to low frequency vibrations, and with it a fish can detect nearby movement in the water. The lateral line runs along both sides of the fish, and consists of a series of very small pits with nerve endings. Scales along the lateral line have tiny holes in them.

Fish have an excellent sense of vision, and some (especially reef fish) can probably see colors. Because of the location of the fish's eyes it can see almost all the way around its body. As seen in the diagram, both eyes cover the area directly in front of the fish, so it is only in that area that the fish has any depth perception. Vision to the rear is cut off by the fish's body, resulting in a blind spot of only about 60 degrees of arc. Fish that are active at night have large eyes.

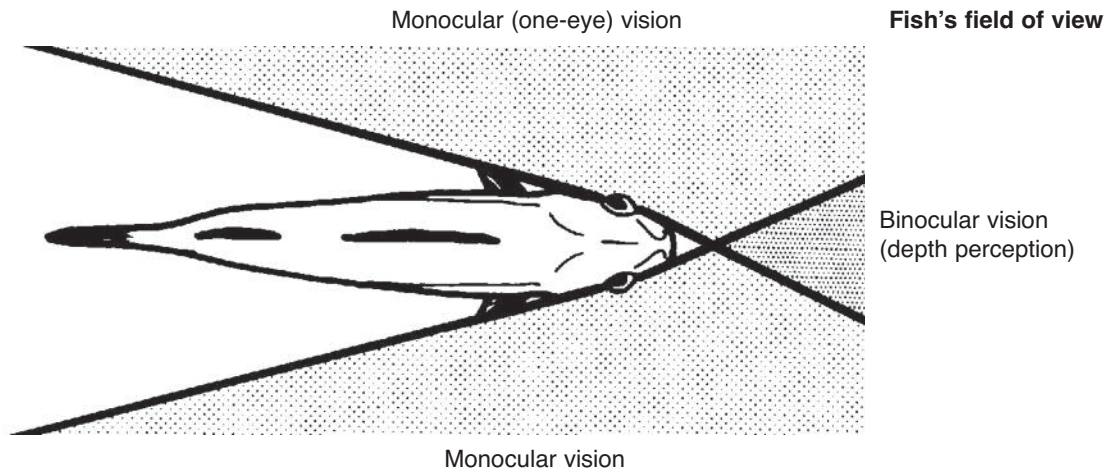

## Coloration

A fish's body coloration has a purpose. Many fish are colored to avoid being seen by other fish. Fish that live on sandy bottoms or in rough water are usually light colored. The light color is a type of camouflage. So is a color pattern known as *countershading*. Fish with countershading are dark on the dorsal surface and light below. This type of coloration is fairly common, and its advantages are easy to understand. Looking at the fish from above, you (or another fish) would see a dark fish against a dark background. Looking from below you'd see a light fish against a light background.

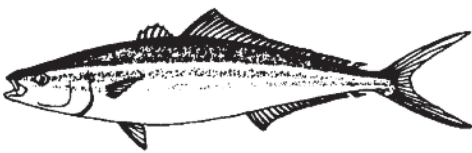

Countershading

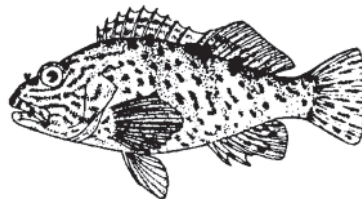

Disruptive coloration

Illustrations  
courtesy of NOAA

Bars and circles are often found on fish that live near coral heads or in areas of seaweed. Known as *disruptive coloration*, these patterns disrupt an observer's view by breaking up the fish's body in some way so it blends with the background or appears less "fish-shaped". Some fish (like pāki'i, or flounders) are able to change color to match their background. It's the ultimate in camouflage.

Many reef fishes are known for their brilliant coloration. They're clearly not trying to remain inconspicuous. But most reef fish don't need to hide by virtue of color — they can duck into crevices in the reef to avoid predators. The bright colors may serve primarily for identification, especially of potential mates.



## Body Shape

Most fish have a shape that's somewhat long and streamlined, which helps water flow easily over the body without much energy loss on the part of the fish. But the shape of the body is related to the fish's habitat and feeding style. Fish that spend most of their time sitting on or swimming along the bottom, such as goatfish and scorpionfish, will have a shape that's fairly flat on the ventral surface. Fish like eels and trumpetfish, which are long and skinny, aren't known as fast swimmers but are good ambush predators. Their shape gives them low visibility as they sneak up on prey. Fast swimming fish, like jacks and tunas, have very streamlined body shapes. In fact, the bullet shape of a tuna is considered the most perfect shape for high speed swimming.

### Variations in body and tail shapes

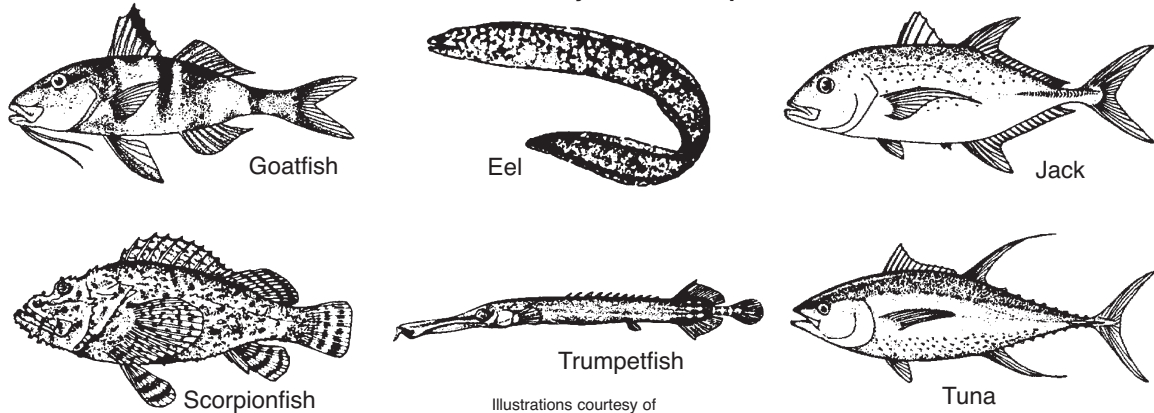

Illustrations courtesy of  
NOAA and Waikiki Aquarium

Related to body shape is the shape of the tail. All fast swimmers have a highly forked tail which cuts down on water resistance. Slow swimmers usually have a more rounded tail.

Mouth structure also tells you something about the fish. *Carnivores* (meat eaters) will have large mouths with sharp teeth for grasping other fishes, or heavy flat teeth for eating mollusks and other hard-shelled animals. *Herbivores* (plant eaters) will usually have small mouths with fine teeth for biting plants or scraping algae off rocks.

## Internal Anatomy

We won't spend much time going over the internal organs of a fish. You'll become familiar enough with them as you clean fish. But there are a couple of structures worth pointing out.

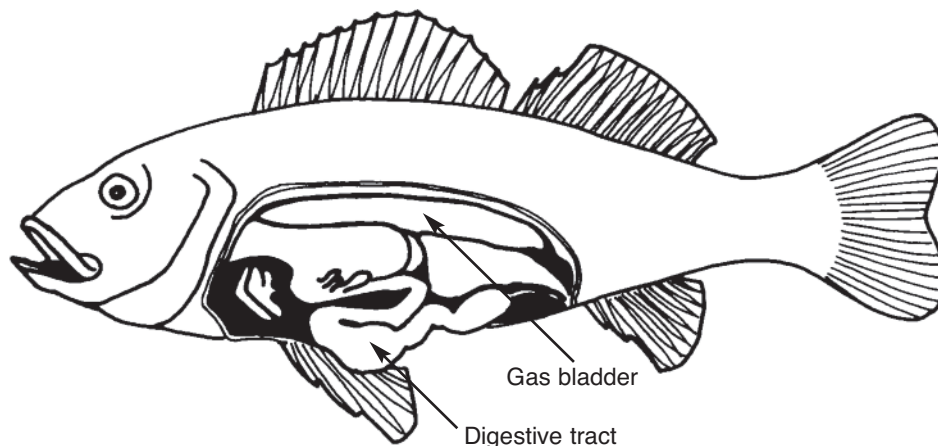

Most fish have a *gas bladder* (or swim bladder), which is an air-filled membrane just under the backbone. Its function is to provide the fish with some buoyancy. Without a gas bladder a fish would tend to sink, and would have to keep swimming to stay at a particular level. Some fish that live on the bottom don't have a gas bladder.

Gas bladders expand as fish are brought up from deep water, and the expansion will cause fish to float on the surface if released. To release a fish in that condition, take a sharp needle and push it through the side of the fish, into the gas bladder. The excess gas will escape, and the wound will heal quickly.

The other structure worth mentioning is the *digestive tract*. As you clean fish you'll notice that the digestive tracts of carnivores and herbivores are different. Herbivores have a much longer intestine than carnivores. That's because plant material is harder to digest than animal material; a longer intestine gives the fish more time to break down its food.

## Habitat

---

The place where a fish lives is known as its *habitat*. Any habitat must provide a fish with certain basic requirements: food, good water quality, and protection from predators. Different kinds of fish require different types of habitat, and the waters of Hawai'i have a number of marine and freshwater habitats, each with its own characteristic fishes and other aquatic life.

### Coral Reefs

Perhaps the best known marine habitat is the *coral reef*, made up of living and nonliving *corals* and *coralline algae*. Corals are small animals (*polyps*) resembling sea anemones, which form hard skeletons that remain long after the animals have died. Coralline algae is red algae that secretes calcium carbonate, and makes up most of the reef structure, especially on older reefs.

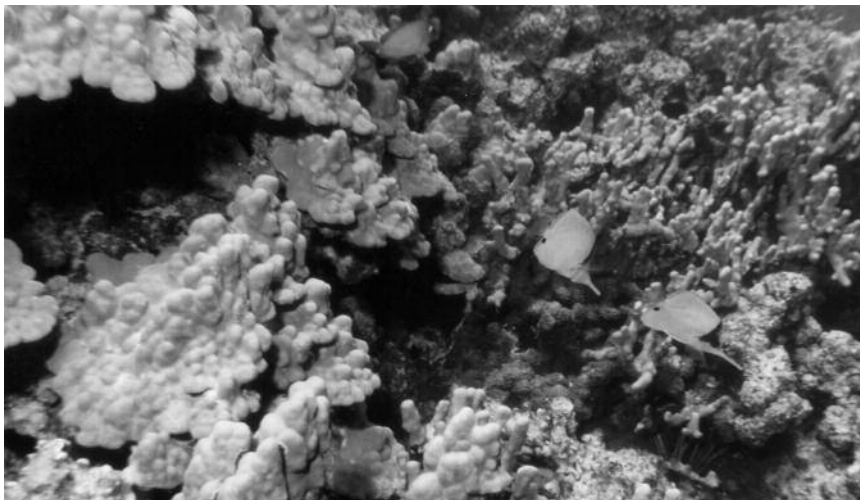

Coral reef habitat

Reef areas with living coral attract a great deal of life. The coral polyps are food for some fish, including butterflyfish. Surgeonfish feed on algae growing on exposed surfaces. Parrotfish scrape algae off dead coral surfaces. Other fish feed on plankton above the reef. All these fish are in turn preyed upon by larger species higher up the food chain. Coral also provides shelter for fish and other animals, protecting them to some extent from predators. Fishes generally found in coral reef

areas include butterflyfish, surgeonfish, parrotfish, wrasses, damselfish, goatfish, eels, pāpio and others (refer to the Other Reef Fishes section of the fish identification pages at the end of the book).

In order to survive, corals need abundant sunlight, clean water, food and oxygen. Corals eat plankton, and get some food from algae living in their tissues. Corals have a very low tolerance for changes in *salinity* (amount of salt in the water), and will not grow in areas near freshwater runoff. Sunlight is required by the algae living in the coral polyps. If sunlight can't penetrate down to the coral, due to turbid water or siltation, corals will die. (Corals can clean themselves off to an extent, so small amounts of silt can be tolerated.)

An abundance of nutrients from sources such as sewage may cause seaweed and sponges to grow rapidly over the coral and kill it. These kinds of events have happened over the past few decades in Kāneʻohe Bay on Oʻahu, resulting in degradation of the reef and loss of much marine life. However, after steps were taken to reduce the amount of silt and sewage flowing into the bay, the corals started to recover and fish populations increased.

## Sandy Bottom Areas

Sandy areas are often found along the coastline, between and around coral reefs and boulders, and in deeper areas beyond the reef. Many invertebrates burrow into the sand, and are preyed upon by fish. Sandy areas offer little protection for fish, so they generally feed in these areas (especially at night when the invertebrates are active) and look for shelter somewhere nearby. Fish commonly found in sandy bottom areas include goatfish, 'ō'io, awa'aua, wrasses, lizardfish, pāki'i and moi.

## Rocky Shorelines and Boulder Areas

Many areas of coastline are formed of basalt rock extending into the water with little coral growth or sand nearby. In such areas boulders may be strewn on the seafloor, having broken loose from the shoreline at one time. These areas often have rough wave activity, and only a few types of algae and encrusting corals are found here. The boulders provide shelter for fish, but the small amount of available food (compared with a coral reef, for example) limits the number of fish present. However, some herbivores such as nenu and surgeonfish may be found here, feeding on the algae that's broken off by wave activity. Predators such as pāpio may also be present.

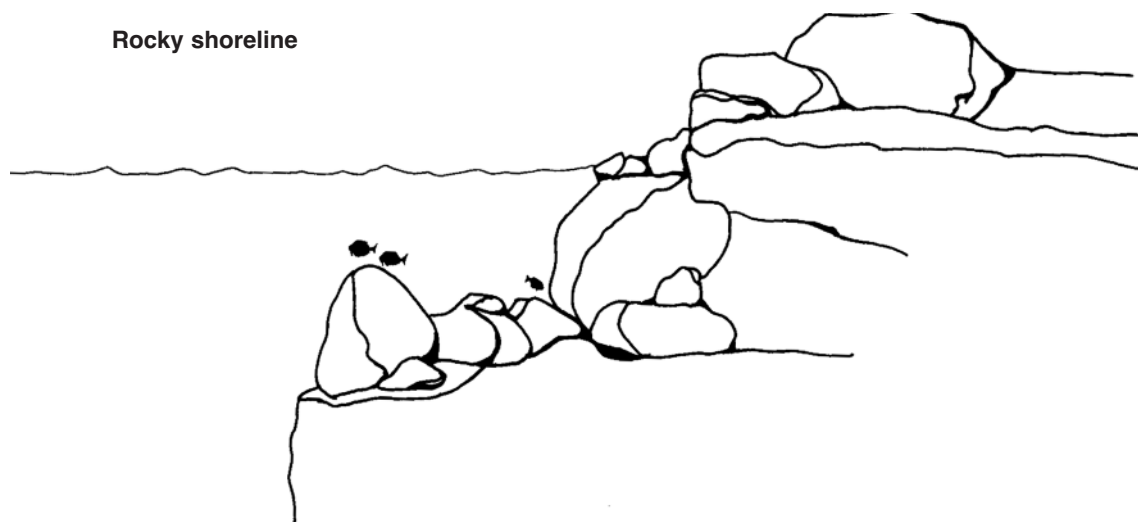

## Steep Dropoffs

Along some of the more vertical rocky shoreline areas, as well as just outside the reef, there is a dropoff to fairly deep waters. Currents in these areas may bring nutrient rich water up from the depths, resulting in an abundance of plankton and, in turn, plankton feeding fishes. These fish will often congregate in large schools, and include 'ōpelu kala and various butterflyfish.

## Offshore Habitats

The *pelagic* (open ocean) fishes exist in a habitat quite different from the inshore species. There is no shelter available, so the fish are usually countershaded with a gun-metal blue color above fading to silvery below. These fish are active swimmers and ravenous feeders, often moving in closer to shore or around bank areas to find food. Many of these fish, such as mahimahi and various tunas, are attracted to floating objects, perhaps because other fishes lower in the food chain are also likely to be found there. In bottom areas are found the various deepwater snappers ('ōpakapaka, ehu, etc.) and groupers (hāpu'u).

## Freshwater Habitats

Hawai'i has many freshwater streams, but only a few small naturally occurring lakes. The streams are home to only five native species of fish, the 'o'opu or freshwater gobies (one species is not a true goby). 'O'opu have life cycles that include both freshwater and saltwater environments — adults live and lay their eggs in freshwater, and after the eggs hatch the larvae are swept out to sea where they spend several months before migrating back to the streams. 'O'opu have pelvic fins that are fused together to form suction disks, and some species are able to climb steep waterfalls.

Several native species of freshwater mollusks and shrimp are found in streams. Two marine fish, āholehole and 'ama'ama, can often be found in the brackish lower reaches of streams. In addition to the native fishes, a number of introduced species are also found in Hawai'i's streams. Smallmouth bass, rainbow trout, puntat and tilapia are popular with anglers.



Nu'uuanu Reservoir No. 4,  
O'ahu

Over the years a number of water storage reservoirs were constructed around the state, many of which were in turn stocked with introduced sportfish, as discussed in the next chapter. Large-mouth and smallmouth bass, channel catfish, bluegill, tucunare, oscars and pongee are present, and are favorite target species for Hawai'i's freshwater anglers.

## Water Quality

There are environmental factors other than availability of food and protection from predators that affect fish populations. These factors may affect either the fish themselves or the food chain. One of these is *salinity*, the proportion of salt in the water. We've seen that corals can tolerate only a very narrow range of salinities. The same is true of most fish species. However, some fish such as mullet, āholehole and barracuda will often be found in brackish water areas (saltwater mixed with freshwater), such as embayments near the mouths of rivers. Most other saltwater fish would not enter such areas.

*Dissolved oxygen* is another factor critical to fish (as anyone who's tried to keep baitfish alive in a bucket without an aerator knows). Oxygen is produced by algae through the process of photosynthesis. It also enters the water through its surface, especially when the surface is churned up by wave activity. There is quite a bit of oxygen in sea water because of its constant mixing. But in tidepools the situation may be much different. Warm water doesn't hold as much oxygen as cool water, and an isolated tidepool may become low in oxygen fairly quickly. Isolated freshwater areas may also become low in oxygen, especially if any plant decomposition is going on. Algal blooms also tend to use up a great deal of oxygen. Many fish will come to the surface and attempt to “gulp” air when the dissolved oxygen level gets too low. Some fish, such as tilapia and carp, can tolerate lowered oxygen levels better than other species. That's one reason they can be found in waters of relatively poor quality.

*Temperature* is a factor that most saltwater fish don't have to worry about, since the water temperatures in Hawai'i vary little during the year. Still, since temperature decreases as you get deeper, there are limits to how deep a fish will be able to go before its metabolism slows down too much. Freshwater species, especially in temperate regions, are more susceptible to temperature changes, and in some cases their life cycles may be influenced by temperature. Trout, for example, cannot spawn except in cold water. That's why most of the trout stocked in Hawai'i cannot reproduce here.

## Summing Up

Fish will be found in areas that provide them with food, good water quality and, in most cases, protection from predators. Each type of habitat has its own characteristic species present, so if you know what sort of habitat you're fishing you'll have at least some idea of the kinds of fish likely to be there. Fish are also affected, directly or indirectly, by other factors. Conditions that degrade the reef, such as pollution or siltation, will result in loss of fish from the area. Restoring fish populations involves taking these environmental factors into consideration, and is a topic that will be discussed in the next chapter.



# CONSERVATION AND MANAGEMENT

The early Hawaiians understood the importance of protecting their fish resources. Fish were their major source of protein. The survival of the Hawaiian people depended on their ability to manage their fisheries wisely. The *kapu* system, which regulated all aspects of society, applied to fishing as well. Certain activities were strictly forbidden. For example, the Hawaiians prohibited fishing for certain species during their spawning seasons. Since ‘ōpelu spawn from about January through July, aku and ‘ahi were caught at that time, and ‘ōpelu were *kapu* (forbidden). When aku were spawning, from about July through December, ‘ōpelu and akule were taken.

The need to protect spawning fish is obvious: fish must be allowed to reproduce in order for the species to survive. It's believed that the early Hawaiians probably knew more about the life histories of some fish than we do today, and seasonal restrictions were based on their knowledge of the fish's biology. Other laws prohibited taking more than a portion of the fish supply from one area at a time; greed would not be tolerated. The Hawaiians took their laws very seriously. Violating a *kapu* often meant death. The needs of society outweighed everything else; food resources could not be wasted.

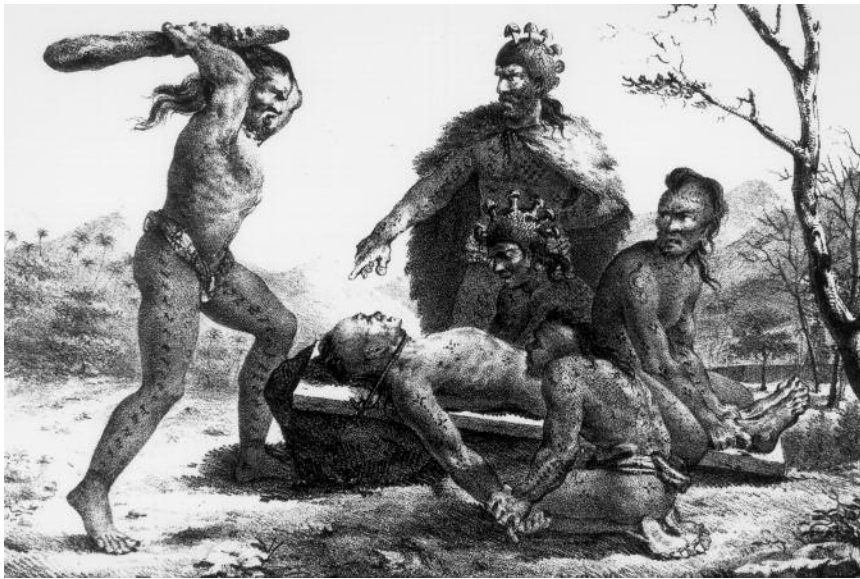

The old way of punishment

Lithograph after Jacques Arago  
Courtesy of Bishop Museum

The number of fish around the Hawaiian islands in these early years can only be imagined, but it must have been incredible. The Hawaiian population was fairly small, the reefs were unspoiled, and enough fish were present to adequately meet the demands of the people. Over the years, cultural changes affected nearshore fisheries. The *kapu* system was abolished by Kamehameha II in 1819. Waves of immigrants arrived from Asia, Europe and America, bringing with them new techniques for catching fish. These newcomers didn't share the Hawaiians' sense of oneness with the sea and its creatures.

As the population continued to grow, more people were using better fishing methods. The numbers of fishes on the reef were no longer enough to satisfy the growing number of fishermen, and fish populations declined. Fish habitats were also affected as a result of the growing population. The shoreline would be changed by development, and the quality of nearshore waters would become affected by technology.

A new system was needed to manage nearshore resources so fish and other aquatic life would be conserved and sustained for the future. The system must balance out the needs of both consumptive (e.g. removing fish for food or aquarium pets) and nonconsumptive (catch-and-release fishing, dive tours, etc.) users of the resource.

Management today involves controlling use of the resource, as well as manipulating habitat and fish populations. It includes a) *regulations* to control taking of existing resources, b) *management by area* to protect fish populations, c) *habitat enhancement* to provide shelter and attract fishes, and d) *introduced species* and *stock enhancement*, culturing and releasing fishes in order to improve fishing opportunities.

## Regulations

---

The end of the *kapu* system was not the end of fishing rules. In 1839 Kamehameha III established the first written set of laws in Hawai'i's history, and a long section dealt with fish and fishing grounds. However, the new laws were not as effective as the *kapu* system at conserving marine resources. In 1900, shortly after Hawai'i became a territory of the United States, studies were made of Hawai'i's fisheries and fishing laws by the U.S. Congress. The territorial government and, later, the state government continued to pass new laws to protect fish and other marine resources.

Today, all of the submerged lands of the state, from the high water mark seaward to a distance of at least three miles, are under the jurisdiction of the Department of Land and Natural Resources (DLNR). The department has been given the authority to establish rules as it sees fit to protect the nearshore environment, much as the early Hawaiians did. The state legislature can also pass laws for this purpose. For example, the importance of coral to marine life was discussed in the previous chapter. Removing coral as a souvenir has long been popular, but it's clearly not in the best interest of fish. It's now illegal to take any stony coral.



Penalties for violating fishing rules and regulations are not as severe as they were in the old days, but they are a deterrent. Most violations of laws and rules relating to protection of the marine environment are punishable by stiff fines and jail sentences. Because regulations change from time to time, it's important to keep current on them.

### Closed Seasons

Earlier we mentioned the importance of closed seasons for fish reproduction. Some species of fish and crustaceans are protected by closed seasons during their critical spawning months, as was the case in earlier times. Closed seasons have been established for 'ama'ama (striped mullet, closed December through March), moi (closed June through August), lobster and Kona crab (closed May through August). Lobster spawn to a certain extent all year, so it's always illegal to take a lobster with eggs. If the population of a species falls to drastically low levels, a continuous closed season may be imposed. That's the case with clams, oysters and many other mollusks. Taking them is prohibited all year long. However, the season may reopen one day, if populations recover sufficiently.

Moi: Closed season June - August;  
Minimum size 11 inches; Bag limit 15

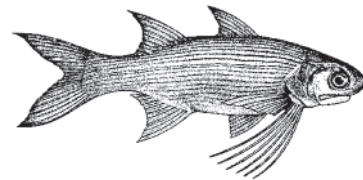

Courtesy of Waikiki Aquarium

## Minimum Sizes

A number of fish and crustaceans have regulations on minimum size. The reason for size restrictions is related to the animal's life cycle. Fish cannot reproduce until they reach a certain size, and that size depends on the species. Minimum size restrictions are designed to allow fish to grow large enough to be able to reproduce. As more information is learned about the biology of various species, minimum size rules and other regulations are likely to change. Because large fish produce many more eggs than smaller fish, maximum sizes may one day be introduced as well to protect the best spawners.

## Bag Limits

A few of the more popular marine species, as well as most of the introduced freshwater sportfishes, have bag limits — limits on the number of fish you may take in one day or have in your possession. These restrictions are similar in intent to the old laws governing how many fish could be taken from a particular area. Taking too many fish could put a serious dent in the population. Bag limits also make more fish available to other fishers.

## Other Regulations

In addition to the regulations described above, restrictions apply to the use of certain types of fishing gear (for example, minimum mesh sizes for nets and traps, and prohibiting spearing of lobster). Seasonal restrictions on maximum sizes of freshwater gamefish apply in certain areas. Regulations pertaining to particular areas are in effect (as described somewhat in the following sections). It's important to know and follow the law. As mentioned in an earlier chapter, you should always have a current copy of the *Hawai'i Fishing Regulations* booklet. These are available from DLNR offices and most fishing supply stores.

## Management by Area

---

### Marine Life Conservation Districts

In the fall of 1967 the state closed Hanauma Bay on O'ahu to all forms of fishing, making it illegal to take any type of marine life from the area. The effects of this closure have been amazing - the number of fish in Hanauma Bay have increased tremendously, making it one of the state's most popular destinations for visitors and locals alike. Hanauma Bay was the state's first Marine Life



Hanauma Bay MLCD,  
O'ahu

Conservation District (MLCD), and its success in restoring fish resources resulted in the establishment of ten others (to date), including Molokini Shoal off the island of Maui, and Kealakekua Bay on the Big Island.

MLCDs are generally closed to fishing, but certain exceptions apply to some areas. One of the benefits of MLCDs as breeding areas for fish is not real obvious: the larvae that hatch out of fish eggs spawned in the protected waters of an MLCD can be dispersed by currents to surrounding areas, and probably even to other islands. MLCDs have proven to be a very effective method of increasing the numbers of nearshore fishes, and more MLCDs are likely to be established around the state in the future.

## Shoreline Fisheries Management Areas

The success of MLCDs showed that fish populations could increase rapidly when an area is permanently closed to fishing. In 1978 the state began an experiment to determine whether closing an area temporarily could have a similar effect. The area chosen was just offshore of Waikīkī and Diamond Head, on the island of O‘ahu. Fish counts of the area were made during Fiscal Year (FY) 1978 (July 1, 1977 to June 30, 1978), and the area was then closed for two years beginning July 1, 1978 (FYs 1979 and 1980). During this time the numbers of fish increased, as expected.

On July 1, 1980 (the start of FY 1981) the area was opened to pole and line fishing and hand harvesting, then opened to all legal fishing methods at the beginning of FY 1982. The area was again closed for two years at the start of FY 1983, and the cycle repeated. The graph shows the results of fish counts taken during the period from FY 1978 through FY 1988. The dark bars represent years during which the area was closed.

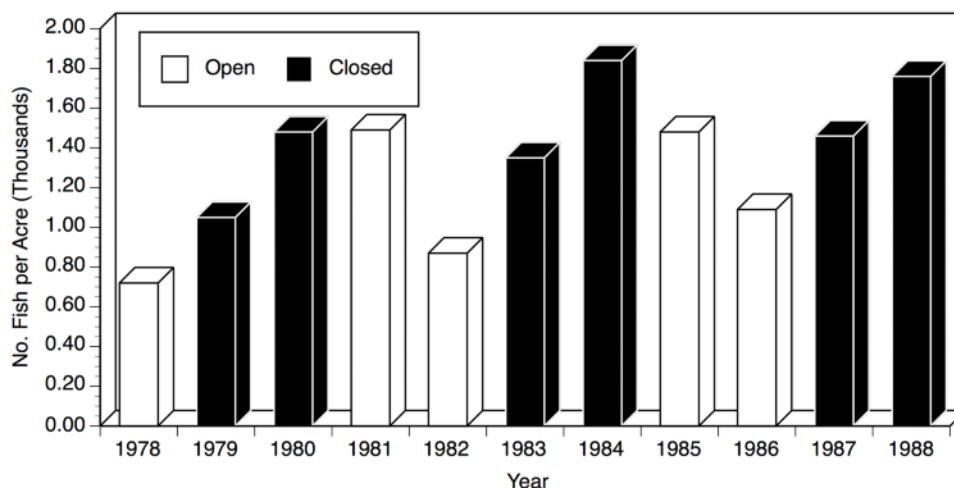

After studying this and other data, it was concluded that the decrease in fish populations that took place when the area was open to all legal fishing methods was due mostly to net fishing and, to a lesser extent, night spearing. In addition, it was felt that the fish populations could recover enough in a year's time to allow only certain types of fishing. So the rules changed. The Waikīkī-Diamond Head Shoreline Fisheries Management Area (SFMA) is now closed for only one year, then open for one year. Use of nets (except thrownets) is prohibited, as is night spearing. In order to get away from the confusing fiscal year dates, the openings are now on a calendar year basis. During even-numbered years the area is open (starting January 1), and it's closed during odd-numbered years.



# Habitat Enhancement

---

## Artificial Reefs

The attractiveness of reef areas to fish was discussed in the previous chapter. Reefs provide food and protection from predators, whereas barren areas have little to offer a fish. Placing artificial shelters in barren areas should attract fish.

Attempts to create artificial reefs were made with car bodies in the early 1970s. Unfortunately, the cars rusted away within a few years. Concrete structures (pipes and pilings) proved to be more permanent, but were difficult to deploy and tended to move around during periods of strong surf. Eventually a modular design consisting of eight to ten old tires embedded in a six foot long slab of concrete was selected. Hundreds of these modules are loaded onto a barge, then deployed and stacked underwater in large piles.



**Weke attracted to artificial reef modules**

The results have been impressive. Areas which were once desolate now attract thousands of fish. To date the state has established four artificial reef sites off O‘ahu and one off Maui. In addition to the tire modules, hulls of old ships and barges may be sunk on the sites, providing more habitat.

## Fish Aggregating Devices

Fishermen have known for a long time that some species, like mahimahi and aku, are attracted to floating objects. It's not clear why they're attracted, but the most likely explanation relates to the food chain: small fish may congregate there, possibly in an attempt to hide from predators. For years man-made floating objects have been placed in the ocean to attract species, in areas including the Philippines, Sea of Japan and Mediterranean Sea.

Fish aggregating devices (FADs) were first tried in Hawai‘i in 1977. The initial design used old cane haul tires filled with polyurethane foam. Streamers were attached to the mooring line along the top hundred feet, and were the major fish attractant. Unfortunately, the foam would eventually soak up water. A new design was tried using five surplus Navy buoys welded together in a pentasphere. It was found that the amount of drag on the buoys caused considerable strain on the mooring line, and they would often break loose.



### Fishing at a FAD



To reduce the drag, a single 58 inch sphere was tried. This design proved to be the most stable, and is still in use. There are over 60 surface FAD stations around the state, with more planned for the near future. They are by far the most popular ocean sites for recreational fishing.

Because the drag on even single sphere FADs causes them to break loose from time to time, another design was tested. Midwater FADs were constructed of four spheres welded together in a tetrahedral arrangement. Rather than floating on the surface, they were located 40 to 60 feet below it. This eliminated surface drag, and was expected to extend the life of the FADs. A trolling alley consisting of a row of ten midwater FADs was first installed off the Wai‘anae coast of O‘ahu. A second set of midwater FADs was deployed off Moloka‘i. The midwater FAD system never made it past the experimental stage. They were more difficult to maintain than expected, and fishers often had a hard time finding them.

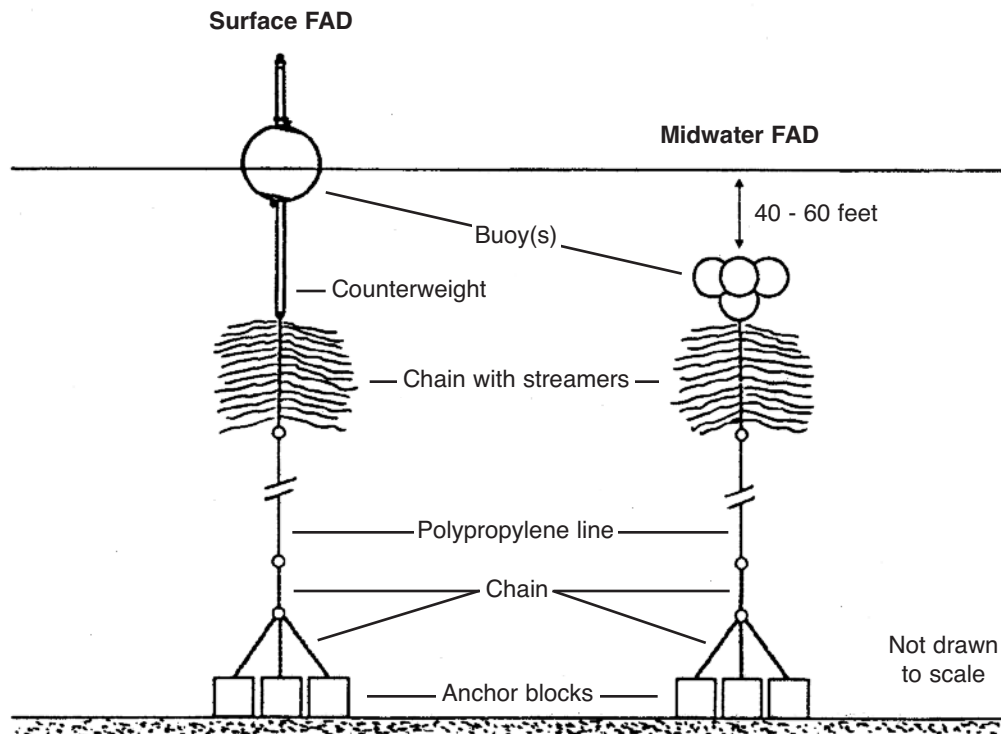

## Introduced Species and Stock Enhancement

---

From time to time species not native to Hawai‘i are brought in to provide more fishing opportunities for local fishermen. Examples of marine species that have been introduced include ta‘ape, to‘au and roi. Before a species may be brought into the state, considerable studies must be done on the possible effects of the introduction. Certain species (like piranha) may not be brought in under any conditions.

### Freshwater Introductions

As mentioned in the previous chapter, Hawai‘i has only five species of native freshwater fish. Only one of these, the *‘o‘opu nākea*, has been fished to any extent. In order to improve freshwater recreational fishing opportunities, the state has introduced such popular sportfish as largemouth and smallmouth bass, rainbow trout, channel catfish, tucunare, bluegill and others. These fish are generally released into places designated as “Public Fishing Areas,” such as Wahiaiwā and Nu‘uanu Reservoirs on O‘ahu and Kōke‘e State Park on Kaua‘i. A license is required in order to take introduced freshwater sportfish.

### Fish Hatcheries

Rainbow trout are stocked in the waters of Kōke‘e on Kaua‘i. Because the water temperature is so warm, they are unable to spawn successfully. So every year about 100,000 trout eggs are shipped to Hawai‘i from California. These eggs are taken to a DLNR facility at Sand Island on O‘ahu where they are hatched and raised to fingerling size. They are then flown to Kaua‘i, transported to Kōke‘e, and placed in cages in Pu‘u Lua Reservoir. After grow-out to a larger size, some are stocked into streams, while others are released directly into the reservoir.



**Channel catfish fingerlings,  
Sand Island, O‘ahu**

Channel catfish were stocked in Nu‘uanu Reservoir on O‘ahu, and spawned in late spring. Because other predatory fish present in the reservoir would eat any young catfish they could find, the chances of survival were low. So each spring fishery technicians went into the reservoir with scuba gear and collected as many catfish eggs as possible (the nest locations were pretty well known). The eggs were taken to Sand Island where they were raised to fingerlings, then grown out in cages in Nu‘uanu Reservoir. Eventually they were released into the reservoir.

Fish hatcheries can also be used to culture native marine fishes, which are then released into nearshore waters. This process, known as stock enhancement, is still relatively new. Experiments have been conducted with mullet, moi, mahimahi and a few other species in which fish are grown out from eggs, raised to an appropriate size, then released. The released fish are expected to help increase the sizes of existing populations.

## How You Can Help

---

The success of the state's efforts to restore nearshore fisheries, and improve both freshwater and marine fishing opportunities, depends largely on the people who fish. You can help make fishing better for the future by being a “*pono*” fisherman — an ethical angler. Your actions when fishing should be based on a respect for yourself, for others, and for the sea. Following the steps below will go a long way to helping our fish populations, and make fishing more enjoyable.

**Take only the fish you need.** The fun of fishing is in the fight; if you don't need to eat your catch, release it carefully as described earlier. Always let the small ones go, whether there's a minimum size or not.

**Know and follow current fishing regulations.** All regulations were introduced for a reason, based on our understanding of the fish's biology. If you happen to catch something that's out of season, and feel it will die anyway, throw it back. It will provide food for other fish, and you won't get busted.

**Report violations.** If you see somebody fishing illegally and don't want to confront them, call the number in the back of your fishing regulations booklet. Get a license number if possible. Not only are you helping to conserve the resource, but you might even get to keep part of the fine.

**Respect ocean life.** Don't spear fish just for the “fun” of it. Don't use illegal or unethical fishing methods that destroy or alter habitat. When diving or snorkeling leave things as you found them. When anchoring a boat don't drag the anchor over live coral. Think about the consequences of your actions, and treat all aquatic life with respect.

**Don't pollute.** Dispose of trash properly. This includes old fishing line, nets, etc. Throwing these things into the ocean presents a hazard to fish and other aquatic life, and leaving them lying around on land is dangerous to people. Besides, it's illegal.

**Respect the rights of others.** Treat other fishermen the way you'd want them to treat you. Be considerate. Don't spook their fish, tangle their lines, or do other things to take the fun out of fishing. If fishing from a boat, slow down when approaching other anglers. If crossing private property to get to a fishing spot, respect the rights of the property owner.

Fishing is a sport that can be enjoyed for a lifetime, and passed on from generation to generation. The future of fishing in Hawai'i depends on all of us.

## GOATFISH

Goatfish are bottom-feeding carnivores, easily recognized by the pair of barbels under their jaws which are used to locate food. Tucked under the sides of the jaw when not in use, the barbels may not be immediately apparent. Goatfish are common in inshore waters, and are among the most popular food fish in Hawaii.

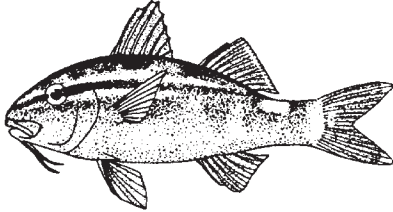

### Kūmū

*Parupeneus porphyreus*  
Whitesaddle goatfish

**Description:** Juveniles greenish with red fins, body coloration becomes brick red with age; white saddle behind soft dorsal fin; dark stripe running through eye from near snout to below first dorsal fin, darker spot between eye and upper edge of gill cover.

**Size:** Length up to 20 inches; weight generally up to 5 pounds.

**Habitat:** Various depths throughout reef areas, especially under coral heads.

**Feeding:** Nocturnal; mostly crustaceans.

**Schooling:** Small groups by day, solitary at night.

**Fishing methods:** Spear, trap, net, handline, pole and line.

**Seasonality:** Young kūmū common on inshore reefs throughout spring and summer; adults common year round.

Kūmū are extremely prized fish in Hawai'i; the flesh is considered a delicacy.

Endemic to Hawai'i.

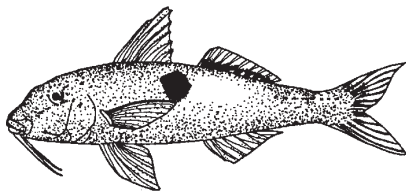

### Malu

*Parupeneus pleurostigma*  
Sidespot goatfish

**Description:** Body light, whitish to pink; black spot on side below rear of first dorsal fin, followed by large oval white area.

**Size:** Length up to 16 inches; weight generally up to 2 pounds.

**Habitat:** Sandy patches adjacent to coral, from nearshore to depths of about 120 feet.

**Feeding:** Diurnal; small worms, crustaceans.

**Schooling:** Adults solitary; juveniles small groups.

**Fishing methods:** Handline, spear, trap, net.

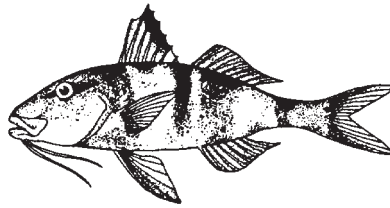

### Moano

*Parupeneus multifasciatus*  
Manybar goatfish

**Description:** Reddish with shades of yellow and white; black marks behind eye, at base of pectoral fin, and black saddle areas in front of first dorsal fin, between dorsal fins, below soft dorsal fin, and in front of tail; deepness of color varies with light intensity, becoming lighter in bright light.

**Size:** Length up to 14 inches; weight generally up to 1 pound.

**Habitat:** Rocky areas, sandy bottoms near coral heads.

**Feeding:** Diurnal; crustaceans, small fish.

**Schooling:** Solitary or small groups.

**Fishing methods:** Handline, trap, spear, pole and line.

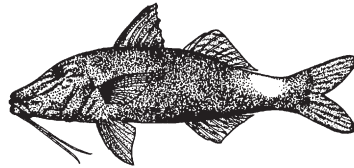

### Moano kea

*Parupeneus cyclostomus*  
Moana kali, blue goatfish

**Description:** Bluish-purple, with prominent yellow saddle at base of tail; slender body, long snout and long barbels.

**Size:** Length up to 2 feet; weight generally up to 5 pounds.

**Habitat:** Rocky or reef areas, from nearshore to depth of about 200 feet.

**Feeding:** Diurnal; small fish, crustaceans.

**Schooling:** Adults small groups; juveniles solitary.

**Fishing methods:** Handline, spear, trap, net, pole and line

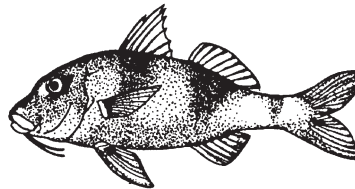

### Munu

*Parupeneus bifasciatus*  
Doublebar goatfish, Joe Louis

**Description:** Reddish to yellowish-gray; black triangular saddle under each dorsal fin and near tail.

**Size:** Length up to 16 inches; weight generally up to 3 pounds.

**Habitat:** Rocky areas, especially lava rocks, from nearshore to about 150 feet.

**Feeding:** Diurnal and nocturnal; small fish, crustaceans.

**Schooling:** Solitary or small groups.

**Fishing methods:** Handline, spear, trap, net, pole and line.

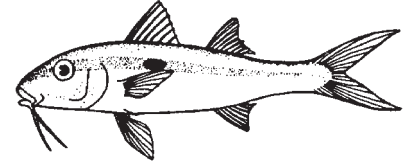

### Weke 'ā, 'oama

*Mulloides flavolineatus*  
White weke, yellowstripe goatfish

**Description:** Silvery white; yellow band extends from eye to tail when schooling; band becomes less distinct when feeding, and a black spot appears below first dorsal fin; very slender body compared with most other goatfish.

**Size:** Length up to 18 inches; weight generally up to 2 pounds.

**Habitat:** Sandy bottom areas near coral patches; shallow water (to about 100 feet).

**Feeding:** Nocturnal and diurnal; crustaceans, worms.

**Schooling:** Schools by day.

**Fishing methods:** 'Oama (juveniles) taken by pole and line; adults by net, trap, pole and line, spear.

**Seasonality:** 'Oama commonly found in shallow sandy areas during late summer; adult weke common year round.

'Oama make excellent bait for papio and other predators, and are highly sought by shoreline fishermen.

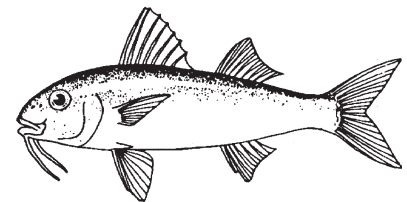

### Weke 'ula, 'oama

*Mulloides vanicolensis*  
Red weke, yellowfin goatfish

**Description:** Light pink with yellow hues; long yellow band extending from eye to base of tail; fish becomes reddish when dead; inner lining of abdomen is black.

**Size:** Length up to 16 inches; weight generally up to 2 pounds.

**Habitat:** Reef areas, generally in depths from 20-200 feet.

**Feeding:** Nocturnal; small worms and crustaceans.

**Schooling:** Large schools during the day; solitary or small groups at night when feeding.



**Fishing methods:** Mostly net and trap.

**Seasonality:** Juveniles, known as 'oama, common offshore in late summer; adults common year round.

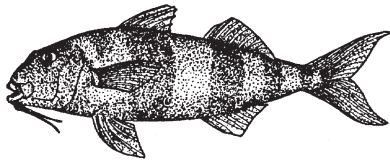

### Weke nono

*Mulloides pflugeri*

Weke 'ula, moelua, Pfluger's goatfish

**Description:** Red with vertical orange-yellow bands when alive; color changes to uniform red when dead; inner lining of abdominal cavity white; fairly robust compared with most other goatfish.

**Size:** Length up to 24 inches; weight generally up to 8 pounds.

**Habitat:** Sand patches and limestone bottoms, usually 60-300 feet.

**Feeding:** Diurnal; small fish and crustaceans.

**Schooling:** Small groups or large schools.

**Fishing methods:** Handline, trap, spear.

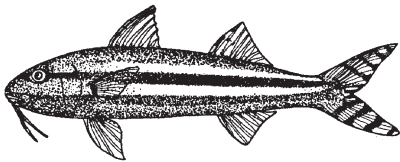

### Weke pueo

*Upeneus spp.*

Nightmare weke, bandtail goatfish

**Description:** Light greenish above, fading to white below; black and white horizontal stripes on tail.

**Size:** Length up to 12 inches

**Habitat:** Shallow sandy or muddy bottoms.

**Feeding:** Diurnal; crustaceans and small fish.

**Schooling:** Small group

**Fishing methods:** Pole and line, net, spear.

Weke pueo should be prepared and eaten with care, since the head may cause hallucinations and other symptoms of poisoning if consumed.

## SURGEONFISH

Surgeonfish (tang) have blade-like spines on either side of the base of the tail, which are sometimes used defensively by the fish. (Fishermen have suffered cuts on their account, so surgeonfish should always be handled with care.) Surgeonfish are very common in inshore waters, feeding primarily by day, and at night resting on the bottom in a sleep-like state. Because they are mostly plant eaters, having small mouths and specialized teeth, most surgeonfish are difficult to catch with hook and line.

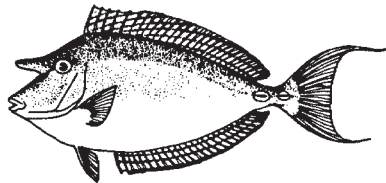

### Kala

*Naso unicornis*

Bluespine unicornfish

**Description:** Dusky olive, with light blue on the fins and around the caudal spines; horn protruding from front of head about eye level (lengthens with age). A similar species, *Naso brevirostris*, is grayish green with numerous small spots or dark lines on the sides, and a body that is less deep. Kala have two fixed caudal spines on each side.

**Size:** Length up to 2 feet; weight generally up to 8 pounds.

**Habitat:** Inshore reef areas and along rocky shores.

**Feeding:** Diurnal; algae, especially more leafy varieties.

**Schooling:** Schools; large adults sometimes found singly at edge of reef.

**Fishing methods:** Net, spear, pole and line.

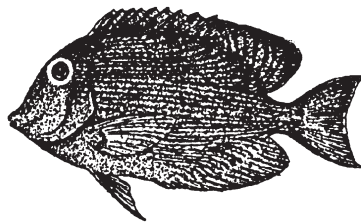

### Kole

*Ctenochaetus strigosus*

Goldring surgeonfish

**Description:** Dark brown with about 35 light blue horizontal lines extending into the fins, small blue spots on the head, bright yellow ring around the eye; single retractable caudal spine on each side.

**Size:** Length up to 7 inches; weight generally up to ½ pound.

**Habitat:** Inshore reef areas, and depths of 150 feet or more.

**Feeding:** Diurnal, small bits of algae and decaying plant material.

**Schooling:** Solitary.

**Fishing methods:** Spear.

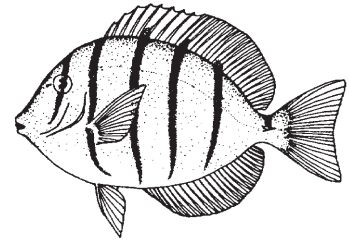

### Manini

*Acanthurus triostegus sandvicensis*

Convict tang

**Description:** Silvery, may have yellowish tinge; six black vertical bars, the first passing through the eye and the last near the base of the tail; single small retractable caudal spine on each side.

**Size:** Length up to 12 inches; weight generally up to ¾ pound.

**Habitat:** Most reef areas, from shore to depths of about 90 feet.

**Feeding:** Diurnal; mostly fine algae.

**Schooling:** Large schools, but also seen singly or in small schools.

**Fishing methods:** Net, spear.

Manini are the most abundant surgeonfish in Hawai'i.

Endemic to Hawai'i.

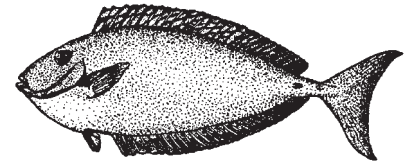

### 'Ōpelu kala

*Naso hexacanthus*

Sleek unicornfish

**Description:** Color varies from dark brown to pale blue, with a dark blue tail fin; two fixed caudal spines on each side.

**Size:** Length up to 2 feet; weight generally up to 3 pounds.

**Habitat:** Deeper waters outside reef; not common in waters less than 30 to 50 feet.

**Feeding:** Diurnal; plankton, including crab larvae and small worms.

**Schooling:** Large schools.

**Fishing methods:** Spear, net, pole and line.



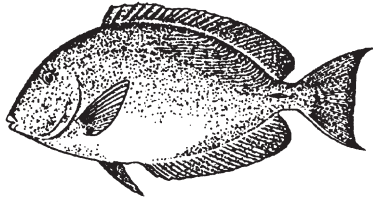

### Palani

*Acanthurus dussumieri*  
Eyestripe surgeonfish

**Description:** Yellowish brown with black spots, bright blue tail fin, fine blue lines on body fading towards belly, yellow dorsal and anal fins, yellow band between and behind the eyes; single white retractable caudal spine on each side, surrounded by a patch of black.

**Size:** Length up to 18 inches or more; weight generally up to 3 pounds.

**Habitat:** Mostly bays and outer reef areas over sandy patches, usually at depths of at least 10 feet.

**Feeding:** Diurnal; algae and decaying plant material.

**Schooling:** Schools.

**Fishing methods:** Spear, trap.

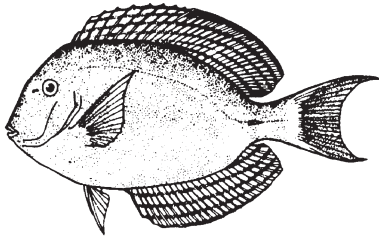

### Pualu

*Acanthurus spp.*  
Ringtail surgeonfish, yellowfin surgeonfish

**Description:** Purplish gray, sometimes with irregular dark stripes along the sides, dorsal and anal fins have horizontal blue bands, yellow spot between eye and top of gill cover; single black retractable caudal spine on each side.

**Size:** Length up to 20 inches or more; weight generally up to 5 pounds.

**Habitat:** Bays and harbors; also deep outer reefs with sandy patches, usually at depths of 30 feet or more.

**Feeding:** Diurnal; mostly algae, but often hooked with animal material as bait.

**Schooling:** Schools.

**Fishing methods:** Spear, net, handline.

## WRASSES

Wrasses make up the largest family of fishes in Hawaii. Nearly 50 species are known to exist here, but only a few are popular with fishermen. Males and females of the same species frequently have different colorations, and wrasses are known to undergo sex conversions from female to male. Coloration changes as the fish gets older.

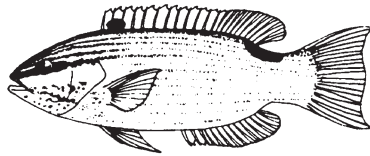

### 'A'awa

*Bodianus bilunulatus*  
Hawaiian hogfish, table boss

**Description:** Juveniles (up to 4 inches) whitish with reddish brown horizontal lines and large black spot between soft dorsal and anal fins; as fish grows older spot disappears and black saddle forms at rear of dorsal fin; females white with brown horizontal lines in front, shading to yellow near tail; males wine-colored or purplish brown, and black saddle is faint or absent.

**Size:** Length up to 2 feet; weight generally up to 4 pounds.

**Habitat:** Common throughout reef area, taken on bottom in shallow water out to depths of about 100 feet or more.

**Feeding:** Diurnal; small fish, crustaceans, molluscs, sea urchins.

**Schooling:** Solitary.

**Fishing methods:** Handline, spear, pole and line.



### Hinālea lauili

*Thalassoma duperrey*  
Saddle wrasse

**Description:** Green with vertical purple-red bars, purplish blue head and wide orange saddle surrounding body just behind head; saddle not apparent on juveniles.

**Size:** Length up to 1 foot; weight generally up to ½ pound.

**Habitat:** Very abundant along shallow rocky shorelines and reef areas.

**Feeding:** Diurnal; seaweed, crustaceans.

**Schooling:** Solitary or small aggregate.

**Fishing methods:** Pole and line, handline. Generally an incidental catch; food value considered poor, often used as bait. Endemic to Hawai'i.

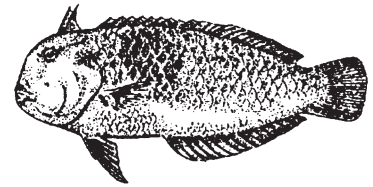

### Laenihi

*Xyrichtys umbrilatus*  
Blackside razorfish, nabeta

**Description:** Blue-green or grayish body with faint vertical crossbands, one dark scale on either side below front of dorsal fin, yellow stripe on anal fin.

**Size:** Length up to 15 inches; weight generally up to 2 pounds.

**Habitat:** Sandy areas at depths of 60 to 300 feet, generally within a few hundred yards of the shoreline.

**Feeding:** Diurnal; crustaceans.

**Schooling:** Solitary.

**Fishing methods:** Handline.

Considered an excellent food fish.

Endemic to Hawai'i.

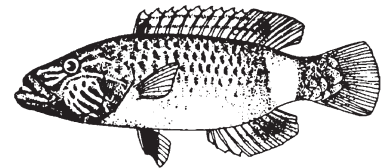

### Po'ou

*Oxycheilinus unifasciatus*  
Ringtail wrasse

**Description:** Color varies with age; at 10 inches the fish is plain olive green with white saddle near tail; fish 20 inches and over have no white saddle, but show black spots at base of dorsal and anal fins, and have dark pelvic fins.

**Size:** Length up to 2 feet; weight generally up to 2 pounds.

**Habitat:** Reef and rocky areas at depths of up to 40 or 50 feet.

**Feeding:** Diurnal; fish and crustaceans.

**Schooling:** Solitary.

**Fishing methods:** Handline, spear.

## MULLET

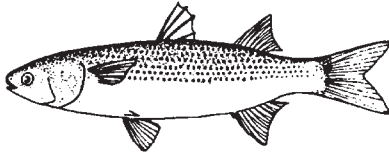

### 'Ama'ama, pua

*Mugil cephalus*  
Striped mullet

**Description:** Body silver with grayish-green above changing to white below, reddish tinge around mouth and gills. A similar species, *Chelon engeli* (summer or Australian mullet), is smaller than the amaama, growing to a length of about 8 inches, and has slightly larger scales.

**Size:** Length up to 2 feet; weight generally up to 5 pounds.

**Habitat:** Calm waters close to shore, around mouths of streams and inlets, and brackish bays and harbors.

**Feeding:** Diurnal; algae and small plants, especially along bottom.

**Schooling:** Schools.

**Fishing methods:** Generally taken with nets; difficult to catch with pole and line, but will take a hook baited with thin seaweed or bread.

**Seasonality:** Spawns December through February.

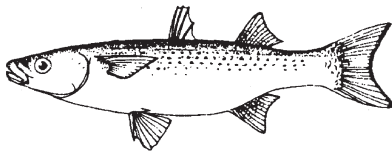

### Uouoa

*Neomyxus leuciscus*  
Sharpnose mullet

**Description:** Grayish back, changing to silver on the sides, white belly; yellow spot present at base of pectoral fins; snout more pointed than 'ama'ama.

**Size:** Length up to 16 inches; weight generally up to 1½ pounds.

**Habitat:** Sandy shores, tide pools, rocky surge areas.

**Feeding:** Diurnal; seaweed, some crustaceans.

**Schooling:** Schools.

**Fishing methods:** Net.

**Seasonality:** More common November through March.

## BARRACUDAS



### Kākū

*Sphyaena barracuda*  
Great barracuda

**Description:** Greyish back turning silvery on sides and belly, with irregular black flecks on sides.

**Size:** Length up to 6 feet; weight generally up to 70 pounds.

**Habitat:** Various, inshore and offshore; juveniles prefer brackish water areas, bays and stream mouths.

**Feeding:** Diurnal and nocturnal; fish and squid.

**Schooling:** Generally solitary.

**Fishing methods:** Generally caught casting from shore, trolling lures and baits, and handlining from boats. Prominent sharp teeth make a wire leader essential, and the fish should be regarded with caution.



### Kawale'ā

*Sphyaena helleri*  
Heller's barracuda

**Description:** Silvery olive above, becoming silvery on sides and belly; sides marked with two horizontal yellowish stripes which disappear after death. Smaller than kaku, with more slender head and larger eyes.

**Size:** Length up to 2 feet; weight generally up to 4 pounds.

**Habitat:** Inshore to depths of 50 to 200 feet.

**Feeding:** Nocturnal; small fish.

**Schooling:** Large schools.

**Fishing methods:** Mostly handline.

## NEARSHORE SNAPPERS

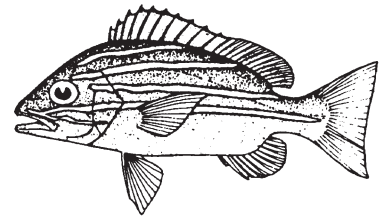

### Ta'ape

*Lutjanus kasmira*  
Bluestripe snapper

**Description:** Bright lemon yellow with four pale-blue horizontal stripes edged with lavender or deep purple.

**Size:** Length up to 15 inches; weight generally up to 1½ pounds.

**Habitat:** Hard bottom areas, generally in waters 40 to over 300 feet deep.

**Feeding:** Primarily nocturnal; shrimp and other crustaceans, squid, and small fish.

**Schooling:** Schools.

**Fishing methods:** Generally taken at night with handlines; some taken in traps or nets; occasionally by pole and line near shore and by spear.

Introduced 1958 and 1961 from Marquesas Islands and Society Islands.

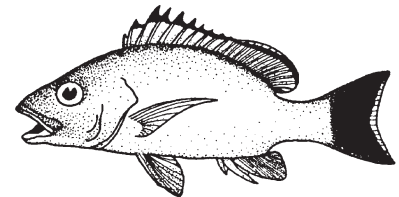

### To'au

*Lutjanus fulvus*  
Blacktail snapper

**Description:** Dusky yellow above fading to pale yellow or white below, six or more thin horizontal yellow stripes along side; dorsal fin reddish, tail fin blackish with reddish tinge and white margin; other fins yellow.

**Size:** Length up to 13 inches; weight generally up to 3 pounds.

**Habitat:** Inshore, brackish water and around stream mouths out to waters about 40 or 50 feet in depth.

**Feeding:** Nocturnal; crustaceans, especially crabs, and small fish.

**Schooling:** Solitary or small school.

**Fishing methods:** Handline, pole and line, trap, spear.

Introduced 1956 and 1958 from Society Islands.

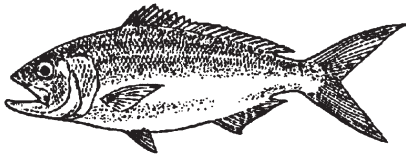

### Wahanui

*Aphareus furca*  
Smalltooth jobfish, gurutsu

**Description:** Uniform steel blue or purplish, with yellow border on anal fin.  
**Size:** Length up to 2 feet; weight generally up to 2 pounds.  
**Habitat:** Open water, generally just outside or above reef.  
**Feeding:** Diurnal; small fish and crustaceans.  
**Schooling:** Solitary or small school.  
**Fishing methods:** Pole and line, handline, spear.

## OTHER REEF FISHES

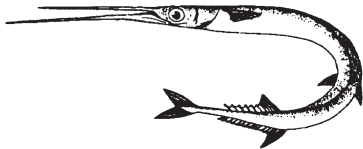

### 'Aha

Belonidae  
Needlefish

**Description:** Blue green on back, fading to silvery below; jaws long and pointed, with sharp teeth.  
**Size:** Length depends on species, 15 inches to more than 4 feet; weight generally up to 5 pounds.  
**Habitat:** Near surface in waters of various depths from nearshore to open ocean.  
**Feeding:** Diurnal and nocturnal; small fish near the surface, floating crabs.  
**Schooling:** Schools.  
**Fishing methods:** Pole and line.  
Aha can be dangerous at night; they are attracted to lights and have been known to spear people.

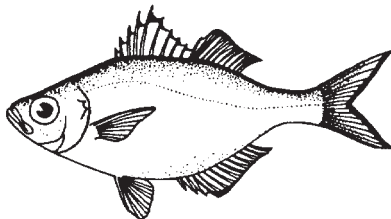

### Āholehole

*Kuhlia sandvicensis*  
Hawaiian flagtail

**Description:** Silvery, with blue tones on back, fins often dusky tipped.  
**Size:** Length up to 12 inches; weight generally up to 1 pound.

**Habitat:** Inshore areas, including streams, bays and along shoreline; generally found at depths less than 20 feet; juveniles live in tide pools or schools close to shore.

**Feeding:** Mostly nocturnal; primarily crustaceans.

**Schooling:** Schools.

**Fishing methods:** Pole and line, cast nets, spear.

**Seasonality:** More taken during fall and winter.

Endemic to Hawai'i.

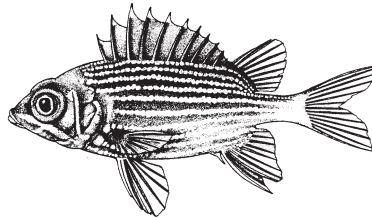

### 'Ala'ihī

*Sargocentron* and *Neoniphon* spp.  
Squirrelfish

**Description:** Bright red, fading to lighter below in some species; sides marked with six or more light horizontal lines; most species take on prominent nocturnal coloration, generally white spots or vertical bands.

**Size:** Length up to 12 inches or more, depending on species; weight up to 5 pounds for largest species.

**Habitat:** Inshore reef areas, congregating in crevices and caves by day and foraging over the reef at night.

**Feeding:** Nocturnal; crustaceans.

**Schooling:** Solitary or grouped, depending on species.

**Fishing methods:** Spear, handline, pole and line, trap.

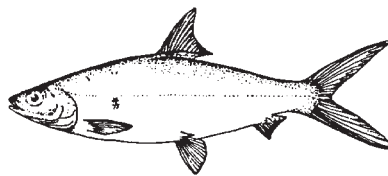

### Awa

*Chanos chanos*  
Milkfish

**Description:** Grayish green above, fading to silvery below.

**Size:** Length up to 3 feet or more; most caught are around 18 to 24 inches; weight generally up to 40 pounds.

**Habitat:** Near surface in inshore areas, including brackish-water areas, bays and inlets.

**Feeding:** Diurnal; algae.

**Schooling:** Schools.

**Fishing methods:** Pole and line, net.

**Seasonality:** Generally more taken in summer months.



### Awa'aua

*Elops hawaiiensis*  
Hawaiian tenpounder

**Description:** Bright silvery, with blue-green hue on the dorsal area.

**Size:** Length up to 3 feet or more; weight generally up to 12 pounds.

**Habitat:** Inshore areas, including bays and harbors, and along sandy shorelines.

**Feeding:** Diurnal and nocturnal; small fish and crustaceans.

**Schooling:** Singly or in small schools.

**Fishing methods:** Pole and line, net.

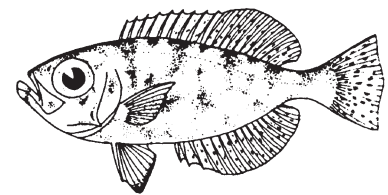

### Āweoweo

Priacanthidae  
Bigeye, glasseye

**Description:** Variable coloration, from deep red to silvery, or mottled silvery pink and red; fins often speckled with black; some species plain red by day.

**Size:** Length depends on species, up to 20 inches; weight generally up to 3 pounds.

**Habitat:** Shallow reefs out to deep boulder areas.

**Feeding:** Nocturnal; small fish and invertebrates.

**Schooling:** Solitary or schools.

**Fishing methods:** Pole and line, handline, spear, net.

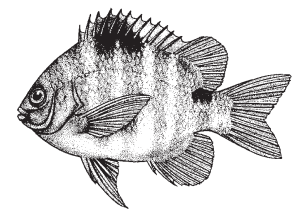

### Kūpīpī

*Abudefduf sordidus*  
Blackspot sergeant

**Description:** Grayish brown above fading to silvery below; sides marked with seven dark vertical bands; dark spot on upper side of caudal peduncle and at base of dorsal fin.

**Size:** Length up to 9 inches; weight generally up to 1 pound.

**Habitat:** Inshore reef and boulder areas; shallow rock crevices; juveniles common in tide pools.



**Feeding:** Diurnal; algae, small crustaceans and other invertebrates.  
**Schooling:** Solitary or small schools.  
**Fishing methods:** Pole and line, spear.

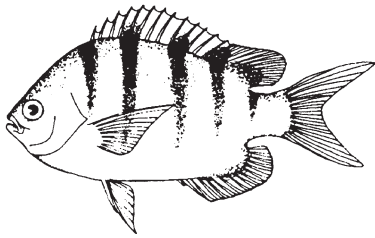

**Mamo**  
*Abudefduf abdominalis*  
 Hawaiian sergeant

**Description:** Pale brassy or green with four or five black vertical bars; belly white with yellow tinge near anal fin.  
**Size:** Length up to 9 inches; weight generally up to ¾ pound.  
**Habitat:** Shallow water reefs, harbors and bays, from nearshore to edge of reef.  
**Feeding:** Diurnal; small crustaceans, plankton.  
**Schooling:** Loose aggregates.  
**Fishing methods:** Pole and line, spear.  
 Endemic to Hawai'i.

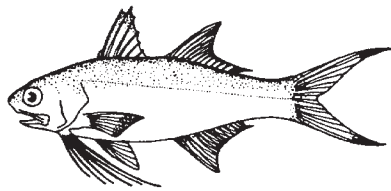

**Moi**  
*Polydactylus sexfilis*  
 Six-fingered threadfin

**Description:** Dusky above, silvery on sides and belly, with numerous narrow wavy horizontal lines along sides; fins black-tipped; characterized by presence of six long filaments extending from base of each pectoral fin, and overhanging snout.  
**Size:** Length up to 24 inches; weight generally up to 6 pounds.  
**Habitat:** Generally found in sandy holes along rocky shorelines, or along sandy beaches in surge areas.  
**Feeding:** Diurnal and nocturnal; primarily crustaceans.  
**Schooling:** Schools.  
**Fishing methods:** Pole and line, net.  
**Seasonality:** Spawn during summer months; from about May through August small moi (or moi-li'i) occur in schools along beaches and in sheltered coves.

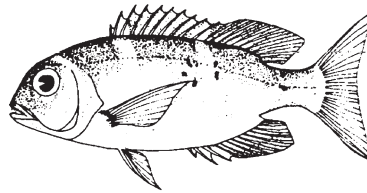

**Mū**  
*Monotaxis grandoculis*  
 Bigeye emperor

**Description:** Olive gray above fading to silvery below; sides marked with four light vertical bands which fade as fish gets older; inside of mouth red.  
**Size:** Length up to 30 inches; weight generally up to 5 pounds.  
**Habitat:** Various reef areas, generally moving into shallower waters during evening.  
**Feeding:** Nocturnal; small mollusks and crustaceans.  
**Schooling:** Solitary or loose aggregates.  
**Fishing methods:** Pole and line, spear.

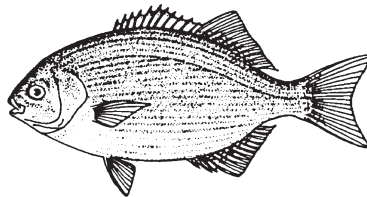

**Nenuē**  
*Kyphosus spp.*  
 Nenuē, sea chub, rudderfish

**Description:** Gray brown with blue reflections above, fading to lighter below; narrow dark bands on sides between scale rows; some fish have irregular yellow blotches on sides, and on rare occasions a fish may be entirely yellow.  
**Size:** Length up to 24 inches; weight generally up to 6 pounds.  
**Habitat:** Rough and turbulent waters along rocky coasts.  
**Feeding:** Diurnal; mostly algae.  
**Schooling:** Schools.  
**Fishing methods:** Spear, net, pole and line.

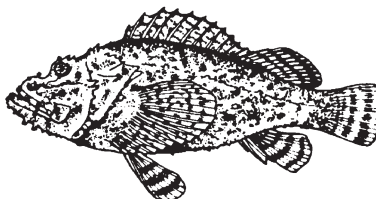

**Nohu**  
*Scorpaenopsis cacopsis*  
 Scorpionfish

**Description:** Mottled camouflage coloration, reddish brown with irregular white and yellow hues, fading to lighter below; spines venomous.

**Size:** Length up to 20 inches or more; weight generally up to 5 pounds.  
**Habitat:** Outer edges of reef in water over 20 feet deep.  
**Feeding:** Diurnal; small fish and invertebrates.  
**Schooling:** Solitary, sedentary.  
**Fishing methods:** Spear, pole and line.

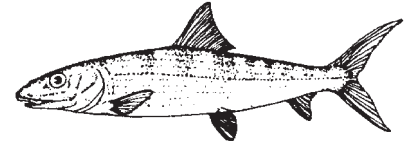

**Ō'io**  
*Albula spp.*  
 Bonefish

**Description:** Bright iridescent silver, with greenish tinge on dorsal area; elongate upper jaw.  
**Size:** Length generally up to about 18 inches; may reach over 40 inches; weight generally up to 16 pounds.  
**Habitat:** Sandy bottoms, usually over sand patches or channels in reef areas.  
**Feeding:** Generally nocturnal; crustaceans, small fish.  
**Schooling:** Schools.  
**Fishing methods:** Pole and line, net, handline.  
**Seasonality:** More taken December through April.



**Pāki'i**  
*Bothus spp.*  
 Flounder

**Description:** Brownish coloration with irregular mottling, lower surface white or tan; coloration changes to match substrate.  
**Size:** Length up to 16 inches; weight generally up to 4 pounds.  
**Habitat:** Sandy patches in shallow water.  
**Feeding:** Diurnal; crustaceans and small fish.  
**Schooling:** Solitary.  
**Fishing methods:** Pole and line, spear.

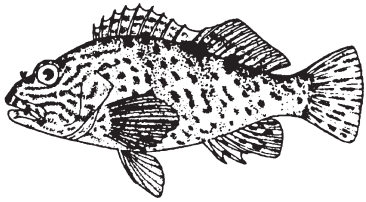

### Po'opa'a

*Cirrhitus pinnulatus*

Stocky hawkfish

**Description:** Brownish above fading to lighter below, with white mottlings; body and fins have red spots; head bluish white with brownish orange markings.

**Size:** Length up to 10 inches; weight generally up to 1½ pounds.

**Habitat:** Hides in crevices during the day; at night found in turbulent waters of surge zones, often on large rocks or coral heads.

**Feeding:** Diurnal and nocturnal; small fish and crustaceans.

**Schooling:** Solitary.

**Fishing methods:** Pole and line, spear.



### Puhu

*Gymnothorax spp.*

Moray eel

**Description:** Coloration varies with species; generally brown (darker toward posterior) with numerous round or irregular light spots, depending on species; large fanglike teeth.

**Size:** Length up to 5 or 6 feet; most under 2 feet; weight occasionally reaches 70 pounds.

**Habitat:** Crevices and holes in rocky or reef areas; rarely exposed, except for head.

**Feeding:** Diurnal and nocturnal; fish and crustaceans.

**Schooling:** Solitary.

**Fishing methods:** Spear, pole and line, trap.



### Puhu ūhā

*Conger cinereus*

White eel, mustache conger, tohe

**Description:** Grayish brown on dorsal surface, fading to lighter below, alternating light and dark bars on body when feeding; well-developed pectoral fins are present.

**Size:** Length up to 5 feet; weight generally up to 25 pounds.

**Habitat:** Crevices and holes in nearshore reef areas by day; moves in open on reef after dark.

**Feeding:** Nocturnal; fish and crustaceans.

**Schooling:** Solitary.

**Fishing methods:** Spear, pole and line, trap.

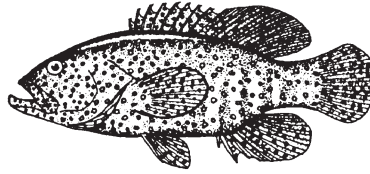

### Roi

*Cephalopholis argus*

Peacock grouper

**Description:** Purple brown with light blue spots; pale vertical bars present towards tail region, fins edged with yellow.

**Size:** Length up to 20 inches; weight generally up to 5 pounds.

**Habitat:** Reefs and rocky areas at depths of about 10 to 40 fathoms, generally near ledges and crevices.

**Feeding:** Diurnal; fish.

**Schooling:** Solitary.

**Fishing methods:** Spear, trap, handline  
Introduced 1956 and 1961 from Society Islands.

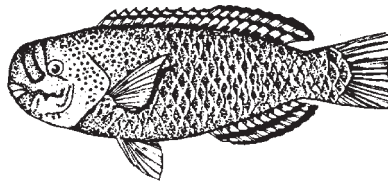

### Uhu

Scaridae

Parrotfish

**Description:** Coloration varies with species, sex and age; males are generally more gaudy, with colors dominated by blues and greens, females are generally more bland with colors dominated by reddish browns or grays; teeth are fused together and resemble a beak.

**Size:** Length up to 2 feet or more; weight generally up to 15 pounds.

**Habitat:** Rocky areas and coral reefs, usually more abundant at outer edge of reef.

**Feeding:** Diurnal; algae, crustaceans.

**Schooling:** Solitary or small groups; juveniles tend to school.

**Fishing methods:** Spear, net.

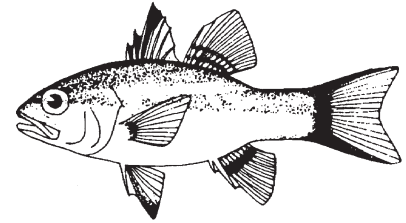

### 'Upāpalu

*Apogon spp.*

Cardinalfish

**Description:** Coloration varies with species; generally light red or brown with iridescent hues; dark horizontal bands present in some species.

**Size:** Length up to about 7 inches, depending on species; weight generally up to ¼ pound.

**Habitat:** Nearshore caves and crevices.

**Feeding:** Nocturnal; small crustaceans.

**Schooling:** Solitary when feeding..

**Fishing methods:** Pole and line

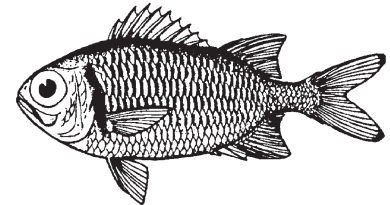

### Ūū

*Myripristis spp.*

Soldierfish, menpachi

**Description:** Bright red by day, lower sides become silvery at night.

**Size:** Length up to 14 inches; weight generally up to 1 pound.

**Habitat:** Inshore reef areas, congregating in caves and crevices during the day.

**Feeding:** Nocturnal; plankton, crustaceans.

**Schooling:** Schools.

**Fishing methods:** Spear, handline, net, trap.

**Seasonality:** Spawns late spring to mid-summer; generally more taken in late summer and early fall.



## CARANGIDS

(Jacks and their allies)

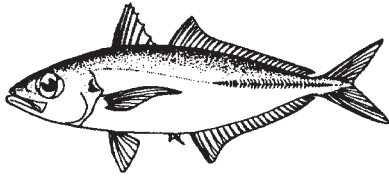

### Akule, halalū

*Selar crumenophthalmus*  
Bigeye scad, aji

**Description:** Silvery blue above fading to silvery white below, yellow tail fin; very large eyes.

**Size:** Length up to 15 inches; weight generally up to 2 pounds.

**Habitat:** Mid- or surface waters along coast, or shallow banks near shore.

**Feeding:** Nocturnal; small crustaceans.

**Schooling:** Large schools.

**Fishing methods:** Halalū (juveniles up to about 5 inches) taken with light tackle; akule are generally taken handlining at night, or by day with net or pole and line.

**Seasonality:** Spawn from about March through October, at which time they form large schools in shallow water; halalū .common about July to December  
An excellent food fish.

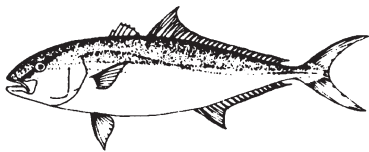

### Kāhala

*Seriola dumerili*  
Greater amberjack

**Description:** Light metallic brown with purplish tinge; light yellow horizontal band extends from head to base of tail, fades after fish is caught; dark diagonal streak through eye.

**Size:** Length up to 6 feet; weight generally up to 120 pounds.

**Habitat:** Deeper coastal waters, typically 60 to 600 feet or more; lives near bottom; young often found around floating objects at sea.

**Feeding:** Diurnal and nocturnal; fish and squid.

**Schooling:** Solitary or small school.

**Fishing methods:** Caught mostly by fishing over deep-sea ledges or drop offs; usually taken handlining offshore, but often come close enough to shore to be caught with baitcasting gear; occasionally by spear or trap.



### Kamanu

*Elagatis bipinnulatus*  
Rainbow runner

**Description:** Dark blue above followed in succession down side by light blue stripe, yellow stripe, another light blue stripe; yellow silver below, yellow fins.

**Size:** Length up to 4 feet; weight generally up to 10 pounds.

**Habitat:** Open water, usually near surface; may be found with other fish around floating objects.

**Feeding:** Diurnal; fish and squid.

**Schooling:** Solitary or small school.

**Fishing methods:** Trolling with small lures or baits, by handline, or from shore with baitcasting gear.

Considered an excellent food fish.

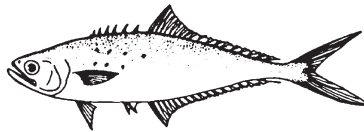

### Lai

*Scomberoides lysan*  
Leatherback

**Description:** Slate blue above, fading to silvery below; fins may have yellowish tinge; leathery skin with small needle-like scales.

**Size:** Length up to 2 feet; weight generally up to 2 pounds.

**Habitat:** Inshore coastal waters, sheltered bays and harbors, brackish water areas near mouths of streams.

**Feeding:** Diurnal; smaller schooling fishes, especially mullet and nehu, crustaceans.

**Schooling:** Schools near the surface.

**Fishing methods:** Often caught by shore anglers casting bait or lures for young jacks; also by net; should be handled carefully because of sharp anal spines  
Not widely sought after for food; skin is valued for making trolling lures.

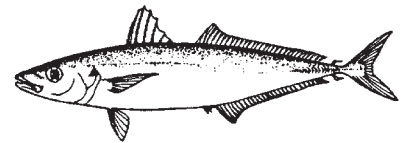

### Ōpelu

*Decapterus macarellus*  
Mackerel scad

**Description:** Bluish or greenish yellow above fading to silvery white below, dark spot on upper part of gill cover.

**Size:** Length up to 20 inches; weight generally up to 2 pounds.

**Habitat:** Near coast in surface and mid-water; juveniles school far out at sea.

**Feeding:** Diurnal and nocturnal; plankton, especially small crustaceans.

**Schooling:** Schools.

**Fishing methods:** Caught by handline at night, and with special lift nets during the day.

**Seasonality:** Spawns from about March to the middle of August; juveniles enter coastal areas in late fall and winter  
Considered an excellent food fish; also popular as bait and live chum for large tuna, marlin, and other predators.

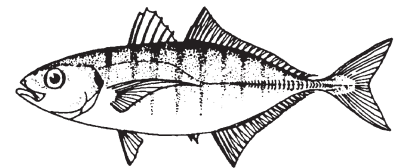

### Ōmaka

*Atule mate*  
Yellowtail scad

**Description:** Silvery body with greenish yellow tinge, marked with 9 or 10 darker vertical bars; yellow tail, black spot behind eye on edge of gill cover.

**Size:** Length up to one foot; weight generally up to ¾ pound.

**Habitat:** Protected bays and estuaries; juveniles very abundant in fall around floating objects, especially jellyfish; not found in open sea.

**Feeding:** Diurnal; plankton, mostly small fish and crustaceans.

**Schooling:** Schools.

**Fishing methods:** Mostly taken with light tackle from shore and piers; occasionally taken with net.

**Seasonality:** More common March to October.

Considered an excellent food fish.

## ULUA

Like other carangids, ulua are fast-swimming predators, feeding on a variety of fish and crustaceans. Juveniles, known collectively as pāpio, tend to live close to shore for protection, then move toward deeper waters as they get older. Ulua are extremely popular gamefish, and the flesh is very good to eat.

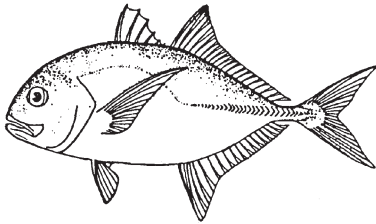

### Ulua aukea

*Caranx ignobilis*  
White ulua, giant trevally

**Description:** Pale olive above with greenish tinge around head, white sides, yellow anal fin; color varies to darker shades, depending on fish's temperament and time of day; breast nearly scaleless except for patch of about 10 scales in middle.

**Size:** Length over 5 feet; weight generally up to 120 pounds.

**Habitat:** Pāpio caught near shore, adult fish found over nearshore reefs; often hiding in caves during the day.

**Feeding:** Nocturnal, but occasionally caught by day; fish, octopus, crustaceans.

**Schooling:** School; when large (over 30 pounds) generally solitary or in pairs.

**Fishing methods:** Casting from rocky shores and ledges; handline, trap, spear.

**Seasonality:** Young common in summer, adults common year round.

An excellent food fish, the white ulua is widely considered to be the ultimate shoreline gamefish.

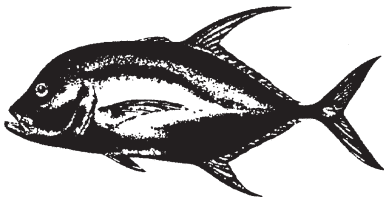

### Ulua lā'uli

*Caranx lugubris*  
Black trevally

**Description:** Dark brown, with almost black head; may tend toward a creamy or dusky shade; breast completely scaled, scutes distinct; definite notch above snout in profile.

**Size:** Length over 3 feet.

**Habitat:** Outer reef channels.

**Feeding:** Nocturnal; fish and crustaceans.

**Schooling:** Form large schools when feeding.

**Fishing methods:** Casting from rocky shores and ledges.

**Seasonality:** Uncommon year round in main Hawaiian Islands.

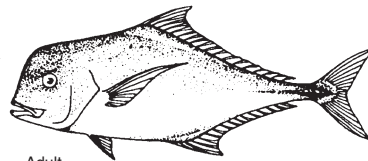

Adult

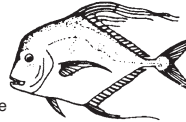

Juvenile

### Ulua kihikihi

*Alectis ciliaris*  
Threadfin jack, kagami ulua

**Description:** Adults dusky white, often darker along dorsal area, with bluish, greenish, and yellowish hues; juveniles silvery blue above and bright silver below, with a diamond shaped body and long trailing filaments extending from dorsal and anal fins; as fish gets older body becomes more elongate, and filaments begin to disappear.

**Size:** Length up to 40 inches; weight generally up to 40 pounds.

**Habitat:** Juveniles often found in harbors and other sheltered waters, upon reaching maturity move to deeper and more open water, often taken from depths of 60 to 200 feet.

**Feeding:** Diurnal; mostly crustaceans.

**Schooling:** Solitary or small school.

**Fishing methods:** Handline.

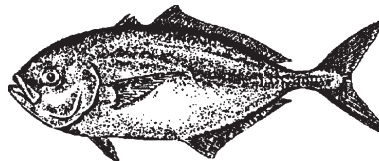

### Ulua

*Uraspis helvola*  
Cottonmouth jack, dobe ulua

**Description:** Dark dusky color, easily identified by looking inside mouth; tongue and roof of mouth are white, back of mouth and throat and gill areas are bluish black.

**Size:** Length up to 20 inches; weight generally up to 3 pounds.

**Habitat:** Dropoff areas, generally 100 to 200 feet.

**Feeding:** Nocturnal; small fish and crustaceans.

**Schooling:** Schools.

**Fishing methods:** Handline.

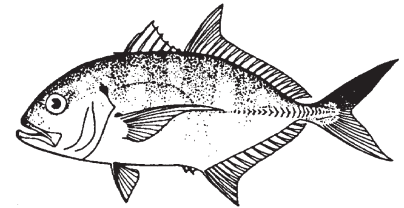

### Pake ulua

*Caranx sexfasciatus*  
Bigeye trevally, menpachi ulua, sasa

**Description:** Dark blue-green to gold above, yellow-green to silver below, upper lobe of tail fin dark with black tip; juveniles have four to seven dark vertical bands.

**Size:** Length usually under 3 feet; weight generally up to 15 pounds.

**Habitat:** Young fish found in brackish water areas out to deeper coastal waters; adult fish live along rocky shores in turbulent water over reefs.

**Feeding:** Nocturnal; fish and crustaceans

**Schooling:** Solitary.

**Fishing methods:** Handline; juveniles taken with pole and line.

**Seasonality:** More abundant spring to mid-summer.

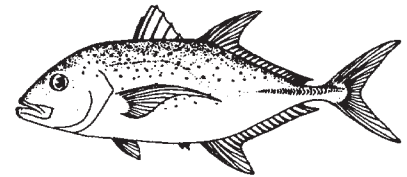

### ‘Ōmilu

*Caranx melampygus*  
Bluefin trevally, hoshi ulua

**Description:** Juveniles silvery blue above fading to silver below, with yellow pectoral fins; as fish ages bluish-black spots begin to appear all over, and body changes to neon blue; fins, especially first dorsal, also blue; breast completely scaled.

**Size:** Length up to 3 feet; weight generally up to 20 pounds.

**Habitat:** Juveniles found in shallow bays and estuaries; medium sized fish (6 to 20 inches) taken over reefs; adults often move in close to shore by following channels in coral reefs, swimming over the reef by day.

**Feeding:** Mostly diurnal; small fish.

**Schooling:** Solitary or small groups.

**Fishing methods:** Usually taken with surfcasting gear; trolling, spear, net, handline, trap; juveniles taken with pole and line.

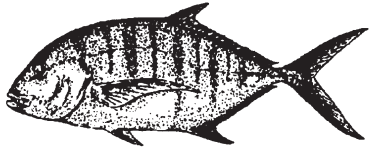

### Ulua pa'opa'o

*Gnathanodon speciosus*  
Golden trevally

**Description:** Creamy yellow with silvery and bluish hues, marked by series of 8 to 12 darker greenish vertical bands; jaws of adults contain no teeth.

**Size:** Length up to 3 feet; weight generally up to 10 pounds.

**Habitat:** Generally found in sandy channels and bars close to shore.

**Feeding:** Uncertain; fish and crustaceans.

**Schooling:** Small schools.

**Fishing methods:** Pole and line, net.

**Seasonality:** Uncommon year round.

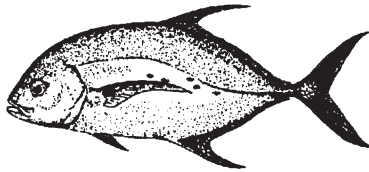

### Ulua

*Carangoides orthogrammus*  
Yellowspot trevally, island jack, papa

**Description:** Silvery blue above fading to silvery white below, bluish and golden hues on fins; sides marked with a few lemon-colored round spots, which tend to fade as fish gets older.

**Size:** Length up to 2 feet; weight generally up to 5 pounds.

**Habitat:** Near shore.

**Feeding:** Diurnal; small fish and crustaceans.

**Schooling:** Solitary or small groups.

**Fishing methods:** Trolling, spear, pole and line.

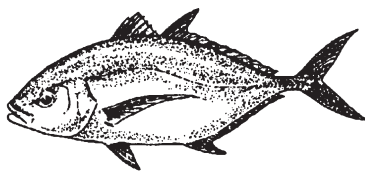

### Butaguchi

*Pseudocaranx dentex*  
Buta ulua, thicklipped jack

**Description:** Dark silver above fading to light silver below, dark spot at upper edge of gill cover; juveniles have yellow horizontal streak extending through eye and along side of body to base of tail; thick fleshy lips, pointed snout, and concave depression in front of eyes.

**Size:** Length up to 4 feet; weight generally up to 40 pounds.

**Habitat:** Bays and coastal waters.

**Feeding:** Diurnal and nocturnal; fish, crustaceans and octopus.

**Schooling:** Schools.

**Fishing methods:** Handline.

## SCOMBRIDS

(Tunas and their allies)

Scombrids are carnivorous fishes that feed on squids, crustaceans and other small fishes. They have well-contoured torpedo-shaped bodies, the most perfect shape for high-speed swimming. The anterior dorsal fin can be completely tucked into a groove on the back. Scombrids often live in large schools, and many species are known to migrate over long distances.

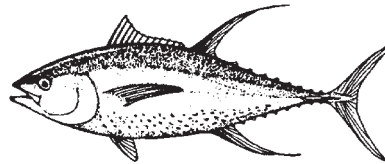

### 'Ahi

*Thunnus albacares*  
Yellowfin tuna

**Description:** Blackish blue above fading to white below; faint yellow stripe extends from eye to tail, soft dorsal and anal fins and finlets bright yellow; dorsal and anal fins lengthen with age.

**Size:** Weight up to 300 pounds.

**Habitat:** Open water, generally found over deepwater banks and submarine ledge areas at depths to 1000 fathoms; young fish often travel near the surface.

**Feeding:** Diurnal and nocturnal; fish, squid and crustaceans.

**Schooling:** Schools.

**Fishing methods:** Longline, pole and line, trolling, handline.

**Seasonality:** Adults more abundant late spring through early fall; juveniles abundant fall and winter.

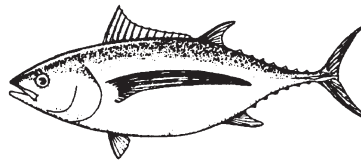

### 'Ahi palaha

*Thunnus alalunga*  
Albacore, tombo

**Description:** Blackish blue above fading to silvery below; long pectoral fins which extend beyond the soft dorsal and anal fins.

**Size:** Weight up to 80 pounds or more, but few exceed 40 pounds.

**Habitat:** Open water, generally staying below 60 fathoms during the day, then moves close to surface by night.

**Feeding:** Diurnal and nocturnal; fish, squid and crustaceans.

**Schooling:** Schools.

**Fishing methods:** Longline, handline.

**Seasonality:** More abundant during summer months.

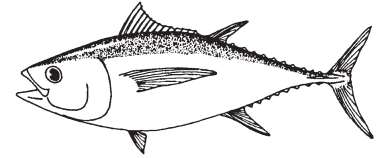

### 'Ahi po'o nui

*Thunnus obesus*  
Bigeye tuna

**Description:** Blackish blue above fading to silvery below, yellowish finlets; closely resembles ahi, but has larger eyes.

**Size:** Weight generally up to 150 pounds, but some have been known to reach 300 pounds.

**Habitat:** Open water, generally staying below 60 to 70 fathoms by day, then moving closer to surface by night.

**Feeding:** Diurnal and nocturnal; fish, squid and crustaceans.

**Schooling:** Schools.

**Fishing methods:** Handline, longline.

**Seasonality:** More abundant late fall through late spring.

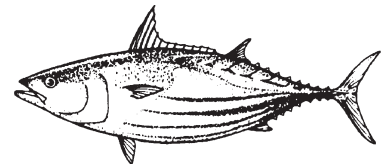

### Aku

*Katsuwonus pelamis*  
Skipjack tuna

**Description:** Dark metallic blue above, light dusky blue below, with four or five dark purplish longitudinal stripes on side of belly.

**Size:** Weight averages about 18 to 22 pounds during the summer, 5 to 12 pounds during the rest of the year.

**Habitat:** Generally found in waters 100 fathoms and deeper.

**Feeding:** Diurnal; fish, squid and crustaceans.

**Schooling:** Schools.

**Fishing methods:** Pole and line (aku boat type), trolling.

**Seasonality:** Taken year round, but most common during spring and summer.

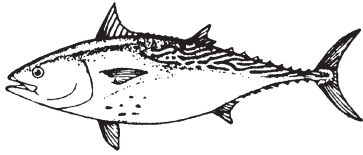

### Kawakawa

*Euthynnus affinis*  
Wavyback skipjack

**Description:** Dark blue or bluegreen above fading to silver below; about 12 dark wavy marks on dorsal area.

**Size:** Weight up to about 20 pounds, but most are around 4 or 5 pounds.

**Habitat:** Open water, but somewhat close to shoreline, generally in depths less than 100 fathoms; often found over dropoffs, or in association with aku; young may enter bays and harbors.

**Feeding:** Diurnal and nocturnal; small fish, squid and crustaceans.

**Schooling:** Schools.

**Fishing methods:** Trolling, pole and line.

**Seasonality:** Present throughout year, but most abundant during summer when the fish come fairly close to shore in large schools.

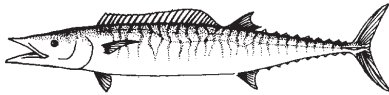

### Ono

*Acanthocybium solanderi*  
Wahoo

**Description:** Dark blue above fading to silver below, with about 30 purplish-gray vertical bars on sides that flash bright blue when the fish is fighting a hook.

**Size:** Weight up to 100 pounds, average 30 to 40 pounds.

**Habitat:** Roams the surface waters of the open sea, usually over deep-sea ledges; often found near floating logs and other objects.

**Feeding:** Diurnal; fish, squid and crustaceans.

**Schooling:** Solitary or small schools.

**Fishing methods:** Trolling, longline.

**Seasonality:** More abundant late spring through fall.

## BILLFISH

Billfish are carnivorous fishes of the open ocean, feeding on squid and relatively large fishes. They are characterized by the presence of a spear, or bill, which is actually an extension of the upper jaw. The bill helps streamline the fish, and is often used to slash at schools of prey; the billfish then feeds on the wounded fish.

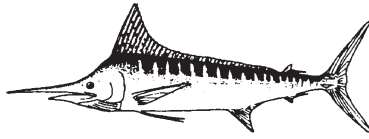

### A'u

*Tetrapterus audax*  
Striped marlin, nairagi

**Description:** Royal blue above fading to silvery below, with lavender or pale blue vertical stripes on sides; dorsal and anal fins cobalt blue; high pointed dorsal fin.

**Size:** Weight up to 150 pounds or more; most average about 25 to 100 pounds.

**Habitat:** Pelagic.

**Feeding:** Diurnal; fish and squid.

**Schooling:** Solitary or small schools.

**Fishing methods:** Trolling, longline.

**Seasonality:** Taken mostly in spring and fall.

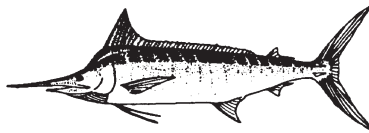

### A'u

*Makaira nigricans*  
Pacific blue marlin, kajiki

**Description:** Cobalt blue above fading to silvery below, with pale blue vertical stripes on sides and blue patches on dorsal area and tail.

**Size:** Weight averages about 300 to 400 pounds, but some exceeding 1400 pounds have been taken.

**Habitat:** Generally taken over bank areas where baitfish are abundant, and over offshore ledges where bottom drops off from 100 to 1000 fathoms or more.

**Feeding:** Diurnal; mainly aku and other tunas.

**Schooling:** Solitary.

**Fishing methods:** Trolling, longline.

**Seasonality:** Most abundant during summer.

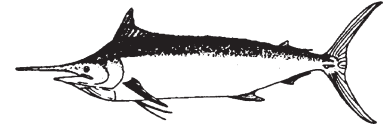

### A'u

*Makaira indica*  
Black marlin, hida

**Description:** Variable coloration; most are dark slate blue above fading to silvery below; may have pale blue stripes or blue patches on sides that fade quickly after death; pectoral fins don't fold against body.

**Size:** Most average about 200 pounds, but have been known to reach 1800 pounds.

**Habitat:** Pelagic.

**Feeding:** Diurnal; fish and squid.

**Schooling:** Solitary.

**Fishing methods:** Trolling, longline

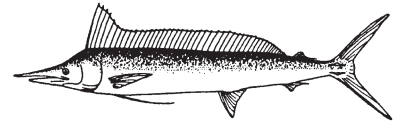

### A'u

*Tetrapterus angustirostris*  
Shortbill spearfish, hebi

**Description:** Deep metallic blue above fading to silvery and white below; no significant markings; upper jaw extends on a short distance beyond the lower jaw.

**Size:** Average weight about 20 to 40 pounds, rarely exceeds 100 pounds.

**Habitat:** Pelagic.

**Feeding:** Diurnal; squid and small fish.

**Schooling:** Solitary or small schools.

**Fishing methods:** Trolling, longline.

**Seasonality:** Most abundant during winter and early spring.

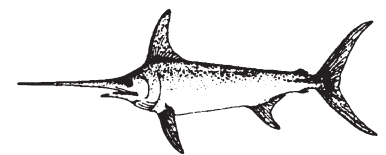

### A'u ku

*Xiphias gladius*  
Broadbill swordfish, shutome

**Description:** Coloration varies from metallic purplish to blackish brown, but generally dark brown, with silvery iridescence below; pelvic fins are absent, dorsal fin not retractable.

**Size:** Average weight about 200 to 300 pounds; large fish may exceed 1000 pounds.

**Habitat:** Pelagic.

**Feeding:** Nocturnal; fish and squid.

**Schooling:** Solitary or in pairs.

**Fishing methods:** Longline, handline.



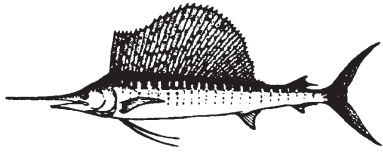

### A'u lepe

*Istiophorus platypterus*  
Sailfish

**Description:** Body coloration dark steely blue above fading to silvery white below, with pale purple vertical bars on sides; sail cobalt blue to purple with numerous small blue spots.

**Size:** Average weight about 30 to 50 pounds.

**Habitat:** Generally near submerged shoals fairly close to shore.

**Feeding:** Diurnal; small fish and squid.

**Schooling:** Usually solitary; may occur in small schools.

**Fishing methods:** Trolling, longline.

**Seasonality:** Uncommon year round.

### DOLPHINFISH

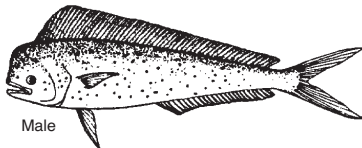

Male

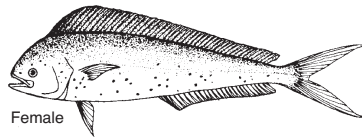

Female

### Mahimahi

*Coryphaena hippurus*  
Dorado

**Description:** Brilliant green and yellow dotted with phosphorescent blue, with purplish blue dorsal fin; colors change rapidly when fighting and just before death. Males have an almost vertical head profile, females are more sloping.

**Size:** Average weight 20 to 30 pounds; occasionally 70 pounds.

**Habitat:** Open ocean, often seen close to surface near schools of flyingfish, or around floating objects.

**Feeding:** Diurnal and nocturnal; squid and small fish, especially flyingfish.

**Schooling:** School.

**Fishing methods:** Trolling, handline, longline.

**Seasonality:** Small fish (up to 5 pounds) common in summer, large fish (30 to 40 pounds) more plentiful in late winter and early spring.

### DEEPWATER SNAPPERS

Snappers are voracious carnivores, and the species described here are generally found in the deeper waters of Hawai'i, up to 150 fathoms (900 ft), as opposed to the nearshore species described earlier. Most deepwater snappers are a uniform bright color, usually with red or yellow hues. A few species have color patterns.

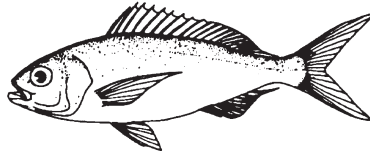

### Kalekale

*Pristipomoides sieboldii*  
Kalikali, von Siebold's snapper

**Description:** Light lavender above fading to lighter below; scales above lateral line have pale-blue spots in center which form lengthwise lines; margin of dorsal fin orange with light lavender; tail fin dark lavender with light margin.

**Size:** Length up to 2 feet; weight generally up to 4 pounds.

**Habitat:** Deep waters, usually 80 to 120 fathoms.

**Feeding:** Diurnal and nocturnal; fish, squid and crustaceans.

**Schooling:** School.

**Fishing methods:** Handline.

**Seasonality:** Most caught during late fall and winter.

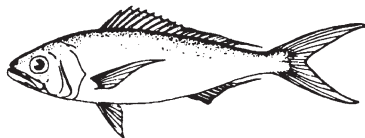

### Lehe

*Aphareus rutilans*  
Lehi, ironjaw snapper

**Description:** Brick red above fading to silvery below; dorsal fin has yellow spot on margins and yellow border; tail has yellowish hues.

**Size:** Length up to 3 feet or more; weight generally up to 25 pounds.

**Habitat:** Deep waters, usually around 100 fathoms.

**Feeding:** Diurnal and nocturnal; fish, squid and crustaceans.

**Schooling:** School.

**Fishing methods:** Handline.

**Seasonality:** Most caught during late fall and winter.

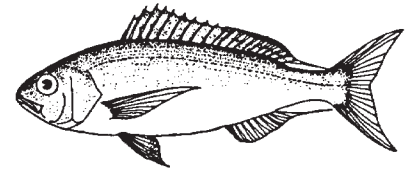

### Opakapaka

*Pristipomoides filamentosus*  
Pink snapper

**Description:** Light violet brown above fading to dusky white below; pectoral fins yellowish.

**Size:** Length up to 3 feet; weight generally up to 18 pounds.

**Habitat:** Deep waters, usually 40 to 100 fathoms; most abundant over rocky bottom dropoffs.

**Feeding:** Diurnal and nocturnal; fish, squid and sea cucumbers.

**Schooling:** School.

**Fishing methods:** Handline.

**Seasonality:** Most caught during winter months.

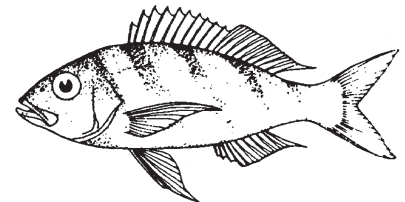

### Ukikiki

*Pristipomoides zonatus*  
Brigham's snapper, gindai

**Description:** Pinkish red with four wide vertical yellow bands; dorsal, pectoral and caudal fins yellow.

**Size:** Length up to 20 inches or more; weight generally up to 4 pounds.

**Habitat:** Deep water, usually 60 to 100 fathoms.

**Feeding:** Diurnal; fish, squid and crustaceans.

**Schooling:** Solitary or small schools.

**Fishing methods:** Handline.

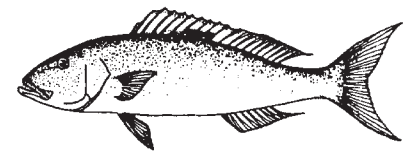

### Uku

*Aprion virescens*  
Gray snapper

**Description:** Uniform grayish blue, with dorsal area more bluish than below; dark blue towards head; three dark spots near base of dorsal fin.

**Size:** Length up to 3 feet or more; average weight about 4 to 8 pounds.



**Habitat:** Relatively shallow water compared with other snappers, usually less than 60 fathoms; rocky bottom areas outside of reef, deep rocky areas near shore.

**Feeding:** Generally nocturnal; fish, squid and crustaceans.

**Schooling:** Solitary or small groups; large aggregates when spawning.

**Fishing methods:** Handline, spear.

**Seasonality:** Most caught during late spring and early summer when spawning.

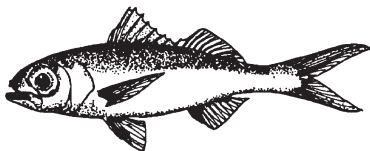

### 'Ula'ula

*Etelis carbunculus*

'Ehu, red snapper

**Description:** Red above fading to silvery pink below; interior of mouth is pink.

**Size:** Weight generally up to 9 pounds.

**Habitat:** Deep waters, usually 100 to 150 fathoms.

**Feeding:** Generally diurnal; fish, squid and crustaceans.

**Schooling:** Aggregates.

**Fishing methods:** Handline.

**Seasonality:** Most caught during winter.

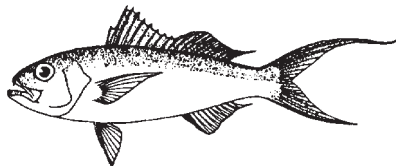

### 'Ula'ula koa'e

*Etelis coruscans*

Longtail red snapper, onaga

**Description:** Red above fading to silvery pink below; dorsal and tail fins red; inside of mouth red; caudal fin lobes are elongate, upper lobe longer than lower.

**Size:** Weight generally up to 35 pounds.

**Habitat:** Taken over offshore dropoffs, usually in water 100 to 150 fathoms.

**Feeding:** Generally diurnal; fish, squid and crustaceans.

**Schooling:** School.

**Fishing methods:** Handline.

**Seasonality:** Most caught during winter.

## GROUPERS

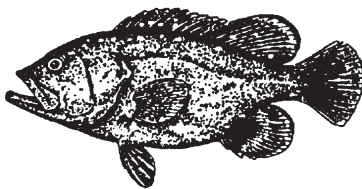

### Hāpu'u

*Epinephelus quernus*

Seale's grouper

**Description:** Dark purplish brown with small white spots; spots become less distinct as fish grows larger.

**Size:** Length up to 4 feet; weight generally up to 50 pounds.

**Habitat:** Deep water, generally 50 to over 120 fathoms.

**Feeding:** Diurnal; fish and crustaceans.

**Schooling:** Solitary.

**Fishing methods:** Handline.

## FRESHWATER SPORTFISH (Introduced)

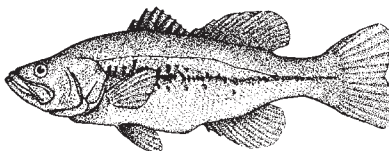

### Largemouth Bass

*Micropterus salmoides*

**Description:** Coloration varies with location, generally dark green above fading to white below; may have faint horizontal band along sides (more distinct in young fish); jaw extends back beyond posterior margin of eye; dorsal fin deeply notched between spiny and soft portions.

**Size:** Weight ranges up to 10 pounds in Hawai'i; state record 9 lbs 9.4 oz (1992); world record 22 lbs 4 oz (1932, Georgia).

**Distribution:** In Hawai'i found on the islands of Kaua'i, O'ahu and Hawai'i.

**Habitat:** Usually found in sluggish waters, occur primarily in reservoirs in Hawaii; prefer submerged logs, weeds or other cover near banks.

**Feeding:** Young feed on crustaceans, insects and small fishes; adults feed on live fishes, crayfish and frogs.

**Life history:** In Hawai'i spawning season occurs during the winter and spring and is limited to reservoir habitats; male builds a circular nest in 3 to 4 feet of water; male guards the nest and defends eggs and young until they leave.

**Fishing methods:** Light spinning or bait-casting gear is recommended, with surface or deep running lures, such as plastic worms, crankbaits or spinnerbaits; effective live baits include puntat, tilapia, crayfish and worms.

Introduced to Hawai'i in 1896.

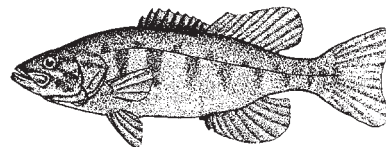

### Smallmouth Bass

*Micropterus dolomieu*

**Description:** Coloration varies with location, generally dark green to olive brown above fading to white below; sides marked with vertical bars and dark mottlings; jaw does not extend back beyond eye; spiny portion of dorsal fin lower than on largemouth bass, and not as deeply notched.

**Size:** Weight ranges up to 4 pounds in Hawai'i; state record 4.98 lbs (2004); world record 11 lbs 15 oz (1955, Kentucky).

**Distribution:** In Hawai'i found on the islands of Kaua'i and O'ahu.

**Habitat:** Found in cool flowing streams and reservoirs fed by such streams.

**Feeding:** Young feed on crustaceans, insects and small fishes; adults feed primarily on live fishes and crayfish.

**Life history:** In Hawai'i spawning season occurs during the spring and is limited to stream habitats; male builds a hollow nest in sand and guards the young, viciously attacking any intruder.

**Fishing methods:** Small spinners or poppers are effective lures; live baits include crayfish or worms.

Introduced to Hawai'i in 1953.

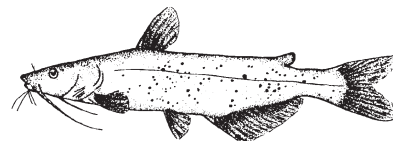

### Channel Catfish

*Ictalurus punctatus*

**Description:** Bluish olive to gray above fading to white below, with dark spots scattered along sides; older males become dark in color and lose spots; long barbels surrounding mouth; deeply forked tail.

**Size:** Generally under 10 pounds, but have unofficially exceeded 50 pounds in Hawai'i; state record 43 lbs 13 oz (1974); world record 58 lbs (1964, South Carolina).

**Distribution:** In Hawai'i found on the islands of Kaua'i and O'ahu.

**Habitat:** Occur primarily in reservoirs in Hawai'i.

**Feeding:** Feeds primarily on small fish, crustaceans, clams and snails.

**Life history:** Spawning occurs in late spring; eggs are laid in jelly-like masses in holes and crevices, and guarded by the male; hatching occurs after about a week, and the male continues to guard the young.

**Fishing methods:** Crankbaits or large spinnerbaits are the most effective lures; a catfish weighing 51 pounds (unofficially) was taken from the Wahiawa Reservoir on a spoon; other baits include tilapia, crayfish, aku belly, liver and various stinkbaits. Introduced to Hawai'i in 1958.

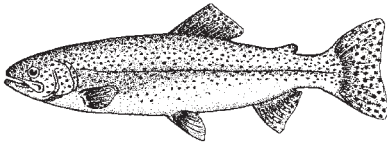

### Rainbow Trout

*Oncorhynchus mykiss*

**Description:** Bluish or olive green above fading to silvery below, with broad pink lateral stripe; back, sides, dorsal and caudal fins marked with small dark spots.

**Size:** Generally under 3 pounds, but have unofficially reached 8 pounds in Hawai'i; state record 5 lbs 10 oz (1991); world record 42 lbs 3 oz (1970, Alaska).

**Distribution:** In Hawai'i found on the islands of Kaua'i and Hawai'i.

**Habitat:** Prefers cold water streams with moderate flow.

**Feeding:** Young feed on small insects and crustaceans; adults feed on fish eggs, minnows and other small fish (including other trout).

**Life history:** Limited spawning occurs in Hawai'i because water temperatures are too high; what spawning does occur takes place from about November to February; annual stockings of the Kokee region on Kaua'i are accomplished with eggs from California, hatched and raised at Sand Island, O'ahu.

**Fishing methods:** Small spinners or flies are effective lures; salmon eggs are used with good success.

Introduced to Hawai'i in 1920.

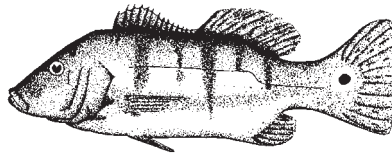

### Tucunare

*Cichla ocellaris*

**Description:** Yellow with a green back and white abdomen; vertical bars along sides; during spawning season yellow color intensifies, and males develop a large hump above the head; prominent black spot on caudal fin.

**Size:** Weight averages about 2 to 3 pounds; state record 9 lbs 4.2 oz (1990); world record 27 lbs (1994, Brazil)

**Distribution:** In Hawai'i found on the islands of Kaua'i, O'ahu, Maui and Hawai'i.

**Habitat:** Generally found in the larger reservoirs of the state.

**Feeding:** Feeds exclusively on small fish, especially threadfin shad, mosquito fish, tilapia and bluegill.

**Life history:** Spawning in Hawai'i occurs from about March to September; eggs are laid on rocks or other hard objects and guarded by one or both parents; hatching takes place within four days, and parents guard the young; presence of at least one parent is essential for survival of young, so fishermen are urged not to disturb spawning fish which are often visible near shore.

**Fishing methods:** Lures include jigs and torpedo-shaped lures that resemble minnows; the only effective live bait is mosquitofish, mollies or tilapia.

Introduced to Hawai'i in 1957.

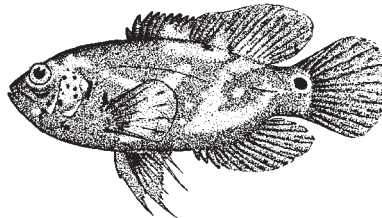

### Oscar

*Astronotus ocellatus*

**Description:** Brightly colored with irregular red markings on a dark brown body; prominent black spot surrounded by red ring at base of caudal fin.

**Size:** Weight reaches 3 pounds or more; state record 2 lbs 6 oz (1976).

**Distribution:** In Hawai'i found on the island of O'ahu.

**Habitat:** Prefers quiet shallow water.

**Feeding:** Feeds on small fish, crayfish, worms and insect larvae.

**Life history:** Spawning in Hawai'i occurs from about March to September; oscar pairs excavate a circular nest in shallow water, where eggs are deposited; both parents guard the nest.

**Fishing methods:** Minnow-like lures are effective; live baits include worms, crayfish and mosquitofish.

Introduced to Hawai'i in 1951.

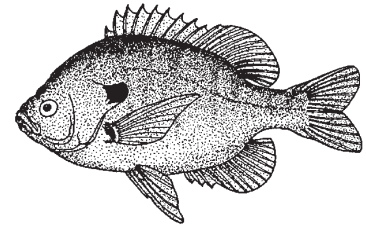

### Bluegill Sunfish

*Lepomis macrochirus*

**Description:** Coloration varies somewhat with sex and age, generally olive green above with blue or purplish sheen along sides; breeding males may have more blue and orange on sides; faint vertical bars along sides; opercular flap is dark blue or black, and prominent dark blotch is present at posterior base of dorsal fin.

**Size:** Generally 4 to 6 inches in length, may reach 14 inches; state record 8 oz (2000); world record 4 lb 12 oz (1950, Alabama).

**Distribution:** In Hawai'i found on the islands of Kaua'i, O'ahu, Maui and Hawai'i.

**Habitat:** Usually found in lakes, ponds, reservoirs and sluggish streams, occur primarily in reservoirs in Hawai'i; prefer deep weed beds.

**Feeding:** Young feed on crustaceans, insects and worms; adults feed on snails, small crayfish, insects, worms and small minnows; feed mostly in early morning and late afternoon and evening.

**Life history:** In Hawai'i spawning season occurs in winter and spring; male builds a circular nest in sandy areas 3 to 6 feet deep; after fertilizing eggs male chases female away and guards the nest until fry disperse.

**Fishing methods:** Worms are the most effective live bait; lures include flies and small spinners.

Introduced to Hawai'i in 1946.

State records as of Feb 2006;  
source Hawaii Fishing News.

**Illustrations:** National Oceanic and Atmospheric Administration, Les Hata / Hawaii Fishing News, Division of Aquatic Resources, Waikiki Aquarium

## Suggested Reading

- Dunn-Rankin, Peter. *Fishing the Reefs*. Honolulu: Mutual Publishing Co., 1994
- Hosaka, Edward. *Shore Fishing in Hawaii*. Hilo: Petroglyph Press, 1944, 1973
- MacKellar, Jean Scott. *Hawaii Goes Fishing*. Tokyo: Chas. E. Tuttle Co., 1968
- Rizzuto, Jim. *Fishing Hawaii Style*. Honolulu: Fishing Hawaii Style, Ltd., 1983
- Rizzuto, Jim. *Fishing Hawaii Style, Vol. 2*. Honolulu: Fishing Hawaii Style, Ltd., 1987
- Rizzuto, Jim. *Fishing Hawaii Style, Vol. 3*. Honolulu: Fishing Hawaii Style, Ltd., 1990
- Rizzuto, Jim. *Modern Hawaiian Gamefishing*. Honolulu: Univ. of Hawai'i Press, 1977
- Sakamoto, Mike. *Hawaii's Mike Sakamoto Presents 101 Fishing Tips*. Honolulu: Bess Press, 2003
- Sakamoto, Mike. *How to Hook and Cookbook*. Honolulu: Bess Press, 1988
- Sakamoto, Mike. *More How to Hook and Cookbook*. Honolulu: Bess Press, 1994
- Sakamoto, Mike. *Pacific Shore Fishing*. Honolulu: Univ. of Hawai'i Press, 1985
- Titcomb, Margaret. *Native Use of Fish in Hawai'i*. Honolulu: Univ. of Hawai'i Press, 1952, 1972
- Hawai'i Department of Health, 1988. *Fish Poisoning in Hawaii*.
- Hawaii Fishing News*. (Honolulu) Monthly publication.

The Department of Land and Natural Resources receives financial support under the Federal Aid in Sport Fish and Wildlife Restoration and other federal programs. Under Title VI of the Civil Rights Act of 1964, Section 504 of the Rehabilitation Act of 1973, Title II of the Americans with Disabilities Act of 1990, the Age Discrimination Act of 1975, Title IX of the Education Amendments of 1972, and the laws of the U.S. Department of the Interior and the State of Hawai'i prohibit discrimination on the basis of race, color, religion, sex, national origin, age, and disability. If you believe that you have been discriminated against in any program, activity or facility, or if you desire information, please write to: Affirmative Action Officer, Personnel Office, Department of Land and Natural Resources, 1151 Punchbowl Street, Rm. 231, Honolulu, HI 96813, or the U.S. Fish & Wildlife Service, Civil Rights Branch, 4040 N. Fairfax Drive, Suite 300, Arlington, VA 22203.