

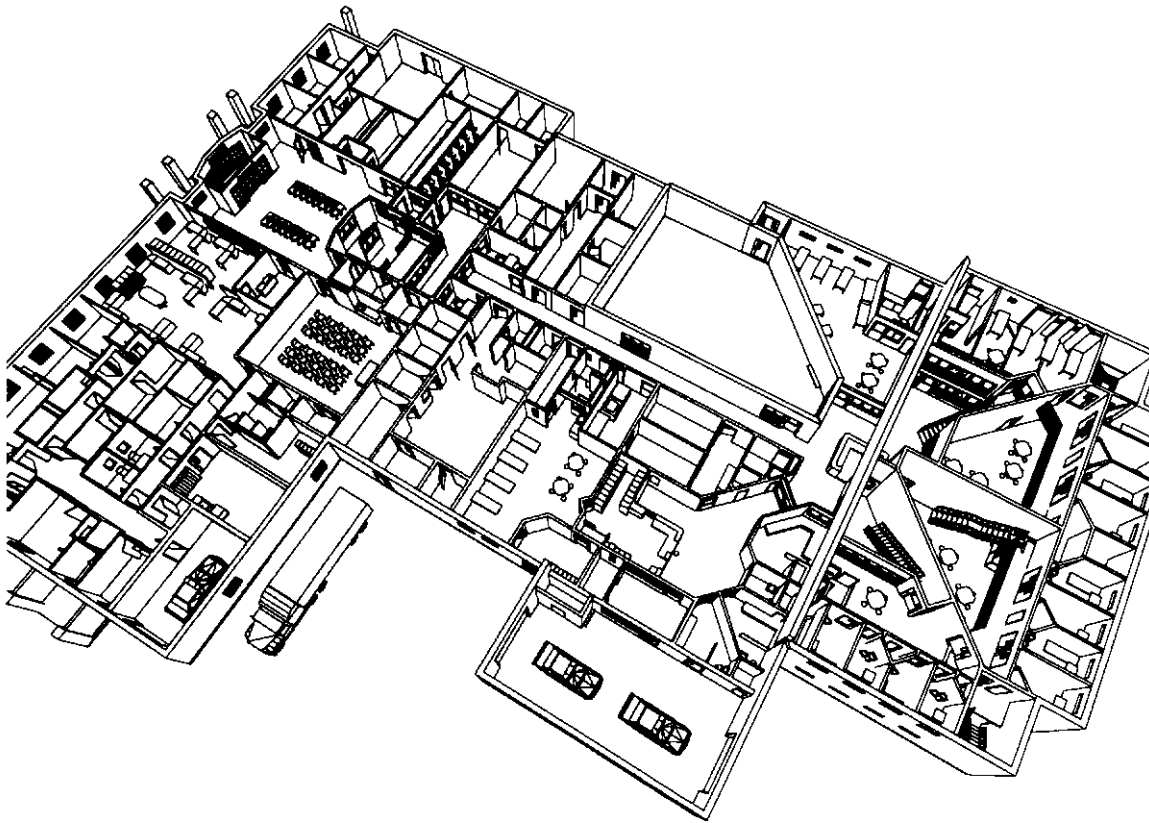

JAIL DESIGN GUIDE

A Resource for Small and Medium-Sized Jails



National Institute of Corrections

Morris L. Thigpen, Director

Michael A. O'Toole, Project Manager

Tom Reid, Project Manager



JAIL DESIGN GUIDE

A Resource for Small and Medium-Sized Jails

Project Director

Dennis A. Kimme, A.I.A.

Associate Project Director

Gary M. Bowker, Corrections Specialist

Project Staff

Robert G. Deichman, R.A.

David E. Bostwick, A.I.A.

James R. Rowenhorst, Corrections Specialist

This project was supported by grant number 94J04GHZ8 from the National Institute of Corrections, U.S. Department of Justice. Points of view or opinions stated in this document are those of the authors and do not necessarily represent the official position or policies of the U.S. Department of Justice.

November 1998

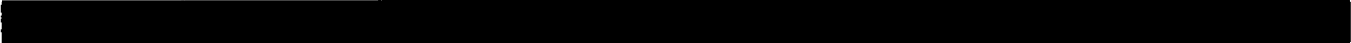

©Copyright 1998. Kimme & Associates, Inc.
807% S. Neil
Champaign, IL 61820
217-351-7036

The National Institute of Corrections reserves the right to reproduce, publish, **translate**, or otherwise use, and to authorize others to publish and use, all or any part of the copyrighted material contained in this publication.

TABLE OF CONTENTS

Acknowledgements.....	viii
Foreword.....	ix
Abstract.....	x
1. Background.....	1-1
History.....	1-2
Lessons from Experience.....	1-3
Intended Audience.....	1-3
Contents.....	1-4
"Better" Jails.....	1-4
Operations and Design.....	1-6
Construction Details.....	1-6
2. Pre-Design Planning.....	21
Reasons for Planning.....	2-2
Can a Prototype Replace the Need to Plan?.....	23
Planning Steps.....	2-4
Phase 1: Needs, Options, and Cost	
Assessment.....	2-5
Phase 2: Facility Program.....	2-9
When Planning Works Well.....	2-10
3. Major Design Considerations.....	31
Site Selection/Design.....	3-2
Site Size.....	32
Site Location.....	3-7
Site Costs.....	3.11
Site Selection Process.....	3-13
Image/Appearance.....	3-15
Exterior.....	3-15
Interior.....	3-16
Describing Desired Appearance.....	3-18
Classification/Separation.....	3-19
Separation Problems.....	3. 19
Classification Systems.....	3.22
Resolving the Numbers Problem.....	3.23
Designing for Proper Separation.....	3.24

Surveillance/Supervision	3.33
Methods of Surveillance/Supervision	3.33
Design Considerations	3.35
Staffing Impact	3.48
Legal Issues	3.49
24-Hour Coverage.....	3.49
Design Factors	3.50
Security Perimeter.....	3.59
Ingredients of Security	3.59
Perimeters and Zones.....	3-61
Design Considerations	3.64
Conclusion.....	3-74
Criminal Justice Interface.....	3-75
A General Caution	3-75
Law Enforcement Interface.....	3-76
Courts Interface	3-81
Attorneys.....	3-84
Probation/Parole	3-85
Conclusion.....	3-85
Functional Components and Relationships	3-86
Jail Components	3.86
Degrees of Development	3-88
Component Relationships	3-90
Space-Sharing Possibilities.....	3-94
Conclusion.....	3-96
Planning & Designing to Standards.....	3.97
State Standards.....	3-97
ACA Commission on Accreditation Standards.....	3-98
NFPA Life Safety Code.....	3.99
Americans with Disabilities Act	3.99
Conclusion.....	3-101
Expansion.....	3-102
Why Plan for Expansion?.....	3-102
Expansion Options.....	3-102
When to Develop an Expansion Plan.....	3-103
Setting Expansion Capacity.....	3-103
Vertical vs. Horizontal Expansion.....	3-104
Conclusion.....	3-107

4 . Detail Functional Components	41
Master Control.....	4-2
Description	4-2
Key Decisions.....	4-2
Detail Issues.....	4-3
Space List.....	4-14
Relationships.....	4-14
Component Diagram.....	4-15
Intake-Release.....	4-16
Description	4-16
Key Decisions.....	4-18
Detail Issues.....	4-19
Space List.....	4-42
Relationships.....	4-43
Component Diagrams.....	4-43
General Housing.....	4-44
Description	4-44
Key Decisions.....	4-45
Detail Issues.....	4-46
Space List.....	4-81
Relationships.....	4-82
Component Diagram.....	4-82
Special Housing.....	4-83
Description	4-83
Key Decisions.....	4-84
Detail Issues.....	4-85
Space List.....	4-101
Relationships.....	4-102
Component Diagram.....	4-102
Health Care.....	4-104
Description	4-104
Key Decisions.....	4-105
Detail Issues.....	4-106
Space List.....	4-119
Relationships.....	4-120
Component Diagram.....	4-120
Visiting Areas.....	4-121
Description	4-121
Key Decisions.....	4-122
Detail Issues.....	4-122
Space List.....	4-131
Relationships.....	4-132
Component Diagram.....	4-132

Exercise Areas	4-133
Description.....	4-133
Key Decisions.....	4-133
Detail Issues	4-134
Space List.....	4-145
Relationships.....	4-146
Component Diagram.....	4-147
Programs/Services	4-148
Description.....	4-148
Key Decisions.....	4-148
Detail Issues	4-149
Space List.....	4-164
Relationships.....	4-165
Component Diagram.....	4-165
Inmate Commissary.....	4-166
Description	4-166
Key Decisions.....	4-166
Detail Issues	4-167
Space List.....	4-170
Relationships.....	4-170
Component Diagram.....	4-170
Food Service.....	4-171
Description.....	4-171
Key Decisions.....	4-172
Detail Issues	4-172
Space List.....	4-180
Relationships.....	4-181
Component Diagram.....	4-181
Laundry Area	4-182
Description	4-182
Key Decisions.....	4-182
Detail Issues.....	4-182
Space List.....	4-187
Relationships.....	4-188
Component Diagram.....	4-188
Administration/Public.....	4-189
Description	4-189
Key Decisions.....	4-190
Detail Issues	4-190
Space List.....	4-202
Relationships.....	4-203
Component Diagram.....	4-203

Staff Areas	4.204
Description.....	4.204
Key Decisions.....	4-204
Detail Issues.....	4.205
Space List.....	4.2 15
Relationships.....	4.2 16
Component Diagram.....	4.2 16
Storage Areas.....	4.2 17
Description.....	4.2 17
Key Decisions.....	4-217
Detail Issues.....	4.2 17
Space List.....	4.224
Relationships.....	4-225
Component Diagram.....	4-225
5 . Special Considerations.....	5-1
Single vs. Multiple Occupancy	5-2
Definitions	5.2
Standards and Legal Issues.....	5-3
The Issue.....	5-4
Single Occupancy: Two Concerns	5.5
The Costs of Multiple Occupancy.....	5.6
Double Ceiling Single Cells	5-7
Conclusion.....	5-9
Renovating Non-Secure Buildings into Jails....	5-10
A Common Renovation Example	5-10
Security Construction	5-11
Costs	5-12
Conclusion.....	5-14
Construction and Project Costs.....	5-16
Construction Costs	5-16
Project Cost.....	5-16
Conclusion.....	5-19
6 . Making a Building Work.....	6-1
Policy and Procedure Development	6-2
Final Staffing Plan and Staff Post Orders	6-2
Budget Preparation and Approval.....	6-3
Staff Recruitment and Selection	6-3
Staff Training.....	6.3
Move Logistics	6.4
Summary	6-4

ACKNOWLEDGEMENTS

The project team is indebted to the National Institute of Corrections (NIC) for the opportunity to revise and update the original *Small Jail Design Guide*, now ten years old. It was a large and complicated undertaking then, but one that provided its authors with many rewards based on its documented value to planning professionals and local officials alike. Without NIC's *Small Jail Design Guide*, they would have been without a substantial planning and design resource as they undertook major projects involving millions of dollars in construction and jail staff time.

As with the first edition, the project team is enormously indebted to Michael O'Toole, former NIC Jails Division Chief, for his stewardship of this complicated and lengthy project. His patience, professionalism, and commitment to a quality end-product were a major driving force during the course of the work. Thanks also to Tom Reid, NIC Project Monitor at the document's conclusion, for his review assistance and guidance, and to Nancy Sabanosh, NIC Publications Manager, for her superb editorial and production assistance. Sue Van Matre's attention to the endless revisions is greatly appreciated. Finally, recognition must again go to many current and former NIC Jails Division staff who invested considerable time in reviewing and improving the document.

FOREWORD

New jail construction is a major capital undertaking, which often represents the single largest project in which county officials will ever be involved. Many local jurisdictions are replacing outdated facilities as well as expanding **bedspace** to accommodate increasing numbers of inmates. The U.S. Department of Justice Bureau of Justice Statistics reports the capacity of the nation's jails increased by approximately 20,000 beds during the year ending June 30, 1997.

To respond to local jurisdictions' need for assistance in jail planning and design, the National Institute of Corrections offers a Facility Development Program that provides guidance as they proceed with jail planning, design, construction, and transition. This document supports the Facility Development Program by providing information about basic concepts and issues surrounding jail design.

This document is a revised and expanded version of the *Small Jail Design Guide* published in 1988. It now includes information relevant to planning for both small and medium-sized jails. Based on information from survey respondents and analysis by the *Design Guide* authors, the document discusses current correctional standards and architectural principles that are important to building a cost-efficient jail to meet a locality's particular needs. While plainly written, it is sufficiently technical and detailed to guide local officials, architects, and planners who may be unfamiliar with jail design, construction, and operational issues. It does not, however, include sample floor plans as that would imply the recommendation of model solutions to jail planning and design issues. Each jurisdiction needs to craft a jail design to meet its unique situation and community needs.

The information presented here will be beneficial to anyone involved in the planning, design, and construction of a new small or medium-sized jail -- sheriffs, county commissioners, jail administrators, local directors of corrections, criminal justice planners, and interested citizens. This document can help local officials assume and retain control of this important process and direct it toward the most beneficial solution for their community.

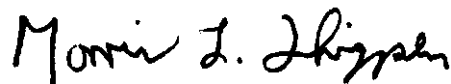

Morris L. Thigpen, Director
National Institute of Corrections

ABSTRACT

This work is an updated version of the *Small Jail Design Guide* originally published in 1988. It updates and expands upon the original work, adding new and revised graphics. It removes dated references to standards and adds several new sections. The illustrative designs at the end of the original *Small Jail Design Guide* are not included in this edition.

In reviewing the original document it was realized that many of the concepts discussed apply equally to most jails, including those regarded as medium size (100 to 200 beds). Thus, after appropriate editing, the document was renamed *Jail Design Guide: A Resource for Small and Medium-Sized Jails*.

In 1985, Kimme Planning and Architecture (now Kimme & Associates, Inc.) compiled survey information on 255 jails of 50 beds or less ("small jails") that had been opened since 1974. In addition to survey information, on-site evaluations of 32 of those facilities were conducted to discuss and evaluate specific operational issues with administrators and staff. This work identified the nature of the facilities and what "worked" about them and what did not. The data revealed that many new facilities suffered from a variety of design flaws and operational problems. Certain design features were identified as driving factors in the general operational "success" or "failure" of new small jails as perceived by staff and others charged with the administration and funding of these facilities.

Survey and site visit findings were reported in the *Nature of New Small Jails: Report and Analysis* released in 1985. In conducting the survey, the project team identified several key planning issues that were problematic and appeared to cause difficulties for many responding jurisdictions. A total of nine issues were analyzed in a separate NIC publication entitled *Small Jail Special Issues* released in 1986. Taken together, these two documents represented Phase One of the NIC grant project.

The first edition of the *Small Jail Design Guide* represented the end-product of Phase Two of the project. Since numerous NIC-sponsored documents and training curricula had already explored the pre-design planning process, this document attempted to avoid duplicating those discussions. Rather, it sought to identify and describe those issues and architectural considerations that directly assist the development of an efficient, standards-compliant, and functionally effective design.

In filling the void of design-oriented information available to small and medium-sized jails -- and jails in general -- the *Jail Design Guide* explores the broad operational questions that drive a jail design and the specific operational and design issues that must be addressed for each functional component (e.g., intake/release, food services, housing). Architectural responses to the issues are closely integrated with operational data as a way of illustrating the link between jail activities and physical space design.

1

BACKGROUND

1 BACKGROUND

This second edition of what was originally titled the *Small Jail Design Guide* is, as was its predecessor, an information resource intended to help jurisdictions create better and more effective jails. It attempts to do this by providing information concerning the important elements and concepts of successful jail design.

One important change in this edition from the original *Small Jail Design Guide* is that the audience it addresses has been expanded. Whereas the original document targeted "small jails," which were defined as having 50 beds or less, this edition targets small and medium-sized jails. These are defined as facilities up to 200 beds in size.

The focus of what is now simply entitled the *Jail Design Guide* was broadened for two reasons:

- increases in local jail populations have significantly reduced the demand for new jails of only 50 beds or less; and
- reflection and feedback on the First edition have made it clear that most of the issues raised in the original document apply equally well to medium-sized facilities in the 100- to 200-bed range.

The document was not redefined as an "all-jail design guide," because there are still some fundamental differences between small/medium-sized jails and large jails or systems of facilities found in major metropolitan areas. These fundamental differences were found in many areas, a key one, for example, being the challenge of designing to accommodate inmate classification-separation needs. Large systems can respond by devoting entire housing pods, or even separate facilities, to different classifications while still maintaining staff efficiency. The design for small and medium-sized facilities is more complicated and calls for different answers. The techniques of designing for their classification-separation needs are the subject of considerable discussion in this document, as are many other special design challenges that result from lesser scale and more limited resources. Having established these distinctions of size, it must be said that many readers of the original *Small Jail Design Guide* still found it helpful in designing large jails since many basic issues explored do indeed apply to all jails.

The design guide avoids re-creating information that already exists in other areas of importance to small and medium-sized jails. Specifically, the document does not present detailed information on the pre-design planning process, inmate supervision approaches, or staff training and needs analysis since other excellent resources on these topics already exist. However, since these and other "non-design" issues so greatly affect design, their influence is acknowledged and expressed throughout this document. One

of the main philosophies of the *Jail Design Guide* is that planning and operational issues cannot be separated from design and, in fact, shape all that a design becomes.

HISTORY

PROBLEMS RECOGNIZED

The primary incentive for developing the original *Small Jail Design Guide* is that staff of the Jails Division of the National Institute of Corrections (NIC), as well as other professionals in the field, became increasingly aware that some very ineffective and outdated small jails were being designed and built. These facilities came to NIC's attention because they created many problems and controversies for their owners and operators. These problems and controversies generated numerous technical assistance requests to NIC, and it was often the case that little could be done to correct major flaws in the architecture of something as permanent as a jail.

NIC quickly realized that there were additional reasons to pay special attention to small jails. It realized that small jails (originally defined as 50 beds or less) represent the majority of the jail facilities in the United States. However, very little of the research and literature in the jail field was really applicable to the small jail. NIC also realized that even though small jails are obliged to meet most of the same requirements as large jails, they typically have far fewer resources with which to solve their problems or to access information to solve them. In addition, there were problems unique to small jails that were not problems to large jails simply because of differences in scale.

NIC RESPONSE

In response, NIC adopted a proactive approach to small jail problems rather than continue to react to them. To fill the information void surrounding small jails, NIC initiated a "Small Jails" grant program in 1984.

The "Small Jails" program, awarded to KIMME Planning & Architecture P.C. (now **Kimme & Associates, Inc.**), began with an evaluation of new county jails of 50 beds or less opened since 1974. The evaluation was designed to determine the degree of problems and to find out what "worked" and what "didn't work" in small jail design.

While identifying some successful facilities and operations, the evaluation confirmed that there were indeed serious and widespread problems in the design and operation of recently built small jails. In some cases these problems were unsolvable, and in others they were manageable. Most disappointing was that many traditional problems of small jails were being repeated in ways that were irreversible short of major renovation.

The original *Small Jail Design Guide* attempted to provide data that would help jurisdictions avoid past design problems. It represented the last in a series of products that addressed this general goal by documenting and applying the lessons learned from the initial evaluation work. Preceding the document were two publications that are direct products of the small jails evaluation. *The Nature of New Small Jails: Report and Analysis* was

released in 1985, and *Small Jail Special Issues* was released in 1986. These publications are still available from the National Institute of Corrections and are companion pieces to the original *Small Jail Design Guide* and this revised *Jail Design Guide*.

THE SECOND EDITION

The *Jail Design Guide* retains the basic purpose, organization, and content of the first edition. Besides expanding the target audience, it updates the first edition by:

- removing references to specific standards that are now outdated,
- adding revised material that accommodates significant changes in standards and concepts,
- revising and adding graphics, and
- adding some new material on topics like jail expansion and renovation in lieu of new construction.

One other change was the deletion of the "illustrative floor plan designs" that appeared in the first edition. In retrospect, they were judged to be of little value and perhaps counterproductive given 1) the design guide's emphasis on thoughtful development of individual solutions to individual problems as a way to avoid the mistakes of other jurisdictions, 2) the extensive design material presented elsewhere in the design guide, and 3) the possibility that the designs might be inappropriately perceived as "prototypes." Prototypes are the antithesis of what the design guide is meant to inspire since the premise of a prototype is that one design suits all, irrespective of a community's individuality.

LESSONS FROM EXPERIENCE

The materials presented in the design guide are based on ideas and concepts that have been found through research and experience to work for jurisdictions faced with the challenge of building small or medium-sized jails. The materials also focus to a significant but lesser degree on what has *not* worked. Consequently, it is hoped that through use of this design guide some of the lessons learned by others will benefit jurisdictions now about to enter their own planning and design process. In this way, people using this document can move one step closer to creating safe, secure, and lasting facilities of which everyone can be proud.

INTENDED AUDIENCE

It is expected that the primary readers of this document will be the people who operate and design small and medium-sized jails. It is also expected and hoped that other local officials such as commissioners, judges, and prosecuting attorneys might find elements of this document useful and informative. Those involved in the creation of a new jail, regardless of their role and regardless of the facility's size, should find the design guide a helpful resource.

CONTENTS

The following kinds of information are presented in the *Jail Design Guide*.

Planning information. Although it is not the goal of this document to present a how-to guide on planning, one chapter is devoted to identifying the characteristics of good pre-design planning in relation to planning's influence on architectural design. Planning considerations that affect design also appear throughout the document.

Architectural design data. The bulk of this document consists of information about the design of small and medium-sized jails. This information begins with the major considerations shaping the overall design approach, continues with detailed information about various functional components of a facility, and concludes with selected pieces on special jail design issues.

Transitional issues. The last portion of the design guide identifies some of the key activities that must occur during design and construction to make a facility an operational success.

"BETTER" JAILS

The opening statement of the design guide identified its purpose as one of helping to create "better" and "more effective" small and medium-sized jails. Since such terms can mean different things to different people, they should be defined.

The findings of the original small jails research indicate that better and more effective jails are fundamentally those that satisfy the basic needs of their occupants, users, and owners for safety, security, and efficiency. More specifically, evaluations of old and new jails throughout the country suggest that the following minimum characteristics are essential to attaining a better and more effective jail.

OPERATIONAL CHARACTERISTICS

- Adequate and efficient staffing, including around-the-clock jail staff and female staffing when women are housed.
- Staff well-trained in jail operations.
- Existence of written policies and procedures of operations.
- Constant surveillance or supervision of inmates, as opposed to intermittent observation.
Programs and amenities through which to influence inmate behavior and alleviate idleness.
- Existence of inmate rules and disciplinary procedures.
- Sufficient staffing and operational funding available prior to the opening of the new facility.

ARCHITECTURAL CHARACTERISTICS

- Adequate capacity, including the right kinds of capacity to allow proper classification, and flexibility in the use of capacity.
- Visibility of housing areas from fixed posts.
- Cell and dorm occupancies appropriate to the inmate type, preferably with emphasis on single occupancy.
- Control of sound levels and elimination of visual conflicts.

Provision of a decent environment (space, temperature, light, color, humidity) for inmates to live and for staff to work.

Minimum need to rely on electronic surveillance, especially closed-circuit television (CCTV).

- Properly detailed and designed exterior cell windows (when used).
- Spatial organization that accommodates the flow of activities rather than inhibits it.
- Ample storage.
- Meets some form of recognized standards.
- Can be expanded in terms of both capacity and support services.
- Can be maintained wherever possible through the use of local service personnel and locally available parts and equipment.

Although these characteristics may seem obvious to many readers, many newer jails fail to provide them. Some lack almost all of the characteristics and are considered architectural disasters by their owners. They are expensive mistakes laden with financial and political costs that can haunt local officials for years to come.

PROBLEMS OVERCOME

Generally, small and medium-sized jails with the foregoing characteristics have overcome or minimized some traditional problems.

Accommodation of small and special populations (e.g., female; intoxicated, behavioral problems);

- Assaults against staff and inmates;
- Suicides and suicide attempts;
- Fires;
- Vandalism;
- Lawsuits;
- Contraband passage; and
- Standards compliance.

PLANNING: A KEY CHARACTERISTIC

One key characteristic behind a better and more effective jail makes all of the other characteristics possible: *comprehensive pre-design planning*. Jail evaluations and practical experiences clearly demonstrate that jurisdictions that take the time to plan before they design, and that take the time to determine what they need before they authorize the architect to proceed, have fewer operational and facility problems. By performing the pre-design work necessary to learn and apply the characteristics of better and more effective small or medium-sized jails, local governments are achieving a greater degree of satisfaction with their new facilities.

Besides integrating the characteristics cited earlier, jurisdictions that did comprehensive pre-design planning also improved their architectural designs in the following areas:

- circulation patterns in the jail,
- placement of rooms within the facility,
- the right types and number of rooms,
- the adequacy of space provided,

- environmental quality,
- durability of materials and hardware, and
- proper views into **cellbock** areas.

These are all fundamental and necessary attributes of a successful small or medium-sized jail facility design (or a design of any size).

OPERATIONS AND DESIGN

The positive conclusion in support of pre-design planning leads to another important conclusion that serves as one of the fundamental premises of this document. Since good planning involves identifying users and activities, good design is clearly measured by the degree to which a building conforms to the needs and activities of the people who will use and live in the facility. To borrow an old phrase, good jail design is based on the premise that "form follows function."

The findings of the original small jails research, subsequent feedback on the document, and the practical experience of the authors over the last decade regarding the importance of planning and operations to attaining successful designs inspired the approach taken to the presentation of this design guide.

CONSTRUCTION DETAILS









Architectural construction details are not addressed to any great extent in the *Jail Design Guide*. Although this may disappoint some, construction details are excluded for several reasons, not the least of which is avoidance of an overly lengthy and complex document. Also, the authors want to encourage rather than limit local involvement, learning, and choice in the detail development of individual facilities.

The goal of this effort is to provide direction and assistance, not substitution for local efforts and decisionmaking. Providing detail and material recommendations could stifle creativity and the search for answers proper to the widely varying needs of jurisdictions across the country. Also, trying to address the full range of detail issues could easily lead to the unintended exclusion of alternative materials, hardware, or equipment and to providing insufficient detail to guide local efforts. Consequently, this document is limited to the major design questions and influences affecting small and medium-sized jails, leaving local architects and engineers to develop proper detail, hardware, material, and equipment responses.

ILLUSTRATIONS

Many illustrations are used throughout the design guide. The meanings of commonly used symbols follow.

GRAPHIC KEY

	2-way movement		room(s) in this component
	view		generally 1-way movement
	secure pass-through		room(s) from another component that relate to this component
	restricted access over counter		area within a room

2

PRE-DESIGN PLANNING

2 PRE-DESIGN PLANNING

Many communities fail to recognize the value of and need for pre-design planning. Once they acknowledge that construction of a new jail facility is unavoidable, they frequently want to move quickly and painlessly to a solution. Hiring an architect to start drawing plans, buying a prototype design, or signing a design-build contract on the strength of a budget and bed need estimate alone fulfills those desires for many communities.

Unfortunately, jails created without adequate pre-design work often experience problems once the facility is opened. The facility may be too small and quickly become overcrowded. Or it may be large enough but too expensive to operate. Important design features may have been left out, such as the ability to see into inmate living areas from a single control point or to move easily through the building. Support spaces may be inadequate or missing altogether. The building may lack important equipment and capabilities and may use materials prone to wear and breakage. The completed building may be nothing like local officials imagined or what the public expected for its tax dollars. Once these faults are discovered in something as permanent and visible as a jail, they tend to be thorns in the side of local officials for years to come.

What these communities left out of the facility development process was pre-design planning: the work that needs to be done before the architect can pick up a pencil. This early planning work is needed to answer a number of critical questions.

- How many beds should the jail have? How many inmates will it hold when it opens and further into the future?
- How many and what types of inmates will need separation from others?
- How will inmates be supervised?
- What are the options in terms of renovation, addition, or new construction?
- How should the jail interrelate with other criminal justice functions?
- What programs and services will the jail provide and to what extent?
- How many staff will be needed?
- What kinds of spaces should be in the jail? How big should they be? How should they be arranged?

- How much and what type of expansion capability should be built in?
- How much will it cost to build and operate a jail?

Although it is not the purpose of the *Jail Design Guide* to be a complete pre-design planning resource, planning is sufficiently important to merit a brief review of its nature and impact.

REASONS FOR PLANNING

Planning takes time, effort, and money. Why should a jurisdiction bother, rather than going ahead and building a new jail when it already knows that it needs one? Here are some reasons.

- This may be the only chance during an official's lifetime to influence the direction of a facility that should last at least 30 or 40 years. In some ways, design has less impact than pre-design planning, where the really big decisions are made.
- Planning allows local officials to take control of the process and ensure that the jail built is what is needed and wanted rather than what someone else thinks is needed or wanted.
- Planning is a vehicle for gaining broad political and public support for the project. It can help prevent the project from being "shot down" when it comes to getting the money needed to build.
- Money-saving ideas, which might not come up during design, can be considered in this phase. Examples are the creation of non-jail programs (saving beds) or contracting for food and laundry services instead of paying for expensive space and equipment.
- The architects or design-builders, no matter how experienced in jail design, will not truly know what to design to meet a jurisdiction's needs without basic planning information. Consequently, they will have to design according to their view of what a jail should be, rather than the client's, and may well miss features important to local operations.
- The costs of pre-design planning are negligible compared to the costs of designing, constructing, and operating a jail, particularly one that is ill-suited to local needs. Pre-design planning usually costs between 1/4 to 1/2 of 1% of total project costs.

Because of the money and liabilities involved in a jail, local officials owe it to their constituents and themselves to consider the critical issues that pre-design planning is intended to resolve, rather than prematurely jumping into design, buying prototypes, or initiating a design-build process.

CAN A PROTOTYPE REPLACE THE NEED TO PLAN?

Local officials, and sometimes the public, frequently express the opinion that all jails are alike --or that they cannot be that much different -- so why bother with planning? Why not just use someone else's design, why not just buy a prototype, to save time and money?

Every community is unique and has different problems, but many have at least one common problem: their jail is overcrowded and they need a new or expanded one. While all jails have cells and need support services -- administration, lobby, booking, food service, laundry, programs, mechanical -- these commonalties rarely lead to an identical description of facilities needed by different communities. Many variables change the exact way in which people solve their problems, thus leading away from prototypes. For example, each local jurisdiction may have different:

- jail standards per state and per point in history;
- building and life safety codes per point in history;
- jail site characteristics (size, shape, elevation, soils, water tables, flood plain, etc.);
- physical relationships to the courthouse (on same site, across the street, remote);
- budgets;
- climates;
- bed capacity and expansion demands;
- mixes of inmate populations;
- facility design/management concepts (e.g., direct supervision versus intermittent surveillance);
- technologies;
- qualities of architectural detailing and engineering systems (mechanical, electrical, plumbing, etc.);
- correctional philosophies/public attitudes;
- operational policies and procedures (some dictated by law);
- degrees of qualified staff (low-paid, poorly educated to highly paid and highly educated); and
- preferences.

All of these considerations tend to interact in ways that diminish the likelihood that jail design appropriate for one community can be successfully used in another.

The Possibility of Re-Use

In spite of the issues raised above, it does seem theoretically possible to find a building plan that would exactly fit a community's needs. More likely is that specific parts of a prototype might meet those needs. To accommodate the differences, however, adjustments to the prototype would have to be made. Once adjustments to a prototype are needed, a community may have the worst of both worlds: adapting most of its needs to someone else's solution while absorbing nearly the full price of design after purchasing the drawings and paying for plan adjustments.

To prove that an existing plan could work, a community would be advised to at least "program-in-reverse." That is, a team of community representa-

tives should visit the prototype facility being considered and spend considerable time there evaluating: 1) in detail, all of the spaces and how those spaces work, 2) staffing required by those spaces, and 3) whether the building's construction, code, and standards performance is adequate and up to date. If everything about the building's design, operation, and staffing would work for the community, it would be fair to consider it a potential prototype. If not, the community must determine if it can adapt its operations, staffing, and needs to accommodate the prototype's non-compliance with local requirements, preferences, and practices. As with any other purchase, however, the community is advised to check products and prices at more than one location.

The cost savings realized by buying someone else's plan may not be as great as hoped. They may not be worth losing the opportunity to creatively plan and program a facility to meet the specific needs of the local community that will operate it for the next 30 years. For example, assume the architectural and engineering fees for a normally developed project are 7% of the cost of construction. In buying someone's plans, the community would have to negotiate payment to the programmers, architects, and engineers who created the design and who retain copyrights to it. The community may also have to negotiate payment to the client who paid for the design and who may have legal rights to it. Costs will also be incurred for doing whatever site adaptation is required and for preparing a full set of drawings to which the architect can legally affix his or her license stamp and for which permits will be sought. Any changes to the plan would also incur potentially significant costs.

The savings that actually accrue from reduced planning and design and an earlier construction start are likely to be 2% to 4% of project costs. When one considers that the operational costs for a jail are 10 times greater than construction costs over a 30-year life cycle and adds that data to the equation, savings through use of a prototype dwindles to 0.2% to 0.4%. A creatively planned and designed original facility that saves one full-time equivalent staff position per year, compared to the prototype, will, over 30 years, save many times the design and planning savings hoped for with use of a prototype.

Buyer Beware

All jails are not alike. Savings through use of a prototype are generally not as significant or as certain as a community may think or hope. Use of a prototype should be approached carefully and thoughtfully, with a complete awareness of the issues involved. Decisionmakers should focus on the real cost implications of sacrificing opportunities for creative, efficient, and specific solutions to community needs if thorough pre-design planning and original design are bypassed.

PLANNING STEPS

Two main phases in pre-design planning are directed toward answering basic planning questions and preparing a jurisdiction for design. They can be initiated separately in sequence or collapsed into one overall pre-design planning process.

- The first phase is called "*needs, options, and cost assessment.*"
- The second phase is called "*facility program.*"

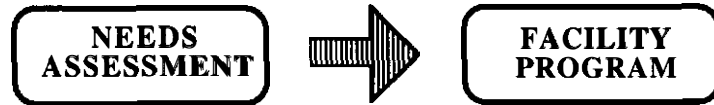

Each is described briefly here, with more information available from the Jails Division of the National Institute of Corrections.

Generally, the local planning team will need the assistance of an experienced consultant to assist with these steps. However, it is essential that local officials, staff, and citizens remain very involved with the process to ensure that the results are compatible with local needs and desires.

PHASE 1: NEEDS, OPTIONS, AND COST ASSESSMENT

The Needs, Options, and Cost Assessment phase is frequently referred to by other names that are less descriptive: "master plan" and "feasibility study." For brevity, it will be referred to as the "Needs Assessment" phase here. Whatever the phase is called, its goals are the same: to broadly define what a jurisdiction *needs*, what *options* it has to fulfill those needs, and what it will *cost*. It concludes with:

- a statement of the project's size (capacity and gross square feet) and chief characteristics;
- a selected and endorsed option, frequently including an identified site location; and
- an estimate of construction/project costs and operational/staff costs.

This phase is the most important to the facility development process because it is where the "big questions" with big cost and operational implications are asked and answered. Once a jurisdiction completes this phase, the remaining work can be viewed as detail implementation of decisions made -- even though far more time and money will be spent to complete the subsequent phases of pre-design programming, design, construction, and transition.

The Needs Assessment phase is to the facility development process what the **foundation** is to a building. If the foundation is weak, the entire building is likely to exhibit flaws throughout its life.

TASK 1: FOUNDATION FOR PROJECT WORK

Continuing the foundation analogy, any good process begins with common ground among planning participants. To the extent that communications between participating parties are good and expectations are understood, the chances for success in planning are greatly enhanced. Therefore, establishing a good foundation for the Needs Assessment work is essential.

Basic foundation-building tasks include:

- identifying the roles of planning participants and establishing communication protocols;
- researching applicable standards, codes, and caselaw;
- reviewing prior jail studies, reports, and evaluations;
- determining a supportable mission and related goals for the project; and
- becoming more knowledgeable about current thinking on jail design, operations, and staffing issues.

Below is a brief elaboration on the last two items.

Mission Statement

The basis for making project decisions is to define the purposes of the jail in the jurisdiction, developing what is often called a "mission statement." This will define many fundamental aspects of the jail:

- the legal mandates for the jail;
- the entities that are responsible for its operation and funding;
- who will be incarcerated in the jail and why;
- responsibilities for safety, security, and service to inmates, staff, and the community; and
- the "correctional philosophy" of the jail with respect to sentenced inmates, including goals of punishment, reintegration into the community, rehabilitation, etc.

While some of these issues may seem vague, they can have a direct impact on the size and nature of the jail that is built. For example, if the planning team determines that responding to alcohol abuse is part of the facility's mission, planners will be guided to provide spaces not only for receiving people who are under the influence, but also for offering counseling and other support services.

Learning More About Jails

Two truths apply to jail planning for **small** jurisdictions, if not all jurisdictions. First, things have probably changed greatly since the last time the jurisdiction built a jail. Second, though the jail staff works hard on a daily basis, they are typically too mired in the existing jail's problems to be broadly aware of modern concepts, requirements, and possibilities. It is therefore very valuable to spend time early in the process -- before pre-conceived notions take firm root -- to learn more about modern jails.

Learning about current issues and concepts can be done by:

- participating in training programs like those provided by the National Institute of Corrections;
- attending conferences sponsored by professional organizations like the American Jail Association (AJA) and its affiliate state organizations;
- touring new facilities in other jurisdictions;
- reading articles and books; and
- working with experienced consultants who can make oral and visual presentations on jail issues.

**TASK 2:
ESTABLISHING
BED CAPACITY**

No one has a crystal ball with which to foresee the future. Yet projecting the number and type of jail beds that will be needed in the years after the new jail opens is an important early task in the Needs Assessment phase. The total number of beds drives facility costs more than any other factor.

Establishing bed capacity is not simply a function of executing mathematical projections of future need based on past data trends. For one thing, past data may be of limited use since overcrowding may have forced local criminal justice officials to release people in ways that are normally undesirable. The data then would be artificially low and unrepresentative of true historic needs. Mathematical projections based on that data would be too low, raising the unhappy prospect of overcrowded new facilities shortly after opening. Multiple issues should be considered when establishing future bed needs:

- *projections* of data other than jail average daily population (bookings, criminal case load, arrests);
- the condition of the local *economy* and *community*;
- local and regional *population growth* and demographic changes;
- *alternatives to incarceration*, such as releasing pre-trial inmates on their own recognizance or creating a home arrest program (electronically monitored or otherwise) for sentenced inmates;
- *streamlined criminal justice case processing* that results in shorter pre-trial lengths of stay and thus a lower jail population;
- *changes in law* that could measurably increase or decrease the jail population, such as a state mandating that non-violent felons serve jail time rather than state prison sentences;

- inmate *classification and separation* requirements (see Chapter 3 on "Classification\Separation"); and
- daily, monthly, and annual deviations from the projected trendline, i.e., *population peaks*.

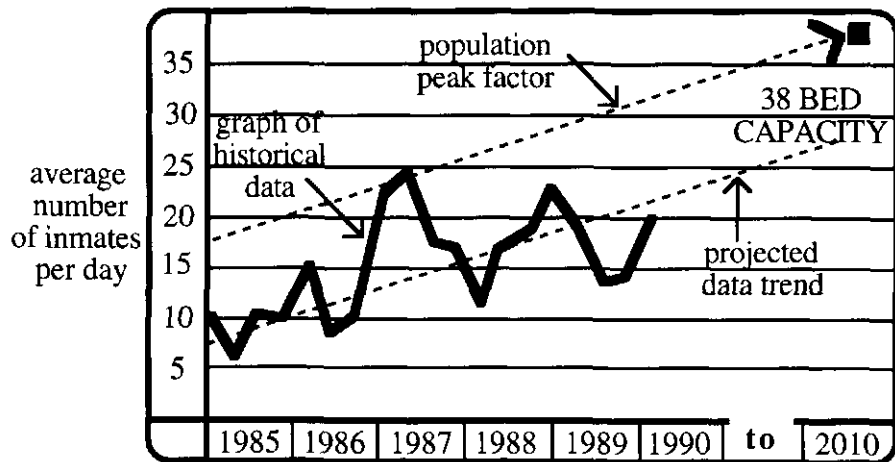

The bed capacity must be arrived at by consensus of local officials using jail data, analysis of past and current forces impacting the jail population, and good judgment. A mathematical projection is only one tool to help in establishing the bed capacity.

Capacity-Setting Results

The results of a bed-capacity-setting process will include capacity projections broken down:

- by year (for 10 to 20 years into the future for initial construction, and beyond for use in planning for expansion); and
- by type of bed (male/female, security type, special needs), which will determine the number and size of the jail's living units.

In addition, the capacity-setting process will recommend alternative policies and practices for the criminal justice system to limit the growth in the number of inmates or describe otherwise unexpected increases due to policy changes.

Conditions that can lead to inadequate capacities in the future include:

- a lack of adequate data about the past;
- trends that are difficult to interpret;
- poor implementation of alternatives to incarceration that are central to the adequacy of the selected capacity; and
- unanticipated changes in law, philosophy, and culture

TASK 3: MAJOR BUILDING CONSIDERATIONS

Once the capacity is set, reasonable conclusions about the general magnitude and character of the building can be reached by making basic decisions with respect to several major considerations. These allow preliminary calculations of required building square footage and thus allow the development of feasible options and accurate cost estimates. They also drive operational costs. Major considerations to address are:

- confirming the inmate *classification/separation* system established during capacity setting;
- determining the appropriate *occupancy level* for each classification of inmate (e.g., single-occupancy cell, double-occupancy cell, multiple-occupancy cell, dormitory);
- establishing the method(s) by which inmate *supervision/surveillance* will occur in housing areas;
- calculating *staffing needs* relative to different design and management concepts;
- identifying the range of *non-housing functions* in the jail that must be supported by space (e.g., booking, medical, administration);
- ascertaining which *services* (e.g., food) can be obtained elsewhere or to what outside agencies the jail might provide services through expanded facilities; and
- deciding the degree of *expansion* to be accommodated

TASK 4: OPTION DEVELOPMENT

Once the planning team has a picture of jail space needs, it can begin to explore options for accommodating those needs. The team will see the shortfall between needed beds and support space and the existing jail capabilities. Can it be accommodated through a renovation of, or addition to, the existing jail? Can the existing jail accommodate the key supervision and occupancy concepts established? Is new construction the only practical way to provide capacity and solve other problems with the existing facility? Should facilities separate from the jail be provided for work releasees or others? Can a multi-jurisdictional facility be created for all inmates or selected groups, such as females? What are the differences between downtown construction and building on the edge of town?

The Needs Assessment phase will help answer these questions and also develop an idea of the construction, project, and operational costs of each option as well as sources for the needed funds.

PHASE 2: FACILITY PROGRAM

Once the needs assessment work is finished and an option is selected, a considerable amount of work still needs to be done before design can begin. This is because the operations of the jail should dictate the design, not the other way around. The planning team must be in a position to tell the

architect how the jail is to function in detail and to tell local governing boards how many staff will be needed.

While the needs, options, and cost assessment phase dealt with the "big issues" that generally shape a jail, the programming phase deals with refining details. Only in this way can the detail work of putting a building together flow smoothly and with the full understanding and endorsement of the staff who will operate the facility and the owners who will pay for it. The program is the instruction book for the designer and the gauge by which the jurisdiction judges the adequacy of the design.

Among the kinds of information added to the process by the program are:

- documentation of essential policies, practices, and scenarios that generate space needs and relationships;
- description of the **services** and functions to be provided in the facility;
- identification of each space in the building and its size;
- description of how spaces should be grouped and how they interrelate;
- proposed staffing needs with basic descriptions of staff duties;
- more precise pre-design project, operational, and life cycle cost estimates; and
- **parking**, access, and site requirements.

The balance of the *Jail Design Guide* can help the planning team consider each function in the jail and determine the desired approaches. As these topics are explored, with or without an architect, it is important to **document** all decisions, either as notes, memoranda, or a program report.

WHEN PLANNING WORKS WELL

Rather than viewing planning as a number of hurdles that stand in the way of getting a new building, it should be seen as an opportunity to ensure that the jurisdiction gets the building it needs -- one that will serve the community for many years to come. Planning works best when:

- it is done with considerable involvement of local **government**, which must fund the jail; the affected agencies, especially, but not only the sheriffs office; staff, who will work in the jail; and citizens, whose taxes support the jail;
- it results in these groups "buying into" the project and supporting it at each major phase, from funding to operations; and

3

MAJOR DESIGN CONSIDERATIONS

3 MAJOR DESIGN CONSIDERATIONS

Once the pre-design planning is complete, it is time for the architect and the client to undertake the design process. This process starts with preliminary "schematic" designs of a very basic nature. These initial designs explore a series of major considerations that will fundamentally influence the direction of the design, well before individual spaces are drawn.

Each of these major considerations involves fundamental operational and security decisions that should have been made during the pre-design planning process. They are, in essence, the "big ideas" that make the design "work" in the way intended by local officials, operators, and users.

The purpose of this chapter is to identify and elaborate on major considerations relevant to the small and medium-sized jail. Specific information about various jail components and spaces -- the detail that completes a design -- is given in Chapter 4.

The considerations addressed in this chapter are:

- Site selection and design,
- Jail image and appearance,
- Classification and separation,
- Surveillance and supervision,
- Staffing impact,
- Security perimeter (envelope),
- Criminal justice interface,
- Functional components and relationships,
- Planning and designing to standards, and
- Expansion.

Although it is not the purpose of the *Jail Design* Guide to instruct on the pre-design planning process, considerable planning and operational content is included in each discussion.

SITE SELECTION/DESIGN

The location of the jail will affect its operations and the convenience of staff and visitors for years to come. It will also affect construction, project, and annual operational costs.

Site selection is frequently a difficult political issue. Finding a location acceptable to the public has been a major stumbling block to many projects, resulting in delays and, in some cases, the termination of an otherwise well-planned effort.

Careful site selection, then, is one of the most important features of a successful facility development process, as is the consideration of a site's impact on design. This section presents information about site location and design that needs to be taken into account in choosing and developing a site for a new jail. The various issues surrounding site selection can be organized around three primary factors: size, location, and cost.

SITE SIZE

The size of the site will greatly influence design. Size needs are a function of the ground level area of the building (including area for non-jail functions) and area needed for expansion, parking, building access, outdoor activities, landscaping buffers, and support elements such as outdoor equipment. In rural sites, non-building elements may comprise 80% of the site area.

BUILDING AREA

In first considering site possibilities, it is important for the client to appreciate how much larger a new jail will be when compared to the existing jail. It is not unusual, for example, for new facilities to be **four to six times** larger than older facilities, even though they have only twice the capacity. This is typically due to several key factors besides the increase in bed capacity:

- increased per bed square footage requirements in housing areas;
- increased provision of program and support areas; and
- oversized support and program areas to accommodate future bed capacity expansion.

The client may expect the new jail to be only twice as large because the projected capacity need is only twice as great. This misperception has led to difficulties in developing a useful list of site possibilities and to early public commitments to sites that were too small.

The actual **ground area** to be required for the building is critical to determining site size. However, for the following reasons, ground area is rarely the same as the total square footage documented in the space program developed during pre-design planning.

- **Irregular shapes** -- To achieve interior efficiency, many jails have irregular shapes (non-square or non-rectangular, for example) that create unusable spaces between portions of the building.

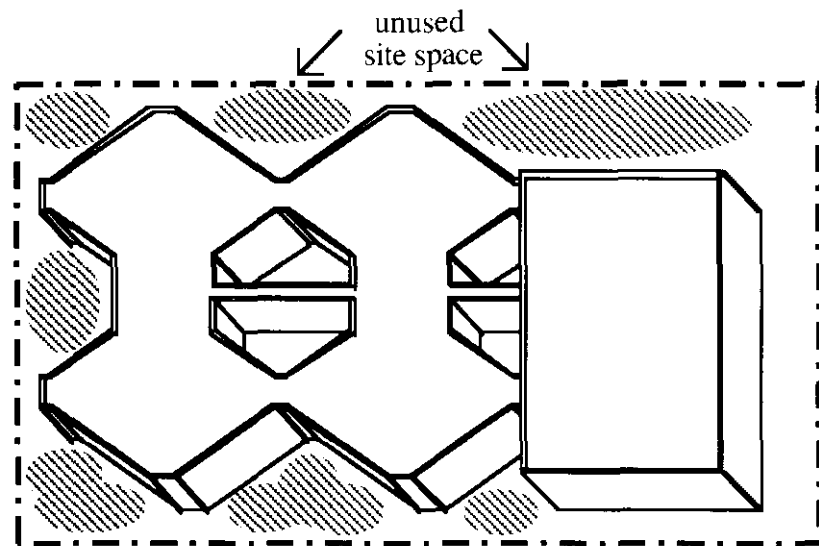

- **Multiple levels** -- While the small and medium-sized jail tends to be most effectively developed as a one-level structure, the facility, particularly if it has other functions associated with it (law enforcement, courts, etc.) might be developed on multiple levels. This might include a basement level for mechanical systems, computer rooms, and storage. A commitment to a multiple-level jail should not be made merely to save on the amount of site needed unless the functioning and security of the building are not compromised and staffing needs are not increased beyond acceptable and supportable levels.

If a multiple-level jail must be developed, the functions that *must* be on the ground level should be identified and the sites studied to see if they can accommodate them.

- **Two-tier housing** -- Some designs use two-tier housing -- one cell over another and sharing a common single-level dayroom -- thus saving ground area coverage.

BUILDING EXPANSION

Many new jails are designed without consideration of future capacity expansion. With the many changes that have occurred and can occur with criminal justice philosophy, state law, and arrest rates, expansion planning must be part of any facility development process. Expansion options, then, must also be considered in establishing the size of the required site:

- future bed capacity expansion;
- future jail support/program service expansion;
- future expansion of non-jail functions sharing the building or site

- law enforcement,
- courts and court services,
- clerk of courts and court services,
- prosecuting attorney,
- probation/parole, and
- other county offices.

In the absence of specific expansion plans, providing *twice* the area of the jail for expansion needs would not be unreasonable.

PARKING

The parking needs of a jail facility can be considerable and, at approximately 350 to 400 *square feet per car*, can represent a significant on site requirement. Parking allocations should be developed as follows.

- **Staff** -- One car per employee on the largest two shifts combined to allow adequate parking at shift change. For example:

	<u>"Shift 1"</u>	<u>Shift Change</u>	<u>"Shift 2"</u>
Staff	5	9	4

- **Family/personal visitors** -- Two cars for the maximum number of visitors allowed at one time to allow enough parking for both the persons visiting and the persons coming to visit during the next time period. This provision assumes some scheduling of visits so that visitors arrive sequentially rather than all at once. Without scheduling, parking demands will be greater. For example:

Maximum visitors = 8
 8 visitors visiting
8 visitors waiting to visit
 16 total visitors requiring parking

- **Others** -- Spaces as appropriate for:
 - arresting officers from city, county, and state agencies;
 - outside service providers (doctors, nurses, counselors, volunteers);
 - official vehicles, such as transport vans; and
 - business/official visitors (lawyers, bondspersons, sales representatives, law enforcement officials).

Multiple parking areas -- A key consideration in determining parking needs is whether all parking can be in one large area or whether it must be in multiple areas with separate accesses. The chief advantage of one large parking area is that peak needs, such as those occurring at staff shift changes and during visiting, can be better absorbed into fewer overall parking stalls through scheduling.

A primary advantage with **multiple areas** is that secured parking can be provided for staff cars and official vehicles that are sometimes subject to

vandalism. Additionally, separate areas tend to better recognize an official, professional status, particularly if select parking stalls are protected from the elements (such as shed-like covered areas).

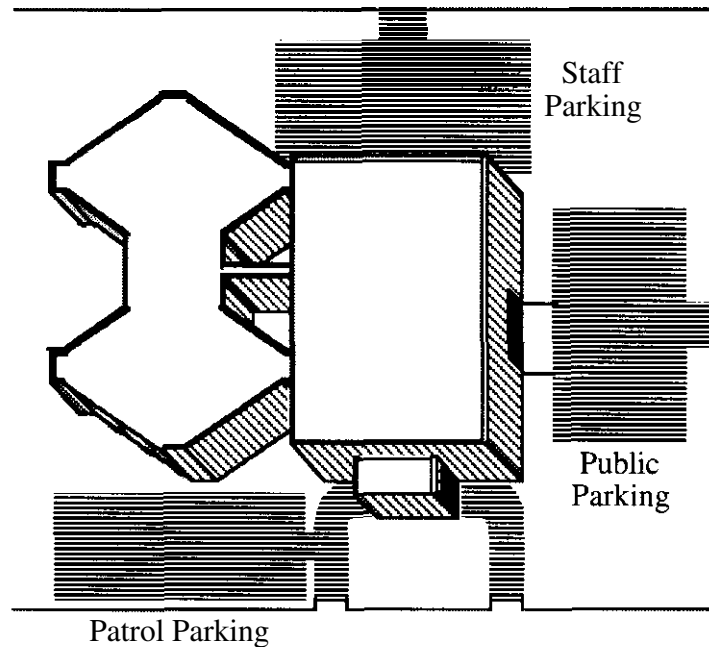

At a minimum, consideration should be given to establishing a certain number of dedicated parking stalls if a single large area is developed.

Convenience and functionality are additional reasons to consider separate parking areas, accesses, and drives, and their impact on site size. For example, it may be desirable to create separate parking for arresting officers near the **booking** area and near where they can re-enter the facility to complete any remaining business pertaining to an arrest (filing reports or evidence, disposing of inmate property).

Expansion needs must also be considered when calculating a facility's parking and site needs.

OUTDOOR SPACES

The principal outdoor areas needed for a jail include:

- **exercise** area -- walled, fenced, or unenclosed, depending on the security level of inmates.
- **emergency egress/refuge** area -- a controlled outdoor area to which inmates can be temporarily evacuated in an emergency. This may be the same as the exercise area, if part of it is far enough from the main building (check codes for more details).
- **visiting** area -- for minimum-security inmates, perhaps with a picnic table.

- *farm or garden* area -- if the facility grows some of its own food or has an inmate training program.
- general *landscaping* area -- for aesthetic purposes and the creation of buffers between the building and the public.

ACCESS TO THE SITE

Vehicle driveways and pedestrian walks required for building access and services take land area. The principal forms of access for which area must be provided include:

- arrestee delivery and transport, frequently in association with a secure vehicle sally port and a secure pedestrian entry;
- food service delivery, which may involve semi-trailer trucks;
- supply delivery;
- staff (affiliated with parking);
- public/official visitors (affiliated with parking);
- inmates, staff, or visitors with disabilities (affiliated with parking);
- work release/periodic inmates, when they enter and exit at a point different from most inmates for security reasons;
- garbage removal;
- emergencies, including medical and fire;
- mechanical repair/equipment replacement; and
- officials from other agencies, such as law enforcement.

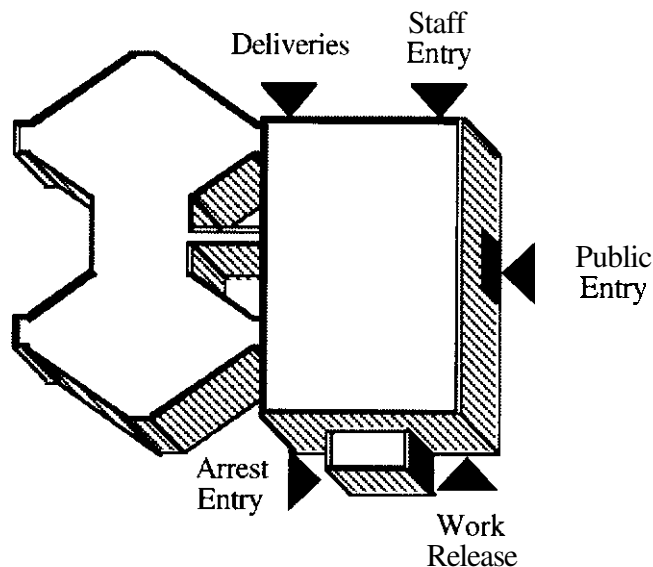

SUPPORT ELEMENTS Ground space may be needed for:

- radio antennas,
- gas tanks and pumps,
- utilities (transformers, sewage treatment, etc.),

- water retention areas (in locations where onsite management of water run-off from heavy rainstorms is a concern),
- garbage dumpster/compactor, and
- special law enforcement needs (impound yard or building, vehicle service bay, etc.).

TOTAL SITE AREA

By adding together all the elements, the total required site size can be determined and site identification can begin in earnest.

Building Area (x irregular shape factor)

- + building expansion area
- + parking areas and parking expansion
- + outdoor spaces
- + walk and drive access areas
- + support element areas
- = Total Site Area Required

SITE LOCATION

The location of the jail depends on satisfying several major concerns

LINKAGES

In locating the jail, several important relationships, or "linkages," should be satisfied. The jail should be designed with awareness of relationship or proximity needs to:

- **The courts.** Maintaining efficient and secure movement of inmates between the jail and the courts may be the single most critical linkage. A direct physical connection is most desirable, although being on the same site is of some value. On the other hand, if inmates must be transported between the jail and the courts, a few blocks or a few miles makes little difference, since most of the transfer time is taken up with readying the inmate, loading, unloading, and re-admitting the inmate, rather than with driving.
- **Sheriff's law enforcement** functions (for investigations, interrogation, sharing of staff and facilities, and backup). Most desirable is a direct physical connection, although being on the same site but unconnected is also valuable. (See the section in this chapter on "Criminal Justice Interface.")
- **Services.** It is desirable for the jail to be convenient to lawyers, a health care center, educational resources, volunteers, employees' homes, and community groups (such as Alcoholics Anonymous). Additionally, proximity to emergency resources such as the fire department and medical emergency facilities is important.
- **Transportation.** The jail should be easily accessible to all staff working in the facility as well as to visitors and others. If there is a public transport system in the area, the jail should be close to it.

SURROUNDINGS

It is important that the jail be located in appropriate surroundings. If it is in the right type of area, conflicts with different types of functions will be avoided. The best locations are in government, light industrial, or commercial areas. In general, the jail should not be near a school, a housing area, a church, or a recreation area.

VIEWS AND CONTACT

Controlling views and contact between inmates and people of surrounding areas is an important consideration in site selection and design. There are several typical problems.

Outdoor exercise areas. The tendency to create an inexpensive, ground-level exercise area that can double as an outdoor emergency refuge area can, especially in downtown areas, create sight, sound, and physical contact problems, especially escape and contraband passage through, under, or over fences.

To help resolve this, the use of solid walls, protective screens over the exercise area, and careful placement within the floor plan can be effective. For more information on this, see the section on "Exercise Areas" in Chapter 4.

View conflicts from inmate-occupied areas. View conflicts can result, especially in downtown areas, with the use of windows to provide required or desired natural light in inmate-occupied areas. This is most acutely the case with cell windows on the ground level, although view conflicts from program areas (like multi-purpose rooms) can also occur.

Some responses to the problem include:

- Creating a heavily landscaped visual buffer, recognizing that trees and shrubs take time to grow.
- Creating window sill heights well above floor levels.

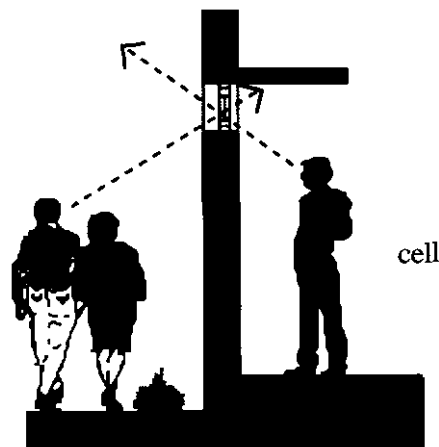

- Using tinted or reflective glass in windows, with night lighting on the exterior of the building to limit exterior-to-interior visibility while preserving inmate view and to discourage outside approaches to the building.
- Using translucent glazing in windows to provide natural light only (if allowed by local standards and codes).
- Using inaccessible skylights or clerestory windows to provide natural light and, possibly, a view of the sky only. Clerestory lighting, in particular, has to be studied because views may unintentionally be created between the inmate areas and the upper portions of an adjacent mid-rise building.
- Placing windows to look out onto controlled exterior spaces, such as courtyards or walled-in areas.

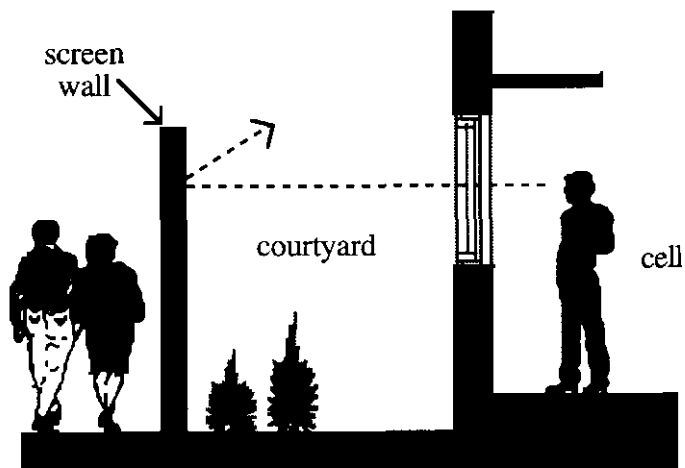

Another concern is *view conflicts between different inmate areas* where total visual separation is required (see the section of this chapter on "Classification/Separation"). Care must be taken, for example, not to create view conflicts between male and female cell areas through exterior windows.

Physical contact at the security perimeter (envelope). Physical contact with windows in inmate-occupied areas, especially housing areas at ground level, is a major concern in terms of escape and contraband passage. Responses here include:

- building secondary perimeters (fences, walls);
- keeping sill heights as far above grade as possible;
- planting tough, thorny bushes around the perimeter to discourage spontaneous, random contact;

- using security glass in a secure window design (framing, anchoring, glazing, opening size), possibly also including alarm systems built into the window;
- eliminating exterior windows (where allowed and acceptable) and introducing natural light indirectly through better protected sources within the perimeter; and
- using perimeter security systems (CCTV, lighting, infrared, pressure sensitive, etc.), though careful consideration must be given to the costs and aesthetic impact on the site surroundings.

Inmate workers. Jail operations sometimes include an inmate work program in which inmates provide services both inside and outside the facility (car washing, lawn mowing, etc.). Such a program, and the visibility and contact it implies, should be considered in terms of its impact on surrounding land uses.

Arrestee entry. Officers will bring arrestees to the jail daily, often with the arrestee in an agitated state. Although it has become common to provide a fully enclosed vehicle sally port for this purpose, some facility programs may not include this. Not having an enclosed sally port presents view, sound, and even physical contact difficulties that may be totally inappropriate for certain sites, given the surrounding buildings and their functions.

EXISTING JAIL SITES

Existing jail sites are frequently considered natural sites for new facilities because they are generally in good locations and are already accepted by the public for jail use. However, there are four typical concerns with existing jail sites.

Early demolition. If the existing jail must be demolished to make way for construction of the new facility, a major inconvenience and cost can be incurred for:

- transporting and boarding inmates elsewhere during the entire construction period,
- having no short-term holding capability for arrestees or for holding associated with court appearances,
- ensuring timely court appearances, and
- displacing associated law enforcement and criminal justice functions if they were also in the jail building.

Integration of the existing jail. There is a temptation to re-use the existing jail for part of the new jail functions. This would be disadvantageous if it results in a relatively small amount of generally deficient jail space overly influencing and compromising the design of a significant amount of new facility.

Effect on other criminal justice facilities. When the jail is on the courthouse site, planners must be careful not to limit growth options for adjacent court and criminal justice functions by putting the planning focus on the jail alone. In this case, it is wise to consider doing a full justice system master plan to ensure that all needs are adequately accommodated prior to making site commitments. Planning for existing courthouse/criminal justice sites must also consider overall parking needs, which are frequently overlooked.

Historic preservation. Existing jails frequently have historic value, if not to county officials, to citizens' organizations and to state or federal officials. The historic status and value of existing jails should be ascertained in considering demolition or renovation. It is also wise to check the historic status of any building that may be affected by the proposed project either now or in the future when expansion might occur.

TECHNICAL REQUIREMENTS

The design team should identify and deal with technical site design factors. Briefly, some of the technical factors include:

- the types of *soils* on the site, which impact the height and cost of the building;
- *utilities* available at the site or the cost of carrying them to the site;
- *topography* (or slope), site drainage, and potential for flooding;
- *zoning*, which could limit the height or square footage of the building or prevent its construction altogether; and
- impact on *traffic* flow around the site

SITE COSTS

The cost factors associated with any given site can be a significant element in determining its desirability. Some key cost factors include:

Acquisition costs, which may include legal costs if condemnation proceedings are required to obtain certain parcels or all of the proposed site.

Demolition costs for existing buildings and removing materials from the site.

Utility costs for bringing new utilities to a site or relocating existing utilities that would otherwise interfere with proper building development: gas, waste, storm sewer, telephone, electrical, and water lines. Utility costs can be quite high if the site under consideration must provide its own utilities, such as sewage treatment and water supply/treatment.

Site preparation costs, which can include significant grading of uneven sites, providing fill in low sites or sites with unstable soil conditions, and excavating rock to create basements or foundations.

Construction impact costs, which are additional costs that a site with special conditions or restrictions imposes on design or construction. Some examples:

- Less flexibility in design, leading to a less efficient facility requiring more staff.
- Need for more elaborate and expensive exterior detailing, as with the greater needs of a downtown building next to a historic courthouse versus a rural site with no surrounding structures.
- Need for a more expensive, tight, complicated mid-rise structure owing to lack of site size.
- Special basement foundation walls where the site is in a flood plain.
- Difficulty in staging construction due to limited land on which to store building supplies and set up construction headquarters.

Environmental impact study costs associated with producing, or hiring consultants to produce, the required information regarding the selected site and/or effect of the project on the surrounding environment.

Environmental clean-up costs associated with cleaning soil contaminated by gas and oil products, chemical spills, etc.

Lost tax revenue costs of losing tax-producing land, as in businesses, farms, and personal residences, and of losing revenue-producing land, as in county parking lots or rental property.

Transportation costs associated with providing the staff and the vehicle (~for transporting inmates between the new jail site and the courthouse or other detention, corrections, or service-providing facilities. Additionally, siting remote from the courts might demand creating a secure vehicle sally port and holding facilities at the courthouse for the secure management of inmates.

Boarding costs generated by housing inmates at another facility. A typical example is when use of the existing jail site requires housing all inmates at other facilities during the construction period.

Annual energy costs, which can differ according to site characteristics such as the presence of an aquifer that can be a source of chilled water to lessen air conditioning and heating costs.

Phasing costs of doing construction in multiple steps, due to special conditions such as keeping an existing jail open during initial construction

but tearing it down part way through the project in order to complete the project.

SITE SELECTION PROCESS

If only in terms of initially identifying and generally evaluating site possibilities, site selection must be handled early in the planning process. Preferably it is done during the Needs, Options, and Cost Assessment process discussed in Chapter 2. In selecting a site, these steps should be followed:

- Define site needs, including size, type of location, etc.
- Set other criteria.
- Identify potential sites.
- Gather information and evaluate each site

SITE EVALUATIONS - CRITERIA RATING OF 1 TO 10

	Site A	Site B	Site C	Site D
1 adequacy of acreage	7	9	5	5
2 utilities access	4	7	5	9
3 access to courts	6	6	6	3
~ ~ ~				
13 cost to purchase	10	5	10	7
14 public access	10	8	8	5
Totals	119	112	123	93

- Select one site.
- Acquire the site, if it is not already owned by the jurisdiction. If condemnation proceedings are needed to acquire parcels of a site, both time and funds may be required.
- Prepare a master plan of the site and an environmental impact report if required. An environmental impact report can take a considerable amount of time.

It can take quite a long time to go through the process, especially if controversy or "politics" is involved.

RISKS OF PREMATURE SITE SELECTION

While early work on site selection is valuable, it can be risky to select the site too soon. Enough information about the future operational space needs of the jail has to be developed to answer the questions discussed earlier. If a prematurely selected site turns out to be too small or in the wrong location, it would be a major setback in time, momentum, and perhaps money as well as an embarrassment.

This happened in one jurisdiction, where the site was selected by the county (along with a federal agency) without any public input or knowledge and before facility requirements had been explored. When the location was revealed, it stirred up great controversy -- and it was later determined that the site was too small anyway. This can be avoided with proper planning done at the right time.

IMAGE/APPEARANCE

The jail will project an "image" and give a message to the people who pass by, visit, work, or are confined there -- although the way each person responds to it will depend on why they are there. The building's image helps people recognize the type of place it is and establishes their expectations for what will happen there, how they will be treated, and how they should behave.

The typical jail of the past is easily recognizable -- hard and impenetrable, with steel bars and barbed wire. Many people now think that this traditional jail image is inappropriate given new attitudes about the role and purpose of the jail; that is, the desire to elicit normal behavior and to create a positive and accessible addition to the local community. Older jails tend to convey a message only of punishment and inaccessibility.

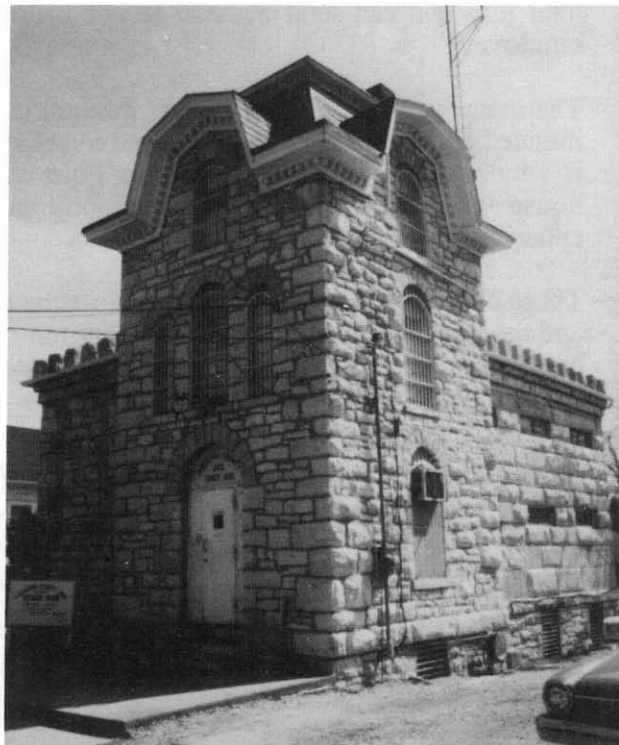

Familiar jail appearance.

EXTERIOR

The outside of the building will convey a message to the public about law enforcement and the role of the jail in the community. Jurisdictions should decide whether they wish to convey an image of community service, deterrence, frugality, or some other quality.

In considering the jail's appearance, take into account the context in which it will be located. If it is to be located downtown, it may be important to repeat the materials, colors, and scale of surrounding buildings so that it fits in. If the jail is to be near or adjacent to other government buildings, it is probably desirable to have the jail complement those buildings to create a unified and identifiable government image.

If the jail is to be located away from other buildings, the jurisdiction may be freer to choose the architectural elements desired. These might include less costly exterior building materials, such as decorative concrete block instead of brick.

INTERIOR

The interior image and character of the jail environment will be most important to staff and inmates, but will also be important to visitors. Staff will spend more time in the jail over the years than will individual inmates. The image and character of the jail interior can affect staffs satisfaction with their jobs and can send a message about how they are perceived by their employers.

The interior of the jail can also express and reinforce an expectation about inmate behavior, since all people tend to respond to their environment. That is why good church design inspires quiet and reverence, why good field house design encourages participation, and why good office design enhances productivity.

These concerns must be balanced against the perceptions of elected officials and the public. An interior that appears too nice to the casual observer can be interpreted as an intent to "coddle" inmates and create a "hotel-quality" environment. The mission statement of the jail (see Chapter 2) will go a long way toward setting the aesthetic tone for the interior of the building.

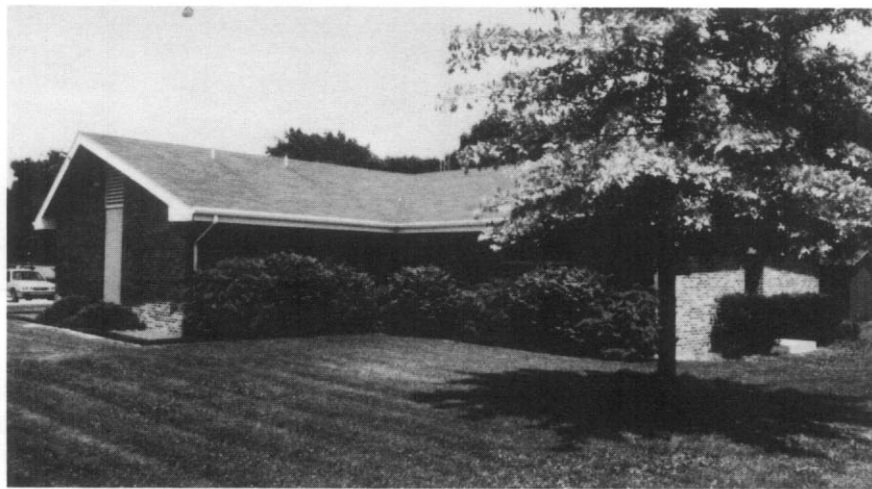

Jail using residential form, scale, and materials to comfortably blend into an adjacent neighborhood.



Jail (on the left) using materials, detailing, and scale to complement the appearance of an existing courthouse.

Research has shown that where jails have eliminated the symbols of incarceration and provided a more normal setting, there have been positive effects -- such as reducing stress, vandalism, and assaults -- so long as this approach is rooted in the actual operational philosophy used. These jails tend to use such elements as carpet on the floor, wooden doors in cells, bright colors, and lots of daylight. While using these features may seem counter to ideas about what makes a jail secure, inmates tend to treat the jail with more respect if its design communicates to them that they are also going to be treated with respect.

Differentiating the physical character of housing units can also be used to reinforce good behavior. For example, disciplinary housing units could have a more traditional jail appearance, such as concrete floors and fixed furniture, than the normalized general housing units. Thus, a more normal environment can be a reward for good behavior.

MAINTENANCE OF PHYSICAL SECURITY

A more normal appearance does not require that security perimeters and fundamental construction be non-secure. Concrete floors can be underneath carpet, and reinforced and grouted concrete masonry units can be underneath bright and pleasing paint colors. Wooden doors can **be** on cells where penetration of the door only allows access to a supervised dayroom, and daylight can be provided by security-glazed openings looking into controlled exterior courtyards.

OPERATIONS: KEY TO NORMALIZATION

The latitude that can be taken in creating a more **normal** environment depends to a significant degree on concepts of surveillance, staffing, classification, as well as on a clearly defined security envelope and internal zoning system. A facility that is inadequately staffed, does not maintain constant surveillance over inmates, poorly classifies and separates inmates,

and poorly defines and controls its security perimeter will have less success with concepts of architectural normalization. Concepts of appearance and character must be derived from, and intertwined with, concepts of operations and security.

DESCRIBING DESIRED APPEARANCE

After the jurisdiction considers the image and behavior it desires in the jail, it is essential that its decisions be communicated to the design team. **Adjectives** should be used to describe the desired appearance of the new jail, or reference should be made to other buildings that look the way that is wanted. Here are some pairs of adjectives from which to choose:

open -- closed
spacious -- confined
controlled -- free
warm -- cold
welcoming -- rejecting
minimal -- adequate -- generous
light, bright -- dark, dim
colorful -- plain
soft -- hard
friendly -- unfriendly
safe -- dangerous
caring -- indifferent.

CLASSIFICATION/ SEPARATION

Physically separating categories of inmates from each other remains a major design and operational problem for all jails, particularly the small jail. It is perhaps the problem that most distinguishes a small jail from a large jail. This is because a small jail must respond to the same variety of inmates as a large jail, but has far less capacity in which to disperse and manage them.

Housing units comprise about half of a jail's square footage and the primary security areas of the jail. Consequently, an issue like classification and housing area separation has a fundamental influence on basic design arrangements and facility success. Attaining proper separation in the non-housing areas is also essential to successful design.

The reader should note that there is a close link between classification and the issues of surveillance/supervision mode and staffing. Consequently, the authors strongly suggest that the reader also refer to the sections of this chapter dealing with those topics when considering classification and separation issues.

SEPARATION PROBLEMS

The difficulty of obtaining proper physical separation in smaller jails results from several basic problems.

INMATE TYPES

Unfortunately many counties and designers dismiss the need for translating the separation needs of a classification system into the jail design. In part, this may be due to an erroneous belief that small rural jails do not have to respond to the varied inmate types experienced in metropolitan settings. Experience has shown that this is true only to a degree and that, in reality, small and medium-sized jails must cope with a substantial number of inmate types, many of which require physical separation and management.

Examples of the varying characteristics of inmates in both large and small jails include:

- male, female, transsexual;
- adult;
- juvenile detained as an adult;
- prior arrest **and/or** conviction history;
- prior incarceration experience;
- short- and long-term stays;
- arrest for violent offense;
- arrest for drug-related offense;
- arrest for alcohol-related offense;
- immediate health problems;
- intoxicated;
- psychological or mental problems;
- sexual predators;

- under medical treatment;
- history of alcohol or drug abuse;
- disabled;
- violent and combative at intake;
- intent on self-destructive behavior; and
- known enemies in the facility.

By identifying the characteristics of the current and projected jail population, jail staff can begin to develop a classification and custody level for each inmate. Of particular importance is the need to identify classifications that can be housed and managed together and those that warrant separation and special management.

Typically inmates who are management problems and require special consideration in housing placement fall into several categories:

- Those who require protection and separation because they may be in danger from other inmates or a danger to themselves.
- Those who, by reason of their offense, criminal record, or institutional behavior, require enhanced security and close supervision.
- Those who received unusual publicity because of the nature of their charge or crime, the circumstances of their arrest, or the threat they pose to the public.
- Those who by reason of either their mental or physical condition require special housing.

In addition to making decisions about security levels, housing separations, and housing unit capacity from such data, the jail administrators and designer can use this information to make decisions about the type and size of *program space* needed. For example, if projections are that the jail population will have a high percentage of persons with drug or alcohol problems, this information can be used when planning for counseling and program space. If the population is characteristically youthful, planners may want to program space for physical activity accordingly.

COST AND FREQUENCY

It is impractical to provide a cell or housing unit for each type of inmate since many inmate types appear at the jail rarely or infrequently. Yet when they do appear, the jail must have the capability to provide appropriate physical, sight, and/or sound separation.

POPULATION CHANGES

The makeup of the jail population can change considerably from year to year or month to month. Populations may go from two-thirds sentenced to one-third sentenced or from two-thirds felon to one-third felon in relatively short periods. The adult female population seems to be most vulnerable to major swings in peak as well as average daily counts and presents a significant design as well as management challenge. This variability tends not to be as extreme in a large jail, but is a special problem for the small and medium-sized jail.

SURVEILLANCE METHOD

Different forms of housing unit surveillance, and related staff posting concepts, create different challenges in maintaining proper inmate separation.

Remote surveillance designs, in which a series of housing units is clustered around a fixed control position, pose the greatest challenge since visual and perhaps acoustic conflicts can occur between individual housing units as a by-product of the clustering design.

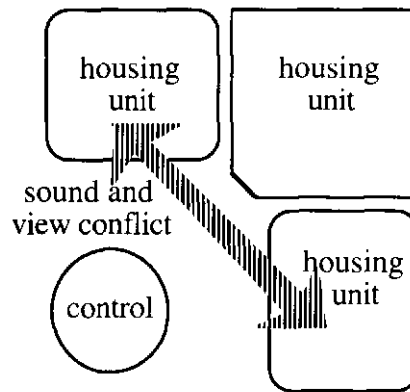

The success of podular/direct supervision over the past ten years has caused most jurisdictions that are planning new facilities to eliminate or minimize the traditional linear jail design with its reliance on *intermittent surveillance*. While physical inmate separation can be more easily attained with facilities designed for traditional intermittent surveillance, since the location and size of housing units are not closely tied to the location of a staff post, there are too many other operational drawbacks with this approach. While intermittent surveillance has the benefit of easily allowing many separate cellblocks, in reality visual and acoustic separation capabilities are lost through housing units located across from each other, back-to-back with each other, or next to each other in one common cellblock area.

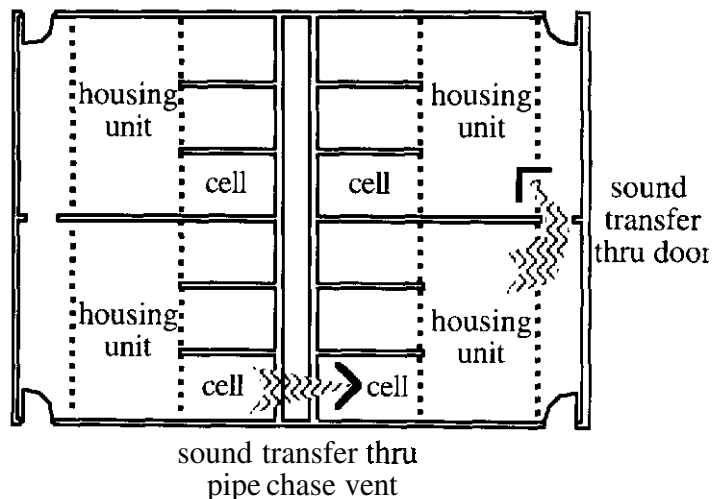

Many intermittent designs use steel bars on cell and **dayroom** fronts, thereby sacrificing sound and, in some cases, sight and physical separation capabilities.

Separation tends not to be a problem with *direct-supervision* operations since the units can operate in an essentially self-contained manner, thereby eliminating the need to affiliate them with control positions outside the unit or to expose them to full views from corridors.

More on surveillance method and staffing can be found later in this chapter.

CELL OCCUPANCY

Most older jails had much of their capacity in multiple-occupancy cells and dormitories that often compromised classification and physical separation decisions, especially when cells with four or more beds predominated.

In such a jail, when an inmate requires special housing, he/she effectively occupies four beds rather than one. Further, proper separation still cannot be achieved since the "special housing" cell is part of an entire **cellblock** from which sight and sound separation cannot be achieved. The traditional bar grill cell-front design only worsens this problem since not even physical separation can be fully achieved.

CLASSIFICATION SYSTEMS

A logical first step toward resolving separation problems in design is for the local community and jail administrators to identify the number and types of inmates with which they must deal and to classify them into appropriate groups.

Classification is a process of systematically assessing the needs and characteristics of jail inmates in order to respond to safety, security, health, and programmatic concerns. In some cases, the classification plan will call for separate housing of certain classification categories or require that they be housed in space equipped to handle their particular needs. Because of space limitations and the many classifications that can be established, a classification plan may also specify which inmate types can be housed together.

Jail classification systems have improved but still tend to be very subjective in that they require independent judgments by jail personnel making the classification decision. In general, the subjective approach is based on determining an inmate's relative conformance with several basic criteria (rules and regulations, policies, and procedures) that are extensions of the agency's correctional mission and physical plant capability.

Objective systems are preferable because they attempt to minimize subjectivity by using classification criteria to which weights or values have been assigned. An objective classification process promotes fundamental fairness and consistency, two attributes that the courts increasingly look for when evaluating the adequacy of classification systems.

WHEN/WHERE IT OCCURS

Initial classification typically takes place at the intake-release area. If the jail does not have *holding cells* in the receiving area or an *intake housing unit*, the inmate's swift transfer into the general inmate population will be assured unless some means of release can be arranged almost immediately. Many jails rely heavily on multiple-occupancy cells that hold two or more inmates. These cells are not appropriate for inmates prior to classification as they can provide the opportunity for various foreseeable problems: assaults, intimidation, fights, spread of disease, and passage of contraband.

If holding cells are available, classification decisions are made within the several hours during which temporary holding occurs. If an intake housing unit for initial stays of up to 72-96 hours is available, observation and classification can occur in a more deliberate fashion.

Following classification, inmates are given a housing assignment consistent with their classification status. This can only be done if the facility design and the separation it provides are compatible with the established system.

JUVENILES

With regard to housing juveniles in an adult jail, it should be noted that **most** standards call for housing only those juveniles who are subject to trial as adults and, even then, only if they are kept separate from adults. All other juveniles should be housed in separate facilities. Despite professional positions on the subject, this remains a serious problem for the geographically remote county with a small jail.

Given the sometimes protracted nature of the judicial process, housing juveniles to be tried as adults could involve stays of several months. This presents a real design and operational dilemma, especially for the small jail, in that the jurisdiction should probably provide enhanced supervision for juveniles. But from a design perspective, it is difficult to achieve physical, sight, and sound separation for one or a few juvenile inmates without isolating them, thus reducing the potential for proper supervision and increasing the likelihood of such problems as vandalism, depression, or suicide.

As difficult as the juvenile housing problem is for smaller jails, especially those in geographically remote areas, it is always more suitable to pursue alternative placement for juvenile inmates. Their presence in an adult jail presents nearly insurmountable operational and design problems. Efforts should be made to place them in facilities designed and operated exclusively for juveniles.

RESOLVING THE NUMBERS PROBLEM

The basic classification problem for small and medium-sized jails is one of *numbers*. There are simply not enough inmates in most categories to make complete separation consistent with an ideal classification system. And neither tricks of design nor advances in technology can ever fully bridge the gap, especially if affordable staffing patterns and facilities are required. Economics cause most small and medium-sized jails to house every inmate classification in a single jail facility rather than providing one facility for adult males, one for adult females, and one for juveniles.

MULTI-JURISDICTIONAL OPTIONS

One way to solve the numbers problem is to create larger sets of numbers by pooling the resources of several jurisdictions and building one larger facility. By increasing capacity, other problems are solved as well: more economical staff-to-inmate ratios and better opportunities to provide quality programs and services.

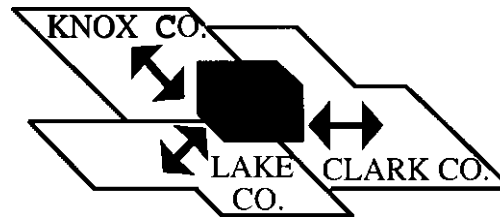

Although the multi-jurisdictional approach is sometimes problematic politically and may pose transportation, visiting, and local holding problems, many counties already engage in it to a minor degree through the occasional leasing of space on a per diem basis. Some counties find it easier to form limited multi-jurisdictional solutions for special, small, hard-to-manage classifications, such as juveniles and women.

Original small jail survey findings show that many new small jails had multi-jurisdictional arrangements of some sort. Forty-three percent transfer special inmates, 34% transfer juveniles, and 19% transfer women to other facilities. The NIC document *Small Jail Special Issues* deals with this problem and references other sources on the multi-jurisdictional option. This issue should be considered during the creation of local classification systems in terms of its impact on staffing, design, and costs.

DESIGNING FOR PROPER SEPARATION

In response to the many problems jails have with classification and separation, the following steps should be considered.

IDENTIFY INMATE TYPES

Jail staff should identify the various types of inmates that will be detained in the new jail facility. A key part of this endeavor is to identify types of inmates that may be dealt with at other facilities, either within the county or elsewhere. The problems of attaining effective separation can thereby be reduced if special groups can be eliminated from housing at the new jail.

The following inmate types should be considered for alternative housing:

- juveniles,
- mentally disturbed,
- suicidal,
- those requiring medical isolation, and
- intoxicated.

It is recognized that most groups, including some or all of the above, must be detained at the jail even if for very brief periods. However, because of

the special strain they place on space, management, and training, it is strongly recommended by most professionals and by most state standards that these groups be accommodated for very short periods only, generally avoiding stays of more than several hours.

Care should be exercised during the planning process to determine the probable *long-term availability* of outside resources for special groups prior to designing a jail without the capability to house them.

DETERMINE DEGREE OF SEPARATION

It is important to identify the degree of separation required among various inmate groups. Separation should be considered at several levels:

- between housing units,
- during movement through the facility to program or service areas, and
- during programs and services.

Housing Area Separation

The degree of separation needed in the *housing area* varies greatly for different groups. Physical separation may be all that is necessary between some groups of adult male populations. For example, the high-security adult male population may only need to be separated by physical barriers from the general adult male population. Sight and sound separation may not be a critical issue. On the other hand, sight and sound separation, as well as physical separation, is commonly required between the male and female housing areas.

Sound separation is required to prevent harassment between groups, eliminate undesirable communication, attain proper privacy, and eliminate disturbances between groups. Different kinds of sound might be controlled:

- normal conversation;
- shouting;
- TV and other artificially generated sounds;
- impact sounds (banging, kicking, tapping);
- noise from group movements; and
- mechanical and equipment noise.

Total sound separation is typically required between men and women and between juveniles and adults. Total sound separation of mentally disturbed inmates may also be desired. Sound separation between inmates, however, should not preclude or impede staff/inmate communication.

Conversational sounds can be managed by the use of solid, insulated partitions between adjacent areas. The isolation of other sounds may not only require heavier partitioning but sound-conscious detailing of doors and other openings that might allow the transmission of sounds through corridors and shared openings (such as jointly used security vestibules). Total sound isolation can frequently be achieved only by locating areas requiring isolation from each other in different parts of the facility.

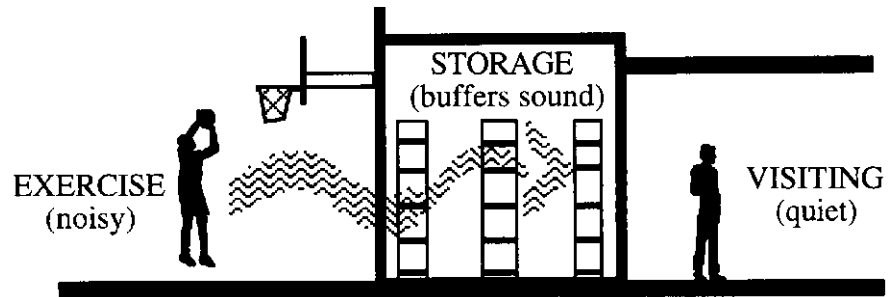

Sound can also be transmitted through ceiling plenums, duct work, and electrical outlets placed back-to-back between two areas. Consequently, a close review of these details is required to preclude unwanted sound transmission.

Movement Separation

Separation during times of *movement* must be considered. Is it acceptable to have female inmates walk past adult male housing units and therefore have the opportunity to see and to be seen? Some state standards and some practitioners object to this concept. However, passage through another area may not be objectionable in terms of having a disciplinary detention classification of male inmates move past other adult male housing units, even though physical, sight, and sound separation may be required between their housing units.

One way to clearly separate sight and sound contact during movement is to identify the basic degrees of separation desired in housing, to create appropriate clusters of housing accordingly, and to locate key program and service areas between those clusters. Such positioning enables inmates from the various clusters to move to the program and service areas without having to directly pass the housing units of the classifications from which they must be totally separated.

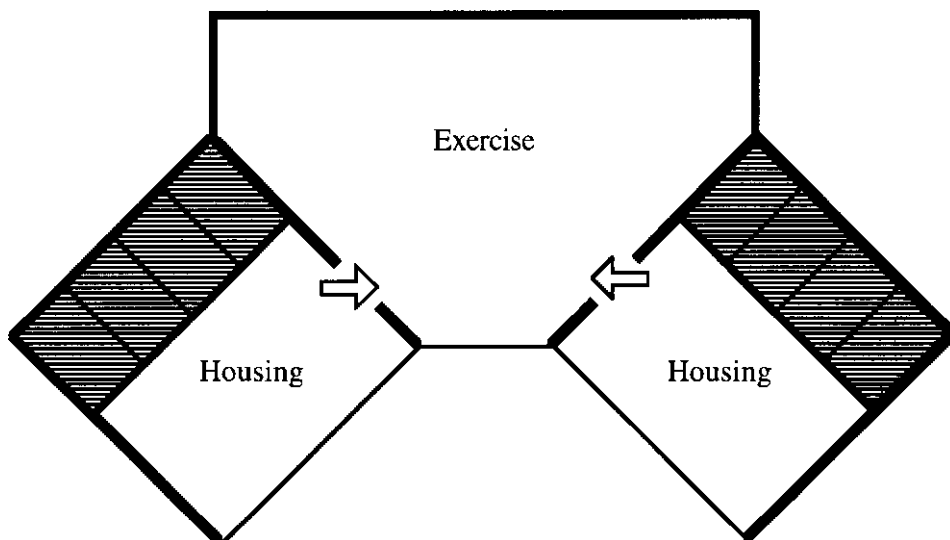

Program/Service Area Separation

Separation in *program and service areas* might *be* treated differently than separation for housing and movement or might cause special design considerations in joint-use areas. For example, while it may be desirable to separate the housing areas of the general male population and the high-security population, and to separate women from each of these, some of each category might participate jointly in alcohol counseling programs or wait in a common area for medical exams, depending on classification goals and methods of supervising the activities. To some degree, proper separation might be attained through scheduling key activities since the flow through these areas might be limited.

Attaining desired separation in the *intake-release area* is critical since all arrestees and probably all releasees (including inmates going to court) pass through this area.

Concern here centers on attaining proper separation for:

- temporary holding or waiting (management of loud, disruptive, and medical/mental health inmates);
- telephone calling;
- searches (controlling contraband dumping or exchange); and
- showers and dressing

More on the design of this area can be found in the functional-architectural component on "Intake-Release."

CREATE HOUSING AREA FLEXIBILITY

Given the changes in population mix in the small and medium-sized jail, it is essential that flexibility in housing area development be explored. Some ideas regarding flexibility follow.

Special Management Housing

Since some inmate types appear at the jail rarely or infrequently, opportunities might exist for creating housing units that can serve more than one special inmate type. This kind of multi-use housing capability is dependent on the groups sharing the space not being in the facility at the same time and having similar design requirements. This might also be an option for the medium-sized jail.

A key concept to evaluate is the creation of a constantly monitored "*special management*" area. It might consist of several small housing units featuring single-occupancy cells as well as dayrooms, showers, etc. This area would be separated from other areas of the jail with respect to sight, sound, and physical contact and would offer the same level of separation between individual special management units. Also, it would be flexibly designed to accommodate the various applicable groups.

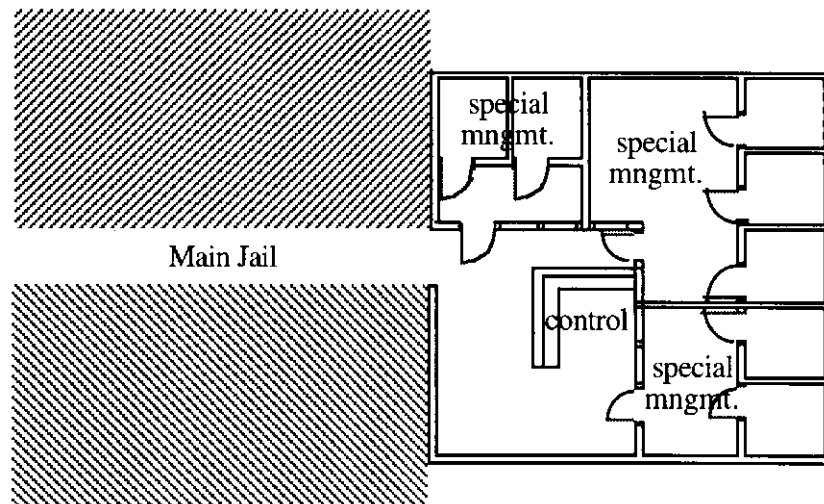

The following types of inmates seem to appear at the small or medium-sized jail on a rare, irregular, or infrequent basis. Thus they might be suitable for a special management unit.

- Those requiring medical isolation;
- Material witnesses;
- Juveniles bound over to adult court;
- Handicapped;
- Mentally disturbed;
- Those requiring administrative segregation (dangerous, disruptive);
- Those needing protective custody (at risk from others).

General Housing

Since the general population of a small or medium-sized jail can change considerably, it is a good idea to consider whether an area that is basically designed for low-security adult males, for example, might on another occasion accommodate high-security adult males. This type of flexibility can be accommodated in two basic ways:

- Sufficiently subdivide the capacity of the jail into small enough units that growth or decline of certain groups by, say, four to eight in population can be accommodated simply by the reassignment of a couple of key "swing" housing areas.

Since this problem of variation seems to most impact the adult male population, it would be wise to concentrate the entire male population into several basic units exclusive of the special housing areas. For example, where the adult male population demands a total of 32 new beds in two basic classifications, one being a general population unit of 24 beds and the other being a high-security unit of 8 beds, it might be better to subdivide that grouping even further.

Such a subdivision could be 16 beds general population, 8 beds high security, and 8 beds (or two groups of 4 beds) for "swing" space that accommodates variations in population.

- Another kind of flexibility desirable in general housing relates to the need to handle the occasional female overflow. Although most small and medium-sized jails have a relatively low female population, this will periodically change (surging upward, usually for short periods of time). During such times the overflow in female housing areas must be housed elsewhere. "Swing space" can absorb overflow for short periods if it has been properly designed to provide the necessary separation by sight, sound, and movement.

The flexibility required by these two approaches tends to suggest a more standardized approach to the design of furniture, equipment, and hardware.

Swing Cells

Another more complicated form of adding flexibility on a small scale is to develop designs that allow cells to serve two adjacent housing areas. Such a "swing cell" design concept is difficult to develop effectively, particularly if sight and sound separation is necessary.

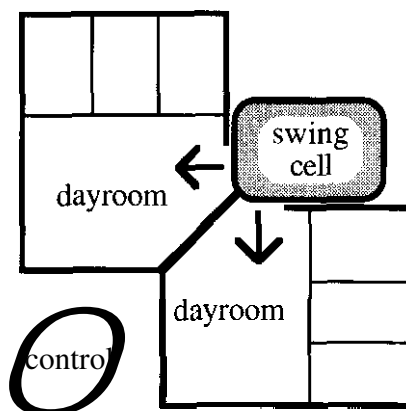

CHOOSE A SURVEILLANCE METHOD

Each of the basic surveillance/supervision methods has a very large effect on the ability to attain proper sight, sound, and physical separation between various inmate categories. Although surveillance methods are discussed in the next section, it is not premature to identify the surveillance methods and their various strengths and weaknesses as far as separation is concerned.

Direct Supervision

The direct-supervision method is a very effective approach for managing the behavior of inmates. Direct supervision allows staff to be in total control of all spaces and activities within the jail. Inmates are under constant staff supervision. Its principal effects on classification are both positive and potentially negative in the small jail. In positive terms, direct supervision allows for the merging of some populations that might not otherwise be housed together. For example, there would seem to be little or no need to create a "medium" security group and to separate it from a "minimum" security group. In addition, with direct supervision, there is less concern about slight variations in the makeup of the population as it changes over time.

One possibly negative impact is a tendency to over-staff the small jail by placing staff in pods with relatively small capacities simply to achieve both direct supervision and separation of certain inmate groups for management purposes.

Intermittent Surveillance

Intermittent surveillance approaches do not assume that staff will observe housing units constantly, thus placing no special requirements on grouping the various units around a constantly staffed post. Therefore, housing clusters can be dispersed for physical, sight, or sound separation.

However, intermittently monitored facilities tend to have greater operational problems in the areas of assaults, suicides, escape attempts, and damage. Consequently, if this approach is adopted in lieu of a constant method of surveillance or supervision, it is recommended that a more discriminating job of separating inmates be done. This would ensure that the density of each housing area is minimal and that security or management risks are more clearly separated by physical means, rather than by dependence on constant staff intervention, even though it cannot fully compensate for a lack of staff presence. Additionally, more emphasis should be placed on the use of higher security construction.

Remote Surveillance

The constant presence of staff in remote surveillance settings helps mitigate some differences in classification that call for separation of certain groups. However, while superior to the intermittent approach in terms of reduced operational problems, the remote method of surveillance poses a challenge to attaining necessary physical, sight, and sound separation between the different housing units that operate off the staff post. The constant presence of staff tends to minimize the effect of such separation problems, however.

In designing for remote surveillance, the following special concepts should be implemented to mitigate sight and sound separation problems.

- Create separate housing clusters for groups that require complete separation. For example, all male clusters could be developed separate from all female clusters.
- Control sound through the use of solid construction consisting of security glass and concrete block or concrete wall elements instead of bar or grill cellblock faces. Not only do fire codes typically demand that the **dayroom** faces be solid, but required acoustic and physical separation also demand that they be solid. Walls should extend past ceilings and above roof construction, and/or ceilings should be secure and resistant to sound transmission through ceiling plenums.
- Control views by the manipulation of **dayroom** faces, dividing walls, and the use of other barriers such as intervening corridor doors.
- Control views by placing housing units over each other.

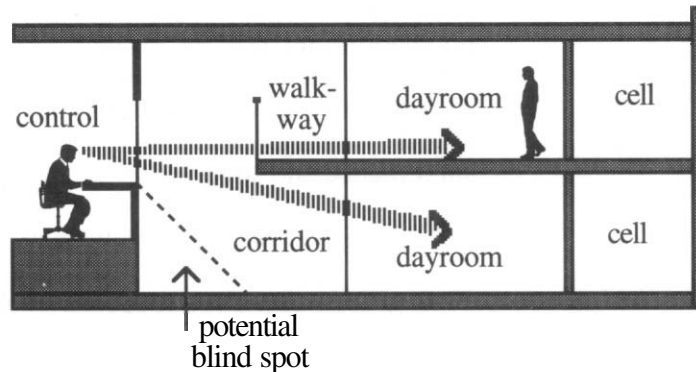

- Use reflective glass surfaces in the control position to eliminate views through the control center to other housing units. Some administrators feel that the inability of inmates to see the officer through such obscured glazing has a positive behavioral influence in that inmates never know when the officer is watching them. Such an approach is not without problems, however. Reflective glass can limit the control officer's view by creating darker, more reflective surfaces through which to look. This problem is complicated when light levels are higher in the control center than in areas being viewed. This approach also tends to de-personalize the jail environment by hindering inmate/officer interaction.



Reflective glass in the control center can inhibit officer view when light levels are too high in the control space.

USE TEMPORARY HOLDING CELLS

The use of temporary holding cells in and around the booking area may help minimize classification problems since many arrestees are released very quickly from a jail. These people include some of the special groups, such as the intoxicated and the mentally disturbed, who are referred to more appropriate service-providing agencies.

USE SINGLE OCCUPANCY

Multiple-occupancy spaces reduce flexibility and the ability to subdivide the population into distinct groups. Single-occupancy cells not only provide improved inmate management but allow greater flexibility in limiting the capacity of any given housing unit. They also avoid inmate-on-inmate assaults during lockdown periods (such as sleeping hours) when staff surveillance and supervision are normally reduced.

See "Single vs. Multiple Occupancy" in Chapter 5 for more information.

SEPARATE WORK RELEASE/PERIODIC HOUSING

Two groups that pose a special problem in terms of the introduction of contraband into the facility are work release and periodic-sentence inmates (typically weekends). Since work releasees and periodic inmates leave and return to the jail on a daily or other regular basis, they have ample opportunity to obtain and arrange for the passage of drugs, weapons, and other contraband that may be desired by other inmates. Consequently, while work releasees and the periodic population can share a housing unit, it should be completely separated from the rest of the inmate population, particularly from inmate workers who as part of their work detail often move throughout the jail.

Some of the problems associated with these inmates may be handled operationally. However, to guarantee total separation of work releasees and the periodic-sentence inmates from the rest of the inmate population the following design considerations apply:

- separate areas for initial intake and release,
- separate housing units,
- separate entrance and exit,
- separate visiting and recreation areas,
- separate laundry facilities so that contraband may not be passed into the general population by laundry workers, and
- potentially separate food staging or food service area.

More on these design approaches can be found under "Special Housing" in Chapter 4.

DESIGN FOR PRIVACY

The issue of privacy comes into play in two ways. The first is when one inmate type passes the area of another inmate type. Of particular concern is when inmates of one sex pass the housing area of the other sex and the design is such that they can view toilet and shower areas.

This same consideration is also true in relationship to staff who must be able to supervise shower and toilet areas without unnecessary invasion of privacy. Design of the shower and toilet areas, as well as other areas with a privacy implication, must allow for the prospect that staff of the opposite sex will be working in and around the housing unit.

SURVEILLANCE/ SUPERVISION

A key operational decision that will have a major impact on facility design is the method of inmate supervision or surveillance to be used. Concepts of surveillance and supervision have much to do with the way in which jail spaces are organized, with the amount of time staff are in physical or visual contact with inmates, and with the number of staff required. The degree to which the jail is a safe and secure facility in which to live and work depends greatly on these concepts and how they are translated into design.

The reader should note that there is a *close link* between surveillance/supervision and the issues of classification/separation and staffing. Thus, the reader should also refer to the sections of this chapter addressing those topics when considering the surveillance/supervision issue.

METHODS OF SURVEILLANCE/ SUPERVISION

There are at least four basic approaches to observing or supervising inmates. The fundamental difference between them is that two require the *constant* presence of staff and, thus, fixed staff posts and the other two do not, thereby leaving inmates to themselves for significant periods of time (up to 60 minutes in many jurisdictions). The four methods, as they apply to housing units, are described next.

CONSTANT PRESENCE REQUIRED

Direct supervision. In this method, jail staff are constantly positioned within each housing unit in direct contact with inmates, since no barriers separate staff from inmates. The word "supervision" is used because the staff officer can actually manage, supervise, and control inmate activities and behavior when in direct contact, rather than just watch and react as is the case when staff are separated from the inmates by a physical barrier.

Remote surveillance. The remote surveillance method results in a series of pod-like units that ring a central control station constantly occupied by jail staff. The staff member is outside the housing units rather than inside, thus inspiring the *term* "remote." In this **arrangement**, staff are always able to look directly into the housing units or activity areas and can maintain a constant level of surveillance. However, the relationship between the inmates and the control station staff is only minimally interactive. The interaction may be limited to verbal communication through a pass-through or wire mesh, or a crude system of hand signals and window tapping. The role of the staff person at this fixed post is essentially that of observer. Direct interaction with inmates is accomplished through use of a roving officer who moves in and out of the housing area "as needed" or on an unscheduled basis.

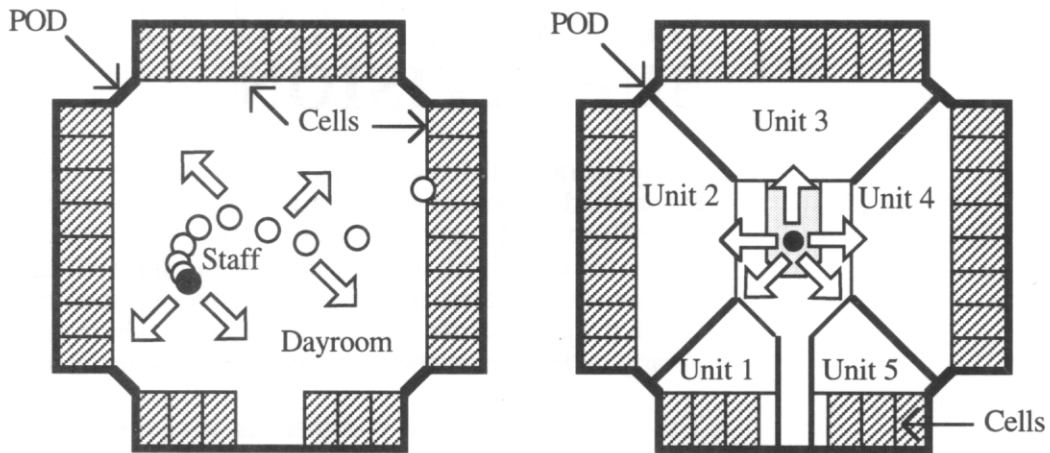

PERIODIC STAFF PRESENCE REQUIRED

Intermittent surveillance. With this method, staff are actually posted in a different area of the jail than the inmates and, therefore, have only intermittent, periodic contact with the inmates -- usually for minutes or even seconds. Although staff frequently and regularly patrol inmate-occupied areas (typically once per hour or per half hour), inmates are largely responsible for their own behavior. In some cases, electronic surveillance is used to compensate for the lack of constant staff presence around the inmates. This method of surveillance is rarely used in new jails today and is recommended only for selected populations such as inmate worker and work-release inmates. The key design impact of this concept is that housing unit or support space location is not directly dependent on staff placement since staff play a minimal role in these areas.

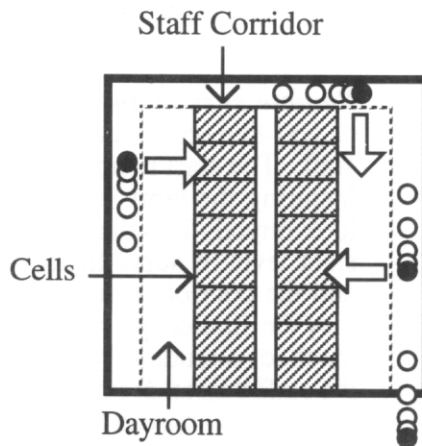

Electronic monitoring. Consisting of closed-circuit television (CCTV) or audio surveillance (listening devices) or both, this method of supervision

generally does not involve any frequent or routine staff presence in the cell-blocks, but is merely a monitoring capability from a remote location. This method also has no direct bearing on the arrangement of space in relationship to staff positions. Indeed, in extreme cases found in some older small jails, the monitoring center is not even in the same building. The limitations of such a system are well documented and include a less than desirable view of the area to be monitored, frequent vandalism, tampering, destruction of the monitoring devices in the inmate-occupied area, and poor-quality reception on monitors due to environmental conditions.

DESIGN CONSIDER- ATIONS

The remainder of this section provides design information about the four surveillancesupervision methods. The focus is on those things that have a significant impact on overall design arrangement as well as some of the details that affect the successful implementation of those concepts.

SELECTING INMATE MANAGEMENT1 SUPERVISION MODES

The place to begin in managing the design elements resulting from surveillance/supervision modes is to match the various classifications of inmates to preferred surveillance/supervision approaches. It is not required that one mode of surveillancesupervision be selected for all types of inmates. In fact, a commitment to one approach could be quite harmful to the operation of a facility. Rather, it is possible, if not desirable, to use a variety of methods according to the level of control desired for each classification.

It is clear, for example, that even though direct supervision may be the most desirable form of managing general population inmates, it is probably not appropriate as the sole means of supervision for such groups as disciplinary detention inmates or inmates whose behavior poses serious dangers to staff and other inmates. Additionally, the commitment of full-time staff to constant supervision of inmate workers or work releasees may seem unnecessary and is probably not practical given the low security nature of those classifications. Intermittent surveillance may work adequately for work releasees and inmate workers, but have serious limitations for high security risks and administrative segregation inmates.

STAFFING VS. FACILITY DURABILITY

In considering the selection of a surveillancesupervision approach in terms of architectural impact, one fundamental thought about the inter-relationship of staff, surveillance, and architecture should be kept in mind. This concept is simply that staff and the surveillance/supervision mode tend to be more critical to security than architecture.

None of the so-called state-of-the-art security hardware and materials will resist unrestrained attack, even though security hardware and construction are meant to take abuse and contain an inmate population. However, they cannot provide total security by themselves. The key to security is a balance among elements of proactive supervision (where staff and management provide fundamental security and safety), technology, and architecture.

REMOTE SURVEILLANCE DESIGN

The following issues relate to the use of remote surveillance design in housing and non-housing areas.

Number of staff posts. A key consideration in the clustering of cells in a remote surveillance setting is to identify the number of staff posts that is required to achieve the proper balance between security and economy. A careful analysis must be undertaken to evaluate the type and number of inmates to be monitored from a single post. This will have a great deal to do with the overall arrangement of the facility and with the degree of separation and classification that can be attained.

Unwanted views between inmates. The greatest challenge in developing the remote surveillance concept in housing is to provide officers with a full view of all areas they are expected to observe from a fixed post while avoiding view conflicts between individual housing units associated with that post. The primary way to do this is to avoid mixing into one housing area groups that should be dispersed among different staff stations.

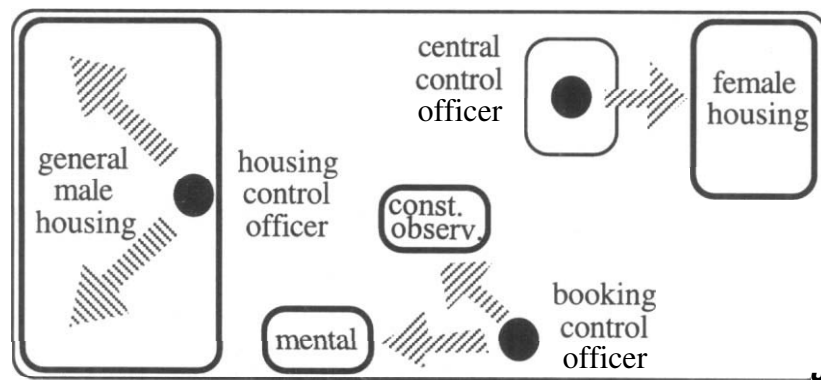

Frequently the attainment of minimum staffing requires that different groups be around the same control position. In the smallest of jails, the desire may be to do this around one fixed post. Several techniques can be used to try to achieve this without creating sight and sound conflicts.

- Subdivide the corridor within the area to create visually and acoustically separate subparts.

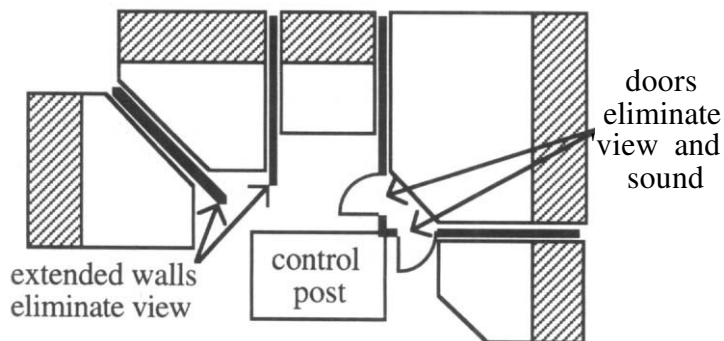

- Manipulate the location of **dayroom** side and front walls to preclude side-to-side view between units.
- Consider placing housing units one over the other to preclude side-to-side view.
- Consider using mirrored surfaces on the glazing of control center pods to preclude view through the pod and into another area (this has limitations, as discussed in "Classification/Separation").

Staff view of housing. Not only do the dayrooms of housing units need to be visible, but cell interiors should be visible to some degree. Since most new jails tend not to use bars for fire safety and sound containment reasons, view into the cells is typically provided through the creation of vision panels in doors and/or the use of side-lights. Visibility of all cell doors is a minimum view requirement.

The concern in cell design is to strike a proper balance between visibility and privacy. The degree to which cell exposure is required depends on three considerations:

- security level of the inmate population, i.e., low or high custody, disciplinary detention, etc.;
- operation of the individual units. For example, if inmates are locked out of their cells during the day and in them at night, remote visibility of the cell is less critical since staff can view everyone in the dayroom during the day and securely enter the housing unit **intermittently** at night to observe cells; and
- **staff/inmate** communications. Of critical importance to the officer at a remote surveillance post is the need to maintain ongoing verbal communication with inmates to ensure compliance with rules and regulations and acceptable behavior in the dayrooms, to give verbal commands and instructions to inmates, and to respond to inmate requests. If the officer is to maintain control, adequate means to easily and clearly communicate with inmates must be incorporated in the housing control station.

Closed or open staff post. The issues of an enclosed staff space versus an open staff space include:

- A total physical **barrier** between officer's station and the inmates in the housing area **corridor** versus a limited barrier (normally at least a high counter).
- Lesser versus better ability to hear, smell, and see what is happening.

- Almost total reliance on electronic means of communication versus an ability to communicate directly with inmates in a dayroom or cell at all times.
- A limited ability to provide services to the housing units versus total freedom to move around the pod to provide services and more quickly respond to inmate needs.

If the open-counter approach is used at the control post, the post may be operated somewhat like a direct-supervision unit. That is, the officer at the remote surveillance post has to have limits on what is controlled at that position in order to reduce his/her risk. A way to limit that risk would be to:

- Maintain control of the accesses to and exits from the overall housing area at Master Control.

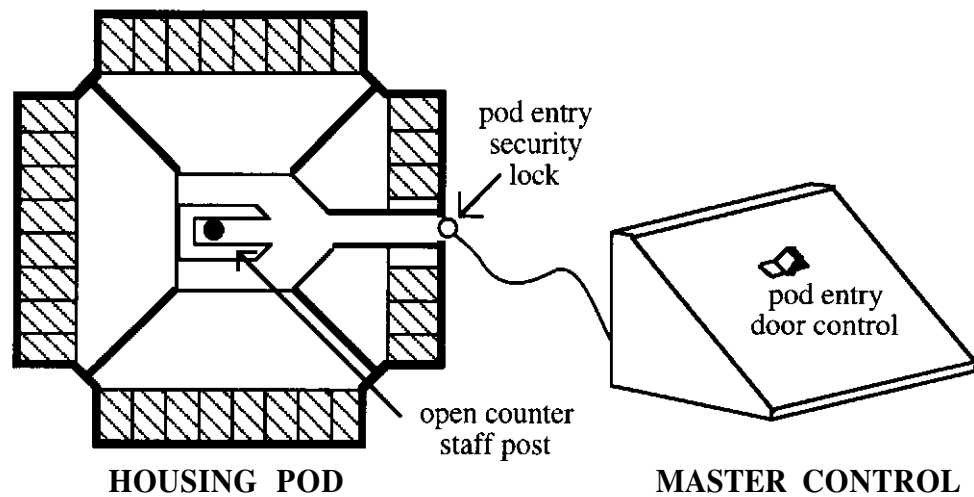

- Have backup controls at Master Control to assume control of the area in the event of an emergency.
- Provide means (such as two-way radios) by which the housing officer can stay in constant communication with Master Control as he/she moves around in the housing area.

Surveillance of movement. The remote surveillance approach to monitoring movement requires placing fixed staff posts in a position to look down key corridors. Preferably, designs will feature the ability not only to monitor corridors but to maintain direct visual contact with other control positions within the jail. The potential also exists here to supplement staff monitoring of inmate movement with electronic surveillance, especially for minimum-security inmates.

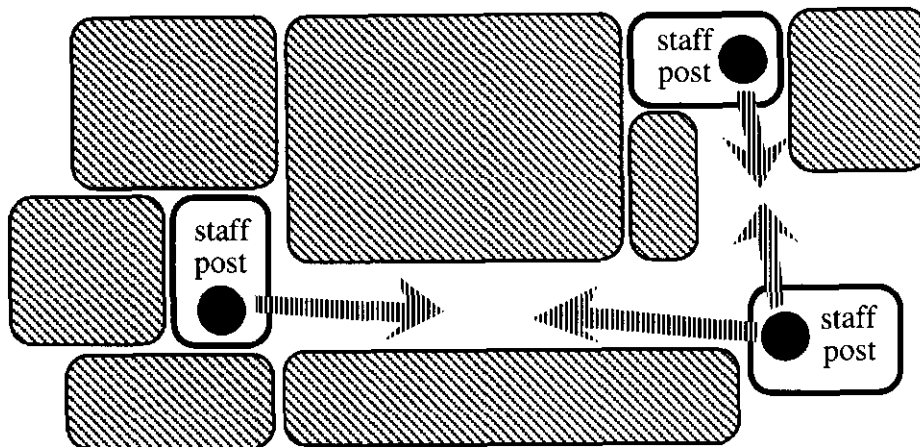

Monitoring support areas. To achieve the constant surveillance of support services and activities that is lacking in most jails, staff positions can be affiliated with support and program areas much as they are with housing units.

Program area control posts do not necessarily need to be enclosed since they tend to serve a very limited function. However, enclosure would be required if the posts had controls that might facilitate release from the security perimeter.

Since many small jails do not have sufficient staff to create separate observation posts to monitor program and support areas, an important concept is to arrange key program and service areas, such as exercise and visiting, in direct view of a housing unit officer. In essence, these functions then become part of the overall design plan for the housing unit. Careful planning must be done to eliminate potential "blind spots." In addition, the opportunities for officer diversion(s) must be taken into account, especially when the officer is expected to control or monitor more than one activity.

Sound control. As noted in the survey, the control of sound -- for both inmates and staff -- is an important challenge for the remote surveillance setting because of the close proximity of housing areas. The principal way in which sound might be controlled is through use of solid partitions consisting of concrete masonry and security glass within each unit. However, such sound containment has the related problem of cutting the officer off from things that he/she needs to hear and from communicating with the inmates in the various housing units. The answer to this dilemma is to consider various means by which the officer can communicate:

- intercoms between cells and the control position, and between the dayroom and the control position.
- telephones between the dayroom and the control position.

- security openings in the dayroom walls through which the officer and inmate can communicate. (Be sure to check the fire codes with respect to such openings and fire separation requirements.)

Lighting. In providing a good view to remote surveillance officers, it is important to consider the level of lighting. This is particularly true when using an enclosed staff post. In this case, the officer is potentially looking through three glass panels and three spaces to view the inside of a cell. To minimize the amount of reflection from the glass, reduce eye strain, and increase view quality, it is important to reduce the amount of artificial or natural light shining toward the officer and to provide higher levels of lighting in inmate areas than in the staff area. Officer control of lighting levels is also recommended so that the officer can adapt his/her space to changing natural and artificial lighting conditions.

Furniture and equipment. With the constant presence offered by remote surveillance, designers have felt that -- in selected housing units -- less costly, non-fixed institutional furnishings can be used in place of fixed detention furnishings and that locks and hardware of a lower security nature can be used. Additionally, a lesser need for electronic surveillance, particularly CCTV, has been perceived in remote surveillance housing settings. However, the security envelope of the building cannot be compromised and must be maintained with high-security construction.

INTERMITTENT SURVEILLANCE DESIGN

Intermittent surveillance is not recommended as the primary method of inmate housing area control for the following reasons:

- Inmates rather than staff are essentially in control of the inmate housing areas.
- Inmate control usually results in coercion, intimidation, violence, and damage to facilities.
- Access to activities and services tends to be more limited because of the greater need for escorted movement.
- The flow of information between inmates and staff is inhibited.
- There are more minor and major inconveniences for jail staff, including providing inmates access to the telephone, escorting them from one place to another, and being required to directly supervise their work activities throughout the jail.
- Discipline is difficult to achieve since rule violators cannot be easily identified.

However, the following information is presented for those selected classifications and non-housing areas of the facility that might be suitably monitored by intermittent surveillance.

Movement. One of the key concepts that shape the organization of spaces in an intermittently monitored area is the efficiency of officer movement in making rounds. While the design benefit of the intermittent surveillance concept (particularly as it refers to housing units) is that there is much more latitude in the placement of spaces, totally random and loosely developed concepts of arrangement can make for very awkward and difficult movement patterns for the officers. Consequently, a key design consideration is how the spaces to be monitored can be arranged to allow efficient movement of the officers who must view different areas.

A critical aspect of movement patterns in intermittent designed facilities relates to the tradition of arranging housing areas in a series of back-to-back cellblocks. These cellblocks are not monitored from a primary corridor, but by leaving the primary corridor and entering a perimeter guard corridor around the housing units.

Monitoring cellblocks in this fashion is difficult because of the additional movement required and because the arrangement virtually precludes random, unannounced surveillance. This is because staff entrance into the cellblock area is difficult to mask, since it is either quite noisy or easily visible to inmates. Remote view into the cellblock areas is typically limited because the traditional back-to-back design allows nothing but a look across the cell fronts from the main corridors of the facility.



Limited remote view with linear intermittent design.

The traditional back-to-back cellblocks with perimeter officer corridor sometimes feature more than two separate housing units in the area to achieve construction economy. In this case, to get proper degrees of separation, one might be creating a difficult movement pattern for the officer as he/she moves through a series of doors in the officer corridor to see each separate unit. The likelihood of random surveillance is further diminished and any view of the rear units from the central corridor is precluded by such designs.

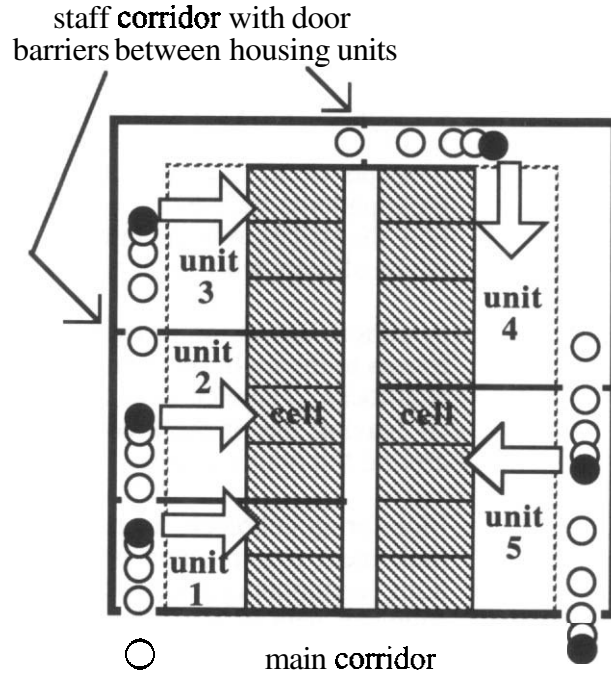

Furniture and equipment. Since the housing areas monitored by intermittent surveillance leave inmates unsupervised for the majority of time, the need for vandal-resistant furnishings, fixtures, finishes, and hardware becomes critical.

Staff impact on design. Experience in numerous jurisdictions has shown that two staff members **are** required for intermittently monitored housing units since one officer must be available to back up the officer who enters the cellblock. Since no **fixed** control post monitors the area, both officers **are** roving staff -- one officer controls the cellblock from outside while the other is within the cellblock.

View conflict. While intermittent surveillance allows the relatively random dispersal of housing units and program spaces, designing for efficient movement creates the prospect of view conflicts. For example, a view conflict may exist because two housing units **are** placed across from each other

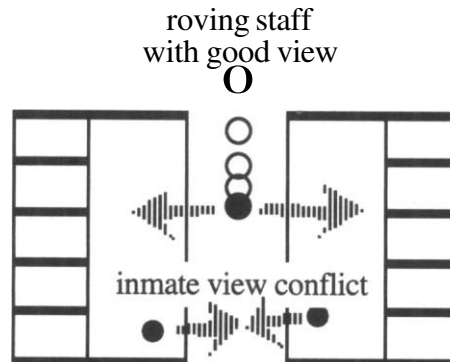

off a main corridor to facilitate staff movement and observation. The conflict may become acute if the entire faces of the dayrooms are glazed to allow the intermittently roving staff good view across the entirety of the dayroom and a direct line of sight into each cell.

Such view conflicts are no more desirable with intermittent than they are with remote surveillance settings. Indeed, they **are** less desirable because staff are not constantly available to control the consequence of two different groups being able to see, communicate with, and gesture to each other.

A way to resolve such a conflict is to associate groups that could see and communicate with each other without creating a problem. However, since the needs for separation may limit the potential for this, special design techniques might be used to limit exposure.

- Use solid-face dayroom fronts with shuttered vision panels at key points along the corridor.
- Create entry pockets that allow the officer a good view of all parts of the dayroom from the pocket.

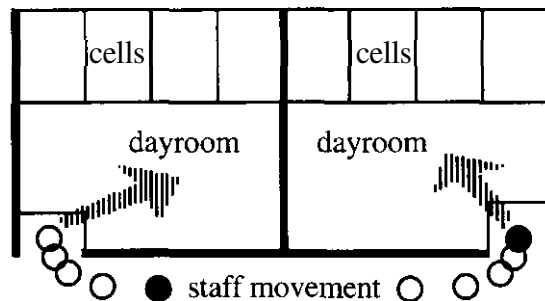

Backup surveillance. Because backup electronic monitoring is essential to retain some surveillance over intermittently observed housing or program areas, it is advisable to install CCTV units and/or audio monitoring systems in those areas. However, to make backup electronic surveillance effective, a staff position dedicated to the task of monitoring (and not distracted by a multitude of other duties) must be created. While a small jail typically assigns the monitoring role to Master Control, it must be recognized that Master Control functions -- especially if law enforcement dispatch functions are included -- can require the majority if not all of the officer's attention in even the smallest jail. (For more information on the functions of Master Control, see Chapter 4.)

DIRECT-SUPERVISION DESIGN

The direct-supervision approach to inmate management has gained wide acceptance across the country as the preferred inmate management style in mid-size to large jail facilities. Incidents of inmate violence, vandalism, and disruptive behavior reportedly occur at very minimal levels in direct-supervision facilities. However, due to the limited size of their inmate populations, many small jails may conclude that it simply is not staff-efficient to post an officer in the housing units. Jail standards in many states require

separation of inmates according to a range of variables or criteria that place restrictions on the types of individuals who may share a common housing unit. These conditions often preclude the creation of larger scale housing units (usually in the 48- to 64-bed range) needed to achieve efficient staffing. In recognition of this possibility, the following design considerations are offered with respect to the direct-supervision concept.

Security. Security begins with classification and the assurance that a person in a direct-supervision module is not fundamentally a danger to staff and other inmates and is rationally capable of responding to supervision and directions. Beyond that, a key supporting concept places the officer at minimal risk by virtue of the design itself. For example, it is critical that the direct-supervision officer has no control of exiting from the unit. This greatly diminishes the benefit of inmates assaulting the unit officer and attempting to take control of the unit. Master Control should control **all** exits from the unit.

It is essential that the direct-supervision officer be able to communicate directly with Master Control from any point in the housing unit. This would suggest the use of telephones at the control position within the housing unit and mobile communication and alarm devices on the officer's person.

Movement. Although movement within the housing unit is not an issue, moving out of the unit to programs and services is. By the very nature of the direct-supervision concept, the housing unit officer is confined to the housing unit and cannot perform duties outside of the unit. Consequently, a key idea behind direct supervision is to focus as many activities and programs within, or adjacent to, the housing unit as possible with minimal staffing. This can be done with all essential daily functions, such as dining, exercise, sick call, counseling, and visiting. Otherwise all movement outside of the housing unit must be monitored by other staff unless **all** inmates in the unit are moving out of the unit.

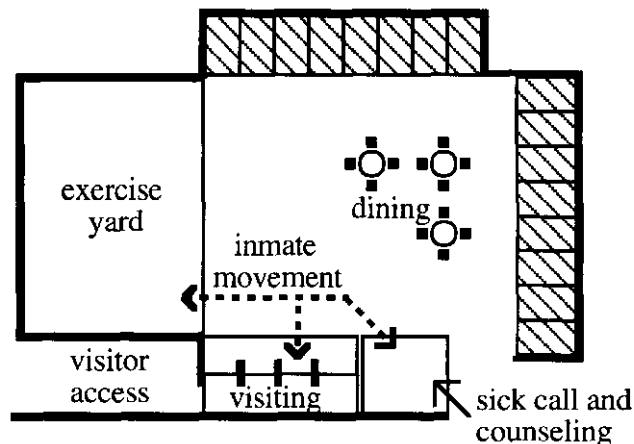

Furniture and equipment. One of the benefits of the direct-supervision concept is that the security features and construction of the facility can be lessened and normalized because of greater staff control. This reduces initial construction costs. The following selections have been made in some direct-supervision housing units:

- non-fixed, non-security dayroom furnishings;
- non-fixed, non-security stools and desks in cells;
- low-security locks and hardware on cell doors;
- solid wood core or lighter gauge hollow metal doors on cells (gauge mainly decided by durability considerations);
- carpeted floor surfaces;
- more lightly constructed and reinforced partitions; and
- non-security vitreous china toilet and sink fixtures.

The use of more normalized materials, equipment, and hardware is consistent with, and reinforces, the direct-supervision concept, which in large part is based upon an assumption of rational behavior by inmates classified for general population. More normative furnishings can be graduated from level to level to provide incentives for positive inmate behavior. Even with more normalized materials, hardware, and equipment used within the housing unit, however, it is critical that the *exterior perimeter* of the housing unit be as secure as any other portion of the jail facility.

Non-housing areas. Direct-supervision monitoring of programs and services is not uncommon in jails. Control booths or observation counters are not needed outside of program and services areas. However, the officer in these situations should be backed up by direct surveillance from a control post or by electronic supplements such as panic buttons in the walls, voice-activated intercoms in walls or ceilings, personal radio alarm systems, and, perhaps, CCTV monitoring of program areas. Care must be taken that direct supervision is not relied on in areas that require privacy (e.g., attorney/client visiting, private counseling).

View. Although the officer is positioned within the housing unit or program area, it is still wise to provide a good view of the entire area being supervised. "Blind comers" and out-of-the-way pockets of space are problematic to direct-supervision officers and are a threat to inmate safety.

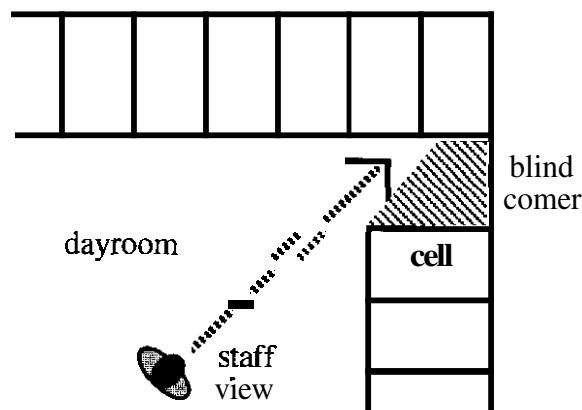

ELECTRONIC SURVEILLANCE DESIGN

Reliance on electronic surveillance (CCTV or audio monitoring) as the primary method of inmate supervision is not recommended for housing areas for the following reasons:

- Contemporary standards encourage constant and active forms of surveillance and discourage non-constant or passive forms, such as intermittent and electronic surveillance, at least for the housing areas of the facility. Conventional wisdom also dictates that audio or electronic surveillance methods should not serve as a substitute, but only as a supplement or enhancement for staff supervision.
- Inability to monitor areas constantly and effectively due to fatigue, preoccupation with other activities, or too many cameras and monitors to manage.
- Almost total lack of supervision over inmates for significant portions of time.
- Initial purchase costs and repair costs related to monitoring equipment.
- Dangerous conditions created by malfunctioning or inoperable equipment.
- Lack of staff to respond to problems in cases where insufficient staffing originally resulted in reliance on the electronic surveillance.
- Vulnerability when inmates determine what is not monitored.

However, electronic surveillance does have a role in a jail. Considering where and how electronic surveillance might supplement the basic approaches used to control the inmate population can have an influence on the general approach to design. In general, electronic surveillance is appropriate as follows.

Closed-circuit television seems suitable for:

- monitoring building perimeters;
- monitoring corridor movement when that movement cannot be monitored from the fixed post **and/or** where non-escorted movement is desired;
- monitoring remote areas or areas not typically occupied by inmates, for example, exits and other access points to the secure perimeter, the vehicle sally port, fire egress, stairways, and mechanical spaces;
- monitoring **ingress/egress** points to ascertain the identity and status of persons at those points; and

- providing backup support for selected areas: kitchens, laundry, outdoor exercise areas, multi-purpose rooms, general housing unit areas.

Use of color monitors provides much better resolution than black and white and enhances security.

Audio surveillance and communication seems best suited to the following applications, all of which should allow inmate communication with staff.

- two-way audio to cells, including special cells;
- two-way audio to dayrooms/dayroom entries;
- two-way audio to program and support areas; and
- two-way audio at ingress/egress points at internal perimeters,

Generally, an over-reliance on the use of CCTV tends to result from a deficiency in design. It is recommended that housing areas and support areas be monitored by staff as opposed to CCTV or audio monitoring. Electronic surveillance techniques should never be viewed as suitable to replace staff.

NON-HOUSING SURVEILLANCE

Another important aspect of surveillance/supervision methods is their impact on the supervision/monitoring of the *non-housing* areas of the facility and on inmate, public, and staff *movement*. This may be equally significant to the design of facilities and may influence the efficiency, safety, and security of the building as much as housing unit surveillance. Key areas of inmate supervision in non-housing areas that need to be addressed are:

- inmate movement to and from housing areas,
- inmate visitation areas,
- inmate exercise areas,
- inmate program or multi-purpose areas,
- medical services area,
- public lobby and visitor waiting,
- loading docks/trash dumpsters,
- reception areas, and
- public seating areas in attached courtrooms or video arraignment rooms.

STAFFING IMPACT

Without adequate numbers of trained staff, properly assigned and supervised, the jail will not be able to respond to day-to-day operational requirements or to emergency situations. Unfortunately, a poor understanding and appreciation of staffing requirements and determinants combined with scarce monetary resources has frequently resulted in the understaffing of many new jails.

Planners and local officials must recognize one particular finding of national studies: over the 30-year life cycle of a correctional facility, construction costs for the average, standards-compliant new jail will amount to only about 10% of the total combined cost of operations and construction. This means that for every \$1 million invested in capital construction, communities will spend another \$9 million for operations over 30 years. Of this \$9 million, an average of \$6.3 million will be spent on staffing. The impact of staffing on design, and vice versa, is clearly one of the most important issues to consider in developing any new jail.

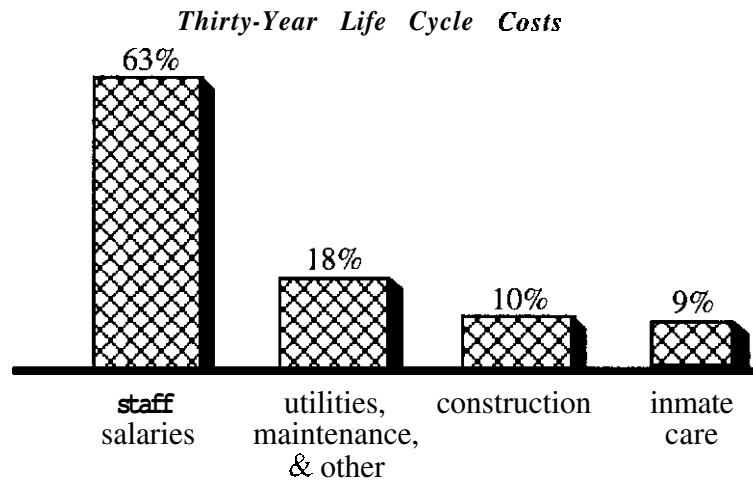

The impact of staffing can be more acute for small and medium-sized jails than for larger ones, since the high ratio of inmates-to-staff found in large jails cannot be realized easily, if at all, in small and medium-sized jails. When one considers the challenge of separating different classifications (especially by gender) and the variety of possible surveillance approaches (some of which require the constant commitment of staff), the impact of design on staff efficiency and costs becomes readily apparent.

In reviewing this section, the reader should note that there is a close link between staffing and the issues of surveillance/supervision and classification/separation. Readers should refer to the sections on "Classification/ Separation" and "Surveillance/Supervision."

LEGAL ISSUES

Federal courts have made it clear that those who fund and operate jails have a duty to protect inmates from violence and to provide for their safe and secure detention. In essence, key court decisions indicate that staff must:

- protect inmates, from themselves and from other inmates;
- regularly visit inmate-occupied areas and maintain communication with inmates (the timing of these visits may vary with the type of inmate in specific housing areas and agency policy);
- respond to inmate calls for assistance;
- classify and separate inmates for their own protection;
- ensure the safety of inmates;
- maintain security systems and implement procedures;
- process and supervise female inmates;
- monitor electronic surveillance;
- ensure that all required inmate activities, services, and programs are delivered (medical, exercise, visits, etc.); and
- initiate contingency plans in emergency situations.

Court decisions and **contemporary** standards have also defined important parameters for jail operations that affect staffing through establishing:

- minimum levels of service, such as requirements for visitation, exercise, etc.;
- performance objectives;
- prohibited practices; and
- specific required operational actions, including such functions as inmate counts, security rounds, cell searches, etc.

Perhaps most important of all, courts have repeatedly ruled that a lack of resources is insufficient reason for failure to meet constitutional minima. Judging from past rulings, then, arguments that proper staffing cannot be provided at the small and medium-sized jail because of expense will receive little support from the courts.

24-HOUR COVERAGE

Staff costs in a properly operated jail are high because jails are so unlike other county operations. For example, although a county's administrative offices might only be open from 8:30 a.m. to 4:30 p.m., Monday through Friday, jails never close. They require 24-hour-a-day, 7-day-a-week coverage and, in many states, "same sex" staffing (that is, female staff for female inmates and male staff for male inmates).

A 24-hour post, such as Central Control, requires approximately 5 persons to operate 365 days a year. Ordinarily, three 8-hour shifts are staffed at jails and prisons. Staff on each shift are typically available to work approximately 219 days a year; the remaining 146 days are "relief" days for regular days off, vacation, sick leave, training, etc. Following is a graphic representation of how one 24-hour post requires 5 persons for adequate coverage. The example "relief factor" of 1.67 is calculated by dividing the number of days the post must be covered (365) by the number of days an

individual staff person is available to operate the post (219). Example: 365 days per year ÷ 219 days available = 1.67 relief factor. Each jurisdiction must calculate its own relief factor when determining its particular staffing needs.

Position or Post	Day	Even.	Night	Total Positions	Relief Factor	Total Staff
Central Control	1	1	1	3	1.67	5.0

The 5.0 staff required for one 24-hour post is arrived at by multiplying the total positions by the relief factor (3 x 1.67 = 5.0).

All personnel required for other functions, including those that are not 24-hour posts, should be calculated. These calculations should be realistic, given the design, and based on the tasks that need to be done by staff.

POSSIBLE STAFF TYPES

The kinds of jail staff for whom space might be needed include:

- administrator and assistants,
- central control,
- booking,
- housing control,
- movement or support security,
- court transport,
- **clerical/records,**
- program (in-house **and/or** outside service providers)
 - work release
 - counseling
 - ministerial
 - medical
 - education
 - library
 - mental health,
- food service,
- laundry,
- maintenance.

Jurisdictions will need to conduct a thorough analysis of their staffing requirements to determine which posts or staff types are needed on a continuous basis versus those that might be needed on selected shifts.

DESIGN FACTORS

The following information addresses the primary issues with which planners should be concerned when developing staff-efficient and secure jail designs.

FACILITY LOCATION

The impact of the facility location on staffing results primarily from the need to transport inmates between jail and court. A significant amount of staff time can be consumed by this task, possibly to the point of requiring more personnel.

Those contemplating building a new jail at a location remote from court facilities should consider the staffing impact and whether alternatives to in-court appearances -- such as *video first appearance* or a *first appearance court at the jail* -- would be feasible. Designers must also consider the impact of frequent movement to court facilities:

- separating the flow of inmates, public, and court personnel;
- searches before and after court appearances;
- temporary court holding;
- holding at the remote court facilities; and
- potential meal service, attorney visits, and emergency medical services.

Another staff-consuming activity is providing transportation to, and security at, *medical facilities* in the community.

SINGLE-LEVEL VS. MULTI-LEVEL DESIGN

A multi-level design with just 10 to 15 beds on each floor can drive staffing costs to **unaffordable** levels. For example, if each floor requires a minimum of one 24-hour post, a 3-floor jail with a capacity of 45 beds could well require a minimum of 15 housing area security staff (3 floors x 3 posts x 1.67 relief factor = 15 staff) just to meet minimum standards in some states and to ensure safety and security. This does not include administrative staff, support staff, or any other security staff.

In addition, movement of people and services (food service and laundry, for example) can become more time consuming and complicated in a multi-level facility, particularly a small one with fewer staff. Required stairways and elevators present the jail staff with additional surveillance problems and security risks. Multiple levels also add to fire safety complications in terms of design and exiting. Also, the potential exists for increased maintenance problems and costs (elevator service, more potential for equipment failure, and more problems in managing operations when essential equipment fails).

Multiple levels also eliminate the ability to create direct sight lines between staff posts and preclude any direct interrelationship between them unless an attempt is made at some sort of *vertical connection* such as a stairway.

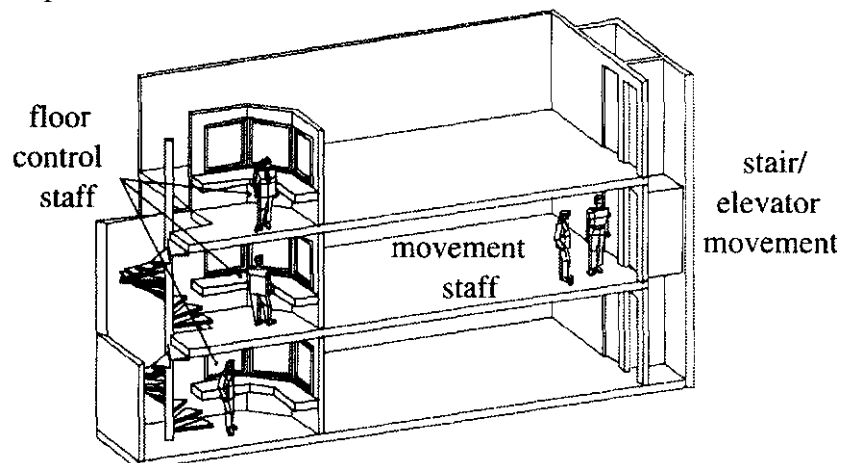

VERTICALLY CONNECTED POSTS

Any attempt to connect fixed posts on two or more levels must be carefully evaluated since there **are** potentially serious limitations of this approach.

- **Loss of control.** With vertically connected control positions, the loss of one position in an assault can cause the loss of the **other(s)** unless special precautions are taken. These precautions (lockable hatches or doors) can complicate design and limit the actual connection between levels.
- **Insufficient staffing.** Placement of a secure control post on each floor visually linked to adjacent housing units represents a remote surveillance form of design. Yet if cost-saving measures result in only one officer moving vertically from one floor's observation post to another to control both floors, the design compromises the benefits that make the remote surveillance approach superior to intermittent surveillance (*i.e.*, continuous observation of the inmate population and immediate intervention during conflicts and altercations).

Additionally, staffing control posts on multiple floors with one person becomes problematic when staff are needed simultaneously on two levels to unlock doors, back up roving officers, etc.

INMATE SEPARATION

The extent to which inmates are separated in the facility and the manner in which separation is achieved can translate into staffing requirements. The need to separate inmates is addressed in all standards and was discussed in an earlier section of this document. Often, the greater the **number** of distinct housing units a facility has, the more staff it needs to supervise the units.

The **types** of inmates to be housed in the facility can also dictate the types and number of staff needed. A facility that houses both male and female inmates, for instance, should have both a male and a female jail officer on duty at all times and space for both (posts, lockers, showers, etc.).

If the jail has a long-term population, more programs and services -- such as exercise, visitation, work release, counseling, and mental health services -- and additional staff to administer them must be provided. A facility that primarily detains violent felons and career criminals requires more intensive staffing than one that houses nonviolent misdemeanants such as **drunk** driving and minor property offenders.

Decisions on inmate separation, housing types, and staffing levels should be based on the collection and analysis of data very early in the functional programming phase of the project.

SURVEILLANCE1 SUPERVISION METHODS

The method of surveillance or supervision selected for housing and non-housing functions has a direct bearing on staffing needs. Remote surveillance and direct supervision methods, for example, require constant staffing and clear sight lines from established staff positions, as discussed in the preceding section. The implications of limiting the movement of staff in a remote surveillance setting (and thus the tasks that can be performed) versus the freedom of movement and flexibility staff have in a direct-supervision setting must be carefully evaluated. The added ramification of monitoring needed separation according to classification is significant. See the preceding discussions for more on these subjects.

CIRCULATION AND MOVEMENT

Jail operations require constant movement within the security perimeter by staff and inmates. Inmates move to and from activities and services, and staff are constantly moving to provide basic supervision and security. Additionally, the public enters the facility for a variety of purposes, including visiting and providing programs and services.

Controlling movement within the jail is an essential and staff-intensive ingredient of security. The design of the facility, therefore, can either enhance or inhibit effective movement control and will influence the need for staff. For example, complicated staff circulation **patterns** for surveillance rounds can diminish staff efficiency and reduce the chances that rounds will be executed as frequently and effectively as necessary. Several key design considerations regarding movement and circulation follow.

Simplicity. Keep circulation corridor patterns simple and to the minimum number of levels possible. This makes movement more direct as well as easier to observe and supervise.

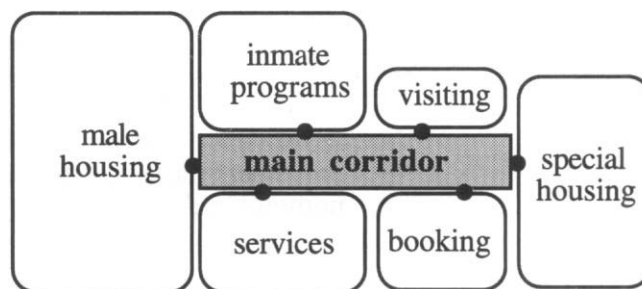

Corridor width. Provide ample width in corridors to accommodate the movement of food and laundry carts, officers escorting inmates through the facility, and people passing each other in the corridor. Also, consider providing sufficient width to allow doors to swing into the corridor without blocking egress or flow as a way to avoid unobservable door pockets wherever possible. It is recommended that primary corridors be at least *eight feet* wide.

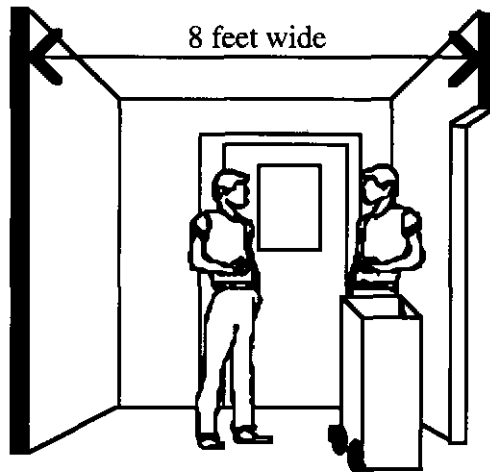

Functional relationships. Arrange functional components according to their use and their users. For example, since inmates eat three times a day, a convenient location for food services that permits efficient delivery of food to the pods and the return of trays and refuse to the kitchen becomes **important** to staff. On the other hand, since the commissary is probably used once or twice a week, its location is less critical.

Housing area linkage. Identify services and programs that occur frequently, such as exercise or visiting, and locate them adjacent to housing units. This allows already established staff posts to monitor movement to the activity and the activity itself. This strategy is particularly applicable to remote surveillance and direct supervision housing areas.

Unescorted movement. Identify the need for surveillance at various inmate areas and plan for unescorted movement wherever possible. Identify whether any of these design possibilities exist:

- movement directly monitored from constantly staffed posts;
- movement monitored by electronic means -- CCTV and audio;
- unmonitored movement, by issuing passes with specific timeframes for lower security inmates moving within the security perimeter.

Public movement. Minimize the need for public/visitor movement within the facility, especially within the security perimeter, if possible. **Public/visitor** movement presents special security problems that can only be solved by staff presence. Create locations at which visitors can conduct business via a controlled access in the security perimeter (e.g., security passage or secure visiting area separate from the inmate-occupied areas).

SHARED ACTIVITIES

Monitoring inmate activities outside of the housing unit can be quite time consuming. It is, therefore, advantageous to identify which groups might participate safely together in various activities and programs -- such as visiting, exercise, and group counseling -- and to design space accordingly. For example, staff time would be saved if space was designed to accommodate larger groups of exercisers versus smaller groups. That is, if

The National Fire Protection Association (NFPA) *Life Safety Code* 101 and local codes should be referred to for more information on safety precautions and evacuation. The state fire authority and local fire chief or fire marshal should be contacted for guidance on this issue.

STAFF BACKUP

Typically one staff member will be able to observe most inmate housing areas from a remote, fixed post. However, that staff member's ability to physically respond, unassisted, to incidents such as assaults or escape attempts may be severely limited by a need to retain control of the secure post and by concerns for his/her own personal safety. Although that officer cannot respond directly to a problem, he/she is able to provide direct *visual* backup assistance to officers who do enter the housing units or other inmate-occupied areas.

Obviously, the control post officer's inability to provide direct assistance eliminates the possibility of direct *intervention*. However, he/she does play an important inmate observation and support function for staff by:

- providing a psychological deterrent to further misbehavior by his/her presence;
- monitoring and witnessing illegal behavior and, therefore, guaranteeing successful prosecution of offenders; and
- serving as a communication link to obtain assistance from other personnel outside the immediate area of the jail, including non-jail sheriffs staff, municipal police, and fire department and ambulance personnel.

From a practical standpoint, it can be assumed that numerous small jails may be staffed with two-person, male/female teams on each shift, with one officer in a secure Master Control station and the other in a roving capacity. Given the need to maintain the security of a Master Control room, the officer can ill afford to leave it to render assistance. Therefore, his/her chief tool in providing backup assistance is an unobstructed view of all inmate-occupied areas and communication linkages through which to interact verbally with inmates and/or to summon outside assistance.

Through this team approach, which combines direct interaction of the roving officer with the backup of a Master Control officer, the well-designed jail can respond to most occurrences without creating excessive risk to staff or inmates.

NATURE OF STAFF POSTS

When a facility features a staff post for housing control (other than Master Control), a major design and operational question is whether to fully enclose and secure the post or to leave it an open counter-like area, as discussed in the preceding section on "Surveillance/Supervision".

The open-counter area is much more versatile from a staff point of view, allowing the officer to move freely from the post to perform duties and services other than those demanded within the post itself. Such versatility

potentially distributes work better, improves supervision by allowing better and more frequent contact, facilitates two-way communication between staff and inmates, and minimizes the need for staff. Without careful planning and design, however, the open design can lead to security compromises.

In determining the nature of a staff post, consider the following:

- whether tasks can be performed more efficiently from a post that restricts staff movement or one that enhances staff movement and flexibility;
- backup security that reduces the risk of an open-counter arrangement;
- what is at stake if the post is lost;
- impact on inmate surveillance if opened or closed;
- level of inmate contact and communication attained;
- ability to communicate with other staff in the area; and
- potential staff savings.

The open-counter housing post is not viable unless the jail maintains a secure Master Control room with complete override capability on all security systems and full control of the perimeter of the housing area.

CELL OCCUPANCY

While there is no irrefutable evidence that single-cell jails are less costly to staff than facilities with multiple-occupancy housing, there are strong arguments that **single-cell** housing results in more efficient use of staff. These arguments generally include the following.

- Multiple-occupancy housing greatly reduces the staffs ability to prevent physical or sexual assaults, especially during night lock-down when staffing levels tend to be reduced. Multiple-occupancy housing may eliminate the ability to reduce night-time staffing.
- During a disturbance in multiple-occupancy housing, the staffs ability to take full control of the incident is reduced due to the inability to **fully** separate combative inmates.
- Multiple occupancy diminishes staffs ability to maintain discipline and control since vandalism is difficult to attribute to individual inmates.

ELECTRONIC MONITORING VS. STAFF

Audio monitoring and CCTV have their place in the jail security system, but such equipment is effective only when staff are provided to monitor the systems and summon assistance. Often, surveillance equipment is installed but staffing is not appropriately allocated to monitor it, thus compromising its effectiveness. In addition to the staff assigned to monitor the electronic systems, other staff must be available to **respond** to inappropriate inmate behavior detected by the electronic surveillance. Personal supervision by trained staff should be provided in all jails, regardless of the electronic tools used to supplement it. Electronic monitoring should be used to enhance rather than supplant staff functions. The appropriate blending of staff and technology should be reinforced during the transition process.

WORK ENVIRONMENT

A key fact to remember when creating the jail environment is that it is not only an inmate environment but a **staff environment**. Buildings contain behavior. Staff control inmate behavior.

Indeed, the jail is more of a staff work environment in that the average officer works in the facility about 215-220 days a year. The average inmate, according to national statistics, stays only about 11 days.

Additionally, jails experience a major problem with staff turnover. Much of it has to do with salary and career opportunity, but some of it has to do with very poor and stressful work conditions in older jails. Consequently, designs developed with staff in mind may help eliminate this trend and even set in motion improvements in other areas.

Staff-oriented considerations include:

- personal safety and security;
- ease of movement and ease of general job performance;
- pleasantness of environment
 - natural light,
 - artificial light,
 - sound,
 - color,
 - ventilation;
- control over personal environment, especially staff posts;
- amenities
 - **lockers/showers**,
 - training areas,
 - **lounge/break** room,
 - parking.

SECURITY PERIMETER

"Escape" and "contraband" are deeply troubling words to sheriffs and jail administrators. They represent the manifestation of basic security defects within the jail physical plant or problems with its operation. New jail design approaches, hardware technology, and improved training for jail staff over the recent past have reduced but not eliminated problems of escape, contraband passage, and related breaches in jail security.

Many breaches in jail security result from **human error** in recruitment, selection, and supervision of jail staff or a lack of adequate training and **written** policies and procedures. Some escapes early in a new jail's life occur because staff were inadequately trained in the new building's control equipment, which is frequently more complex than that found in the old jail. However, even the most elite correctional staff cannot be expected to make an inadequately designed and equipped jail consistently secure through staff effort alone. They must rely, to some extent, on the integrity of the materials, hardware, and design to complement effective security procedures.

The failure to define and establish, through planning and design, a clearly identifiable and reliable security perimeter (envelope) is a primary contributor to problems in small and medium-sized jails. Architecture, operational procedures, and technology are elements of jail security. Equipment, materials, and design decisions are influenced by the nature of the inmate population and are oriented toward basic security objectives. This section describes an overall approach to security and **recommends** measures to enhance jail security.

INGREDIENTS OF SECURITY

Security systems engineers and analysts have identified four major **ingredients** involved in providing building security: denial, detection, assessment, and response.

- **Denial.** In practical terms, denial for a jail means restricting inmates' access to unauthorized **internal** areas or the outside, separating different groups of inmates, controlling inmate movement, and eliminating the presence and passage of contraband in the jail.
- **Detection.** If the denial element fails or is compromised (e.g., a lock malfunctions or security glass is penetrated), then detection is necessary. Historically, detection in jails often came about through regular inmate counts or random cell checks and searches that revealed an escape or contraband. Detection might also mean that an officer observes an inmate scaling a fence or bolting through a door to an unsecured area. In modern jails, detection can involve sophisticated technology such as perimeter sensing devices to detect attempts at escape or intrusion.

- **Assessment.** Assessment is simply an evaluation of the problem that has been detected. It is largely a matter of determining the nature and degree of a situation (e.g., escape attempt, window tampering, unauthorized movement in a secure zone). Assessment may or may not be made with the assistance of sophisticated technology.
- **Response.** After detection and assessment, the response is the action taken by staff to counteract the problem. This may include triggering alarms, lighting selected areas, closing gates, and initiating evacuation procedures, as well as sending staff to the affected area.

THE SMALL/MEDIUM JAIL'S DESIGN FOCUS

The latter three of these ingredients tend to be supplemented by sophisticated technologies. Many of these technologies are most applicable to large military and industrial complexes, sensitive research facilities, and large correctional facilities. Since small and medium-sized jails are more compact structures that rarely have expansive and unprotected outdoor areas and do not involve a complex of separate buildings arranged in a campus fashion, many of these technologies seem unnecessary and tend not to be economically feasible.

The small and medium-sized jail's focus, then, is on providing the fundamental design features and the staffing required for effective denial, detection, assessment, and response.

Detection, assessment, and response primarily require the involvement of staff, supplemented by more basic technologies such as CCTV, audio monitoring, and remote control of locks, lights, and alarms. These staff-intensive ingredients are best provided by creating operations and designs that use constant and effective staff surveillance or supervision of all inmate-occupied or inmate-utilized areas, routes of egress, and the exterior of the facility. Refer to those sections for design information on how to make detection, assessment, and response an effective part of the overall security system.

This section of the design guide is devoted to the fundamental design features that provide the ingredient of *denial*.

Denial of escape and contraband passage is fundamentally accommodated in the design of the physical plant by:

- creating an overall barrier -- commonly referred to as a "*security perimeter*" -- that precludes contraband passage from the outside and unauthorized access to, and exiting from, the jail; and
 - creating *internal security zones* that preclude escape and contraband passage from inside the jail by controlling internal movement and maintaining separation between key activities and inmate-occupied areas -- especially those that house inmates who pose the greatest risk of escape or contraband passage according to the facility's classification plan. (See the section on "Classification/ Separation.")
-

PERIMETERS AND ZONES

The different kinds of perimeters and zones that might be created to assist staff in denying escape and contraband passage are described below.

Main security perimeter. This is the fundamental barrier that is intended to preclude escape, unauthorized ingress or egress, and contraband passage. It might best be thought of as a security *envelope* because the main security perimeter is a three-dimensional rather than a two-dimensional element. That is, it consists of the ceilings, roofs, and floors, as well as the exterior and interior walls, doors, pass-throughs, and windows, which help deny escape or contraband passage from the outside.

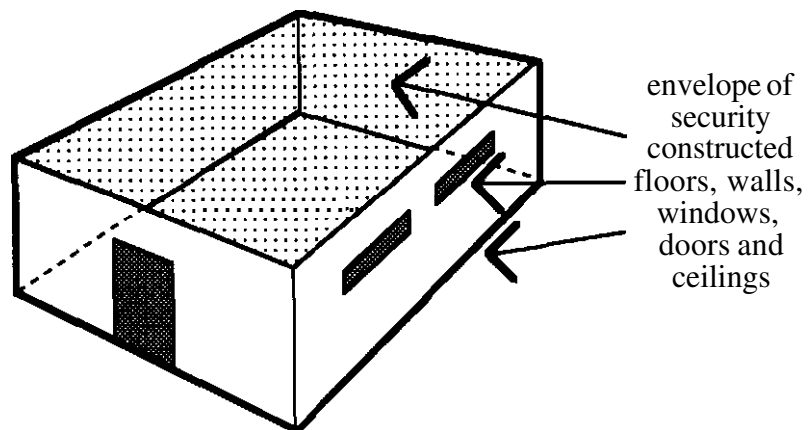

Perimeter fence or wall. This is a secondary or support element that complements the main security perimeter of the jail. The element normally consists of fences that define large outdoor exercise or farm and garden areas and that inhibit (though not necessarily prohibit) access to the main security perimeter. It may also consist of walls that create controlled exterior spaces to preclude view as well as inhibit access. These perimeter fences and walls do not create a three-dimensional security envelope.

Primary internal security zones. These are three-dimensional areas within the main security perimeter that provide for basic security separation and control of primary movement routes within the jail, denying or delaying access to other zones. Typical examples of primary security zones in a small and medium-sized jail include:

- Master Control;
- general-population male housing areas;
- female housing areas;
- special housing areas, especially those for work release or periodically confined inmates;
- program and support service areas; and
- visiting areas, especially those accessible to the public.

Access to these zones is typically controlled remotely by Master Control. In some cases, selected primary internal security zones coincide with fire and smoke containment zones within the overall structure.

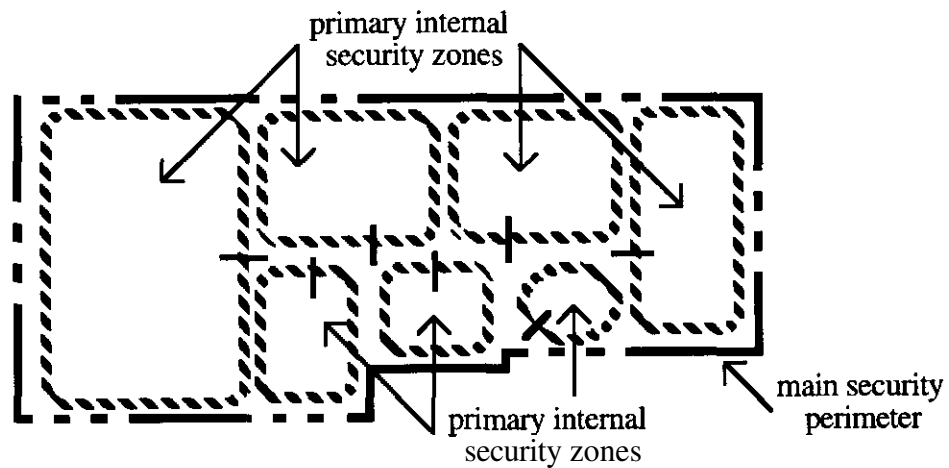

Secondary internal security zones. These are three-dimensional areas within both the main security perimeter and the primary internal security zones. Their purpose is typically to preclude unauthorized and uncontrolled access between functional components (e.g., laundry and food services) or between areas that are part of functional components (e.g., separate housing units) within a primary internal security zone. Access to these zones is typically controlled remotely by Master Control, or remotely or directly by other facility staff.

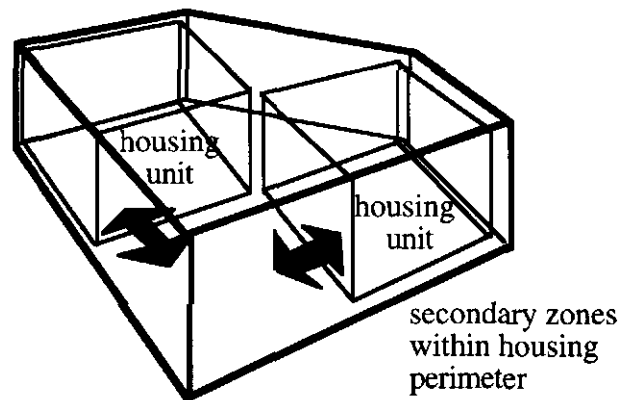

Zoning may go to a third level since *individual spaces*, such as cells and medication storage, frequently require fully secure protection from outside intrusion, escape attempts, and uncontrolled access within a secondary internal security zone. These spaces might be referred to as *tertiary internal security zones*.

BUILDING AREAS OUTSIDE THE ENVELOPE

The overall building envelope is virtually never the same as the security envelope of the jail. There are functions outside of the jail security envelope that must share the building to be effective. Typically, these include the sheriff's law enforcement functions and possibly court and probation functions. For these non-jail functions to share the building with the jail effectively, their needs must be recognized, their interrelationship with the

jail understood, and components integrated into the design in a way that avoids security conflicts. These issues are examined more closely in Chapter 3 under the section "Criminal Justice Interface."

Jail-related functions that need to be outside of the primary jail security envelope (like the lobby) also share the overall building envelope. Access to some or all of these areas may be controlled by jail staff within the security envelope.

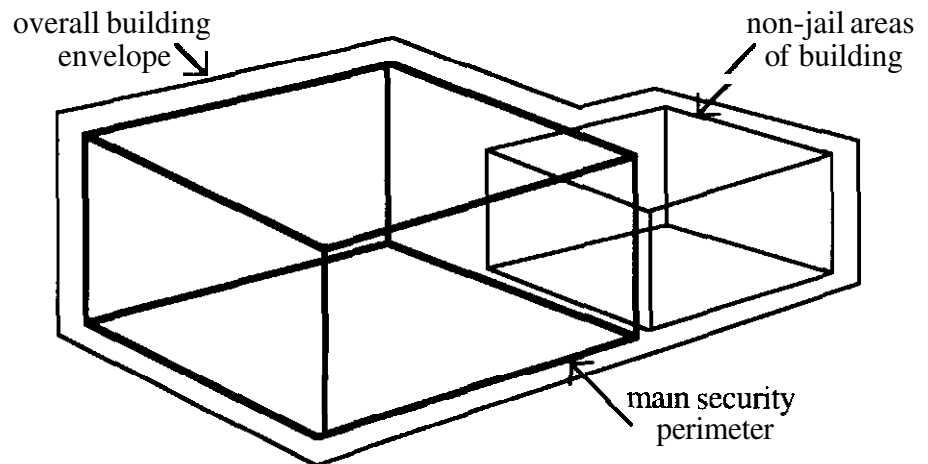

The most common functions affiliated with the jail, but outside its main security envelope, are the public lobby, the night lobby/vestibule, and the jail administration and staff areas (frequently provided in association with the law enforcement area). These **public areas** need different levels of access control. Non-jail spaces should be grouped depending on the type of access control required. Access groupings follow.

- ***Uncontrolled public areas.*** These areas consist of spaces to which the public has unrestricted access although they may be monitored by direct observation from a constantly staffed post **and/or** by electronic means (CCTV and/or audio). Spaces that frequently fall into this category are the night lobby/vestibule and, in certain designs, the public restrooms and the public lobby and its affiliated spaces (public restrooms, clothing locker areas).
- ***Periodically controlled areas.*** These are areas to which the public has unrestricted access only during portions of the day. At other times, access is precluded and controlled by jail staff (usually Master Control) or by law enforcement staff (normally the dispatcher). The public lobby and its affiliated spaces typically fall into this category, especially when a night lobby/vestibule is incorporated to accommodate unrestricted public contact after visiting and office hours.

- **Controlled access areas.** These are areas to which public access must be controlled or restricted at all times. The jail administration area is the main example of a set of spaces to which the public must have access only in a controlled and regulated way. The staff spaces (lockers, training, exercise) are normally within this area since public access should be restricted.
- **Restricted areas.** These are areas outside of the secure jail envelope to which all public access is prohibited. Such areas are generally minimal and are best exemplified by staff locker, lounge, shower, and training areas.

DESIGN CONSIDER- ATIONS

Following are design considerations for the development of the main security envelope and the internal security zones essential to the denial of escape, unauthorized access, and contraband passage. More information on the security development of different functional components, and spaces within functional components, can be found in Chapter 4.

GENERAL CONSIDERATIONS

Overlapping Perimeters/Zones

Because of the nature of internal zoning, the floors, walls, **and/or** roof **areas** that define internal zones and the main security envelope frequently **overlap**. For example, the exterior wall of an individual cell, which may be defined as part of a tertiary internal security zone, is frequently also the wall of the housing unit (secondary security zone), the general-population male housing area (primary security zone), and the jail as a whole (main security envelope). In such a case, it is critical to design the wall according to the needs of the most severe security condition -- in this case, those of the main security envelope.

In the same example, however, the ceiling of the cell might not coincide, or overlap, with that of other zones. This is because the security demands of the cell, or tertiary zone, might require the use of a securely constructed ceiling (concrete, steel, cement plaster on metal lath) that precludes access to a roof system above. If the roof system is securely constructed, it may serve separately as part of the main security perimeter or part of a secondary or a primary security zone. In another instance, the cell may be located under another cell sharing the same two-tier housing unit, or under a floor of another internal security zone.

Impact on Design

The primary reason for establishing a main security perimeter (envelope) and internal security zones is basic facility safety and security. However, an important architectural and economic benefit also accrues: development of a sound security envelope and effective internal zones allows wider latitude in the development of individual spaces in terms of material finish, hardware, and furniture selection. This is especially true when perimeter and zoning concepts are coupled with a well-developed **classification/separation** plan, and with concepts of constant staff presence and surveillance, thus providing detection, assessment, and response capabilities.

For example, if the main security envelope and the primary internal security zone of a housing area consisting of several housing units are well defined and properly designed, as well as constantly observed by staff, some of the following options and associated cost savings might become available.

- Less heavily reinforced and constructed **partitions** and less costly **security glazing** to separate housing unit **dayrooms** from the zone corridor since the zone is clearly defined and controlled, offering little gain to inmate(s) penetrating the wall.
- Less costly **doors, frames, hardware, and locks** on general-population cells since there is little gained by penetration.
- Less costly **dayroom ceiling** materials since penetration offers no viable escape route from the zone.
- Elimination of costly **security vestibules** at the entry to housing units since escape from the individual unit is contained within the primary housing area security zone.
- Elimination of costly **enclosed housing control posts** since assaultive behavior by inmates will not result in egress from the primary housing area security zone.

In evaluating these types of options, the issue of durability should not be neglected nor should it be forgotten that physical security is still a required ingredient.

From an operational viewpoint, a good perimeter and good internal zoning may allow for **unescorted inmate movement** between different points in the facility without fear of a successful escape attempt. An example would be unescorted movement between housing and visiting zones.

Master Control

A key consideration in the development of an effective security envelope and effective internal security zones is creation of a Master Control position. This position, which must be a primary internal security zone in its own right, must be able to:

- monitor all security systems (CCTV, alarms, pressure-sensitive movement detectors, etc.);
- communicate with, control, and monitor or directly observe people at all **ingress/egress** points in the main security envelope;
- communicate with, control, and monitor or directly observe people at the doors or gates that help define internal security zones and inhibit movement between them;
- communicate with facility staff wherever they are located in the facility; and

- control entry into the Master Control space. Note that an emergency key should be kept outside the facility's security perimeter to open the room if the officer becomes incapacitated.

More on the design of this space can be found in Chapter 4 under "Master Control."

Compatibility of Construction

In creating the security envelope and internal security zones, it is important that materials, finishes, and hardware in perimeter and zone barriers are compatible and comparable. For example, it is not helpful to provide a glass-clad polycarbonate glazing material, only to provide a base wall that consists of gypsum board. It is also inappropriate to provide a high-security lock with a lightweight hollow metal door and door frame. Other incompatible elements are concrete floors and reinforced concrete masonry unit walls combined with lightweight suspended metal acoustic ceiling panels that lead to unsecured ceiling plenums (the space between ceilings and roofs).

Security above the Zone

One often-overlooked consideration in the development of envelope and internal security zones is security *above* the space or area that is being defined as a zone or envelope. Failing to realize that the envelope and zones **are** three-dimensional, planners often give inadequate attention to the development of the ceiling in relation to the ceiling plenum and the roof as a key element of the envelope or zone.

There are several considerations in this regard.

- The ceiling of a space should be securely constructed if the walls around the zone do not extend to the roof or construction above and/or if the roof or construction above is not secured.

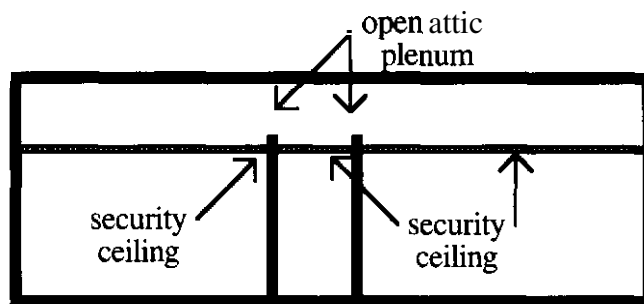

- The ceiling should be securely constructed regardless of the nature of the roof or construction above and regardless of the degree to which the walls exceed the ceiling line if elements in the ceiling need protection (electrical lines, water lines, ductwork) or access to the plenum is intolerable under any circumstance.
- Openings in a secure ceiling should be sized and designed to preclude unwanted penetration.

MAIN SECURITY ENVELOPE

The following design considerations apply to the main security envelope of the small and medium-sized jail.

The main security envelope must assist in denying escape and contraband passage and must be constructed with the assumption that extremely dangerous and sophisticated criminals may be held in the local jail. Escape and contraband passage **are** constant risks that can be initiated by individual inmates or in conjunction with outside collaborators. The preservation of a safe environment inside the **jail** and the prevention of assisted escapes or contraband passage from the outside require strict control over all penetrations of the security envelope.

A variety of design considerations address the development of the main security envelope to prevent escapes and contraband passage.

- The number of **access points** must be **limited** to the minimum necessary for the efficient operation of the building, separation of conflicting traffic flows, and compliance with life safety codes. The fewer entry and exit points, the fewer chances that security at these areas will be compromised. Minimum access points needed in a security perimeter to properly control traffic flow and satisfy codes include:
 - main public access to visiting and program areas;
 - staff access to the perimeter, which may be the same as the public access;
 - **arrestee/officer** access;
 - **food/supply** delivery and garbage removal access; and
 - required points of emergency egress.
- All access points into the main security perimeter should be through a security vestibule with **interlocking doors**, which have the capability of being overidden in an emergency.

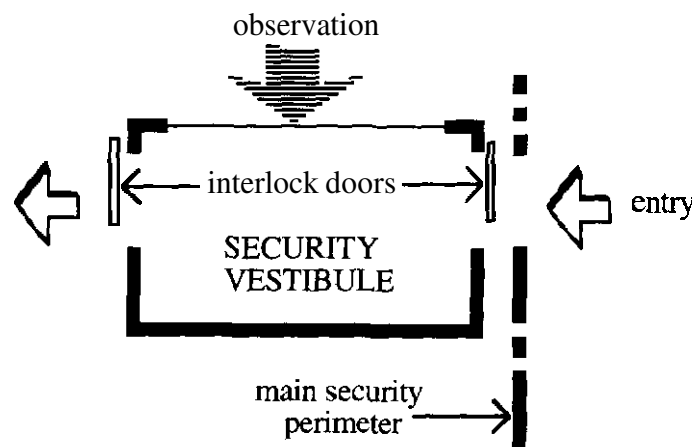

- Access points into the main security perimeter should have a **key override** capability. Keys to these doors should be under the direct control of the Master Control officer and should never be removed from the Master Control area except in an emergency.
- **Metal detectors** should be available at all access points used by the public and outside service providers and, depending on the policy of the jail administration, at access points used by jail staff and other officials.

Metal detectors can be integrated into the architecture of the facility in ways that hide them from view. Although the integrated detectors may be more aesthetic, the use of free-standing or hand-held detectors might be more of a deterrent at access points.

- All access points should be securely constructed. Some example approaches include:
 - swing or sliding doors of 12- or 14-gauge steel;
 - frames grouted and anchored securely to the wall;
 - high-security detention-grade locks and hardware;
 - vision panels, if used, employing the strongest security glass products; and
 - walls, floors, and ceilings that are securely constructed and create their own three-dimensional security zone.
- The materials and construction methods used for the envelope must be relatively impenetrable, even from sustained attack with tools. Examples:

Floors

- concrete with various finishes

Walls

- precast or cast-in-place concrete
- concrete masonry units reinforced and grouted every 8 to 16 inches on center

Ceilings

- precast or cast-in-place concrete
- steel security panels
- cement plaster on expanded metal lath

Roof

- precast or cast-in-place concrete with built-up roofing membrane
- heavy gauge metal deck securely fixed in place with roofing membrane

Windows

- typically inoperable unless heavily screened with **security-grade products**
 - strongest security glass products available
 - securely anchored detention-grade
- Penetrations of the main security envelope (other than the access points) should be secured:
 - pass-throughs for such things as packages, money, and mail
 - **ductwork**
 - **electrical** openings
 - roof fan openings
 - air supply grills
 - skylights
 - other.

In general, these openings or penetrations in the walls, ceilings, roofs, and walls of the main security perimeter should not exceed 5 inches in one dimension unless the opening can be confined to an area of 8 x 8 inches or less. Openings exceeding these dimensional limits should be protected by steel bars or other security elements that effectively reduce the size of the opening.

- **Public view** of inmate living or activity areas must be limited as much as possible. Techniques to accomplish this and still provide natural light to inmate-occupied areas are discussed in the section on "Site **Selection/Design.**"
- **Outdoor exercise** areas traditionally present special problems for security envelope design, including at least five typical **concerns**:
 - Need to eliminate view conflicts and physical contact with the public.
 - Control of contraband introduction from outside sources.
 - Prevention of intrusion or escape through or over the exercise area fence or wall.
 - Need for a means of egress from the area if it is to serve as a containment area for facility evacuations.
 - Need for CCTV surveillance to augment direct supervision of the area.

At this particularly vulnerable point, special care must be taken during the design effort to close potential "holes" in the main security envelope. A thorough discussion of related design considerations is contained in the "Exercise Areas" section in Chapter 4.

- CCTV monitoring systems can provide some control over the exterior of the main security perimeter. If CCTV is used, several considerations apply:

- minimize the number of cameras to facilitate effective monitoring,
- minimize recesses and pockets in the building form to enable a minimal number of monitors and better view,
- place cameras in locations inaccessible to public contact, and
- select cameras that accommodate changes in light level (day-night) where applicable.

Perimeter lighting is also a useful feature to discourage approaches to the security envelope by the public or persons collaborating with inmates on escape attempts.

If a CCTV system is provided, monitoring of the rooftop should be considered, especially if the facility is a single-story structure. Building rooftops should be as clear of obstructions as possible. Means of discouraging access to the roof via downspouts, light fixtures, and other elements that protrude from the exterior should be examined.

- Access to mechanical penthouses should be secured at both the outside access and the inside access to the rest of the jail.
- Landscaping for the facility must be examined in light of overall security design. All shrubs and trees should be placed to ensure that sight lines to the perimeter are not obscured. They should not be positioned where they can be used by an intruder in scaling perimeter walls and fences. Landscaping may be useful to help preclude approaches to the exterior (tough, thorny bushes, for example).
- Installation of a totally climate-controlled heating, ventilating, and air conditioning (HVAC) system should be considered to void the need for operable windows.
- The design should limit personal visitors to a primary internal security zone created for visitation purposes adjacent to the public lobby. Contact visits should occur in a designated area within this zone under staff supervision.

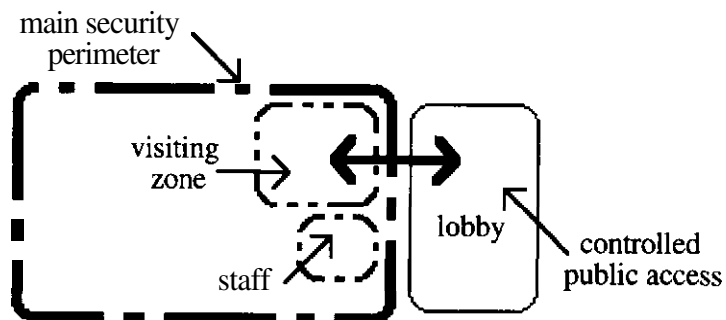

Special Considerations for Denying Contraband

Most of the preceding design considerations that help deny escapes fundamentally help deny contraband passage from outside parties. However, contraband can be introduced into the facility by inmates **entering** the main security envelope. Two types of inmates are usually involved.

- The escorted inmate who acquires contraband while outside the main security envelope. Contraband enters the jail when officers returning the inmate fail to perform an adequate clothed or unclothed search prior to returning the inmate to the general population.
- The work **releasee** or inmate worker who has outside privileges and is not subject to search each time he/she reenters the main security perimeter of the facility.

Design features that can be incorporated to reduce this risk include:

- Clearly **separating the entry and exit** of work releasees and inmate workers from each other since they provide a natural chain of contraband passage. If separate entries are not **achievable**, contact and contraband passage opportunities will have to be controlled by staff.
- Providing **separate clothing exchange** areas for inmate workers and work releasees, where they can leave potentially contaminated clothing and personal items and dress in institutional clothing prior to returning to a secure housing area.
- Clearly separating the **housing** of work releasees from inmate workers by placing them in separate primary internal security zones and precluding one group from entering the zone of the other.
- Providing **separate laundry** facilities for work releasees. Separate facilities for exercise, visiting, and other activities might also be considered unless staff action can minimize contraband passage opportunities.
- Providing **vestibules** or spaces in which all escorted inmates, work releasees, and inmate workers can be searched at reentry.
- Locating all activities or **work functions** of inmate workers, such as food preparation and laundry, inside the main security envelope and outside of primary internal security zones provided for inmate housing.
- Creating an **enclosed delivery vestibule** and refuse storage area, using a system of interlocking doors observed by CCTV from Master Control and/or directly by staff in cases where inmate workers are involved in receiving and storing food or packaging refuse.

- Designing all **pedestrian entrance vestibules** to avoid hiding places that could be used for concealment and later retrieval of contraband during entry and exit by inmates.
- Providing **exterior doors** that seal tightly to prevent introduction of contraband under the door or between the frame and the door.
- Providing secure routes to **court** facilities that eliminate or minimize opportunities for public contact.
- Providing secure space for **interviewing** inmates within the main security envelope rather than outside the envelope, such as in jail administration or law enforcement areas.

PERIMETER FENCES/WALLS

Perimeter fencing is commonly found at large jails and prisons and typically consists of two parallel fences around the entire institution. The only openings in the fences are at the public entry near the administration portion of the building and at a vehicle entry point. Some distance between the two fences is necessary to prevent jumping from the top of one fence over the other or using instruments (e.g., ropes, ladders) to bridge from one fence to the other. The space between the two fences also allows for the placement of security wire to inhibit movement if the first fence is penetrated or scaled.

For the small and medium-sized jail, the need for such a perimeter fence or wall is less clear than for large facilities that have multiple buildings and high levels of required outdoor inmate movement. In the small and medium-sized jail, most or all inmate housing activities and movement occur within the secure envelope of the physical plant, negating the need to physically contain outdoor movement.

There are, however, reasons that a perimeter fence or wall around some or all of a small or medium-sized jail makes sense.

- There may be concerns regarding the jail's immediate adjacency to sensitive public areas, such as schools, playgrounds, parks, nursing homes, or densely populated areas, that justify additional separation or screening.
- The amount and type of inmate activity **occurring** outside the jail building, such as inmate gardening, grounds-keeping, building maintenance, and field recreation, might require a fence enclosure.

In most instances, a single fence rather than a double fence makes sense, especially if inmates do not have access to the outdoor areas or if only a few inmates use the areas and they are directly supervised by staff.

If view conflicts are perceived or the appearance of a fence is objectionable, a perimeter **wall** would be more appropriate but probably more costly.

If a perimeter fence or wall is incorporated into the building plan, several design characteristics should be considered:

- a minimum height of approximately 12 feet;
- if a fence is used, a tightly woven mesh or wire to inhibit climbing;
- security wire at the top of the fence or wall (in the case of a wall, the security wire might be just behind the wall out of public view for aesthetic purposes);
- an ability to observe all portions of the area defined by the fence, especially if inmates are to use the area (by a direct view from a constantly staffed post, by CCTV, or by both); and
- an extension of the fence or wall below grade to preclude tunneling.

INTERNAL SECURITY ZONES

Primary security zones incorporate the following key principles into facility design and operation.

- Ingress and egress are regulated and monitored by direct visual or CCTV observation from a Master Control center.
- All movement of people and materials from one zone to another is restricted and controlled by strategic placement of corridor gates or doors remotely operated by Master Control.
- All out-of-cell inmate activities in the zones are directly supervised, observed from a constantly staffed post, or monitored by CCTV.
- Creation of a secure three-dimensional envelope, similar in construction to that of the main security perimeter although the zone can frequently share elements with the security envelope.

One key aspect of defining primary internal security zones is to achieve a proper *balance* between security needs and efficiency. That is, it is possible to subdivide the jail into so many zones that staff and inmate movement becomes difficult and burdensome. One consequence of this is that staff prop open doors that are meant to be closed and are indicated as closed on control panel annunciators. Thus, the value of sophisticated control technologies diminishes and concepts of zoning and movement control break down.

Secondary Security Zones

Secondary internal security zones incorporate the following key principles into facility design and operation.

- Ingress and egress are regulated and monitored by Master Control or another officer through locked doors that may either be remotely or mechanically operated.

- Inmate activities in the zones may be supervised or unsupervised depending on the risk level of the inmates in the zones.
- Construction and material approaches for secondary and even tertiary internal security zones might be less secure than those for the main security envelope and primary internal security zones, although needs vary on a space-by-space basis.

For example, the security needs of a medications storage space or a disciplinary detention cell, both of which might be defined as tertiary security zones, may well demand construction similar to that of a primary zone. Conversely, the indoor exercise area, as a secondary internal security zone, would typically not require construction as heavy or as secure as a primary zone or the main security envelope.

The data on individual components presented in Chapter 4 should be examined for their implications for security construction.

CONCLUSION

Accurately defining and creating security envelopes and zones is the essential ingredient in an architecturally secure facility. Effective development of envelopes and zones is also one of the key space-organizing principles of a jail design. To be fully effective, however, the architectural concepts must complement and, in fact, derive from, fully developed operational principles regarding inmate classification and separation, supervision and surveillance, staffing, and basic policies and procedures of operations. If a true **marriage** between security design and operations is achieved, the small or **medium**-sized jail's basic mission of ensuring exterior and interior security will be achieved.

CRIMINAL JUSTICE INTERFACE

A jail does not operate in a vacuum. It is only one part of a larger, interrelated criminal justice system. Officials from other elements of the system interact with jail inmates and staff on a daily basis, and jail designs need to enhance the effectiveness of these interactions. This section identifies ways in which **other** criminal justice system participants interface with the jail.

The system elements that have the most interaction with the jail include:

- the affiliated law enforcement agency, most typically the sheriff's department;
- the courts;
- defense and prosecuting attorneys; and
- probation and parole.

A GENERAL CAUTION

Establishing proper interface between the jail and other elements of the system entails more than just **making** sure inmates get to court or see an attorney. Sometimes design processes get so focused on solving jail facility problems that they inadvertently create problems for law enforcement, probation, court, and other related functions.

This problem is **especially** acute when the jail facility shares a site with other criminal justice functions. **Specifically, jurisdictions have expanded jails** in less than-desirable ways on **existing** sites solely because the courts **are** also there. These solutions have either ignored the growth needs of the courthouse or its fundamental inadequacy as a modern, secure court facility.

Then when the jurisdiction later turns its attention to court needs, it discovers there is inadequate room on the site and that solutions require a new facility or addition at a different location. Thus, the jurisdiction is left with the worst of all worlds: higher costs for the court solution, no interconnection between jail and courts, and a jail design that was compromised by erroneous site considerations.

To avoid this scenario, consider doing the following during pre-design planning for the jail:

- develop at least a broad **understanding** of the facility, parking, and operational needs of related criminal justice functions;
- if possible, develop a criminal justice facilities **master plan** so the jail project fits into a clearly understood context;
- invite **criminal justice officials** to be routinely involved in jail planning meetings;

LAW ENFORCEMENT INTERFACE

- before using a shared site, develop *sketchwork* that shows how the site will accommodate the jail design, jail expansion, expansion of the other facilities on the site, and all related parking; and
- evaluate jail *options* at varying distances from the site to test actual functional and cost differences -- it may be discovered that a new location is not as detrimental as staying on the courthouse site.

Most county jails **are** organizationally a part of the local sheriff's department. As a result, most small and medium-sized jail facilities **are** constructed in combination with a sheriff's administrative, road patrol, and civil functions. The close administrative and arrest processing ties between law enforcement and jail operations frequently result in a blurring of distinctions between the two different functional needs. For example, law enforcement communications/dispatch staff are often responsible for controls and electronic monitoring of jail areas, and the kitchen in some jails is the break area for law enforcement staff.

While some staff and space sharing can be successfully planned and designed, experience has shown jail resources are frequently used to compensate for insufficient law enforcement provisions. The most frequent complaints relate to storage **and/or** staff support provisions. Many jurisdictions find they need to reassign some jail spaces to law enforcement use to relieve critical deficiencies, which creates a twofold problem:

- Space planned for jail use is lost, thereby **re-creating** some of the same overcrowded or deficient jail conditions that originally prompted new construction.
- The reassigned spaces are not efficiently located, requiring law enforcement staff to regularly move in and out of the jail security envelope for non-jail purposes. This increases the workload for jail control staff and potentially generates security concerns. Secure jail operations require a specific security envelope that restricts and controls access of all non-jail persons and activities. This concept of control should include non-jail sheriff's department staff.

The principal reason space shortages exist in new law enforcement components seems to be that most of the *focus* was on the jail throughout the facility development process -- a logical thing when one considers the controversies that frequently propel jail projects. The solution? Treat both the jail and law enforcement functions more equally, beginning with a solid review of how they interrelate.

SPACE-SHARING CONCEPTS

When the jail facility is jointly constructed with law enforcement spaces, a number of space-sharing concepts can be considered in both the jail and law enforcement areas. Space sharing can help eliminate duplication of resources while providing a comprehensive facility plan at minimal **construction** cost. These issues and their design implications are discussed next.

GENERAL

The success of the jail design can, to some extent, depend on the successful planning and design of adjacent, non-jail areas. Therefore, the following issues, while not dealing with law enforcement design per se, focus on the design of key law enforcement elements that "interface" with the jail.

Public/Staff Separation

The organization of jail building and site designs frequently achieves separation of public access and vehicular traffic, including parking, from non-public areas (staff entry, arrestee entry, service delivery access, etc.). Law enforcement functions need to be similarly separated. Coordinating these separations during initial site utilization studies can create the basis for better separation of public from non-public areas and possibly yield a more efficient shared public lobby and unified staff parking area.

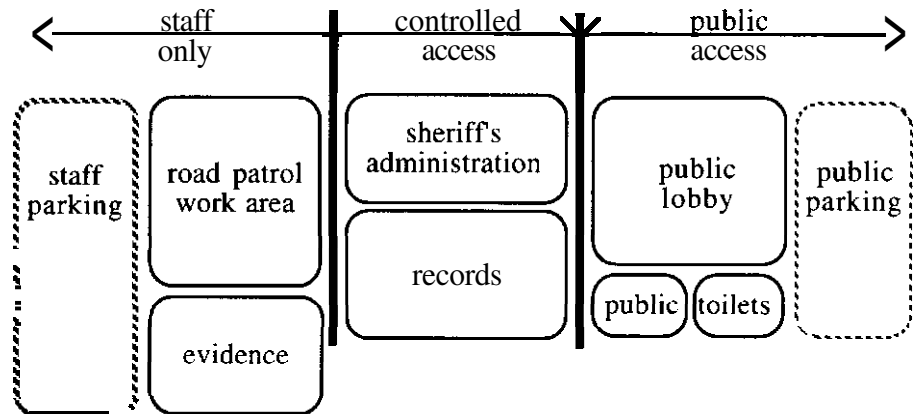

Law Enforcement Dispatch and Jail Control

Jurisdictions with smaller sheriffs departments often use staff in the dual role of jail Master Control officer and law enforcement communications/dispatch officer. Whether this operational practice can or should continue is a critical decision in developing a small jail design. It is rarely an option in medium- and large-scale facilities.

The expectations for staff monitoring of inmate activities and the sophisticated controls of new jails dramatically increase the tasks and responsibilities of jail staff over previous experience. Where population growth is a factor, the increasing volume of communication calls alone may dictate separate dispatch staff. To assess the issues involving the Master Control jail position and communications dispatch, see the section on "Master Control" in Chapter 4.

Regardless of the decision made on control responsibilities, any staff responsible for monitoring jail movement or inmate activities should be trained jail officers whose *primary responsibilities are jail operations*.

This is critical to eliminating the problem of staff trained as dispatchers being thrust into a jail control role they do not want and that they perform reluctantly and ineffectively. In designs where the Master Control/dispatch

center is strategically located to visually monitor and control a series of jail spaces and activities around it, dispatch staff frequently cut off the views by placing blinds or curtains over the vision panels, which can create a dangerous situation.

When communications/dispatch operations are to be combined with the Master Control space, the space may need to be located adjacent to or closely connected to the records area and the public lobby. Dispatchers frequently need access to records information not available in electronic data systems. Especially during evening and weekend hours, they also frequently respond directly to citizen requests for assistance.

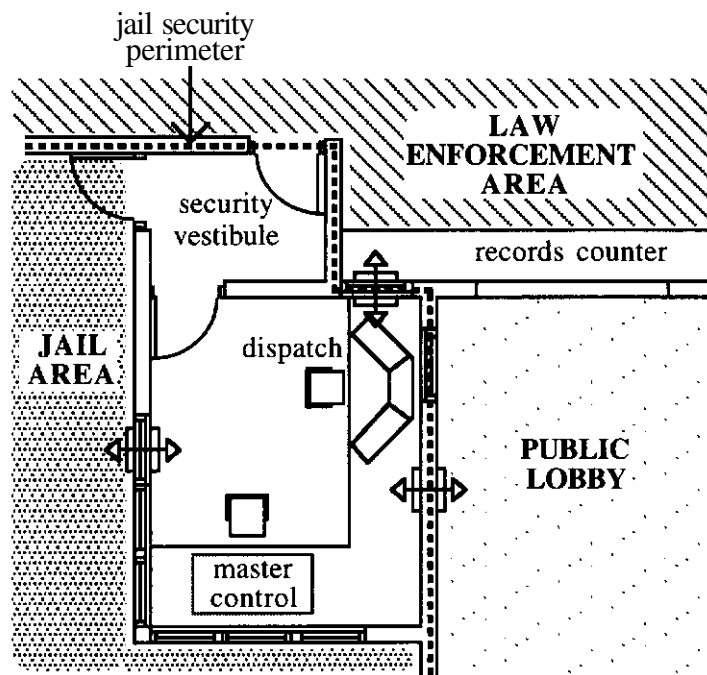

Records

Most records storage and retrieval functions will be focused in the law enforcement areas of a sheriff's department. The active, hardcopy files for inmates, however, are created and stored in the jail until an inmate is released or transferred. The physical transfer of those files to a central records area requires little more than the design of a staff access route between the jail and law enforcement areas or the creation of another means, like a pneumatic tube system.

Arrest Processing

The chief interface between law enforcement and the jail is the transfer of custody of an arrestee from local police, state police, or sheriff's deputies to the jail staff. This is a daily occurrence that must be easily accommodated by the jail design.

An enclosed vehicle sally port for entry of the arrestee and arresting officer is a virtual standard in modern jails. Beyond that, provisions for the arresting officers should also include:

- weapons lockers in the vehicle bay;
- an exterior **pedestrian** entry through which an officer can re-enter after moving **his/her** vehicle out of the sally port;
- visual monitoring by intake-release **and/or** Master Control staff of the entire arrestee route in case the arresting officer needs assistance;
- a work **area/security** vestibule that provides a secure entry point through the jail's security envelope as well as a place for law enforcement officers to do pat downs, take property, and complete pre-booking paperwork;
- sobriety testing equipment in or adjacent to the work **area/vestibule**;
- **interview/interrogation** space; and
- a report-writing area, possibly with a telephone, for the arresting officer.

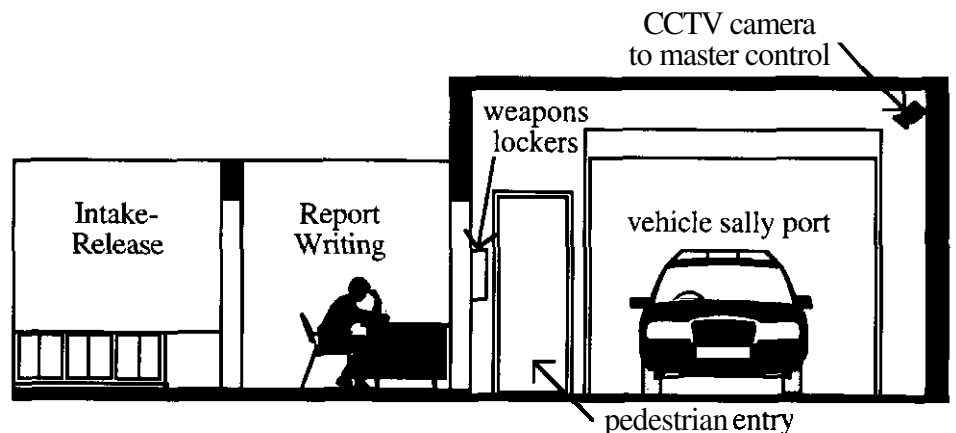

Other provisions for the arresting law enforcement officer might include:

- a toilet;
- quick access to a temporary holding room for uncooperative **arrestees** or for processing multiple arrests; and
- in jails that frequently serve state police or game wardens, separate or special fingerprinting, photographing, or alcohol testing equipment.

These provisions should all be located **adjacent to the intake-release area** in a way that does not require the arresting officer to go beyond the entry vestibule and deeper into the jail security envelope. For more information on this topic, see the section on "Intake-Release" in Chapter 4.

Investigations

Local and state law enforcement officers frequently need to interview jail inmates. To alleviate security concerns with inmate movement, *interview space* can *be* provided within the jail security envelope, located similar to visiting and attorney counseling spaces. In fact, those spaces could serve the interview function if scheduling conflicts can be avoided.

Some departments indicate a periodic need for a *lineup room* for *victim/witness* identification of *arrestees*. This should be located so as to minimize public penetration of the jail and securely separate *victim/witness* movement from that of inmates. Given the limited use of lineup facilities, these spaces are prime candidates for multiple-use consideration. If located within the security envelope, the inmate side may also be used for counseling, library, or religious services. If the space is located along the security envelope, extra care should be taken in selecting the type of security glass used to separate inmates from the non-secure side.

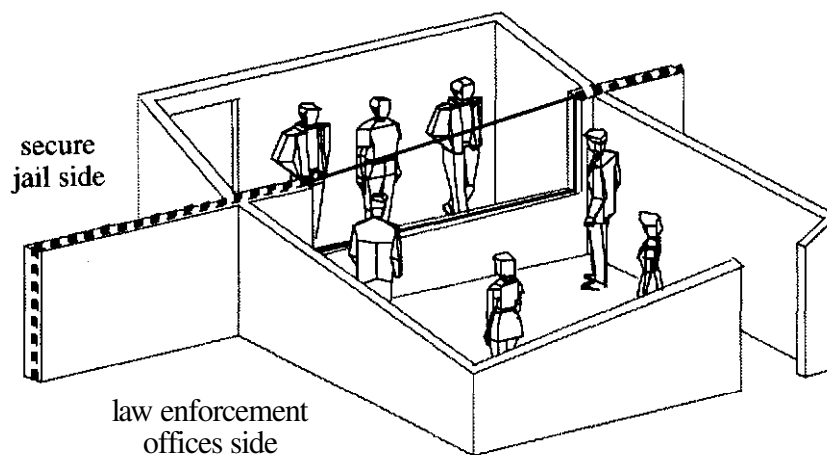

Jail Administration and Staff

Space for the jail administrator, clerical activities, conferences, staff training, and staff lockers and showers does *not* necessarily need to be within the jail security envelope. When law enforcement offices are built in conjunction with the jail, creation of one administrative and staff area can minimize expensive secure space and eliminate unnecessary duplication of spaces. For example, the same space can be used as a training classroom for jailers and for law enforcement officers. Clerical, conference, and jail administration activities can take place in the same area. Jail and law enforcement staff locker areas can be combined outside the secure jail envelope with joint-use toilet and shower facilities.

For more information on these issues, see the sections on "Administration | Public" and "Staff Areas" in Chapter 4.

Food Service

The jail food *service* area is frequently used as a lunch and coffee break space for law enforcement officers. This sharing of kitchen space has also emerged where Disaster *Services/Emergency* Operations provisions are included in an overall facility plan. If the kitchen is located outside the security envelope, this sharing of space is problematic only to the extent that it

tends to discourage the use of inmate workers in food preparation and cleanup. Securely moving three meals a day in and out of the security envelope can be an inefficient use of staff time.

It is usually better to dedicate kitchen facilities to jail meal preparation and to locate these spaces within the jail envelope to enhance security and to minimize staff time in serving meals and returning trays and utensils. Separate canteen or break area facilities for law enforcement staff outside of the jail security envelope result in minimal addition of space and equipment and a more efficient and secure overall operation.

Maintenance

The secure vehicle sally port used for delivering arrestees is often used as a maintenance bay and wash rack for law enforcement vehicles. It is sometimes used to securely search and take evidence from vehicles used in criminal activities. Using the arrestee sally port for these purposes can be dangerous because of the equipment left in the area for maintenance activities and because it can block secure delivery of arrestees.

The ideal solution would be to provide a separate maintenance garage for law enforcement use. At a minimum, all loose equipment and supplies in the sally port garage area should be kept in a securely locked storage room and arrestee delivery should be given priority over other activities.

COURTS INTERFACE

From 50% to 90% of all arrestees booked into the typical jail will make one or more court appearances before they are released from custody. Other inmates arrive at the jail to be booked just after sentencing and under court escort. Inmate movement to and from court tends to occur in three ways:

- the inmate is **walked** through secure **and/or** non-secure corridors directly to the courtroom;
- the inmate is either driven or walked to a courtroom at a separate location; or
- the inmate appears in court facilities specially set up at the jail.

CORRIDOR MOVEMENT

When the jail and the courthouse are directly connected, the following considerations apply:

- movement through the jail security envelope should be through an interlocked security vestibule;
- once out of the security envelope, as much movement as possible should be through corridors, stairs, and elevators to which the public has no access or where public access can be temporarily precluded; and
- movement should be monitored by jail staff other than the escort officer, such as the Master Control officer.

MOVEMENT TO OFF-SITE COURT

Increasingly new jails are being built on sites other than the courthouse site. This requires movement of the inmate outdoors, thus introducing increased risks of escape and assault. Even if the jail is only one block from the courthouse, it is strongly recommended that an inmate not be walked to the courthouse, but driven there in a secure vehicle.

Other related considerations include:

- departure from the jail should be through the vehicle sally port;
- access to the sally port should, if possible, be via a secure route that does not go through the intake area;
- necessary restraint equipment should be readily accessible near the vehicle sally port;
- a place to hold or stage the inmates to be transported should be available; and
- a vehicle sally port should also be at the courthouse to avoid the need for any exposure to the outdoors.

APPEARANCES AT THE JAIL

Some jurisdictions with separate jail and court facilities conduct early, uncomplicated court appearances at the jail. Such appearances include arraignments (also called first appearances) and, in some states, probable cause hearings that are required before arrestees can be booked. Even preliminary hearings are conducted at some jails.

These early proceedings can be done at the jail because they are brief (3 to 5 minutes for arraignments) and do not involve many people. A very high percentage of inmates are released on bail, recognizance, or a third-party signature immediately or shortly after their first court appearance.

Court appearances at the jail generally take place in two ways:

- bringing all participants to specially built court space or an easily adaptable multi-purpose space at the jail; or
- installing a video appearance system that allows everyone but the inmate, and perhaps a public observer, to participate from the courthouse.

COURTROOMS AT THE JAIL

Building a courtroom into a small or medium-sized jail is an option that is not taken very often. It is frequently perceived as inconvenient to judges and court officials, it adds to construction costs, and it broadens security responsibilities at the jail.

When this concept is pursued, several questions must be answered.

- Do jail staff have security responsibilities in the courtroom or do the court and its bailiffs?

- Will all non-inmate participants be screened through jail facility security, including metal detectors?
- Will defendants who are not in custody also make their first appearance at the jail courtroom?
- How extensive will the court operation be? Must there be space for a judge's office, a clerk's office, attorney-client consultation, public waiting, etc.?
- Can the court space be used by the jail for program activities in the evening and on weekends?

Some design considerations that apply if a courtroom is designed into a jail facility follow.

- Provide separate interlocked security vestibules for access to the courtroom by 1) inmates, and 2) the public and officials.
- Provide CCTV monitoring and intercom communications to the Master Control center.
- Create a primary security zone for the court area, e.g., construct any window openings out of detention-grade materials.

VIDEO APPEARANCES AT THE JAIL

Using video technologies has become the common way to hold court appearances at the jail. With video, the only participants at the jail are typically the inmates and jail security staff. In some states, public observers may have the right to **directly** witness the inmate's court appearance at the jail. Judges, prosecuting attorneys, court reporters, clerks, bailiffs, and defense attorneys stay at the courthouse. So do most, if not all, of the public and all out-of-custody defendants.

Space requirements for video appearances are minimal and can be easily provided in a multi-purpose room at most small and medium-sized jails. Equipment needs are generally limited to a TV monitor, a camera, a microphone, switching equipment, chairs, and a table or podium. Video signals are transmitted via microwave, cable television lines, or by dedicated wiring if the courtroom is close enough. Monitors generally provide "split-screen" views so that all major participants can be seen at one time.

In developing a video appearance capability at the jail, a number of design issues should be addressed:

- backup observation of the space by CCTV or, preferably, direct line-of-sight from a staff post should be attained;
- the video appearance equipment should be protected from tampering or accidental damage if in a space shared by other functions (through such means as closeable cabinets, roll-away carts, or closeable alcoves);

- the space should be designed so that multiple inmates can simultaneously hear the initial instructions from the judge;
- it would be useful to install a fax machine or some other means by which papers can be moved quickly between locations; and
- the space should allow sufficient distance between camera and defendant to accommodate full-body views if desired by the judge.

ATTORNEYS

Inmates need to have access to attorneys, **particularly** defense attorneys. This is accomplished primarily through telephone conversations and personal meetings or interviews.

Telephones in the **dayrooms** of housing units facilitate **inmate/attorney** consultation, but have the disadvantage of offering limited privacy. A more private telephone alcove or a pre-fabricated acoustically screened station may be a good solution.

Attorney/client interview space can be either contact or non-contact or both. Discussion with the local bar association is advised to determine the best solution in **terms** of appropriate access and security.

Access to contact interview spaces should always be gained by passing through metal detectors and an interlocked security vestibule. When considering the use of non-contact space, remember that attorneys sometimes must pass paperwork to the inmate for review or signature. Without a **securable** paperpass, jail officers will bear the burden of passing paperwork back and forth.

Other considerations follow.

- provide good acoustic quality;
- provide ample desk surface for files and paperwork;
- provide adequate artificial lighting on the desk surface;
- provide seating for at least two attorneys;
- provide accessible space for attorneys or inmates who are wheelchair-bound;
- provide a means of communication that allows attorneys to talk to staff (**e.g.**, to announce the end of a visit);
- consider providing a panic alarm; and
- locate the space so that random or constant staff observation is possible.

Public Defender

Public defenders have somewhat different needs than private attorneys. It is not unusual, for example, for the public defender to see several inmates during one trip to the jail and to represent most of the jail's population. For efficiency's sake, it is helpful to design a *waiting area* adjacent to the *attorney/client* visiting rooms. Since such a space could hold a mix of inmate classifications, it should be in direct view of a constantly staffed post, if possible.

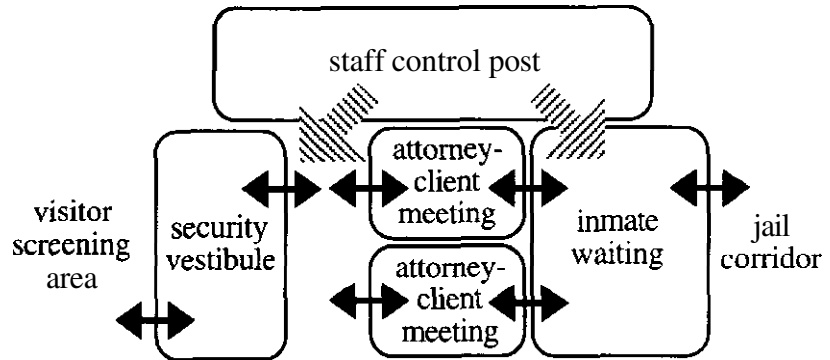

Another way to make the public defender's work more efficient would be to provide a small office with access to a telephone, computer, and fax machine. The computer should be linked to any court or relevant, non-private inmate data systems available.

PROBATION/ PAROLE

Probation and parole staff have interview needs similar to attorneys, and space provided for *attorney/inmate* interviews is normally sufficient for their needs. The planner must ensure, however, that enough space is available to meet the needs of all who will share the space.

The most distinctive need of *probation/parole* officers is for *hearing space*. Hearings occur when offenders are arrested for alleged violation of probation or parole conditions. Many jurisdictions accommodate hearings *at* the jail to minimize inmate movement outside of the facility. Hearing rooms should accommodate four to eight people, provide a large table and chairs, have good acoustics, and provide convenient electrical outlets for recording and transcription equipment.

CONCLUSION

There are important points of interface between the jail and other components of the criminal justice system. Although the collective space needs or space organization demands of these other functions are not great, they have significant impact on the successful operation of the jail. These interface issues deserve serious consideration during pre-design planning and skillful development during design.

FUNCTIONAL COMPONENTS AND RELATIONSHIPS

A jail is a single building made up of many small pieces, or components, that represent different functions or activities. Together the components are intended to satisfy all of the needs of inmates, staff, and public users of the jail.

The selection of appropriate components, the details of their development, and their arrangement in relationship to each other on a selected site are what make each jail design unique and responsive to local conditions. It is this uniqueness of need and condition that makes it difficult to apply one standard, "cookie-cutter" design to all jail design problems. To meet local jail needs effectively, it is critical to develop a working knowledge of the various components needed by the jurisdiction in terms of their function, interrelationship, and impact on design.

In response to the need for information on jail components, the primary purpose of this section of the design guide is twofold: 1) to identify the major and typical components of a small or medium-sized jail, and 2) to describe how they typically interrelate. Detailed functional and design information about individual components is presented in Chapter 4, along with elaboration on many of the issues raised in this section.

An additional purpose of this section is to review how certain types of functions might occur in the same room or area, that is, to identify jail functions that can share space. This is an important concept for small and medium-sized jails since the infrequency of certain activities sometimes makes space sharing essential to the efficient use of scarce local resources.

JAIL COMPONENTS

If a person documented every possible activity that could occur in a jail, the resulting list would be quite lengthy. Fortunately, not all of these activities have space implications. Many are comfortably managed within major activity categories for which proper space is designed and allocated, and some have no direct space impact at all (e.g., key control and inspections). The major activity categories, or *functional components*, for which dedicated space is needed are described next.

Master Control. Monitors and controls all building communications, safety and security systems, and movement and often coordinates management of emergencies in the early stages.

Intake-release (also referred to as "booking," "reception," and "admissions"). Receives and processes incoming arrestees or inmates and releases outgoing inmates.

Housing-general. Accommodates the individual security, sleeping, hygiene, privacy, and routine personal needs of the main, or general, inmate population of adult males and females.

Housing-special. Accommodates the individual security, sleeping, hygiene, privacy, and unique care needs of special inmate groups (e.g., those in disciplinary detention or protective custody, or mentally ill, suicidal, intoxicated, medically infirm, juveniles remanded as adults, or handicapped) and of inmates who regularly leave and return to the jail (work release or periodic confinement).

Health care. Accommodates the health care needs of inmates, including medical exams, dental exams, testing, distributing medications, sick call, medical records, and storage.

Visiting. Accommodates individual and group contact between inmates and family or official visitors (staff, counselors, attorneys, etc.).

Indoor and/or outdoor exercise. Accommodates the physical exercise needs of inmates in an indoor or outdoor setting, and the storing of necessary support equipment.

Programs/services. Accommodates inmate needs in such areas as recreation, education, counseling, training, library, and religious services.

Food service. Accommodates the receiving and storage of food and food supplies; the preparation, delivery, and consumption of meals; cleanup after food preparation and meals; and removal of refuse.

Laundry. Receives, cleans, sometimes mends, stores, and distributes all reusable personal items used in the facility, such as clothing, linens, bedding, pillows, and mattresses.

Commissary. Accommodates basic inmate needs or wants for such miscellaneous items as pens, paper, toiletries, snacks, and cigarettes (most new facilities are smoke-free and sometimes tobacco-free).

Administration/public. Organizes and manages the daily business of the facility, accommodates public access to the facility, and responds to the public's need for information and services.

Staff. Accommodates the training, hygiene, fitness, and personal needs of facility staff.

Storage. Accommodates the need to maintain various types of equipment, spare parts, and supplies safely and securely.

Maintenance. Initiates preventive maintenance, fixes and replaces worn or damaged equipment and materials, and cleans and maintains existing facilities.

Mechanical. Provides heat, ventilation, and air conditioning; water and waste lines; and main and emergency power supplies.

DEGREES OF DEVELOPMENT

The typical small and medium-sized jail built during the past 10 years has each of the preceding functional components. However, there are significant variations from facility to facility in the degree to which some of these functions are provided, largely because of operational and economic considerations. In some facilities, the functions are minimally developed. As a result, the function has a limited impact on space and equipment requirements. In other facilities, the same components are fully developed and require a complete range of space and equipment. Local officials, planners, and architects must determine needs with respect to each functional component during pre-design planning in order to design and arrange the spaces properly.

Some of the functional components that vary greatly in their degree of development in small and medium-sized jails are listed below. They reveal significant opportunities for space savings and measurably affect the way in which a facility operates on a daily basis. They are discussed further in Chapter 4.

FOOD SERVICE

Some jails have found it more economical to cater food from local restaurants, hospitals, or schools rather than prepare their own meals. This approach can significantly reduce space and equipment needs for food service preparation, storage, and cleanup. Others choose to only serve a cold breakfast and cater the remaining meals, reducing space needs compared to a full-service kitchen operation.

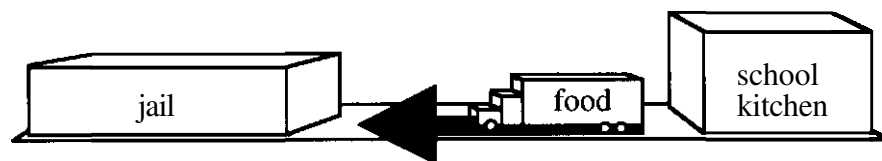

However, with the elimination or limitation of food service space and equipment, new operational and design concerns arise:

- ensuring secure delivery of meals each day, including dealing with non-jail personnel in the delivery;
- maintaining the temperature and quality of food, which may require facilities for re-heating or cooling at the jail;
- distributing the food and, perhaps, providing space for food distribution equipment, storage, and cleanup;
- identifying the source of trays, cups, and utensils and, if the jail is the source, how and where they are accounted for, cleaned, and stored;

- the possibility of losing catering services.

LAUNDRY SERVICE

Some small and medium-sized jails have found it economical to use outside laundry services, thus reducing facility space and equipment needs. Others send some laundry out (sheets, blankets, jail clothing) and wash personal underwear, socks, and non-jail clothing in-house. It is a common practice to have work release inmates do their own laundry at the jail.

Even if laundry services are provided by outside sources, several operational and design issues remain:

- secure delivery of laundered goods by non-jail personnel;
- storage and sorting of the laundered goods, including personal clothing, prior to distribution;
- storage of goods not immediately distributed;
- storage of carts or other devices used in the pickup and distribution of laundered goods (usually a twice weekly clothing/linen exchange);
- laundering at the facility of selected items (such as clothing soiled during arrest) required prior to the next cleaning cycle because of imminent court appearance or release;
- cleaning of non-launderable items such as mattresses;
- loss of contractual services.

HOUSING

To address the chronic problem of providing proper sight, sound, and physical separation between, and appropriate services for, various housing groups in a small and medium-sized jail, some jurisdictions make arrangements with nearby counties to hold selected inmates on a per diem basis. For example, arrangements are often made to house "special" small groups, such as escape risks, violent, protective custody, and women (especially if few women are usually held). Transferring select groups tends to reduce space needs and simplify the design in terms of providing required levels of housing unit separation and observation and management of inmates.

Some jails agree to periodically or regularly hold inmates from other counties. Sometimes this is done on a simple exchange basis; for example, "You take our female inmates, we'll take your special custody inmates." Other times it is done to create a larger, consolidated facility that makes the provision of services and adequate staffing more economical and, thus, more justifiable. Such a "multi-jurisdictional" facility can become considerably larger than a single county operation and can make proper inmate separation easier to attain in a staff-efficient fashion. Future growth of these special

small groups and the possibility that other facilities may decline to take them in the future should be considered when planning the new facility.

COMPONENT RELATIONSHIPS

While each functional component plays a role in the facility and is generally expressed as a distinct, consolidated group of subsidiary spaces, no component operates in a vacuum. The components serve the same body of users and are therefore interrelated to some degree. That interrelationship may require that certain components be next to each other, that some merely be close to each other, or that some be separated from each other. It may require the ability to see, hear, or communicate with another space. Understanding these interrelationships is critical to organizing a jail design efficiently and effectively.

The following graphics identify the typical interrelationships between **all** of the functional components that might be assembled in a jail. While these relationships will probably prove satisfactory for most jails, it must be stressed that *each jurisdiction must set its own criteria for these relationships* and there is plenty of room for variation, no matter how minor.

More detailed information on functional components is given in Chapter 4.

RELATIONSHIP MATRIX

One way to express component relationships is through a matrix. This is a technique using symbols or, in this case, numbers to indicate the nature of a relationship. By reading along the boxes leading from two different components to where they converge, one can find the number describing the relationship between the two spaces. It is an effective form of documentation in that it is very complete and can be as precise as desired. Its weakness seems to be that many people find the format difficult to follow.

RELATIONSHIP DIAGRAM

To some, a more effective way to communicate relationships is through use of a relationship diagram. This is normally a drawing that consists of simple shapes arranged to reflect the relationship of one component to another. That is, if two components need to be adjacent they are drawn adjacent to each other. If they need to be nearby, they are drawn nearby and linked by a line or graphic connector of some sort.

The component shapes in a relationship diagram are frequently drawn loosely enough that they are commonly referred to as "bubbles." Hence the phrase "bubble diagram."

Relationship diagrams are more frequently used than matrixes because they can communicate a greater variety of **information**, such as view connections and external relations or public view conflicts and delivery service access.

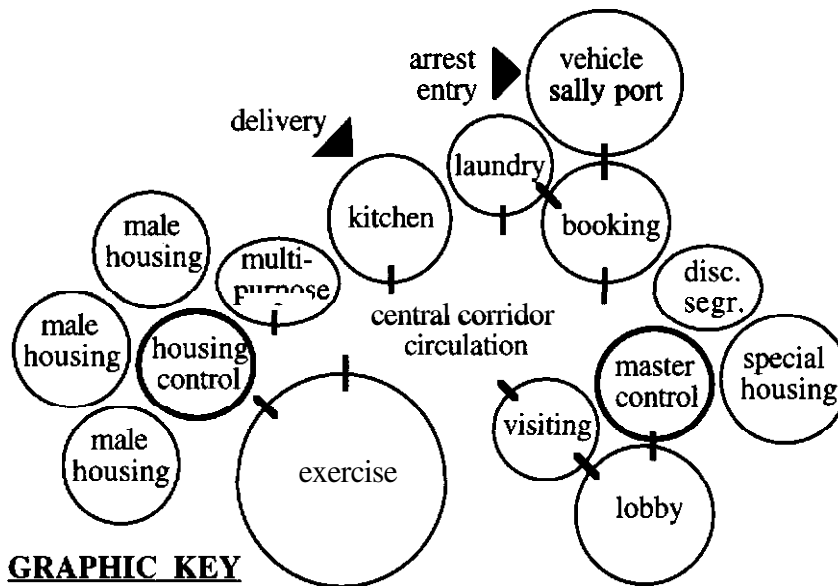

GRAPHIC KEY

- = functional area component
- ◉ = fixed staff post
- ▶ = exterior access
- = primary area access

TYPICAL JAIL RELATIONSHIP DIAGRAM

CRITICAL RELATIONSHIPS

A series of relationships and non-relationships seems to be especially critical in a jail. Some of these involve sub-components of the jail. They deserve highlighting.

Work release and other inmate areas. Since work releases come and go from the jail on a daily basis, there is a high potential for contraband passage between them and the rest of the inmate population. Consequently, work releases must be kept distinctly *separate* from the rest of the inmate-occupied areas of the jail. Each area shared with non-work-release inmates provides the opportunity for hiding of contraband by work releases for later retrieval by non-work-release inmates. Contraband may also be passed to inmate workers during delivery of meals to the work release area or be hidden on meal trays and carts to be taken to other inmates in the jail population. To be effective, separation of work releases should include separate entrances, laundry facilities, and exercise areas. Their area, as noted in the diagram below, is actually outside the secure perimeter of the jail.

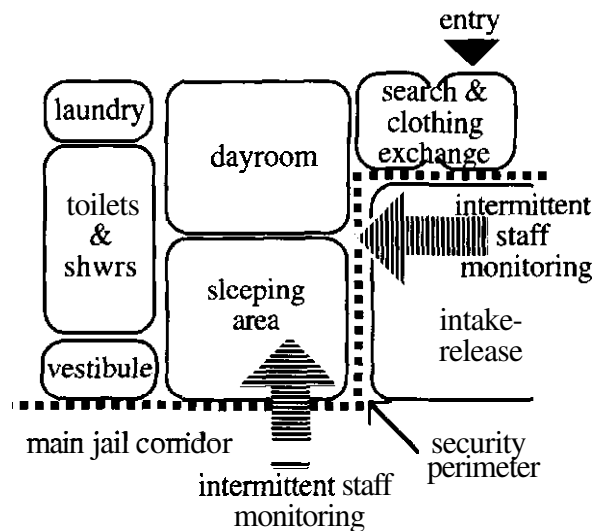

Female housing and male housing. Female housing areas should be physically, visually, and acoustically separate from male housing areas. This requires careful design when the areas are nearby, or placement of the areas in completely different locations within the building.

Control positions and inmate-occupied areas. To assure the safety and security of inmates and staff and reduce vandalism to the facility, Master Control and other staffed positions should be located with a direct view of inmate-occupied areas: housing, visiting, booking, exercise, etc. Constant direct view allows for better control of inmate behavior and reduces incidents that typically occur with intermittent observation -- vandalism, assaults, graffiti, etc.

Arrestee access, intake-release, and control. This set of relationships is critical because of the volume of incoming traffic at booking, the tension and risks involved in the booking process, the presence of officers from other jurisdictions, and traffic associated with the release process. When observing the intake-release operation, Master Control can quickly summon assistance in case of trouble, thereby providing backup for the booking officer.

Public lobby, visiting, and inmate areas. In any jail, it is important to control public access to the secure areas of the facility. Since visiting is by far the most common reason for the public to enter the jail, it is important to locate visiting areas adjacent to the lobby in such a way that visitors enter a controlled area but never penetrate the inmate-occupied zones of the facility (including corridors). (See the earlier section on "Security Perimeter.") If a courtroom is to be associated with the jail, it too should be located adjacent to the public lobby.

Maintenance support spaces (janitors closets) and inmate housing areas. To facilitate daily cleaning, janitor closets need to be located in

close proximity to each inmate housing area. Staff must be able to quickly and efficiently provide cleaning supplies and equipment to inmates to clean their cells and dayroom spaces.

SPACE- SHARING POSSIBILITIES

Some functions occur infrequently and could well take place in the same space at different times. This flexibility, if accommodated by proper design, can save money in facility construction.

Space-sharing possibilities should be examined during pre-design planning and should be judged on the basis of solid functional programming information: function, activity type, scheduling, security, and numbers and types of users. If space sharing still seems a possibility after such an evaluation, the varying architectural requirements should be examined to assure construction compatibility. Some examples of space-sharing possibilities follow.

SPECIAL HOUSING

Compatibility Concept. A common space or spaces could be interchangeably used for the short-term holding of intoxicated individuals, individuals with mental illness, or the temporarily out-of-control inmate. Since smaller jails, in particular, will not often receive mentally ill and out-of-control inmates at the same time, and intoxicated people tend to be received at specific times during the week, it would seem wasteful to create a bank of cells for each of these categories.

Architectural Compatibility Issues:

- Need for spartan space with minimum equipment and protrusions;
- Benches low to the floor (8 inches);
- Security toilet/sink fixture;
- Floor drain (possibly flushing);
- High ceilings;
- Observable from a staff post or frequently passed by staff;
- Need to accommodate personnel and/or crisis intervention workers;
- Sound controlled;
- Specially ventilated;
- Washable surfaces;
- Variable lighting;
- Temporary housing only;
- No particular requirement for natural light; and
- Protection of the inmate from self-injury: rounded edges, padding (if feasible by code, fire safety, and durability considerations), protective clothing for the inmate.

INDOOR PROGRAMS/ SERVICES

Compatibility Concept. A variety of programs and services for inmates may occur on a regular but infrequent basis in a small or medium-sized jail. These might all occur in one or more multi-purpose spaces, depending on scheduling, the nature of the services, and the users:

- Passive recreation,
- Group counseling or meetings,

- Religious services,
- Barbering,
- Recreation and legal library,
- **Disciplinary** hearings, and
- Educational classes.

Architectural Compatibility Issues:

- Acoustical compatibility of various activities with adjoining areas,
- Adequate size to accommodate the most space-consuming activity planned for the area,
- Flexibility in furnishings and equipment,
- Storage for alternative furnishings and equipment,
- **Temperature** **light** **cc** **l**
- **Finishes compatible** with each function,
- **Observability** of space(s), and
- Lack of security conflicts.

GENERAL HOUSING

Compatibility Concept. Since the nature of the population in a small or medium-sized jail can change rapidly, it makes sense to create at least one small housing area that can accommodate a variety of inmate types. Specifically, one or more areas could be designed in such a way as to accommodate either high- or low-security males, or females or males. Such a housing area is sometimes referred to as a "swing area."

Architectural Compatibility Issues:

- Small capacity unit(s),
- Observable from a fixed post,
- Appropriately separated from other housing units, and
- Higher security detailing for flexibility. (Low-security inmates held in the area could be provided less-restrictive custody through management options.)

**CONTACT VISITING
COUNSELING**

Compatibility Concept. Attorney contact visiting, family contact visiting, and counseling all share a need for privacy, small groups, and interaction with the public. The frequency of these activities in smaller jails suggests that one common space or set of spaces can be used, rather than providing separate physical accommodations for each. Attorneys and counselors should be consulted during programming to identify their space needs.

Architectural Compatibility Issues:

- Private space,
- Small-scale space,
- Located in zone between public areas and main inmate-occupied areas, and
- Observable by staff.

**INDOOR/OUTDOOR
RECREATION**

Compatibility Concept. Both indoor and outdoor recreation spaces accommodate the same activities, such as basketball, handball, and weight lifting. The only difference is outdoor recreation is open to the outside -- natural light and fresh air. By creating the ability to close open air access to

the outside, a recreation area can be used as both indoor and outdoor space.

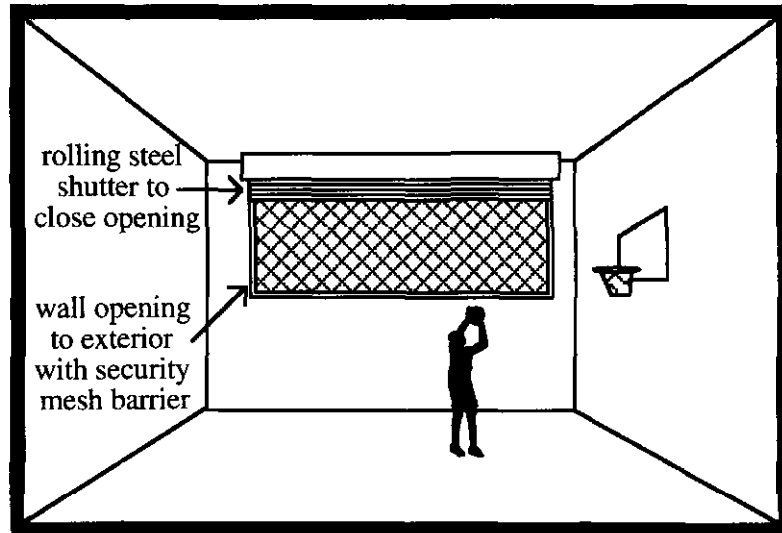

Architectural Compatibility Issues:

- Adequate size to accommodate basketball and exercise equipment;
- Storage for recreational and exercise equipment;
- Heating, cooling, and lighting when used as indoor exercise space;
- High ceiling to allow for basketball;
- Observable by staff;
- Located in close proximity to inmate housing; and
- Sight and sound separation from housing areas to allow use by both males and females at different times.

A SPACE-SHARING PROBLEM

A space-sharing problem occurs where a space used by inmates is also used by the public at other times. For example, there would potentially be a major contraband passage problem if the public had access to a multi-purpose space that inmates would also use later for another program. The visitor could bring nonmetallic contraband into the facility undetected by the normal metal detector, and hide it for an inmate to retrieve later during a program in the multi-purpose area. This problem could be solved by operational procedure (i.e., a thorough area search after use by the public) or by preventing space sharing by the two functions. This type of potential problem should be considered along with space-sharing opportunities as each functional component of the jail is developed.

CONCLUSION

The preceding space-sharing possibilities and issues merit consideration. However, it is important to reiterate that shared space should be carefully determined only after pre-design planning verifies that function, security concerns, scheduling needs, and user types make it feasible.

PLANNING & DESIGNING TO STANDARDS

Designing a jail involves the application of codes and standards developed by various local, state, and/or national agencies. Legally mandated codes and standards require interaction with officials representing the code/standards agencies in order to obtain approvals required to initiate construction. Being aware of applicable codes and standards early in the planning and design process is necessary to a successful project.

Some **people** react negatively to codes and standards as an intrusion into their process and right to do as they see fit. However, all building codes and standards **are** intended to preserve the health, safety, and welfare of building occupants. Standards tend to be ideologically neutral. Virtually all of their content is derived from unsatisfactory and sometimes tragic experiences. They generally represent the collected wisdom of specialists and practitioners in a particular field.

If approached positively and early in the process, standards and codes can be useful tools in establishing safe and proven design parameters. Personnel from standards and code agencies can provide significant help to local officials and designers based on their experience with many similar projects in the **area** and state. Both legally binding and advisory standards are worth reviewing before design, and even before programming begins.

This section identifies standards and legal requirements referenced in the development of this document, as well as those that are particularly relevant to communities about to design a jail.

STATE STANDARDS

In many states, one or more agencies within state government have legislative authority to promulgate and enforce minimum jail standards. These agencies vary greatly in terms of the resources, approaches, and legal authorities they employ. In some states, design and operational standards for jails **are** exceedingly detailed and strictly enforced; the responsible authority has the means to enforce standards up to the point of bringing suit against local governments whose facilities are non-compliant. In other states, the responsible agency may have detailed standards but lacks the authority to enforce them and is relegated to simply encouraging compliance through educational strategies such as training and technical assistance.

In some states, more than one agency has authority over the planning, design, and operation of jails. Often one agency focuses on the planning, design, and construction requirements, while another is primarily charged with establishing operational requirements dealing with non-architectural aspects such as training standards, policies and procedures, and inmate services. Identification and review of state standards and understanding their official role in the development of a proposed jail project are essential.

ACA COMMISSION ON ACCREDITATION STANDARDS

Persons both within and external to the field of corrections sometimes erroneously refer to the standards published by the American Correctional Association and Commission on Accreditation for Corrections as mandated "national" or "federal standards." While this is understandable, it is essentially incorrect. The ACA and the Commission on Accreditation for Corrections (CAC) are private, nonprofit organizations that administer the only national accreditation program for all components of adult and juvenile corrections. Their purpose is to promote improvement in the management and design of correctional agencies through the development and revision of useful standards. It is an effort supported by the corrections profession. The standards have benefited from contributions by practitioners throughout the nation.

Neither the ACA nor the CAC have the authority to mandate or enforce compliance with the standards. Agencies that voluntarily opt to participate in the CAC's formal accreditation program are required to comply with certain eligibility criteria and enter into an accreditation contract. Any new architectural design, building, and/or renovation of an institution must be done in accordance with the standards current at the time.

In some states, the laws affecting jails are dated and limited in their scope and applicability to modern jails. In others, no state agency is charged with the enforcement of statutes or standards relative to jails. Therefore, there is little guidance available to local officials and jail staff who are responsible for the funding and operation of local jails. In such cases, the ACNCAC standards for adult local detention facilities represent a logical set of physical plant and operational criteria upon which to base the planning, design, and operation of a new jail.

ACNCAC standards pertaining to city and county jails or detention facilities at the time of this writing are published as the *Standards for Adult Local Detention Facilities*. A *Supplement* is periodically published to document additions, revisions, deletions, and/or interpretations for all ACNCAC standards manuals.* Users of the ACNCAC standards must review both the prevailing base standards document in its most recent edition as well as the most recent supplement.

Whether or not a local community formally participates in the ACNCAC accreditation program, which requires entry into a contract and payment of an accreditation fee, the *Standards for Adult Local Detention Facilities* represents an excellent tool against which to evaluate their jail operations and facilities. As stated in the Introduction to Accreditation section of the *Standards* document, "The recognized benefits of such a process may include improved management; increased accountability and enhanced public credibility for administrative and line staff; safer and more humane environment for personnel and inmates; and the establishment of measurable

* In addition to detention standards, ACA/CAC publishes standards in most other areas of adult and juvenile corrections, including prisons, probation and parole, and community residential facilities.

criteria for upgrading programs, personnel, and the physical plant on a continuing basis."

NFPA LIFE SAFETY CODE

Established in 1896, the National Fire Protection Association (NFPA) is the leading nonprofit organization dedicated to protecting lives and property from the hazards of fire. The NFPA publishes hundreds of nationally recognized codes and standards including the *National Electrical Code* and the *Fire Protection Handbook*, as well as numerous fire-service training and fire-safety education materials.

The NFPA *Life Safety Code* represents the most authoritative and widely used resource available to planners, architects, engineers, building and fire officials, safety personnel, and manufacturers whose responsibilities include fire and life safety. The *Code* is organized into six major parts, with the first part consisting of "base" or "fundamental" chapters. Many of the provisions of these base chapters are mandatory for all types of occupancies. The term "occupancies" basically refers to buildings of different types and varying uses. Of special value to those designing a jail are the chapters on "New Detention and Correctional Occupancies" and "Existing Detention and Correctional Occupancies."

In addition to the *Life Safety Code*, the NFPA publishes the *Life Safety Code Handbook* to provide additional clarifying commentary and illustrations to help users of the Code understand and apply Code requirements. The *Handbook* also explains changes to the Code since the previous edition.

NFPA publications and training seminars are excellent resources, but the NFPA does not have the authority to enforce compliance with the Code or other recommendations. However, many state and local building regulatory agencies have adopted the Code in whole or in substantial part, thereby giving the life safety requirements of the Code the force of law in jurisdictions under their purview.

It is important to consult applicable federal, state, and local laws and regulatory agencies that are relevant to the planning and design of jails. The NFPA is clear that it does not endorse compliance with its Life Safety Code in cases where Code requirements are at variance with other laws with which a local project must achieve mandatory compliance.

AMERICANS WITH DISABILITIES ACT

Originally passed in 1990, the Americans with Disabilities Act (ADA) (42 U.S.C. 1201 et seq.) seeks to protect individuals with physical and mental disabilities from discriminatory practices in employment, public services, transportation, public accommodations, and telecommunications services. The ADA extends comprehensive civil rights protections to individuals with disabilities similar to those provided to persons on the basis of race, sex, national origin, and religion under the Civil Rights Act of 1964.

Title II of the ADA, which became effective on January 26, 1992, prohibits discrimination on the basis of disability in services, programs, and activities

provided by state and local government entities. Section 202 of the ADA extends the nondiscrimination policy of the Rehabilitation Act of 1973, as amended (29 U.S.C. 794), which prohibits discrimination on the basis of disability in federally assisted programs and activities by **all** state and local government entities regardless of whether such entities receive federal funds. Most programs and activities of state and local governments are recipients of financial assistance from one or more federal agencies and are already covered by Section 504.

Section 504 of the ADA requires that the Architectural and Transportation Barriers Compliance Board issue minimum guidelines to assist the **Department** of Justice (DOJ) and the Department of Transportation in establishing accessibility standards under Titles **II** (pertaining to state and local governments) and **III** (pertaining to private entities who own, lease, lease to, or operate a place of public accommodation).

The Board has published the *Americans with Disabilities Act Accessibility Guidelines (ADAAG)* to assist the DOJ in establishing accessibility standards for new construction and alternatives in places of public accommodation and commercial facilities. In 1992, the DOJ issued proposed Rules for Courthouses (Section 11), and Detention and Correctional Facilities (Section 12). At the time the DOJ published its proposed rules for Title **II** facilities, it indicated that the Board would be further supplementing the ADAAG to include the comments and suggestions for "scoping requirements" for justice facilities and other types of facilities. In 1994, the DOJ issued the "Interim Final Rules" that included Sections 11-12 governing Courthouses and Correctional and Detention Facilities. Local leaders and planners should research the latest requirements of the ADA as they evolve prior to, and during, design.

Several general points should be made about the ADA regarding its impact on jail planning and design.

1. ADA facility requirements are applicable not only to proposed new jails but existing jails to the extent that accommodations to meet the ADA rules are adjudged "readily achievable."
2. Since ADA prohibits discrimination based on disability, literally every inmate classification (maximum, disciplinary, protective custody, female, etc.) must be accommodated in housing area design. This affects all spaces including:
 - cells,
 - dayrooms,
 - vestibules,
 - shower areas,
 - toilet areas, and
 - exercise or other support areas at housing.

It also affects furniture, hardware, and equipment in housing areas:

- desks and tables,
- seating,
- beds,
- shower fixtures (grab bars and seats),
- toilet fixtures (grab bars),
- sinks,
- mirrors,
- shelves/storage,
- alarms,
- communications,
- doors (width and clearances surrounding the door),
- door handles,
- televisions, and
- telephones.

As awareness of design issues for inmates with disabilities has grown, an increasing number of products have become available to meet ADA requirements.

3. Virtually all areas generally accessible to inmates are affected by ADA requirements, such as exercise, booking, programs, health care, food service, and laundry areas.
4. ADA requirements apply to jail staff and the public as well, therefore affecting all areas of a facility.
5. The ADA covers a wide range of disabilities. While the needs of people in wheelchairs receive primary attention from most designers, other disabilities like hearing and sight impairments also demand design attention.

There is no substitute for detailed and thorough research into the documents that govern the base legislation forming the ADA and that continue to record its evolution. Local governments undertaking jail projects must avail themselves of these resources and should consider acquiring the professional services of consultants, architects, and engineers with experience implementing the requirements of the ADA.

CONCLUSION

Standards and codes are a significant factor in the design of a new jail. Applicable standards and codes should be identified early and applied even before design commences, i.e., during pre-design planning. Local code or standards officials can be an asset to the facility development process if involved early.

Special standards by national organizations can serve as a major supplement to required state or local codes. Jurisdictions should research these and avail themselves of the expertise they represent.

EXPANSION

A jail is a large capital expenditure for a community. It is paramount that the facility have a long and useful life. The key to ensuring the jail's longevity is to plan for future expansion.

WHY PLAN FOR EXPANSION?

Many communities have the foresight to build a jail that not only meets their capacity needs today, but also their projected needs 15 to 20 years into the future. Sometimes these projections are correct, but sometimes they are not. Developing bed capacity projections is not entirely precise because key assumptions that go into formulating the projections may change. For example, the jurisdiction's population may grow or its crime rate may increase faster than anticipated.

Totally unforeseen factors may also affect the size of the jail population. Recently two phenomena -- mandatory sentences and overcrowded state prison systems -- have increased jail populations, forcing many jurisdictions to build **additional** beds they never thought they would need. Sometimes the additions are needed within a few years after a new jail opens.

Failing to develop an expansion plan can have significant consequences to a community in terms of public safety and its budget. For example, if the jail does not have the ability to expand because of design or site constraints, it could be rendered obsolete because it does not meet the jurisdiction's capacity needs. If the facility is relatively new, say less than 15 years old, it may be difficult to persuade taxpayers to approve funding for a new jail. If that happens, the jurisdiction may be forced to crowd the jail beyond its capacity -- to the detriment of safety and security -- or board inmates in other jurisdictions at considerable expense.

EXPANSION OPTIONS

A number of basic options are available to local jurisdictions as they plan their expansion strategy.

Satellite Jail

Many jurisdictions have built satellite jails as an adjunct to their existing jail. Typically, they have pursued this course because:

- site constraints do not permit expansion of the existing jail, and
- the existing jail is relatively new and it would not be prudent for political **and/or** fiscal reasons to discontinue its use.

A satellite jail is generally not considered a good expansion option for a small jail system because it is relatively expensive. Costs **normally** associated with a satellite jail are:

- Site Acquisition -- Purchase of a new site could be required if the jurisdiction does not own a suitable parcel of land.

- Duplicate Building Components -- Several components of the existing jail cannot be shared with the satellite jail, such as exercise and visiting areas, and must be replicated.
- Duplicate Staff -- The jurisdiction will lose some staffing efficiency by have some duplicate staff, such as shift supervisors, in two facilities.

Double Bunking

Many jurisdictions see the double bunking of single cells as an expansion option because it can quickly and inexpensively increase capacity. However, it has several major drawbacks, which are discussed at length in the section entitled "Single vs. Multiple Occupancy" in Chapter 5.

Planned Additions to the Jail

Constructing additions to the jail, such as building new housing pods, is the preferred expansion option because it is less expensive and more staff efficient than building a satellite jail. It is preferred to expansion through double bunking because the fundamental security and management capabilities of the initial construction can be maintained.

WHEN TO DEVELOP AN EXPANSION PLAN

Planning for expansion should begin *during pre-design planning* and continue through the development of the facility program because the expansion plan will affect site selection, design, and operations of the jail. It is important to realize that the expansion plan will greatly affect the initial design of the jail because it will tell the architect how each component will grow and by how much. The architect must then arrange and design the components to allow for that growth. The expansion plan will assist with site selection because it will give the architect information needed to determine ultimate building square footage demands as well as off-street parking needs.

The expansion plan should contain the following information:

- the expansion capacity of the facility (generally, the ultimate bed capacity of the jail);
- how each component of the facility should expand and by how much (in terms of cells, square feet, equipment needs, or policy changes); and
- the parking expansion capacity

SETTING EXPANSION CAPACITY

One method for setting expansion bed capacity is to use bed capacity projections developed during the needs assessment step of pre-design planning. If initial capacity is based on a projection of 15 years into the future, it would be reasonable to use the same data to project a capacity 25 to 30 years into the future for the expansion capacity. Another reasonable method would be to simply double the initial capacity.

VERTICAL VS. HORIZONTAL EXPANSION

No matter what method or expansion capacity number is chosen, it is best to err on the high side. The expansion plan by no means commits the jurisdiction to build additional beds. But if additional capacity is ever needed, it can be accommodated by the building and the site.

Additions to a jail can be built in basically two ways -- vertically or horizontally.

Vertical expansion assumes that future expansion will be constructed on top of the existing jail. In the case of housing, expansion is typically planned to be built on top of an existing housing pod, with the new pod having the same basic design and perimeter wall footprint as the pod below. With horizontal expansion, it is assumed that expansion construction will be adjacent and contiguous to the existing building.

The major benefit of vertical expansion is that a smaller site can be used because the expansion will take place on top of the existing building. This may be desirable if the jail is to be built on a small downtown site. However, several drawbacks to the vertical expansion approach should be considered:

- ***Initial design may adversely affect design of future expansion.*** If housing expansion is going to be constructed above an existing housing pod, it is normally assumed that the future pod will be designed like the pod below. This could, however, adversely affect the design of the expansion housing by eliminating design flexibility.

For example, assume that the vertical expansion plan calls for a dormitory to be built above an existing dormitory but, because of changing circumstances, a high-security housing pod with single cells is needed instead of a dormitory. Unless there is major renovation to the dormitory, the high-security housing cannot easily be built above it because the locations of interior plumbing and mechanical chases are not compatible with high-security housing.

In the same vein, jail standards could change from the time the jail is built to when expansion is needed. New standards may dictate different requirements for cell size, dayroom size, number of showers per inmate, etc. Like the above example, the housing area below dictates design of vertical expansion housing to a great extent.

Horizontal expansion, on the other hand, can provide flexibility. It will not be constrained by an existing building footprint or the plumbing and mechanical chases of a housing unit below.

- ***Higher Initial Construction Cost.*** If vertical expansion is to be used, initial construction costs for the structural elements of the building will be higher because the structure (columns, beams, etc.)

must be designed and built to also support the weight of the future expansion construction.

- ***Disruption to Facility Operations.*** Vertical expansion will disrupt facility operations during construction. Construction workers, tools, and equipment will need to be inside the security envelope. If housing is to be built on top of an existing housing area, that area may have to be vacated during construction. This would be extremely disruptive because beds could be eliminated for a long period of time.

EXPANSION CONCEPT FOR EACH COMPONENT

The expansion plan should not only include an expanded bed capacity, but also an expansion concept for every functional component of the jail. These expansion concepts will tell the designer how each component will accommodate future capacity requirements and will, in turn, begin to dictate design and location. Considerations and options for expanding each component follow.

- ***Master Control.*** Allowance must be made for future control systems and panels. If the control system is computerized, expansion can be accommodated by adding control screens to the monitor; this does not require much if any additional space. If a hardwire control system is used, then space must be allocated during initial construction for panels that will control future locks and intercoms. Since this component is typically buried within the core of the building, it is difficult to expand without major renovation and disruption to operations and should be initially sized to accommodate expansion capacity.
- ***Intake-Release.*** This component should be sized to accommodate the expansion capacity of the jail because it must be continuously available for the intake and processing of arrestees. Renovation or expansion of this area would be extremely disruptive.
- ***Property Storage.*** Many jails store inmate property in garment bags, and expansion of this component can be achieved in several ways. First, the area could be oversized to accommodate additional hanging racks at a later date. Second, a tiered hanging rack could be used, where the lower tier could accommodate the initial capacity and the upper tier the expansion capacity. Third, the space could be designed to accommodate a hanging conveyor system similar to that found at a dry cleaning establishment. A conveyor system allows property bags to be stored more compactly, thus saving square footage. Space for the storage of bulk property items should be sized for expansion capacity.
- ***Health Care.*** This component could be designed for expansion capacity or it could be designed for initial capacity and expanded when the need arises. If the latter expansion option is chosen, the

health care component should be located on an outside wall so that expansion does not infringe on adjacent components.

- **Visiting Areas.** Visiting areas are typically located within the core of the jail making physical expansion difficult or, at worst, impossible. Visitation can be expanded without enlarging the area by increasing the visitation schedule. For **example**, if visitation is scheduled two times a week, it could be expanded to four times a week, thereby allowing twice the number of inmate visitation opportunities.
- **Exercise Areas.** Expansion of this component can occur in two ways. First, the number of hours the exercise area is available for use by inmates can be expanded. Second, new exercise areas can be built as part of housing expansion rather than enlarging existing exercise areas.
- **Programs and Services.** The number of hours per week programs and services are offered can be increased if there is time available on the schedule. Otherwise, new space would be needed for expanded needs.
- **Inmate Commissary.** Expansion can be accommodated by building the commissary large enough for a high-density storage system at a later date or by placing it on an exterior wall so that it can be physically expanded.
- **Food Service.** Extra space can be provided for the addition of equipment when bed capacity is expanded, or the **kitchen** can be placed on an outside wall and physically expanded. Physical expansion of this component, however, can be difficult given the precise arrangement of equipment into specific work areas: **storage/receiving**, food preparation, **cooking**, meal traying, and cleanup. Special mechanical considerations **like** exhaust ventilation, gas lines, drain lines, etc. also make space expansion difficult.
- **Laundry.** The laundry operation can be expanded by increasing the number of hours of operation, by providing space for additional equipment when capacity is added, or by placing the laundry room on an exterior wall and physically expanding it.
- **Lobby.** The lobby is typically sized for the expansion capacity of the facility.
- **Administration Area.** The administration area can be sized to accommodate the ultimate number of staff or the area could **be** placed on an exterior wall and physically expanded. It is always a good idea to design extra square feet or an extra office into the area as part of the initial construction because additional administrative staff are often added before jails reach the point of expansion.

-
- *Staff Areas.* Locker rooms are typically sized for expansion capacity and the ultimate number of staff. However, they could be placed on an exterior wall to permit physical expansion.
 - *Storage Areas.* Some storage areas can be added with additional housing. For example, it may make sense to build a new mattress storage or linen storage area as part of new housing expansion so it can be located closer to the housing areas it serves. Another alternative is to use high-density storage systems at a later date if feasible. Some storage capabilities that do not involve great security concerns might be provided by separate stand-alone buildings.

CONCLUSION

The future is difficult, if not impossible, to predict. Jail expansion concepts that are easy to execute, cause minimal disruption to the existing day-to-day operations, and permit flexibility in future design will serve the community for decades to come.

4

DETAIL FUNCTIONAL COMPONENTS

4 DETAIL FUNCTIONAL COMPONENTS

This chapter contains detail functional and design information on the major functional components of a jail to provide local officials and planners with a sound background in the fundamental issues, characteristics, and concepts of each major component. This information should help local sheriffs, commissioners, and planners create a solid foundation from which to develop a detailed set of plans responding to unique local jail needs.

All of the sections are organized alike. The following kinds of information **are** provided for each functional component:

- description of the function,
- key decisions to be made,
- detail functional requirements and design impacts,
- space list,
- relationship diagrams, and
- component diagrams.

The concepts dealt with previously regarding staffing, management, security envelope, etc. are discussed throughout the functional component sections and expressed in all illustrations provided in support of the text. This link is critical because, as the following pages show, a design is truly the result of the functional and operational needs of facility users -- needs that are determined during pre-design planning.

MASTER CONTROL

DESCRIPTION

The basic function of Master Control is the monitoring and control of all communications, life safety and security systems, and all general building movement patterns, including entries and exits through the main security envelope of the jail. In small jails, Master Control (also referred to as "Central" Control) may serve as the only secure, fixed staff post within the facility and is truly the "nerve center" of the operation.

Master Control may also function as a point from which some inmate housing units (cellblocks) or other inmate or public areas are monitored. It might also be combined with the law enforcement dispatch function and handle public reception during some or all shifts.

Small jails have traditionally had some sort of control center even if it only consisted of an unprotected control panel in a relatively insecure room. Often the only reason the control post was staffed 24 hours a day was because it also doubled as the dispatch center for the law enforcement agency affiliated with the jail.

The minimum acceptable staffing in any jail is two people. This permits one staff person to handle Master Control post duties while the other serves as a rover or floor officer. Staff often take **turns** in Master Control. The concept of having at least two staff on duty is essential when a Master Control area is maintained since the person at that post cannot leave, thus necessitating the presence of an additional person. However, two staff should be viewed as the minimum necessary on each shift to staff Master Control and carry out basic minimal supervision of a small jail population only if other issues such as adequate back-up in emergencies and gender-related requirements are adequately addressed. Medium-sized facilities in the range of 50 or more beds clearly need more than two staff.

KEY DECISIONS

As the role of the Master Control component is evaluated, the following decisions should be made since they have a fundamental effect on design requirements.

- Will the Master Control function be combined with the *law enforcement dispatch* function? Can both jobs be done by one person throughout the life of the facility? Are they compatible in terms of security since the loss of Master Control to an inmate takeover would also mean the loss of all law enforcement communications?
 - Will Master Control only monitor electronic security and safety systems or will it have *other responsibilities*, such as lobby reception, housing area surveillance, intake-release area surveillance, record keeping, answering outside telephone calls, supervising visiting, or receiving packages? That is, what are Master Control's responsibilities -- and can one person do the job?
-

- Where must the Master Control space be *located* to function effectively in conjunction with other facility activities and still be adequately protected from assault?

DETAIL ISSUES

The following detail functional/architectural issues should be considered in the development of the Master Control component.

USERS

ISSUE: Use of the Master Control center should be principally limited to Master Control staff.

RESPONSE: The need for security in the Master Control center clearly precludes access to the space by inmates or the public, but access by jail staff should also be limited. Routine communications and contact between Master Control and other officers should be accomplished through intercoms, pass-throughs, etc., rather than through entry into Master Control. The control center should not serve as the focal point for staff breaks or periods of inactivity, as it does in many facilities.

ACTIVITIES

ISSUE: Master Control functions must be identified and priorities set in terms of tasks and workload responsibilities.

RESPONSE: Experience with newer jails has shown that it is easy to overburden this vital position. The original small jail research revealed that facilities with more than 20 beds began having noticeable difficulty effectively using a single Master Control person for many jail functions when that person also did law enforcement dispatching.

Sample Master Control jail functions:

- Monitoring electronic surveillance systems (audio, CCTV).
- Controlling entries to, and exits from, the security envelope
- Monitoring various building systems (radio, surveillance alarms, perimeter lighting, and other mechanical and electrical systems).
- Serving as the communications center for the facility, including receiving and/or handling telephone calls.
- Maintaining and monitoring necessary security/safety equipment, such as fire alarms, smoke and thermal detection systems, self-contained breathing apparatus, keylock box, flashlights, and storage for riot gear (e.g., batons and restraints).
- Monitoring and assuming responsibility for inmate counts.
- Producing and/or managing jail records and logs.

- Distributing keys, logs, walkie-talkies, flashlights, and other equipment to staff.
- Exchanging packages and paperwork with the public and mail with postal workers, and receiving bail and commissary monies.
- Monitoring staff shift changes, including identification checks and logging of arrivals and departures.
- Providing surveillance of adjacent housing units and inmate activity areas.
- Providing surveillance of special temporary holding areas, such as those for the mentally ill or intoxicated.
- Providing primary or backup observation and/or monitoring the:
 - public lobby or night vestibule (i.e., public access);
 - main jail corridors;
 - elevators;
 - housing units;
 - visiting (public, attorneys);
 - vehicle sally port;
 - intake-release area;
 - temporary holding cells;
 - multi-purpose or indoor exercise room;
 - outdoor exercise areas;
 - storage of bond monies and legal documents; and
 - storage of prescription medicines and first-aid kits.

Sample Master Control law enforcement-related functions:

- Radio dispatching of patrol cars;
- Receiving incoming department telephone calls;
- Handling of 911 emergency system;
- Dispatching ambulance services;
- Coordinating emergency disaster dispatching;
- Monitoring fire alarms and burglar alarms at local businesses and institutions;
- Record keeping and computer data entry; and
- Managing national, state, and/or local criminal data systems.

It should be clear that combining the many functions just described for law enforcement with those for the jail would create an unmanageable situation for one person to handle on some or all shifts. However, with staff at a premium, good planning should attempt to get the most from the Master Control post without sacrificing facility security and staff and public safety.

A full evaluation of Master Control workloads is warranted. Such an evaluation should take into account *future change* and workloads since Master Control may someday require two people rather than one on certain shifts. In combining the functions of Master Control and dispatch, be

aware that all control of the jail and **all** security and communication links within the county may be severed if the space is overtaken by inmates.

SECURITY

ISSUE: Master Control should be able to control the entire facility if necessary.

RESPONSE: In the event of a disturbance, a fire emergency, or an equipment breakdown, Master Control should be able to secure and control the facility. For example, if there is a second housing control post or panel by which other staff supervise or manage a housing area, Master Control should have the operational capability to override those controls if need be.

In fulfilling the backup role, it may be necessary for Master Control to release multiple cells simultaneously, remotely open housing unit **dayroom** doors, and allow egress of inmates to a safe holding area. As a primary function, Master Control must be able to remotely allow entrance of emergency personnel into **all** areas of the building. Master Control should also maintain a set of master jail keys for manual override of locking mechanisms in case of a power loss (although emergency power generation should be a feature of all jail designs).

ISSUE: Master Control must be of fundamentally secure construction to preclude access by inmates and the public.

RESPONSE: Since Master Control is the "nerve center" of the jail and may also contain the law enforcement communication center, the creation of a physically secure space is vital. A secure envelope must be created for Master Control; that is, the walls, floor, and ceiling of Master Control must be constructed of secure materials.

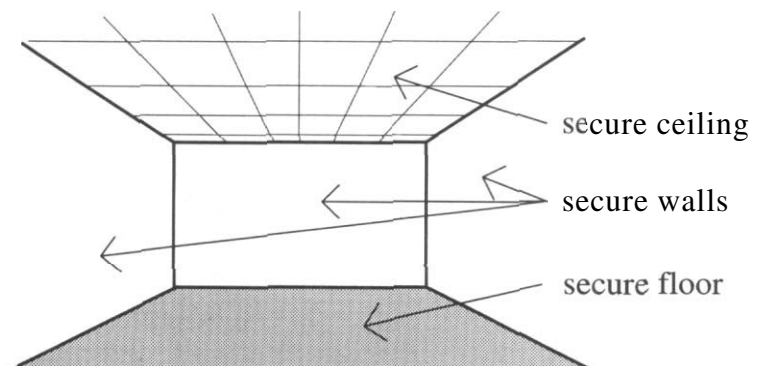

A secure ceiling is particularly important since many buildings have a ceiling plenum (an area between the ceiling and the roof or floor above for structural beams, ductwork, electrical conduit, etc.). If inmates penetrate the plenum, **they** might gain access to Master Control through the ceiling unless the ceiling is of secure construction (concrete, steel decking, cement plaster with metal lath, for example). **An** alternative to secure ceiling construction

is to extend the security walls of the space up past the ceiling to the floor or roof construction above.

Selection of the correct *security glass product* is also essential to creating a secure envelope. In selecting detention glass, remember that no security glass product is impenetrable or shatterproof, only penetration-resistant and shatter-resistant. Penetration resistance is the primary need in Master Control since the glass must at least delay, if not prevent, unauthorized access. Shatter resistance is a lesser, though still important, issue. Glazing panels should be as wide as possible to maximize view without **interruption** by normally thick security framing. Panel height should be examined carefully where vertical view relationships are important.

ISSUE: All openings into Master Control must be secure.

RESPONSE: Besides the obvious opening of the entry door, other critical openings that must be securable include pass-throughs, air supply openings, and electrical openings.

Secure entry is often handled by creating a vestibule into the Master Control area. The doors to the vestibule are normally "interlocked," i.e., they cannot both be opened at the same time unless the interlock is purposely overridden (a capability that should exist). Doors normally swing inward so the Master Control officer can barricade them shut if need be.

A vestibule created solely for access to Master Control requires valuable square footage and can impede views to other areas. One approach in response is to allow the vestibule entry to the secure perimeter (which is frequently adjacent to, and monitored by, Master Control) to double as the secure entry to Master Control.

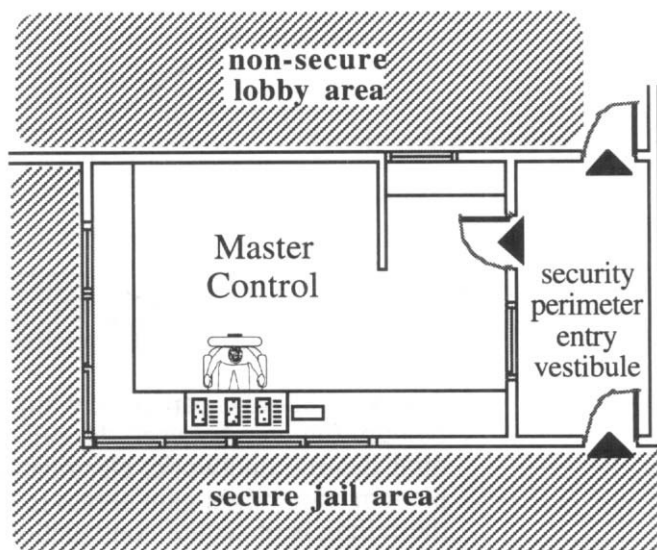

Another important issue in a small or medium-sized jail where there is frequently only one Master Control officer is to provide a means of access to Master Control in case the officer becomes incapacitated. One such means is a key kept in another secured area that is readily accessible to authorized staff.

Pass-through openings for keys, packages, walkie-talkies, and paperwork, and to prevent the introduction of such dangerous items as chemical agents, explosives, or firearms, should prohibit opening by anyone but the Master Control officer.

Openings for heating and air conditioning ducts and *electrical openings* for light fixtures and outlets should also be secured to prevent access.

ISSUE: All power, communication, and computer lines outside the Master Control space must be secured.

RESPONSE: It would do little good to secure the Master Control space if the sources of its power and capabilities were vulnerable. Consequently, the electrical, mechanical, and emergency power sources for the facility must be protected. If control center computers are housed in a room outside of the Master Control area, they must also be secure.

Electrical panels that contain relays, switches, and wiring for control systems must also be protected, as must the electrical lines carrying power between Master Control and the locks, intercoms, and monitoring systems under its control.

VIEW

ISSUE: The design should allow effective visual observation of areas where monitoring by Master Control is desired.

RESPONSE: If Master Control is to provide backup or principal monitoring of an area, a *direct line of sight* to that area should be created wherever possible in lieu of reliance on CCTV monitoring. This is more effective and has the secondary benefit of letting inmates know they are under observation.

A difficulty with providing direct visual observation of various activities from Master Control arises if Master Control is expected to *observe too many things*. When this occurs, Master Control can become an overly large and unwieldy space in order to be next to, or in view of, everything. As the planning team increases Master Control responsibilities and the control space gets larger, the precise location of the Master Control staff and equipment must be determined. The desired view and the proximity of Master Control to different spaces may not be attained when the actual location of the staff position is established. Unanticipated blind spots or excessive movement away from the control panel may compromise staff's ability to view key areas.

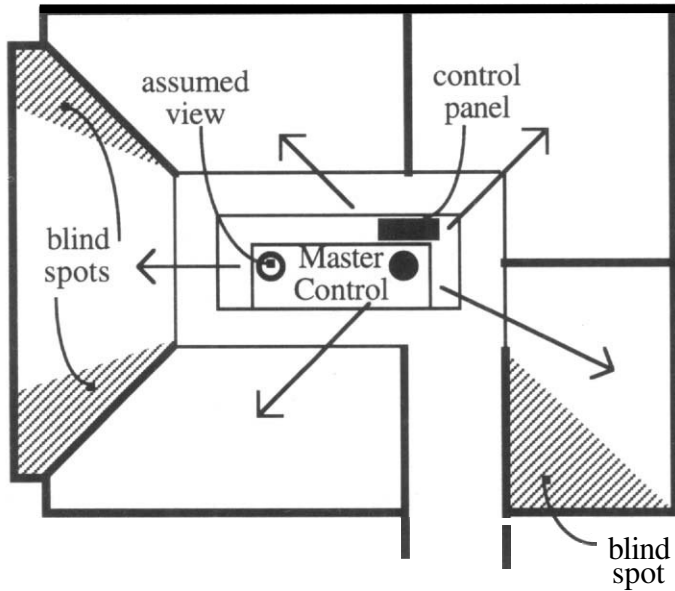

ISSUE: Views into and through Master Control should be controlled.

RESPONSE: When Master Control becomes the hub of a series of adjacent activities that it monitors, the prospect of view *conflicts* between spaces arises. Inmates may see through Master Control to public areas, be able to view control boards and computer screens in Master Control, or be able to view or communicate with inmates of the opposite sex in other areas.



View from lobby of Master Control CCTV monitor and into the jail.

Several approaches can be taken to prevent these problems.

- Minimize the potential for view conflicts by minimizing the number of areas that must be directly observed by Master Control.
- Use equipment or partitions in Master Control to screen views.
- Raise the floor height of Master Control to help limit views.

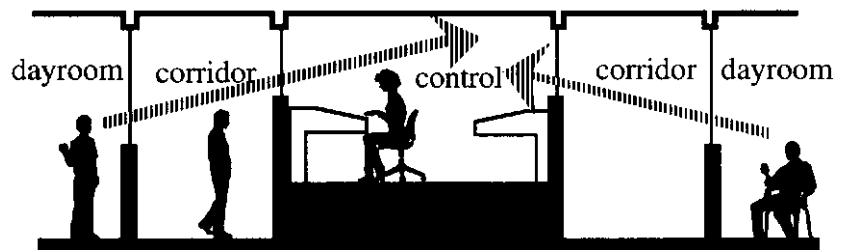

With this technique, it is important to ensure that the control platform is not so high that it eliminates a line of sight between the Master Control officer and the floor officer or between the Master Control officer and inmates in adjacent areas. The ability to conveniently communicate and pass logs, keys, and other items between Master Control and roving staff should be preserved. In establishing proper floor height and sight lines, be sure to factor in the location and height of control panels and television monitors.

- Selectively apply reflective, one-way, or tinted glass to the Master Control area or the inside of the rooms from which view conflicts arise. However, such glass severely limits contact and interaction between Master Control and inmates, the public, and other staff. Tinting or minoring also impacts the intensity of lighting required in adjacent spaces to be monitored by Master Control. If tinting is not uniformly applied to all Master Control glass panels, internal light reflections off the glass can erode view quality.

Another critical view conflict often arises in small jails when *non-jailer dispatchers* operate Master Control and become uncomfortable at being visible to inmates. Their response is often to screen themselves from view, thus defeating the location and design of Master Control.

The solution here may be in the selection and training of staff, not in the design. See the section on "Criminal Justice Interface" in Chapter 3.



Blinds used by Master Control staff block view of staff by inmates, but defeat location and design of the space.

**DESIGN
EFFICIENCY**

ISSUE: Master Control must be laid out efficiently.

RESPONSE: Control panels should be within easy reach of the officer.

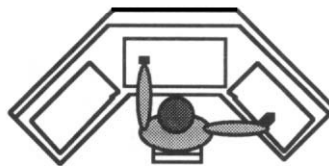

desirable

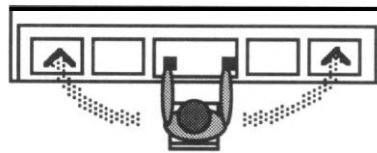

not desirable

Control panels can be organized independently of each other by function (locks, lights, intercom) or together on one panel by the physical location in the building to which the functions correspond (locks, light, intercom grouped together by space -- dayroom, cell, etc.). They can also be organ-

ized on computer monitors through the use of "touch screen" technologies.* With this approach, separate panels are replaced by separate screens using a single monitor.

Grouping frequently used controls by the location to which they correspond is more efficient, although it can be more costly and complicated to install and can result in very large panels if a "hard-wired" system is used rather than a computerized "touch-screen" system.

It is important to the design to determine whether the staff will *sit or stand*. If the nature of the post requires frequent movement around the space, standing -- or sitting on a high stool -- might be preferred over a low seat. This decision must be coordinated with decisions regarding the design of control panels, and the sill and head heights of glass view panels in the walls of Master Control.

If control staff are constantly leaving their equipment and moving around the Master Control space to do all the jobs required and to obtain all the necessary views, the Master Control task may become quite frustrating and inefficient. It might be better to reduce control functions and switch duties to other staff.

Ready accessibility to such things as life safety annunciator panels, bulletin boards, inmate location charts, post orders, and egress plans frequently demands that some *solid wall space* be provided in Master Control. Thus, it is difficult to provide a totally efficient, fully glazed space. This may be beneficial, though, since it can be overly stressful to work in what some refer to as a "fish-bowl" environment.

ENVIRONMENT

ISSUE: The Master Control environment should reduce stress and fatigue and enhance control activities.

RESPONSE: *Sound-absorbing materials* such as carpet and acoustic ceiling tile can reduce sound reverberation (echoes) and the harshness of sound that could easily result from the incessant noise of Master Control equipment.

Temperature and ventilation are critical considerations since the equipment within Master Control frequently generates excessive heat. To alleviate this problem, it would help to make special or separate provisions to cool and ventilate the Master Control space and to give some control over these conditions to the staff. Separate provisions also aid security since they make Master Control less vulnerable to attack and help eliminate unwanted sound transmission from inmate-occupied areas that can result from improperly designed duct work.

* Hard-wire systems rely on buttons and wires for each lock, camera, intercom, etc. Touch-screen systems tend to rely on a computer monitor with multiple screens and symbols representing functions, with coded signals being sent through a few wires to the lock or other function involved.

Direct and indirect lighting that can be controlled in intensity by the Master Control officer is helpful in minimizing eyestrain by reducing glare and reflections from control panels and glazing. It also helps balance light levels between TV monitors, panel lights, adjacent rooms, and the Master Control area.

While frequent staff breaks are recommended, Master Control staff should be able to get a drink of water and use **restroom facilities** without leaving the Master Control space. Therefore, having such facilities accessible from within Master Control is very desirable. A place for a coffee pot may also be desirable.

COMMUNICATION

ISSUE: Easy communication should be provided throughout the facility.

RESPONSE: Master Control should be linked by **telephone or intercom** to all key areas of the facility, including all staff control posts and staff work areas. A facility-wide public address system is not appropriate for point-to-point communication between staff where privacy or discretion is desired.

Continuous communication with officers not assigned to a constantly staffed post (rovers) or with transport officers may require the use of a **portable radio system**. An officer duress system, tied to alarms at Master Control, can be incorporated into the portable radio system to provide additional officer safety.

Master Control should also have some means by which to communicate to all **housing units** and major areas used by inmates in case other control posts become inoperative.

Communication between **Master Control and adjacent spaces** always seems to be a special problem in new jails owing to the use of security glass, concrete block, and other materials that effectively form solid walls through which sound does not transmit. It is advisable to use electronic devices or secure portals through which direct voice contact can be established. In either case, the convenience of the users should be taken into account.

Portals to public areas should be secure; electronic communications are preferable. **Direct two-way visual contact** between the control officer and the public visitor tends to be preferred by both parties.

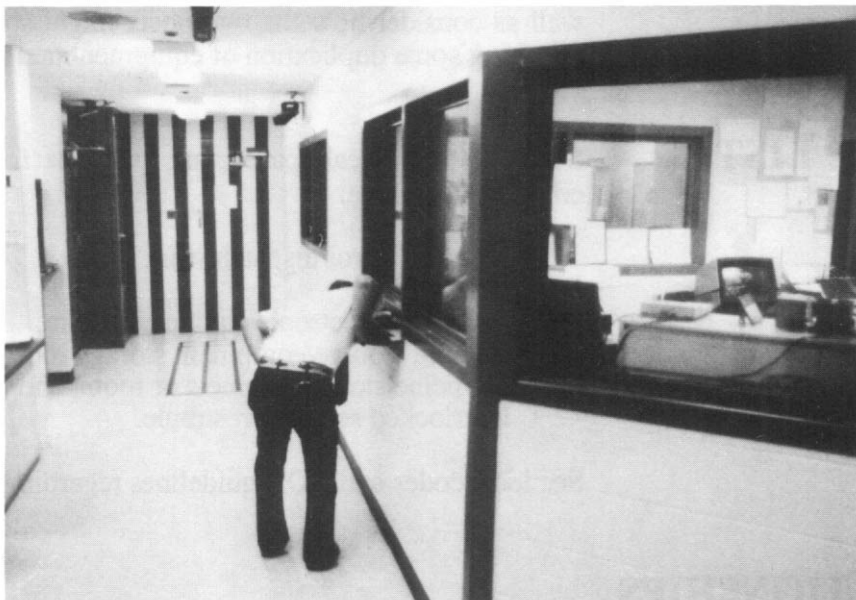

Awkward communication between officer and Master Control.

FIRE SAFETY

ISSUE: Proper fire safety provisions are essential within Master Control.

RESPONSE: Although planners must check local codes for specific fire safety requirements, several general considerations should be noted.

- Master Control should use fire suppression systems that minimize equipment damage.
- A fire extinguisher and self-contained breathing apparatus (air pack) should be available in Master Control.
- A direct alarm link to the fire department should be available in Master Control.
- Provisions for smoke evacuation or blocking smoke movement from other areas should be considered.
- A backup set of facility keys should be located in Master Control.

EXPANSION

ISSUE: Expansion must be accommodated.

RESPONSE: Master Control is not easy to expand because of its nature and central location in the jail. Therefore, if workload demands are likely to increase to the point where two positions are needed rather than one, it would be wise to design Master Control as a two-position space from the start. Such a design must account for appropriate space and arrangement as

well as consider how the two posts might split or share functions, thereby requiring some duplication of equipment and power sources.

SPACE LIST

Some of the typical spaces that might be found with the Master Control component include:

- Master control/dispatch work space,
- Restroom,
- Computer/electronic equipment room,
- General storage/equipment storage room,
- Medicine storage cabinets or room, and
- Interlocked security vestibule.

See local codes and ADA guidelines regarding accessibility requirements.

RELATIONSHIPS

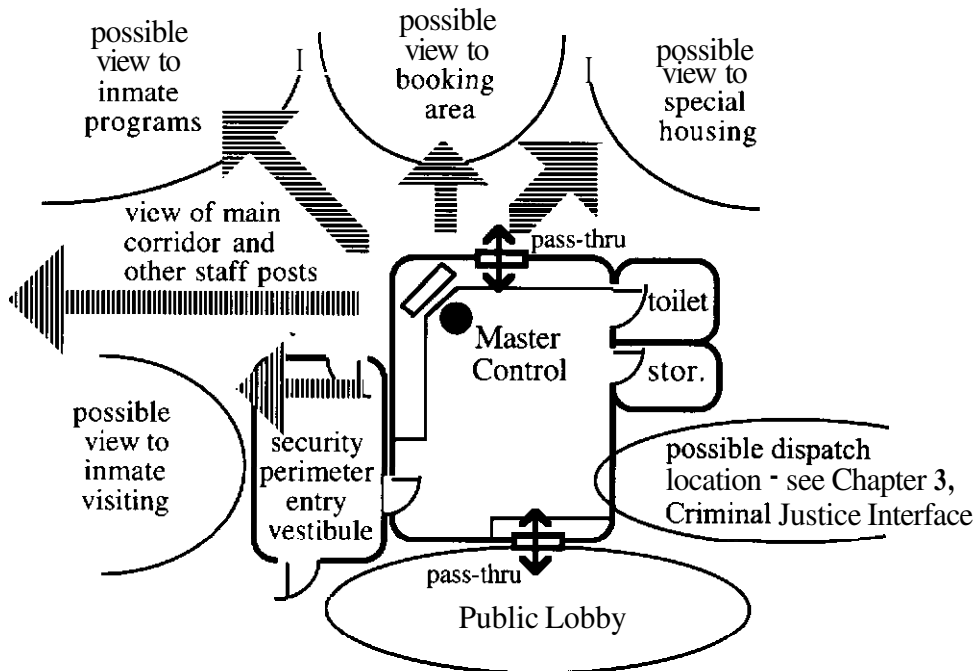

COMPONENT DIAGRAM

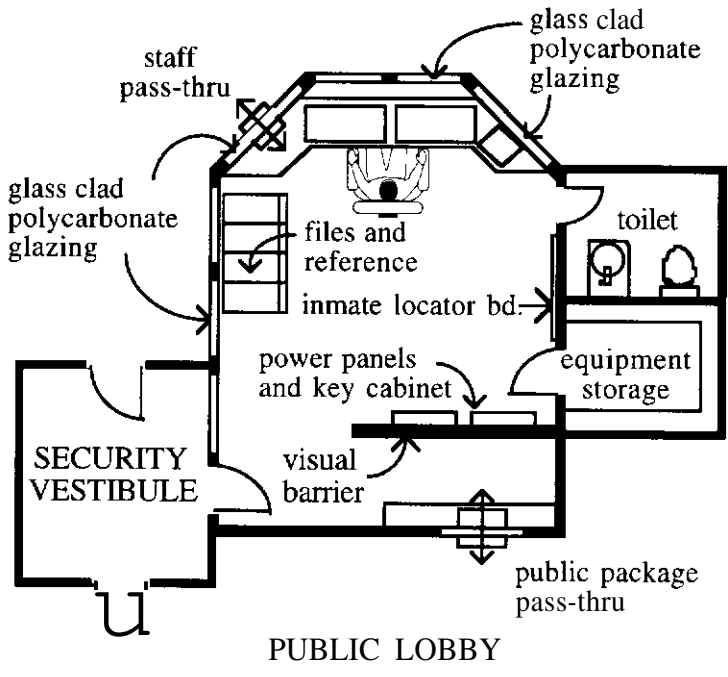

INTAKE-RELEASE

DESCRIPTION

The intake-release area of a jail -- often referred to as booking, admissions, or receiving -- is an active, vital component. It performs three key roles:

- Conducting all intake activities involved in initially *receiving* arrestees or inmates from court or other facilities:
 - secure **entry/verify arresting** authority;
 - frisk, receive and temporarily store selected property;
 - book, fingerprint, and photograph;
 - temporarily hold;
 - visit (in person or via the telephone);
 - **screen/interview**;
 - provide minor first aid.
- Conducting all intake activities involved in *admitting* arrestees or inmates into residency in a housing unit:
 - exchange clothing, dress;
 - **shower/decontamination**;
 - search;
 - store **clothes/property**;
 - orient to facility rules;
 - classify;
 - move to housing unit.
- Conducting all activities involved in *releasing* arrestees or inmates from either the receiving area or a housing unit:
 - verify identity;
 - execute release **paperwork**;
 - exchange clothing, dress;
 - return property;
 - provide secure exit.

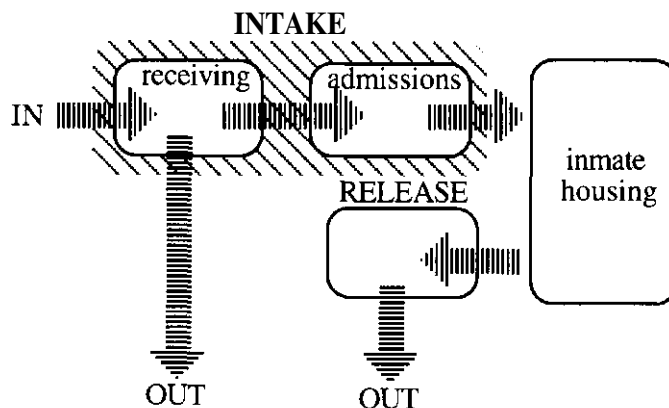

The intake-release area provides the arrestee with his/her first impression of the facility and sets the tone for his/her stay, much in the same way that the public lobby and reception areas of a jail (and all other buildings for that matter) affect the public. It affects the immediate behavior of new intakes as well as the behavior of long-term inmates. Architecturally and operationally, the stage is set at the intake-release area for subsequent inmate behavior by what is communicated verbally and non-verbally.

Because every arrestee or inmate who enters the facility is in this area at least once and they are in a wide variety of mental and physical states while there (e.g., angry, intoxicated, emotionally disturbed), the area is used both frequently and intensely. Its planning and design require special care and attention. The result should be a set of spaces that allow staff and inmates to function in a safe, secure, calm, and orderly way that preserves human dignity to the greatest extent possible.

The typical small or medium-sized jail of the past provided much less space for intake and release functions than do modern jails. Few jails provided secure and protected vehicle sally ports or temporary holding capabilities, instead keeping the inmate waiting in the booking area or moving him/her directly to a cellblock. In many older jails, admission into residency occurred without a shower or a change of clothes and without any screening for medical and mental health problems. Booking areas in older jails were rarely within a fully secure perimeter, sometimes being combined with the dispatch function in an area accessible to the public. Over the years, litigation forced staff to squeeze many of these needed but neglected functions into whatever limited space might be available -- hallways, storage spaces, closets. The results are often far from satisfactory.

Modern intake-release areas tend to provide space for a full variety of intake-release functions and to consolidate them into one distinct complex of interrelated spaces within the main security perimeter of the jail.

SPACE NEEDS

Many types of spaces are designated as intake-release space in this functional-architectural component, including:

Receiving

- Vehicle sally port,
- Secure entry vestibule/frisk area,
- Arresting officer report writing area,
- Sobriety testing area,
- Holding cells,
- Waiting areas,
- Booking/staff position,
- Fingerprint/photograph area,
- Temporary property storage area,
- Record storage area,
- Staff toilet,
- Arrestee toilet,

- Telephone alcove,
- Strip search area.

Admitting

- Shower/clothing change,
- Clothing issue/storage,
- Clean linens/toiletries issue/storage,
- Property storage,
- Street clothes storage.

Release (generally uses receiving and admitting spaces)

- Clothing issue/change and property issue area,
- Temporary holding (mainly for transfers to court and other facilities).

Cells for intoxicated, mentally ill, and suicidal individuals might be located within the intake-release area. Information on their design appears in the section on "Special Housing." The laundry area that is usually affiliated with clothing storage areas, such as those listed under "admitting," is addressed in the section on "Laundry Area."

Many state jail standards require certain spaces in the intake-release area. Since these vary from state to state, state standards must be checked carefully for applicable requirements.

KEY DECISIONS

As the role of the intake-release component is evaluated, the following decisions should be made since they have a fundamental effect on design requirements:

- Will **arrestees** and officers enter the jail through a secured vehicle sally port or will they park in, and move through, unprotected outdoor areas to gain access to the jail?
- Will the arresting officer have to assist in the receiving and admitting process or can **his/her** involvement be limited to minimize the **arrestee/officer** tension that results from arrests?
- Will arresting officers interview the inmate at the jail prior to booking to gather information for completing reports or will this take place prior to arrival at the facility? Will arrest procedures such as administering a breathalyzer be conducted at the jail or at some other location prior to arrival at the jail?
- Will the facility accept intoxicated, mentally ill, or injured persons or can they be taken directly to alternative facilities? If they are accepted at the jail, will specially trained staff and areas be made available to accommodate them?

- Will there be a release area separate from the receiving and admissions area or will release occur in the same area?
- Will inmates admitted into residency wear clothing provided by the facility or their personal clothing?
- Will females be processed in areas separate from those used for males or can design and scheduling effectively eliminate any anticipated problems of using one area?
- Will the booking area be staffed at all times or will staff only be present when an intake or release occurs?

DETAIL ISSUES

The following detail functional-architectural issues should be considered in the development of the intake-release component. Because of the many complex questions involved with intake-release area design, the detail issues are subdivided into four categories: 1) general design, 2) receiving area, 3) admission area, and 4) release area.

GENERAL DESIGN ISSUES

The issues presented next pertain to the total intake-release area.

Users

ISSUE: Users of the intake-release area should be identified to plan and design space effectively.

RESPONSE: The most frequent users of the intake-release area will be staff, new arrestees, and law enforcement officials. Intake-release staff must process all inmates for admission into the facility or for pre-trial release via bail, recognizance, or third-party release. Local law enforcement officials will use the area to deliver arrestees for receiving and/or sobriety testing. Other law enforcement officials (federal marshals or sheriff's departments, for example) might use the area for temporary detention of inmates in transit. Court officers or transport personnel will use the area for staging to prepare inmates for transport to and from court. Probation and parole officers may use the area for temporary holding of violators.

The variety of arrestees and inmates that might use the facility and shape its space needs is considerable. Some of the disparate behaviors and characteristics typically encountered include:

- scared;
- violent, angry;
- nonviolent, passive;
- career criminals;
- average citizens;
- male;
- female;
- juveniles charged as an adult;

- intoxicated on drugs or alcohol;
- mentally ill; and
- suicidal.

Other intermittent users of the area will include medical and mental health personnel, bondspersons, attorneys, and pre-trial services personnel. These users may need work space in the intake-release area at the same time that law enforcement and jail staff require space. Consideration should be given to the feasibility of all users sharing the same space or whether several spaces will be needed.

The *number* of users planned should be based on actual historical booking records and future projections of receiving and admissions activity. It is critical to recognize that the number of arrestees or inmates in the **intake**-release area at any one time can vary greatly based on several factors:

- group arrests;
- unusually busy times (weekend nights, court transfer times); or
- length of stay in temporary holding.

In determining the number of users, it should be realized that the *average length of stay* of an arrestee in the receiving area of a new jail might be longer than in the old jail. This is because most new jails provide a holding capability in the receiving area where none existed before. This allows the arrestee to spend several hours in the intake area while trying to arrange release or waiting for arrangements to be made by others, rather than being moved to a housing unit shortly after booking. Only after it appears that release will not occur in a timely manner is the admission process completed and the inmate placed in a housing area. Adequate staff supervision must be provided for arrestees in the intake area.

Location

ISSUE: The location of the intake-release area is vital to the efficient operation of the facility.

RESPONSE: The intake-release area should be located using the following key criteria:

- Within the *secure perimeter* of the facility.
- Adjacent to a *controlled entrance* to the building, such as a vehicle sally port and entry vestibule, and preferably within view of Master Control since Master Control will likely control all access to the building.
- Near the *public lobby* to allow a convenient and dignified release.
- Near *visiting*, if visiting is not provided within the component, to allow access to friends, family, attorneys, and bondspersons who are integral to inmates' release or helping with personal matters.

- Near the *medical examination* area to allow easy access.
- Near cells used for *mentally ill* or *intoxicated individuals*, if such cells are not provided in the intake-release area. These cells should be as quickly accessible from the secure entry as possible to minimize the difficulty of moving these individuals. Additionally, it is preferable that the cells be observable from a constantly staffed post.
- Near the *laundry* area, if inmates will change into facility-provided clothing prior to entering a housing unit.
- Near *offices* of personnel involved in pre-trial screening and *interview* rooms they or others might use.

A diagram at the end of this section illustrates these relationships.

Arrangement

ISSUE: The arrangement of intake-release spaces must facilitate inmate and staff flow and ensure the integrity of the area and its functions.

RESPONSE: A series of primary flow sequences occur in an intake-release area. These should be charted in sequence to identify the types of spaces needed and their fundamental arrangement.

The different types of flow that may occur in the intake-release area include:

- receiving an arrestee;
- receiving and admitting an inmate transferred from another facility;
- re-admitting an inmate who temporarily left the facility;
- admitting an arrestee into residency;
- releasing an arrestee prior to admission;
- releasing **an** inmate after a stay in a housing unit;
- releasing **an** inmate for a court appearance.

It is generally recommended that *work releasees* enter and exit the facility through a separate access point. However, this may be impractical and unnecessary for the jail that has:

- a very limited capacity;
- a low arrestee receiving and release rate, suggesting minimal potential conflicts and a greater ability to concentrate on the management of contraband problems through staff and policy; or
- a need to use space and equipment in the intake-release area since duplication cannot be justified.

However flow is projected to work through the intake-release area, all the spaces of the area should be *consolidated into one distinct group of*

spaces that work together uninterrupted by other nearby activities and functions. That is, pieces of the intake-release area should not be scattered throughout the facility. Consolidation allows smooth and effective operations and helps retain the privacy and dignity of the arrestee since, for many arrestees, contact with the jail can be successfully limited to the intake-release area alone. (As many as a third of all arrestees might be released in the first six hours of stay.)

In this regard, it is important to assure that there is proper *separation* between the spaces involved with receiving and those involved with admission into residency, which require more privacy (shower, dress, unclothed body search, etc.). Particular attention needs to be given to privacy since the intake-release area of small and medium-sized jails will likely be used by both male and female arrestees.

Environmental Quality

ISSUE: The intake-release environment should help reduce tensions and create a calm, orderly, and secure intake process.

RESPONSE: While the development of a calm, pleasant, and orderly atmosphere is in many ways dependent on staff attitudes, architecture can help considerably. Such an atmosphere can help reduce initial tensions and anxieties and thereby reduce aggressive behavior of new inmates. By communicating an expectation of rational behavior, the appearance and atmosphere of the intake-release area often produce that result.

The appearance and character of the area -- and people's response to it -- can be improved in a number of ways without sacrificing security. Possible techniques, which should be used selectively in deference to different inmate types and staff considerations, include:

- Using more conventional construction materials, such as concrete masonry units and security glass instead of steel plate and bars.
- Using "softer" materials that add warmth to the area and improve acoustics:
 - carpet,
 - lay-in acoustic ceiling tile,
 - ribbed concrete masonry units, and
 - solid-core wood doors.
- Using warm and bright colors, rather than institutional colors and patterns.
- Providing normalizing diversions, such as television and magazines.
- Providing durable yet more attractive furnishings -- plastics and woods, rather than concrete and metal.
- Providing maximum freedom in holding accommodations, such as open waiting areas for arrestees who do not require a more restrictive setting.

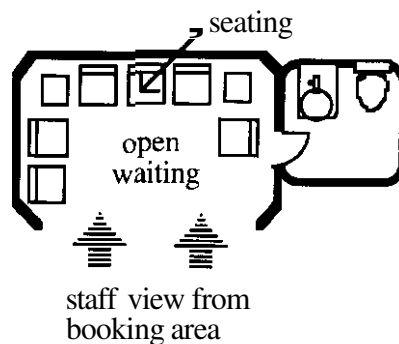

Overall, the intake-release area should create an appearance similar to that of a well-designed waiting area in a clinic, while the underlying construction approach, a well-defined security zone, and staff observation provide the ability to segregate and restrain disruptive inmates.

Security

ISSUE: Intake-release functions require close security and control, given their sensitive and difficult nature.

RESPONSE: Given the emotional stress involved in the receiving process and the potential for security problems during receiving, admissions, court transfers, etc., the intake-release area functions need to be among the most secure and closely monitored in the facility.

The entry sequence to the receiving area should be within the direct line of sight of the intake-release officer, if possible. Ideally, intake-release staff will be able to *directly view*:

- the identity and circumstances of the transporting officer prior to opening the vehicle sally port door,
- complete entry of the vehicle,
- departure of the officer and the arrestee from the vehicle,
- movement to and through the door or vestibule leading to the receiving area,
- departure of the officer from the entry vestibule, and
- departure of the officer and vehicle from the vehicle sally port.

The advantages of this arrangement are that 1) the intake-release officer can view the entire entrance process and respond if trouble arises; 2) the arresting officer is reassured, and the arrestee is deterred from dangerous behavior by the constant and visible support given by the intake-release officer; and 3) the arrestee can see where he/she is going next, thereby relieving a degree of anxiety about the process.

If possible, this same sequence should be visible from a constantly staffed post such as Master Control, since it will probably have responsibility for

operating sally port and entry doors. Any view that cannot be provided to Master Control directly should be provided through CCTV. Holding cells and, if possible, the booking, fingerprint, and photograph areas should also be visible from Master Control or a constantly staffed post.

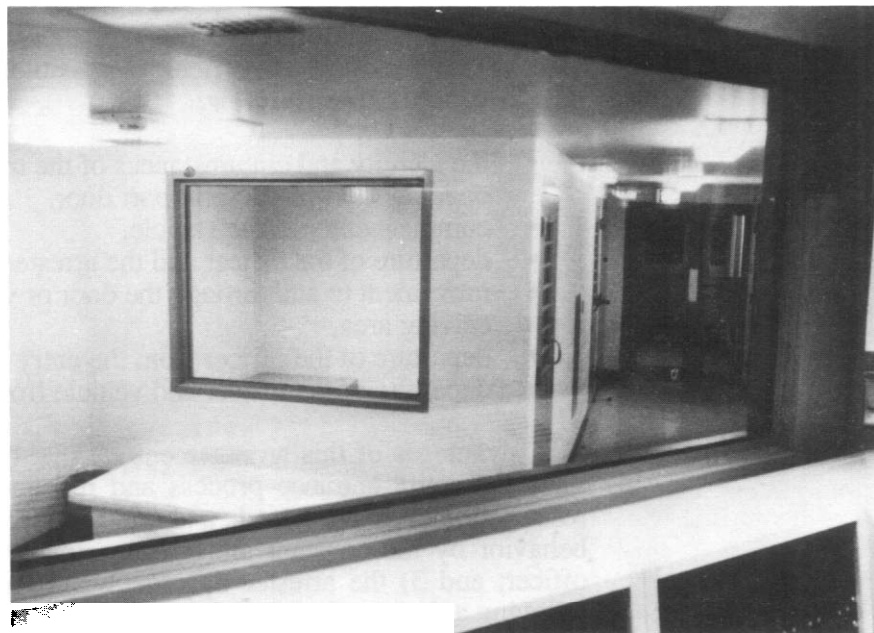
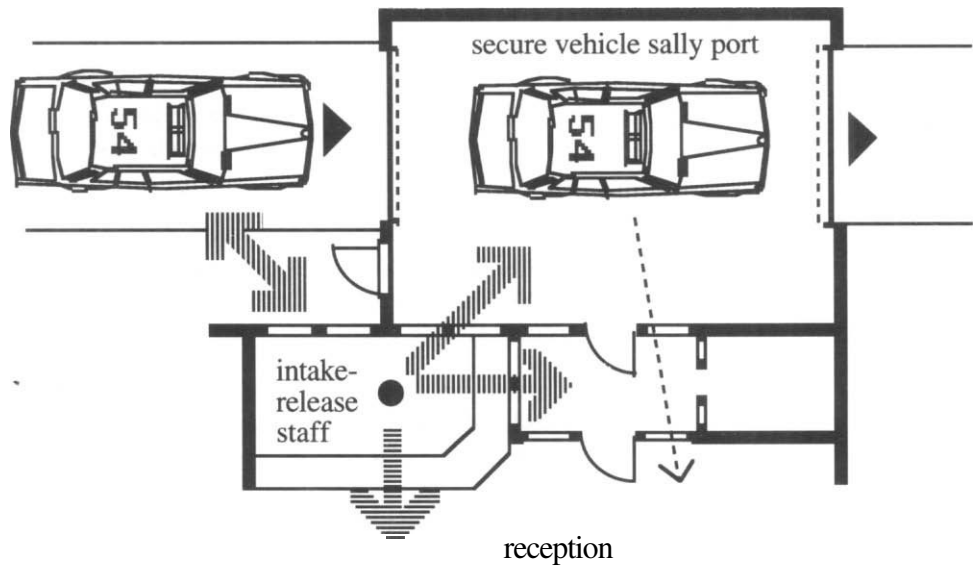

View from staff post to holding cell and arrestee entry.

Direct visual monitoring of the *admissions* area from a remote staff post is impractical given the more private activities involved. However, staff doing the unclothed body search, clothing issue, property storage, etc. will likely be within the space with the arrestee to provide direct supervision. This officer's security should be supplemented by two-way audio communications with a constantly staffed post or by an audio monitoring or alarm capability.

RECEIVING AREA DESIGN

The following detail functional-architectural issues pertain to the areas required for the receiving or "booking" activities of the intake-release component. The receiving areas and spaces are those involved with the initial receipt, but not the admission into residency, of arrestees, inmates returning from court, or inmates transferred from other facilities. The following discussion of the receiving area covers five areas: secure entry, arrestee processing, waiting and temporary holding, outside contact, and miscellaneous support.

Secure Entry

The secure entry typically consists of two primary architectural elements:

- vehicle sally port, and
- entry vestibule, which possibly includes sobriety testing

Vehicle Sally Port

ISSUE: A secure and protected vehicle entry for the arrestee inmate and the transporting officer is necessary.

RESPONSE: An enclosed *vehicle sally port* best responds to this issue by providing three key capabilities:

- a secure environment from which the arrestee/inmate cannot escape or be aided in escape once he/she leaves the transport vehicle,
- privacy separation from adjacent facilities or land uses, and
- protection from the weather.

While the first capability is essential, the other two are highly desirable depending on location, climate, and economics. Some jurisdictions, for example, only have a fenced area to provide a basic degree of security (although contraband passage can remain a problem). This is sometimes thought to be sufficient in cases where the jail is on a remote site, view conflicts are negligible, and the climate minimizes weather-protection concerns. In general, it is recommended that a fully enclosed and securely constructed vehicle sally port be provided.

Some considerations for the design of the vehicle sally port:

- A *drive-through* type sally port for ease of operation, versatility, and traffic flow. This means a vehicle enters through one door/gate and exits through a second door/gate.

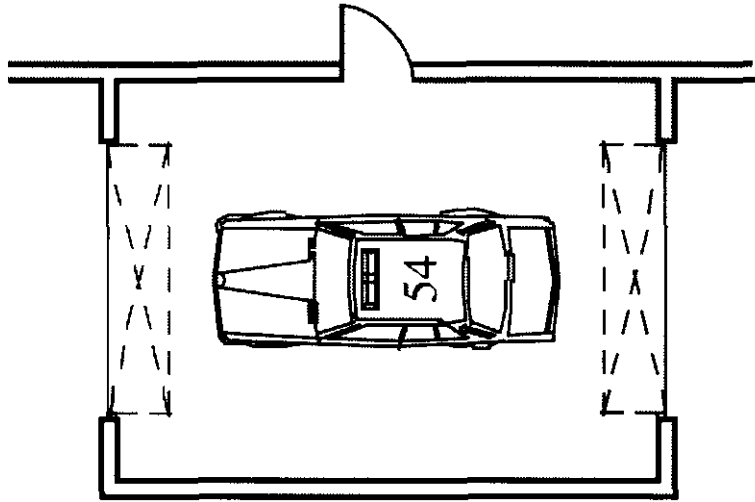

- Sufficient height and width in doors/gates and adequate floor-to-ceiling clearance to accommodate squad cars, 4 x 4s, vans, buses, and/or emergency vehicles, including the height added by antennas, lights, and sirens and the extra width of ambulance and other emergency vehicles including mirrors. Doors/gates 10 to 12 feet high and 12 feet wide are normally appropriate.

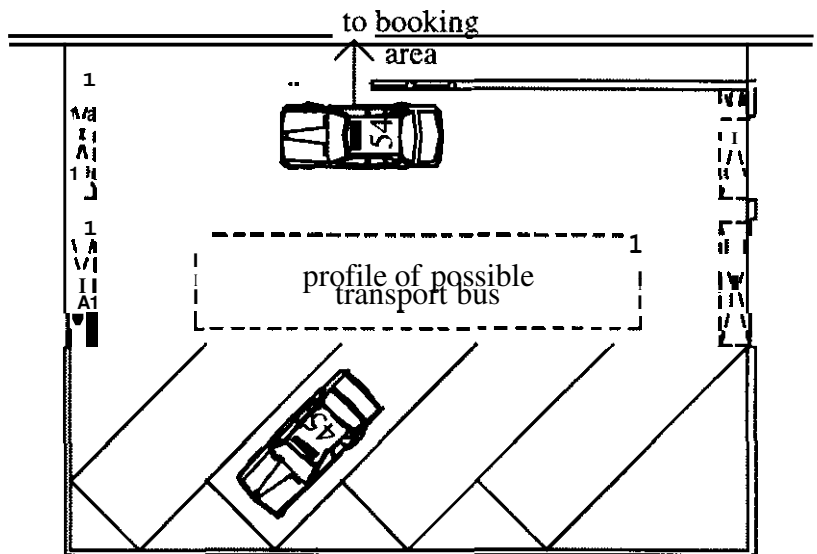

- Sufficient floor area to accommodate:
 - the length of the largest vehicle to use the space (buses are approximately 40 feet long, cars 16 to 18 feet long);

- the width of open car doors and **arrestee/inmate** movement in the space (normally, a minimum of 15 feet for a sally port of single vehicle width);
 - the number of vehicles to be allowed into the sally port at one time; and
 - any parking allowed for other official vehicles in the space.
- A location **adjacent** to the secure vestibule entry to the jail, if a vestibule is provided.
 - Separate **storage** space for any items associated with the vehicle sally port to keep potentially dangerous clutter out of the reach of inmates.

An **arrangement** that makes the door through which the **arrestee/inmate** will leave a squad car open directly at the point of secure entry to the intake-release area.

Sally port doors/gates that are **remotely controlled** by Master Control to keep them easily operable and secure from inmate tampering.

A **pedestrian entry** into the vehicle sally port from the outside, also controlled by Master Control, to allow officer access after parking the squad car and to allow access in the event that overhead doors are in disrepair.

- An **interlock** for all overhead and pedestrian doors to prevent escapes or unauthorized access.
- A **radio or intercom** to Master Control -- at the entrance to the sally port and at the entrance to the jail -- to request entry and provide a means of communication from within the sally port.

Direct visual or CCTV monitoring inside and outside the sally port by Master Control. (Direct monitoring of as much as possible of the entry activity is valuable even if not all of the sally port can be seen without CCTV help.)

- **Weapons lockers** in the vehicle sally port to keep handguns outside of the intake-release area.
- Sufficient **artificial lighting** for night-time use and sufficient **ventilation** to exhaust vehicle fumes.
- **Natural light** to brighten the space if possible and calm the **arrestee**, through the provision of security-glazed detention windows or skylights.
- **Hose bib and floor drain** for easy cleaning

Pedestrian Entry Vestibule

ISSUE: A secure pedestrian entry vestibule may be needed to create a secure and properly controlled entry to the intake-release area.

RESPONSE: A secure pedestrian entry vestibule is essential if the following conditions exist:

- There is no secure, fully enclosed vehicle sally port.
- A variety of pre-booking functions inappropriate for the vehicle sally port must occur prior to allowing entry into the intake-release area -- filling out arrest forms, sobriety testing, initial pat search, initial property receipt.
- There is a desire to limit the access of the arresting officer to the booking area to decrease tensions by eliminating him/her from the process as quickly as possible.
- Another level of security at the point of entry, in addition to a vehicle sally port, is desired (essentially creating three barriers between the intake-release area and the outside).

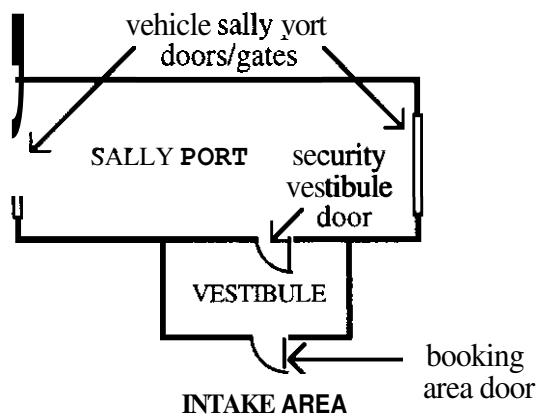

If a secure entry vestibule is required, the following design considerations apply.

- Provide sufficient floor area to permit easy arrestee/officer flow, including difficult flow (e.g., wrestling, stumbling, fighting, two persons holding inmate).
- Provide sufficient floor area to accommodate associated functions if the entry vestibule serves as more than just a passageway. Some possibilities:
 - sobriety testing;
 - report writing, data entry;

- toilet;
- telephone; and
- waiting by the arrestee (consider a bench with restraint capability).

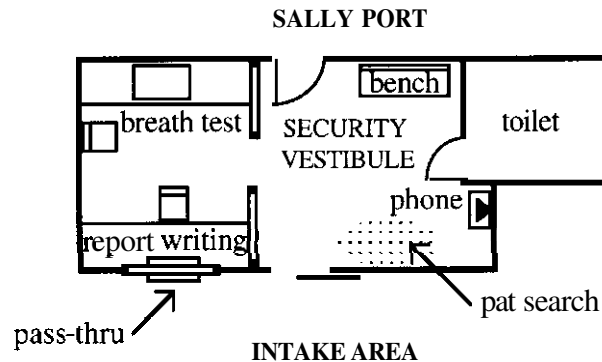

- Provide *visibility* from the booking station and/or a constantly staffed post, but sufficient screening from holding areas to provide privacy for pat searches.
- Consider using *sliding doors* to eliminate the need for the officer to manipulate swinging doors and the arrestee at the same time.
- **Interlock** the vestibule doors and provide an interlock override for emergency ingress or egress.

Provide a means of *voice communication* from the vestibule entry to intake-release and staff control positions.

- Provide a means by which documents and property can be securely *passed* from the vestibule to the intake-release area.
- Provide *mats, non-slip surfaces, and drains* to neutralize the effects of mud, snow, ice, and water brought into the area.

Sobriety Testing

ISSUE: Sobriety testing areas, if provided, should be affiliated with the entry sequence to limit arresting officer entry into the jail and create easy access to needed equipment.

RESPONSE: Some design considerations regarding sobriety testing:

- Sobriety testing should be done at or near the entry from the sally port, preferably in an area distinct from the receiving area and accessible from the secure pedestrian entry vestibule.
- The area should be large enough to accommodate the particular type of sobriety testing equipment used; storage of testing materials, sup-

plies, and forms/records; and seating for both the arrestee and the officer. (Temporary seating is important because arrestees must sometimes be observed for a 15- to 20-minute period prior to testing and may need to sit in the sobriety testing area during observation.)

- It may be desirable to make the space large enough to conduct motor skills tests.
- Space for videotaping the sobriety and motor skills testing process may be needed.
- Toilet facilities should be associated with the area, if possible, since intoxicated individuals frequently need to urinate and often become nauseated.

Arrestee Processing

Three classic functions generate space needs for pre-admission arrestee processing in the intake-release area:

- booking,
- fingerprinting, and
- photographing.

The following detail functional-architectural issues address the design impacts of these functions for the small and medium-sized jail.

Booking

ISSUE: The booking of an arrestee must be accommodated.

RESPONSE: The booking process is largely a paperwork and/or data entry process where information is obtained about the arrestee, including:

- personal data,
- arrest data,
- criminal history,
- arrest authorizations,
- medical history, and
- other relevant information.

The area primarily needs work surfaces and space around them. In a small jail, usually only one booking station is needed because of the relatively low volume of arrests and limited staff resources. Some design issues to consider:

- Decide whether the arrestee and the intake-release officer will *sit and/or stand* during booking and ensure that booking counter surface heights correspond appropriately. Note that high chairs and stools may contribute to injuries of inmates who are intoxicated or otherwise impaired.
 - Locate the booking area as close to the secure entry as possible.
-

- Create enough space on the inmate side of the area to **avoid congestion** when others are entering and using the area.
- Identify the **equipment** needed and allow sufficient space for it:
 - intercoms;
 - telephones;
 - typewriters;
 - computer terminals and printers;
 - file cabinets for active inmate records;
 - forms and other miscellaneous supplies;
 - containers for temporary or secure property storage;
 - writing surface;
 - property receipt equipment, such as heat-sealing equipment for property bags;
 - clock, inmate locator board, bulletin board; and
 - electronic controls for doors, lights, and telephone.
- Decide whether the booking staff will be in an **open work area or an enclosed area**. Given the limited staff of small and medium-sized jails and that the intake-release officer will likely have to receive the inmate at the entry vestibule and move him/her through the intake-release area, an open booking area is more efficient and practical.
- Provide storage in a safe or locked drawer for the temporary holding of cash and small valuables.
- Provide storage for the temporary holding of large property items, such as suitcases and attaché cases.

Photographing
Fingerprinting

ISSUE: Photographing and fingerprinting functions must be accommodated.

RESPONSE: Photographing and fingerprinting are routine functions of the receiving process. The primary question is whether they require a separate alcove or space or whether, especially in the smallest jails, they can be done from the booking counter. Some design considerations follow.

Photographing

- Determine the **method** of photographing arrestees. For example:
 - 35mm photographs;
 - instant-print photographs;
 - multiple instant photographs, as produced by the kind of large portable machines seen in shopping centers;
 - digital photo imaging.

The method selected will frequently depend on the needs of various law enforcement agencies outside of the sheriff's office (FBI, state

bureaus of investigation, prosecuting attorney's office) and the need to have reproducible negatives.

- If 35mm processes are used, decide where the film will be developed. If it is to be developed at the facility, consideration should be given to providing a **darkroom**. Also, film development with some instant-print systems requires a work surface for minimal amounts of equipment and chemicals.
- If photographing is done from the booking counter, be sure to consider the **convenience** of staff in posing the inmate and returning to the camera to take the pictures.
- Provide above and below counter **storage** for equipment, supplies, and forms associated with both photographing and **fingerprinting** inmates. Such things include booking cards, film, and development chemicals. If **chemicals** are used, they should be stored in a **locked cabinet** and not be used in areas accessible to inmates.
- Provide flexibility for using a **height chart** as part of the photographing arrangement. (Criminal investigators may not want a height chart in order to use jail photographs for photo line-up.)
- Provide storage for the **board and Z.D. letters** used in the photographing process.
- Provide ample **artificial lighting** to enhance the quality of photographs.
- In arranging space and equipment, consider how photographs might be taken. For example, while it is typical to take a single shot from the front and shots from both sides of the individual, another idea is to use a mirror system that allows one shot to provide front face, left face, and right face.

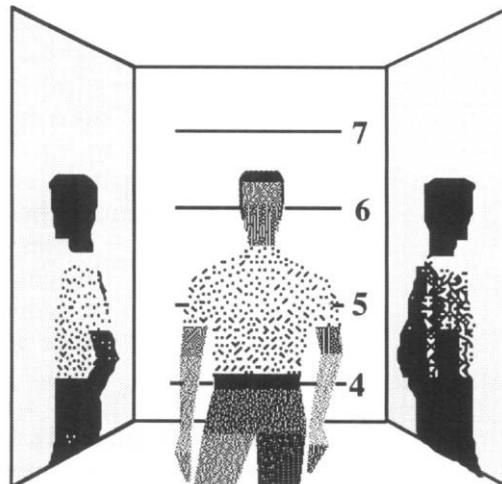

Fingerprinting

- Identify the ***method of fingerprinting*** to be used. Some methods use chemicals, heat processes, or computer imaging instead of the traditional ink pads.
- Be sure there is ***sufficient room*** on either side of the fingerprint pad for the staff to stand while working with the arrestee.

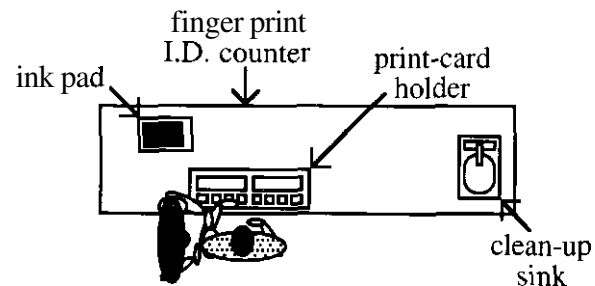

- Provide a sink for ***hand washing*** after fingerprinting, paper towel dispenser, and waste receptacle if ink is used.

Temporary Waiting and Holding

Because it is not always possible to immediately process every arrestee who arrives at the jail and some facilities may choose to allow arrestees to wait in the intake-release area for several hours while bond arrangements are being made, the provision of temporary holding or waiting areas becomes critical to the operation of the intake-release area.

All holding or waiting spaces should be easily observable from a staff post. However, care must be taken to ensure adequate privacy when toilets are included in the spaces. View conflicts between holding spaces and between holding spaces and other areas of the facility must also be controlled.

ISSUE: Secure single-occupancy holding should be available for arrestees or inmates who have been violent or combative or who otherwise need temporary confinement apart from other persons.

RESPONSE: The characteristics of a secure holding room for violent or combative inmates might include:

- Single-cell occupancy, recommended size of 50 to 70 square feet (check state standards for applicable requirements).
- Large security-glazed vision panel in cell door and front wall
- Sufficient door width to facilitate two officers placing a combative inmate in the cell and to allow for easy entry of a "restraint chair" and emergency equipment.

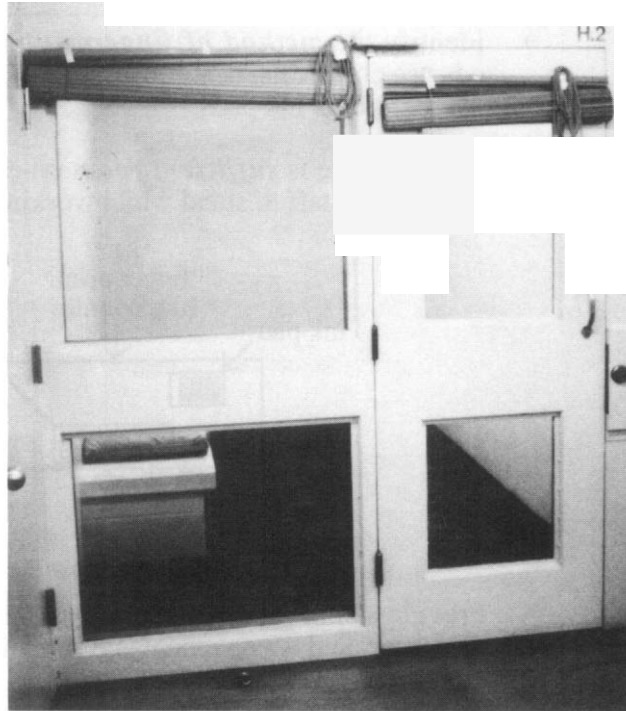

Holding cell with full vision and screening capability.

- High-security hardware.
- Detention plumbing fixtures behind a privacy screen that allows some view control (normally about 42 inches in height is adequate). Consider installing a remote flushing feature to prevent the loss of potential evidence.

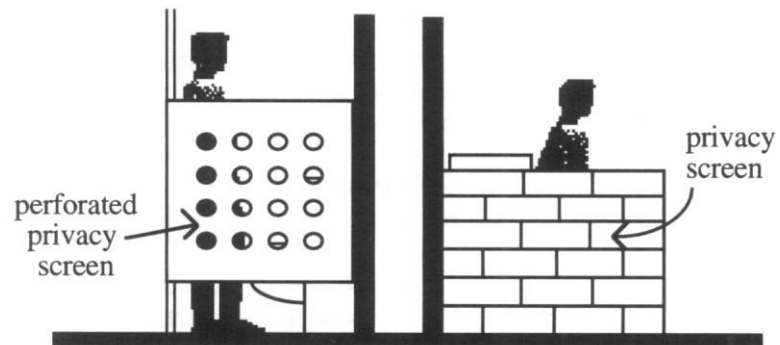

- Fixed seating (sufficiently wide and long to permit lying down, if possible).

- Natural light through secure windows, skylights, or clerestories, if possible.
- Artificial lighting controlled by staff.
- At least nine-foot ceilings, if possible, to minimize random assaults on the surface or fixtures at the ceiling.
- Durable finishes and materials.
- Ashtrays and perhaps electric cigarette lighters if smoking is allowed (ashtrays may be disposable if fixed equipment, which requires maintenance, is not desired).
- Capability of attaching restraints to the wall, seating, or floor.

ISSUE: Multi-purpose secure waiting space is needed for holding during mass arrests and staging for court or other transport.

RESPONSE: The characteristics of a multi-purpose space might include:

- Multiple-occupancy holding for four to six people. The recommended room size would be a minimum of 60 square feet, with 12.5 square feet added for each person over one (check state standards for applicable requirements).
- Fixed seating (a bench is preferred to allow arrestees to lie down when only one or two are in the space).
- A detention-quality toilet and sink behind a privacy screen, which allows some view control by staff.
- Large vision panels in the door and side wall for observation from the booking/staff station in the receiving area.
- Medium- to high-security hardware
- A floor drain
- Natural light through secure windows, skylights, or clerestories, if possible.
- Nine-foot ceilings, if possible
- Durable finishes and materials.
- Ashtrays and perhaps electric cigarette lighters if smoking is allowed (ashtrays may be disposable).

ISSUE: An open waiting area should be available for cooperative and non-combative arrestees awaiting booking or pre-trial release via bonding or other measures.

RESPONSE: The characteristics of open waiting areas might include:

- Fixed durable seating (such as that used in airports) in the receiving area, allowing approximately 15 square feet per seat.
- Access to telephone.
- Access to toilet and sink in a private space.
- Access to drinking fountain.
- Good visibility from the booking/staff station and/or Master Control.
- Television and reading material, if desired, to preoccupy arrestees
- Fan to exhaust cigarette smoke if smoking is allowed
- Signage providing information on the receiving process, bonding, legal assistance, and basic legal rights. (Providing information reduces fear of the unknown and thereby has a calming effect.)
- A brochure rack to provide information on alcohol/drug problems, legal assistance, and other topics as appropriate.
- As much screening as possible from the view of those in holding cells.
- A location out of the main circulation path and outside the entry of the waiting area to avoid congestion and security risks.
- Natural light through secure windows, skylights, or clerestories, if possible.

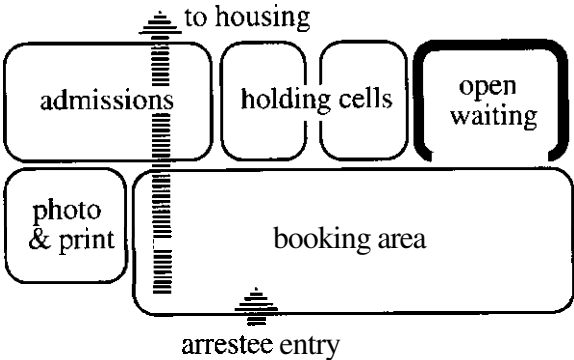

Outside Contact

ISSUE: Provisions need to **be** made for arrestees to have contact with outside family, friends, lawyers, and bondspersons.

RESPONSE: Contact with outside persons is usually made possible by creating a visiting area and providing access to telephones.

In most small and medium-sized jails, access to a nearby **general visiting area** should be sufficient since distances between areas should not be that great. However, it may be desirable to minimize arrestee movement by having a visiting area for bondspersons or lawyers as part of the intake-release area. Such a space, if provided, should have the following characteristics:

- Visibility from a constantly staffed post or a post that is occupied during the visit.
- A controlled point of entry for the bondsperson or lawyer. This point of entry should not only have remotely operated locks with status indication (locked, unlocked), but should be monitored by CCTV unless a direct line of sight to the entry can be established from a constantly staffed post without creating view conflicts with inmate areas. Additionally, an intercom ought to be located so that initial identification by voice can be made.

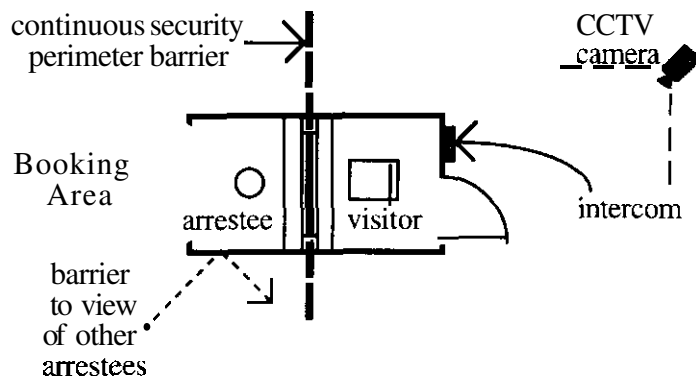

- A secure barrier between the arrestee and the visitor, created by using secure wall materials and security glass and framing (as discussed in the functional-architectural section on "Visiting").
- A means by which papers requiring an arrestee's signature can be **passed** securely from the lawyer or bondsperson to the arrestee. This should be accomplished with minimum staff effort. A lockable paper pass is a typical option.
- A means by which facility staff can communicate to the visitor side to respond to requests for information and notify individuals of the end of a visit.

Telephones with outside lines should be provided throughout the intake area. The primary question is how telephone access is given to **arrestees** within secure single- and multiple-occupancy holding rooms. There **are** several answers: 1) install wall-mounted telephones within the holding spaces, 2) move the arrestee from the cell to a central telephone location, or 3) provide a telephone jack in the walls so that a telephone unit can be passed through a food pass or opening in the holding cell door for the arrestee's use. The choice of method depends on the visibility of the cells, the behavior expected of the individuals in the cells, the availability of staff to move inmates, and how available the facility administration wants telephone contact to be.

Generally, it is probably inappropriate to place telephones in secure **single**-occupancy cells, but it seems reasonable to consider placing them in multiple-occupancy waiting cells. (An exception is where a telephone would be available to an inmate while waiting to be transported -- allowing telephone calls just prior to transport violates sound security procedures.)

If telephone use occurs outside the holding cells, it is important to consider providing some level of *privacy* for the telephone call. A small telephone alcove with appropriate acoustic treatments is the best solution, although, in a small jail, the low number of **arrestees** may diminish the noise/privacy concern.

Miscellaneous Support

ISSUE: Miscellaneous support requirements should be accommodated.

RESPONSE: The following support elements should be considered in the design of the receiving area:

- staff toilet,
- general supply storage,
- janitor's closet,
- hose bib or hose,
- drinking fountains,
- clocks,
- ashtrays and electric cigarette lighters if smoking is allowed, and
- trash cans and waste baskets.

ADMISSIONS AREA DESIGN

The following detail functional-architectural issues pertain to the admissions activities of the intake-release component. That is, they deal with the areas required to accommodate admission into residency of the arrestee who cannot be released from the receiving area. They also pertain to the admission of inmates returning from court or transferred from another facility.

Shower/Change

ISSUE: Facilities should be provided to allow the inmate to shower and change clothing.

RESPONSE: There needs to be a place where inmates, under the observation of staff, can shower and change into clothing issued by the facility prior to entering their assigned housing unit (assuming this practice is part of the facility's operational scheme). The characteristics of this area might include:

- Privacy from the booking area and from the facility generally.
- Backup audio surveillance and/or communication with a constantly staffed post.
- Shower, toilet, and sink fixtures.
- A drying area with a non-slip surface, a small bench, and towel and clothes hooks or bars.
- Excellent ventilation, especially if the area is also used for inmate decontamination.
- Shelves for prepared sets of clothing, linen, and toiletries for incoming inmates, preferably in an alcove open to the area or in a securable cabinet within the shower/change area.
- A modesty screen behind which an inmate can undress/dress when a strip search is not allowable. (In recent years considerable litigation has limited strip searches of certain arrestees, such as non-violent misdemeanants and traffic offenders. Court rulings preclude the viewing of genital and anal areas of both genders and the breasts of females during the search or clothing-exchange process.)

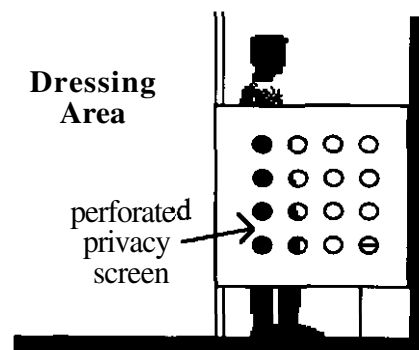

- Sufficient floor area within the space to allow easy movement of at least two people and to allow the officer to conduct unclothed body searches.
- A small work surface and form storage area to allow the officer to document the receipt of property and clothing and to obtain the inmate's signature.

Storage/Issue

ISSUE: Storage, receipt, and issue of a wide variety of items must be accommodated in association with the shower and change area.

RESPONSE: There is a need to store, receive, and/or issue the following types of items in spaces adjacent to, and easily accessible from, the shower and change area:

- street clothes;
- personal property;
- bulk property (e.g., suitcases, duffel bags, attache cases);
- facility clothing;
- linens;
- mattresses/pillows; and
- toiletries.

Some of these storage capabilities might be *consolidated*. For example, it is common to store all inmate property (clothing, wallets, keys, suitcases) in one area that is secured from access by inmates and most staff. It is also common to consolidate linen, clothing, and toiletry storage.

Issuing Methods

The extent to which items are stored near the shower and change area depends on the method of issuing items to incoming inmates and how those items are expected to get to the assigned cell area. For example, some facilities will issue all items to the inmate at the shower and change area, thus expecting him/her to carry them, including the bulky mattress, to the cell. Other facilities provide all essential items with the exception of inmate clothing *at the cell*. A cleaned and disinfected mattress, linens, and toiletries are at the cell when the inmate arrives. This distribution approach suggests that storage facilities be located near the housing areas rather than near the admissions area.

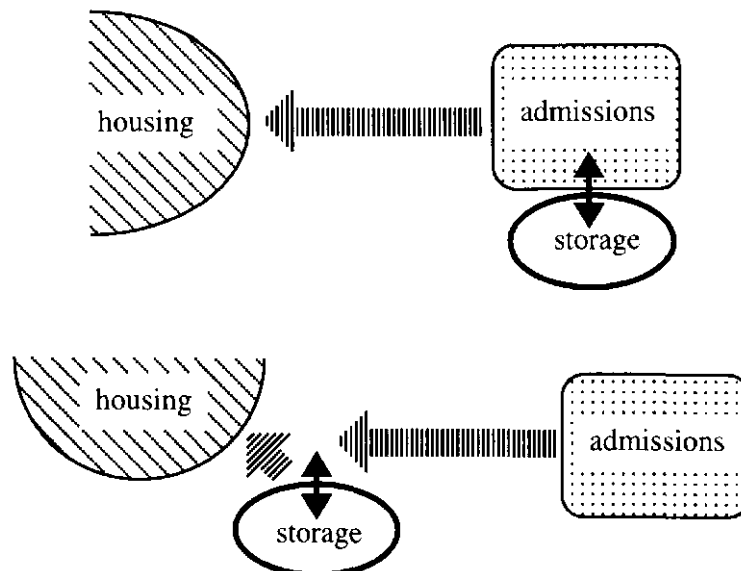

Personal property (wallets, jewelry, etc.) may be stored in lockable drawers at the booking desk or in a space immediately adjacent to the booking desk that is accessible from the receiving area, the admissions area, and the point of release. Special clothing bags with pouches that can be used for secure storage of property can also be obtained. As noted earlier, if this approach is used, the street clothing storage area must be secured and controlled by a few select officers to avoid loss of property and passage of contraband.

Storage Space Factors

The amount of space needed for the storage of clothing, linens, and toiletries will depend on the following factors:

- The *variety* of items issued by the facility.
- The method of *exchanging* soiled for clean articles. Will a full supply of linens replace those being laundered or can the same linens be taken, washed, and returned? Likewise, will all clothing have to be replaced while soiled clothing is being washed?
- The amount of *excess* clothing required to ensure that proper sizes are available for all inmates (including during overflow periods) and that damaged goods can be taken out of circulation for repair without creating a shortage of needed articles.
- The *length of time* toiletry supplies are expected to last, given the booking and use patterns of the facility.

A key functional-architectural component affected by decisions regarding admissions and storage requirements is the *laundry*, which has a close affiliation with the linen and clothing storage areas. If these are affiliated with the intake-release area to accommodate desired operational practices, it is critical that the laundry area be *adjacent* to the linen and clothing supply areas.

RELEASE AREA DESIGN

ISSUE: The need for a separate release area should be considered.

RESPONSE: Because the receiving and admissions areas frequently serve the needs of release in smaller jails, several considerations should be taken into account when developing the layout of the intake-release component:

- The need to assemble a group of inmates to be transported or released without interfering with intake operations.
- The need to apply restraints to a group of inmates to be transported to court, thereby necessitating a group staging area and access to restraint equipment.
- The need to change into street clothes for release or court appearances without disrupting the receiving or admission processes. A

small group dressing area might be provided or the facility might require the changing of clothes at the housing units.

- The need to provide privacy for low-security offenders when changing clothes.

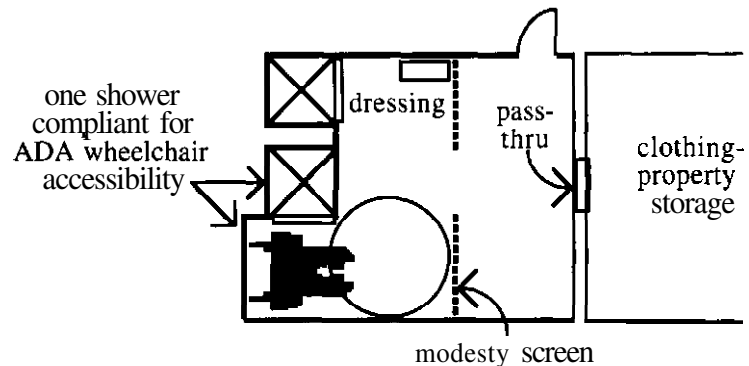

SPACE LIST

Some of the typical spaces that might be found in the intake-release component follow.

RECEIVING

- Vehicle sally port
- Storage area
- Secure entry vestibule
- Sobriety testing room
- Booking area/temporary property storage
- Photo/fingerprint
- Telephone alcove
- Secure single-occupancy holding
- Multi-purpose (multiple-occupancy) holding
- Open waiting area
- Staff toilet*
- Inmate toilet*
- Supply storage
- Janitor closet
- Strip search space

ADMISSIONS (some storage areas might be consolidated)

- Shower/change area
- Street clothes storage
- Valuables storage
- Bulk property storage
- Facility clothing storage
- Linen storage
- Toiletries storage

* See local codes and the ADA regarding handicapped accessibility requirements.

Other related areas that may be added to the component include:
 Visiting
 Laundry
 Interview/counseling
 Offices for pre-trial personnel.

RELATIONSHIPS

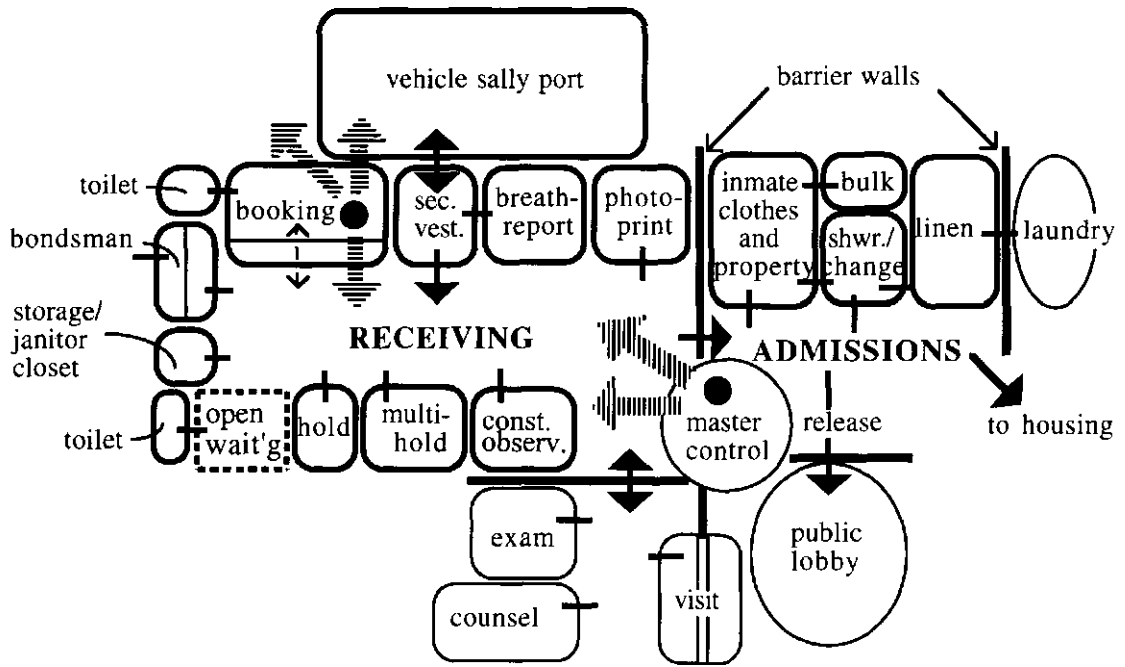

COMPONENT DIAGRAMS

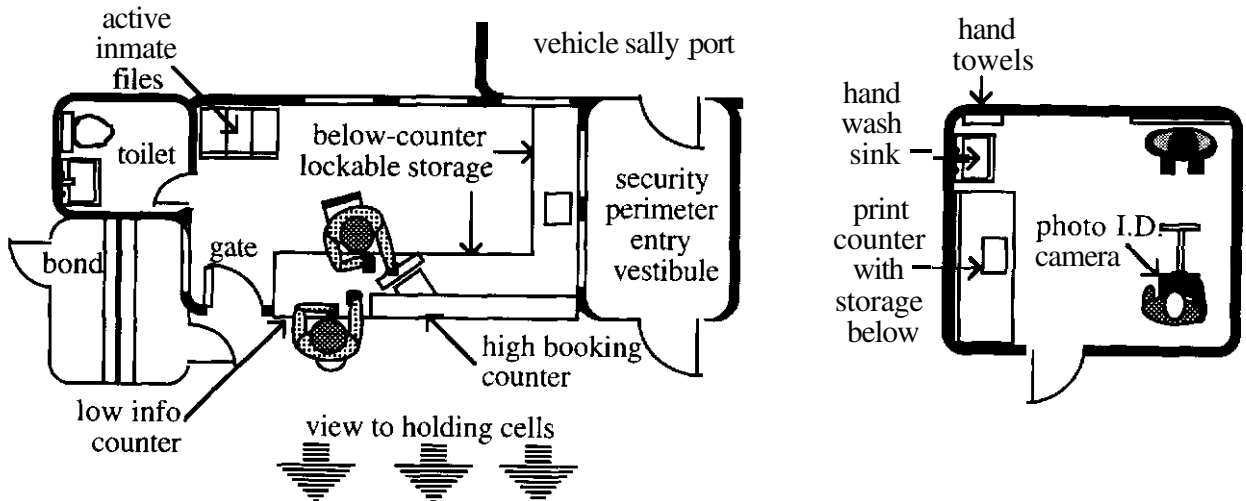

GENERAL HOUSING

DESCRIPTION

The general housing component of a jail consists of those areas that accommodate the typical or "average" inmate. This inmate is defined as one who does *not* require special housing accommodations due to behavior, condition, or unique separation requirements. The following inmate types are generally considered inappropriate for general housing:

- work release/periodic confinement,
- inmate worker,
- protective custody,
- juveniles to be adjudicated as adults,
- inmates requiring medical isolation,
- disciplinary detainees,
- suicidal,
- mentally ill, and
- intoxicated.

The functional-architectural "Special Housing" component follows this section and addresses the housing needs of these inmate classifications.

Inmates with disabilities were historically thought to require separate special housing but should be accommodated within the general population. Their needs are described within this component.

The general housing inmate population primarily consists of adult males in either pre-trial or post-trial status, charged with a felony, misdemeanor, municipal, or traffic offense. It can also consist of adult females in similar categories (although in appropriately separate general housing areas). There can be variations of security risk levels within general housing, ranging from "low" to "high."

Functionally, the basic mission of general housing areas is to accommodate the sleeping, privacy, personal hygiene, personal interaction, safety, and security needs of the typical inmate and the management, safety, security, personal, and professional needs of the staff working in the area. The general housing area is the focal point of a jail design and represents a substantial portion of the costs and square footage involved with a jail.

General housing areas normally consist of the following types of spaces:

- inmate cells or dormitories;
- dayrooms (central activity areas serving a group of cells or a dorm);
- staff control posts;
- security vestibules;
- shower/toilet areas, and
- miscellaneous support spaces: storage, janitor closet, etc.

Historically, the inadequacies of the general (and special) housing areas have been the target of lawsuits and standards. Typical shortcomings cited about cells have included multiple occupancy and the resulting lack of personal safety when compensating supervision and operational steps are not taken; limited square footage of as little as 15 square feet per inmate; and a lack of personal privacy. Courts have found artificial lighting insufficient for reading, natural light frequently lacking, and general environmental conditions substandard.

The traditional arrangement of cellblocks -- principally the classic hack-to-back steel-constructed cellblocks surrounded by a barred officer corridor -- has been judged to be ineffective. Its deficiencies include limiting the officer's view and control; providing inadequate dayroom space; offering minimal true separation capabilities; and providing severely limited sound, odor, or smoke containment capabilities.

In recent years, general housing areas have changed considerably in character. The emphasis has shifted to an improved environmental quality and improved safety. It has also shifted toward creation of a more normal environment that tends to reinforce desired behavior, express more respect for the inmate, and provide better working conditions for staff.

Direct and constant view into all parts of the housing units is increasingly emphasized. The use of modern technology to provide better security and control in support of staff efforts is increasing, and a wider variety of materials are being used instead of the traditional steel bar and plate construction.

KEY DECISIONS

As the role of the general housing component is evaluated, the following decisions should be made since they have a fundamental effect on design requirements.

- What *classifications* of inmates will make up the general population of the jail? How will they be grouped and separated from each other? (See also "Classification/Separation" in Chapter 3.)
- What degree of *flexibility* in housing unit design will be required to accommodate fluctuations in the nature of the inmate population?
- What will be the occupancy level of inmate sleeping areas -- single occupancy, double occupancy, or multiple occupancy? (See also "Single vs. Multiple Occupancy" in Chapter 5.)
- Will each housing unit have its own *dayroom*? How many inmates will use it at one time?
- What surveillance or supervision methods will be used? (See also "Surveillance/Supervision" in Chapter 3.)

-
- What *programs and services* will be brought to the housing areas in lieu of moving inmates to the programs and services?
 - How will *emergency egress* be made from the housing units?
 - How will inmates with **disabilities** be accommodated and how must housing design concepts be configured?
 - How will *natural light* be introduced into cells and dayrooms?
 - How will *expansion* of bed capacity be achieved?

DETAIL ISSUES

The following discussion of detail functional-architectural issues is limited to the general residential areas of the facility, including female housing areas. Housing for special groups is dealt with in the section on "Special Housing," but many of the issues discussed here also apply to special housing areas.

The general housing functional-architectural issues are subdivided into several discrete areas:

- basic design;
- cell design;
- dayroom design;
- staff control post design; and
- miscellaneous design --
 - security vestibule,
 - showers,
 - storage, and
 - janitor closet.

BASIC DESIGN ISSUES

Activities

The following issues apply to the overall design of the general housing units.

ISSUE: Housing unit activities must be identified.

RESPONSE: Many varied activities occur within a housing unit. Some of the more typical activities include:

- sleeping;
 - attending to personal hygiene and grooming;
 - dressing;
 - storing personal articles;
 - talking with other inmates;
 - communicating with staff;
 - reading and writing;
 - recreating;
-

- cleaning and maintaining the area;
- eating;
- receiving and sending mail;
- watching TV; and
- telephoning lawyers, friends, and family.

The design must acknowledge the potential for less common events, including:

- emergency communications between inmates and staff,
- vandalous acts,
- escape attempts,
- contraband passage,
- assaults on inmates or staff, and
- emergency evacuation.

Note that the needs of disabled (physical, sight, hearing) inmates must be accommodated in all routine activities and atypical events.

Users

ISSUE: Changes in the makeup of the average daily population must be accommodated.

RESPONSE: Some flexibility must be built into the design to accommodate changes in the makeup of the jail population from year to year, month to month, and even day to day. This can be achieved by:

- subdividing the overall capacity of the general population area into smaller areas so there is enough flexibility to create "swing" units that can be assigned to different general residential populations -- high security or low, male or female.
- providing security equipment and hardware that can accommodate any of the assigned groups, although this tends to make the unit higher in security orientation. Consequently, lower security populations must be distinguished from higher security populations through different management approaches.

More on the issue of housing unit flexibility appears in Chapter 3 under "Classification/Separation."

ISSUE: Providing adequate housing capacity and environments for female inmates in small and medium-sized jails presents special problems because of their small numbers.

RESPONSE: Female inmates have historically represented less than 10% of the average daily population in a small or medium-sized jail, although the percentage has increased over recent years. Some smaller jails do not house female inmates beyond initial booking and holding because of inadequate separation capabilities, reluctance to dedicate a housing unit to one female, and/or the difficulties of providing same-sex staffing. Additionally, even

though there are usually few female inmates, their impact on bed space needs can be significant on days when several female arrestees enter the facility.

The key to handling this population is to create one or more small "swing" housing units that can be used for females, or for males when not needed for females. Since this area could contain high-security inmates of either sex, it should be under constant surveillance. Providing constant surveillance is also useful to ensure that male staff can supervise female inmates without fear of modesty conflicts or accusations of sexual misconduct.

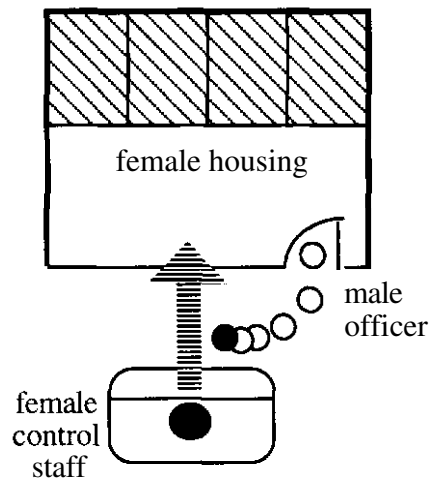

In facilities with a typically small female population, it is recommended that all female inmates -- including those on *work release* or *inmate worker status* -- be housed in the same area, although not necessarily in the same housing unit. Close supervision and management of this area will be required to ensure that inmate-to-inmate conflicts and contraband passage do not occur.

Movement

ISSUE: The degree of movement between housing units and other areas of the facility must be identified.

RESPONSE: Many activities occur in a jail besides the basic housing functions. If these activities occur elsewhere in the building, inmates and staff must move to them. Another approach is to have selected activities be part of the housing area complex or to actually accommodate them within the housing units. Consequently, the manner in which programs and activities are to be accessed is a critical element of housing area design.

Generally, it is beneficial to minimize the amount of movement that occurs in a facility. As the security level of the inmates increases, the management benefits of limited movement also increase. The following kinds of activities have been integrated into housing unit designs to minimize inmate movement.

- passive recreation (TV, table games);
- indoor exercise (e.g., basketball, volleyball, weightlifting);
- outdoor exercise;
- dining;
- counseling;
- sick call;
- visiting;
- telephone use; and
- video arraignments.

ISSUE: Movement should be controlled.

RESPONSE: Movement *within the housing units* and to and from other areas of the facility should always be under staff control.

To facilitate staff control of movement within the *housing area*, all cell, dayroom, and related housing area spaces into which inmates move should be controlled through doors with remotely operated locking systems. It is also highly desirable to have all doors in the housing unit under direct view, preferably from a constantly staffed post, as is characteristic of both direct-supervision and remote surveillance designs.

Even though a remote surveillance or direct-supervision staff position may have control over all housing unit doors, these doors should also be controllable by the Master Control position through an override function that neutralizes local control functions.

Movement to areas *outside the housing units* can be controlled as follows:

- Under direct staff observation (preferred)
- Under staff observation through CCTV monitors supplemented, as appropriate, by audio communication systems.
- By using a "pass" system that specifies an amount of time for an inmate to leave one point in the facility and arrive at another point, moving through areas not directly observed by staff or through areas indirectly observed by CCTV monitors.

ARRANGEMENT

ISSUE: The arrangement of housing unit spaces should facilitate control and movement.

RESPONSE: Some general arrangement considerations that facilitate surveillance and control include the following. Other considerations are discussed in Chapter 3 and later in this section.

- All primary spaces should be **observable** by staff from outside the housing unit area. These spaces include cells, dayrooms, egress doors, showers, and associated program or support areas.



Good view of cell fronts, dayroom, and shower (to left) from staff control position.

- **Non-housing activities** associated with the housing units must be easily accessible and within view of staff outside the housing and activity areas.
- **Blind spots** should be avoided or minimized to the greatest extent possible.
- In designs where **two tiers** of cells share a common dayspace:
 - The design should provide a workable **view angle** toward second-tier spaces, even if this requires a raised staff position.
 - Stairs providing access to the second tier should have **open risers** to allow view behind the staircase.
 - Second-tier **railings** should allow view through to the cell faces, but be high enough (**42 inches +**) to provide adequate safety for persons on the walkway.
 - **Walkways** should be wide enough to allow easy movement where out-swinging cell doors are used, but not so wide as to unduly limit view from staff positions.

- *Mid-level* dayrooms should not obscure views or provide hiding places at the lower-tier level.

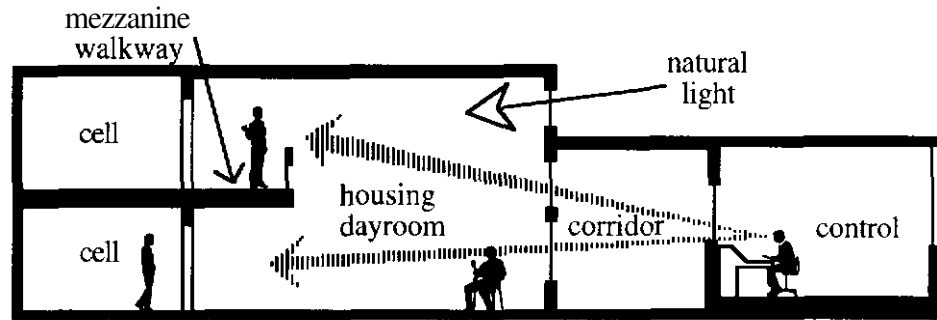

Some designs feature "sunken" first tiers so that access and staff positions are essentially at a second-tier level.

- Access to housing units should be through either a *security vestibule* or an adjacent corridor that serves as a control corridor by effectively separating the housing area from other portions of the building.
- *Emergency egress* routes from the housing areas should not only be standards compliant, but easily accessible and controllable. An important element of egress that affects arrangement is the provision of two ways out of all cellblocks where required (desirable everywhere).

A key aspect of creating an egress door between housing units is doing so in a manner that inhibits sound transmissions and prevents contraband passage. Another consideration for egress is the possible need for, or use of, a second means of egress off the second tier of a two-tier housing unit. This implies that protected stair towers be integrated into the arrangement of the housing unit.

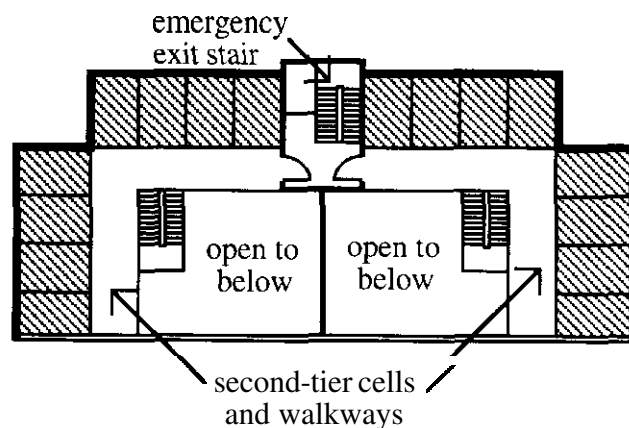

Security

ISSUE: Inmates must be protected from violence, assault, and exploitation by other inmates.

RESPONSE: Following are essential considerations in designing to protect inmates from each other.

- A classification system and a range of *separate housing units*. (See also the "Special Housing" component in this chapter.)
- Selection of a *mode of supervision* based on careful analysis of the relative strengths, weaknesses, and efficiencies of the three most common combinations of architectural styles/supervision approaches (remote surveillance, direct supervision, and linear intermittent) and their applicability to different classifications and groups of inmates.
- Adequate numbers of qualified and trained *staff*.
- Choice of cell or dorm *occupancy* level to provide appropriate inmate safety and reduce the chances of inmates being exploited, coerced, or assaulted by other inmates.

ISSUE: Differences in security and custody levels should be considered in the design of the physical environment.

RESPONSE: Even the general population of the jail consists of different behavioral types, each of which poses different levels of security risk and custody needs. These can be accommodated through varying approaches to design.

The key issues that influence design revolve around classification, surveillance, and staff. In facilities that provide inadequate classification and separation capabilities and are intermittently monitored, the physical plant must provide greater levels of security. Without constant staff control, however, it is difficult to decide what is truly "enough" physical security.

Regardless of the inmate type or the surveillance mode employed, the basic *security envelope* of the housing area should always be adequately constructed to prevent escape and control contraband passage. Consequently, major physical differences due to surveillance and custody level principally occur *within* the housing units.

Examples of some of the chief areas of difference within the housing areas of the general population are given in the following table, *assuming constant surveillance or supervision*. These examples are not meant to describe the full range of options available, only to illustrate general differences in physical security. It is conceivable that the options under "lesser physical security" could be applied to high-security groups or vice versa. The key to security is classification, staff presence, and the surveillance/supervision approach.

Sample Variations in Design Approach

	<u>Greater physical security</u>	<u>Lesser physical security</u>
View to exterior	To controlled exterior space, or not provided	To outside
Access to adjacent program areas	Controlled at all times	Free movement at some or all times
Entry vestibules	Yes	No
Floor	Concrete, terrazzo	Carpet on secure base, vinyl composite tile (VCT)
Interior cell partitions	Concrete; reinforced, grouted concrete masonry unit (CMU)	CMU, cement plaster on metal lath
Cell ceilings	Concrete	Cement plaster on metal lath, acoustic metal
Dayroom ceilings	Concrete, cement plaster on metal lath, steel panels	Acoustic tile or panels, two layers of gypsum board (assuming adequate ceiling height & dayroom perimeter secured by other means)
Interior dayroom/ cell face glazing	Glass-clad polycarbonate or equal	Laminates of strengthened glass, tempered glass
Furnishings	Fixed detention type	Non-fixed institutional or commercial
Cell doors	12- or 14-gauge steel	14- or 16-gauge steel reinforced or solid-cure wood
Cell locks	High-security remotely operated	Low-security detention or heavy-grade commercial remotely operated (durability the issue)
Plumbing fixtures	Stainless steel combo sink/toilet, stainless steel shower cabinet	Vitreous china sink and toilet; CMU shower with sealer, and pre-made base
Light fixtures	Detention type	Detention type, some inmate control in cells

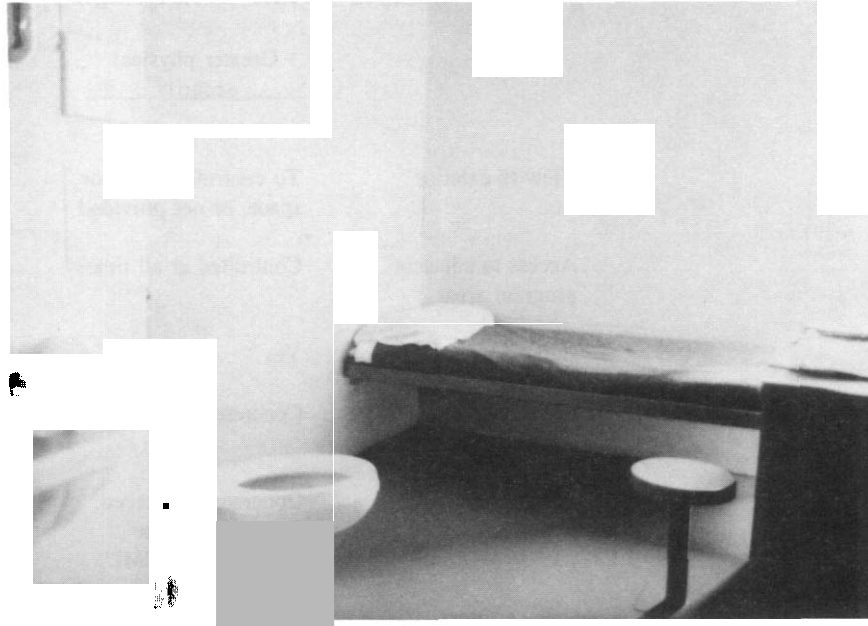

Cell with mix of "greater" and "lesser" physical security: fixed detention furniture, but vitreous china plumbing fixtures.

ISSUE: Physical safety of staff must be provided.

RESPONSE: Physical safety of staff is an often overlooked element of housing area design. Depending on the **surveillance/supervision** approach used, some design considerations may include:

- enclosed, secured staff posts.
- direct visual backup of staff entering or **working** around housing units.
- solid, security-glazed partitions to allow vision but prevent physical contact, coupled with intercoms or speaker boxes for **communication**.
- body alarms, **walkie-talkies**, and/or panic alarms linked to secured, constantly staffed posts such as Master Control.
- CCTV and audio backup to Master Control.
- design of **locking** systems to minimize escape potential if a roving officer or the housing area **control** officer is assaulted by inmates (e.g., all locks remotely operated so that the roving officer has no keys, or keys only to immediate areas but no exit keys).

- secured openings (pass-throughs) through which items exchanged between staff and inmates can be passed without entry into the housing unit:
 - food, drinks;
 - clothing, linens;
 - mail;
 - packages;
 - paperwork, including sick call requests, commissary slips, etc.

Environmental

ISSUE: The need or desire for natural light in housing areas should be balanced against security concerns.

RESPONSE: All inmate cells and dayrooms should have exposure to natural light and, if possible, a view. Both are valuable conditions conducive to good physical and mental health and to a more normal appearing environment that encourages or reinforces more normal behavior. Providing natural light, however, also poses potential security or management problems:

- escape,
- contraband passage,
- vandalism,
- view conflicts with persons outside the facility, and
- view conflicts between housing units.

The greatest problems occur with *cell windows* since cells are generally a less observable part of the housing area in many new designs and penetration of the window frequently results in penetration of the main security envelope.

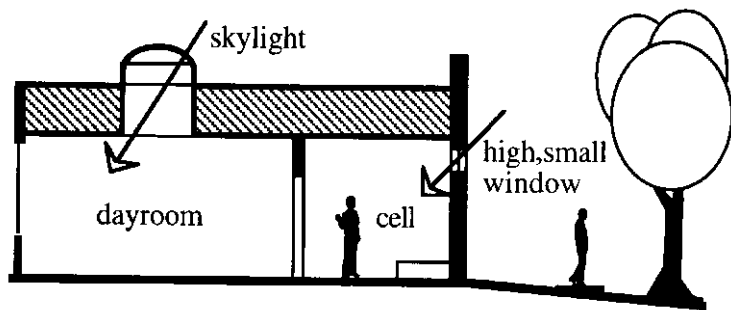

Principles of cell window design can help mitigate escape, contraband passage, and vandalism problems.

View conflicts with cells and dayrooms can be controlled by:

- orienting windows toward interior courtyards or screened areas;
- placing windows high in the wall; or

- using reflective or heavily smoked glazing products to limit view, especially during daylight hours.

One way to minimize window security problems is to introduce "*borrowed light*" to the cells from other spaces, rather than provide a window in the cells. Historically, this was done by placing cells on the interior of the housing area (typically back-to-back with other cells, divided by a chase) and separating them from windows by a **dayroom** and a perimeter corridor. An aesthetic value to this was that the **dayroom** -- the place where inmates spend the majority of their daytime hours -- received the most natural light.

A common problem with this approach was that the windows were typically limited in size and heavily screened to minimize escape potential and eliminate view conflicts. Consequently, limited amounts of light and view were afforded occupants of the cells. It also tended to negate remote surveillance possibilities in which a full view of cell fronts and some portions of the cell interiors was provided from a point outside the housing unit.

A variation on the borrowed light concept for remote surveillance housing designs is to use clerestories, skylights, and adjacent outdoor areas to introduce natural light in significant quantities instead of cell windows.

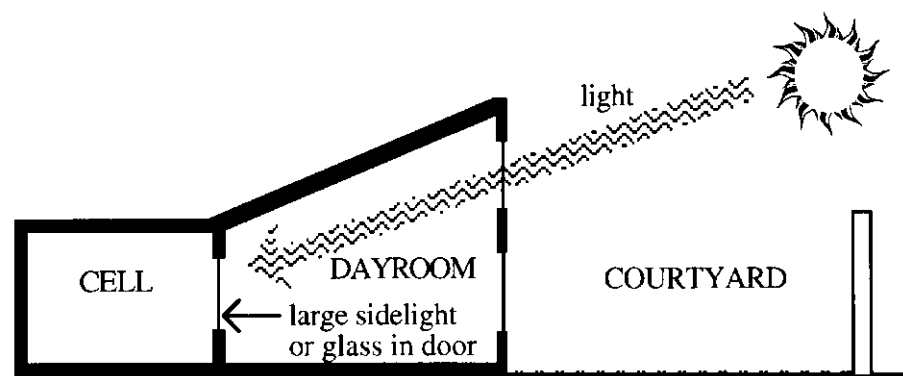

Even then, the amount of light actually entering the cells would still be limited, especially if privacy demands meant that the cell face (walls and door) was largely solid.

To introduce natural light directly into cells but fully eliminate view conflicts, some facilities employ translucent or obscured glazing, thereby sacrificing all view. This tends to occur most often with ground-level cells on restricted urban sites where the possibilities for controlled exterior areas are limited.

If natural light is provided in the **dayroom** via a window or clerestory, it is preferable that the light not shine directly toward the officer outside of the housing unit. Otherwise, the glare from the light source could increase eye

strain and reduce effective view control. If the window or clerestory is out of the officer's view, it should also be inaccessible to inmates.



Dayroom clerestory shining toward cells (on right) and not toward the officer's vantage point.

ISSUE: Basic environmental needs should be accommodated.

RESPONSE: The environmental quality of housing areas can make them more "livable" and influence inmate behavior. Cooperative, calm behavior is not reinforced by noisy, cold, dark areas thick with unpleasant odors. Most state jail standards and building codes require basic environmental quality.

Some special considerations for jail housing areas follow.

- **Sound.** Sound quality is one of the more difficult environmental problems, resulting from the typically hard surfaces and many sources of sound:
 - electric locks (solenoid and motorized);
 - slamming doors, sliding doors;
 - electronic communications (intercoms, public address);
 - showers;
 - toilets;
 - TVs, radios.

These frequently combine to produce high sound levels and, with hard surfaces, **generate** reverberations (echoes) that can obscure conversation and be imtating to both inmates and staff.

Some solutions:

- More textured surfaces -- concrete masonry units (versus concrete or steel plate), acoustic ceiling panels, carpet on floors or selected wall surfaces.
- More irregular surfaces -- e.g., angled walls, pan joist structural systems.
- Solid cell and **dayroom** faces (block, hollow metal/wood doors, security glazing) instead of bars or grating.
- Quieter locks -- electric motor or pneumatic versus solenoid.
- Swing doors instead of sliding doors.
- Showers pocketed within the construction rather than steel shower cabinets in and facing the **dayroom**.
- **TVs** with localized speakers controlled by staff, rather than inmates.
- Separate TV watching rooms adjacent to the **dayroom**.

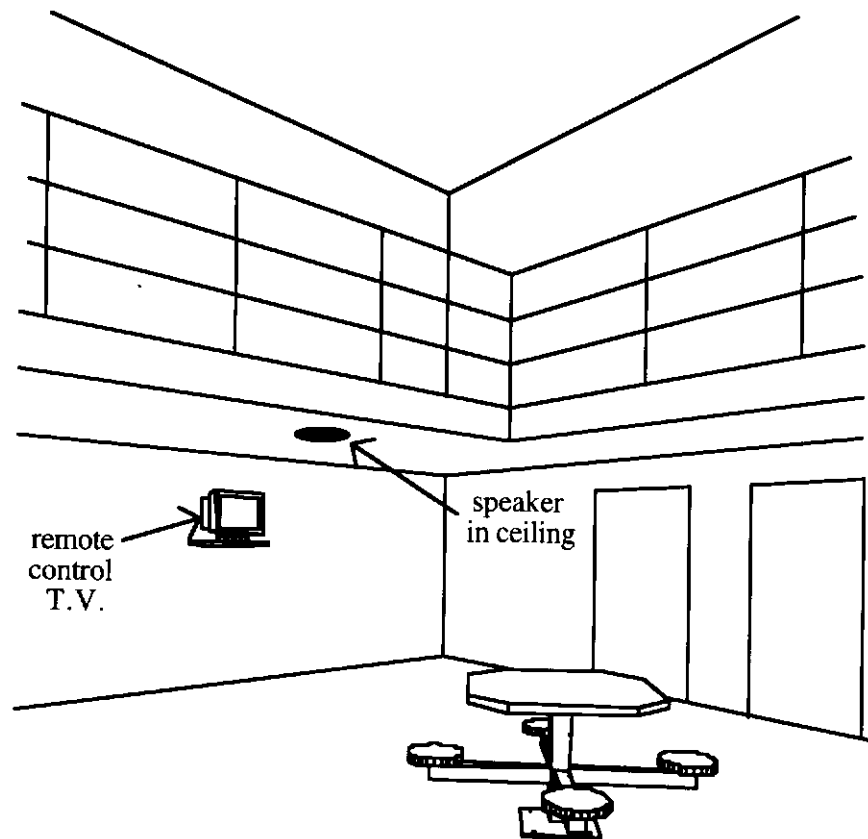

- **Artificial light.** Historically, artificial light has been a problem because of its insufficiency in providing adequate lighting and its constancy. The latter frequently results in vandalized fixtures when inmates get no relief from light at night.

Some solutions:

- Provide night lighting capabilities in cells and dayrooms that allow primary lighting to be shut off.
- Provide selected categories of inmates some control over their cell lighting.

Avoid light sources that shine toward the jail officer viewing into the area.

- Avoid lighting with sources with unnatural light spectrums, such as high-pressure sodium fixtures that are energy efficient but more suitable to street lighting because of their yellowish color.
 - Provide staff with control of the lighting in 1) their spaces, 2) adjacent housing area corridors, and 3) the housing units, for good vision and reduced eye strain.
- **Temperature.** Complaints about temperature most frequently relate to that in cells. This is because cells are often made of hard, cold surfaces, do not have individual temperature control, and are on an exterior wall. In addition, their heat source is normally at the front of the cell, the opposite of typical building practice. The design process should evaluate ways to get the heat to the outside wall and at the floor in a vandal-resistant manner.

Fire Safety

ISSUE: Fire safety is a critical consideration in the design of housing areas.

RESPONSE: Most injuries and deaths resulting from fire or smoke inhalation at jails occur in the housing areas. The National Fire Protection Association's *101 Life Safety Code* specifically addresses jail safety issues. Reference to it, a thorough review of local codes, and consultation with fire inspection officials early in the design process are strongly recommended.

There are several special issues to consider besides providing proper means of egress and proper detection, alarm, and suppression systems:

- Use fire retardant, non-toxic materials wherever possible and consistent with general design/environmental goals.

- Provide a place to store extinguishers and air packs that is easily accessible to all staff positions.
- Provide backup keys in a secure area outside the jail perimeter.
- Provide emergency group unlocking capabilities in all housing units, with Master Control override.
- Consider developing fire zones within the facility perimeter to prevent emergency release from the building being the only option. Also, consider creating an outdoor retention yard that might also be the outdoor exercise area.

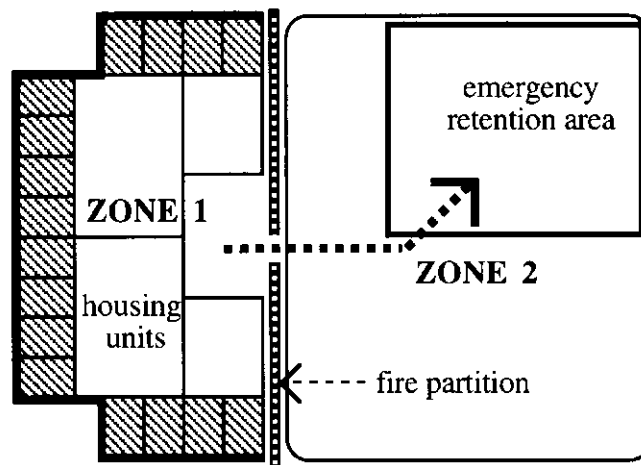

- Avoid open, barred, or grilled cell and dayroom fronts since they are incapable of providing any fire or smoke containment.
- Consult with local fire inspectors on the use of security glass and pass-through openings at housing unit dayroom walls since they frequently abut egress corridors, thereby potentially conflicting with fire ratings for those walls. Variances may have to be sought on the basis of security need and be justified by the provision of a full range of detection, alarm, suppression, and evacuation measures.
- Create "no smoking" facility or contain **smoking** in specified areas.
- Install built-in electric cigarette lighters for inmate use to eliminate the need for matches and lighters in inmate-occupied areas.
- Use flame retardant, non-toxic mattresses and pillows.
- Consider how fire fighters will gain access to various parts of the building.

**Plumbing
Considerations**

ISSUE: The need for plumbing fixtures depends on the operation of the housing unit.

RESPONSE: It is generally accepted, and required by most standards, that **all** cells and dayrooms must have toilet and sink facilities. However, the key issue regarding their location is one of *access*.

Cells generally have toilet and sink fixtures because there is an expectation that inmates will be locked in their cells at night and have no alternative. However, the possibility exists with constantly monitored areas backed up by roving officers (especially direct supervision areas) that inmates could use centralized facilities at night. This seems feasible because inmates use centralized facilities **and/or** cell facilities without incident during the day when many more activities and distractions are occurring.

Having centralized facilities rather than in-cell facilities (thereby creating *dry cells*) does not necessarily preclude the ability to lockdown inmates during disturbances or inspections since inmates can be individually released through remotely controlled cell-locking mechanisms. Also, additional staff are typically assigned to the facility during disturbances and inspections to provide necessary security support and thus offset potential problems.

Toilet and sink fixtures accessible from the *dayroom* are required when the operation of the housing unit includes denying inmates access to cell fixtures for significant portions of the day (or when there are no fixtures in the cells). If such an operational approach is not, and never will be, adopted, toilet and sink fixtures in the dayroom are merely a convenience.

ISSUE: Potential problems with damaged or inoperable plumbing fixtures must be accommodated in design.

RESPONSE: Some considerations follow.

- Provide floor drains to accommodate accidental or purposeful spillage from fixtures in cells or dayrooms. Drains should be placed outside cells to minimize inmate attempts to block them.
- Make pipe chases readily accessible to maintenance staff and sufficiently large to allow easy repair.
- Locate shutoff valves strategically to allow staff to stop water flow in specific areas. One such location might be a secure space accessible from outside of the building to provide some level of control in the event that inmates take over the jail.

SLEEPING AREA
(CELL/DORM)
DESIGN ISSUES

The following functional-architectural issues apply to inmate sleeping areas, both cells and dormitories.

Occupancy

ISSUE: Sleeping area occupancy is determined by the agency's philosophy and supervision-surveillance approach; by inmate behavior, classification, and custody levels; and by construction costs.

RESPONSE: Perhaps the most significant decision regarding the design and operation of a new jail is that of sleeping area occupancy. This choice measurably affects initial construction cost and significantly affects long-term operations and staffing.

The options available to a jurisdiction generally include:

- single occupancy
- double occupancy
- multiple occupancy (3 to 50 occupancy).

The word "cell" has classically been applied to inmate sleeping areas of 1-4 occupancy that are separate from an inmate **dayroom** in which showers, dining/recreation tables, and TVs are located. The word "dormitory" is generally applied when sleeping and **dayroom** functions are merged together, or when the sleeping room occupancy reaches 8 even if there is an adjacent **dayroom**.

The principal argument for using double- or multiple-occupancy settings is construction cost savings. The arguments against them, as compared to single occupancy, are:

- less ability to ensure inmate safety from physical or sexual assault;
- inability to isolate inmates during fights or disturbances;
- greater demand for maintaining a constant staff presence during sleeping hours, whereas in single cells inmates can be locked-down at night and checked intermittently by roving staff;
- more difficulty in protecting inmate property from theft;
- less accountability for **cell/dorm** damage; and
- elimination of an inmate's principal source of privacy.

The general inmate population is the group for whom the **single/multiple**-occupancy debate most typically occurs. This is because most of the special housing populations discussed in the next section are more clearly **single**-occupancy candidates (**disciplinary** detention, medical isolation) or **multiple**-occupancy candidates (inmate worker, work releasee).

The challenge to most jurisdictions is to determine whether initial cost advantages during construction justify potentially greater operational and staff cost challenges over the operational life of the building.

For more on this subject, see the "Single vs. Multiple Occupancy" section in Chapter 5.

Size

ISSUE: Sleeping area size is shaped by activities, equipment, and individual needs.

RESPONSE: ACA standards and some state standards require a minimum square footage for sleeping areas. These requirements are not uniform and often vary per the occupancy level of the sleeping area.

Sleeping area size is also influenced by the amount of time an inmate is confined to the area per day. Cell size should be based on the activities to occur in the cell and the type of furnishings and equipment selected for use.

Activities

Activities that might influence cell size include:

- sleeping;
- reading and writing;
- grooming;
- storing personal belongings, toiletries;
- using the toilet;
- doing limited calisthenics (e.g., push-ups, sit-ups);
- eating (this is not recommended for general population cells),

Equipment

Equipment options that can influence cell size include:

- **Bed size.** Beds sufficient in length and width to accommodate taller, heavier people may dictate special designs that exceed the approximate dimensions of the standard detention bunk (80 by 27 inches).
- **Bed arrangement.** Bunk beds used in multiple-occupancy settings demand less floor area than separate beds.
- **Desk surface.** Minimal desk surfaces, as offered by detention equipment manufacturers, provide approximately 2 to 4 square feet. If more desk surface area is needed, a fabricated surface may provide more square footage and thus require more area in the cell. Smaller detention desks with angular wall supports are not recommended if the angle interferes with desk use.
- **Seating.** Desks are frequently accompanied by a fixed or movable stool or chair. If fixed, an established area of the floor is committed. Swing-out stools are available on some detention desks, and some designs allow the bunk to serve as the seat.

- **Storage.** Storage for toiletries, books, paper, pens, pictures, clothing, etc. is essential to maintaining a neat and sanitary cell environment. Shelves and collapsible hooks create no special space demand, while lockers or storage drawers do demand floor area.
- **Plumbing fixtures.** A toilet and sink occupy square footage. Besides the possibility of a pipe chase intrusion (which is typically outside of cell square footage requirements as defined by standards), the key space-defining issue is whether a combination toilet/sink or more normal, but space-occupying, separate fixtures will be used.

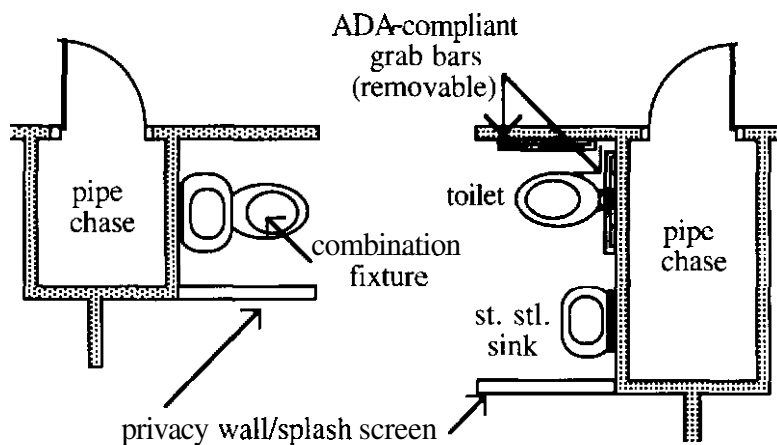

Providing a par-height privacy wall or splash screen between the fixtures and the bed may also require slightly more space.

Showers are typically not placed in general population cells because of expense, sanitation complications, and security. Consequently, no space is typically needed for showers.

Psychological Needs

Psychological needs involve the sense of confinement created by the cell space in particular. These concerns and the need for more space as compensation can be minimized by:

- "extending" the sense of space through the use of sizable cell windows and/or vision panels in the face of the cell (without sacrificing minimum privacy or security);
- using ceiling heights moderately higher than the typical 8 feet, which also has the advantage of allowing ceiling sprinklers and light fixtures to be placed at less accessible heights, thus reducing vandalism potential;
- avoiding unusually narrow cells that disproportionately accentuate room length; and

- using light wall and ceiling colors.

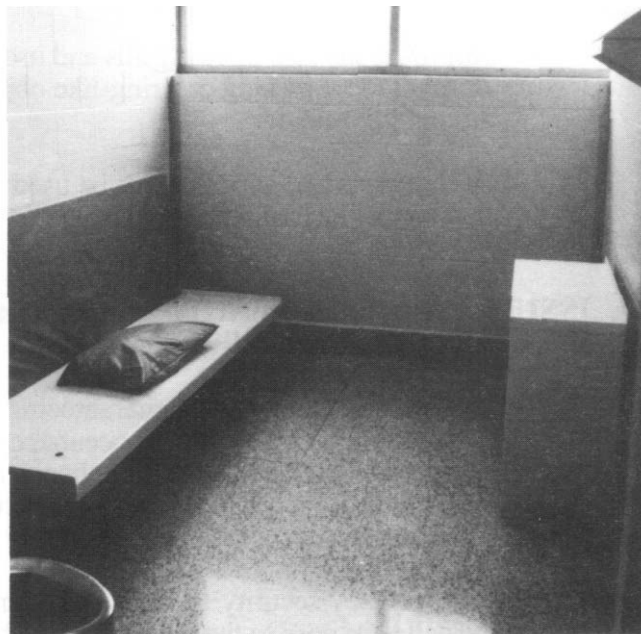
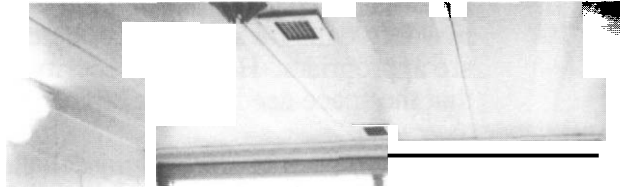

Large cell windows extend the sense of space.

Security

ISSUE: Regardless of the classification of inmates, all sleeping areas must be designed with security in mind.

RESPONSE: Cells and dormitories are places where inmates spend a significant portion of their day. They are frequently located on exterior walls at points in the housing unit farthest from view (as with remote surveillance or direct supervision) or even out of the view of staff standing in, or moving through, adjacent corridors (as with traditional linear intermittent design). Consequently, they provide the best opportunities for escape attempts, vandalism, suicide attempts, and/or contraband passage. A variety of considerations can help minimize these problems.

- Pay particular attention to the security design of the sleeping area window if used. Refer to the "Security Construction" section in Chapter 5 for more information.
- If the cell is on an exterior wall, ensure that the exterior wall is of secure construction. If a concrete masonry unit wall is used, the wall should be reinforced and grouted.

- Use sturdy and vandal-resistant materials within the cells. Such materials as concrete or vinyl tile on concrete floors, concrete masonry units for walls, and concrete or cement plaster for ceilings are appropriate. However, security in this instance does not imply that the space need be dark or grim.
- Securely fasten in place all miscellaneous equipment and hardware in the cell or **dormitory**: outlet covers, intercom covers, vent grills, mirrors, shelves, door stops, etc.
- Minimize the size of vent grills and use a security grill that makes it difficult to tie a string or string-like object through the grill for attempting suicide.
- Avoid joints and gaps that can be used to hide contraband in places that cannot be easily checked by staff.

Security/Privacy

ISSUE: A balance must be struck between inmate privacy in the single-occupancy cell and the need to observe the cell.

RESPONSE: A key element of guaranteeing a degree of privacy is to create single-occupancy cells. Single-occupancy cells (in association with a **dayroom** to prevent isolation) tend to enhance rather than diminish security, as has been noted earlier and is discussed in Chapter 5 under "Single vs. Multiple Occupancy."

The primary privacy-security conflict comes in deciding how much of the face of the cell to expose to the **dayroom** and thereby to staff in the adjacent corridor or control position. The options range from precluding any view of the cell to opening up the entire face of the cell (the classic approach to cell design). However, if any balance between privacy and security is to be attained, the proper approach falls somewhere in between.

The main privacy concern that guides the choice of cell front design is exposure of the inmate using the toilet to both staff and inmates passing the cell, particularly those of the opposite sex. This is a special problem in cells designed with fixtures toward the front of the cell, where they cannot be internally screened. Locating the toilet at the rear of the cell has an advantage in this regard since part-height screens (about 44 inches high) can provide minimal privacy while allowing a view capability and a more liberal opening of the cell face.

Two other cell privacy concerns involve minimizing exposure while sleeping and dressing. Related to those concerns is a simple environmental concern of minimizing the transference of light between the **dayroom** and cells during evening and sleeping hours.

Regarding security, the issue of needed exposure depends on the classification of the inmates involved and on the method of observing and managing

the cells. If staff frequently enter the housing unit to closely examine the cells when inmates occupy them, exposure of the cell interior to remote view becomes far less critical.

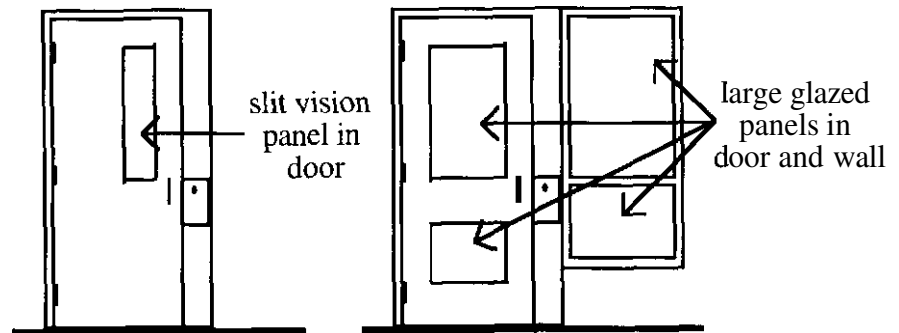

One additional privacy concern involves the (indecent) exposure of inmates through exterior cell or housing area windows. Besides the view conflicts involved from the public's side, the inmates' privacy is infringed when the public can readily see into cells from the street or adjacent buildings.

ISSUE: Some semblance of privacy should be achieved in multiple-occupancy settings.

RESPONSE: By its very nature, fundamental privacy cannot be attained in multiple-occupancy settings. However, some small steps can be taken to provide minimal levels of privacy:

- provide a privacy or splash screen between toilet areas and the bed and desk areas of the cell or dorm.
- provide privacy partitioning, creating small groups of beds (2 to 4) in large dormitory settings.
- provide separate shelving or lockable storage compartments for each inmate.
- provide study or reading carrels or alcoves in adjacent dayrooms.

**DAYROOM
DESIGN
ISSUES**

The following functional-architectural issues apply to dayroom areas -- the central activity areas around which a group of cells is clustered to create a cohesive housing unit.

Location

ISSUE: **Dayrooms** should be located to ensure ease of inmate access and to preserve separation capabilities.

RESPONSE: Dayrooms should be located adjacent to and immediately accessible from the cells or dormitories they serve. There should be one dayroom for each group of cells. Such design minimizes inmate movement

and eliminates the security problems posed by the shared use of a dayroom by different classifications of inmates and by dayrooms separated from the housing units.

Size

ISSUE: The size of dayrooms is dictated by the activities to occur, functionality, and aesthetic concerns for proportion.

RESPONSE: The ACA standards require that dayrooms provide certain square footages. Most often these square footages are based on the number of beds in the housing unit served by the dayroom. In some standards, the square footage is defined by the maximum number of inmates using the dayroom at one time. In the latter case, note that a decrease in dayroom square footage achieved by reducing the number of inmates allowed access to the dayroom at one time may be offset by an increase in cell size requirements because inmates are confined there for a greater part of the day.

In small housing units, typical dayroom square footage requirements can result in little more than a narrow 5- to 6-foot corridor along the front of the cells. In most cases, this is not satisfactory given the kinds of activities desired for this space; the simple functionality of moving through, living in, and working in the space; and the desire for a well-proportioned room.

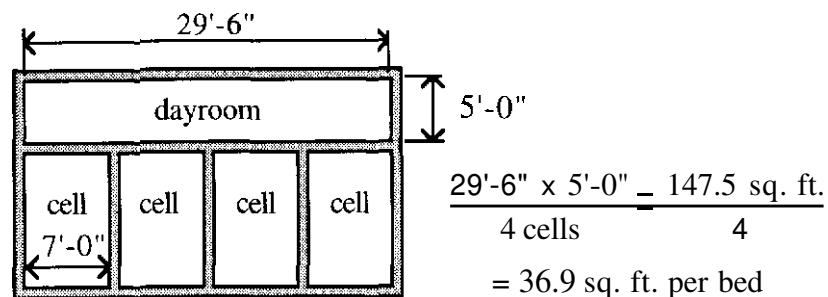

The actual size of a dayroom should depend on a variety of practical design considerations. Activities that might occur in the dayroom and therefore help define its size requirements include:

- eating and snacking,
- reading and writing,
- conversing,
- TV watching,
- telephoning,
- exercising (calisthenics, weights)?
- passive recreating (table games).

Some activities that take place as part of the overall housing unit *should not* occur in the dayroom unless all inmates in the housing unit are involved in the activity: counseling, religious services, and other group program activities. Also, private program activities such as visiting, individual counseling, and medical checkups should not occur in the dayroom.

Tables and seating provided for inmates are another key determinant of dayroom size. Most standards, and good practice, require sufficient tables and seating to accommodate every inmate housed in the unit, including those who are wheelchair-bound. This is particularly critical if dining occurs in the dayroom. Additionally, sufficient space to move around the tables and seating to gain access to exits, cells, and activity areas is crucial.

The question of table placement becomes more critical when *two-tier housing units* are created. One of the basic ideas behind the two-tier units is to reduce the need for dayroom space. However, in a housing unit with limited capacity, the intrusion of the stairs to the second tier can unacceptably diminish the workability of the dayroom layout. This is more true when a security vestibule and a shower area also intrude into the dayroom.

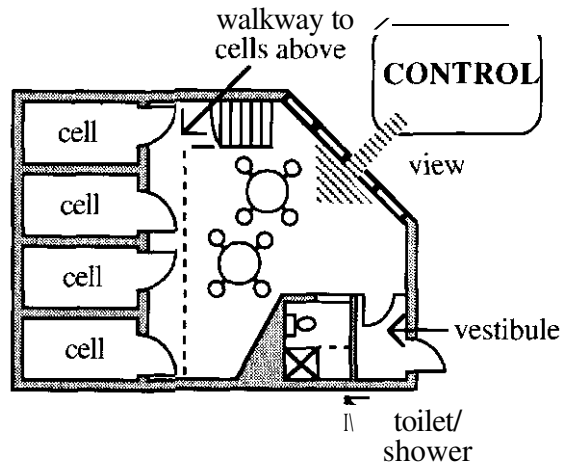

Another size consideration concerns *temporary activities* that occur in the dayroom. One example would be the extra space needed at meal time for food carts, trays, and meal distribution in each dayroom.

The size of the dayroom is also influenced by pieces of *equipment* and their placement: televisions, telephones, electric cigarette lighters, service counters, etc. Some of these items need to be separated from each other and from other functions in the dayroom. For example, telephones should be located as far as possible from the television and other noise sources, as well as positioned to provide proper view angles. To achieve this, the TV cannot be placed too high on the wall and there should be some distance between it and the nearest table. However, TVs should not be placed so low that they obstruct movement or officer view of the area.

Miscellaneous Furniture and Equipment

ISSUE: Miscellaneous furniture and equipment should be identified for proper placement in the dayrooms.

RESPONSE: Besides the tables and chairs used by inmates and major items such as televisions and telephones, several other types of equipment must be accommodated in the dayroom:

- waste containers;
- bulletin boards for notices and information;
- intercoms for communication with staff; and
- CCTV cameras, as appropriate.

INMATES WITH DISABILITIES

ISSUE: The needs of non-ambulatory, wheelchair-bound inmates must be accommodated in the housing units.

RESPONSE: If the facility is to hold non-ambulatory, wheelchair-bound inmates, certain special requirements must be met in their housing units and throughout the facility.

Disabled inmates share all of the behavioral and custody characteristics of other inmates, and housing units must be designed to accommodate them at different custody levels. The law prohibits housing disabled inmates according to their disability alone, e.g., in a housing unit designed to accommodate all disabled inmates or an isolated "disabled cell." This is a significant consideration in the small and medium-sized jail since it means that most, if not all, housing units must be designed to accommodate the needs of the disabled. This is true even if the number of disabled inmates detained in the course of a week, month, or even a year, is quite low, perhaps less than 10, as has been reported by many small and medium-sized jails.

The most common housing area design challenge comes with respect to inmates confined to wheelchairs. Local, state, and federal codes and standards in this regard must be researched prior to design, but special design considerations include the following.

- All *doors* leading to the housing area and the cell must be wide enough to allow the passage of a wheelchair. Additionally, sufficient room must be allowed on the **latch side** of doors, especially when they swing toward the user, to allow access, opening, and maneuvering room.
- If staff are not in a position to assist the inmate, *door closers* should not be set at a tension level that makes opening by the disabled inmate difficult.
- Toilet and sink fixtures in the cell should be *separate fixtures* that accommodate the needs of the disabled inmate. For example, grab bars or a means by which the inmate can access toilet fixtures should be provided. If grab bars are used, consider making them demountable so they do not pose a security problem with non-disabled inmates who might use the cell.
- Central *shower* areas and toilet areas should be accessible to the disabled.

- Cell desks and a position at the dayroom tables should be accessible to the disabled. This implies that the use of a fixed stool may be inappropriate in the cell and at least one position at the dayroom tables should be either a *moveable chair* or a *swing-out security seat*.

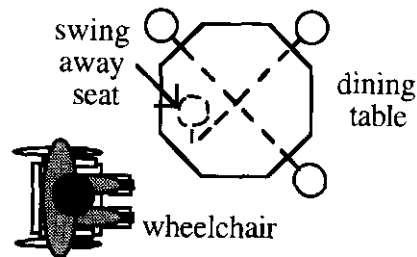

- *Features* in the dayroom or housing area, such as intercoms and telephones, should be accessible to a wheelchair-bound inmate.
- *Ramps* at points of entry/egress to the building should be considered (e.g., main entry, sally port, exercise areas).
- All *program and service* areas should be accessible to the disabled.

ISSUE: Forms of disability other than non-ambulatory and wheelchair-bound must be accommodated.

RESPONSE: When most people think of inmates with disabilities, they think exclusively of people who are wheelchair-bound. The ADA, however, identifies many other conditions that are considered disabilities and should be considered in the design and operation of new jail facilities. Two examples of disabilities with an impact on facility development are **hearing and sight impairments**.

Hearing Impairments

Since many modern jails rely on electronic communications (intercoms, public address systems, telephone visiting, fire alarms, television monitors), communication with hearing-impaired inmates can be lost unless special steps are taken in selection of equipment and/or operational policy. Several physical plant features can be incorporated that respond to daily and life safety needs in housing areas:

- have available TDD (Telecommunications Device for the Deaf) style telephones for telephone visiting;
- install fire alarm systems with visual effects (e.g., flashing lights), as well as audio systems that can be "felt" through sonic vibrations;
- install television monitors with closed caption capabilities;

- create orientation tapes that convey facility rules through presenters who sign, as well as with closed captioning; and
- install electronic message boards within view of cells and dayrooms that can be used to convey routine messages (e.g., visiting hours) as well as information usually expressed orally.

Visual Impairments

Several facility development considerations with respect to inmates having visual impairments are:

- provide Braille signage on cell doors;
- post a Braille version of key facility rules and policies;
- design cell and especially dayroom areas sufficiently spacious to allow easy, clear paths of travel around furniture and equipment and to emergency egress routes;
- if necessary, issue canes that are approved by facility administration;
- locate cells designed for those with disabilities near shower/toilet areas and egress routes.

STAFF CONTROL POST DESIGN

Size/Activities/ Types

The following issues pertain to staff posts that observe or supervise housing units.

ISSUE: The size of staff control posts depends on staff activities and the surveillance/supervision mode used.

RESPONSE: The staff in charge of observing and supervising housing units have a variety of responsibilities, which typically include:

- observing and supervising inmates;
- report writing;
- record keeping;
- storing and maintaining manuals, directories, and similar materials;
- responding to inmate complaints and needs;
- communicating with other staff in the facility via intercoms or telephones;
- observing and controlling activities in and around the housing units: food service, laundry pickup, counseling, movement to court or visiting, maintenance, etc.;

- monitoring alarm and other security systems;
- responding to emergency situations;
- controlling doors, lights, heat, ventilation, communications, and/or security systems within the housing units;
- managing the supply needs of the housing units

Direct Supervision

With *direct supervision*, there is no need for a separate staff space, merely an area and a work surface in the housing unit. The control post work surface has a limited number of controls required by the officer and provides a limited amount of space for paperwork, books, manuals, and miscellaneous items needed by the officer. It should also have lockable drawers and files. Staff toilet areas are in a separate space.

Remote Surveillance

The staff posts in a *remote surveillance* setting are frequently the largest, particularly when they are enclosed. This is because the staff space must function as a self-contained operation. Within it must be all of the control panels used to manage locks, lights, alarm systems, etc., plus records, files, and work surfaces for report writing and equipment (telephones, intercoms). If the control post is fully enclosed, it should provide toilet facilities for staff accessible from within the control space. Open-counter remote surveillance posts tend to require less square footage since toilet facilities are not required within the post itself. Remote surveillance control posts are frequently more spacious than necessary given the need for a strategic location that provides staff with a view into a variety of surrounding housing units or activity areas.

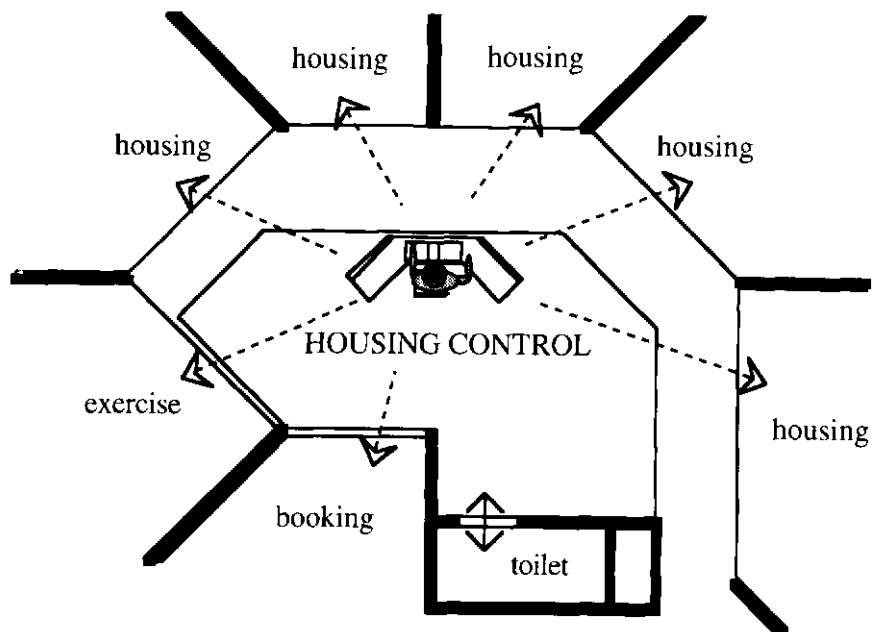

Even though the post may be larger than truly necessary, the additional space should not go unused. Within the remote surveillance space can be a variety of *under-counter storage areas* that help solve some of the chronic problems of insufficient storage in jails.

It is important to realize that although the size of a remote surveillance control post may be larger than necessary, there is generally only **one point** in that space from which the officer typically works. That is, there is only one point where the officer's equipment for controlling locks, lights, etc. will be located. Therefore, even if the size and arrangement of the control post tend to suggest that total view control is obtained, the true location from which the officer will operate controls must be pinpointed with the sufficiency of views then considered from that point.

Intermittent

With *intermittently monitored* facilities, the size of the staff post can be restricted to its basic needs since the design of the post is not, by concept, influenced by a need to create any specific physical or view relationship with the housing units. Its space requirements are shaped by its need for a desk surface for control panels and report writing; record storage; and storage of miscellaneous equipment, paperwork, and supplies.

Shape of Post

Space or area size can be dictated by the *shape* of the control post. It is recommended that the actual casework required for controls etc. be shaped to allow convenient use from a single point. This tends to dictate against long, straight counter tops and suggests work areas that are more or less "in-the-round" so that staff can easily reach all of the equipment and surfaces they need without a lot of chair or body movement.

Security

ISSUE: Housing unit control responsibilities and interrelationships with Master Control responsibilities must be determined.

RESPONSE: It is important that the extent of control allocated to the housing unit officers be determined to ensure that work loads are manageable. Also, it is critical to determine the degree to which the housing unit officers' controls are duplicated and can be overridden by Master Control.

The types of functions that may come under the direct control of the housing unit control officer are:

- individual cell locks and door status;
- **dayroom** door locks and status;
- doors to various program and service areas within a cluster of housing units or directly accessible from a given housing unit;
- egress from the housing area to other parts of the building or to points leading outside the building;

- cell, **dayroom**, associated program area, corridor, and control position lights;
- inmate telephones;
- housing unit cigarette lighters;
- recreational television channel and sound controls;
- CCTV monitors within the housing area;
- intercoms between the cells, **dayroom**, program areas, corridors, and other staff posts and the control position;
- alarm systems.

It is also critical to the design of the staff post and the housing area as a whole to decide whether the officer will merely *observe* or physically *participate* in typical housing area activities:

- distribution of meals;
- pickup and distribution of laundry;
- removal of waste, garbage;
- receipt of sick call, commissary slips;
- receipt and distribution of mail;
- escort of inmates to and from their housing units, either within the perimeter of the housing area or throughout the jail;
- routine cleaning activities.

The choice of "observer" or "participant" role directly affects the design of *remote surveillance* control posts. If the officer is to be a participant, an open staff post would probably be needed, as opposed to a fully enclosed post. The officer's role would not similarly affect direct supervision situations, since the officer does not leave the housing unit and is not, by definition, in an enclosed control post. Nor would it affect intermittent surveillance situations, since officer movement and thus some degree of interaction with inmates is inherent in the concept.

If a remote method of surveillance is selected and the officer is to participate in activities beyond those which can be controlled electronically from within the staff post, the resulting open-counter position presents some security problems that must be addressed.

- There must be a backup override control at Master Control in the event the housing officer has to leave his/her post or the officer is assaulted by inmates.
- The entire housing area (and all of its individual housing units) has to be treated as a perimeter, the exit from which is controlled by Master Control rather than by the housing control officer. This is

done to limit the value of assaulting the officer and gaining control over the open-counter position.

ISSUE: It is critical that the view of the housing control officer be maximized.

RESPONSE: Virtually every area in a housing unit must be visible to the officer as he/she either monitors the area from a fixed control post or moves through the housing area. Although this does not mean that a full view needs to be provided of the interior of every space, such as inmate cells, it does mean that the officer should have a full view of at least the *dayroom* and the *points of access* to all areas within the housing unit: cells, shower areas, vestibules, visiting areas, exercise areas, etc.

If a *two-tier housing* unit area is designed, it is critical that staff have a proper vertical view angle to allow adequate view of second-tier activities and that the details of the design accommodate view as discussed earlier under "Basic Design Issues."



View from mid-level control to two-tier housing units

A key consideration is the view provided through *dayroom windows and vestibules*. If the view angle is severe enough, especially between a fixed staff post and a housing unit, the relatively deep and thick framing used with security glazing may create more of a view obstacle than anticipated.

The actual view obtained through vestibules may also be much less than expected because of the interference created by the framing for glazing, the wide door frames created when jamb-mounted locks are used, and the width

of the door panel, even when the upper portion of the door is glazed. Vertically, single-level vestibules can obscure views when a two-tier housing unit is involved.

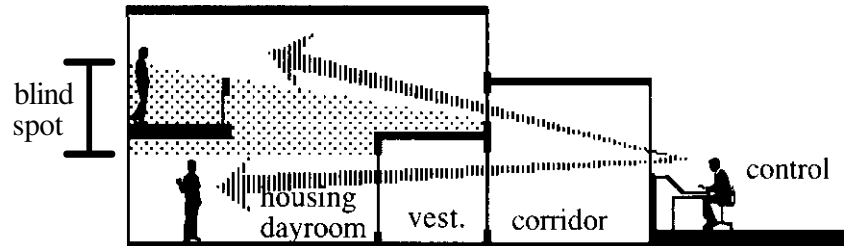

When two-tier spaces are involved, it is also important to take into account the amount of visual interference created by *sliding door mechanisms*. These mechanisms typically are placed above the doors and can be relatively deep, thereby blocking view into second-tier areas from adjacent control positions.

The lower-level views of dayrooms are also important to consider. Many designs have concrete masonry construction of five courses of block (40 inches) at the base of the dayroom walls. This can provide a hiding area for inmates. The designer may want to consider taking the glazing at the front of the dayrooms down to a one- or two-course level.

Communications

ISSUE: The staff control posts must be provided with proper communication capabilities.

RESPONSE: It is important that control officers be in a position to communicate properly with inmates under their control and with other staff in the facility. Communication with the inmate population is also fundamental to meeting inmate needs.

An inmate-to-officer communication system should provide the inmate with the ability to communicate at will from both the cell and the dayroom to the staff in both the corridor and a control post. With the use of solid materials in construction (concrete masonry units, concrete, security glass, etc.), communication is typically achieved through an intercom and/or mechanical talk-through communication device. To provide privacy in dayroom-to-staff communications, a telephone might be considered in addition to the outside telephone lines that allow inmates to talk with friends and relatives.

To facilitate more normal levels of conversation between inmates in the dayroom and officers in the corridor, the designer might consider placing a pass-through or opening in the dayroom wall at approximately shoulder/mouth height. It is also important to provide a means by which staff in enclosed control posts can communicate with, and pass things to, officers outside the control post.

MISCELLANEOUS DESIGN ISSUES

Security Vestibule

The following functional-architectural issues deal with miscellaneous space and design considerations relative to the general housing areas.

ISSUE: The need for a security vestibule entry to housing units should be identified.

RESPONSE: The primary objectives in providing a security vestibule are to prevent unauthorized inmates from leaving the housing unit and to eliminate the danger of several inmates rushing an opening **dayroom** door in an escape attempt. Also, during inmate disturbances, the vestibule provides added control and containment capabilities. However, the security vestibule also represents an additional barrier to manipulate, can diminish remote views, and can add construction costs to a project.

The key to determining the need for a security vestibule is identifying the *security risk* presented by the groups involved, considering the *consequences* to security if inmates escaped their housing unit, and understanding the housing areas' relationship to the *security perimeter* and **zoning** concepts of the jail. It is typical to assume that a low-security general population would be less **likely** to require a security vestibule leading into the space. However, such a vestibule may be deemed essential when a **high-risk** group is involved.

The need for a security vestibule is greatly reduced when a constantly staffed, fully enclosed, securely constructed post is located immediately adjacent to the housing units. If a housing area or pod consisting of several housing units is itself clearly defined as a security zone in which escape from a **dayroom** leads only to a limited, sealed-off housing area corridor, the need for vestibules may be eliminated. In this case, the corridor functions as one large housing area vestibule. Such an approach is especially valid when the exit from the housing area corridor is controlled by staff outside the housing areas, such as Master Control. However, vestibules should still be considered for use with high-risk inmates.

When a security vestibule is provided, it is important that all vestibule doors be *interlocked*. That is, the controls of the doors must be set up so that when one door is opened, the **other(s)** cannot be opened. However, such an interlock system should have an *override* capability so that all doors or selected sets of doors can be opened simultaneously if emergency egress or ingress is required.

In *sizing* a security vestibule, it is important to ensure that it is large enough to accommodate the maximum number of people to be moved at one time and the equipment that might be moved through the space (food carts, laundry carts, stretchers). They should also be designed to meet requirements relative to access for wheelchair-bound inmates or staff. Sizing must be done recognizing that interlocking doors limit maneuverability, especially if swinging doors are used. Swinging doors should swing out, away from the housing unit, to facilitate emergency egress and prevent inmates from

barricading themselves inside their **dayroom**. The actual path of travel for equipment must also be considered in concert with door swings, especially in situations where doors **are** not located in walls parallel to each other but in walls perpendicular to each other.

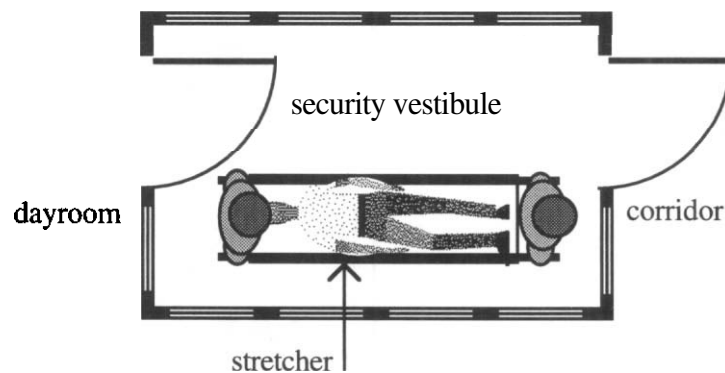

Showers

ISSUE: Showers or bath areas must be provided in association with each housing unit.

RESPONSE: Shower or bath areas **are** typically provided on the ratio of 1 for every 8 to 12 inmates in general population areas, depending on applicable standards. Showers **are** typically provided instead of bath facilities.

Showers can be constructed of concrete masonry walls treated with special water-resistant and durable coatings, and pre-manufactured shower floors/receptors. They can also be stainless steel cabinet units as supplied by detention equipment manufacturers. In either case, the showers should use detention-quality fixtures designed to take inmate abuse and preclude suicide attempts by eliminating protrusions from which an inmate can hang him/herself.

Regardless of the shower type used, it is important to consider the creation of a small *drying and dressing area* or alcove just outside the shower area and ways to contain drippage and spillage from the shower area. A non-slip surface should be applied to the floor immediately adjacent to the shower area.

A key design problem with shower areas is to strike the proper balance between the *privacy* required by the inmate and the needs of staff to *observe* the area. It is recommended that staff at least be able to see the entry to the shower area, and that the entry and shower area not be fully exposed to the **dayroom** and other inmates. Use of security glass block side walls can aid in developing some visibility without totally sacrificing privacy. Shower curtains, doors, or screens should at least allow a shoulder and head view and preferably a **foot/ankle** view of the inmate.

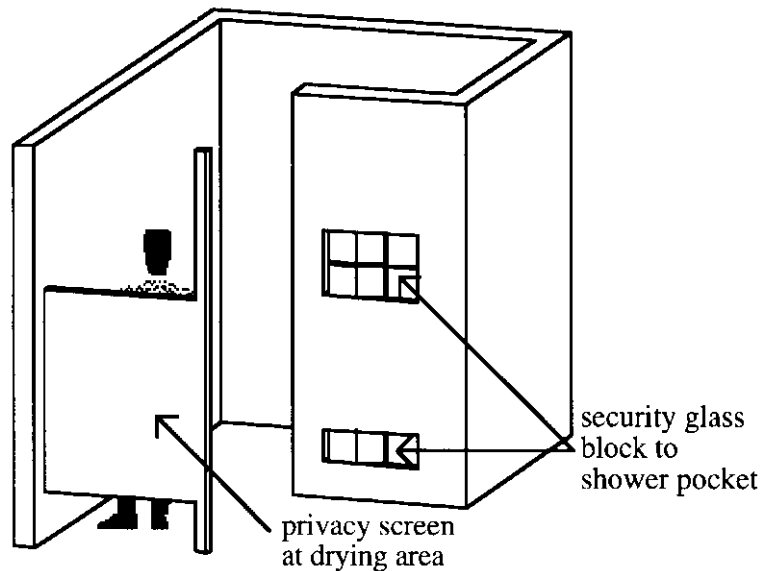

Proper *ventilation* of the shower area is also important to prevent moisture and odors from spreading to adjacent **dayroom** areas and prevent mildew from building up in the shower area.

It is useful to provide a capability for hanging towels and clothing adjacent to the shower area.

Storage

ISSUE: Housing areas require adequate storage adjacent to or within the area.

RESPONSE: It is important that local storage capabilities be provided to service the housing areas. These storage capabilities are not meant to supplant central stores, but to allow a convenient way to respond to the daily needs of inmates. Such localized storage areas might contain extra linens, spare mattresses, toiletries, and other commonly used supplies. In direct-supervision housing units, it is particularly useful to have a small storage space located within the unit.

Janitor Closets

ISSUE: Maintenance of the housing units can be assisted by providing a janitor closet in the area.

RESPONSE: A small janitor closet with mops, buckets, cleaning supplies, floor buffers, etc. can be a great benefit to the maintenance program of the facility. Convenient location in the housing area promotes use of the equipment by inmates. The janitor closet should have shelves for the storage of cleaning goods, a splash basin, and a hose and hose bib that can be used to wash down areas as necessary. It should be equipped with a smoke

detector because of the presence of cleaning fluids and should be a lockable space controlled only by staff.

SPACE LIST

Some of the typical spaces that might be found within the general housing component include:

- Cells or dormitories*
- Dayrooms (1 per housing unit)
- Security vestibules (as needed)
- Shower area* (1 per 8-12 inmates per code)
- Dayroom toilet area*
- Storage
- Janitor closet
- Staff control post (1 per housing area recommended)
- Staff toilet* (1 per staff post)

* See local codes and the ADA regarding handicapped accessibility requirements.

Some spaces that might be associated with general housing, depending on operational programming, movement, and surveillance concepts, include:

- Indoor and/or outdoor exercise
- Visiting
- Counseling
- Sick call
- Multi-purpose program
- Video arraignment
- Food re-heat/distribution
- Linen storage.

RELATIONSHIPS

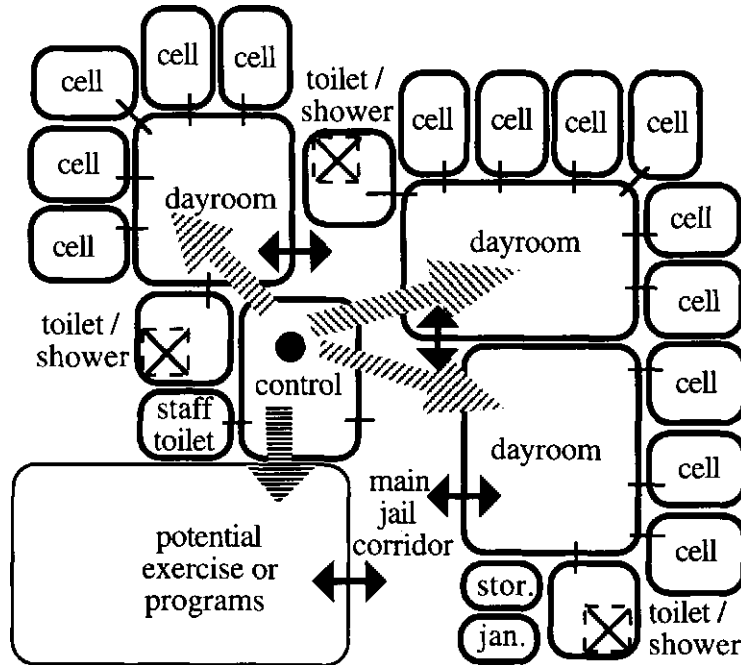

COMPONENT DIAGRAM OF TYPICAL CELL

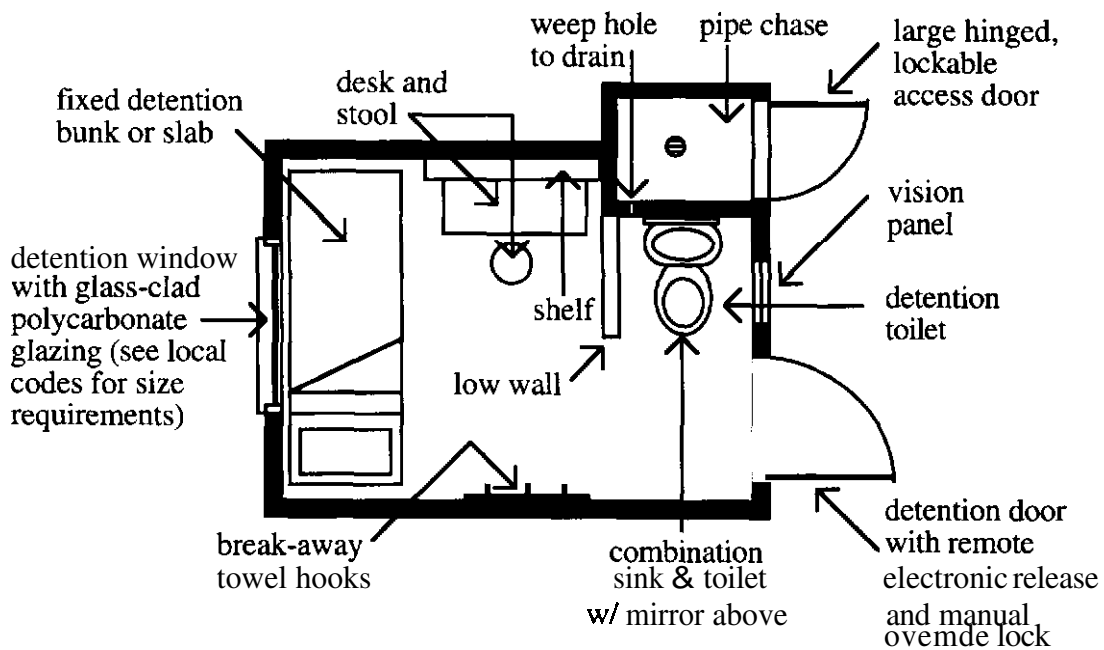

SPECIAL HOUSING

DESCRIPTION

The special housing areas of a small and medium-sized jail accommodate all male or female inmates who by behavior, condition, or unique security risk require spaces with special design characteristics and/or spaces separate from those used by the general population. Inmate groups for whom special housing is described in this functional-architectural component include the following.

- ***Work release/periodic inmates*** who are regularly released from, and readmitted to, the jail to go to a job or school during the time they are serving a sentence or being detained prior to trial.
- ***Inmate workers*** are given work assignments *within* the facility, and outside of their housing unit, such as kitchen or laundry duty and/or general facility maintenance.
- ***Protective custody inmates*** need protection or separation from the rest of the inmate population but do not pose a threat to others or themselves.
- ***Juveniles detained as adults*** are typically 16- to 18-year-olds who are to be tried as adults because of the nature of the crime with which they are charged. (Local laws should be consulted to determine the definition of "juvenile" and criteria regarding assignment of "adult" status in criminal proceedings.)
- ***Medically isolated inmates*** must be separated from others because of their medical status, most commonly because they are infected with a communicable disease.
- ***Disciplinary detainees*** must be separated from others because of serious rule violations.
- ***Suicidal inmates*** have already attempted suicide or have suicidal tendencies so apparent that they need special observation and protection. They do not necessarily include inmates who may have suicidal tendencies but can be detained in a general housing unit that is observed in a constant manner.
- ***Mentally disturbed inmates*** are known to have serious mental problems or demonstrate sufficiently abnormal behavior to merit special observation.
- ***Intoxicated inmates*** are under the influence of alcohol or drugs.

These special categories of inmates pose the greatest separation and management problems in small jails. Some of them require significantly different types of space and/or different levels of separation and observation than

do inmates in general population. Historically, the small jail has had inadequate space and observation capabilities to satisfactorily accommodate these various groups, resulting in serious operational or legal problems.

One option in planning and design is to seek alternative housing for special inmates. Removing them from the small jail is beneficial to the efficient development of space and the management of operational problems facing the limited staff and resources of the small jail. If some or all special categories of inmates must be accommodated at the small jail, the emphasis is on designing spaceflexibly so that the limited number of beds available can accommodate as many different types of inmates as possible.

Inmates with **disabilities** requiring special design accommodations can be found in any of the special housing categories, but do not constitute a group for whom a special unit is created. Designs of special housing areas, therefore, must accommodate the needs of inmates with disabilities as well. More on design considerations for these inmates was provided in the preceding "General Housing" section.

The research behind the 1988 edition of the *Small Jail Design Guide* revealed that nearly half of the new small jails surveyed had problems in properly accommodating different categories of inmates in appropriately designed and separate housing units. Since then, new facilities continue to be built with similar limitations even though many state standards require specifically named special housing categories or a classification/separation plan resulting in varied housing units. Providing for the separate needs of different types of inmates remains perhaps the greatest challenge facing the small jail designer.

A further challenge is that standards typically require that inmates in administrative segregation, protective custody, disciplinary detention, and other special forms of housing receive the same rights to health care, exercise, telephone, and general conditions as do others. In other words, occupancy in a special housing unit does not justify the loss of fundamental rights, conditions, and privileges.

In reviewing the issues addressed in this functional-architectural section, reference should be made to the concepts presented in Chapter 3 in the sections on "Classification/Separation" and "Surveillance/Supervision." Many of those concepts have a direct impact on the development of special housing space.

KEY DECISIONS

As the role of special housing is evaluated, the following decisions should be made since they have a fundamental effect on design requirements:

- Which types of special inmates must be accommodated at the jail and which can be taken directly to alternative facilities, such as work release centers, detoxification centers, or mental health institutions, or be housed in **other jurisdictions**?

- What is the maximum *length of stay* for each type of special inmate to be accommodated by the new jail facility: several hours, overnight, or through adjudication? (Duration of stay will affect the nature of the space provided and the nature of the management problem posed by the groups.)
- To what degree can it be assumed that certain special housing spaces can be *shared* by different types of inmates because of the limited frequency with which they are actually received at the jail?
- Who will *manage and control* the activities of the various special inmate groups? If special treatment or supervision is required by any inmate group, who will provide it?

DETAIL ISSUES

The following detail functional-architectural issues address the development of the special housing areas. Some classifications of special inmates are grouped together because the characteristics of their housing areas are similar. The areas could be used **interchangeably** by the different classifications, assuming, of course, that the classifications will not be mixed together in actual practice. Attaining such interchangeability assumes that the frequency and/or timing of a special inmate's admission is appropriately limited.

The concept of shared space and flexibility in housing use was explored in Chapter 3 under "Classification/Separation" and "Functional Components and Relationships." Those sections should be referenced in using the information in this section.

Many of the design considerations for the dayroom area, cells, and other aspects of the housing units that were discussed in the preceding functional-architectural section on "General Housing" also apply to special housing. Rather than repeat that detail here, reference should be made to the "General Housing" component.

WORK RELEASE/ PERIODIC INMATES

ISSUE: The basic living needs of work release/periodic inmates are similar to those of all inmates and should be accommodated.

RESPONSE: The following characteristics are appropriate to the physical environment for work release and periodic-sentence inmates.

- Sleeping areas may be dormitory, multiple-occupancy cell, or single-occupancy cell style. When dormitories are used, some provisions should be made for privacy and property protection. Privacy can be provided by the use of part- or full-height partitions.

(See the "General Housing" component in this chapter for more on dormitory design.)

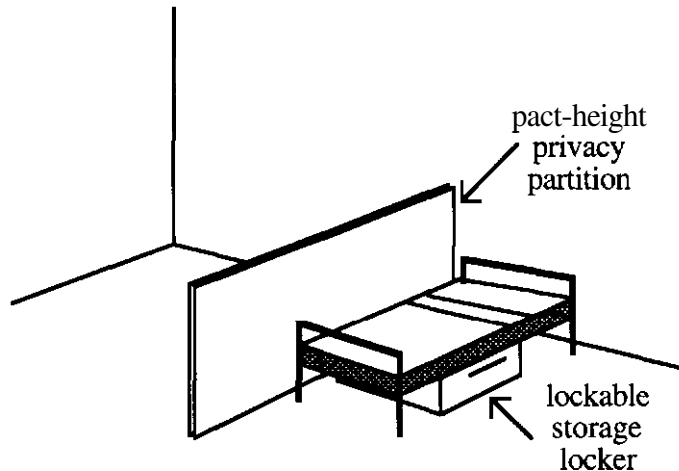

- The sleeping room/area should include:
 - a bed;
 - a desk;
 - a chair or stool;
 - a light fixture, possibly controllable by the inmate; and
 - a lockable storage locker or cabinet.
- **Dayroom space** should be provided. It should be separate from the sleeping areas, especially if work release/periodic inmates work different shifts and the acoustic privacy of sleeping inmates would be disturbed by inmates who may be watching television, talking on the telephone, showering, or conversing.
- Sufficient **shower** areas should be provided to allow work releasees to expeditiously get ready for their work day. Showers should provide a high degree of privacy, although staff observation from outside the area should be accommodated through a small vision panel. The panels may be shuttered or screened to prevent unauthorized view.
- **No security vestibule is needed as an entry to the housing unit.**
- **Furniture** should be durable, but need not be security quality or fixed in place.
- **A direct line of sight** into the sleeping and dayroom areas is useful, even if surveillance policies require that staff physically enter both areas to periodically observe inmates.

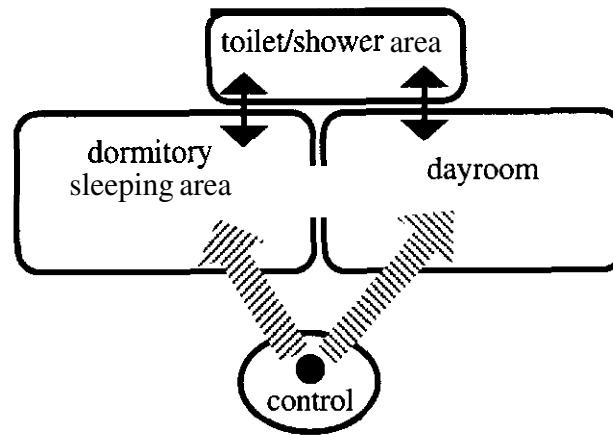

- The housing unit should be provided with a means by which inmates can *communicate* with staff at a constantly staffed post and in the adjacent corridor.
- **Lighting** for the **dayroom** should be controlled by a separate switch than lighting for the sleeping areas due to the separation of the areas and different schedules.
- **Natural light** should be introduced to both sleeping and dayroom areas, but should be minimized and controllable in the sleeping areas if work release schedules require sleeping during daylight hours.
- Additional considerations in the housing unit include:
 - ground fault outlets in the sleeping rooms or **dayrooms** for inmate workers, radios, televisions, and coffee pots.
 - televisions in the dayrooms that are controlled by the inmates.

Security

ISSUE: Although work release and periodic inmates tend to be considered a low-security classification, security is still a major consideration.

RESPONSE: Some vital security considerations that must be addressed **are** principally directed toward the prevention of contraband passage and vandalism in the facility.

- The elements of the **internal** security zone that defines the work release area, principally those elements that double as the main security envelope of the building, must be sufficiently secure to preclude the passage of contraband into the work release area by outside parties: secure wall construction, non-operable windows, security glass, and at least two doors between the area and the outside.

- The **entry/exit** used by work release/periodic inmates should be separate from the entry and exit for the regular inmate population, if possible. If not possible, a strictly managed **entry/exit** sequence should be implemented to minimize contact with areas normally used and occupied by the other inmates. (More on the conditions under which the normal intake-release area can be used is given in the functional-architectural section on "Intake-Release.")

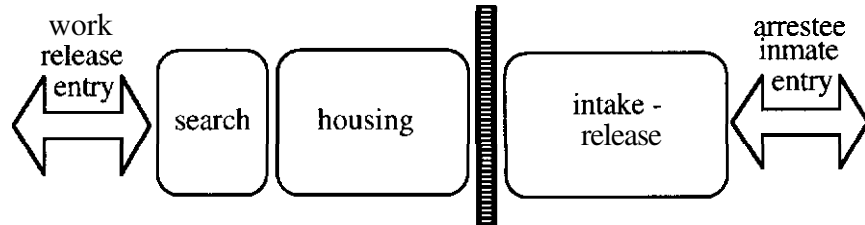

- There should be an area or areas in which the incoming work release/periodic inmates can be **searched**, change clothes, and store their work clothing. This area should accommodate either a standing metal detection unit or simply a hand-held metal detector. Sobriety testing equipment is also useful to test incoming inmates suspected of intoxication.

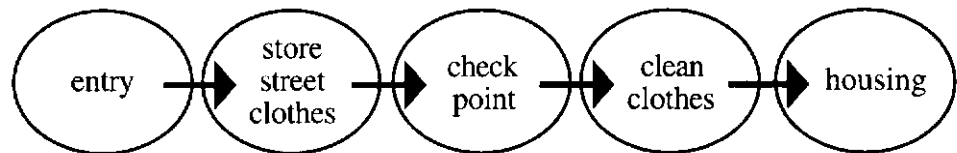

- Locker** facilities outside the sleeping area and dayroom should be provided to secure the valuables, work tools, attaché cases, etc. that inmates are allowed to possess when leaving the facility. Lockers preclude the problem of theft.
- The area should be totally **separate** from all other housing areas and from as many of the main traffic corridors of the facility as possible. If the work release/periodic inmates use program and exercise areas used by the general inmate population, care should be taken by staff to ensure that no contraband has been left by a work release/periodic inmate for other inmates.
- Separate **laundry** facilities might be provided to preclude the possibility that identifiable personal laundry becomes a vehicle for contraband passage.
- Some **subdivision** of the housing area may be appropriate to enhance general control and security between work releasees and periodic inmates **and/or** between inmates released for different work shifts (e.g., if 12 beds are provided overall, two 6-bed areas or three 4-bed areas).

Bed Capacity

ISSUE: Sufficient capacity should be provided to accommodate the surges in inmate population created by weekend sentencing.

RESPONSE: Weekend sentencing is used as an option in many jurisdictions so that the inmate can work all week at his/her job and spend only free weekend time in the jail. However, weekend sentencing typically causes problems for the jail in that it tends to significantly increase the inmate population at a time when there is a normal increase in the number of arrests and jail bookings. This surge must be recognized in planning so that adequate capacity is available in the work release/periodic inmate housing areas and that simultaneous increase in both weekender and arrestee admissions can be handled without violating inmate separation requirements.

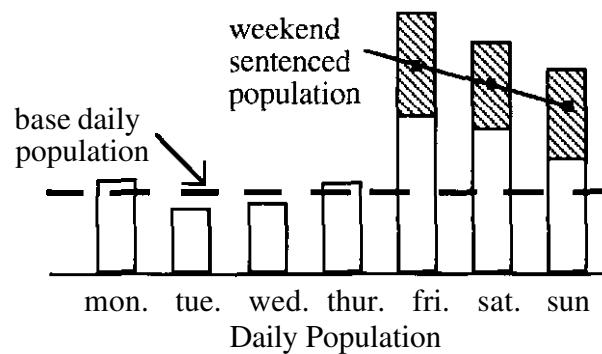

ISSUE: The male work release population must be kept separate from the female work release population.

RESPONSE: There is an increasing tendency to sentence women to work release or periodic stays. The same levels of separation between male and female housing areas discussed in Chapter 3 under "Classification/Separation" must be maintained in the work release/periodic housing areas: physical, sight, and sound. This would be particularly true if the work release/periodic areas are intermittently monitored, as is frequently the case.

In addition to the housing areas, *search areas* should be private, if not separate, for males and females. A common entry is appropriate, but a separate waiting area might be desirable if the area cannot be directly observed and inmates are not immediately processed by staff.

If the female work release/periodic inmate population consists of only one or two women, they might be housed in the general housing or other unit used for female inmates. In this case, the contraband passage and property protection risks must be managed administratively rather than architecturally.

INMATE WORKERS

ISSUE: The basic living needs of inmate workers must be accommodated.

RESPONSE: The inmate worker housing area has the same characteristics detailed above for work release/periodic inmates. Reference should be made to that information in developing the inmate worker space. One exception is that inmate workers should have a telephone with an outside line for visits, a feature not as essential to work releasees given their opportunities for outside contact.

ISSUE: Inmate worker facilities should be properly located.

RESPONSE: Inmate worker housing areas should be kept separate from the other inmate housing areas, if possible, consistent with surveillance needs. They should be near the functional areas where the inmate workers perform their daily duties, such as the laundry and food service areas. The inmate worker area should also be within the secure perimeter of the jail since inmate workers are not normally free to move outside of the facility.

It is critical to keep the inmate workers *separate* from the work release/periodic inmates. Failure to do so provides a natural chain of contraband passage -- i.e., from work releasee to inmate worker to general housing inmate, since inmate workers are frequently in other areas of the facility as part of their laundry, kitchen, or maintenance duties.

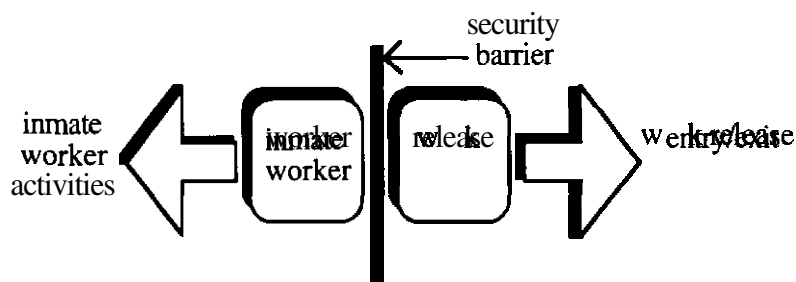

PROTECTIVE CUSTODY/ JUVENILES

The characteristics of housing facilities for inmates in protective custody and for juveniles detained as adults are quite similar. These two groups are dealt with jointly for that reason and because the infrequency of juveniles being detained as adults and of protective custody inmates being held in a small or even medium-sized jail could allow this area to be used interchangeably.

As a rule, the protective custody unit is fundamentally designed no differently than a general housing unit. Consequently, the issues and responses raised in the "General Housing" functional-architectural section regarding **dayroom** and cell space apply.

Given the limited size of the protective custody group in the typical small and medium-sized jail, it is quite possible that the number of beds allocated

for protective custody housing could be accommodated in the kind of *swing or special management housing unit* discussed in Chapter 3 under "Classification/Separation." Such a swing unit might be adjacent to the female housing unit so it could be used for an overflow female population when not being used for protective custody.

Housing Flexibility

ISSUE: Flexibility in housing assignments should be a characteristic of protective custody housing.

RESPONSE: The flexibility of small protective custody or "swing" housing units can be increased in various ways, each of which involves careful detailing and design:

- Develop each individual housing unit with *minimum capacity*. Specifically, restricting each protective custody housing unit to two to four beds provides an ability to adjust to the varying natures of the populations to be housed in the units.
- Provide a *door in the dayroom partition* that divides individual units to allow, for example, two 2-bed areas to function as one 4-bed area when inmates of identical classifications are involved. This flexibility also combats the problems inherent to two-bed areas; that is, a one-on-one inmate situation that is typically thought to be undesirable. It also prevents the possibility of isolation when only one person is in a unit, when immediately adjacent are two inmates of the same classification.

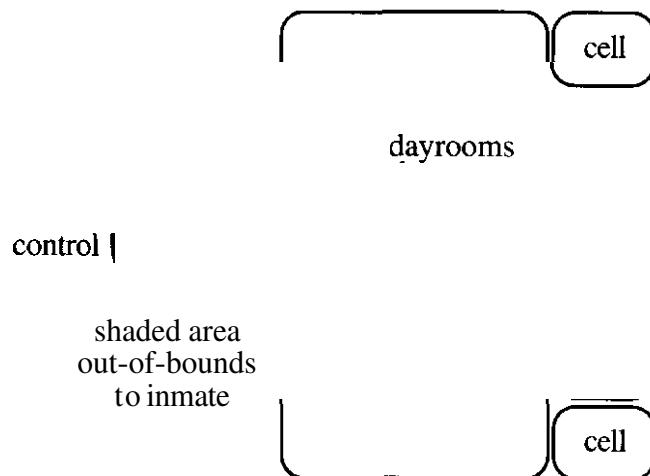

It is important that the door dividing the two housing units be acoustically treated and have a security threshold that limits sound transfer and precludes the passage of contraband when inmates of different classifications are in the adjacent areas.

- Develop a *swing cell* between two adjacent housing units that can open to either of them to easily change the capacity of either area.

- Provide a **second access** to one of the cells so that special housing needs can be accommodated on those unusual days when there is a full variety of inmate types in the facility and too few separate areas to manage them. In these circumstances, which are expected to be rare and of short duration, access to dayrooms and showers will have to be scheduled and managed by staff.

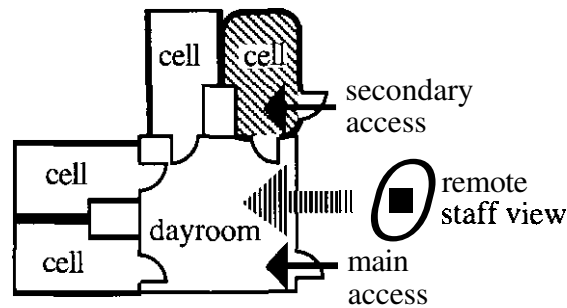

If this possibility is to be incorporated into the design to limit the overall amount of bed space and still cover all circumstances, the constant presence of staff is appropriate. Consequently, it is recommended that when developed as versatile "swing," or "special management" space, protective custody areas be remote surveillance areas.

Separation

ISSUE: The protective custody swing areas should be separated from other housing units, and the units within the protective custody swing areas should be separated from each other.

RESPONSE: It is important to provide full separation capabilities (physical, sight, and sound) from the other general population units. It is also important to provide separation between the various housing units within the area since inmates of very different classifications might be housed in the area at the same time under the swing, or special management, concept.

It is especially important for protective custody areas to be separated from disciplinary detention and high-security areas if inmates in those areas might pose a direct physical, visual, or verbal threat to inmates who are being protected.

MEDICAL ISOLATION

It is strongly recommended that jail administrators refrain from housing inmates with long-term and serious medical problems for any extended period, if at all. This group poses major challenges in terms of providing proper care and facilities. The following functional-architectural issues are presented with respect to the short-term housing of people suspected of having, or known to have, diseases or illnesses that might be contagious. It is recommended that appropriate alternative facilities be sought for inmates diagnosed with a serious contagious illness.

In circumstances where only a cold, a minor virus, or a mild influenza is involved, medical isolation needs might be accommodated by simply isolating the inmate in his or her regular housing unit cell. In this case, it would be useful to exhaust the air of the cell from the cell, not through the dayroom.

More information on non-housing health care areas (examination areas, medication storage, etc.) is given in the functional-architectural section on "Health Care."

Characteristics

ISSUE: Medical isolation facilities should accommodate the medical and personal needs of the inmate user.

RESPONSE: A medical isolation area should have the following design characteristics.

- It should basically be of high security construction since it will likely accommodate the full range of classifications served by the jail.
- A small **dayspace** area, which might accommodate a shower, is desirable adjacent to medical isolation cells. If no **dayspace** is available, medical isolation cells should include a shower if this practice complies with local codes.
- No security vestibule is needed to gain access to the medical isolation area.
- Cells should be single occupancy.
- Cells should be located to facilitate frequent observation by medical personnel and security staff.
- The size of cells should be dictated by the types of furniture and equipment within them. Besides a possible shower, it is useful for the bed to be accessible from more than one side. An appropriately designed medical isolation cell frequently exceeds 100 square feet in size.
- The bed in the cells should be fixed in place and comfortable.
- Inmates should be able to communicate directly with staff. This capability should, perhaps, include a nurse call button that allows the inmate to easily alert staff of a need.
- The needs of inmates with hearing or vision impairments must be accommodated in the cells.
- A detention-quality toilet and sink should be provided; separate fixtures are recommended.

- A small, fixed-in-place, detention-quality desk and chair or stool should be provided.
- A mirror and shelves with collapsible security hooks should be provided.
- An ability to restrain the inmate to the bed should be considered.
- **An** outlet should be considered for a television or radio, especially if such amenities are available to other inmates.
- Cell doors should have a food pass.
- Lights should be controllable by staff, but an option for some inmate control might be desirable.
- Natural light should be provided to the area through a secure means.
- Air from the cells should not be re-circulated if the inmate is contagious, nor should re-circulated air be introduced into the cell if the inmate is susceptible to contagion.
- A floor drain should be provided either in the cells or just outside them.

Location

ISSUE: The location of medical isolation cells should facilitate delivery of medical services by health care staff and surveillance by security staff.

RESPONSE: The examination room and medication storage area of the health care component should be located conveniently in relationship to medical isolation cells, although adjacency is not required if surveillance needs are better served by some separation.

Regarding surveillance, the design should allow for observation or surveillance from a constantly staffed post, if possible, such as Master Control and/or a nurse's desk if a nurse's position is part of the facility program. Medical isolation cells should also be located so that other staff can easily provide extra periodic observation, without overexposing cells to visibility to other inmates in nearby housing units. Providing for this easy periodic observation is a must if cells are not located in a direct line of sight of a constantly staffed post.

In considering these security-related spatial affiliations, it should be remembered that inmate patients can present the same potential security risks as any other inmate, especially if they are fully ambulatory.

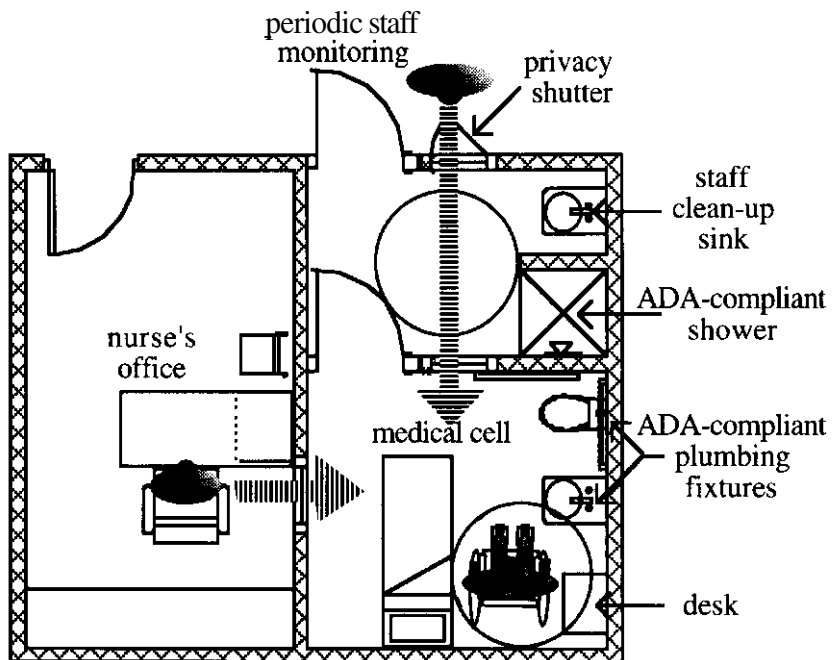

Security

ISSUE: Medical isolation inmates may represent a danger to themselves or others.

RESPONSE: The design of medical isolation cells and the selection of furnishings should take into consideration the potential for suicide and eliminate visual blind spots and bars, hooks, and other protrusions from which inmates could hang themselves. Further, the design should minimize joints, pockets, and other places that could be used to hide contraband and weapons.

Occupants of medical isolation cells may have poor coordination due to illness or injury. Consequently, the design, furniture, and fixtures should not contribute to accidental injury. Fixtures should have rounded or beveled edges, there should be ample room to move around, and eyehead height protrusions should be minimized.

DISCIPLINARY DETENTION

ISSUE: Disciplinary detention areas should be designed to accommodate the security risks posed by the inmate and be responsive to the punitive aspects of placing an inmate there.

RESPONSE: An inmate is placed in disciplinary detention because of a violation of facility rules. Disciplinary detention is meant not only to separate the offending inmate from the rest of the population, but to discourage future bad behavior by denying the inmate some of the privileges and amenities available in other areas. Consequently, a general objective of disciplinary detention is to create a more spartan living environment. How-

ever, this does not include depriving the inmate of basic rights to well-ventilated, temperature-controlled, sanitary, well-lit, and healthful conditions.



A spartan disciplinary detention cell (with limited view from an adjacent corridor).

The *characteristics* of a disciplinary detention area follow.

- It should be high security in general construction approach, emphasizing durable, cleanable, and vandal-resistant materials, furnishings, equipment, and hardware.
- A small **dayroom** adjacent to the **disciplinary** detention **cell(s)** is recommended. Such a space should be sufficient to allow the inmate to obtain required daily exercise and, perhaps, to eat meals. It would help isolate unwanted sound from the cell.
- A shower facility should be easily accessible from, but not within, the detention **cell(s)**.
- No vestibule is needed since the **dayroom** essentially functions as a vestibule. This is because the inmate is routinely locked into the detention cell for all but a limited time for exercise and then is generally alone.
- Natural light should be provided to cells in a secure way.
- Cells should be larger than normal cells given the extensive isolation in the cell.

- Inmates should be able to communicate directly with staff, but audio monitoring capabilities should be controllable by staff.
- The cell should have a fixed bed, a detention-quality toilet and sink fixture, a desk and chair or stool, security mirror, security shelves, and collapsible hooks for clothes and towels.
- Light fixtures should be controlled by staff
- Cell doors should have a food pass.

Security View

ISSUE: Constant observation of the disciplinary detention area is essential.

RESPONSE: Observation should be provided from a constantly staffed post for effective control over the disciplinary detention area. It is also advisable that the disciplinary detention space be in a location that other staff can easily observe when passing by.

Regarding observation, it is not necessarily desirable to have total visual access to the cell by fully glazing or opening the cell front (door and front wall), especially if this exposes the inmate to other inmates in the facility and vice versa. A more limited door vision panel and side light sized and shaped in deference to available view angles from nearby staff posts and that are adequate to allow observation of key parts of the cell would be sufficient in most cases. In general, a partial view of the bunk and open cell area, and a view above the toilet fixtures provide sufficient remote observation.

Separation

ISSUE: Disciplinary detention cells should be separated from the other housing areas.

RESPONSE: The disciplinary detention area might be observed from a staff control post that also provides observation of other housing areas. If so, the design should provide for physical, sound, and visual separation of the area from the other housing units to the greatest degree possible.

Flexibility

ISSUE: The disciplinary detention area may serve other special housing needs.

RESPONSE: The high-security construction of the area, the presence of a dayroom and shower, and the visibility of the area from a staff post provide conditions under which the area could conceivably be used to house other classifications of inmates under certain circumstances. For example, if the facility were to become overcrowded and no one was being held in disciplinary detention, it might be appropriate to use that space on a short-term basis to help relieve the crowding.

In that circumstance, the fundamentally hard and **spartan** character of the disciplinary detention housing area should be offset by providing amenities. It would be desirable, therefore, to consider installing outlets for television and electric cigarette lighters, jacks for telephones, and other amenities in the **dayroom**. A small table and seating in the **dayroom** would also add flexibility to use of the area.

**MENTALLY
DISTURBED/
SUICIDAL
INTOXICATED**

Inmates who pose serious suicide threats, are or appear to be mentally disturbed, or are intoxicated by drugs or alcohol require spaces that have special but similar characteristics. Thus the infrequency in which some of these classifications arrive at a small jail creates the possibility of a **shared-use** area.

Because the suicidal, mentally disturbed, or intoxicated inmate requires special care and close observation, it is recommended that *alternatives to jail* be sought. However, it is recognized that many small and medium-sized jails have no choice but to accommodate such inmates, if only until other arrangements can be made. For example, the mentally disturbed must sometimes be kept for several hours or overnight until a court order can be obtained permitting transfer to an appropriate facility. Intoxicated inmates charged with a serious crime may also have to be held in special quarters while they recover.

In developing the functional-architectural issues related to these spaces, it is assumed that only the briefest of stays are involved with these inmate types. It is assumed, for example, that stays in detoxification spaces are for **no more than 8 hours** and that the mentally ill and people with serious suicidal tendencies stay **no more than 48 hours**.

Because of the unique characteristics of these spaces, it is assumed that they typically will *not* be able to accommodate other classifications of inmates.

Characteristics

ISSUE: The special housing needs of suicidal, mentally disturbed, and intoxicated inmates must be accommodated.

RESPONSE: Some recommended characteristics of the spaces used for these special groups follow.

- The area should be of *high security* construction that is durable, easily maintainable, and has vandal-resistant equipment, hardware, and materials.
 - A *dayroom* or small corridor area should be adjacent to the cells, if possible. This space provides an alternative to confinement in the cells and a useful sound containment **barrier**. If a **dayroom** cannot be provided, consider placing the cells in an area that provides some sound isolation from the other housing areas and the program areas.
 - A *shower* should be easily accessible from, but not within, the cells.
-

- *No vestibule* is required for this area, but a sound containment vestibule might be useful.
- *Natural light* should be provided if possible, but not if it precludes a good observable location for the cells.
- The cells should be provided with a detention-quality *toilet and sink future*. The water supply should be restricted to cold and warm water to preclude scalding possibilities. Fixtures should be easily accessible but out of the way to preclude injuries caused by stumbling.

A *raised slab* approximately 8 inches above the floor should be provided for sitting or sleeping. A small restraint bar should be installed for the mentally disturbed or suicidal inmate, if needed. Such a restraint fixture might also be used to secure a nonflammable mattress to the raised slab.

Cells should be sufficiently large to allow easy movement by officers who may have to struggle with, or restrain, inmates; fixtures and slabs should not be too difficult to negotiate.

No hardware or furniture should be in the cells, such as desk, stool, shelves, hooks, or mirror. There should, however, be sufficient room to accommodate mobile restraint chairs, if used.

- *Ceiling height* should be at least 9 feet so that light fixtures, sprinkler heads, etc. are generally inaccessible to the inmate.
- *Lights* should be controlled by staff. There should be a night light feature in the cell, and the light level should be adjustable to accommodate the comfort of the inmate and the varying observation needs of staff.
- The *air* from the space should not be re-circulated.
- All *edges* should be rounded or beveled. Padded surfaces are desirable if the padding provides adequate fire protection, satisfies local codes, and is functional and durable.
- *Doors* should be heavy-gauge security quality with a food pass.
- A *floor drain* should be either in the space or just outside it. A remotely flushed drain could be beneficial.

It is recommended that a *shutoff valve* for cell plumbing fixtures be readily accessible to staff, and a remote flushing feature is advisable.

Observation

ISSUE: Constant observation of suicidal, intoxicated, or mentally disturbed inmates is critical.

RESPONSE: Constant observation of these cells requires an effective direct view of the space from a constantly staffed post rather than through electronic means. Electronic surveillance might provide a useful supplement to staff observation.

In designing the cells for good view, the degree to which their face is "opened up" with vision panels depends on the location of cells in relation to a staff post. If cells are located adjacent to a staff post with no **dayroom** or other space separating them, a small vision panel is acceptable since the staff can easily go to the panel and obtain a full view of cell interiors.

If cells are at some distance from a staff post or at a remote point from which passing staff will look in, it is critical to provide enough glazing in the doors and the fronts of the cells to make the cell sufficiently visible. Sufficient view would include the ability to see the inmate when lying on the slab or using the toilet (while providing basic privacy), and to see any spaces in which the inmate might attempt to hide.

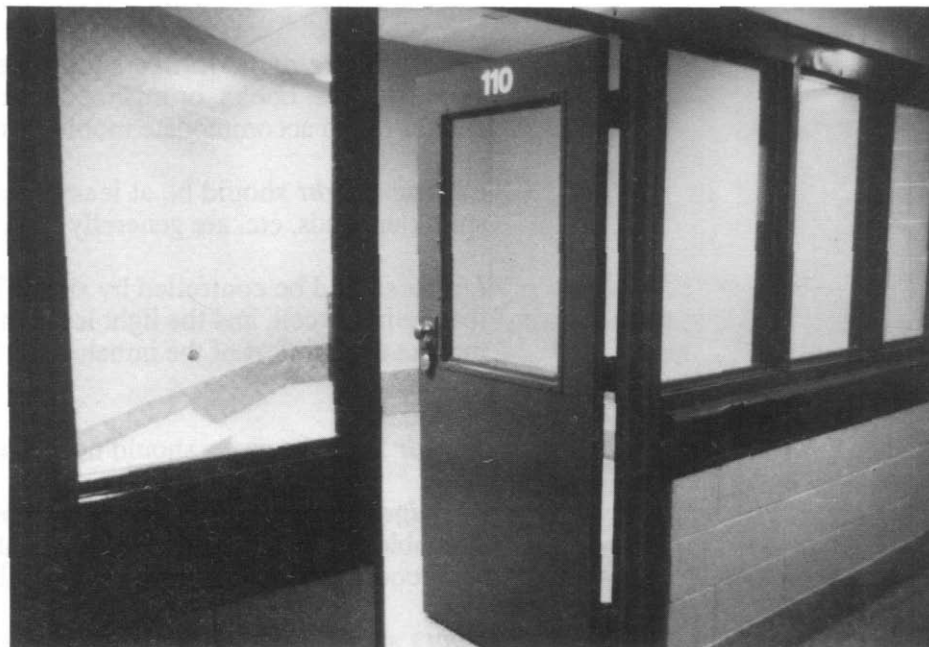

View of a constant-observation cell from a staff post.

Location

ISSUE: The cells for the suicidal, intoxicated, or mentally disturbed might be best located near or in the receiving part of the intake-release area.

RESPONSE: Suicidal, mentally disturbed, or intoxicated individuals can be quite difficult to manage. Consequently, it is desirable to minimize the amount of movement involved in bringing them into the facility and reach-

ing the proper housing area. Placement of these cells in or very near the intake-release area is very desirable. The key to location, however, is having the ability to monitor the inmate constantly. Periodic observation, such as that provided by roving staff, is helpful as a supplement but is not recommended as the sole source of staff surveillance.

SPACE LIST

Some of the typical spaces that might be provided to meet special housing needs follow.

Work Release/Periodic

- vestibule from jail security envelope
- sleeping rooms
- **dayroom**
- shower/toilet
- search (m/f)
- street clothes storage/change area
- clean clothes storage/change area
- secure entry

Inmate Worker

- sleeping rooms/dormitory
- **dayroom**
- shower/toilet

Protective Custody/Juvenile

- cells (disabled, non-disabled)
- **dayroom**
- shower/toilet

Medical Isolation

- cells
- **dayroom**
- shower

Disciplinary Detention

- cells (disabled, non-disabled)
- **dayroom/vestibule**
- shower

Suicidal/Mentally Disturbed/Intoxicated

- cells (disabled, non-disabled)
- **dayroom/vestibule**
- shower

Staff Post

Storage

Janitor Closet

RELATIONSHIPS

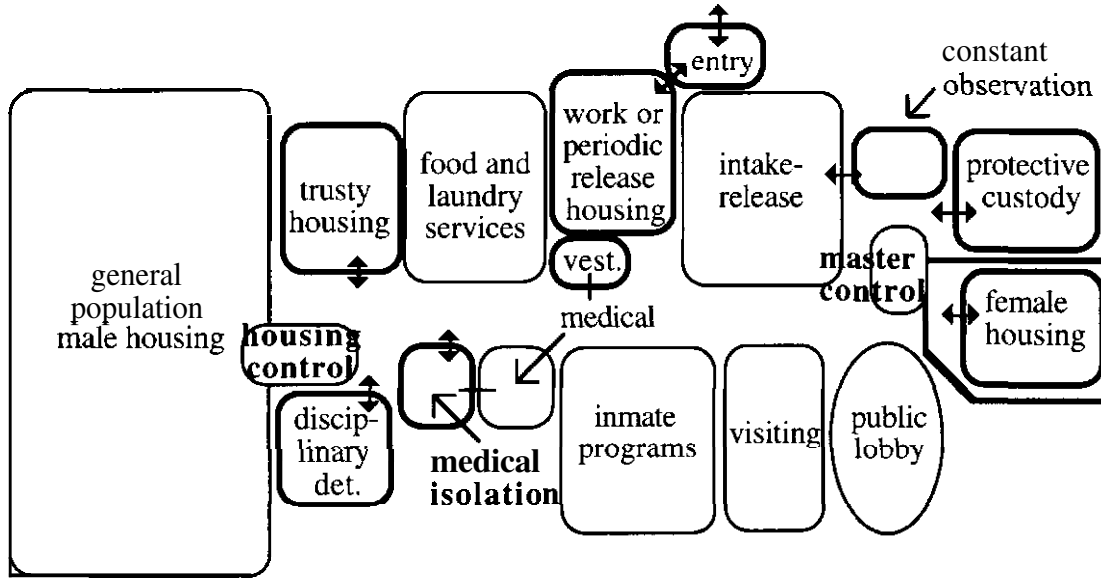

COMPONENT DIAGRAMS

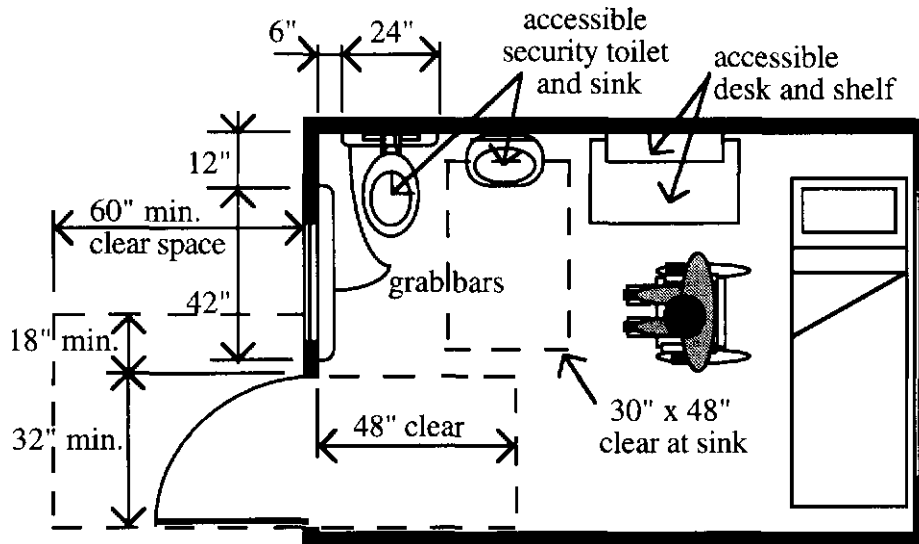

CELL FOR PHYSICALLY DISABLED

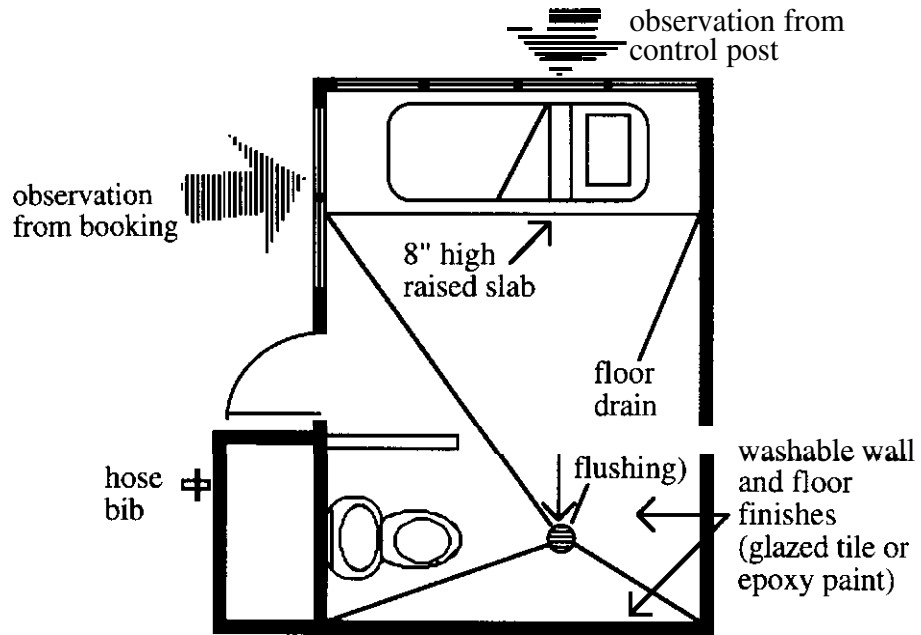

CELL FOR SUICIDAL/MENTALLY DISTURBED/INTOXICATED

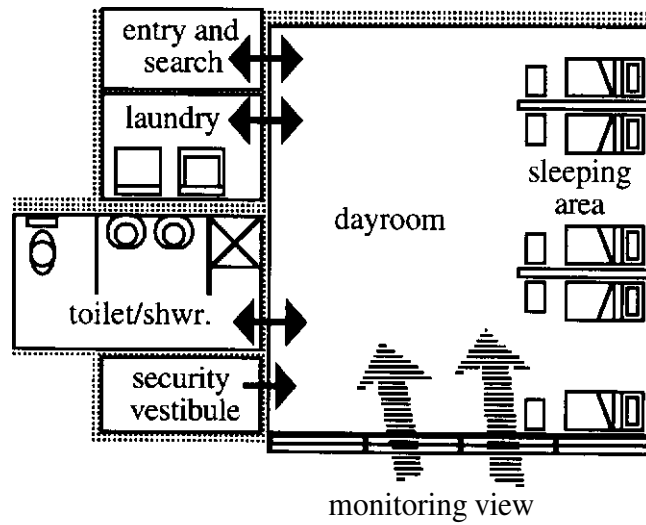

WORK RELEASE UNIT

HEALTH CARE

DESCRIPTION

Adequate health care services are essential to the well-being of arrestees and inmates and should be viewed as a basic human right and a basic responsibility of the jail. The purpose is not only to serve the individual's needs, but to prevent the spread of disease within the facility. The activities necessary to carry out a complete, yet basic, health care program typically include:

- medical screening at intake to identify illnesses or injuries prior to admission,
- suicide screening at intake to identify suicide risk,
- solicitation of inmate health complaints (sick call).
- alcohol or drug detoxification,
- temporary care of individuals with mental illness,
- testing for infectious diseases,
- isolation of those with infectious diseases,
- routine health appraisal,
- emergency and first aid treatment,
- administration of medicines,
- infirmary care,
- emergency dental care,
- special medical diets,
- health education,
- mental health counseling, and
- cleaning and disinfecting of medical space.

There is considerable variety in how health care is provided in small and medium-sized jails; that is, some jails provide health care at the facility while others take the inmate to a clinic or emergency room. Regardless of the arrangement for health care, some activities must take place at the facility and require appropriate space.

Historically, small and medium-sized jails have suffered from an absence of proper examination or treatment space and special cells in which to house persons who have infectious diseases, are intoxicated, or are suspected of having mental health problems. Many new small and medium-sized jails continue to have health care housing deficiencies, but provide more sophisticated examination and treatment space.

For some new facilities, the space and equipment provided for exams have remained relatively idle because jail budgets are insufficient to pay for full-time, in-house health care staff or because service providers in the community will not come to the jail. Many health care practitioners insist that inmates be brought to their offices or to local health care facilities. This practice poses both security and manpower problems for the jail staff. Joint planning with local service providers is essential to determining appropriate space and equipment allocations between the jail and the community and to soliciting proper involvement at the jail.

Overall, space provisions for health care need not be extravagant. If local resources are used for more costly and extensive services, health care space might range from one area for basic exams, first aid, medications, records, and emergency equipment to a space for each of those basic functions, in addition to any special housing provided.

Many state standards require health care services and space in jails. These should be checked closely. The ACA standards contain an extensive list of operational and physical plant standards relative to the delivery of health care services in the local jail. The National Commission on Correctional Health Care has also published standards for health care in jails and guidelines for health care space and basic equipment. These sources provide valuable information for planning discussions.

KEY DECISIONS

As the role of the health care component is evaluated, the following decisions should be made since they have a fundamental effect on design requirements.

- To what extent and how frequently will the required health care services actually be provided?
- To how many inmates?
- Which of the required health care services can be provided by properly trained jail *employees* (first aid, initial screening, CPR, etc.)?
- Which of the required services can and/or should be provided at the jail by *outside professionals* (e.g., routine exams, tests, dental care, sick call)? Are doctors, nurses, and dentists actually available to come to the jail as volunteers or as contract service providers?
- What services and facilities are available and accessible *in the community* that need not be duplicated at the jail, and what are the economic and security ramifications of using them (e.g., transportation, jail officer escorts, providing security at the community facility)?

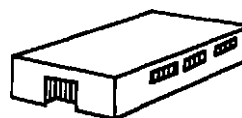

JAIL OR

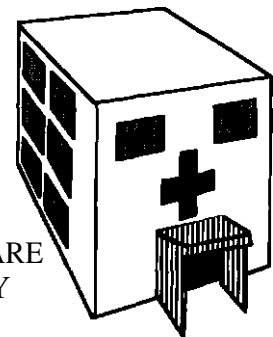

HEALTH CARE FACILITY

- What level of *special housing* will be provided at the jail for detoxification, medical isolation, minor illnesses, or convalescence? How will these areas be supervised and how will proper medical care be provided (staff nurse, emergency medical technician)?
- How will future *growth* in the jail population or future changes in the makeup of the population affect the methods of delivering the various types of medical services? How will future space and equipment needs be met?

DETAIL ISSUES

The following discussion of detail functional-architectural issues is limited to the typical health care functions or spaces common to jails since a review of every issue related to health care (including surgery and prenatal care) would create unnecessary length and complexity for the small to medium-sized facility where such services are rarely provided. Issues dealing with special housing for inmates with **medical/mental** health problems were addressed in the functional-architectural component on "Special Housing."

EXAM AREA

The following information applies to examination areas.

Activities

ISSUE: All of the activities to occur in medical examination spaces should be identified.

RESPONSE: Typical activities might include the following, depending on agency desires and the availability of community resources:

- initial screening to identify **medical/mental** problems and suicide risk,
- responding to inmate health complaints,
- routine health assessments,
- first aid,
- testing for infectious diseases,
- mental health screening,
- **consultations/medical** counseling,
- emergency equipment storage, and
- minor treatment procedures (e.g., injections, topical applications, bandaging).

Other possible activities include:

- record storage;
- record preparation and review;
- assorted **doctor/nurse** office functions;
- storage of medications;
- minor laboratory work;
- routine dental work (exams, fillings, extractions); and
- minor x-ray work.

It would be inappropriate to merge office and record keeping functions with those of examination if it meant that the privacy of exams would be violated. For example, it would be inappropriate to have a doctor examining or consulting with a patient while a records clerk was nearby managing medical files or talking on the telephone.

Number of Rooms

ISSUE: The types of examination activities and the projected workload must be identified to determine the number of examination rooms needed.

RESPONSE: Most smaller jails find one exam room to be sufficient. However, a variety of factors dictates the actual number of spaces needed:

- Significant differences in functions and equipment needs -- for example, dental versus medical exams.
- The variety of tasks to be performed in the space which, in turn: dictates levels of use.
- The projected number of inmate users.
- The actual number of hours of operation per day or week as they relate to the availability of health care professionals.

If more than one exam room is needed, it would be desirable that the rooms connect or at least be adjacent.

Room Size

ISSUE: The size of examination rooms will vary with the level of care provided.

RESPONSE: The minimum examination room might be defined as a space whose size is determined by the needs of basic first aid and basic physical exams. Such a space would probably have the following minimum equipment:

- examination table (with stirrups);
- examination stool or chair, plus a chair for the inmate;
- examination light;
- countertop with sink and gooseneck faucet;
- a small writing surface for the doctor or nurse;
- lockable storage cabinets and drawers;
- scale with measuring rod and support pillar;
- foot stool;
- trash and waste cans;
- eye chart; and
- refrigerator for specimens.

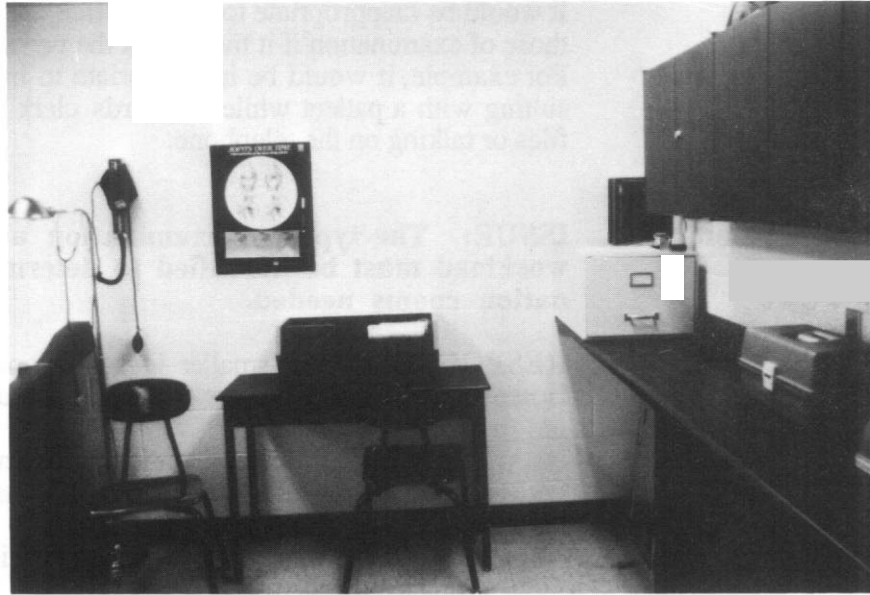

Typical examination space and equipment.

Other basic medical equipment, such as blood pressure cuffs, may or may not be mounted units. It is important to interview health care providers to ascertain their functional and equipment needs.

A space as small as **80 net square feet** could *be* adequate to meet minimum functions and equipment requirements. A space of **100 net square feet** would be more comfortable and more typical of standard expectations in the field. A space of up to **180 net square feet** could *be* required if minor emergency care and additional treatment procedures, such as changing dressings or eye or ear irrigations, are performed.

Work Surface and Access

Two of the key variables in determining space size for the minimum medical examination space seem to be **work surface needs** and **access** around the examination table. A work surface or desk is needed for the doctor's or nurse's report writing, and work surface is needed to accommodate a sink and the temporary placement of equipment and supplies being used during the examination.

The degree to which work surface for report writing is provided depends on whether there is separate office space for health care staff and whether they do most of their paperwork at the facility. A later portion of this section deals in more detail with staff work areas.

Access around the examination table can be one- to four-sided. Two-sided access seems to be the minimum acceptable for routine exams and first aid, while full four-sided access is obviously preferable since a full range of services including emergency medical treatment could be provided.

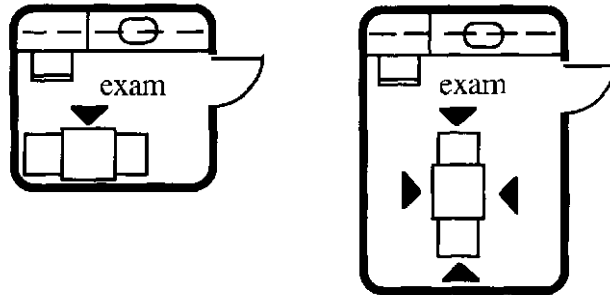

Dental Examination

Dental examination space can range in size from **90 to 150 net square feet** for a single examination unit. Size is principally a factor of how extensive the service will be; that is, will it merely involve visual examinations or will it involve x-rays and dental procedures such as extracting or filling teeth? Sample equipment:

- dental chair (approximately 27 inches wide x 75 inches long reclined);
- dental unit (drills, lights, air line, water lines, tray);
- area for an air compressor to power the dental unit, which is outside of the exam room;
- evacuating system;
- cabinets;
- countertop and sink;
- sterilizer;
- waste and trash cans;
- stools for dentist and assistant;
- x-ray viewer; and
- x-ray machine, the availability of which also requires a protected area and lead-lined aprons.

Examination space can become quite large if both medical and dental exams are merged into one area.

All examination rooms should be sized to allow handicapped access and use and should allow access by stretcher.

Location/Security

ISSUE: Examination rooms should be located at a point within the jail that complements safety, security, and service delivery needs.

RESPONSE: Examination rooms should be located on or near a main circulation corridor to facilitate quick, easy access by inmate patients and staff, especially from the intake-release area. A direct line of sight from a constantly staffed post to the door leading to the medical exam area is desirable. Normally, security staff should not be able to view directly into the exam room, for privacy reasons, but it is important to be able to monitor the flow of traffic in and out. A vision panel that can be screened or shuttered would be appropriate to provide selective observation.

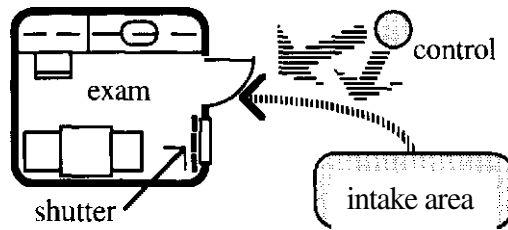

Where direct observation of the entry is not possible, it might be useful to equip the doors with a *status indicator light* that signals whether the door is open or closed. This alerts staff to tampering, particularly at times when the area is not in use. Master Control is the most likely constantly staffed post to monitor the exam area, using electronic means.

Security

ISSUE: The security of medical personnel in examination areas should be assured.

RESPONSE: Health care personnel will often be alone with inmate patients, creating the potential for violent or aggressive behavior. Although the door to the examination area may be monitored by Master Control and roving security staff may be posted outside the area, an alarm system within the area should be considered. This might consist of a body alarm, a panic button, or a voice-activated intercom set at decibel levels above normal conversation (so that private conversations cannot be routinely monitored). Whatever system is chosen, it is critical to preserve privacy and be able to prove that privacy was preserved.

ISSUE: Examination area equipment and supplies must be secured.

RESPONSE: It must be possible to securely store in lockable drawers or cabinets all of the small, detached items of equipment (e.g., scissors, percussion hammers, syringes and needles) and supplies (e.g., bandages, tongue depressors) found in an examination area.

Communication

ISSUE: Two-way communications between the examination area and a constantly staffed post and to parties outside of the facility should be provided.

RESPONSE: A telephone or intercom allows the health care provider to notify staff of the completion of exams, request the next patient, obtain information, be alerted to an emergency, etc. Telephone access to the outside allows the health care provider to order medications and make referrals.

Environmental

ISSUE: Basic environmental needs of examination areas should be accommodated.

RESPONSE: Various significant environmental concerns should be accommodated in an examination area.

- **Lighting** should be sufficient to conduct required exams, record keeping, etc. Special examination lights may not be required, depending on the nature of the exams and the equipment requested by the health care provider.
- **Natural light** is a pleasing feature in an examination room, especially if medical staff will also use this space as an office. If natural light is provided, care must be taken to provide security as well as visual privacy.

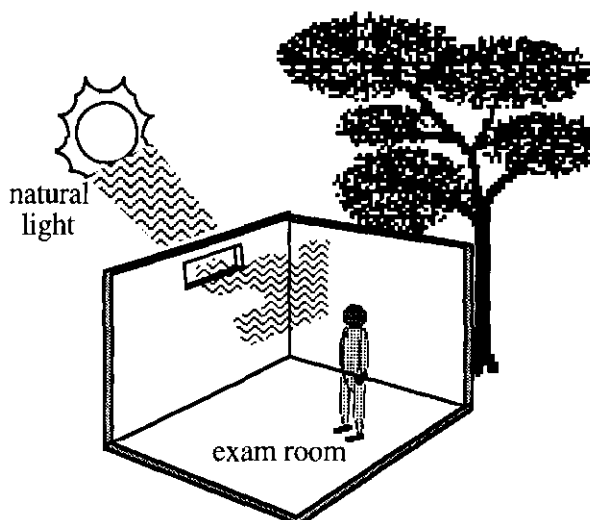

- **Acoustic privacy** is required so that confidential health care discussions remain private and a professional atmosphere is created. Insulating walls and ceiling plenums, using acoustically treated hollow metal or solid-core wood doors, and preventing sound travel through duct systems can help in this regard.
- **Temperature levels** should be comfortable and, perhaps, controllable within the space. Ventilation should meet all required codes to ensure proper conditions and prevent re-circulation of contaminated air.
- If **x-rays** are done in the examination area, even on a small scale, proper precautions must be taken in the design of the room to protect health care personnel, staff, and inmates.

- Cleanliness of the area is essential and can be enhanced by the proper selection of materials and finishes. A janitor's closet should be easily accessible for routine cleaning and occasional spills.

MEDICATION STORAGE

The following functional design issues apply to medication storage and distribution.

Activities

ISSUE: Medication storage and distribution needs should be determined.

RESPONSE: Some of the typical activities found at jails include:

- securely storing each inmate's prescription medicines,
- securely storing quantities of common medicines,
- securely storing medicines needing refrigeration,
- preparing medicines for distribution,
- distributing medicines and storing trays or carts used in distribution,
- documenting prescription needs and distribution,
- inventorying available supplies, and
- charting distribution schedules.

The actual preparation of prescriptions is a function that could, but does not typically, occur at small and medium-sized jails since a jail pharmacist's salary cannot generally be justified. Usually a local drug store or hospital will fill prescriptions issued by a physician. However, a licensed nurse is typically responsible for "setting up" the medications, which may then be distributed by a jail officer (depending on what state law allows).

Size

ISSUE: The size of the area needed for medicine storage and distribution will depend on the extent of the activities involved.

RESPONSE: Usually a single storage area is sufficient. The secure medication storage area can be as small as a secure cabinet in an examination room or as large as 30 to 40 net square feet depending on the activities required, security and operational policy, and the projected number of inmates to be served. Size also depends on whether the storage area is part of the examination area, which would allow necessary features such as sinks and work surfaces to be shared rather than duplicated.

In general, the medications storage and distribution area should be well organized and have sufficient space for a countertop with sink. Lockable base cabinets and wall cabinets with under-cabinet lighting are useful. A wall-mounted tack board for charts and schedules; a telephone or intercom; and a small lockable refrigerator for medicine, urine, and blood specimens are recommended.

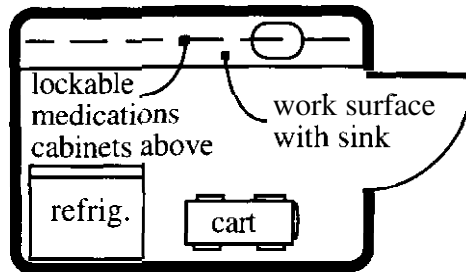

Additional medicine storage capacity considerations include:

- **Distribution method** -- A hand-carried tray for very small jails with limited population, **or** push carts (which must also be stored) for larger jails or for convenience, **or** a secure distribution window or dutch door through which medicines would be issued to inmates brought to the storage area.
- **Basic storage needs** -- A stock of common medications stored at the jail for unit dosage administration **or** daily dosages delivered from the local pharmacy.
- **Storage method** -- Arrangement of medications (on shelves) with positive identification by type, dosage, physician's directions, and inmate's name. Storage of medicines **pre-trayed** by the nurse or doctor for staff distribution throughout each shift.
- **Documentation** -- A surface for report writing or documentation that may also accommodate a typewriter or computer terminal.

Location

ISSUE: The location of the medication storage area should facilitate frequent use and convenient access by authorized staff.

RESPONSE: It is important that access to the area in which medication is stored be monitored, preferably by a direct line of sight from a constantly staffed post. This is especially important if inmates are brought to the area to receive their medications.

The relationship to inmate housing areas is important regardless of whether staff bring medications to the inmates or the inmates go to the medical area for medications.

Medication storage and distribution areas generally consist of one of the following:

- A secure cabinet within the examination area.
- An enclosed medical storage and distribution space opening off the examination room.

- An enclosed medical storage and distribution space adjacent to but independent of the examination area.

In part, this decision is based on the potential conflict of the examination room being in use when access to the medications is required.

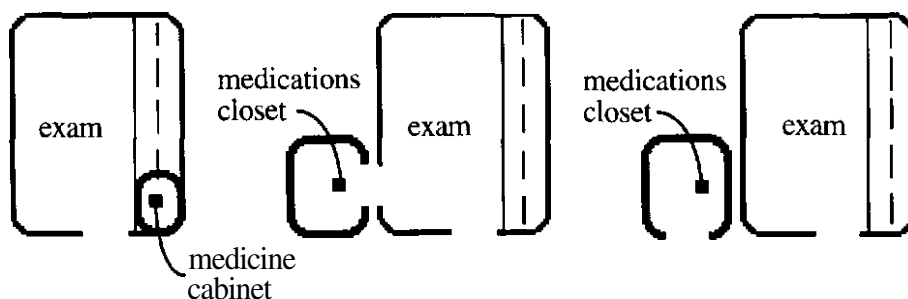

Where daily dosages are prepared in advance during a nurse or doctor visit, a *second medicine cabinet* might be provided in a secure staff post such as Master Control. This facilitates staff distribution of the medicines, while preserving the security of the main medication storage area.

Security

ISSUE: Medications storage is a "medical or security personnel only" area that must be secure from break-in.

RESPONSE: This area should have highly controlled access and be separate from other jail storage. If possible, access to medication storage should be by health care staff only, or by a limited number of health-trained security staff expressly authorized to distribute medications when health care personnel **are** absent from the facility. Thus, key control becomes crucial --the medications storage key should be "checked out" from Master Control each time it is needed.

Some additional considerations:

- Ensure security not only through lockable, monitorable security doors accessing the medications storage area, but through the construction of fully secure walls, floors, and/or ceilings if secure walls do not extend to the roof or floor construction above.
- Secure the ductwork and any other penetrations in the area through which inmates might gain access.
- Create at least two locked barriers between the medications and areas where inmates are frequently present.

Special Characteristics

ISSUE: The contents of the medications storage area are subject to frequent inventory.

RESPONSE: Shelf design enhances the inventory process. Under-cabinet and shelf lighting and *movable* rather than rigid shelving facilitates the organization and inventory process.

ISSUE: The medications storage area may be used for storage of certain flammables, such as medications containing alcohol.

RESPONSE: Consult with local fire department or state fire marshal personnel about fire detection/suppression requirements.

MISCELLANEOUS ISSUES

The following detail functional-architectural issues deal with other elements that might be part of an examination area configuration or that might be separate health care spaces. All are appropriate and fairly common for jails.

Record Storage

ISSUE: Secure health care record storage should be provided.

RESPONSE: The following considerations should guide the development of medical record storage capabilities.

- According to the American Medical Association guidelines, the following types of medical records should be maintained:
 - problem list;
 - receiving screening and health assessment forms;
 - all findings, diagnoses, treatments, and dispositions;
 - prescribed medications and their administration;
 - reports of laboratory, x-ray, and diagnostic studies;
 - progress notes;
 - consent and refusal forms;
 - release of information forms;
 - discharge summary of hospitalizations;
 - reports of dental, psychiatric, and other consultations;
 - special treatment plan, if any;
 - place, date, and time of each medical encounter;
 - signature and title of each documenter.
- Health records are confidential and should be kept secure and separate from other inmate records and under the custody of medical personnel only.
- The key to proper location of health records is that they be accessible to health care staff work areas and highly secured from casual access by unauthorized staff or inmates.

Staff Work Area

ISSUE: A work area for health care personnel should be provided.

RESPONSE: At least a small amount of work area should be provided for report writing, form completion, prescription writing, and the storage of forms and supplies. In many small jails where health care personnel visit only periodically, a small work surface and lockable storage files in the examination area are satisfactory as long as work there does not interfere with examination work. Lockable storage for equipment owned by the health care staff would also be useful. Office space separate from the examination area would be for full-time jail medical personnel or for community medical personnel who spend substantial amounts of non-exam time at the jail.

Additional considerations:

- Separate office space should be adjacent to, but not accessible solely through, the examination space.

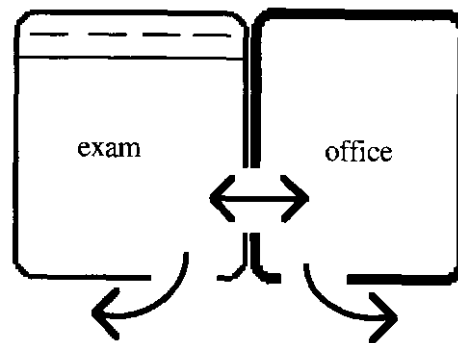

- If health care personnel are provided 24 hours a day and medical isolation cells are also provided, consider creating a direct view link between the two areas.
- Work areas should have telephones with outside lines and should have an **alarm** system (e.g., voice-activated intercom or panic button) if inmates are ever in the space alone with staff. Space should be provided for a computer terminal and printer to facilitate record keeping.
- Office space should be large enough to accommodate private consultations and record storage as well as the work surface and personal storage needs of staff. A minimum size of **60 to 80** square feet is recommended. Information about private medical or mental health counseling areas is given in the functional-architectural component on "Programs/Services."
- Work areas should have visual and acoustic privacy. If, however, some view is desired at certain times, consider the placement

of a side light in the wall of the area that can be covered by curtains or blinds when privacy is desired.

First-Aid Kits

ISSUE: First-aid kits should be available.

RESPONSE: First-aid kits should be standard equipment in small and medium-sized jails. They should be located to be readily accessible to staff, but secured from inmate access and tampering.



A wall-mounted first-aid kit.

Emergency Equipment

ISSUE: Emergency equipment storage needs should be accommodated.

RESPONSE: In addition to first-aid kits, there is a variety of emergency equipment that even the smallest jail might find useful:

- wheelchair,
- stretcher,
- crutches,
- defibrillator,
- oxygen, and
- splints.

If provided, these items should be in a secure and controlled space. However, unlike areas for medications and medical records, the emergency equipment space must be easily accessible to staff on all shifts as well as to health care personnel.

Toilet Facilities

ISSUE: Toilet facilities should be available in the health care area.

RESPONSE: Health care staff should have access to a *staff toilet*, near, but not necessarily in, the health care area. However, a private, handicapped-accessible *inmate toilet* should be near or within the health care component for obtaining samples as well as for general inmate use. Besides using separate detention-quality toilets and sink fixtures, the area should have a tamper-proof mirror, soap dispenser, towel dispenser, and waste receptacle. A small shelf for samples should also be provided unless there is sufficient surface area on the sink.

Inmate Waiting

ISSUE: The need for inmate waiting areas should be identified.

RESPONSE: A separate, secure inmate waiting area would be needed when groups of two or more inmates are brought to the health care area at the same time. Group waiting by standing or sitting in adjacent corridors is discouraged, especially if it occurs in a high-traffic corridor or a corridor that serves as a primary means of egress. Some considerations:

- Appropriate seating should be provided for inmate waiting. The waiting area should be adjacent to the examination area and, preferably, visible from a constantly staffed post.
- Space for the inmate waiting area should be programmed at about 12 to 15 net square feet per person, which should be adequate for both seating and movement around the seating.

Personal Protective Equipment Kits

ISSUE: Personal protective equipment kits should be available.

RESPONSE: Personal protective equipment kits to protect staff from inmate body fluids should be standard equipment. These kits commonly contain plastic bags for body fluid contaminated waste, disposable gloves, germicide hand cleaner, a CPR barrier, a gown, a surgical mask, goggles, etc.

Personal protective equipment kits should be located where they are readily accessible to staff but secured from inmate tampering. Lockable wall-mounted kits near intake-release and inmate housing are preferable.

SPACE LIST

Some of the typical spaces that might be found with the health care component follow.

	<u>Can be part of exam space?</u>
Exam/treatment area	N/A
Secure medications storage and distribution	Yes
Secure records storage	Yes
Staff work area	Yes
Storage closet	No
Emergency equipment storage	No
Inmate toilet*	No
Inmate waiting area	No
Dental exam	Yes
Housing (see "Special Housing")	No

* See local codes and the ADA regarding handicapped accessibility requirements.

Other health care spaces that might be found in a jail:

- Staff lockers
- Treatment room (minor surgeries, emergency treatments separate from exam)
- Sterile storage room
- Soiled linens workroom
- Reception/clerical
- X-ray room
- Dental operator
- Laboratory
- Darkroom.

RELATIONSHIPS

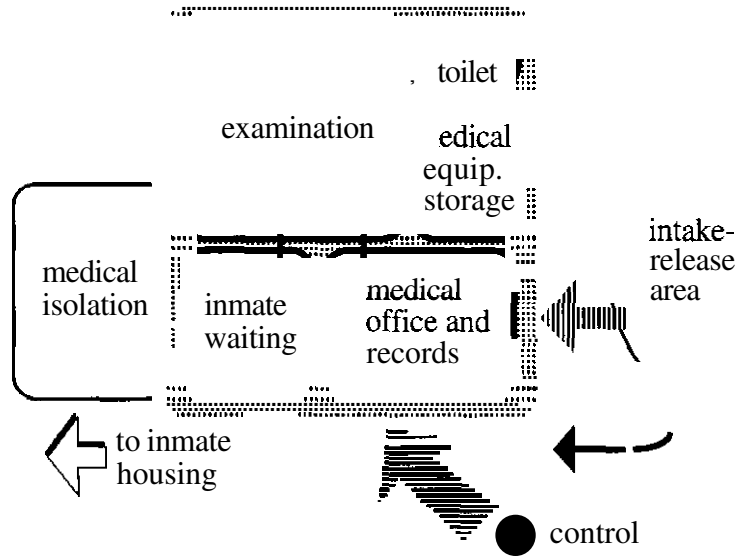

COMPONENT DIAGRAM

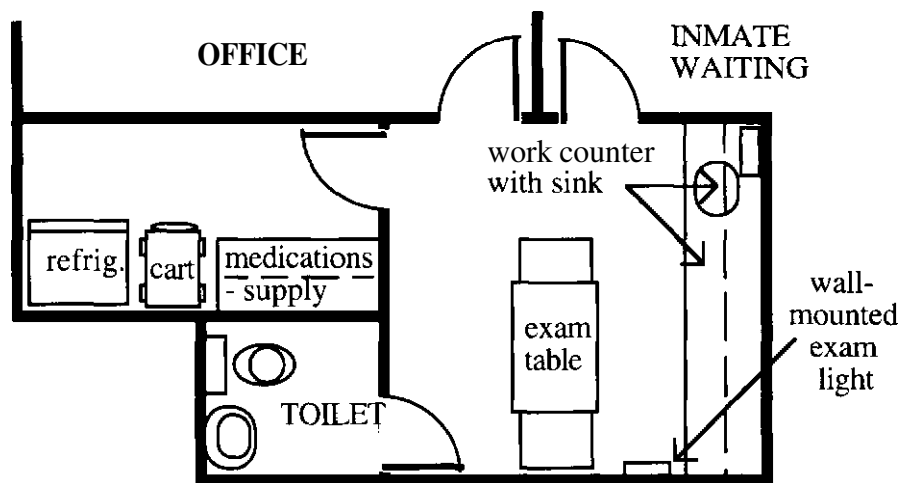

VISITING AREAS

DESCRIPTION

Visiting is one of the crucial links between inmates and the community. It provides a way for inmates to communicate other than by telephone or mail with people outside the jail with whom they need contact. Visiting is extremely important to inmates because it enables them to keep in touch with family members, friends, business associates, ministers, and attorneys. Because visiting is so important to inmates, it is one of the jail's most effective tools in managing their behavior.

In older jails, visiting commonly occurred at the cellblocks rather than in areas set aside specifically for visiting. These cellblock areas were characterized by a complete lack of privacy; physical conditions dangerous for staff, visitors, and inmates; and poor security features. Visitors and inmates had to stand, view each other through tiny vision ports, and strain to speak and be heard through heavily meshed "voice boxes" in spaces with very poor acoustic qualities. The introduction of contraband was a significant problem given the visiting area's location with the security envelope.

In modern designs, visits with friends and family usually occur in private, non-contact spaces where physical comfort and limited privacy are better afforded. These design improvements reflect case law that has condemned the lack of quality visiting space and conditions.

Contact visiting tends to be limited to attorneys, counselors, and other "official" visitors; contact visits with family **are** usually limited to low-security inmates such as inmate workers or to others for special occasions at the discretion of jail officials. In some jurisdictions, contact visiting is accommodated in outdoor recreation yards.

Many varied spaces are needed for visiting, including:

- places for both non-contact and contact visiting -- for both personal and professional visitors;
- visiting facilities that accommodate the disabled;
- a visitor reception desk or area in or adjacent to the public lobby;
- a visitor waiting area, with public restrooms, telephone, and drinking fountain;
- a storage area for visitors' personal property that is prohibited from visiting areas (essential for contact visiting);
- an area in which to search inmates in privacy following their visit (essential for contact visiting);
- an area for occasional searches of visitors suspected of carrying contraband; and
- a means for "telephone visiting" from the dayroom to people outside the jail.

Courts have generally held that inmates should be allowed to visit with family, friends, religious advisers, prospective employers, and the news media

within a reasonable jail schedule. Virtually all states and national agencies with jail standards require and address the provision of visiting opportunities and facilities. Planners should check applicable state standards for mandatory requirements.

KEY DECISIONS

As the role of the visiting component is evaluated, the following decisions will have a fundamental effect on design requirements.

- How much space should be provided for visiting? How many inmates will be able to visit at the same time and how many visitors will be allowed to visit with each inmate? How long will visits last?
- Will visitors move to a visiting area located next to inmate living areas or will inmates move to a central visiting area located near the public entry?
- Will inmates be allowed to have contact visits with family or lawyers and, if so, which classifications of inmates? How will staff be made available for intensive screening of visitors and searches of inmates? Will space be dedicated for contact visiting or will some other space, such as a multi-purpose room, be used?
- Will inmates and visitors communicate over a telephone or more directly, as via a sound port?
- Will video visiting technologies be used to either replace or supplement certain forms of visiting? If so, how will that work and where will it be done?
- Which staff post will supervise the visiting area? How will inmate movement to visiting areas be monitored?
- Where will visitors be received? Who will receive them? How will packages, money, and other items that visitors bring to inmates be handled?

DETAIL ISSUES

The following detail functional-architectural issues should be considered in the development of the visiting component.

ACTIVITIES

ISSUE: It must be determined how basic activities will be accommodated, which staff member will conduct or supervise them, and where they will take place.

RESPONSE: The following activities usually pertain to visiting

- Visitor arrives and is registered and screened for security (person and materials) by staff.

- Staff determines which inmate the visitor desires to see and whether the visit will be allowed.
- Visitor is directed to waiting area and is informed of rules and length of visits.
- Visitor stores property (coats, hats, purses, etc.) in locker area.
- Staff determines where the inmate is and either communicates with other staff who will escort the inmate to the visiting area or escorts the inmate personally.
- Inmate and visitor are escorted to booth or room after visitor is scanned by a metal detector and perhaps searched if it is a contact visit.
- Staff supervises visit, ensuring that behavior is acceptable and within rules (especially important with contact visiting and official interviews).
- Staff informs parties that visit is over or responds to their request to end visit.
- Staff observes inmate return to housing area and visitor return to waiting area.
- Visitor is checked out, and any stored property is returned.

SIZE OF SPACES

ISSUE: The size of visiting spaces is determined by the number of users and by comfort and security considerations.

Non-Contact Visiting

RESPONSE: The size of *non-contact* visiting spaces is determined by the following considerations.

- There should be enough *width* to comfortably accommodate more than one visitor seeing an inmate at the same time. If no visiting information is available to substantiate a proportion, design at least half of the non-contact spaces as **double stations** to accommodate two visitors.

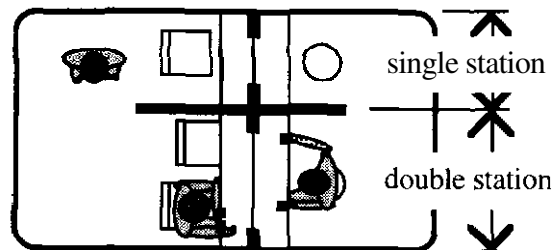

- There should be enough *depth* to allow the visitors to:
 - sit rather than stand,
 - have adequate privacy screening on either side of the space (without inappropriately screening staff view), and
 - move comfortably around and behind the space (especially if movable chairs are used).

It is **recommended** that the depth be sufficient to accommodate a small counter surface for leaning or writing.

- Determine whether each individual visiting station is a fully **enclosed** space or shares space with a series of other visiting stations.

If an enclosed space is chosen for greater privacy and control, allow extra space within the space since these enclosures can feel quite confining. Allow for movement into and out of chairs and for door swings (inmate side should swing out, if possible).

- Dimension should be sufficient to allow access by disabled inmates or visitors, particularly those in wheelchairs. Flexibility in seating is important to consider as well. If security seating is generally preferred, consider detention-quality swing-out seating to allow wheelchair access.



Open-backed visiting stations within one large enclosed visiting room, all with good visibility and easy accessibility.

Contact Visiting

Contact visiting spaces should be sized on the basis of the number of users and types of activities. They should be fully enclosed and private if possible. In most cases, two users are involved: the inmate and the visitor (lawyer, bondsperson, counselor). A desk surface and chairs are also required.

Occasionally more than one visitor may be involved in a contact visit with an inmate. If this possibility exists, at least one area of sufficient size

should be available to accommodate this unusual circumstance

The jail administration may want to consider allowing contact visits to occur in a multi-purpose room with different visiting groups sharing the space at the same time. In this case, the space should be large enough to allow sufficient distance between the groups to retain some degree of privacy. Large numbers of people generate enough sound to mask each other's conversation, as occurs in a restaurant. Background music or "white noise" from ventilating systems can also help in this regard.

For security reasons, primarily contraband passage problems, it is recommended that contact visiting not occur in inmate program and service areas such as a multi-purpose room. (See the functional-architectural section on "Programs/Services" for more discussion on this point.)

ISSUE: Visitor waiting areas must be appropriately sized.

RESPONSE: The size of the visitor waiting areas should be determined with the following considerations.

- Waiting is frequently done in the public lobby. If the building serves law enforcement, courts, and other functions, the total lobby area may be large enough to accommodate waiting visitors. However, if the lobby is restricted to jail functions or if jail waiting is done in a space separate from the public lobby, that space should be provided on the basis of at least 15 square feet per person and preferably 20 to allow adequate circulation.
- The number of expected visitors must be determined. This largely depends on how visiting is administered at the jail. Often jails do not or cannot schedule visiting, so the number of visitors who show up simultaneously is unknown. Ideally, visiting is scheduled so that the number of visitors in the area at any one time can be accurately predicted.

For example, if the jail could accommodate ten visits at any one time, allowed half-hour visits, and provided two hours of visiting time per day, jail staff could expect to have no more than 10 to 20 people waiting at any one time to accommodate 40 total visits in a scheduled situation (based on one to two visitors per inmate visit). However, in an unscheduled situation, it is quite possible that 40 to 80 visitors (one to two visitors per inmate) could arrive at the jail at the same time, thus requiring substantially more square footage in the lobby/waiting area.

- Waiting areas should also provide space for visitor lockers. The amount of space required for the lockers is clearly dependent on the number of lockers, which, in turn, is dependent on:
 - the number of visitors in the facility at any one time who need lockers,

- the number, size, and shape of items to be stored, and
- the size of each locker needed

Lockers do not need to be in a separate space. They can be part of the visitor waiting area or in an alcove just off the waiting area. **Locker size** depends on the items to be stored (normally coats, hats, purses, attaché cases) and the manner in which articles of clothing are to be stored (folded or hung). Visitor lockers should not be confused with the secure weapons storage lockers required at all points of ingress to the facility. (More on lockers appears later in this section).

Another consideration is that of *inmate waiting*. It may be desirable to have a waiting area for those inmates ready to move into the visiting space during the next visiting period. Such a waiting area might be a separate room or it might be a small alcove off an access corridor. It should be under direct staff surveillance or supervision since inmates of different classifications may be waiting at the same time.

Other elements related to the public lobby, such as toilets, telephones, and drinking fountains, should be accessible from the waiting area/lobby, as discussed in the functional-architectural section on "Administration/Public." All elements should be accessible to the disabled.

NUMBER OF VISITING STATIONS

ISSUE: The number of separate visiting stations needed depends on the projected number of visitors and on scheduling.

RESPONSE: To determine the number of visiting stations, the following factors must be considered:

- how many visits per week each inmate will have on average;
- how long the visits will be on average or at minimum;
- how many hours per week will be set aside for visiting (for example, Monday, Wednesday, and Friday, 5 p.m. to 8 p.m., and Saturday and Sunday, noon to 5 p.m., would total 19 hours per week); and
- what visiting loads will be like when the jail population peaks (occasionally beyond design capacity).

Some sample assumptions regarding the factors that affect space needs follow. These factors are then applied to a sample formula showing how to calculate the number of stations needed.

Sample Visiting Assumptions

	40-Bed <u>Jail</u>	80-Bed <u>Jail</u>
Visits per inmate each week (average)	1.5	1.5
Total visits each week	60	120
Average length of visit (hours)	1	1
Total weekly visiting hours available	19	19
Peak factor (for irregularity in visiting patterns)	1.6	1.5

The *formula* used to calculate the number of stations is:

$$\text{number of stations} = \frac{(\text{total visits}) \times (\text{length of visit}) \times (\text{peak factor})}{\text{total weekly visiting hours available}}$$

For the 40-bed jail example above, the formula works out as:

$$\text{number of stations} = \frac{(60) \times (1.0) \times (1.6)}{19} = 5.05 \text{ (or 5) Stations}$$

These calculations should be done separately for both contact and non-contact visiting.

**LOCATION1
MOVEMENT**

ISSUE: The method selected for providing inmate and public access to visiting areas can greatly influence facility design.

RESPONSE: Classically there are two basic choices for getting the visitor and inmate together for a non-contact visit. Each has a major impact on design.

- *Moving the inmate to the visitor* (customary). This usually requires significant staff time since inmates must be taken from their living areas to a visiting area near the public lobby, unless movement can be achieved without escort by properly locating staff posts and/or CCTV cameras.

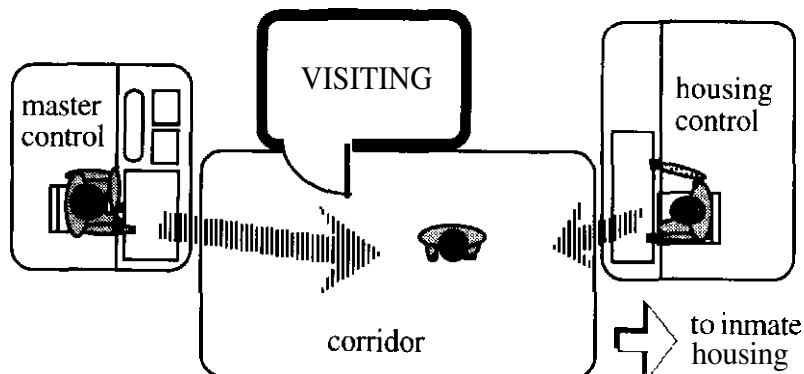

- **Moving the visitor to the inmate.** This is done via a separate circulation corridor from the public lobby to visiting stations outside of, but adjacent to, inmate housing. Inmates enter the visiting booth directly from their dayroom without staff escort. In favorable circumstances, visitor movement can also be unescorted to minimize demands on staff.

Accommodating *visiting at the housing units* presents special movement problems in that the visitor must move deep into the facility to reach the housing units. There are two key considerations with this concept.

- **A second, totally secure visitor corridor** must be created to ensure that the jail's security envelope is not violated. This is frequently achieved by constructing a second corridor above the primary inmate corridor. There are no penetrations in this corridor that allow access to inmate areas. Egress from this corridor should be down a secure set of stairs or through a secure exit that does not involve the security envelope of the jail.

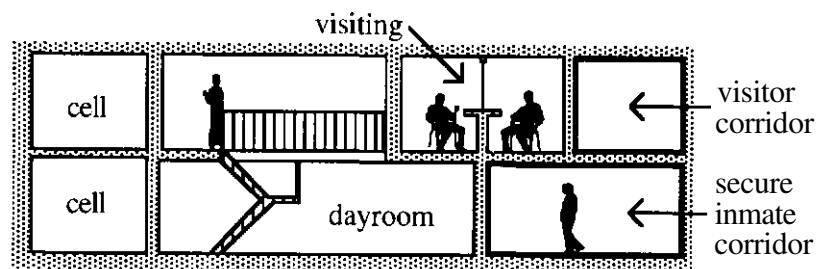

- The visiting areas at the housing unit must provide sight and sound privacy.

For the small and medium-sized jail, this approach to visiting must be closely evaluated. It could create unnecessary expense and complications since inmate movement to a central visiting area does not normally involve great distances or many people at one time. Therefore, this idea does not offer the time-, movement-, and staff-saving elements that make the concept attractive to large jails.

Video Visiting

Visiting by use of **video equipment** (cameras and monitors) changes the discussion of location considerably. Installation of a video visiting system essentially allows the public visitor to stay in or near the lobby or even a remote location. It allows the inmate to stay in or near the housing unit. Traditional contraband passage and security concerns associated with visiting are negated by this method.

The use of video, however, does not negate the need to create private visiting stations for the inmate and the visitor. And it does create the need for designs that protect the equipment at both locations while allowing for easy

maintenance. Nonetheless, staff time and effort can be saved due to reduced inmate movement, security searches, and staff surveillance.

In assessing the appropriateness of video visiting, local laws and statutes must be taken into account and fears of illegal monitoring must be addressed. The quality of the visit must also be evaluated in terms of its consistency with the facility's mission and its effectiveness in satisfying programmatic and behavior management goals.

Arrestee Visiting

The visiting access needs of arrestees in the intake-release area should also be considered. An arrestee may need to consult with family members or a *bondsperson* about release arrangements. One response might be to place a visiting station in the intake-release area. Such a space should:

- have a controllable access for the visitor, especially if the access is directly from outside;
- be non-contact, constructed with security partitions, security ceilings and floors, security glazing and framing, and a secure means of communication;
- be monitored by staff; and
- have a secure paper pass for obtaining signatures on papers, if appropriate to the operational policy.

SECURITY

ISSUE: Certain safeguards must be implemented to maintain security and prevent the passage of contraband during visitation.

RESPONSE: The following considerations help provide adequate security for the visiting component.

- All visitors should be required to pass through a *metal detector* to screen for weapons prior to entering the visiting area of the jail. This typically requires that an officer be posted at the point of access to the visiting area to operate the machine, but this position can often double as the reception point. It is preferably supported by direct visual monitoring from a constantly staffed post, such as Master Control.
- All non-professional visitors who participate in contact visiting will normally be required to place all personal belongings and outer garments in *locked storage space* in the public lobby. This is optional for non-contact visits.

Lockers might be coin-, token-, or key-operated, depending on whether jail staff are to have any control over them. If staff control the use of the lockers, planners must decide who will issue the token or key and how issuance and return will be accomplished.

- An area should be designated to privately *search visitors* who might present a danger to jail security or to staff and inmate safety,
- An area should be designated to privately *search inmates*, particularly after contact visits.
- **Signage** should be posted that puts visitors on notice they are subject to search if there is reasonable belief that they threaten staff, inmate, or public safety.
- **Signage** should be posted in the public lobby to inform the public of visiting rules and regulations (e.g., length of visit, acceptable behavior, smoking restrictions) and the sanctions for violation.
- Access to visiting should be through a *security vestibule* controlled by staff, rather than directly from the waiting area/lobby.

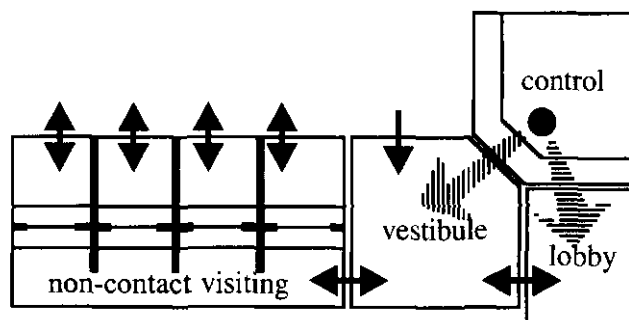

- Staff should be posted to visually *monitor* the visiting area and the security vestibule directly.
- A means of communication should be provided for staff to **speak** to visitors and inmates in designs where the supervising officer is posted outside of the visiting area. Communications are needed to correct misbehavior as well as to announce the beginning and end of visiting periods.
- A means of communication by which **visitors** can voluntarily speak to supervising staff should be considered. It should be physically activated by the visitor rather than voice-activated to avoid accusations of unauthorized monitoring and privacy violations.
- The **wall** separating the visitor and the inmate should be part of a defined internal security zone, if not the main security envelope, that precludes penetration. This includes the vision panel, panel framing, and even the communication device used if it forms part of the security of the wall. The ceiling and floor elements that help form the zone should be securely constructed as well.

QUALITY

ISSUE: The quality of the visiting area is important in responding to the needs of both the visitor and the inmate.

RESPONSE: There are a variety of ways by which the integrity and quality of the visit can be reinforced in design.

- **Communication** between visitor and inmate in non-contact visiting must be of good quality (sufficiently loud and clear). The best way to achieve good sound quality is to use telephones. Be sure to have two on the visitor side of two-person stations. Communication through the vision panel frame (as offered by some detention equipment manufacturers) is also an option. Perforations in the top of the sill of the vision panel frame have been used successfully for communication purposes. The key to this approach is to provide enough perforations to allow satisfactory sound transfer but to ensure that no contraband can be passed through them.
- **Acoustic treatment** of the space should allow for sound levels that permit privacy and conversation without raising one's voice. Sound transfer from neighboring visiting areas should be minimized and, if possible, excluded through the provision of generous amounts of sound-absorbing material. Acoustics within fully enclosed individual non-contact spaces can be particularly bad (sound reverberation) unless sound-absorbing materials are provided.
- If **smoking** is permitted on the visitor's or the inmate's side, proper ventilation should be provided.
- Non-contact visiting booths should provide **ample space** for comfort and include a counter surface for writing or leaning.
- In non-contact visiting stations, the inmate and visitor should be able to **see** each other comfortably by means of a fairly large security-glazed view panel. This not only enhances view but makes the otherwise small visiting spaces seem larger. Determine whether visitors will be seated, standing, or both (which sometimes occurs with two visitors).
- **Natural light** is beneficial to the quality and openness of the visiting area.

SPACE LIST

Some of the typical spaces that might be found within the visiting component include:

- Reception desk/counter/space
- Public waiting
- Locker storage
- Secure entry vestibule
- Public search
- Inmate search

Non-contact visiting
 One-visitor station
 Two-visitor station
 Contact visiting.

Other closely affiliated or space-sharing areas:

Public lobby/night lobby
 Public toilet areas
 Intake-release area.

RELATIONSHIPS

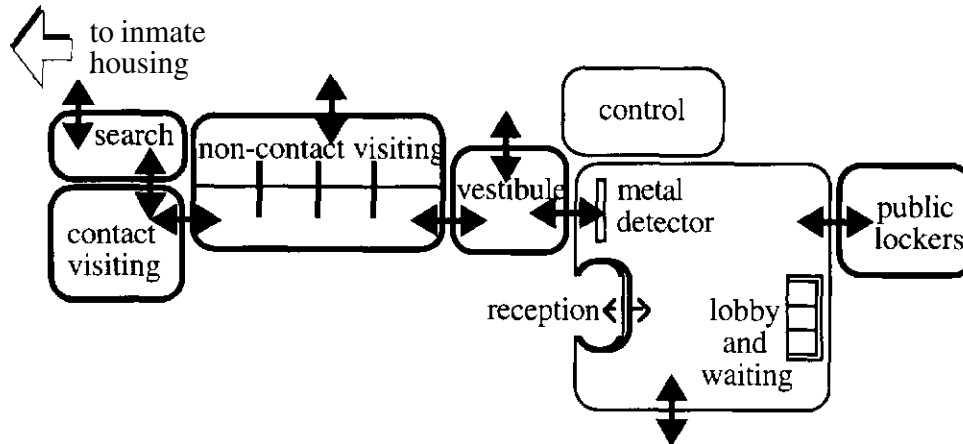

COMPONENT DIAGRAM

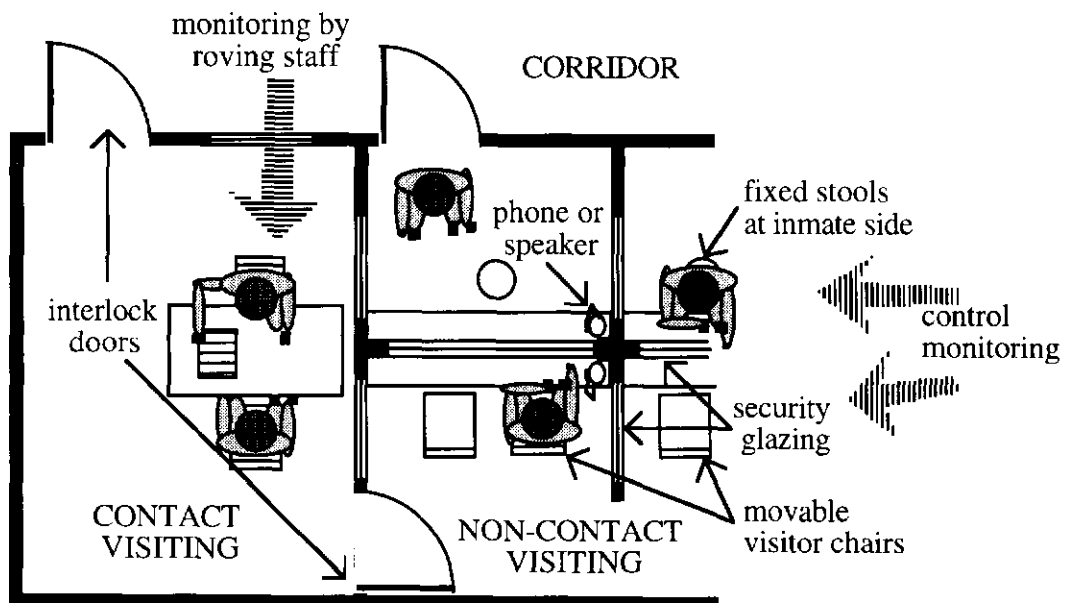

EXERCISE AREAS

DESCRIPTION

Active *indoor and outdoor exercise* outside the housing units is important to the physical and mental well-being of inmates and to facility security, providing a positive outlet for inmate energies. Outdoor exercise is thought to be especially beneficial to both emotional and physical well-being because of exposure to fresh air and sunlight and because it provides a temporary release from confinement within the building.

The most beneficial and typical kinds of *active* exercise found in jails are:

- basketball,
- volleyball,
- weightlifting, and
- calisthenics.

In the past, many small and medium-sized jails did not provide both indoor and outdoor exercise areas. In those providing neither, exercise was limited to individual efforts to do calisthenics in cells or dayrooms.

The provision of indoor and outdoor exercise areas in new jails has generally become an expected practice. Organized recreational programs involving trained recreational staff, competition, and training as are sometimes found in large jails or prisons are not characteristic of small and medium-sized jails because of limitations in staffing, space, inmate population, and length of stay.

Indoor exercise differs from indoor recreation in that it features very physical and vigorous activities that require special space and equipment. Indoor recreation is addressed in the section on "Programs/Services."

Jail administrators report that the availability of outdoor and indoor exercise results in fewer operational problems such as inmate on inmate assaults, inmate assaults on staff, damage to jail property, and lawsuits. These benefits are in addition to the health and psychological benefits for inmates.

KEY DECISIONS

As the role of the exercise component is evaluated, the following decisions should be made since they have a fundamental effect on design requirements.

- Will both outdoor and indoor exercise space be provided or only one or the other?
- Will indoor exercise areas be provided outside the inmate housing units or will special exercise areas be incorporated into the housing units (such as weightlifting)? If outside, will the areas be adjacent to

the housing units or one central exercise area for all male and female inmates (general and special housing)?

- Will groups of inmates be mixed to some degree or will they exercise separately according to housing unit group? If the former, what is the makeup and size of each "mixed exercise group"?
- Who will monitor the exercise activity and how?
- If outdoor exercise space is provided, should it double as emergency evacuation space?
- Should exercise areas be sufficient in size and number to accommodate a future expanded inmate capacity?

DETAIL ISSUES

The following detail functional-architectural issues should be considered in the development of exercise areas.

INDOOR AND OUTDOOR

The following issues apply to both indoor and outdoor exercise.

Users

ISSUE: The numbers and types of people to use exercise areas should be determined.

RESPONSE: There are three principal types of potential users:

- inmates,
- law enforcement or jail officers as part of their fitness or community involvement programs, and
- the public, with or without inmate participation.

It is important to identify the number of *inmate groups* that must exercise at separate times because of separation and supervision concerns. These groupings should respect the basic classification/separation requirements of the facility unless the level of staff supervision for exercise is sufficiently high to allow some merging of groups housed separately.

Once the number and types of groups are identified, the maximum group size should be determined since that size will influence space and equipment requirements as well as staffing needs.

Capacity expansion possibilities should also be identified to determine if a larger group must someday be accommodated or if additional exercise spaces should be planned.

Size

ISSUE: The size of exercise areas should be based on activities and group sizes.

RESPONSE: Activities should be chosen on the basis of what is most useful and productive for the inmates and the staff alike. Different *activities* require different amounts of space. For example, a small half-court basketball area would require 1,600 to 2,688 net square feet (regulation high school dimensions) with a ceiling height of 15 to 20 feet, whereas a calisthenics area might require only about 300 net square feet and a 9-foot ceiling height for the same number of users.

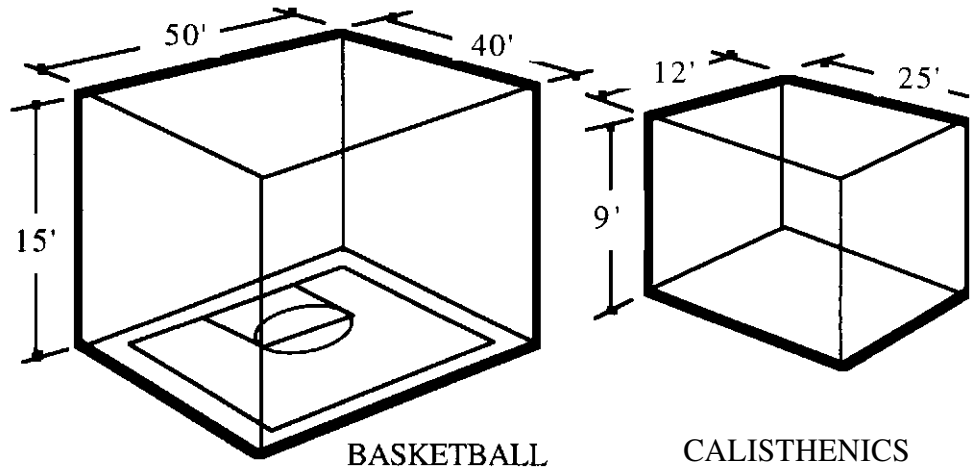

Additionally, each space may have *secondary areas* to accommodate other activities concurrently (such as weightlifting and basketball), Or they may provide seating areas for those who are resting between activities, awaiting an opportunity to participate, or, in the case of outdoor exercise, merely enjoying the fresh air.

The *number of people* to use *an* exercise area at any one time clearly affects space size. Twelve people playing two 3-on-3 games of basketball, for instance, would require two half-court areas at about 3,100 to 5,040 net square feet total. However, eight people playing one 4-on-4 game need only about 1,600 to 2,688 net square feet -- not counting secondary areas for sitting, weightlifting, or other activities. See the space needs below.

<u>Activity</u>	<u>Minimum Dimensions (feet)</u>	<u>Maximum Number of Users</u>
Basketball (half-court; high school)	48x56x15h	10
Volleyball	72x42x20h	12
Weightlifting (weight machine)	12x16x8h	4-6
Sitting	15 s.f./person	

Number of Areas

ISSUE: The number of separate exercise areas needed depends on scheduling, staffing, and the number of different exercise groups.

RESPONSE: Most small and medium-sized jails will need only one indoor and one outdoor exercise area. However, this cannot be known with certainty until a variety of factors are considered. Additionally, space-sharing options with other functions cannot be ascertained until all factors about exercise area use are considered.

Scheduling is a major determinant regarding the number of areas

- **Frequency:** how often inmates will exercise outside the housing area -- once a week? three days a week? five days a week?
- **Duration:** the length of time per exercise period, including movement time between housing and exercise areas -- 30 minutes? one hour? two hours?
- **Hours of operation:** the number of hours per day the exercise area is available for use. This is frequently limited by other basic activities, such as food service and visiting, that absorb staff and inmate time during the day.
- **Weather Conditions:** the number of days per year that weather would typically prohibit use of an outdoor exercise area might influence the size and type of space for the indoor area.

Staffing is a major consideration, particularly when special staff must be retained to supervise the exercise activity. The need or desire to minimize staffing can limit the hours available for exercise.

The *number of different groups* needing to exercise is critical since small and medium-sized jails can easily generate 8 to 12 different groups if a strict adherence to housing unit separation is adopted.

Sample Calculations

Daily Exercise:

$$\frac{2 \text{ hr. duration} \times 12 \text{ groups}}{8 \text{ hrs. of operation per day}} = 3 \text{ SPACES REQUIRED}$$

$$\frac{1 \text{ hr. duration} \times 8 \text{ groups}}{12 \text{ hrs. of operation per day}} = .67 \text{ SPACES REQUIRED}$$

In the second calculation, only *one* space is needed and that space can be shared with other activities as appropriate since, given the hours of operation per day, there appears to be "excess" space -- at least until *future needs* demand more of the space.

Support Space

ISSUE: Space should be provided for staff who supervise exercise activities.

RESPONSE: Staff can be accommodated in several ways:

- an enclosed or open-counter control post immediately adjacent to, but separate from, the exercise area;
- an enclosed or open-counter post in visual contact with, but separate from, the exercise area and also monitoring other areas such as housing; or
- an open post within the exercise area sufficient to allow staff to observe without getting in the way of activity.

In providing staff space, it is important to provide the officer with a communication link to Master Control (assuming that Master Control does not observe exercise). Backup monitoring by CCTV may be useful to ensure the safety of the officer, especially when the officer is within the space directly supervising the inmates.

ISSUE: Equipment storage should be provided.

RESPONSE: A lockable area adjacent to the exercise area allows for the secure storage of exercise and maintenance equipment: basketballs, volleyballs, volleyball nets, weights, frisbees, brooms, hoses, etc. Smaller items may be stored in cabinet space at the control post that monitors exercise.

ISSUE: The design should consider basic human needs.

RESPONSE: Depending on the duration of each exercise period, it may be appropriate to provide a *drinking fountain* and a *restroom* for the area. Such amenities in outdoor exercise areas must be protected against freezing conditions. Restrooms should be designed to provide privacy as well as appropriate monitoring and control.

Shower and/or locker areas are typically not necessary for inmates since they can use the facilities in their housing unit. If staff are to use the exercise area, the location of any such facilities for them should be considered in light of access to the exercise area.

ISSUE: Office space for professional exercise/recreation staff should be considered.

RESPONSE: If the jail is large enough to support formal exercise and recreation programs requiring professional staff, office space should be

considered. Such space should be close to the exercise areas to allow some supervision capability.

Movement and Control

ISSUE: Determine how inmates will gain access to exercise areas and how they will be monitored.

RESPONSE: Some movement and surveillance concepts follow

- Have one large central location to which all inmates are moved and subsequently monitored by special staff.

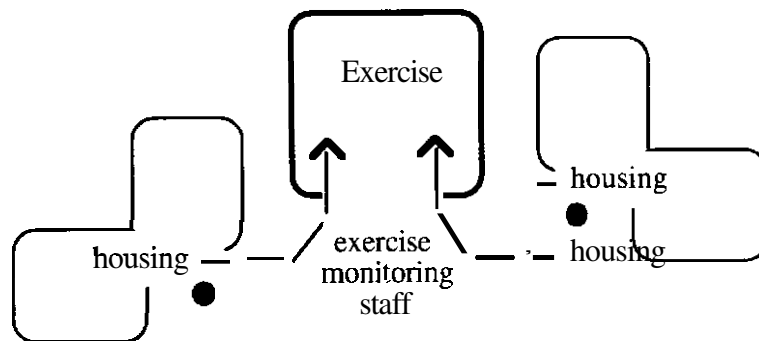

- Have inmates move to one large location monitored by a constantly staffed post that also monitors other areas such as housing (e.g., Master Control or housing control).

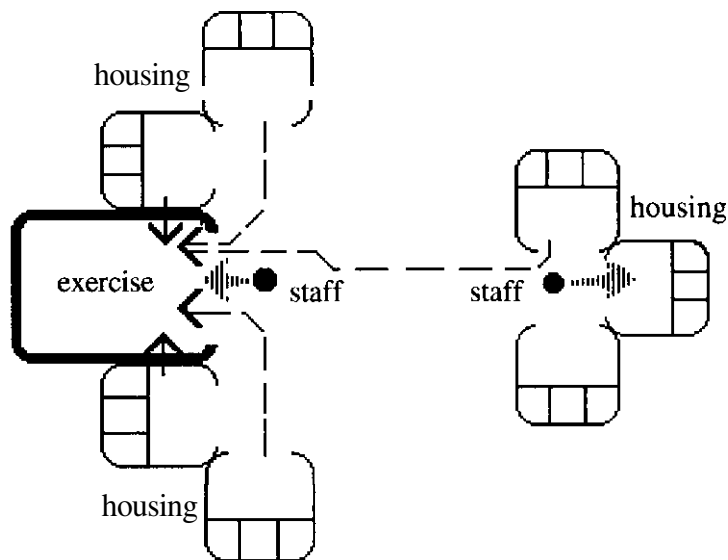

- Create exercise areas immediately adjacent to each housing unit or cluster to be monitored by a constantly staffed post that also **moni-**

tors other areas such as housing, thus eliminating movement of inmates through corridors to exercise areas and maximizing use of a "fixed post staff.

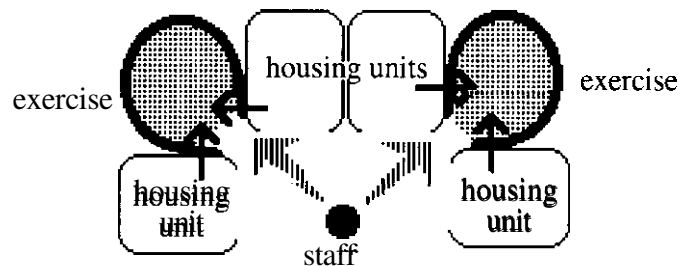

A benefit of placing outdoor exercise areas adjacent to housing units is that they can securely introduce *natural light* into dayrooms (and potentially cells) and serve as directly accessible *temporary containment* areas in case of an emergency.

Classification and separation criteria should *be* evaluated when developing the movement and control scheme to prevent unwanted contact among different inmate groups.

Communication

ISSUE: A means of communication between staff and inmates in the exercise area and other staff should be provided.

RESPONSE: Roving security and/or control post staff must be able to communicate with the inmates and staff in the exercise area. Depending on the location and roles of staff, the following methods might be considered to communicate with inmates:

- intercom,
- public address speaker, or
- direct voice communication through an opening in the exercise wall.

Multi-Purpose/Public

ISSUE: Public use of an exercise area requires secure access that does not compromise perimeter security, movement paths separate from those used by inmates, and precautions to prevent contraband passage.

RESPONSE: If the public is to use an inmate exercise area for program purposes, secure access should be provided by locating the area near the public lobby and creating a monitored security vestibule entry. The public users should enter and exit the exercise area along routes that are separate from those used by inmates.

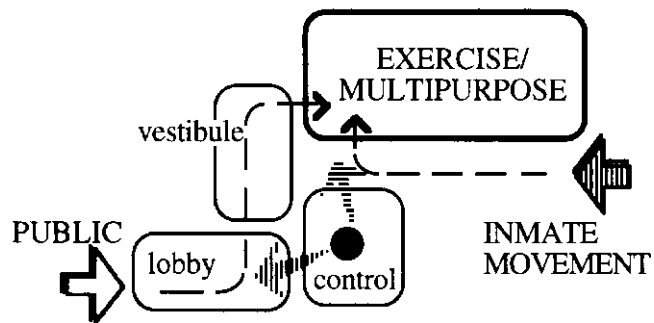

On those occasions when the public is allowed inside the security envelope, precautions must be taken to prevent the introduction of contraband. Precautionary measures include lockers in the lobby for storing personal property, a metal detector immediately in front of the security vestibule, and staff searches of the exercise area and inmates.

ISSUE: Opportunities for vandalism and damage should be minimized.

RESPONSE: Light fixtures, vent grills, drain covers, and other details should be handled in the same secure and protected manner as they would be within housing units.

COMBINATION INDOOR & OUTDOOR EXERCISE

ISSUE: A single space that functions as both an indoor and outdoor exercise area can be a prudent choice for some jurisdictions.

RESPONSE: In some jurisdictions, it is allowable to create a single, specially designed space that simultaneously meets standards for indoor and outdoor exercise. So doing is a less costly and more space-efficient way of providing both capabilities. It may also mean a greater likelihood that both capabilities will be made available to inmates in smaller jails since it is easier to design one large space manageable from a fixed staff post than two.

Climate is also a motivator for the dual-use concept. In cold northern climates, providing a large outdoor exercise area, with expensive high walls, costly structure and screening overhead, and perhaps a second special staff post, is difficult to justify when periods of use are limited. In climates with long rainy seasons, an outdoor exercise area becomes useless for extended periods.

The primary method of creating the dual capability is to create a large opening in one or more walls of an indoor space and to superimpose a *moveable or roll-up shutter* over the opening. With this technique, fresh air can be provided to inmates once the shutter is opened, thus satisfying the technical definition of "outdoor" exercise.

Other design considerations include:

- the openings must be covered by a protective screen that prevents escape and precludes contraband passage;
- the space should be tall (15 to 20 feet high) so that openings can 1) be large enough to allow significant fresh air movement, and 2) have a sill height considerably above inmate head height so as to minimize outside view conflicts with the public;
- the openings should be oriented to allow the introduction of sunlight, and/or skylights should be provided;
- the walls of the indoor space must be developed as though they were exterior walls, i.e., impervious to rain and cold;
- the floor of the space must have drains;
- a space heating unit might be provided to independently heat the space; and
- the space should be monitored by CCTV from the exterior to protect the openings from approach by the public.

In considering the dual-use exercise space concept, a jurisdiction should recognize that its chief deficiencies are that exposure to open air and sunlight is limited and that the "outdoor" space is typically smaller than normally provided. Before committing to the concept, a jurisdiction should verify that it:

- is consistent with the facility mission and goals,
- provides adequate exposure to outdoor air and sunlight, and
- is consistent with applicable codes and jail standards.

INDOOR EXERCISE

The following detail functional-architectural issues apply to indoor exercise.

Multi-Purpose Functioning

ISSUE: If an indoor exercise area is to be used for more than exercise functions, the functions should be carefully selected and appropriately accommodated through design.

RESPONSE: Smaller jails frequently attempt to use an indoor exercise area for library, chapel, and counseling functions, among others. For such multiple users, some special accommodations may be needed. For example, to use an indoor exercise area as a library, exercise must be limited to light and restricted activities, such as table tennis or weightlifting, and/or the library stacks must be in shuttered cases or in areas that can be partitioned off for protection during vigorous activity. However, the characteristics of an exercise area used for vigorous activities are generally not compatible

with those desired for other program/service activities in terms of functions, materials, and environmental quality. More on the multi-purpose question can be found in the functional-architectural section on "Programs/Services."

Contact visiting areas are generally not compatible with exercise spaces because contraband could be hidden during visiting hours and retrieved later during exercise periods when thorough body searches are not routinely done.

Aside from architectural compatibility, one key to determining the potential for creating a multi-purpose exercise area is to do a *realistic schedule* of all activities and to determine the needs and numbers of persons using the activity. Future needs must also be considered.

Environmental

ISSUE: Sound quality in, and noise transmission from, exercise areas should be controlled.

RESPONSE: The level of sound in an indoor exercise area can prevent people from communicating effectively. Communication via intercom systems is obscured because of "echoes" created by hard surfaces. Some acoustic treatment and/or use of floor surfaces more sound-absorbent than concrete are helpful (carpet or applied resilient floorings, for example).

Since exercise is a potentially noisy activity, good sound insulation between areas is particularly helpful when the exercise area is adjacent to housing, visiting, counseling, and control functions.

OUTDOOR EXERCISE

Activities

The following detail functional-architectural issues apply to outdoor exercise.

ISSUE: Plan to use outdoor exercise areas in cold and inclement weather.

RESPONSE: Damp or cold weather will not necessarily eliminate inmates' desire to get some fresh air or sunlight. Therefore, a facility should be prepared to issue appropriate clothing -- gloves, jackets, shoes, and hats. Proper space for storage and distribution of these items should then be provided.

Security

ISSUE: Special attention should be given to controlling escape attempts.

RESPONSE: Experience and research both show that escape risks are high with outdoor exercise. Using solid, security-constructed walls and installing a *sturdy, tightly woven screen or mesh over outdoor*

areas will help solve security problems while still allowing the introduction of fresh air and sunlight.



Outdoor exercise area with security screen above.

Blind spots should be eliminated wherever possible, and drain covers, fixtures, and other items that can be dislodged and used as tools to aid in an escape attempt should be securely fastened.

To help solve staff surveillance problems, locate outdoor areas where they can be seen from a constantly staffed post. CCTV monitoring in lieu of staff surveillance or supervision fails to provide the necessary ability to detect and respond to escape attempts and fights between inmates. To allow control and surveillance of the area at all times, whether or not it is being used, consider providing artificial lighting for the area.

ISSUE: Special attention should be given to controlling contraband passage.

RESPONSE: The passage of weapons, drugs, messages, and other contraband to inmates by outsiders can be controlled through a combination of operational and architectural means. Operationally, staff should check the exercise area for contraband before, after, and during exercise periods. Architecturally, the same techniques noted above as ways to control escape attempts should be considered. Another idea would be to surround the exercise area by the building itself, thereby making it less noticeable and accessible to outsiders.

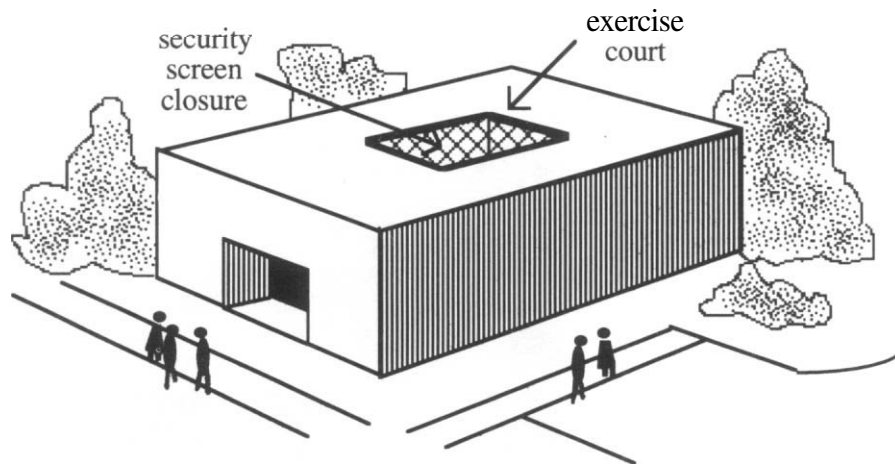

A special security concern arises when *work release and/or inmate workers* use the same activity space as the general inmate population, regardless of whether that space is outdoor or indoor. There is a potential for contraband passage by prior **arrangement** that must be managed by searches of the space and the inmates.

Another physical detail to control is drainage. Openings in walls for exercise area drainage or snow removal can provide a natural route for contraband passage if they are adjacent to public areas and are not properly screened or protected.

ISSUE: Outside view and voice contact between the public and inmates should be controlled.

RESPONSE! Although the use of high, solid walls eliminates direct public view of and conversation with exercising inmates, sound is nearly impossible to isolate totally. In populated areas, placing the outdoor **area(s)** toward the back of the facility helps control random **public/inmate** sound transmission. Constructing rooftop exercise areas to minimize contact problems is discouraged because additional movement problems, staff requirements, and snow removal and drainage problems result.

Fire Safety

ISSUE: Outdoor exercise areas should be evaluated for their potential as a controlled emergency refuge area.

RESPONSE: *All* jail administrators face the problem of controlling inmates during emergency evacuations. In many cases, emergency evacuation needs are limited and can be handled by moving inmates from one **fire**-protected zone of the building to another. However, evacuation from the building itself may be necessary. In this case, it may be useful to let an outdoor exercise area double as a place of outdoor refuge, thus solving evacuation needs without releasing inmates to the street.

Specific requirements apply for an outdoor area if it is to be used as a temporary refuge. According to the National Fire Protection Association's 101 *Life Safety Code*, all inmates should be able to attain a specified distance from the building at risk (see the code for current requirements). Once that distance is reached, there are specific requirements for the number of square feet required per inmate and other occupant (potentially staff) in the refuge area.

A security exit door from the refuge area to the outside should be provided, with a security lock, hardware, jamb, head, and threshold. A two-door vestibule system at the exercise wall is another possibility. Keys to the refuge exit door(s) should be controlled by staff, with a separate set accessible to the fire department under controlled circumstances.

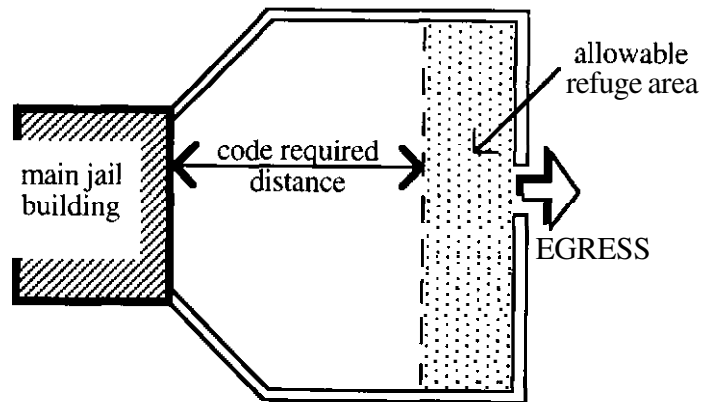

Planners should refer to state and local fire codes to determine the requirements that must be met to use outdoor exercise areas as places of refuge in their specific jurisdiction.

SPACE LIST

Some of the spaces that might be found within the exercise component include:

- Indoor exercise area
- Storage
- Restroom*/search
- Exercise/recreation office

- Outdoor exercise area
- Storage
- Restroom*/search
- Coat/hat storage.

* See local codes and the ADA regarding handicapped accessibility requirements.

RELATIONSHIPS

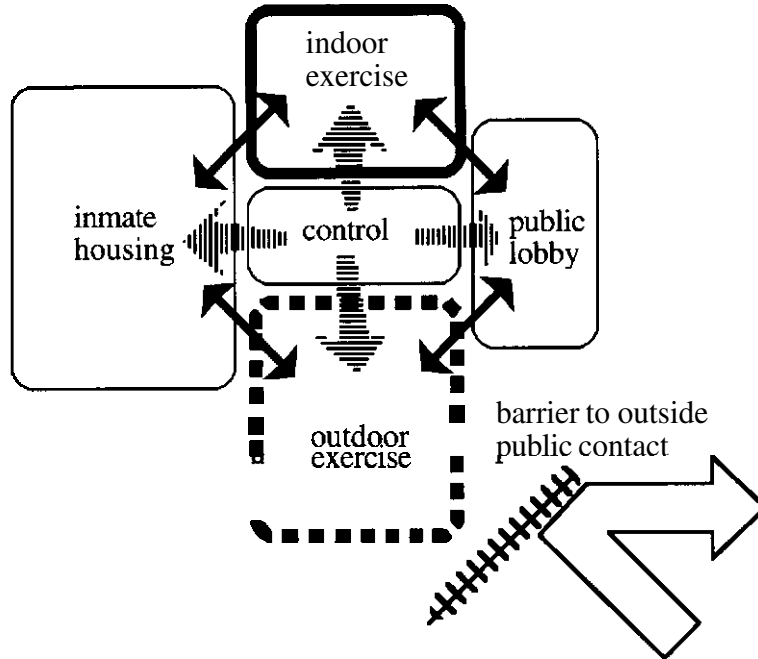

COMPONENT DIAGRAM

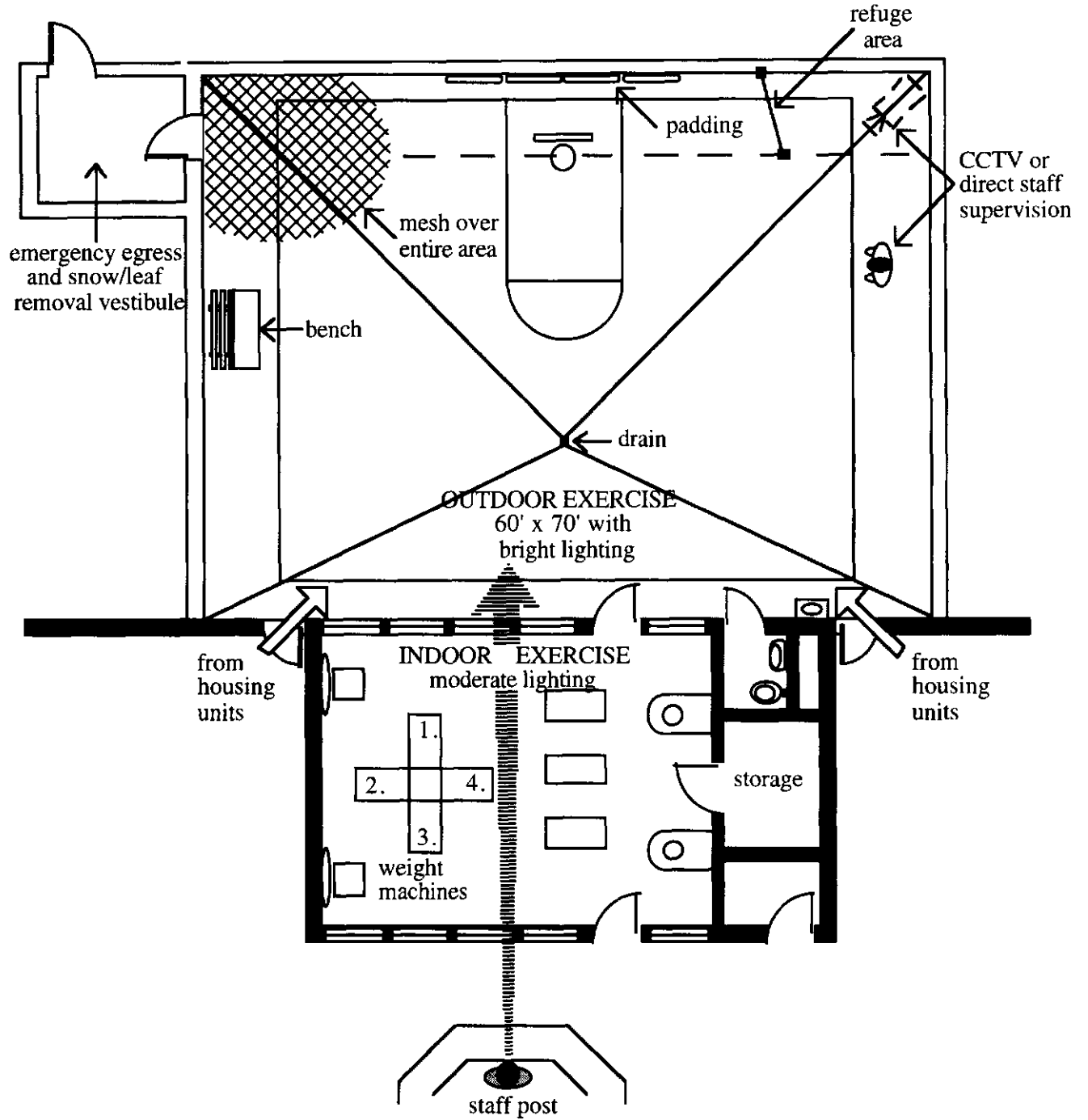

PROGRAMS/SERVICES

DESCRIPTION

A variety of programs and services can be provided to enhance staff **man-**agement capabilities and fulfill the mission of the facility, whether that focuses on restraint, reintegration, reform, or rehabilitation. Some programs and services are required by state standards and **court** decisions, such as religious services and legal library resources.

This component addresses the functional design issues regarding the following inmate programs and services. (Jail industries would also be included in this component, if the jail decides to implement such a program.)

- counseling,
- religious services,
- legal and recreational library,
- education, and
- recreation.

In the past, space for these activities was generally unavailable in smaller jails. Consequently, the jail administration's ability to respond to legal demands for programs and meet evolving concepts of inmate management was limited to a great extent by physical plant design. In response, some jurisdictions converted cellblock, office, or adjacent law enforcement areas (such as the sheriff's residence) to program space. Such attempts to create program space frequently created security and movement problems for the jail.

Today it is important to consider program and service space during the earliest stages of planning. A common response for small and medium-sized jails is to create *multi-purpose areas* that are sufficiently large **and/or** flexible to meet the needs of a wide variety of programs and services that might be provided instead of creating separate spaces for each. Practically speaking, the extent to which programs and services are provided must be balanced against the relatively short stays of the majority of inmates and the availability of qualified service providers, including community services and citizen volunteers.

KEY DECISIONS

As the role of the programs/services component is evaluated, the following decisions should be made since they have a fundamental effect on design requirements.

- Which programs and services will be provided (consistent with the facility's mission and state standards)?
 - How frequently will they be provided, and to whom?
-

- To what extent will outside resources be used, whether it be service providers coming to the jail or inmates going out to the services?
- Will the nature and frequency of selected programs and services permit use of a multi-purpose space? What programs and services should *not* occur in the same space because of security, functional, or environmental conflicts?
- Will small-scale, passive recreational programming be provided? If so, in lieu of vigorous indoor exercise or in addition to it?

DETAIL ISSUES

The detail functional-architectural issues that are most crucial to the inmate programs and services component are discussed here. General issues that seem applicable to all of the programs and services are discussed first, including the multi-purpose concept and the compatibility issues that surround it. Issues relevant to individual programs or services are then addressed.

GENERAL ISSUES

The following issues apply generally to the inmate programs and services component.

Location/Users

ISSUE: The location of program and service components should facilitate proper surveillance and supervision, effective functioning, and access for public users.

RESPONSE: A consistent characteristic of inmate program and service spaces is that outside service providers and the public will use the spaces in conjunction with the inmates. This suggests several general principles about the location of inmate program and service areas:

- They should be easily accessible through a *secure vestibule entry* through the security envelope of the jail to minimize the extent to which the security envelope is penetrated and ensure control of all movement into the jail.
- Public users should be cleared through a *metal detector* before entering any area to which inmates also have access.
- If possible, the inmate program and service areas should be *observable* from a constantly staffed post without violating the privacy required by the function, service, or program taking place.
- Program and service areas should be sufficiently *isolated* from significant noise generated by movement within the jail or other activities -- mechanical areas, indoor or outdoor exercise areas, kitchen, and laundry.

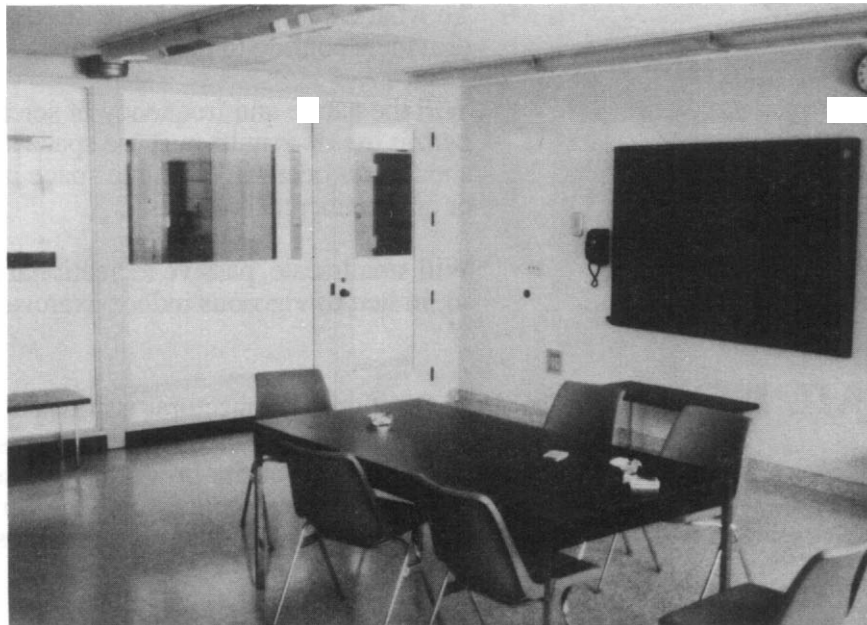

A multi-purpose space visible from a staff post across the corridor.

Separation1 Supervision

ISSUE: Separation requirements and supervision methods for program functions will affect the need for space.

RESPONSE: Separation criteria may be quite different for program and service functions than they would be for the housing areas. The degree to which separation requirements **are** minimized depends a great deal on the method of supervision, the nature of the activity, and the duration of the activity.

Depending on pertinent standards, it may be that both medium- and low-security adult male inmates and even selected adult female inmates may jointly participate in a substance abuse counseling program or in religious services. This possibility increases if program staff **are** present at all times during the event and the space is under observation by a security officer. Such merging of variously separated inmate groups reduces scheduling demands on the space and the possibility that more than one space will be needed.

Conversely, if an activity such as recreation were to take place without constant and direct supervision by staff or even observation from a remote post, it would be best to maintain the same separations used in housing. In reality, sound practice and common sense dictate the need for continual supervision since the competitive nature of most recreational activities can lead to conflict.

Quality

ISSUE: The quality of the program and service area environment should reinforce and complement the activities.

RESPONSE: The following considerations generally apply to inmate program and service areas:

- *Visualprivacy* from activity and movement in adjacent spaces that might distract program participants or detract from the activity at hand.
- *Acoustic privacy* through the use of ceiling treatments, carpeting, insulated walls, and other techniques that improve sound quality and minimize sound transfer from other activities and functions.
- The introduction of *natural light*.
- *Adequate artificial light* for particular activities, including some ability to control and vary light levels and focus.
- Pleasant and comfortable surroundings in general.

Security

ISSUE: Inmate program and service areas should be provided with adequate security.

RESPONSE: Even though inmate programs and services are generally considered benefits that might elicit positive inmate behavior, the fundamental security of the areas should not be compromised in any way. In essence, these areas should be developed much like any other secured area in the jail. Some considerations:

- Regardless of the interior treatment of the program spaces, the *perimeter* of the area -- especially when it includes exterior walls -- must be as secure as any other portion of the building.
- *Windows* to the exterior should have the same security design elements as any other exterior window in the facility, although the narrow slits of glazing preferred for cells may be unnecessary in directly supervised program areas. View conflicts should be minimized.
- Program and service area interiors ideally should be *visible* from a constantly staffed post. At a minimum, access to those spaces should be observable from a constantly staffed post, and roving staff should be able to view interiors from adjacent corridors.
- Staff and service providers working with inmates should be able to *communicate* directly with staff at a fixed post. A two-way intercom would be appropriate for this purpose.
- In cases where direct observation is not possible, CCTV should be considered but never relied on as the sole means of surveillance.

Generally, CCTV monitoring of counseling and interview spaces is permissible. However, it should be as unobtrusive as possible and should not hinder communication between participants. Under no circumstances should staff be able to monitor, either by audio or visually, privileged communications between inmates and legal counsel or clergy. In some states, inmates' consultations with legal counsel are to be out of view of all staff.

Multi-Purpose Possibilities

ISSUE: Multi-purpose space sharing for inmate programs and services is desirable as long as schedules do not conflict and functions are compatible.

RESPONSE: The relative infrequency with which programs and services might occur in a small or medium-sized jail provides an opportunity to save space through the creation of a multi-purpose program space. However, it cannot be automatically assumed that one multi-purpose space will meet all demands. Several important considerations must be taken into account when assessing the extent to which a multi-purpose space suits the program and service needs of a jail.

Schedule

- The *schedule of activities* is critical in assessing multi-purpose potentials. The planner must identify each program or service that will take place now and potentially in the future, and the frequency and duration of each activity. This information should be charted to determine the extent to which there is a demand for programs and services.

Additionally, the schedule should reflect *when* programs and services will occur. For example, most programs and services may be in the evening hours for the convenience of outside service providers, thereby precluding use of a single multi-purpose space.

Flexibility

- The *flexibility* of the multi-purpose space is crucial. The space must be able to accommodate the different furniture and equipment needs of each of the programs or services to take place there. For example, tables needed for table tennis are not appropriate for religious chapel services, so they must be moved out of the way. Moveable, foldable, and/or stackable furniture is essential for a multi-purpose space. In addition, ample *storage space* for equipment and supplies adjacent to a multi-purpose area is critical.

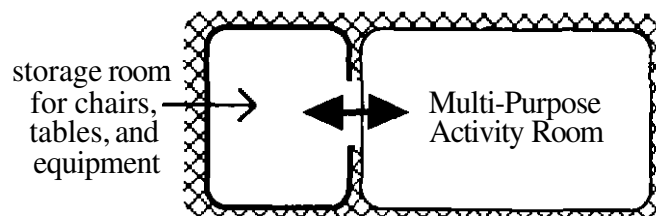

Flexibility also includes being able to adapt the fundamental character of the space. For example, it is valuable to provide acoustically effective *foldable or removable partitions* in the multi-purpose room to allow the size and character of the space to change as the functions and their needs change. This flexibility could allow for more than one group to use the space at the same time.

Another important flexibility consideration is the amount of *time* it takes to move furniture and change the character of the space to accommodate another function. Such setup time might be a critical factor in the scheduling of activities and the determination of whether a multi-purpose space can accommodate as many functions as originally thought. A good example of a potential setup problem occurs when the dining function is merged with a multi-purpose space function. The time it takes to clean the area after meals, move tables and chairs out of the way, and reset that furniture three times a day creates considerable problems in terms of having adequate time to accommodate other functions in the multi-purpose space.

Flexibility also means providing accommodations for varied lighting needs, environmental needs, and equipment needs (audio/visual equipment, screens, etc.).

Compatibility

- The fundamental compatibility of the various programs and services targeted for a multi-purpose space must be closely assessed. It is possible that saving space by combining as many functions as possible would compromise the effectiveness or security of some functions.

The following *matrix* displays recommendations about the compatibility of certain programs, services, and functions that have sometimes taken place in a single multi-purpose space.

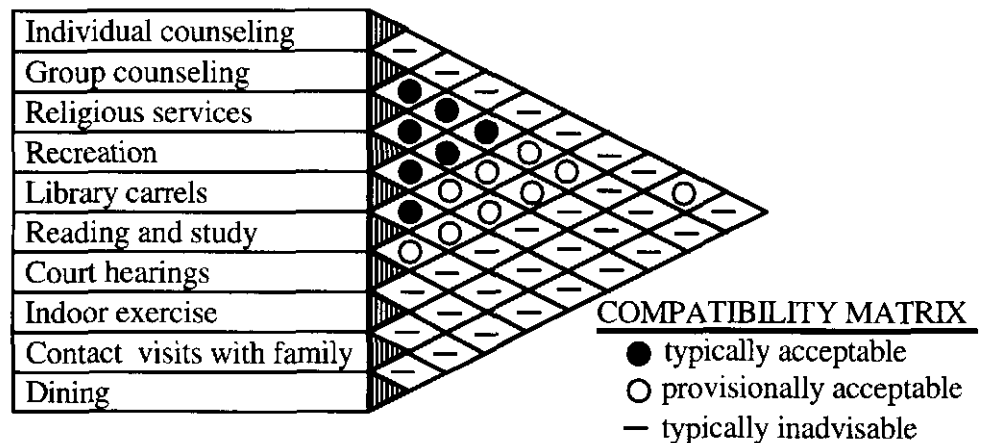

As noted in the matrix, some relationships seem compatible with certain *provisions*. These relationships and their provisions **are** explained below.

- **Library carrels/reading area.** Compatibility depends on the degree to which normally cumbersome study carrels can be moved out of the way during other activities and on the degree to which they contain equipment, such as tape players and audio equipment used in training, which should be protected from inmates during other activities.
- **Court hearings.** Compatibility depends on the proper location of the space so that the general public and court personnel can gain access without penetrating the **inmate-**occupied areas of the jail. It also depends on the frequency of use. For example, daily morning and afternoon sessions would pose problems for other program uses during the day.

Another consideration is the need for fixed furniture and equipment to serve **court** purposes, such as a judge's bench, podiums, microphones and electronic gear, a court reporter's desk, and even a jury box.

The need for the public and legal personnel to move through a secure entry vestibule to court functions is another consideration. Such a secure entry would be required if the court hearing room had a multi-purpose capability that involved inmate programs and services.

If court hearings are limited to CCTV arraignments, there is no incompatibility with the multi-purpose room as long as equipment can be stored **and/or** secured. Equipment would include a television monitor, camera, and microphone setup for the inmate, supervising officer, and, perhaps, an attorney.

- **Contact visiting.** Contact visiting can be compatible with individual counseling spaces. The space must allow visual monitoring while at the same time provide privacy for individual counseling purposes. Shutters and blinds may aid in providing the needed flexibility.

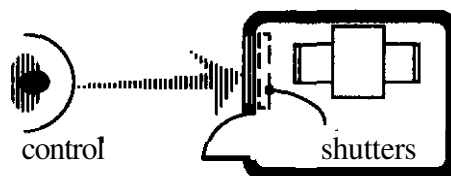

As noted in the compatibility matrix, some functions seem clearly *incompatible* with other functions and therefore should not be conducted in the same multi-purpose space.

- **Dining.** The dining function seems minimally compatible with any of the other programs and services listed owing to the problems of dedicating the space for dining three times a day, the cleanup and setup time that is involved, and general concern about odors and sanitation.
- **Indoor exercise.** The scale, the acoustics, the equipment, and the vigorous use of indoor exercise spaces, particularly those that accommodate such activities as basketball and volleyball, are fundamentally incompatible with the characteristics and needs of other inmate programs and services.
- **Individual counseling.** Individual counseling spaces are intended for one-on-one counseling sessions. Spaces that are overly large, inadequately private, or subject to distraction should not be used as counseling rooms, if at all possible. However, individual counseling rooms may be included within the multi-purpose area.

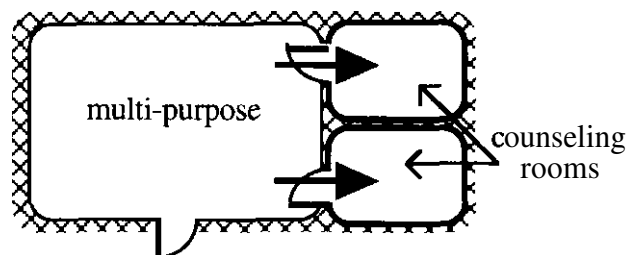

- **Contact visiting.** Concern over the possibilities of contraband passage and the need to keep the general public out of the jail security envelope whenever possible suggests that contact visiting should not be merged with a multi-purpose function if it can be avoided. Rather, contact visiting should occur in a controlled area just outside the primary inmate-occupied areas of the jail. See the functional-architectural section on "Visiting Areas" for more information on location and design.

COUNSELING

Counseling can be a valuable service to the inmate, the facility, and the community. Counseling services can help inmates deal with the tension and anxiety of their situation, aid them in adjusting to jail life, and assist them in controlling chronic personal problems. Counseling activities can include crisis intervention, substance abuse, family, religious, educational, and employment. It can also involve orientation of new inmates to the rules and practices of the facility.

Counseling Space Types

ISSUE: The nature of counseling activities should be identified to determine the type of space required.

RESPONSE: Two fundamentally different types of counseling potentially involve different demands for space. One is *individual* counseling, which is a one-on-one experience between the inmate and the counselor. The other is *group* counseling, which usually involves a counselor and two or more inmates. Group sessions are most common in substance abuse counseling. Ideally, individual counseling will occur in spaces separate from group counseling. Group counseling, by its nature, is much more compatible with a multi-purpose space than is individual counseling. Individual counseling is more compatible with smaller-scale spaces suitable for attorney-client visiting or contact visiting.

Counseling Space Sizes

ISSUE: The size of counseling spaces depends on the number of participants.

RESPONSE: Spaces for individual one-on-one counseling should be a minimum of approximately 60 square feet to allow for some comfort and avoid too great a sense of confinement. If the space cannot be provided with natural light and the "extension of space" that a window tends to provide, it might be desirable to provide a larger space.

The following rules of thumb might be useful for planning the size of group counseling spaces:

- three to four persons -- 100 square feet
- five or more persons -- 100 square feet, plus 15 square feet per person over four

Group counseling spaces should be properly proportioned. A nearly square space provides considerable flexibility in allowing the counselor to create group settings that focus activities appropriately.

If a large multi-purpose space that is longer and more **narrow** than desirable must be used, folding and movable partitions may be beneficial in attaining the proper size and proportions for group counseling sessions.

Number of Counseling Spaces

ISSUE: The number of individual and group counseling spaces required depends on the frequency of use, the duration of use, and the scheduling of staff.

RESPONSE: scheduling may be the key to determining the number of spaces needed; for example, if two or more counselors must come at the same time of day, more than one space needs to be available. The need to provide dedicated individual counseling spaces may be served by the use of attorney-client or contact visiting spaces. This also depends on frequency of use, scheduling, and other compatibility factors discussed earlier.

Another possibility for individual counseling spaces is using office *space* provided for program staff instead of separate counseling space. For example, if there is a work space provided for counselors, that space might also double as a counseling area if properly designed and if privacy can be guaranteed. Proper design involves having sufficient space to accommodate the counselor and the inmate in a proper setting separate from the work area. Counseling should not be planned for a shared office to which two or more staff need access at the same time.

Characteristics of Counseling Spaces

ISSUE: The characteristics of counseling spaces should complement the needs and the security of the activity.

RESPONSE: Several characteristics of counseling spaces should be considered.

- All counseling spaces should be comfortable, quiet, private, and minimally affected by outside distractions.
- Counseling spaces should have comfortable seating. It is helpful if the furniture is moveable so it can be arranged in a fashion most conducive to successful counseling.
- Natural light is beneficial but should be controlled to prevent unnecessary distractions from outside activities. It should also be provided through a securely designed window, skylight, or clerestory. Natural light improves the quality of the area and, with a window, provides some spatial relief, which tends to relax the inmate.
- Counseling spaces should be located as near as possible to the public entry into the security envelope of the jail to minimize the counselor's movement within that envelope.
- Counseling spaces should be observable from a constantly staffed post if possible, but not overexposed. Privacy for counseling is critical to eliciting proper inmate participation. Small vision panels or partially screened or shuttered openings are more appropriate than expansive vision panels fully exposing the counseling activity to officers or inmates outside the space. A two-way intercom within the space can be a valuable aid to ensuring the counselor's safety.

RELIGIOUS SERVICES

ISSUE: Religious services must be accommodated.

RESPONSE: Accommodation of the religious beliefs and practices of the inmate population is a required part of the programs and services offered at a jail. Providing access to religious activities may include:

- counseling on a one-to-one basis;
- small group instruction anytime during the week; and
- weekly formal services, potentially interdenominational.

In addition to these activities, there is usually a need to accommodate the storage of books, brochures, and paper supplies, as well as the sacraments used as part of a religious service.

Religious counseling sessions can occur in individual counseling spaces or attorney-client visiting spaces as long as schedule conflicts can be avoided. Small group instruction and weekly services are quite appropriate to a multi-purpose space. If religious services are to be held in a multi-purpose space, consideration might be given to methods of attaining a more religious environment during services. One idea, for example, would be to create an altar area that could be closed off during non-religious activity and also serve as a sacristy.

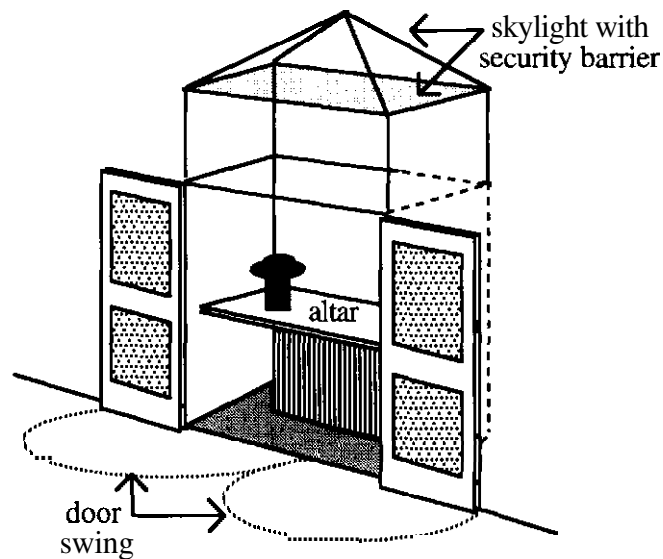

Consideration should be given to the design impact of special religious activities, such as confessions or baptisms, if they are to be accommodated. Typically, confession requires private booths that allow a priest and the inmate to communicate quietly, while seated, through a heavily veiled opening. Such a need might be accommodated by designing a confessional space within the facility or by creating a portable booth that can be stored in an adjacent multi-purpose storage area when not in use. Raised platforms for an altar area may be similarly portable.

As a **rule of thumb**, 15 square feet per user should be provided for religious services, exclusive of the area from which the cleric speaks.

LIBRARY

Libraries supply inmates with needed access to legal materials as well as recreational reading that can help them prepare for vocations, enlarge their social and educational backgrounds, and support facility management.

Library Activities

ISSUE: The extent of library activities must be determined to provide proper space.

RESPONSE: Both fundamental library activities and optional activities greatly influence the size of the jail library. The basic purpose of a library in any jail is to store books, periodicals, and newspapers supplied by the facility for inmate use. Other activities associated with a basic library function include keeping records of books checked out and distributing, sorting, maintaining, and shelving library items as they are returned.

Several optional library activities that might be part of the jail program also affect space and equipment needs. They include:

- maintaining a legal library collection (outside sources are also a viable method of providing inmates with access to legal materials);
- reading and studying;
- writing and preparing documents;
- displaying notices and information about library materials and activities;
- maintaining and using audiovisual equipment, including records and tapes; and
- providing reading and study carrels, with support audiovisual equipment.

Most of these optional activities operate on the basic assumption that some or all of the inmates will go to the library to browse through materials, use them in the library, and/or check them out. However, many jails maintain only sufficient space to store books and the cart with which books are delivered to inmates. In this delivery scenario, inmates identify the books they want from a list of available materials, and the staff later fills their requests.

Storage of library materials in a multi-purpose space tends to provide the jail administration greater flexibility in terms of operating the jail library in either manner.

Library Size

ISSUE: Space needs must be determined by library activities and storage requirements.

RESPONSE: The size of a library space depends primarily on the activities that occur and the types and number of books and materials stored. Regarding the *number of books*, it is recommended that small or medium-sized jails provide roughly 20 books per bed and at least one magazine and one local, state, or national newspaper per every 10 residents. The following formula applies for calculating space for book storage (stack) areas:

$$\text{total volumes} = \text{required square footage for stacks.}$$



Library stacks in a multi-purpose room provide reading area capability.

Using this **formula**, a 1,000-volume library (50 beds x 20 volumes per bed) would require approximately **62** square feet of stack area exclusive of general circulation in the larger library space.

If provided, a **reading area** should be calculated as follows:

$$15\% \text{ of capacity} \times 16 \text{ square feet} = \text{square footage.}$$

By this formula, a 50-bed facility would need to provide 120 square feet of reading area exclusive of general circulation in the library.

These formulas were created by the ACA's Committee on Institutional Libraries and are contained in its *Library Standards for Adult Correctional Institutions*.

Additional area should be considered when fixed study **carrels** and areas for audiovisual equipment are included. Another consideration is space for a **computer work station(s)**. For example, complete legal libraries are available on CD-ROM as well as via the Internet. Additionally, in facilities where a more elaborate library is required, consideration should be given to providing space for a **librarian's office**, a **work room**, a **checkout area**, and a staff **computer terminal**.

Library Environment

ISSUE: The environmental quality is important in creating the proper library setting and preserving library materials.

RESPONSE: A library space has some environmental requirements that differ from those of other functions, especially those that might be housed in a multi-purpose space. These requirements are most applicable if the library is made accessible to inmates for book selection, reading, and studying.

- Artificial light levels should preferably reach 50 to 70 footcandles at 30 inches above the floor surface.
- Humidity levels should be controlled, preferably within a range of 56 to 70%.
- Temperature should be controlled, preferably within a range of 68 to 70 degrees Fahrenheit.
- Acoustic privacy and low reverberation levels are important to maintain the integrity and function of a library area.
- Some visual privacy is important to reduce distractions, but the space should be observable from a constantly staffed post.
- The space should generally be pleasant and comfortable,

Library/ Multi-Purpose

ISSUE: The library function must be compatible with other functions that may share a multi-purpose space.

RESPONSE: The library area poses some difficulty for a multi-purpose operation because of the inflexible nature of stacking and storing books. This is further complicated if fixed equipment, such as study carrels and computer work stations, is also in the space and cannot be moved and/or contains valuable equipment that must be protected.

One way to prevent stacks from being damaged during other activities is to put lockable shutters over them. Another is to locate them at the back of the room where a moveable partition can be drawn in front of them during table tennis and other activities. Stackable chairs and folding tables in reading areas also enhance multi-purpose capabilities.

EDUCATION

Education programs frequently occur in even the smallest jails. The following detail functional-architectural issues apply to educational spaces.

ISSUE: The size of educational facilities depends on the types of programs offered and the number of participants.

RESPONSE: Even though the smallest jail can benefit from offering educational programs to inmates, it is frequently the case that few inmates show sufficient interest or stay long enough to participate in extended programs. Consequently, true need should be ascertained to determine if a

space as great as a dedicated classroom should be provided for educational programs.

Many educational programs in small or medium-sized jails consist of tutoring or GED with a teacher or volunteer working with a small number of students. For these applications, an individual counseling space or an attorney-client visiting space may be an adequate alternative to providing a dedicated space if no schedule conflicts occur. However, spaces used for tutoring or educational programs involving several inmates at one time should have marker boards, chalkboards, and/or other implements that aid in the teaching process.

Special space needs may arise depending on the nature of the educational program offered. For example, some jail educational programs involve independent study via audiovisual equipment placed in fixed study carrels. This approach to education requires space for the carrel and the equipment as well as supervision and supplemental instruction by educational staff. Such a program should not only have dedicated space for the equipment, but should be located where a direct monitoring capability is available from a constantly staffed post.

One form of educational program that is unusual for small and medium-sized jails but must be considered because of its space and equipment implications is *vocational training*. Programs involving cooking, auto repair, or other specialized activities could have a dramatic impact on space and equipment needs.

Education Space Characteristics

ISSUE: Educational spaces should be designed to complement the various activities that might take place.

RESPONSE: For education space to function effectively, some general characteristics should be attained. These apply especially to educational spaces for teaching inmates in groups rather than individually.

- **Equipment/furnishings**
 - moveable furnishings;
 - durable furnishings;
 - computer work stations;
 - TV monitors for teaching tapes or broadcasts; and
 - a range of furnishings and equipment to support the functions, such as student desks with writing surfaces versus chairs and tables, desk or podium for teachers, blackboards, screens, and clocks.
- **Environmental**
 - proper acoustic separation from noise-generating areas;
 - good ventilation and controlled temperature;
 - 50 to 70 footcandles of artificial light 30 inches above the floor surface;

- artificial light that provides options for intensity to accommodate a wide range of activities (verbal instruction, slide shows with note-taking, etc.); and
- natural light, if possible.

RECREATION

Recreation differs from indoor exercise in that recreational activities -- table tennis, crafts, painting, etc. -- are less physical and have considerably more modest square footage and volume requirements than indoor exercise.

ISSUE: Recreational activity needs must be identified to specify space requirements.

RESPONSE: Recreation may be provided in place of large-scale indoor exercise (e.g., basketball, volleyball) in certain jurisdictions. This is a fundamental decision that can affect the amount and character of space needed. If recreation is provided in lieu of indoor exercise, space and equipment requirements are quite different. However, a major opportunity for the constructive expenditure of inmate energies may be eliminated, especially in climates where outdoor exercise is not practical for long periods of time.

Recreational needs may also greatly influence the size and shape of the multi-purpose space if recreation is to take place in such an area. The dimensional requirements for an area to accommodate one or two table tennis games, for example, can greatly influence the amount of space needed.

	Area dimensions (feet)	Users
Table tennis (1 table)	23 x 13 x 9h	2-4
(2 tables)	23 x 24 x 9h	4-8
Foosball (1 table)	10 x 8	2-4

Recreational programs involving movies with screens and projectors, or VCRs and TVs, can generate equipment needs that affect not only the size of space but also its orientation and the need for supplemental storage.

Jail Industries

While jail industries are primarily viewed as a large jail or prison activity, some small and, particularly, medium-sized jails might decide to implement a jail industry program. Examples of these programs include furniture making or repair, product packaging, recycle sorting, etc. The issue of jail industries should be fully explored and evaluated during the planning process to assess the activities involved and the amount and type of spaces required.

SPACE LIST

Some of the typical spaces that might be found within the **programs/services** component as individual spaces or merged into multi-purpose applications follow.

Counseling:
individual
group

Religious:
personal counseling
services/instruction
storage

Library:
recreational/legal
- stack area
- reader area
- work area
- computer work station area
- study **carrel** area
storage

Education:
classroom
storage

Recreation:
recreation room
storage

Staff Facilities:
offices
toilet(s)
storage
closet
reception/secretary

Depending on the overall building concepts, these spaces may be organized together as a discrete **program/services** component, be spread throughout the facility, or integrated, in part, into the housing units.

RELATIONSHIPS

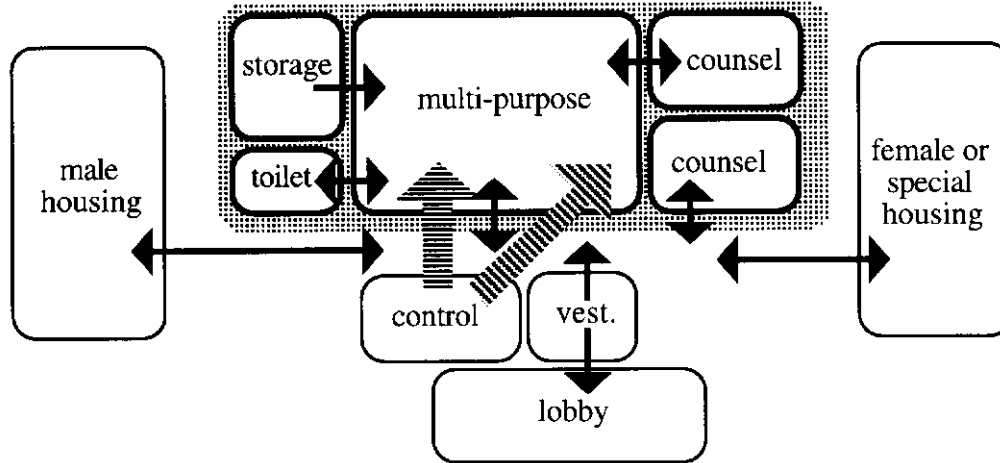

COMPONENT DIAGRAM

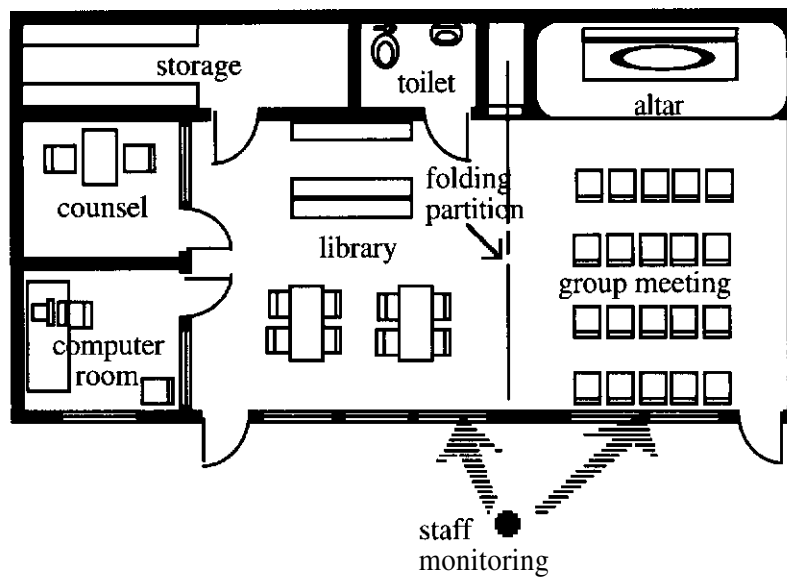

INMATE COMMISSARY

DESCRIPTION

An inmate commissary allows inmates to purchase personal items not normally supplied by the jail. Items necessary to basic hygiene (e.g., soap, toilet paper) should be provided by the facility at no cost.

The inmate commissary is generally viewed as a privilege, not necessarily a right, as long as basic sanitation and food service are adequate and not supplemented from a commissary. The trend nationwide is to provide commissary services at the jail or by using outside sources in lieu of allowing friends or family to bring items to the jail because of the potential for the introduction of contraband.

Providing inmates with an opportunity to purchase certain small items gives them some control over their lives. It also provides the jail administration with an effective management tool for controlling inmate behavior since the commissary privilege can be withdrawn for violations of institutional rules.

Commissary operations have often been troubled by problems related to loss control and fiscal accountability. However, the commissary need not be a problem as long as secure storage and proper distribution and accounting procedures are followed.

In a small or medium-sized jail, administration of the commissary operation is often assigned to either the food services staff or the inmate program staff, depending on the jail's personnel situation and management philosophy. To some degree, the decision as to *who* will manage the commissary will determine where the commissary should be located.

Sound correctional practice and many state standards require that inmates with funds on account be provided with an opportunity to purchase discretionary items not provided by the jail. It is important to check state standards or statutes with regard to commissaries since a few states prohibit the establishment of petty cash funds or other such accounts outside the usual county financial chain of control.

KEY DECISIONS

As the role of the commissary component is evaluated, the following decisions should be made since they have a fundamental effect on design requirements.

- What size and scope of operation is anticipated? Will the commissary role be more broadly defined to include storage of all basic supplies for the facility?
- Given the size and scope of the commissary operation, will the jail rely on an in-house stock of commissary goods or on a retail outlet outside the jail (i.e., local stores or shops)?

- Will commissary goods be brought to the inmates in their housing units or will the inmates, as an additional privilege, go to the commissary to pick up their goods? If the latter, will *all* inmates, including those in maximum security, be allowed to visit the commissary?
- Who will administer the commissary and, therefore, where will it be located?

DETAIL ISSUES

The following detail functional-architectural issues should be considered in the development of the commissary component.

SIZE

ISSUE: The size of the commissary will depend on the inventory, activities, and equipment involved in service delivery.

RESPONSE: The commissary of a small or medium-sized jail will typically involve a relatively small amount of square footage. However, the amount can vary significantly depending on the *inventory* involved. Inventory is affected by the:

- number of inmates served,
- range of items offered,
- amount of each item stocked,
- type of storage required (dry storage vs. cold and/or frozen).

A minimal commissary may limit its stock to cigarettes and candy. Additional items that might be considered include:

- snacks (potato chips, cookies, ice cream);
- beverages (tea, coffee, soda);
- toiletries in addition to facility issue (deodorant, soap);
- cleansing tissue, handkerchiefs;
- radios, batteries;
- greeting cards, stationery, envelopes, stamps;
- inmate clothing (underwear, socks).

Other factors affecting the size and design of the commissary relate to *activities* and *equipment*, including:

- *Efficiency* with which items are stored.
- *A refrigerator and/or freezer* for soda, ice cream, etc.
- *Work surface and seating* for staff administering the commissary. The work surface should be large enough to do paperwork on receipts, request slips, inventories, and order forms, and to count money. If the facility develops a computer-based account system, additional surface area for the keyboard and monitor will be required. A regular staff work station or post could be used if the commissary is managed by regular security staff.

- If cash is used in transactions, a place for a secured cash drawer or safe. Alternatively, a separate commissary checking account might be maintained at a local bank.
- Lockable file cabinet capacity for storage of inmate commissary accounts, financial records, ordering information, and other papers.
- If commissary items are brought to the inmates, space in which to store a mobile cart, unless a cart from the kitchen or the health care area can be borrowed.
- If commissary items are distributed at the commissary area (i.e., inmates go to the commissary), a securable pass-through window. This can be a Dutch door or opening in the wall with a counter. The counter area should be securable with a lockable overhead rolling shutter or a lockable swinging window or door.
- If inmates go to the commissary, an area for a display cabinet or shelves they can see but not touch.



Commissary pass-through window located on main jail corridor.

LOCATION

ISSUE: The location of the commissary depends on the extent of service, the delivery mode, and accessibility.

RESPONSE: If inmates go to the commissary, it should be located in an area where a waiting line does not congest a circulation corridor. It is also preferable that the area be visible from a constantly staffed post, thus eliminating the need for additional escort staff while the officer providing service is inside the commissary room.

A view of the commissary from a staff post is not necessary if the service is brought to the inmates in their housing units. In a small or medium-sized jail, the distances involved in bringing items to inmates are typically not problematic, especially if the jail is on a single floor.

If inmates go to the commissary, it may be useful to consider affiliating the commissary space with a *multi-purpose area*. In this way, staff can consolidate two activities in one movement sequence and share the view control that would normally be integrated into the design of a multi-purpose area.

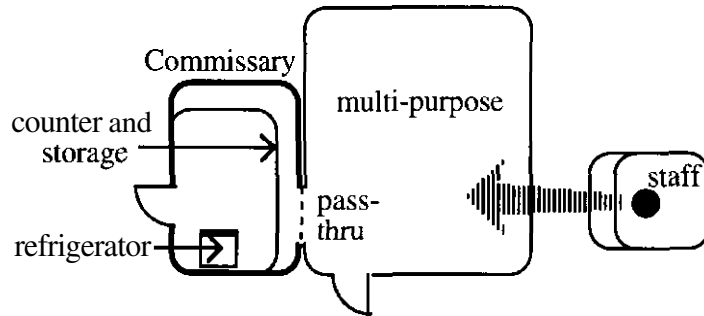

EQUIPMENT

ISSUE: Determine whether vending machines will be used to provide commissary items.

RESPONSE: Many jails have found that, with proper supervision, it is possible to permit inmates to carry small amounts of change. Therefore, it is possible to run a vending operation as part of the commissary or to locate machines in a multi-purpose room as long as they do not interfere with other functions. It is important to evaluate the vending machine issue prior to design to avoid the placement of machines in inappropriate locations (e.g., in corridors or staff areas to which inmates must then gain access).

SECURITY

ISSUE: Access to the commissary must be strictly controlled whether the commissary consists of a locked storage cabinet or a separate room.

RESPONSE: Security and inventory control should be attained by limiting access to essential staff and by maintaining strict key control. The key should be checked out from Master Control or the jail administration each time it is needed. Placing the commissary in an observable location or an area with limited access also assists in general security.

COMMUNICATION

ISSUE: Communication with Master Control is essential.

RESPONSE: As with most areas within the jail, there should be a telephone or intercom link with Master Control. This is particularly true with a centralized commissary dispensing location since the commissary officer will have to summon inmates by housing unit or other criteria.

SPACE LIST

Some of the typical spaces that might be found in the commissary component follow.

- Storage area
- Work area
- Waiting area (for centralized commissary only)

RELATIONSHIPS

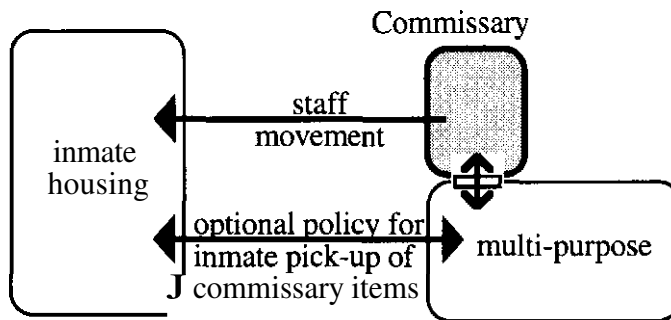

COMPONENT DIAGRAM

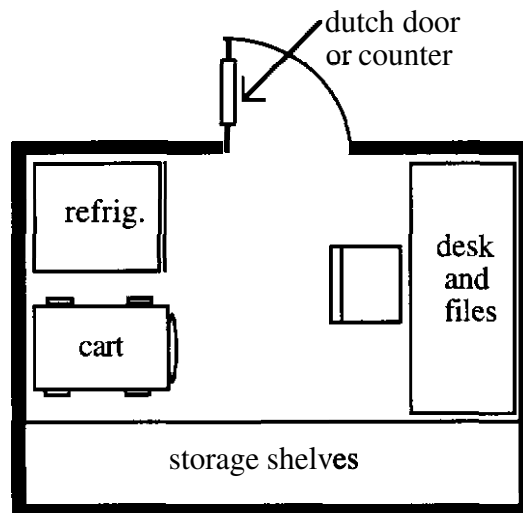

FOOD SERVICE

DESCRIPTION

Food service has a major impact on daily jail operational routines, annual operating costs, and initial construction costs. It presents many security concerns, is a regular disruption to other jail operations and supervision needs, and is a major factor affecting inmate attitudes and behavior. The quantity, quality, and means of preparing and serving food have often been at issue in inmate grievances and legal suits. In these instances, inadequate documentation of meal planning or difficulties maintaining equipment to current standards for institutional food service can become very troublesome for jail administrators.

Constructing sufficient work space and providing adequate storage area and equipment to respond to inmate dietary needs can be quite expensive, making a substantial dent in the normally limited jail construction budget. Thus careful consideration must be given to how food service will be implemented.

The food service component encompasses a variety of basic activities:

- menu planning and ordering,
- receiving and storing foods and related supplies,
- food/beverage preparation,
- food/beverage delivery,
- dining,
- cleanup and dishwashing after meals,
- disposal of waste, and
- record keeping.

The current direction in the design of food service areas in small and medium-sized jails is to focus on providing quality facilities that minimize the time of food preparation, enhance the ease of delivery without compromising food quality, and accommodate future capacity needs without requiring later expansion of food service areas. The character of the food service area and the materials and finishes used are similar to those used in conventional institutional kitchens, with the exception that perimeter and internal security must be provided.

ACA standards focus primarily on policies, procedures, and documentation of an inmate food service operation. Besides requiring three meals per day, these standards are aimed primarily toward ensuring the dietary and hygienic adequacy of a jail food service operation. They do not attempt to dictate specifically how that service is to be provided.

State and local food service requirements should be checked carefully. Most states have health department and sanitation codes regarding the preparation and handling of food and the disposal of food waste products. These state and local requirements define a minimum operational level that must be

met at all local food service facilities. Most state jail standards also address requirements for jail food service.

KEY DECISIONS

As the role of the food service component is evaluated, the following decisions should be made since they have a fundamental effect on design requirements.

- Will food be prepared at the jail or be provided by outside sources such as local schools or hospitals? Or, will "easy" meals like breakfast cereal be prepared at the jail and lunch and dinner come from an outside source?
- If meals are provided by an outside source, what facilities and equipment will be required at the jail to serve the meals? Will the meals have to be re-heated in a re-heat kitchen? Will meals arrive in bulk or already on trays?
- Will inmate dining occur at a central dining space or within the housing units? If at central dining, will all inmates, regardless of classification, use the facilities? If at the housing units, what method of food delivery will be used to ensure that proper food temperatures and quality are maintained?
- How frequently will food supplies be ordered, and what effect does this have on storage needs?
- Will minimum-security inmate workers be available to assist in food service operations and, if so, to what extent?
- How will food service facilities be designed to accommodate future expanded inmate capacities?

DETAIL ISSUES

The following detail functional-architectural issues should be considered in the development of the food services component.

FOOD SERVICE PROVIDER

ISSUE: A choice must be made between providing food services in-house or contracting for them from outside sources.

RESPONSE: Some jails use an *outside food service source*. This can be done through a private food service company or restaurant or a nearby institution, such as a hospital, nursing home, or school. Although this method poses several potential problems, comparing long-term costs and evaluating operational concerns could prove worthwhile.

The primary *advantages* of using outside sources could include:

- eliminating floor area required for kitchen and food storage from construction costs,

- eliminating food service equipment from **initial** project costs,
- **di** overall **mechanical and electrical load requirements** of the building,
- simplifying operational purchasing and maintenance needs,
- eliminating costs for **cooking** staff,
- eliminating periodic costs for repair or replacement of obsolete kitchen equipment,
- eliminating kitchen cutlery from the secure jail area.

Some potential *disadvantages* of using outside sources include:

- attempts to conceal contraband in food trays and carts brought to the **jail**;
- increased security staff time involving movement of food into and out of the jail security perimeter;
- possible inability to add efficient kitchen space to the building if the contracting service must be abandoned;
- lack of control over escalating contract costs;
- potential operational difficulties if the contract service temporarily shuts down (e.g., schools during summer vacation, facilities during renovations);
- possible need for some backup cooking, **warm-up**, or delivery equipment.

In an ideal situation, the outside food service source would provide the following items to reduce staff work and facility space needs:

- meals that are pre-plated in disposable or reusable insulated trays with meal temperature adequately maintained in transit,
- cups and utensils that are either disposable or returned to the provider for cleaning,
- beverages in insulated containers that can be used for dispensing and returned to the provider for cleaning,
- delivery carts.

If any or all of these elements are missing, they must be provided and accommodated at the jail. This could imply the need for a fairly significant amount of space and equipment, though still not as much as a full kitchen with full storage capabilities.

It is also important that a secure method of receiving the food from an outside provider be created. This point of entry should be configured and operate as a *security vestibule* since it represents a penetration of the security perimeter of the jail.

In-House Food Service

If food services are to be provided in-house, the primary operational concerns would focus on the potential use of inmate workers and, therefore, whether food service staff would have security responsibilities in addition to meal preparation and cleanup.

Kitchen activities require cutlery and other equipment that could become weapons. Where inmate workers will assist in food preparation and cleanup, special precautions for food delivery, trash removal, inventory control, and the location of inmate worker housing must be considered. Also, when inmate workers are used, there is the question of whether food service staff must be trained for supervising inmates or if intermittent or electronic monitoring by other jail staff is required.

Other tasks associated with food services include menu planning, food purchasing, and maintaining food service records. The design considerations for these tasks are discussed in the functional issues to follow.

LOCATION OF INMATE DINING

ISSUE: The location of inmate dining and the method of food delivery must be established.

Centralized Dining

RESPONSE: A centralized dining area has the potential advantage of using a serving line and dining space adjacent to the kitchen. This location eliminates the need for tray assembly time and food carts, provides the quickest delivery of hot foods, and simplifies cleanup.

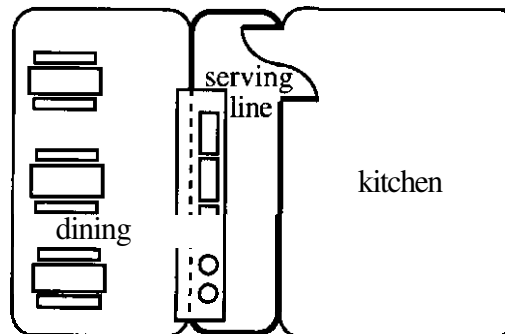

Unfortunately, this method of dining creates a number of major operational problems for the small or medium-sized jail. Maintaining the separation of different housing classifications during meal time can prolong food service times even for small jails with limited capacity. If central dining takes place in a general multi-purpose room, the time needed for food service and cleanup would likely eliminate most other activity uses. Moving groups of inmates to and from dining three times a day substantially increases staff monitoring responsibilities and could require more supervisory personnel. Inmate movement to and from dining would severely restrict other jail activities for prolonged periods of time. Consequently, central dining in a multi-purpose room is generally discouraged, especially when sanitation issues are also considered.

Dayroom (Decentralized) Dining

Decentralized dining, which involves moving prepared food trays in carts to the various housing pods, is the most common method of inmate dining. Inmates eat at dayroom tables and are monitored by the housing area security staff. This tends to facilitate dining with minimal movement and security problems.

Two classic problems with dining at the housing units have been 1) insufficient space for rapidly and effectively distributing meals, including drinks, and 2) maintaining proper food temperature. One response to these problems is to complete the traying process in the housing units. As an example, bulk food containers are set up in each housing unit or general housing area for final traying, in some cases employing a cafeteria-style serving line. In some instances, microwave heating units located in each housing unit or in the general housing area are used to re-heat entrees to an optimal temperature. These food service methods usually require **direct** staff supervision and are rarely attempted in smaller jails because of the modest capacity of each housing unit, the intensive use of staff time required to facilitate serving, and the minimal travel distances (and thus cooling time) involved with a small or medium-sized jail, particularly when it is a single level.

With the conventional approach of preparing food trays at the food service area and delivering them to the inmate housing units, the following considerations apply:

- provide sufficient surface area or traying equipment (like assembly lines) to allow rapid traying and preparation for insulated delivery;
- provide storage for carts used in delivery;
- coordinate the food tray size with the size of food pass-throughs used to serve inmates when they must eat in their cells (e.g., disciplinary detention);
- provide food pass-throughs into the **dayrooms** to allow serving the meal in higher security units without opening the door;
- provide a means to distribute beverages effectively (i.e., fill cups and distribute through a food pass or place a large beverage dispenser in the housing unit for inmates to serve themselves);
- provide a means by which to count, distribute, collect, and recount utensils, trays, and cups; and
- provide a means by which to collect waste (everything returned on a tray, or a waste can in housing units for later collection).

FOOD PREPARATION AND STORAGE ISSUE: Food preparation and storage area size and layout should be adequate to allow the efficient preparation and assembly of meals.

RESPONSE: The sizes of the food preparation and storage areas are influenced by five primary factors:

- types of meals prepared;
- storage capacity,
- **flow/efficiency,**

- tray assembly approach, and
- expansion capabilities.

Size is determined as much by the type of food to be prepared as by the number of meals to be served. Buying bulk commodities and fresh produce increases the storage requirements for a kitchen and frequently requires more equipment (e.g., slicers, vegetable shredders, bread ovens, refrigerators). Retaining the services of a dietitian and a food service consultant during the facility planning stages can assist in developing and coordinating menus with food purchasing options and required food preparation equipment.

The design of the kitchen should emphasize efficient production and assembly of food from storage to preparation, cooking, and serving. This **production flow** for food preparation should be reflected in the design layout and should minimize cross traffic patterns for maximum efficiency.

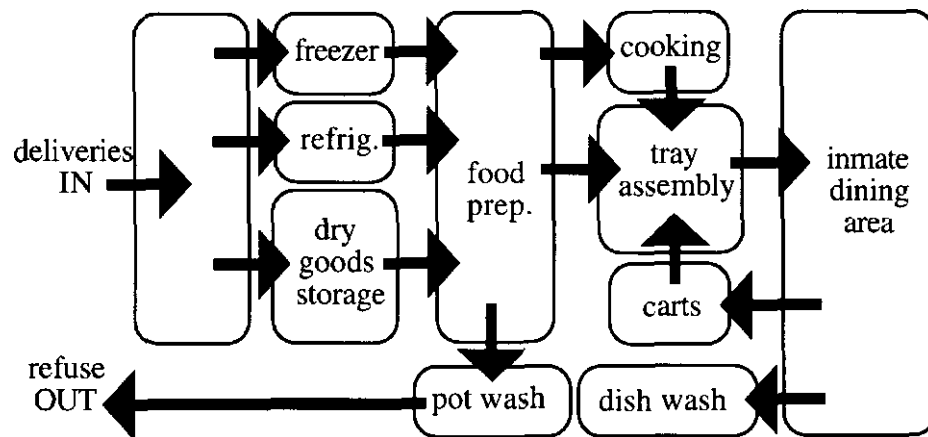

Special consideration should be given to convenient tray assembly procedures, a typical problem in many jail kitchens. Ample work surfaces on which to place the trays prior to placement on a cart, or the provision of a small conveyor belt assembly line for rapid traying and immediate placement on a cart, are practical solutions to this problem. It should be noted, however, that tray assembly systems sometimes require numbers of inmate workers or staff that may not be available in a small or even medium-sized jail.

Deciding the size of the kitchen should also include consideration of future expansion of bed capacity. While kitchen spaces can be located along an exterior wall to allow expansion, this is sometimes an impractical alternative given frequently limited growth needs and the disruption to existing equipment and functional space arrangements that must operate during renovation (preparation areas, cooking areas, traying areas, dish wash areas, etc.). Over-sizing the kitchen and storage areas for a future expanded capacity usually requires only a modest increase in floor area and provides the operators with welcome initial flexibility in storage and work areas.

In determining the size of the food service area, consideration should be given to providing meals to other facilities (e.g., local juvenile detention and detox facilities). Some jurisdictions have consolidated food service areas of one or more facilities in the new jail. Cost savings are realized by eliminating duplication of facilities, equipment, maintenance, and cooking staff and by reducing food purchase costs by buying larger quantities.

CLEANUP/ WASTE HANDLING

ISSUE: Adequate provisions must be made for cleanup and waste handling.

RESPONSE: Most health department regulations require institutional kitchens to provide specific wash and rinse water temperatures. These criteria are best met by institutional dishwashing machines. A professional food service equipment consultant can assist in selecting an adequately sized washer and coordinating related needs for hot water boosters, grease traps, etc.

The need to wash pots, pans, and cutlery used in food preparation is similar to that in kitchens in other facilities and should be accommodated accordingly. Other cleaning needs can vary widely, depending largely on whether disposable or reusable items are used. For reusable items, special cleaning equipment (e.g., special racks, deep sinks) may be required because of the special character of insulated plastic trays, plastic or metal cups, large insulated beverage dispensers, etc.

Adequate *storage* area for trays, utensils, food carts, and other reusable items should be readily available near the cleanup area and the food preparation area.

Waste handling considerations include:

- gathering waste from kitchen and dining areas;
- sorting out items for recycling;
- disposing of food waste;
- disposing of boxes, cartons, cans, drums;
- calculating the frequency and volume of trash removal (perhaps integrated with trash removal for all facility waste -- paper, supplies, etc.);
- providing a trash compactor, as appropriate; and
- temporarily storing trash until removal can be securely and conveniently executed, which may involve a separate space or area to contain offensive odors and maintain the sanitation of the food service area and/or a waste refrigerator for meat, fat, and fish scraps.

FOOD DELIVERY

ISSUE: The need to accommodate periodic food deliveries and use inmates to transfer these supplies to storage areas can create a weak point in the jail security perimeter.

RESPONSE: The jail should have a delivery area that functions like a *security vestibule*. Controlled by Master Control, food deliveries are unloaded into this room. Before the delivery person leaves, the food service staff verify the contents of the delivery, weigh items sold by weight, test the temperature of frozen and chilled items, and check containers for damage and contamination. When the exterior door is secured, food service staff coordinate the transfer of foodstuffs to storage areas by inmate workers.

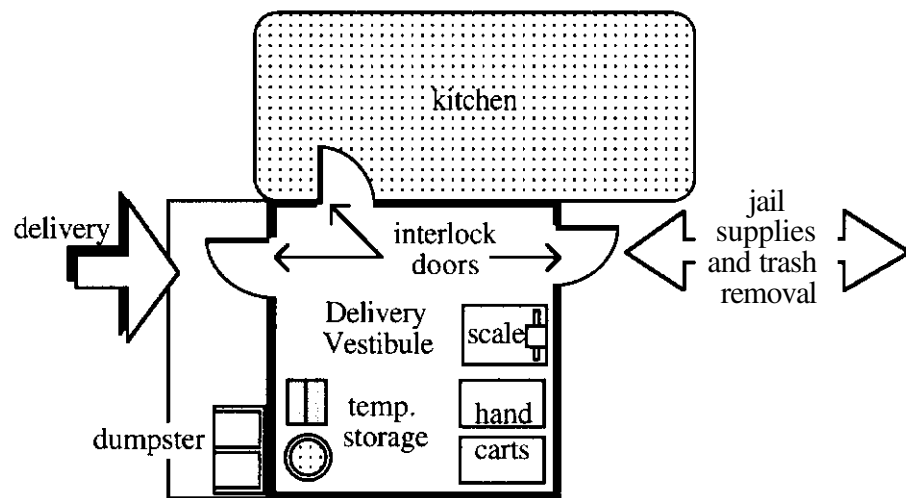

In sizing and designing the delivery vestibule, the following issues should be considered:

- the method of delivery to determine if a raised dock or lift is required,
- temporary storage requirements during delivery,
- the need to store handtrucks and pallets, and
- the type and size of access door(s) needed (overhead, double swinging, etc.).

It is preferable that the delivery vestibule be *separate from the vehicle sally port* used for arrestee intake and release so that the security and availability of that vital area are not compromised.

STAFF ACCOMMODATIONS

ISSUE: The needs of food service staff should be accommodated.

RESPONSE: The food service director (or chief cook) should have a work area at which to prepare menus, document meals served, and do other paperwork. This area may or may not take the form of an enclosed office space but should, at a minimum, have a work surface; **chair**; lockable file storage; telephone; computer terminal (if food service or jail management software is used); and shelving for cookbooks, reference sources, manuals, and catalogs.

Food service staff should be provided with a locker area for clothing and valuables, and toilet facilities adjacent to the food service area. Separate toilet facilities can also be provided for inmate workers.

Storage space, accessible to the food service director, should be provided for plastic gloves, hairnets, and other special articles of clothing used by food preparers.

SECURITY

ISSUE: Security precautions must be taken if inmates work in the kitchen.

RESPONSE: Cutlery should be regularly inventoried and stored in a lockable cabinet or closet with the key securely retained by the food service director and shift commanders. To avoid inmate workers being pressured by other inmates to smuggle contraband from the kitchen, most jails provide them with a separate housing unit, which is strongly recommended. Some jails totally separate that unit from the other housing areas, though care must be taken not to sacrifice necessary surveillance by doing so. (See the functional-architectural component on "Special Housing" and the section on "Classification/Separation" in Chapter 3 for more on inmate worker housing and separation issues.)

General security precautions for the kitchen area should include alarm and/or audio monitoring, and possibly CCTV monitoring, from Master Control and/or vision panels at main corridors to allow staff observation. Kitchen staff should be able to easily summon assistance via portable radio, personal alarm, or panic button.

The food preparation and cleanup areas should be visible from the food service director's work area/office, if possible. Also, the arrangement of counters and equipment should minimally obscure the food service director's and/or the security staff's view, depending on who has the principal responsibility for directly monitoring food service area activities.

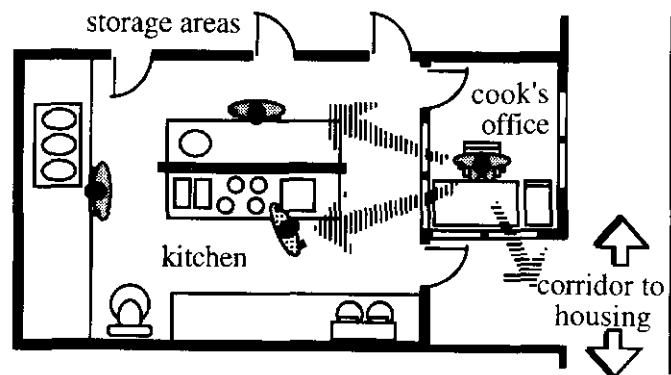

INMATE WORKERS/ STAFF DINING

ISSUE: Staff and inmate dining may need to be accommodated as part of the food service component.

RESPONSE: When centralized dining is not provided, inmate workers can return to their housing unit to eat. However, it may be more convenient to provide a small dining area for them, as well as for food service staff, as part of the food service component.

Options for providing this capability are:

- creating an adjacent, enclosed dining room; or
- creating an alcove or open area immediately adjacent to the food service area.

Creating an enclosed area has the benefit of securely containing the inmates, separating them from food service equipment, and providing more sanitary conditions. Depending on its location, however, it may place them in a less supervisable setting and require more space than the other option.

If a formal breakroom is not provided for jail staff dining, the same dining area used by inmate workers and food service staff may be used by staff.

SPACE LIST

Some of the typical spaces that might be found within the food service component follow.

- Delivery vestibule
- Food storage
 - dry
 - refrigerated
 - frozen
- Food preparation
- Tray assembly
- Cook's work area/office
- Cart storage
- Cleanup (pot wash, dish wash)
- Central dining
- Inmate worker/staff dining
- Staff locker area
- Staff toilet*
- Inmate worker toilet
- Waste disposal
- Temporary garbage retention.

* See local codes and the ADA regarding handicapped accessibility requirements.

RELATIONSHIPS

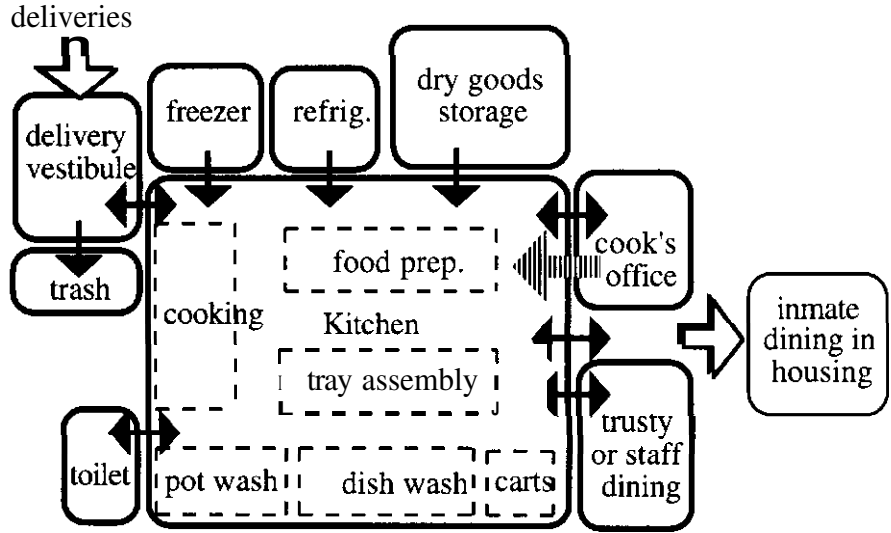

COMPONENT DIAGRAM

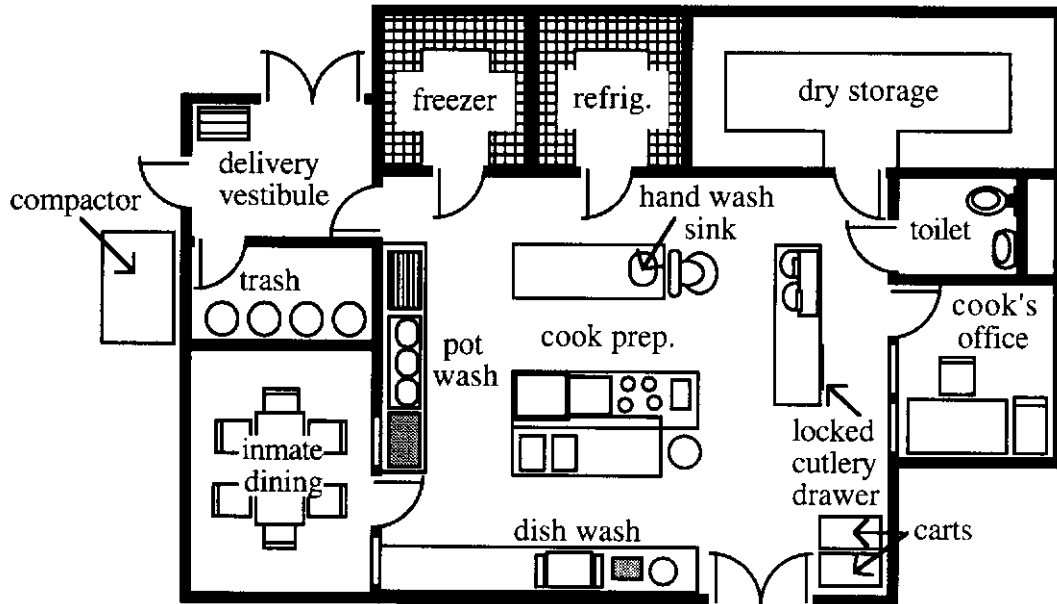

LAUNDRY AREA

DESCRIPTION

The jail laundry should be adequate in size and equipment for the laundering of bedding, linen, towels, and clothing on a scheduled basis consistent with standards and good correctional practice. In addition, the laundry should provide for cleaning soiled clothes removed from arrestees at intake.

Laundry facilities in many small and medium-sized jails tend to be staffed by inmate workers responsible for all clothing, linen, and bedding used in the system. The work flow typically follows this pattern: collection, sorting, washing, drying, folding, mending, storage, and distribution.

In older small and medium-sized jails, laundry areas were quite modest, located in such areas as basements, corridors, and the sheriff's residence. The areas provided little room in which to work and were rarely adjacent to key areas, such as the intake-release area, or readily observable by jail security staff. Laundry services were provided relatively infrequently.

In newer facilities the trend seems to be toward creating easily accessible, dedicated laundry spaces that are used more frequently to upgrade general hygiene within the jail. Commercial equipment tends to be preferred over residential equipment because of its larger capacity and longer life.

KEY DECISIONS

As the role of the laundry services component is evaluated, the following decisions should be made since they have a fundamental effect on design requirements.

- What range of items will be laundered, and how frequently?
- Will laundry services be provided in-house or by outside sources?
- Will inmates assist in laundry operations and, if so, to what extent?
- How many hours a week will the laundry operate?
- Will any inmate classifications be responsible for laundering some or all of their own clothing and linens (e.g., work releasees)? Will this take place in a separate laundry area?

DETAIL ISSUES

The following detail functional-architectural issues should be considered in the development of the laundry component. Linen and clothing storage issues are addressed in the "Intake-Release" component in this chapter.

LAUNDRY PROVIDER

ISSUE: A choice must be made between providing laundry services in-house or contracting with outside sources.

RESPONSE: Contracting for laundry services will result in a limited reduction in construction and project costs. The main advantage seems to

be reduced long-term maintenance and operational problems. To determine the best course, a local jurisdiction needs to compare the savings to the annual costs of outside service; the possible need for extra clothing, linens, and storage capacity (potentially due to less frequent deliveries and less adaptability to unusual situations); and the possible introduction of contraband.

Inmate workers are commonly assigned to provide laundry service to minimize the cost and to help justify providing it in-house (beyond citing the obvious convenience and control it provides). However, the use of inmate workers has not been without problems. The problems experienced have included their using inappropriate amounts of detergent or bleach, the need for premature replacement of laundry equipment and clothing due to misuse or vandalism, and difficulties in monitoring and supervising small groups of inmate workers.

Another consideration is the likelihood of the small or medium-sized jail consistently having enough inmates who can be classified for worker status. Inmate populations can vary widely, and there may be times when no inmate could be safely classified for these duties. These problems, when combined, may suggest that a catered service makes sense, especially if the jail can be assured that adequate clean clothing and linens will always be on hand and will be delivered in a secure fashion.

**SECURITY1
LOCATION**

ISSUE: The laundry must be located to assure adequate security and appropriate access.

RESPONSE: When inmate workers help with laundry services, the laundry must be within the security envelope of the jail, which is advisable in any case. Because the noise and residual moisture of a laundry operation can hamper the use of electronic monitoring devices, it is important to locate



Good observability from a remote staff post.

the laundry so that observation of the area can be maintained from a constantly staffed post or at least from outside the space by a passing officer. Additionally, blind spots in the arrangement of the equipment should be minimized or eliminated to facilitate remote observation. Two-way intercoms should be provided in the space for communication between staff and inmate workers.

Ideally, the laundry location should be:

- adjacent to the admission area of intake-release;
- adjacent to storage areas for street clothing, clean clothing, and linens and blankets;
- easily accessible from the housing units; and
- near or adjacent to inmate worker housing.

SIZE

ISSUE: The size and complexity of the laundry component depend on the frequency of cleaning and the variety of laundry services offered.

RESPONSE: A primary determinant of overall laundry area needs is the frequency with which items are cleaned. Most professional standards recommend a minimal exchange of clean clothing, linen, and bedding once each week. This minimum is exceeded by many facilities, especially for clothing and towel service. Frequent laundry service can help achieve the goal of good inmate hygiene and facility cleanliness.

Not all facilities launder *street clothing* removed from inmates during intake processing although it can present odor, mildew, and parasite problems. Spray disinfectants may partially solve these problems, but laundering is a preferable and effective solution and its impact on equipment and space needs should be considered.

Other laundry activities that can affect space and equipment needs include:

- dry cleaning;
- garment repair or mending;
- ironing or pressing;
- kitchen towel laundering;
- special laundering (e.g., heavily soiled work uniforms from vocational training or work programs);
- work release laundering;
- female personal laundering.

To prevent contraband passage, *separate work release laundry facilities* should be considered. These additional facilities preferably would be part of the work release housing unit and directly accessible to the inmates. It is desirable to place the equipment in a separate room where moisture and sound can be better contained. The space should have good ventilation, a floor drain, and be observable by staff from a remote point.

If work release inmates are not permitted to wear personal clothing within the security envelope, a laundry outside the security envelope should be considered for the laundering of personal clothing they wear to work. This laundry may contain coin-operated washers, dryers, and vending machines for soap and fabric softener. It should be located within the facility near the work release entrance and observable by staff from a remote point.

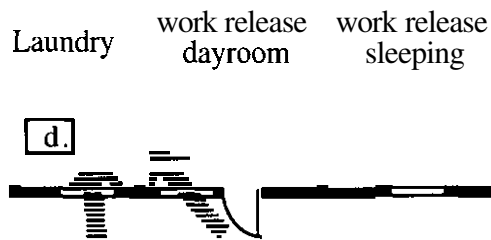

ISSUE: The sizes and types of washers and dryers depend on the amount and type of laundering to be done and the number of hours the laundry will operate.

RESPONSE: Many facilities have found residential or lightweight commercial machines to be inadequate and insufficiently durable to handle the variety and amount of laundering required. The daily use of this equipment and the frequent need to wash heavy loads such as blankets and shoes generally recommend the use of heavy-duty, commercial-grade laundry equipment. To identify actual equipment needs, an estimate of the amount of laundry to be processed *each hour by weight* must be calculated.

First, the weight of laundry to be done for each inmate per week is calculated. This is done by identifying each article issued to an inmate, its weight, and the frequency it will be laundered in a week. Items issued to inmates may include uniforms, underclothes, socks, bed linens, towels, wash cloths, coats, and shoes. The weight of each item can be determined by simply weighing a typical item on a scale.

The weekly laundry poundage to be done for each inmate is multiplied by the projected jail bed capacity or *peak population* estimate to determine the facility's entire weekly laundry needs. The weekly laundry poundage is then adjusted to account for the fact that washers are not typically loaded to capacity. Generally, they work best at 75% of their rated capacity.

The adjusted weekly laundry poundage is then divided by the number of *hours a week* the laundry will operate to determine the amount of laundry to be processed each hour. Assume that one load of laundry can be completed per hour by inmate workers. Generally, the more hours the laundry operates, the smaller the size of equipment needed.

Washing Capacity Formula

$$\frac{\text{lbs./inmate} \times \text{laundered/week} \times \text{peak population}}{\text{hours/week of operation} \times 75\% \text{ efficiency}} = \text{pounds of washing capacity needed}$$

Example:

$$\frac{10 \text{ lbs./inmate} \times 3 \text{ laundered/week} \times 50}{40 \text{ hrs./week of operation} \times 75\% \text{ efficiency}} = 50 \text{ lb. washing capacity}$$

After the amount of laundry to be processed each hour is determined, the equipment can be selected. When choosing equipment, select at least *two sets* of washers and dryers to permit laundering different types of articles at the same time and to provide at least one working washer or dryer if one breaks down. The combined capacity of the washers should exceed the hourly capacity needs, and the dryers should have a capacity slightly larger than the washers to account for moisture in the laundry articles.

If the number of items laundered *and/or* the frequency of laundering changes, a factor must be applied to the formula to account for the change.

The future *expansion* of bed capacity should also be considered in planning. Expansion can be accommodated by either over-sizing equipment, providing space and plumbing for additional equipment, or increasing the number of hours of operation. Corridor and doorway widths should be coordinated to allow passage of repaired or replacement equipment.

WORK/STORAGE

ISSUE: Adequate area must be provided for washers, dryers, work space, and supply storage.

RESPONSE: In addition to washing and drying equipment, space may be required for:

- dry cleaning,
- folding tables,
- laundry carts (separate carts or compartments for soiled and clean laundry),
- laundry tubs (pre-soak),
- supply storage,
- ironing or pressing,
- mending,
- laundry scale, and
- temporary storage of clean linen and clothing until it can be moved to appropriate separate areas.

It may also be wise to consider providing *automatic chemical dispensing equipment* if inmates work in the laundry. This equipment helps eliminate the problem of their using inappropriate amounts of detergent,

fabric softeners, or bleach. Although this equipment requires additional expense, it may be worth it.



Space for folding, a work surface, and room for miscellaneous equipment can be a significant part of a laundry.

CHARACTERISTICS

ISSUE: The laundry area should have special design characteristics appropriate to its needs.

RESPONSE: Some special design characteristics to consider follow.

- an excellent ventilation system that exhausts moisture and excessive heat directly to the outside;
- adequate floor drains;
- trough to accommodate discharge of water from washers;
- janitor's floor sink for mopping up spills;
- non-slip floor surfaces;
- fire detection, suppression, and evacuation systems;
- moisture-resistant surfaces;
- small desk;
- water fountain; and
- inmate worker toilet and sink.

SPACE LIST

Some of the typical spaces that might be found with the laundry component include:

- Main laundry room
 - cart staging area
 - sorting area
 - washing machines

- dryers
 - folding tables
- Supply storage closet
 Inmate worker toilet room
 Laundry at work release
 Laundry at female housing.

Basic laundry spaces are typically closely affiliated with the intake-release area.

RELATIONSHIPS

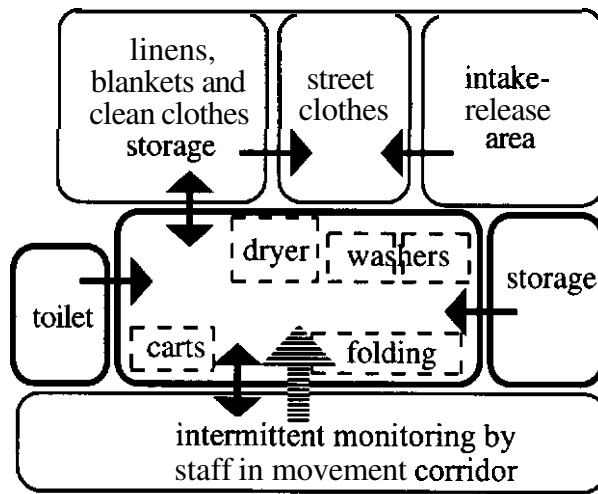

COMPONENT DIAGRAM

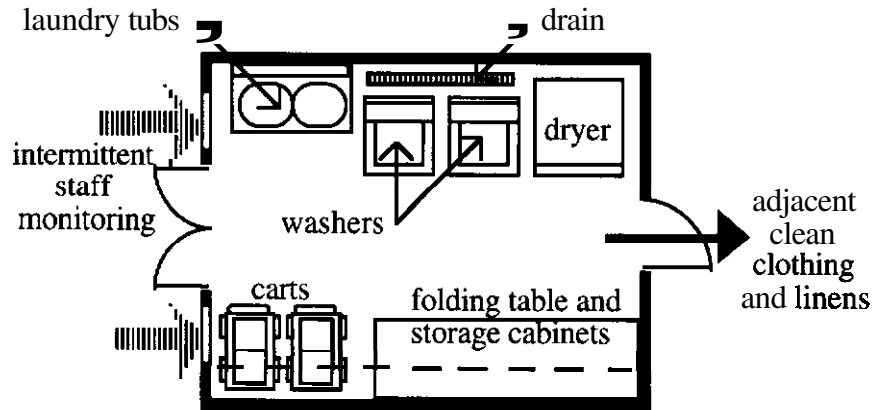

ADMINISTRATION/PUBLIC

DESCRIPTION

The administration and public reception areas of the jail are essential to the organization and management of daily business. They are also essential to accommodate the public's need for access to the facility and to information about inmates and other aspects of the jail operation. Among the many activities performed in this area are:

- Establishing and ensuring the execution of operational and security policies and procedures.
- Managing the business affairs of the jail, including general accounting, ordering supplies and goods, and managing inmate and bond monies.
- Maintaining essential records, with the possible exception of medical records.
- Receiving and distributing monies, mail, packages, and clothing for inmates.
- Conducting inventories of all facility supplies and equipment.
- Maintaining security and restraint equipment unless it is located elsewhere in the facility.
- Managing personnel, including the organization of training, daily briefings, and incidental meetings.
- Dealing with the public in person and by mail and telephone
- Accommodating outside groups for tours and presentations.
- Responding to requests for information and reports from county commissioners and other officials.
- Meeting with local media personnel.
- Storing miscellaneous supplies related to administrative functions.
- Confering with other criminal justice system officials.

Work spaces for administrative staff, for records, and for meeting with the public have usually been severely lacking in older small and medium-sized jails. In some jails, administrative office areas were created out of corridor space or niches in basement areas. Record storage was sometimes accommodated by using a much-needed cell. The public frequently penetrated the security perimeter to reach law enforcement dispatch or jail office areas responsible for public reception.

With the increased emphasis on professional jail administration and accommodating public contact, administration and public areas are receiving more attention in the development of new small and medium-sized jails. However, the adequacy of **administrative/public** space is still a problem and is not getting the attention it deserves during planning and design. This deficiency may result from oversights by the planning team or from an inclination to reduce administration and staff areas when building budgets are limited.

Many diverse spaces are associated with the **administration/public** component and typically include:

- public lobby and related spaces (public toilets);
- **public reception area;**
- administrative staff offices;
- conference and meeting areas;
- clerical areas, including records and work areas;
- security equipment storage space (unless otherwise accommodated);
- general supply storage space;
- staff toilets; and
- janitor's closet.

KEY DECISIONS

As the role of the **administration/public** component is evaluated, the following decisions should be made since they have a fundamental effect on design requirements.

- Will jail administration, clerical, and public reception functions be merged with those of law enforcement? What areas will they share, **e.g.**, a common lobby?
- How and by **whom** will public reception and outside telephone calls be handled during normal office hours? After office hours?
- How will mail, packages, clothing, and other items be received and managed?
- Will the administration area be within the main security perimeter of the jail? If so, will the public enter the security perimeter to see jail administrative staff?
- Will offices for program and **service** staff be located in the administration area?

DETAIL ISSUES

The following issues should be considered in the development of the **administration/public** component.

**LOCATION1
ARRANGEMENT**

ISSUE: The administration component should be accessible to both the public and the inmate-occupied areas of the jail without creating security conflicts.

RESPONSE: Administrative staff deal with the public, salespeople, media, and other official visitors on a daily basis. Therefore, access to the administration area must be convenient and as direct as possible. This essentially requires that administration and public areas be *adjacent*.

It is also important that the lobby area be adjacent to the visiting area or the access point to visiting. This is necessary for immediate post-arrest contacts between inmates and family members, friends, attorneys, and bondspersons. This visiting access must be provided 24 hours a day, 7 days a week.

Public access to administration areas should be controlled for the protection of staff and the safeguard of confidential records and security equipment in the area. Such control can be attained by:

- creating a security door between the public and administration areas,
- providing protected reception counters or areas,
- if an open reception counter is used, providing a means by which it can be secured after office hours and transferring reception responsibilities to a secure space such as Master Control.

**Separate
Administration
from Perimeter**

Since the public should not have access to the jail security perimeter, a good way to provide both proper location and security is to *locate the administration area outside the main security perimeter but adjacent to it*. The need for this separation becomes more important if jail administrative functions (clerical, records, etc.) are merged with law enforcement functions, since law enforcement personnel should generally be separated from inmate areas.

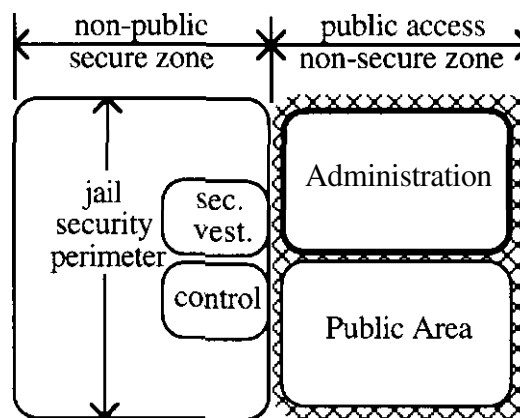

Although separating administrative areas from the security perimeter is a good principle, it may pose a logistical problem for the jail administrator

whose frequent presence within the jail is required. The administrator may be integrally involved in the provision of staff supervision or even security and services to inmates because of staff limitations.

Placement of the jail administrator's office outside the security perimeter could cause considerable inconvenience to the jail administrator who must perform line-officer duties. The following concepts should be considered to address this problem.

- The jail administrator's office might be located just inside the inmate-occupied part of the perimeter and adjacent to the clerical areas of the facility located outside the perimeter. A secure pass-through between the two areas would allow the jail administrator and clerical staff to transfer documents without continuously having to walk through a security vestibule at the perimeter.
- The jail administrator's office might be situated just outside the primary jail security perimeter and a secondary desk or work area, with file storage, within the perimeter.

The approach taken to this problem depends totally on the frequency of public contact with the jail administrator, the jail administrator's need for direct contact with clerical staff and access to records, and the degree to which the jail administrator performs fundamental security tasks.

ISSUE: The administration area should be linked with other functional components with which it frequently interacts.

RESPONSE:

- It is desirable to locate the *staff areas* and the administration areas adjacent to each other:
 - for convenience related to staff briefings;
 - for enhanced management of staff activities;
 - because of a common need to be in an area secured from the public, yet outside the main security perimeter of the jail; and
 - for sharing of spaces, such as multi-purpose and conference rooms.
- All jails, regardless of size, could use a small meeting or conference space in the administration area to accommodate meetings with the public. Such a space might also be used by law enforcement personnel and as a work area for media representatives, volunteers, or job applicants.
- Administration areas, particularly the records area, should be as accessible as possible to *Master Control/dispatch* and the *intake-release' areas* for the convenient transfer of records. This

is especially true in cases where computerized data systems are not in use and "hard-copy" records must be transferred. Unless so located, jail staff will be forced to deliver files to intake/release at inopportune times or maintain active records there as opposed to in a central records location.

- Administrative staff should be able to enter their area quickly and directly from their parking areas. Access can be gained through the public lobby or, preferably, through a separate staff entrance.
- Direct access from the outside into individual administrative offices, such as the administrator's office, is discouraged because of the additional security and surveillance problems it poses. It should be recognized that acts of violence may be directed toward administrative staff. As a rule, the number of openings into any perimeter should be minimized.
- Administrative and public areas should be located so they can be expanded as facility operations grow, or surplus offices and space in which to grow should be provided.

LOBBY/RECEPTION

ISSUE: A lobby and reception area should be provided to properly and effectively accommodate public contact.

RESPONSE: The public lobby is the primary point of contact for all public and official visitors to the jail. The impression left by the lobby and reception experience will greatly influence the image of the jail within the community and the reaction of visitors to jail staff.

The following characteristics should be considered in developing the lobby and reception areas.

- The lobby area should be sized to provide at least 15 square feet per person expected to use the area at one time. A more generous allocation of space is encouraged to enhance public use and impressions of the area.

In evaluating the number of users in the lobby area, it is important to determine whether the lobby will be used only for inmate-visitor waiting, or whether it must also accommodate visitors waiting for general business, law enforcement, or other criminal justice functions associated with the jail. Allowances might also be made for large groups arriving for jail tours or presentations about jail activities, such as county commissioners, citizen committees, and grand juries.

- Acoustic treatment should be provided to improve the quality of the space, especially when large groups with children are in the area.

Additionally, sound separation between the lobby and adjacent jail administration and jail security areas is important.

- The lobby space should be pleasant and comfortable, with natural light if possible.



A comfortably sized, attractive, and functional lobby.

- The reception area should be readily accessible and visible to the visitor. It is advantageous for the visitor to be able to establish eye contact with the reception staff immediately upon entering the jail.
- View conflicts between the lobby area and the jail perimeter should be avoided while still providing direct eye contact between the reception staff and the visitor. Frequently visitors are **able** to see through a reception point into the interior of the jail -- sometimes into sensitive areas like **booking** or holding cells.
- To facilitate public contact, personnel **working** in the reception area need to be able to communicate with all staff in their offices or posts throughout the jail. This allows quick response to public needs that can be filled only by other staff in the jail.

Around-the-clock Reception

ISSUE: A method of accommodating public contact 24 hours a day, 7 days a week must be established.

RESPONSE: The public will need to have contact with the jail 24 hours a day, 7 days a week. Such contact might be made by inmate family members, bondspersons, attorneys, and others who need communication outside

of a 9-to-5, Monday through Friday schedule. Consequently, it is important to **determine** who will do reception duties for the facility at all hours of the day and during the weekends. The basic options include:

- a full-time receptionist;
- all reception done by Master Control;
- all reception done by a law enforcement dispatcher;
- weekday reception done by a receptionist or clerical staff, with night-time and weekend reception done by Master Control **and/or** dispatch.

Visitation presents the potential for high emotions and security problems. During visitation, any non-security personnel at the reception post should have assistance from a deputy or security officer immediately available.

Secure and controlled night-time and weekend reception can be achieved by creating a night **lobby** or vestibule to which the public can gain access and get out of the weather without penetrating the main lobby. Preferably, such a night lobby is adjacent to a staff post such as Master Control or dispatch so that public needs can be dealt with directly and securely. In the event a night lobby area cannot be directly viewed by Master Control or dispatch, it will be necessary to install a CCTV and audio communications link to the area. Regardless of location, some form of pass-through opening should enable those coming to the jail to transfer material to Master Control or the dispatcher without the officer leaving the secure post.

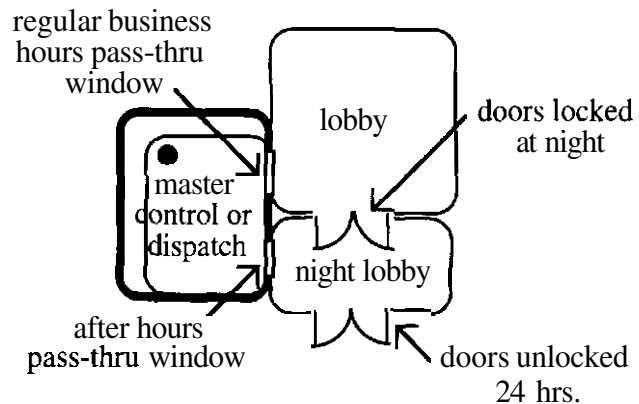

If the night reception post cannot be adjacent to the night lobby, the design should establish visibility between reception and public in the night lobby, if possible. If not possible, staff should have a video monitoring capability of the night lobby. They should also have the ability to monitor the main lobby in the event the visitor needs to enter it for further service. Audio communications should also be provided. Night-time control staff should be able to unlock the door separating the main lobby from the night lobby by remote control.

Receiving Packages

ISSUE: The means by which packages, clothing, money, and other items are received from the public should be secure and convenient.

RESPONSE: The public will bring a variety of items to the facility for use by the inmates. They may bring clothing that will be worn for court appearances, cash, or personal items, as permitted by jail rules. These materials can be securely received in several ways.

- There may be a *secure package or paper pass-through* in the wall of a secure reception area. If the reception point is Master Control and/or dispatch, the package pass-through, in particular, raises a security concern about explosives or other items that would endanger the control staff and the facility.
- Another method is simply to have *facility staff* exit from the security perimeter to receive and screen the contents of the items prior to allowing them within the security perimeter. This is an inconvenience for staff and takes them away from other security duties.
- A third approach is for *clerical staff* or dedicated reception staff to accept materials only during the day. Facility security staff would then probably exit the perimeter at a convenient time to receive and check the materials prior to final acceptance.

A combination of these approaches might best satisfy reception needs

Lobby Support Elements

ISSUE: Proper support space and equipment should be provided for the lobby area.

RESPONSE: Several space and equipment considerations should be made during the design of the lobby area. They include:

- public toilets for men and women (handicapped accessible);
- drinking fountains;
- telephone;
- ashtrays;
- clock;
- a bulletin board or display case that communicates facility rules and practices relevant to the public;
- durable but comfortable furniture with durable finishes;
- a locker area for the secure storage of coats and valuables (especially in connection with visiting -- see the "Visiting Areas" functional-architectural section);
- heavy-duty exhaust and ventilation in areas designated for smoking;
- a small children's table for crayons and coloring books.

CLERICAL/WORK AREAS

These are the work areas for clerical and records staff and other miscellaneous functions associated with facility administration.

ISSUE: The basic activities of the clerical and support staff should be determined to establish size and equipment requirements.

RESPONSE: The clerical area forms the core of the administration area. There are fundamental functions involved in this area, with some variations.

A primary variation is whether the clerical staff will be involved in public reception. If so, their space needs to be immediately adjacent to, and accessible from, the public lobby area. The method by which the public will be received should also be determined since it can be done either in a secure manner (having the public speak through a secure telephone, intercom, or pass-through) or through approaching or entering the clerical area and speaking directly with clerical staff across a counter or desk.

It should also be determined whether the clerical staff will have the primary responsibility for answering *telephone calls* during the day. Answering calls for all parts of the facility can be a time-consuming and eventually generate the need for additional clerical staff. This, in turn, can affect the overall plan for clerical space.

Clearly, the administrative workload must be carefully identified and assigned to positions prior to beginning design. Further discussion of administrative tasks and position assignments will occur during design to ensure an effective and efficient administrative component.

Clerical staff typically perform the following activities:

- typing or entering data,
- maintaining files,
- establishing and keeping records,
- copying and collating reports and information,
- logging and sorting mail,
- maintaining accounts and purchasing,
- controlling and managing inventory of facility office supplies, and
- transcribing dictated information.

The kinds of equipment associated with typical clerical activities include:

- desk and chair for each clerical staff person,
- typing stand **and/or** computer stand,
- typewriter **and/or** computer and printer,
- copier,
- work surface to collate copied reports and information or to sort and log mail,
- postage scale,
- binding machine,
- telephone,
- intercom unit,
- transcribing machine and foot pedal,

- file cabinets,
- waste basket,
- fax machine,
- file server, and
- safe.

ISSUE: A variety of functions associated with the clerical work area may demand separate space.

RESPONSE: Such areas are either provided within the clerical area, an adjacent alcove, or an adjacent separate space.

- **Supply storage** should be provided for pens, pencils, paper, copier supplies, file folders, forms, etc. The size of this space depends on the range of items stored and the inventory maintained (a large file cabinet may be adequate in very small jails). Cheaper prices realized by wholesale purchases from office supply firms, especially with respect to customized forms and copier paper, might suggest a fairly significant amount of space for office supplies.
- **Inactive record files need accommodation.** A jail is frequently required to maintain files on inmates and general office matters, such as budget summaries, policy and procedure manuals, etc., so they are accessible to the staff as needed. Generally, these sorts of files are kept in the clerical area and need not be within the main security perimeter of the jail.

A key determinant of storage needs is the **lifespan** that defines "active" records (e.g., current and those generated in the last year) and "inactive" records (e.g., 1 to 40 years old). Depending on the time period covered and the volume of inactive files kept, some or all of them might be better stored in less valuable space out of the administrative area. Basement or attic space might be used as long as it has satisfactory environmental characteristics to preserve the integrity of the files (dry, well ventilated) and allows for easy retrieval of files.

Other approaches to maintaining inactive records include placing them on **microfilm** or **computerizing** the information. A decision to microfilm or computerize can greatly reduce the need for space in the clerical and administrative areas for inactive records. Microfilm data systems should be accompanied by a storage capability for the microfilm records and for a reader station.

- There should be a **closet area** to store the coats, purses, hats, and boots of administrative personnel and official visitors.
- There should be easily accessible **toilet facilities** for staff (handicapped accessible).

- Depending on whether there is a staff breakroom, a small area for a *coffee machine, microwave, and/or refrigerator* might be provided.
- To maintain the acoustic integrity of the area, a separate space may be developed for equipment such as *copy machines* and *computer printers* that generate noise.

ADMINISTRATOR'S OFFICE

ISSUE: The location of the jail administrator's office must be convenient both to the jail and to clerical areas of the facility.

RESPONSE: As previously discussed, the jail administrator's office has a close relationship with the clerical areas and the primary security areas of the jail. If the jail administrator's office is within the jail security perimeter, it would be useful to provide an ability to observe several key areas or the main circulation corridor from the space. While the jail administrator's office may have a fair amount of glazing to permit observation, it should also have curtains or blinds to afford privacy in dealings with staff or inmates.

If the jail administrator's office is outside the security perimeter, it would be beneficial to make it large enough to accommodate small conferences. If it is within the security perimeter, it would be useful to make it immediately adjacent and accessible to a conference area.

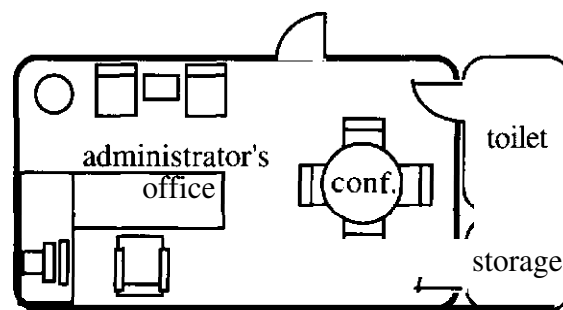

ISSUE: The jail administrator's area should be designed to accommodate a variety of functional needs.

RESPONSE: Aside from the normal desk and seating requirements, a number of functional and equipment considerations influence the design of the jail administrator's area.

- A private toilet would be desirable unless one is convenient in another location.
- A small, very secure storage closet would be desirable. Security is essential because the closet might be used to store sensitive items, such as audio tapes, or evidence from disciplinary investigations.

If the jail administrator's office is outside the security perimeter, it may be a repository for an extra set of facility keys that can be accessed in an emergency. If this is the case, the keys must be in a secure cabinet, preferably in a secured space out of sight. A closet space provided within the jail administrator's area might be an appropriate place to locate a secure key cabinet.

- The windows of the jail administrator's office should have a burglar-resistant or detention-quality glazing to prevent vandalism or attacks from the outside.
- The space should have lockable file cabinets and drawers, especially if other administrative staff also use the jail administrator's office as a night-time command post or meeting center. Often the administrator's office is the repository for personnel records to which access must be restricted.
- The door to the jail administrator's office should be lockable.
- The jail administrator's office must be equipped with both an inside telephone line or intercom system and an outside telephone line.

The jail administrator's office must have the ability to provide visual and acoustic privacy. This is critical because the administrator often meets with inmates or staff about private matters. In providing acoustic privacy, be sure that sound does not transfer through ventilation systems or above the ceiling and into adjacent spaces.

- If the jail administrator is the recipient and caretaker of bond monies, a safe or lockable deposit box would be advisable.
- The jail administrator may want CCTV monitors or the capability to later accommodate them.
- If the primary method of communication between jail staff is portable radio, that capability may be needed in the jail administrator's office.

CONFERENCE AREAS

ISSUE: The conference area should have characteristics conducive to meeting activities.

RESPONSE: Conference space can be provided in several ways, including:

- a dedicated conference area (preferred);
- a conference area within a larger staff briefing/training multi-purpose room;
- an extension of the jail administrator's area for small conferences (preferred only as an addition to other conference space).

The conference area should have the following characteristics:

- Sufficient space to accommodate the number of people expected to use the area. Square footage might be as follows, depending on actual equipment and furnishing needs.

Number	Room size (square feet)
4-5	125
6-7	145
8-9	170
10-11	200
12-13	250
14-15	300
16-17	365
18-19	430
20-22	500

- Sufficient wall surface for presentation boards, screens, marker boards, bulletin boards, etc.
- Controllable and variable lighting arrangements.
- Adjacency to the jail administrator's office, if possible.
- Storage area for audiovisual and other support equipment.
- Telephone, cable TV, and data outlets.
- Good acoustical qualities.
- Natural lighting, if possible.

**SECURITY
EQUIPMENT**

ISSUE: Provisions must be made for storage of security equipment.

RESPONSE: The facility will probably need to maintain a variety of security equipment, including:

- helmets,
- batons,
- shields, and
- chemical agents

This equipment should be stored in a controllable area **outside** the jail's main security perimeter. There is no single **best** location, but common locations include the:

- secure armory locker in the vehicle sally port;
- sheriff's law enforcement weapons armory (if a joint facility); and
- secure armory locker in the jail's administration area (if outside the security perimeter).

Regardless of location, several characteristics of the security equipment storage space must be considered. They include:

- secure and lockable door;
- security construction for the wall, floor, and ceiling of the space;
- access limited to the jail administrator or law enforcement supervisors and other key jail personnel selected by the jail administrator;
- adjacency to the jail administrator's office and briefing areas where officers might assemble in emergencies and be issued the security equipment;
- detectors and alarms if chemical agents or ammunitions are stored in the space;
- special ventilation if chemical agents are stored in the space;
- proper and accessible shelving and storage compartments for the various equipment stored.

SPACE LIST

Some of the typical spaces that might be found in the administration/public component follow.

	<u>Number</u>
ADMINISTRATION	
Clerical	1
Supply storage	as needed
Copy room	as needed
Administrator's office	1
Shift commander	as needed
Conference	1
Other staff offices (incl. spares)	1+
Staff toilet*	1-2
Coat closet	1
Inactive records	1
Jail security equipment	1
PUBLIC	
Public lobby	1
Public toilet	2
Public storage/locker area	1
Night lobby	1
Public reception desk	1
Security vestibule	1
(may be same as used for visiting access)	
Parking	as needed

*See local codes and the ADA regarding handicapped accessibility requirements.

RELATIONSHIPS

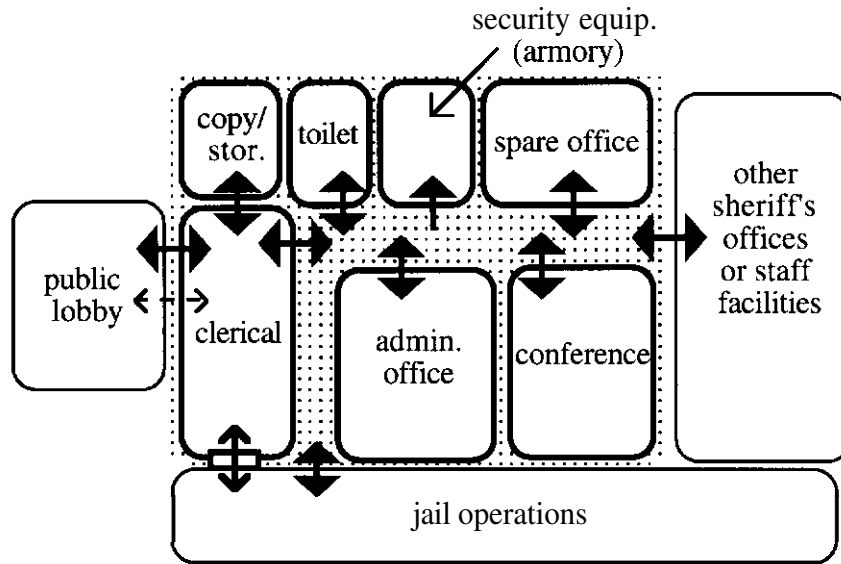

COMPONENT DIAGRAM

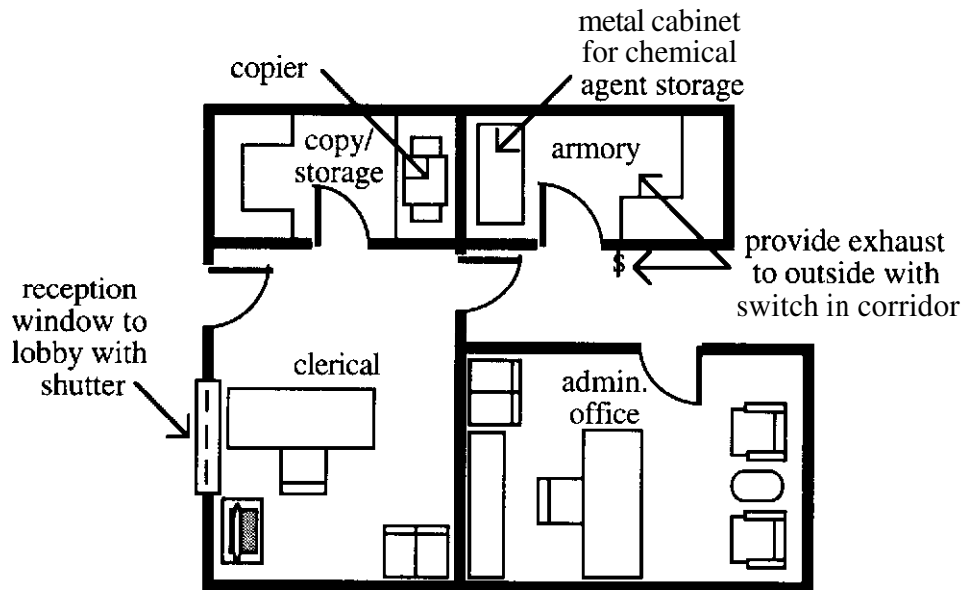

STAFF AREAS

DESCRIPTION

No one spends more time in jail than the jail staff, who often work under unpleasant and stressful conditions. Yet jails across the country have consistently neglected to address their needs.

Motivation and management experts state there is growing evidence that corporations failing to address staff needs send a clear message to their employees. That message is, "You don't count around here!" By making an architectural statement that clearly recognizes and accommodates the needs of its jail staff, a local government can make a lasting contribution to positive employer-employee relations, staff morale, and productivity.

In this functional-architectural component, "staff areas" are defined as those spaces that are specifically intended for the private use of jail staff. This includes a lounge or breakroom, training areas, **locker/shower** rooms, and toilets. It does not include staff control posts, which are dealt with under "Master Control" and "General Housing."

Newly built small and medium-sized jails around the country have some -- and a few have all -- of the staff areas identified. Some jails have cleverly consolidated some of the spaces under the heading of a staff "multi-purpose" or "multi-use" room. It is recognized that consolidation of selected functions and activities is **necessary** and in fact prudent in a small jail. Therefore, it is not necessary to view every staff space as having a mutually exclusive purpose. The trick is to avoid taxing any one area with too much staff or traffic or with activities that are inappropriately combined, as in one small jail where the coffee room and weight room occupied the same space.

A key sharing concept in a small or medium-sized jail is that of creating common staff areas for both **law enforcement and jail personnel**. With few exceptions, there is no substantial reason to separate many of the areas. It is important, however, to consider providing equal accommodations for each to help avoid the age-old problem of perceiving law enforcement work as more important and desirable than jail work.

KEY DECISIONS

As the role of the staff component is evaluated, the following decisions should be made since they have a fundamental effect on design requirements.

- Will jail officers routinely change into uniforms at the facility? Will locker and shower areas be needed? Where will they store coats, boots, hats, and articles which should not enter the security envelope (e.g., weapons, holsters, pocket knives, and, perhaps, matches and lighters)?

- Will there be physical fitness requirements for officers that can only be met by providing proper facilities at the jail? Can exercise facilities that are primarily designed for inmate use also accommodate staff needs?
- Will staff receive regular or daily briefings on the previous shift's activities and their responsibilities, or for other purposes?
- Will staff be allowed breaks away from their posts? Will they eat meals away from their posts? Does the administration want to encourage camaraderie by providing a place for staff to meet before or after work?
- Where will staff receive formal training?
- If the law enforcement function is in the same facility, which staff areas can be shared?

DETAIL ISSUES

The following detail functional-architectural issues relate to the various functions and spaces that make up the private staff areas of the facility.

GENERAL ISSUES

ISSUE: Staff areas should be located outside the secure envelope of the jail.

RESPONSE: It is not in the best interests of jail security and operations to place staff areas within the security envelope because off-duty jail officers, and especially law enforcement officers, within the envelope can distract the attention of on-duty staff and inmates. Staff areas should be near and easily accessible to an access point in the secure perimeter to avoid unnecessary delay in moving into the jail.

The exceptions to this rule are staff dining/break areas served by the jail kitchen (but off limits to off-duty staff) and inmate exercise areas that also serve the physical fitness needs of staff in circumstances where a dedicated staff exercise area is not affordable. These areas would need to be inside the security perimeter.

Staff areas are not public areas. Therefore, they need to be separate and secured from unwanted public traffic.

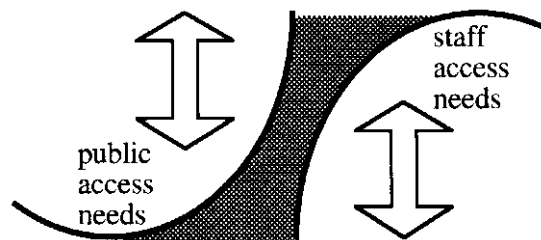

ISSUE: Staff parking and entry must be considered in design.

RESPONSE: It is important that adequate parking be provided for staff, which generally entails:

- *sufficient parking* to accommodate shift overlap needs so that personal and departmental vehicles are not left on the street or in places other than the staff parking area, and
- *protected parking*, or at least parking separate from the public and visitor parking areas.

Protected or separate parking recognizes the professional status of staff and guards against vandalism. It can be provided in several ways:

- underground garages or above-grade structures with or without a controlled access point, which also provide protection from the weather;
- fenced-in parking areas behind a control gate; and
- a separate area, less visible to the public, possibly with access controlled by a gate.

Staff should have the option of entering the jail through the public lobby or through a staff-only entrance. In a small or medium-sized jail, the choice makes little difference as long as the following conditions are met:

- entry is convenient to staff **parking**;
- entry to the staff areas is securable by key or pass card issued to staff, by remote **unlocking** operation from a dispatch center or Master Control, or by a coded electric lock; and
- there is a conveniently located place, such as a locker area, for staff to deposit weapons and personal belongings prior to entering the jail security envelope.

LOCKER/SHOWER AREAS

Across the country, the need to provide locker and shower space for staff gets a mixed response. Many new jails have such space but find it receives little use, while other facility managers voice a need for it. Factors that contribute to the use of and need for this space include:

- absence of any other space to secure personal property or clothing during the work shift;
- provision of physical conditioning space and equipment within the facility;
- a physical fitness movement or "culture" among staff;
- ages and interests of staff;

- prevalence of "moonlighting" by staff, which might require a clothing change and possibly a shower;
- need to change into civilian clothes for court;
- potential for contact with soiled clothing, laundry, body fluids;
- need for storage of extra uniforms or issued equipment; and
- proximity of the jail to staff residences.

Activities1 Characteristics

ISSUE: Space, equipment, hardware, and finishes should be appropriate for the activities and needs of the area.

RESPONSE: Locker/shower area activities are little different from those in conventional public facilities. They include:

- dressing and undressing;
- clothing exchange/storage of coats, hats, boots;
- storage of spare uniforms;
- storage of holsters, belts, and miscellaneous job-related paraphernalia, if not weapons;
- storage of policy and procedure manuals, study documents;
- grooming (counter, sink, and mirror are necessary);
- showering and drying;
- hand and face washing;
- toilet; and
- temporary storage of clean and dirty towels.

Equipment, hardware, and finish considerations include:

- shower stalls, preferably individual with accessibility for staff with disabilities;
- drying area, preferably with seat and towel racks;
- sink;
- toilets and urinals, accessible for staff with disabilities;
- shelving for storage of towels, washcloths, and toiletries;
- clothes hampers;
- lockers, benches;
- non-slip surfaces near the shower areas and waterproof, cleanable surfaces throughout;
- mirrors;
- mechanical ventilation sufficient for the area;
- electric hand and hair dryers;
- ample outlets at the sink/grooming area;
- heat lamps; and
- bulletin board(s).

Female Staff

ISSUE: Separate areas for female staff should be considered.

RESPONSE: Female officers are employed at jails in greater numbers than ever before. While female staff can clearly share breakrooms, physical

fitness, and training areas with male staff, they should be afforded the privacy of separate showers and locker areas.

Locker/Shower Area Size

ISSUE: The size of the locker/shower areas depends on the number and flow of users and their basic equipment needs.

RESPONSE: In calculating equipment and thus space needs, a significant difference between locker needs and other equipment needs must be recognized. The number of lockers is determined by the *total number of staff* projected to use the area. Other equipment needs are determined by the number of users *at any one time*. The difference recognizes that there are considerably more total staff under employment than there are at work at the jail at any one time or who may come to exercise at any one time. This is also true of law enforcement officers who may share the locker/shower area. (The section on "Staffing Impact" in Chapter 3 reviews the difference between staff totals and staff shift counts.)

The number of lockers and other equipment provided, and thus the amount of space required, may increase if administrative, clerical, reserve, and even outside civilians use the exercise facilities. Outside civilians may use exercise and locker facilities for any number of reasons: community programs with inmates or programs involving disadvantaged children, civic groups, or local officials. In these circumstances, it might be wise not only to add extra lockers, fixtures, and space for such users but, if funds allow, to provide them in a *separate area* to preserve the security and integrity of the staff-designated areas.

Sufficient space to permit generously sized staff lockers is recommended. This is due to the variety of articles that might be stored, including:

- uniforms;
- hats, coats, boots, shoes;
- extra socks, underwear;
- civilian clothing;
- equipment, such as holsters, pocket knives;
- toiletries, medications;
- books, manuals, personal papers; and
- other items issued or required by the agency.

A typical locker has:

- ventilation through small louvers or perforations;
 - a lockable latch;
 - a shelf or shelves for hats, toiletries, manuals;
 - single-tier design for full-length garments;
 - sufficient width and depth to accommodate garments on a hanger (at least 21 inches deep); and
 - hooks for towels or other garments.
-

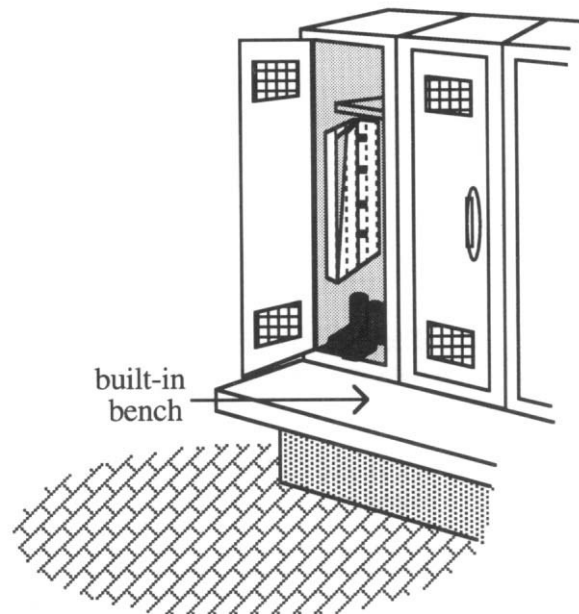

Bench seating should be adjacent to the lockers. To facilitate cleaning, lockers should be elevated on a base.

PHYSICAL CONDITIONING AREA

Many jurisdictions require staff meet minimum physical fitness standards. A good argument can be made that it is reasonable for those jurisdictions to provide space and equipment to permit staff to exercise regularly. The key to determining whether such a space is needed will be an evaluation of whether the level of usage and resultant benefits to the staff and the organization justify the expenditure. Provision of an exercise area and equipment will in all likelihood necessitate a staff locker room also.

Space Size

ISSUE: The size of the area depends on the number of people using it and types of activities.

RESPONSE: The size of a physical conditioning area is influenced by the following factors:

- total number of potential exercisers at any one time;
- whether the area will be jointly used by both jail and law enforcement staff;
- type of activities:
 - basketball;
 - **weightlifting**;
 - martial arts training;
 - calisthenics;
 - aerobics;
 - other.

- type of equipment required for the activities:
 - basketball backboard, rim, and floor area;
 - open floor space for wrestling/self-defense activity mat;
 - multiple-station exercise machine;
 - station for "free weights," including bench press;
 - inclined board;
 - stationary bicycle;
 - treadmill;
 - other.

The functional-architectural section on "Exercise Areas" provides further data on some of the space needs of these activities.

Using Inmate Areas

ISSUE: It is possible for staff to use inmate indoor and outdoor exercise areas.

RESPONSE: Staff use of inmate exercise areas has generally met with resistance. Attempting to schedule the space reduces the opportunity for both groups to use it and reduces its value as an inmate management tool and staff benefit. Staff should also have privacy from inmates when working out, which is difficult to achieve when exercise is located in the security envelope and is perhaps within view of inmates and jail control posts.

If use of the inmate areas is necessary, however, care should be taken that the design allows for staff supervision of indoor/outdoor exercise when the areas are used by inmates, but prohibits inmate viewing from housing and other areas when used by staff. This might be achieved by spatial arrangement as well as the use of curtains, screens, or movable panels over key vision panels that otherwise allow view into the exercise area.

Access

ISSUE: A dedicated staff exercise area should be located outside of the security envelope.

RESPONSE: A dedicated staff exercise area should be designed so that staff can come and go without entering the security envelope. This is desirable since staff may want to exercise at odd hours and most jail administrators do not encourage off-duty staff to enter the security envelope after hours. Also, staff will be out of uniform and carrying gym bags, clothes, and other gear that could raise questions of contraband passage since items accidentally left behind might be obtained by inmates.

If staff use the inmate exercise area, it is important that they gain access to it through a controlled point in the security envelope. Like all other penetrations of the security envelope, access should be through a vestibule that is monitored and controlled, if not also directly observed, by Master Control. It would also be wise to consider placing the exercise area(s) as near to the point of staff access as possible to minimize staff (or non-staff) movement.

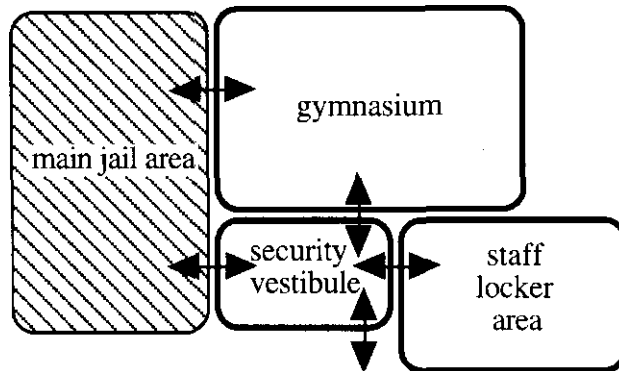

**STAFF
BREAKROOM**

Staff need a place apart from the inmate population to eat meals and take other approved breaks during the shift. In addition, space should be provided to store meals, snacks, and soft drinks.

Breakroom Size

ISSUE: The size of the staff breakroom depends on the activities, users, and equipment involved.

RESPONSE: Activities that typically occur in a breakroom include:

- storage of personal meals and foodstuffs;
- cigarette, soft drink, and snack vending unless available through the commissary;
- refrigeration of sack lunches and perishable snacks;
- eating of meals;
- recreational reading;
- conversation;
- "time outs" or stress-reducing breaks;
- preparation of hot and cold beverages;
- limited meal preparation (warming, toasting); and
- smoking (depending on local ordinances or institutional policy).

Equipment and furnishings for which space may be needed include:

- table and chairs;
- small sink (gooseneck faucet for easy filling);
- countertop;
- drawer for utensils;
- storage for cleaning supplies, cups, dishes;
- kitchen appliances (coffee maker, toaster, microwave);
- hot plate or countertop stove elements;
- under-cabinet lighting;
- electrical outlets near counter;
- refrigerated storage for food and drink;
- trophy cabinets, shelves;
- bulletin boards;
- telephone;

- intercom (if walkie-talkies are not used);
- television; and
- vending machines.

The breakroom should accommodate about 75% of staff on the largest shift, including jail officers, administrators, and clerical. If the breakroom is shared with law enforcement staff, their needs must also be met.

If smoking is prohibited in the facility, an *outdoor courtyard* with a covered area adjacent to the breakroom would be appropriate and would help keep the officer who smokes in close proximity to where he/she may be needed if an emergency arises. The natural light introduced to the breakroom through an adjacent courtyard is also beneficial.

Breakroom Location

ISSUE: The breakroom might be located within the security envelope of the jail.

RESPONSE: The breakroom might best be placed within the security envelope of the jail and thus separate from the other staff areas if:

- staff meals are provided by the jail kitchen (already within the jail perimeter);
- the breakroom is not intended for heavy use by law enforcement personnel;
- the space is essentially limited to the breakroom function and does not serve as a conference room, training area, or staff multi-purpose room; and
- the sheriff or jail administrator wants to keep staff who are taking a scheduled break within the security envelope, so they can respond quickly to an emergency or problem that might arise. (This may especially be the case in the small jail since the total number of staff available per shift may be quite limited.)

STAFF TRAINING MULTI-PURPOSE

Training is a must for any size jail. Small or medium-sized jails often find in-house training necessary because it is so difficult to release staff for extended stays at state academies or other training programs. A totally separate training area is probably impractical for the small jail unless the combined jail and law enforcement training demand is high enough to justify one. However, this will vary with organizational philosophy and training requirements. One common approach in jails where consolidation is feasible is a *combination training/conference/briefing room*.

The following functional issues apply to the design of an area for staff training and conference rooms.

ISSUE: The training area in a small or medium-sized jail is usually dual or multi-purpose space.

RESPONSE: Design and plan to furnish the space in such a way that its location and furnishings accommodate a wide range of activities. Carefully evaluate the activities that will take place along with training. Small and medium-sized jails often fail to detail the nature and type of staff areas needed and end up with one or more poorly defined and designed rooms.

There is more to planning staff multi-purpose space than simply designing a large, open room as occurs in many jail projects. In many of these projects, the original plan was to accommodate all of the following activities and functions in a single space:

- inmate multi-purpose;
- law library;
- training room and resource library;
- audiovisual storage;
- inmate recreation equipment and supply storage;
- staff meetings and conferences; and
- inmate programs (e.g., AA, GED classes).

Such a plan, while appearing practical, ignores the reality that inmate activities are fundamentally at variance with staff activities. The need for the space at peak activity times, such as evening hours, places unrealistic demands on the space if conflicting uses are merged.

Aside from time and security conflicts (e.g., inmate access to staff equipment, information, training documents), there may be sufficient legitimate staff-related activities in even the 20- to 50-bed jail to justify provision of a separate staff multi-purpose area. Such a space could accommodate the following compatible activities and functions:

- conferences and meetings;
- staff training;
- staff library and training resource storage;
- audiovisual storage (overhead projector, 35mm slide projector, 16mm projector, video camera, VCR, television, movie screen, easel, and related supplies); and
- training programs through cable TV broadcasts.

ISSUE: Equipment, hardware, and furnishings should match activities and functions.

RESPONSE: The following considerations apply for the staff multi-purpose area.

- Size and shape should be compatible with classroom-style instruction.

- Lighting should be adjustable and suitable for both audiovisual presentations and reading.
- Folding tables and folding or stackable chairs enhance flexibility.
- If the room is of sufficient size, a moveable, ceiling-suspended divider adds flexibility for scheduling. An access door should be provided for each side.
- Windows are desirable but are not as great a priority as wall space for shelves, marker boards, tackboards, and storage cabinets.
- Finishes and furnishings should be suitable for activities that entail instruction, reading, writing, listening, concentration, and group discussion. An attempt should be made to design, finish, and furnish the space in a way that distinguishes it from the starker surroundings in other areas of the jail. Otherwise, part of the benefit of having a separate staff multi-purpose space will be lost.
- Lockable storage should be available for such equipment as projectors, tape recorders, video cameras, VCRs and televisions, and training documents that might include sensitive policies and procedures.

ISSUE: The staff breakroom might be merged into a space used for other staff functions.

RESPONSE: Since the breakroom might be used for short periods during the day and training/briefings might occur irregularly and at different times, it may be wise to consider merging the functions into one multi-purpose space. Compatible staff functions include:

- training,
- library,
- staff conference, and
- comparable law enforcement functions.

Merging physical conditioning with the breakroom/training/conference functions is not recommended. The key to any merging of functions is to identify the nature, timing, and frequency involved and ensure there are no incompatibilities or conflicts.

To give some spatial definition to the break area in a multi-purpose setting, two ideas might be considered, among others:

- create an alcove area for the breakroom off the main multi-purpose space, or
 - provide partitions to separate the food preparation and storage area from the breakroom area.
-

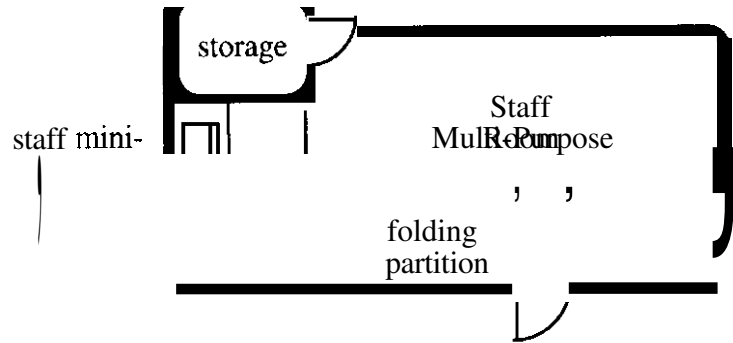

To make the break area complement the multi-purpose concept, consider:

- using stackable chairs for staff dining/breaks,
- using folding tables that can be moved out of the way, and
- providing an adjacent storage space.

STAFF TOILETS

ISSUE: The need for staff toilet facilities within the security envelope must be evaluated.

RESPONSE: There are many options for providing proper facilities for staff consistent with security and operational goals. There will undoubtedly be both male and female public toilet facilities in the public reception area, if not facilities in staff locker/shower areas. Depending on the jail's final design, these toilets might be used by on-duty staff as well. However, this practice may require staff to move outside the security envelope, creating security problems and considerable inconvenience.

There is the potential of staff using the inmate facilities located at the intake/booking area, but staff may object for hygienic reasons. If the jail operates a secure Master Control or housing control, it will be necessary to locate a single unisex restroom within the control space. However, the use of this restroom by roving staff might violate the perimeter of the control center more than desired by security policy.

It may be best to provide a separate unisex toilet facility within the security envelope and accessible to non-control staff. Such a facility should be at an easily accessible location and generally out of view of the inmates.

SPACE LIST

Some typical spaces that might be within the staff component include:

- Locker/shower area
 - male
 - female
- Physical conditioning
 - storage
- Breakroom
 - outdoor courtyard
- Training/multi-purpose

- storage
 Staff toilet within secure perimeter*
 Parking.

* See local codes and the ADA regarding accessibility requirements for persons with disabilities.

RELATIONSHIPS

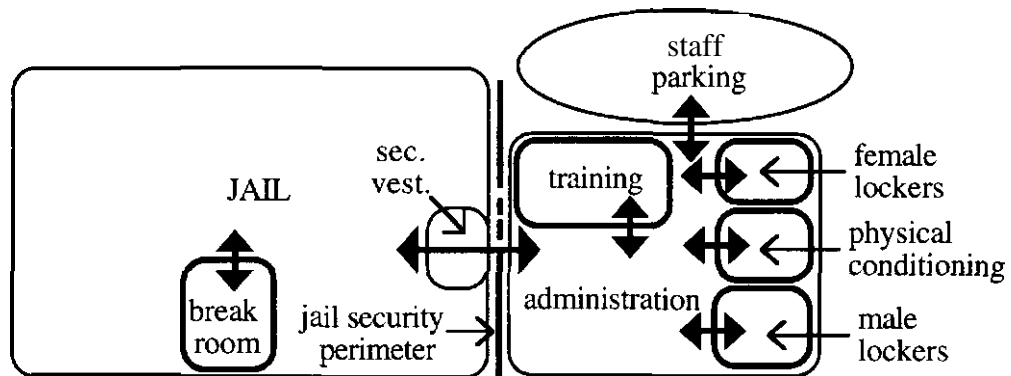

COMPONENT DIAGRAM

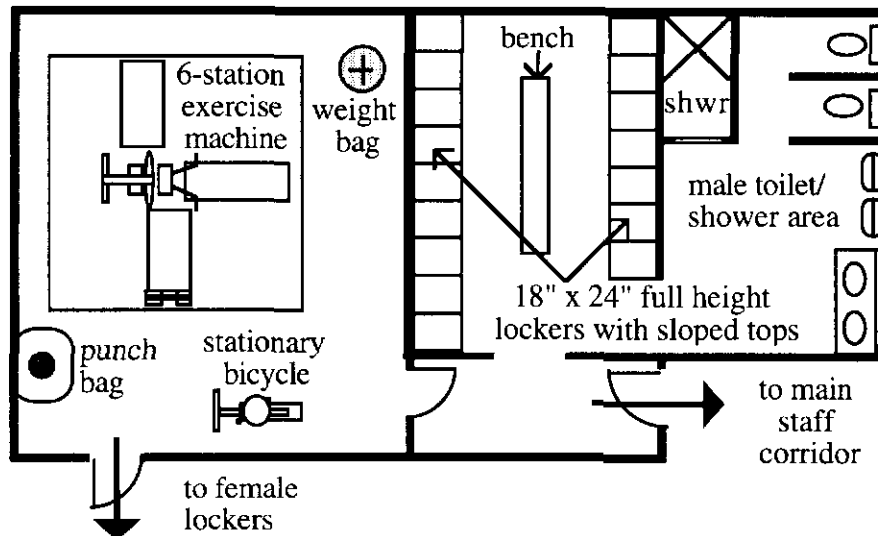

STORAGE AREAS

DESCRIPTION

Storage space must be provided in virtually every functional component of a jail. While less prominent, it is as vital as any other space to attaining efficient and convenient operations. The presence of files, mattresses, and paper goods in corridors, fire stairs, interview rooms, and staff offices of existing jails is testimony to the fact that storage space has been consistently underestimated in planning and designing new jails.

While various storage needs have been documented throughout this chapter, miscellaneous storage needs are addressed here. Additionally, since storage is often an overlooked aspect of jail design, this functional-architectural component summarizes all typical storage needs for all components in a small or medium-sized jail and thereby focuses attention on them.

KEY DECISIONS

As the role of storage is evaluated, the following decisions should be made since they have a fundamental effect on design requirements.

- Is there an opportunity for shared storage space between the jail and sheriff's law enforcement operation?
- What items can be stored together in a general purpose storage room and what items will require separate space?
- Should certain items be stored in one central area, or should they be stored in satellite facilities served by a central source for greater daily convenience (e.g., linens, toiletries, and/or mattresses distributed from a small storage space at the housing unit but supplied from a larger space)?
- Will the jail emphasize purchasing at wholesale and therefore in large quantities (such as food, toiletries)?

DETAIL ISSUES

The following detail functional-architectural issues should be considered in the development of storage spaces.

MISCELLANEOUS STORAGE NEEDS

ISSUE: There are numerous miscellaneous storage needs aside from those associated with other functional-architectural components.

RESPONSE: Miscellaneous storage needs not yet addressed in this chapter include the following.

- *Central storage.* This storage area serves as a catch-all for a variety of important items, some of which might be identifiable before design and others after the facility is opened.

- Bulk supplies: toilet paper, soaps, detergents, etc.
- Items used in routine maintenance: air filters, fan belts, oil, car parts, grease guns, etc.
- **Replacement parts.** Every facility should store replacement parts for vital elements of facility operations and security. For example, it would be wise to provide storage for replacement locks, hinges, security glass panels, toilet fixtures, food passage doors, door closers, door handles, etc. as a precaution against damage that compromises the effective operation of the facility. Storage of such parts would avoid delays in obtaining replacement items, especially special detention items.
- **Mattresses.** Mattress storage needs are important to identify because most mattresses require significant amounts of space. Storage needs will depend on the facility's approach to distributing mattresses to inmates. Pillows might be stored in the same area as the mattresses, given that they probably will be purchased and issued together and will likely be of identical materials.

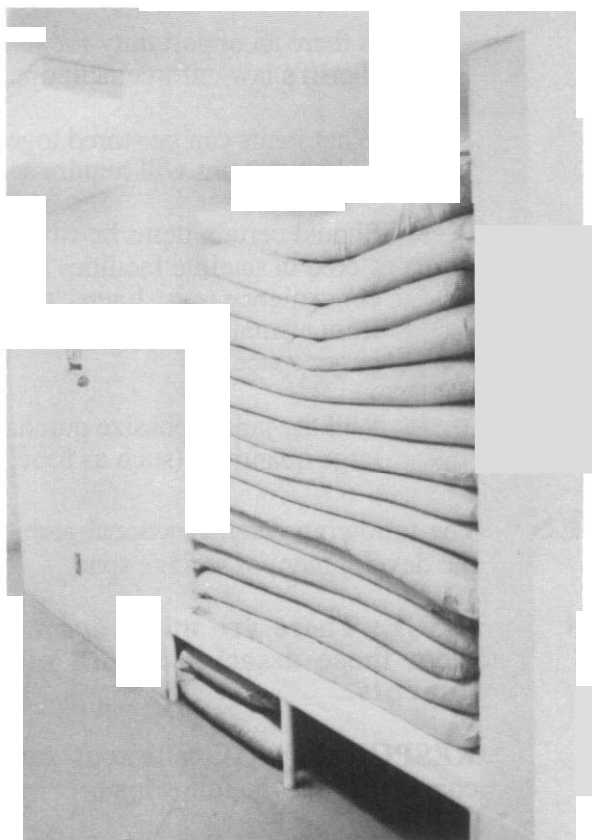

Conveniently located mattress storage alcove.

The mattress storage area should be near an area in which the mattresses can be thoroughly cleaned and disinfected periodically, even though a spray disinfectant may be regularly applied to the mattress

at the cell each time an inmate leaves the facility. If inmates launder the mattresses, the mattress cleaning and storage area should be in a space within the security perimeter that is easily controllable by staff.

- **Outdoor equipment.** Every facility needs storage space for outdoor equipment, such as lawn mowers, garden hoses, ladders, yard tractors, rakes, hoes, etc. This need increases if the facility has an inmate gardening program.

Outdoor equipment should not be stored in a vehicle sally port, which has been a common practice in the past. Rather, it should be in a secured space in another location accessible directly from the outside, if possible.

- **Cleaning equipment.** Every facility needs to maintain cleanliness. This principally involves keeping the floors, furnishings, and windows clean by the use of mops, buckets, cleaning fluids, cloths, floor buffers, etc. Storage space for these items should be provided liberally throughout the facility. Cleaning equipment is normally stored in a general janitor's closet that also includes a "slop" sink or wash tub and a capacity for storing such items as cleaning fluids and dust cloths. Care should be taken to keep toxic, flammable, and caustic materials secured from unauthorized inmate access.

The possibility of combining central storage, mattress storage, and storage of replacement parts and maintenance items in *one secured area* should be considered.

**FACILITY STORAGE:
OVERALL CONCERN**

The following functional-architectural issues summarize basic storage needs in general and some of the characteristics of storage facilities.

Summary List

ISSUE: All storage needs should be identified and associated with their proper functional component.

RESPONSE: Typical storage needs in a jail include the following.

- **Master Control**
 - restraint gear
 - walkie-talkies/battery chargers
 - keys
 - paper supplies/forms
 - manuals, directories
 - active records
 - first-aid kit
 - self-contained breathing apparatus
 - fire extinguisher

- ***Intake-Release***
 - active records
 - paper supplies/forms
 - personal property
 - clothing (including suits for court appearances, jackets, hats, boots)
 - valuables
 - money
 - bulky items (suitcases, duffel bags, attaché cases)
 - restraint devices
 - jail clothing
 - shirts/pants or jumpsuits
 - undergarments
 - footwear
 - socks
 - jackets
 - hats
 - gloves
 - linens/reusables
 - blankets
 - sheets
 - pillowcases
 - towels
 - washcloths
 - mattresses
 - toiletries
 - shaving gear
 - soap
 - toothpaste and toothbrushes
 - deodorant
 - toilet paper
 - weapons (officer weapon lockers)
- ***General and Special Housing*** (including control posts)
 - cleaning supplies
 - linens
 - toiletries
 - clothing
 - records, manuals
 - fire extinguishers
 - self-contained breathing apparatus
 - first-aid kit
- ***Health Care***
 - supplies
 - instruments
 - equipment/carts
 - records
 - emergency equipment
 - medications
 - first-aid kits

- **Visiting**
 - visitor log
 - visitor property (clothes, purses, attache cases, hats, etc.)
- **Indoor and Outdoor Exercise**
 - exercise equipment (balls, nets, poles, weights, etc.)
- **Inmate Programs and Services**
 - records, miscellaneous equipment
 - stackable and foldable furnishings
 - paper supplies
 - books, brochures, magazines, newspapers
 - religious materials
 - audiovisual equipment
 - flip charts, marker boards, markers
 - recreational equipment (folding ping pong tables, balls, paddles, etc.)
- **Commissary**
 - commissary goods (dry, refrigerated, frozen)
 - carts
 - records
 - writing materials and forms
 - containers (bags, boxes)
- **Food Service**
 - utensils, cutlery
 - dishware
 - pots and pans
 - carts and trays
 - refrigerated, frozen, and dry foods
 - garbage, recyclables
 - records, books
- **Laundry**
 - detergents, bleaches
 - carts and bags
 - records
 - temporary clothing and linen
 - miscellaneous cleaning implements
- **Administration/Public**
 - records
 - paper and office supplies
 - manuals, directories, books
 - security equipment
 - audiovisual equipment
 - staff coats, hats, boots, other items
 - security keys

- **Staff Areas**
 - clothing, extra uniforms
 - gym bags
 - books, manuals, brochures, newsletters
 - memos, paper records
 - break area supplies
 - coffee
 - snacks
 - paper cups and plates
 - audiovisual equipment
- **Miscellaneous Storage**
 - central supplies
 - outdoor equipment
 - replacement parts
 - maintenance equipment
 - mattresses
 - cleaning supplies and equipment
 - recycled items (cans, glass, plastic, paper, cardboard)

Security

ISSUE: All storage facilities must be properly secured.

RESPONSE: In general, it is appropriate to prevent random access to all storage areas in the facility by securing them with locked doors. However, it is not necessary to provide heavy security hardware, doors, and construction for many of the facility's storage needs.

High security is needed principally when the storage facility contains something valuable or potentially dangerous or provides a route of escape to inmates who have access to the storage area. However, observability of the storage area or the access to it may lessen the need for security construction. For example, if a storage area for cleaning fluids and chemicals is directly across from a constantly staffed post, a hollow metal door with an institutional lockset or a low-security detention lockset might be adequate. The gauge of the metal in the door might be selected more on the basis of durability than on security.

In assessing security needs with respect to storage, the following types of storage require the *highest level of security*:

- officer weaponry;
- jail keys/pass cards;
- medications;
- cutlery and utensils;
- personal property, especially money and valuables;
- medical instruments and equipment;
- cleaning fluids and detergents;
- restraint and riot equipment; and
- commissary and bond monies.

Special attention should also be paid to the security provided the following types of storage:

- first-aid kits,
- toiletries,
- walkie-talkies and other communication devices,
- fire extinguishers,
- self-contained breathing apparatus,
- medical records,
- other records,
- personal clothing/bulk property,
- personal articles belonging to visitors, and
- foodstuffs.

Proper security for the preceding storage items can be provided through a combination of approaches:

- placing certain stored items within enclosed security staff posts;
- keeping them outside areas accessible to inmates;
- directly observing access to the storage area(s);
- employing secure construction around the space, including walls, floors, ceilings, doors, and locks; and
- limiting inmate and staff access to sensitive storage areas, such as money, property, and key storage.

Size

ISSUE: The size of storage space depends on many factors, including institutional policies and procedures.

RESPONSE: The amount of space to provide in any given storage situation depends greatly on the policies and procedures of the facility and the activities that it plans to undertake. Consequently, proper storage space planning must identify these policies, procedures, and activities. Some factors involved in establishing storage space requirements include:

- the range of things that must be stored;
- size of inventory, which is influenced by ordering and replacement practices;
- surplus or overflow stocks;
- storage methods, particularly those that use the full height of storage spaces;
- capability of storing a wide variety of items in a common area or space;
- system of distribution, which generally varies between a central storage and distribution capability and a smaller central storage area complemented by satellite storage spaces elsewhere in the building;
- work activities related to storage (e.g., inventory control, ordering, sorting).

Location**ISSUE: Storage areas need to be conveniently located.**

RESPONSE: To be used efficiently, storage spaces must be properly located. However, since many storage functions are not necessarily critical to the minute-by-minute operation of the jail, some selectivity in locating storage facilities is important. This is particularly true when the methods of surveillance in the facility and the movement of inmates from housing to other areas dictate that higher priority be given to locating other functional components. Some criteria to consider when locating storage space include:

- security of the space and the need to isolate it from access;
- frequency of use; and
- affiliation of the location and the users involved.

The different priorities in locating storage space are illustrated by contrasting jail clothing storage for the booking area (where routine daily access is required for the efficient flow of inmate arrestees) and central supply storage (which is used only infrequently and typically only by staff as part of a re-supply effort).

**Mechanical
Plumbing****ISSUE: Special mechanical requirements must be recognized in developing storage space.**

RESPONSE: Given the nature of some of the items stored in a jail, special mechanical accommodations must be made for the space to function effectively and securely. These include:

- ventilation for storage spaces containing gases (security restraint storage area) or cleaning fluids;
- humidity controls for storage of paper products, powdered detergents, and similar items;
- temperature control for areas such as food service; and
- ventilation for storage that generates odors, such as street clothes.

SPACE LIST

Some of the miscellaneous storage spaces that have not been identified as part of the storage requirements for the other functional-architectural components include:

Central storage
Mattress storage/cleaning
Replacement parts
Maintenance equipment/supplies
Janitor closets
Outdoor equipment.

RELATIONSHIPS

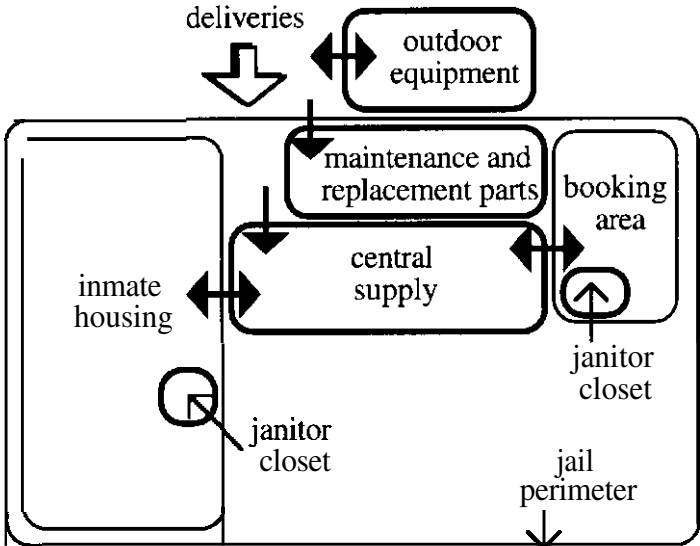

COMPONENT DIAGRAM

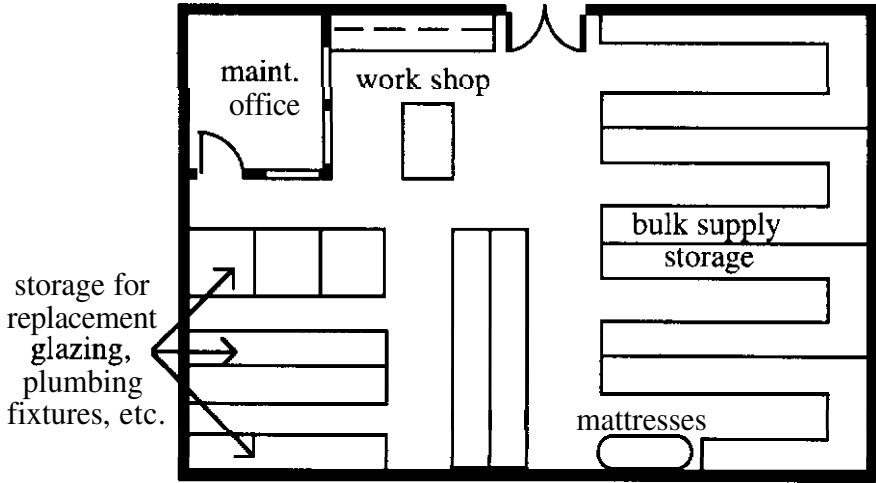

5

SPECIAL CONSIDERATIONS

5 SPECIAL CONSIDERATIONS

A number of issues deserve special consideration in the development of a small or medium-sized jail project. These are issues that seem to consistently cause difficulty or controversy in jurisdictions throughout the country. The resolution of each issue can substantially affect the outcome or direction of a project.

Nine of these special topics were addressed in the companion book to this document entitled *Small Jail Special Issues*. The issues presented in that document should be reviewed, in addition to those presented in this chapter.

The special considerations addressed here include:

- Single Versus Multiple Occupancy
- Renovating Non-Secure Buildings into Jails
- Construction and Project Costs.

These issues and the nine in the *Special Issues* document are addressed in the hopes that they can be confronted and resolved more expeditiously and knowledgeably by both the planner and the client.

SINGLE VS. MULTIPLE OCCUPANCY

An issue that frequently sparks debate within a community is whether to design inmate cells (sleeping rooms) with one bed (single occupancy) or with two or more beds (multiple occupancy). Local decisions in this regard have a considerable impact on the design of a jail, on project costs, and on the security and management of the jail.

DEFINITIONS

MULTIPLE OCCUPANCY

Multiple-occupancy sleeping rooms generally come in two types: *cell style* and *dormitory style*. The cell style multiple-occupancy room has historically included beds, a toilet, a sink, and perhaps a desk, stool, and shelf. It does not include such things as a shower or dining table, which are normally provided in adjacent or nearby dayroom spaces. Cell type multiple-occupancy spaces usually hold two to four inmates.

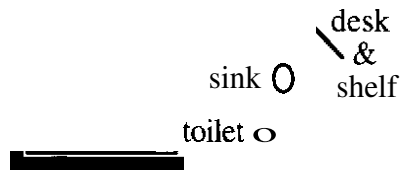

The dormitory style multiple-occupancy inmate space tends to be more self-contained. Everything needed to serve minimal inmate personal needs is within the single space: beds, toilet, sink, shower, dining table, and bench. Consequently, dayrooms are not typically associated with dormitory style cells. As many as 8 beds are frequently found in multiple-occupancy dormitories of smaller jails, and as many as 50 beds in those of large jails.

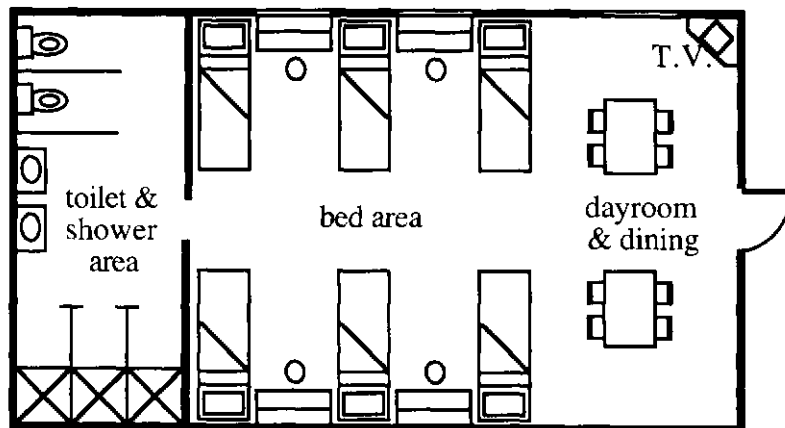

SINGLE OCCUPANCY

A single-occupancy cell normally has a bed, desk, stool, toilet, sink, and shelf at a minimum and shares an adjacent dayroom with other single-occupancy cells.

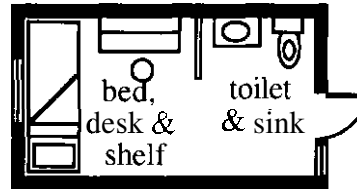

STANDARDS AND LEGAL ISSUES

Cases of constitutionality decided in the federal court system have not fully resolved the question of occupancy. Prior to the late 1970s, numerous district courts condemned double celling (two beds per cell). These rulings led to the creation of single-occupancy cells in the affected jurisdictions and led many to conclude that single-occupancy rooms were "constitutional" and multiple-occupancy rooms were not. However, based on a close reading of the cases, one could not conclude that double celling was in and of itself unconstitutional. Rather, double celling was found unconstitutional given the particular overall conditions of the facilities in question: lack of proper square footage, unsanitary conditions, poor ventilation, inadequate lighting (natural and artificial), lack of privacy, isolation in the cell for extended periods, inadequate exercise opportunities outside the cell, poor surveillance, and many other deficiencies in and out of the cellblock area.

Later, two cases on which the U.S. Supreme Court ruled dealt with the question of multiple occupancy: Bell v. Wolfish (1979) and Rhodes v. Chapman (1981). In both cases, new facilities were the topic of the suit. And in both cases, the facilities were ruled fundamentally "constitutional," having healthful and standards-compliant environments and a variety of amenities in and out of the cellblock areas. The Supreme Court essentially found no constitutional violations on grounds of occupancy alone in those two particular situations. Consequently, thoughts that multiple-occupancy housing was in and of itself unconstitutional began to change.

Since Bell and Rhodes, it has become clear that double celling in and of itself is not a constitutional issue unless it can be shown the cause of other problems, such as violence.

ACA STANDARDS

In 1977, ACA published its *Manual of Standards for Adult Local Detention Facilities*, which called for the exclusive use of single-occupancy cells. This position was also taken by the U.S. Department of Justice and had been the policy of the federal government in setting criteria for local jail construction projects funded by federal grant monies. ACA continued to call for single occupancy in the second edition of the *Standards*.

In the third edition and subsequent supplements, ACA adopted a more flexible standard calling for single cells for one-third of the jail population and allowing multiple-occupancy cells or dormitories for the rest, assuming

a series of additional standards are met. Of more importance is that each inmate have a minimum amount of unencumbered floor space in the cell.

Many states have also placed heavy emphasis on a portion of the jail being single-occupancy cells. The most consistent exception to single occupancy has been to allow multiple-occupancy dormitories for work release/periodic inmates or in-house inmate workers (trusties).

THE ISSUE

Central to the single-occupancy/multiple-occupancy issue is the cost of *construction versus management and operational concerns*. Rapidly increasing jail populations, the high costs of jail construction, and tight local budgets have led many county board and city council leaders to argue for multiple-occupancy, while greater security and better management have led many sheriffs, police chiefs, and jail administrators to argue for single occupancy.

COSTS

The following benefits of multiple occupancy versus single occupancy do indeed lead to reduced construction costs:

- fewer cell doors, locks, and hardware sets per bed;
- fewer toilet and sink fixtures per bed;
- fewer interior walls;
- less complicated electrical and mechanical provisions, as well as fewer light fixtures; and
- savings on square footage, including dayroom square footage.

A study done by Farbstein and Associates showed that the cost differential between single and multiple occupancy was significant. The study, *Housing Pre-Trial Inmates: The Costs and Benefits of Single Cells, Multiple Cells, and Dormitories*, found an overall facility construction cost *savings* of **11% to 21%** with various forms of multiple-occupancy housing.

OPERATIONAL CONCERNS

While it is difficult to argue against saving construction costs, jail administrators argue in defense of single-occupancy cells for a variety of reasons. Some jail officials concede that multiple occupancy is acceptable for persons considered low security, such as inmate workers or work releasees, even though it results in loss of privacy and vulnerability. However, they argue that single occupancy is a must for inmates with special behavioral, medical, or custody needs:

- disciplinary detention,
- medical isolation,
- high security,
- protective custody,
- serious mental health, and
- juveniles detained as adults

It is the general population between these extremes for which local jurisdictions must determine if they want single- or multiple-occupancy

housing. The main arguments against multiple occupancy for the general population include:

- It greatly reduces the staffs ability to prevent physical or sexual assaults, especially during night-time lockdown or other times when staffing levels tend to be reduced.
- It reduces the staffs ability to control inmates during disturbances since the staff cannot fully separate inmates and achieve a fully secure lockdown until the emergency passes.
- It increases tensions because inmates have no place to which to retreat to ensure personal safety and no place in which personal property can be protected from theft or vandalism.
- It diminishes administrative control since acts of vandalism in the multiple-occupancy cell or dormitory cannot be clearly attributed to one individual.
- It reduces flexibility in the small or medium-sized jail in that dramatic shifts in jail population makeup may force inmates who require single occupancy into multiple-occupancy spaces.
- It causes inmates to completely forfeit personal privacy since they must openly share toilet fixtures in close quarters and no other area of the facility affords individual privacy.

SINGLE OCCUPANCY: TWO CONCERNS

Two frequently cited operational concerns about the use of single occupancy are suicide and isolation. The isolation issue is easily resolved, however, with the provision of an adjacent dayroom serving a number of single-occupancy cells. Such a dayroom provides ample opportunity for contact between inmates. Dayrooms are required by the ACA standards and many state jail standards.

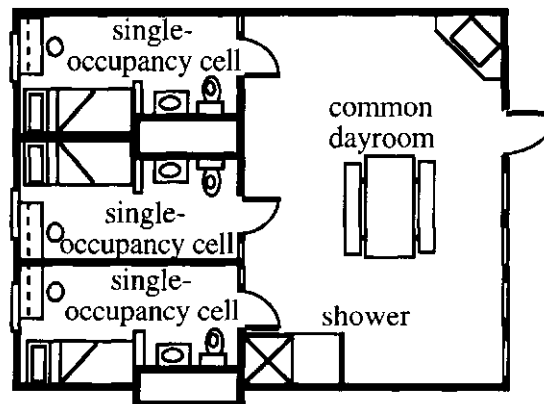

CONTROL OF SUICIDES

Suicide is a more difficult issue. Many people feel that single-occupancy cells are more conducive to suicide attempts and that the presence of two or more inmates in a multiple-occupancy setting reduces the likelihood of suicides. However, beyond the question of whether inmates should be relied on to prevent suicide by their cellmates, the fact is that suicide has been a problem in jails for years and most jails have, historically, consisted mainly of multiple-occupancy cells or dormitories.

The primary way to control suicide is operational rather than physical:

- realizing that most attempts occur shortly after intake;
- taking steps to identify suicide risks (i.e., suicide screening at intake);
- providing thorough staff training in recognizing signs and symptoms of suicide risk;
- providing adequate and frequent staff observation of suicidal inmates; and
- arranging for needed services for troubled inmates.

THE COSTS OF MULTIPLE OCCUPANCY

On balance, it seems that certain security and management capabilities are compromised to attain the construction cost savings of multiple-occupancy settings. Once compromised, these critical capabilities may be lost for the life of the jail, which could exact a toll on the jail staff and inmates.

Given the increased operational vulnerabilities of multiple-occupancy housing, jurisdictions should evaluate whether initial construction cost savings are merely expenses deferred until a later date. Specifically, these savings may at some point be offset by higher medical bills because of more frequent assaults; higher repair costs due to increased damage to jail property; or unanticipated legal costs arising as inmates or their families sue to recover damages as a consequence of injuries received in the jail.

Life Cycle Analysis

Adding staffing to the calculation produces scenarios under which double-occupancy housing costs about the same or more than single occupancy over a specified life cycle. Single occupancy offers the assurance that no assaults between inmates will occur during night-time lockdown. Some jurisdictions, therefore, feel that the night shift pod housing officer in a constant surveillance, single-occupancy situation (direct supervision or remote surveillance) can be replaced by roving staff periodically doing cell checks while executing other duties.

If jurisdictions feel that **double** occupancy requires a constant, 24-hour-per-day staff presence in the pod, as some do, the staffing difference between single and double occupancy could be about 0.5 FTE (full-time equivalent). The staffing impact could be greater if the roving officer doing the cell checks in the single-occupancy scenario is still present in the facility, perhaps somewhat inefficiently. The cost of such staffing differences adds up over time, especially since operational costs constantly inflate.

On the next page is a cost comparison contrasting the scenarios outlined above. In it are several assumptions:

- the cost of constructing a 40-bed double-occupancy housing pod is 20% less than constructing 40 single-occupancy cells;
- construction costs are based on a direct-supervision housing pod designed according to ACA standards;
- construction and project costs (fees, furniture, etc.) are all borrowed and paid off over 15 years;
- the financing rate and the inflation rate used are 6% and 3%, respectively; and
- officer salaries and fringe packages are calculated at \$25,000 and 35%, respectively.

The cost comparison shows that, under the above conditions, the overall life cycle cost of double occupancy is slightly greater than the cost of single occupancy. These figures exclude economic losses due to mishap in the facility and the operational compromises inherent to double occupancy.

DOUBLE CELLING SINGLE CELLS

One idea frequently considered during planning is to build single-occupancy cells for later use as multiple-occupancy cells. This allows a community to initially commit to single occupancy for standards compliance or better operations, but to accommodate expansion needs quickly and economically at a later date by housing two people in each cell.

A variety of problems are inherent to this approach, however.

- *Safety and security* benefits of single occupancy will be lost.
- Compliance with state or accreditation *occupancy* standards must be maintained.
- Compliance with *cell square footage* requirements may be lost. For example, if the single-occupancy cell provides the required square feet for one inmate (per ACA and some state standards), double **celling** reduces space allocations to half of the minimum square feet per inmate. This same problem can occur with **day-room** space requirements. For example, a dayroom space adequate in square footage to accommodate 8 inmates would now have to accommodate 16.
- Designing for future double occupancy may result in a *waste of space* and money. Referring to the example above, the architect would have to create single-occupancy cells larger in size to meet the minimum required square feet per bed after double occupancy. If

**COST COMPARISON
PROJECT & STAFF COSTS
SINGLE vs. DOUBLE OCCUPANCY**

CONCEPTS/STAFFING:

OCCUPANCY N P E	NUMBER		SUPERVISION SNLE	TOTAL POD STAFFING			SUB-TOTAL	SHIFT RELIEF FACTOR**	TOTAL STAFF
	of BEDS PER POD	# of PODS		Shift 1	Shift 2	Shift 3			
SINGLE	40	1	Direct	1	1	0.5	2.5	1.67	4.2
DOUBLE	40	1	Direct	1	1	1	3	1.67	5.0

* ASSUMES ROVING OFFICER MAKING CELL CHECKS AT NIGHT AFTER LOCK-DOWN AND 50% OF ROVER'S TIME SPENT ON OTHER DUTIES.

** 'SHIFT RELIEF FACTOR' COVERS IMPACT OF WEEKENDS, VACATION, SICK LEAVE, ETC. ON STAFFING A 24-HR/DAY, 7 DAY/WEEK OPERATION.

**LIFE CYCLE COST ANALYSIS:
Project Costs & Staffing**

Project Financing Rate = 6%
Years of Financing = 15

Annual inflation Rate = 3%

OCCUPANCY N P E	CONSTRUCTION			STAFFING COSTS				TOTAL 15 YR. PROJECT & STAFFING COSTS	
	Estimated Construction & Project Costs of Pods Only	Average Annual Payment	Total Financed Construction & Project Cost	Total # of Staff	Officer Salary	Fringe Benefits Factor	Total First Year Cost		15 Year Total w/Annual Inflation
SINGLE	\$1,650,000	\$169,889	\$2,548,328	4.2	\$25,000	35%	\$140,906	\$2,620,704	\$5,169,033
DOUBLE	\$1,320,000	\$135,911	\$2,038,663	5.0	\$25,000	35%	\$169,088	\$3,144,845	\$5,183,508
Difference from Single	-\$330,000	-\$33,978	-\$509,666	+0.8	\$0	-	+\$28,181	+\$524,141	+\$14,475

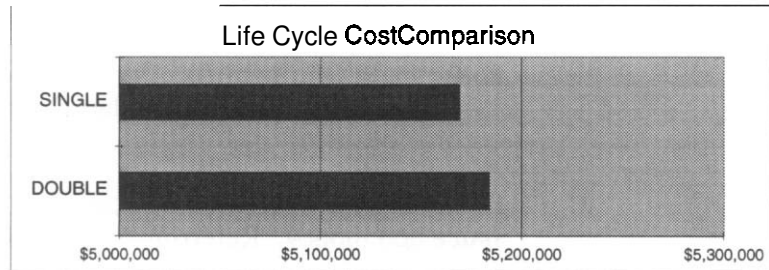

the need to double cell fails to materialize, space and money will have been wasted.

- Other features of the housing unit and jail will have to be provided in *excess* (showers and dayroom toilets) or *over-designed* (ventilation systems, egress elements, plumbing lines) to accommodate possible future double occupancy. This would also result in waste if the double-occupancy option is never exercised.
- Certain *classifications* are not suitable for double occupancy under any circumstances, thus minimizing the capacity expansion benefits.
- The *ratio of staff to inmates* may become imbalanced through later double occupancy. For example, a 10-bed area adequately monitored by a Master Control officer may become too much to monitor if 20 inmates later occupy the area. An adequately supervised 40-bed direct-supervision housing unit may become too much for one officer as an 80-bed unit.

Generally, if sufficient reasons exist to initially adopt a single-occupancy approach to the design of a new jail, those reasons will not likely diminish in the future. If future growth in capacity needs is the reason for creating a double-occupancy option, providing an easy expansion alternative would seem to be the best answer.

CONCLUSION

Financing a jail is difficult and costly. Therefore, the need to create economical solutions is important. However, each jurisdiction must carefully weigh the pros and cons of single vs. multiple occupancy. Multiple occupancy may not be an effective way to achieve construction cost savings if fundamental security, manageability, operational efficiency, and standards compliance are jeopardized by such an approach.

RENOVATING NON-SECURE BUILDINGS INTO JAILS

When confronted with the need for expensive new jail facilities, county leaders frequently ask, "Is there an existing facility that could be renovated for less?" This is a natural question in the face of ever higher costs for jail construction and ever increasing demands for bed capacity. It seems especially logical when communities have existing structures available that are of an institutional character, such as hospitals, schools, and warehouses. Some communities have even looked at abandoned missile sites and grain silos. Regardless of the buildings available, renovation is a possibility that demands serious consideration.

The quest for renovation possibilities has to include an assessment of operational needs. Many existing buildings are eliminated as jail conversion candidates because they do not meet local jail operational requirements and, more specifically, fail to accommodate effective approaches to inmate classification, inmate supervision, and staffing efficiency. It is critical, therefore, that a community clearly establish the character of its future jail operations before -- not after -- it begins a search for renovation candidates. It is not sufficient to simply find a stout old building and assume suitability for renovation as a jail.

A COMMON RENOVATION EXAMPLE

A hospital is an example of a building that seems to be a natural prospect for renovation, but that potential frequently breaks down under operational analysis. The appeal of hospitals tends to be that they are solidly built, have wings that suggest separate housing areas, and have nursing control stations. Further, they have a series of rooms with toilets and sinks on each wing, which could be envisioned as jail cells.

The hospital's basic arrangement, however, can become its greatest weakness. Specifically, most hospitals, including newer ones, **are** linear in design. They consist of long, narrow wings with rooms on either side of a wide corridor (in architectural terms, a "double-loaded corridor"). The hospital's linear nature precludes the kinds of views and control required for direct supervision or indirect surveillance of inmates.

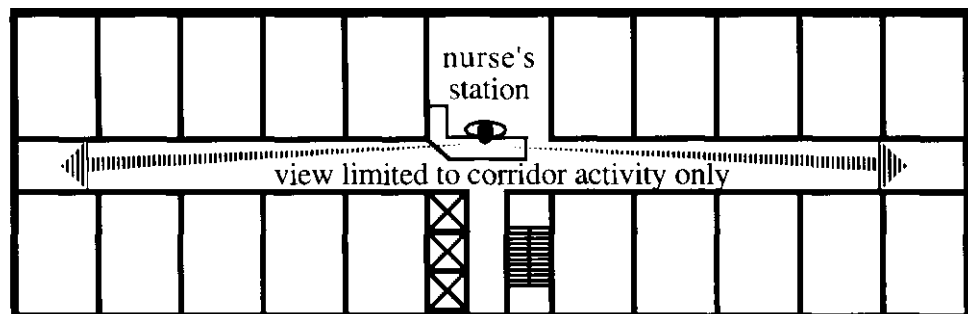

The hospital's potential further diminishes if inmates need to be housed in single-occupancy cells, the minimum size of which is only one-third to one-quarter as big as a normal hospital room. Placing lone inmates in rooms that are 250 to 300 square feet in size is a clear waste of space that also results in low inmate densities per wing and per staff person.

Experience shows that hospitals and even schools tend to work best as low-security operations involving intermittently surveilled dormitory or multiple-occupancy settings. It is rare for the small or even medium-sized jail to have enough inmates of the appropriate type to justify the acquisition and renovation of a hospital or school.

SECURITY CONSTRUCTION

A stout, old building does not necessarily have acceptable security-grade construction and detailing for use as a jail. Therefore, a second hurdle for a renovation candidate to pass is that of security fitness.

Perimeter Issues

Security starts with the building perimeter, or envelope. As outlined in Chapter 3 under "Security Perimeter," the security envelope is three dimensional, including ceilings, roofs, floors, and walls. Each of these elements, if not secure, must be made secure to prevent escapes and contraband passage.

The thick masonry walls found in older institutional or industrial facilities -- which create so much of their appeal -- generally have limited escape resistance. Un-reinforced masonry, no matter how thick, can be penetrated by removing the mortar that binds the masonry together. Masonry walls in jails are generally heavily reinforced and grouted to foil such efforts. Rectifying wall deficiencies in non-secure facilities can be very costly, involving options as varied as 1) applying a new barrier, such as steel plate, over the walls, and 2) creating fenced perimeters beyond the exterior walls.

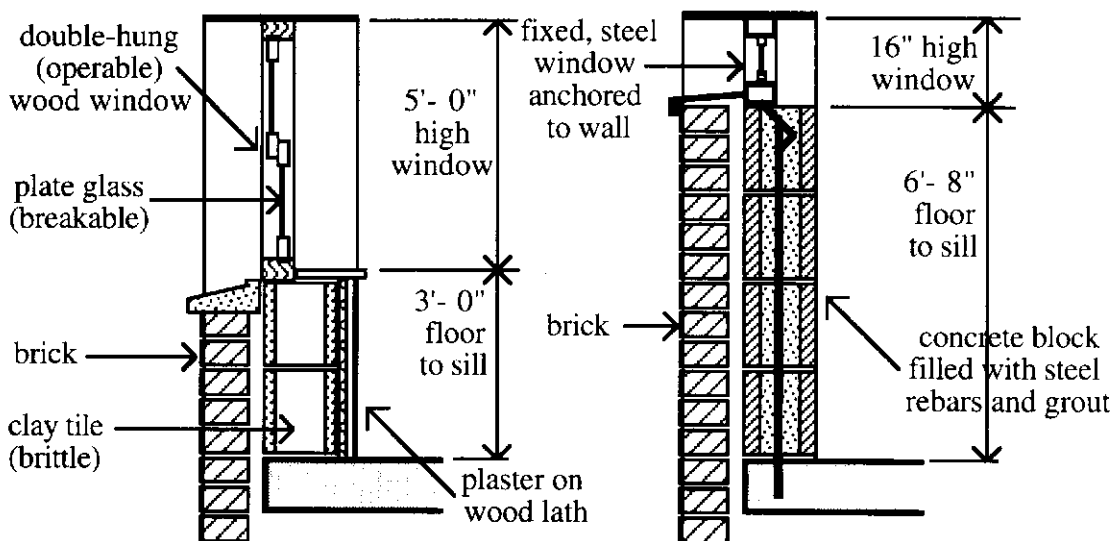

Typical Hospital Wall

Typical Jail Wall

Windows in older institutional buildings tend to be large in expanse, wood or aluminum framed, and of non-security glass. None of these characteristics is conducive to keeping inmates confined. Therefore, major security revisions must be made while retaining the introduction of natural light required by most jail standards and building codes.

Window modification options include:

- re-glazing the entire opening with detention-grade windows and lites (glass),
- filling substantial portions of the opening and glazing the rest with a security-grade detention window to reduce costs and opening size,
- applying dense security-mesh screens over the window opening.

The choice between these options may be influenced by another issue, that of minimizing view conflicts between inmates and the public. Such conflicts are a special concern at night when higher indoor light levels enhance views into the jail.

Windows in older institutional facilities may be operable to ensure adequate ventilation. Operable windows are generally not compatible with a jail's need to prevent escapes, communication with the outside, and contraband passage. Therefore, windows must be sealed and mechanical ventilation or air conditioning systems added or enhanced, a potentially costly activity.

Interior Issues

Interior partitions (walls), doors, and locks of institutional facilities tend to be inadequate for jail security needs, thus requiring total replacement and re-design. Light fixtures, switches, outlets, and lighting controls are rarely up to the security and vandal-resistance requirements of a jail and are inappropriately located for a jail. The same is true of radiators, air diffusers, and thermostats. Toilet and sink fixtures, as well as the water lines, drains, and drain covers serving them, are typically unsuited to the rigors of jail use.

All of these material, hardware, and equipment considerations are essentially what distinguish jail construction from school or hospital construction. More importantly, they define the ultimate safety and security of the physical plant and its occupants. These not-so-obvious fine points are frequently missed when a community is initially impressed with the massiveness of an existing institutional facility.

COSTS

For many people, it is a given that renovation is less expensive than new construction. This explains renovation's principal appeal, exceeding other virtues such as urban renewal and re-use of existing, otherwise abandoned buildings of value. However, substantial savings are frequently unattainable when converting them from non-security uses to secure jail uses. Further, the cost saving issue is complicated by two other considerations: long-term operational costs and acquisition costs.

Construction Costs

If a building appears substantially constructed, the assumption is that the cost of any internal modifications is offset by the money saved by avoiding exterior construction. However, when the costs of a jail are broken down, it becomes clear that only a fraction of the total is spent on the outer shell. Below is a breakdown of jail costs by different components of construction, as reported in *Means Square Foot Costs:*'

	%
Foundation	1.1
Substructure	0.8
Superstructure	11.6
Exterior Closure	12.0
Roofing	0.9
Interior Construction	5.1
Conveying (elevators, etc.)	2.2
Mechanical	25.9
Electrical	6.1
Special Security Construction	34.3
	100.0

Working from that list, the following portions of the building are represented by the shell, that is, the wall, roof, floor, foundation, and key structural elements involved in their creation:

	%
Foundation	1.1
Substructure	0.8
Superstructure	11.6
Exterior Closure	12.0
<u>Roofing</u>	0.9
Total Shell Costs	26.4%

While the shell looks impressive and gives the appearance of great value, it only represents about 26.4% of the total construction costs of a jail. Therefore, about three-fourths of a jail's construction cost is in interior elements.

While saving one-fourth of the construction costs is certainly attractive, additional costs are involved in renovation. A major cost is potentially that of upgrading the shell to security status. That may involve reinforcing walls, building walls within the walls, adding security windows (sometimes by cutting openings through solid walls), and securing the ceiling/roof assemblies. If the particular building being examined has walls, doors, ceilings, and floor finishes that must be removed to make way for the jail design, a demolition cost is added to the cost projection.

Reconfiguring the floor plan to meet jail needs can mean all new walls, ceilings, and floor finishes. It can involve replacing existing conduits, wiring, and power supplies as well as replacing and relocating lighting fix

tures. Reconfiguring can also require altering the location of supply and return air ducts and openings. Re-doing plumbing systems and penetrating existing flooring for new water supply and drain lines can be very costly. Ceilings that are non-security suspended types, such as lay-in ceiling tiles and drywall ceilings, may need complete replacement. New concrete block cell walls can add excessive load to the floor, thus requiring additional structural support. Depending on the building, **making** all of these changes can be a very expensive proposition. These sorts of cost factors can quickly erode the money saved on the shell, thus leading to costs comparable to those of new construction.

Even if conversion is feasible and renovation would save 10% to 20% of the cost of new construction, the **owner/client** is advised to once again consider the operational issues before committing to the renovation project. Given that one is converting a building designed for a different function, the renovation layout is frequently not as effective or efficient as a new design and may have inevitable, unacceptable functional compromises. Other planning concerns, such as the need for expansion, sufficient parking, and public access, may also be compromised.

Operational Costs

Operational costs, particularly those of staffing, are actually the biggest part of a jail's economics. Over the long run, the costs of staffing and operating a jail will far exceed the costs of construction and project financing. Therefore, if the price of cheaper construction is the addition of one or two more 24-hour-a-day, 7-day-a-week posts, the economic impact on a jail can be devastating. The cost analysis on the next page demonstrates the differences over a 20-year life cycle between a new 75-bed jail and a renovated facility of equal capacity. The essential differences are that renovation costs are assumed to be 20% less than new construction and the staffing for the renovated facility is greater by one officer per shift. An average interest rate of 6% and an inflation rate of 3% are used.

Acquisition Costs

A key factor in assessing project costs is the acquisition cost of the site and building being considered for renovation. The purchase price of the facility could be greater than any potential savings over new construction. Also, if private property is purchased, the cost calculation must take into account tax receipts that will be lost once the property is removed from the tax rolls.

CONCLUSION

Local officials should by all means examine renovation options before committing to new construction. Construction cost savings may be there to find within the context of creating secure facilities that meet local needs.

However, experience shows that many renovation options fail to offer the savings initially expected. Or they offer measurable savings at the cost of functionality, safety, or staff efficiency. Enthusiasm for renovation options should be tempered by a reasoned analysis of a building's ability to meet pre-established goals for inmate classification, surveillance/supervision, safety/security, staffing efficiency, and true convertibility prior to public or private commitments.

EXAMPLE: IMPACT OF ADDING ONE POST versus SAVED CONSTRUCTION COSTS

STAFFING:

	Number of of BEDS	TOTAL STAFFING			Sub-Total	Shift Relief Factor'	TOTAL STAFF
		Shift 1	Shift 2	Shift 3			
RENOVATION	75	5	5	4	14	1.67	23.4
NEW	75	4	4	3	11	1.67	18.4

**SHIFT RELIEF FACTOR' ACCOUNTS FOR IMPACT OF WEEKENDS. VACATION. SICK LEAVE. TRAINING TIME. ETC. ON STAFFING A 24-HRIDAY. 7 DAY/WEEK OPERATION

COST ANALYSIS:

Project Financing Ram = **6.00%**
Years of Financing = **15**

Inflation Factor = **1.03**
Years until Opening = **2**

15 YEAR COSTS:

CONSTRUCTION COSTS

STAFFING COSTS

PROJECT TYPE	Estimated Construction Cost (1996 Dollars)	Average Annual Payment	Total Financed Construction Cost	Total # of Staff	1996 Officer Salary	Fringe Benefit Factor	Total First Year Staff Cost (1996 dollars)	15 Year Total Staff Cost w/Annual Inflation; 2 yrs until opening	TOTAL 15 YR. CONSTRUCTION & STAFFING COSTS
RENOVATION	\$3,360,000	\$345,955	\$5,189,323**	23.4	\$25,000	1.35	\$789,075	\$15,569,704	\$20,759,027
NEW	\$4,200,000	\$432,444	\$6,486,654	18.4	\$25,000	7.35	\$619,988	\$12,233,339	\$18,719,993
Differencew/Renovation	-5840.000	-\$86,489	\$1,297,331	+5.0	\$0		+\$169,088	+\$3,336,365	+\$2,039,034

** Renovation saves 20%

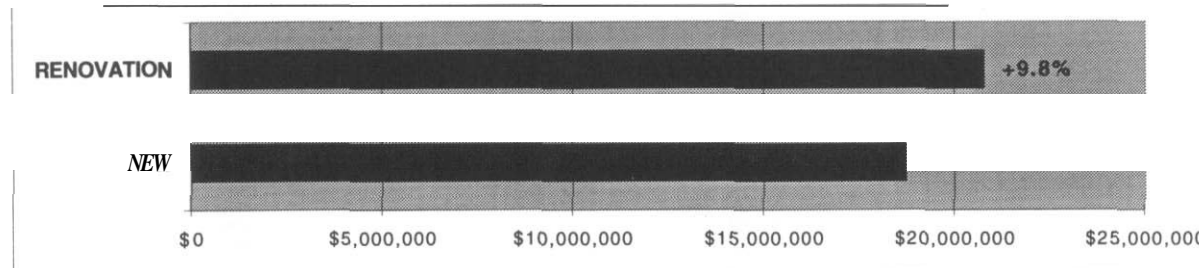

CONSTRUCTION AND PROJECT COSTS

While jail construction costs are significant, they do not represent the total per bed cost paid by a jurisdiction to complete its project. Additional costs significantly increase the expense of the jail. When these costs are added to construction costs, one arrives at the actual *project cost*.

The project cost represents the true cost of building a jail and is not clearly understood by many jurisdictions. Failing to understand the difference between project cost and construction costs has caused jurisdictions to inadequately plan for project funding or for referendums requesting funding.

This, in turn, has led to under-financed projects that provide less capacity than required, less support and program space than needed, and/or a building with less quality and durability than desired. It has also led to embarrassment as it became clear to the public that their local officials did not understand the costs involved in the jail project to which they committed the jurisdiction.

This section identifies the differences between construction and project costs.

CONSTRUCTION COSTS

Construction costs are those costs that relate specifically and exclusively to the construction of the building. They typically include costs for:

- site preparation;
- all materials required for construction;
- all labor required to assemble the building materials;
- all overhead and profit of the contractor(s);
- all equipment and furnishings that are physically attached (fixed) to the building;
basic site improvements, such as landscaping and on-grade parking and sidewalks associated with the building;
- signage; and
- general conditions, such as warranties, permits, insurance, testing, shop drawings, etc.

PROJECT COST

Even though construction costs represent the major part of a jail's cost, many other costs must be incurred to actually get the jail built. These "*other costs*," when combined with construction costs, give the total project cost.

The other costs involved in producing a project can be quite significant. As a rule of thumb, it is wise to plan initially on adding 20% to 30% to the construction costs of the building. That is, if the jail is expected to cost \$5

million to construct, it would be wise to initially add another \$1 million to \$1.5 million to estimate a true project cost. Consequently, a \$5 million construction cost could easily result in a \$6.5 million estimated project cost.

The ratio of project cost to construction costs will vary considerably from jurisdiction to jurisdiction since many variables will dictate that relationship. It is critical, however, for a jurisdiction to conduct *all* of its financial planning, even from the earliest phases of the effort, with an appreciation of all costs involved with the project.

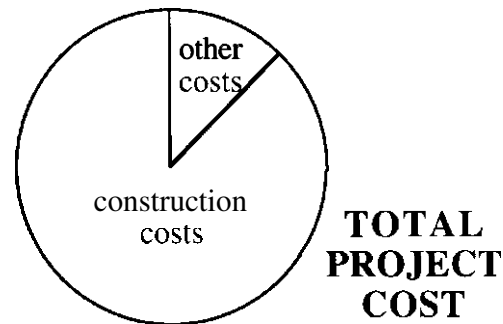

PROJECT COST FACTORS

The most significant and typical cost factors that add to basic construction costs to create a project cost follow.

- **Site acquisition.** This covers the cost of any land and buildings needed to create the jail site.
- **Demolition.** If the acquired site has existing buildings or pavement, retaining walls, etc., the cost of demolishing these structures and disposing of the waste in preparation for future construction must be taken into account.
- **Utilities.** Costs are associated with providing utilities to a site (particularly a remote site) or relocating existing utilities (gas lines, power lines, etc.) that would otherwise interfere with construction.
- **Professional fees.** These are the fees for the architects and engineers who will design the building and develop all of the structural, mechanical, electrical, and civil engineering systems for the building and the site. Fees will vary depending on the size and complexity of the building and whether it is new construction, renovation, and/or an addition. Professional fees also include those for specialists such as food service consultants, interior designers, and construction managers.
- **Reimbursables.** Various expenses are incurred by professionals during the course of the project that are generally billed-back to the owner as a reimbursable expense. Typical reimbursables for an architect, for example, include the costs of travel, report printing, courier services, and construction document reproduction.

- ***Furnishings and equipment.*** All of the desks, chairs, file cabinets, copy machines, computers, and other *unfixed* items that must be purchased for the operation of a building incur additional expenses. Also included in this cost might be such things as potted plants, curtains, and other unattached office decorations.
- ***Site survey.*** Before design can begin, a complete survey of the site must be completed. This survey will establish the location of all buildings, the contours of the site, the location of all utilities, and any easements and setbacks.
- ***Special testing.*** A variety of special tests not typically included in the construction contract will be made before and during construction, such as tests of the soil conditions and selected materials.
- ***Legal fees.*** A variety of legal fees might be paid during the project, such as those for condemning and acquiring properties. Or there may be legal fees involved with developing clear title to land, requesting variances, zoning changes, settling disputes, and negotiating contracts.
- ***Project manager.*** Some jurisdictions think it is wise to hire their own project manager. This representative serves as a liaison between the county, the architect, and the contractors. The project manager helps ensure that the project is proceeding along the lines required by the county. Such a person may also keep a record of design and construction progress for the county as insurance against failures to meet contract demands.
- ***Selling bonds.*** If bonds must be sold to finance a project, a fee is generally paid to the firm or individual arranging for the sale.
- ***Transition.*** To prepare for the transition to the new jail, jurisdictions are well advised to add funding for an existing staff member **and/or** a consultant to focus on the significant amount of work to be done before opening the new building: writing policy, procedures, and staff post orders; establishing a hiring and training schedule; etc. More on this important subject can be found in Chapter 6.
- ***Moving.*** Professional movers are sometimes retained to move **furniture** and equipment from the old building to the new.
- ***Telephone Equipment.*** Telephone equipment is frequently purchased from a vendor or provider outside of the normal construction contract.

PROJECT COST EXAMPLE

Following is an example of a hypothetical project budget, which is based on a \$5 million construction cost and the typical cost factors outlined above. These costs can vary considerably from project to project and may include other factors. This example budget is provided only to enhance the reader's

understanding of the magnitude of the project cost.

<i>Construction costs</i>	\$5,000,000
<i>Other cost factors</i>	
Site acquisition	250,000
Demolition & disposal	25,000
Utility relocation	25,000
Professional fees	350,000
Reimbursables	30,000
Furnishings & equipment	200,000
Site survey	10,000
Testing	10,000
Legal fees	20,000
Project manager	50,000
Transition	50,000
Moving	10,000
Telephone equipment	<u>100,000</u>
Total Other Costs	\$1,130,000
<i>Total project cost</i>	\$6,130,000

In this example, the cost factors other than construction costs are equal to about 22.6% of the cost of construction and represent 18.4% of the total project cost.

CONCLUSION

In planning the financial aspects of a proposed project, it is important to understand all operational and construction-related costs to be incurred. Only then can a jurisdiction make informed decisions about the size and nature of the project to be developed and adequately prepare for the expenses to come and the revenues needed to cover them.

6

MAKING A BUILDING WORK

6 MAKING A BUILDING WORK

A common mistake made by many local government officials is to think that their role in the development of a new jail ends with the completion of the architectural phase of the project. Others mistakenly feel that their role is ended before construction documents are complete because they cannot contribute much to that process. The client must remember that a jail facility's security and overall success depend largely on staff and management. In fact, attention to operational and transition issues at this point will yield major benefits later. Failure to plan for the opening of new facilities has led to some embarrassing problems:

- New facilities opened only to discover that recruitment, selection, training, and funding of new staff had been overlooked.
- New jails opened only to discover that staff had little familiarity with the more complex equipment and systems in their modern, high-technology facility. In one instance, inmates were able to simply walk out the front door because staff did not fully understand the door status indicator system.
- Considerable damage to new facilities resulted because they were seriously understaffed. Planned services and programs and classification are often never implemented because they are simply not given a priority within the transition process.
- Numerous new jails quickly became overcrowded for reasons other than being built too small. Their size was based on assumptions about continuation or implementation of population-reducing alternatives to incarceration that either were not implemented after the new jail opened or were subsequently discontinued.
- New facilities opened only to encounter considerable disruption, unrest, and verbal and physical confrontations among inmates in the housing units. Staff had little knowledge of a classification system that was intended to separate the "violent" from the "non-violent" and the "prey" from the "predators."

These examples of facilities that did not "work" well were not all necessarily poorly planned, designed, or constructed. Rather, preparation for opening them was inadequate or key planning assumptions were never implemented.

The purpose of this chapter is to alert those involved in new jail design projects to those post-design activities that must be pursued if the architecture of the new jail is to solve the problems they had hoped it would. It is critical to remember that buildings only contain behavior and that it is incumbent upon management and line staff to control the behavior of those confined.

Assuming that good procedural operations, adequate staffing, and effective staff training are vital to the success of a jail design, it is strongly recommended that local officials and jail staff undertake a series of critical non-architectural tasks in preparing for the opening of a new jail. These tasks are essential to the success of a new jail in terms of minimizing initial and long-term operating problems and increasing the satisfaction of the owner, the user, and the public. Without executing these tasks, a city or county will not be prepared to operate its new jail since the jail will probably be vastly different in size, technology, and complexity than the one it replaced. The following post-design tasks are viewed as essential to making a smooth transition from old to new facilities.

POLICY AND PROCEDURE DEVELOPMENT

A vital element in operating a jail that avoids incurring unnecessary liability risks is a comprehensive set of written operational policies and procedures. Well-researched and drafted policies and procedures tailored to a particular facility serve the jail administration in many ways. Primarily, they provide an essential training tool for all jail officers that ensures consistency of performance, provides guidance for staff when administrative personnel are not immediately on the scene in an emergency, and provides protection for the county against liability when individual acts can be shown to be outside of the prescribed practices dictated by the policy and procedure manual. No facility, particularly no new one, should operate without a well-researched and knowledgeably prepared set of written policies and procedures that are specifically written for the facility and are compliant with current case law, professional practices, local statutes, and state standards.

The policy and procedure development process requires heavy involvement by local jail staff. It includes the following tasks:

- outline the issues and topics to be covered;
- review past policy and procedure manuals for relevancy (errors, omissions, deletions, or additions); research and document applicable case law, state statutes, and recommended professional practice;
- hold discussions, during which key policy decisions are made;
- tailor all policies and procedures to the specific jail design;
- draft the initial policy and procedure manual;
- review, comment, and modify until the final document is complete;
- to the degree possible, "field test" the draft policies and procedures by walking staff through them on facility models or plans; and develop a test on the policies and procedures to be administered to all staff (veteran and new) once training has been completed.

FINAL STAFFING PLAN AND STAFF POST ORDERS

A final staffing plan for the new jail, which is consistent with the final facility design and the revised policies and procedures, must be prepared. This includes documenting staff needs by function, number, and shift, including consideration of the impact of weekends, holidays, sick leave, training leave, absenteeism, and other factors that impact the need for post coverage.

Detailed post orders indicating precise responsibilities and tasks for each post and position indicated in the final jail staffing plan and the written policies and procedures must be prepared and implemented in the same manner as operational policies and procedures. While the policies and procedures provide staff direction for what is to be done, why it is to be done, and how it will be done, post orders detail what tasks are to be done, when they are to be done, and who will do them.

BUDGET PREPARATION AND APPROVAL

A first-year operational budget based on finalized staffing levels and anticipated costs of opening the new building (overtime, initial supply expenses for new articles, moving, basic supplies for larger populations, new uniforms, etc.) should be developed as far in advance of opening as possible. Approval from the necessary government **bodies** must be secured.

STAFF RECRUITMENT AND SELECTION

Staff recruitment and selection have evolved from a very simple process to one that often involves the administration of a variety of psychological screening and aptitude measurement instruments and oral interviews. Haphazard recruitment and selection can seriously jeopardize the operation of a new jail and expose the local government to tremendous liability. Jurisdictions should execute this process according to a plan consistent with formal personnel practices and **state/federal** laws governing employment.

Too many jurisdictions do not devote sufficient time to recruitment and selection. Plan to allow at least six months for this critical process.

STAFF TRAINING

New and current officers need training in the operation and philosophy of the new jail. Such training should focus on current case law, techniques of managing inmates, and, most importantly, on the application of the new policies and procedures that have been written and must now be implemented. A major aid to the training program is the use of a three-dimensional working model of the floor plan, which helps staff understand and visualize the spatial relationships and movement patterns in the new facility.

Emphasis on training jail officers in policies and procedures in advanced inmate supervision and management techniques and in the operation of the new electronic equipment and hardware in the jail is critical. Such training should be in addition to any mandatory basic training required by the state. The training should also emphasize practical exercises, such as conducting emergency facility evacuation drills and responding to "officer down" situations. Testing should be administered to ensure adequate understanding and performance of just how the new facility equipment and physical plant are intended to operate and to identify areas where staff have particular questions or problems. New staff should be hired well in advance of the facility's scheduled opening so that they can participate in mandatory state training programs and local training specific to the new facility.

MOVE LOGISTICS

A detailed plan for making the actual move to the new jail and the sequencing steps involved must be prepared. Move logistics include such considerations as means of transporting inmates to the new facility, when to begin moving inmates and equipment, how to do so in such a way that both staff and inmates can move gradually and smoothly while closing down the old jail, arrangements for enhanced security during transport, plans for covering two facilities during the inmate transfer, and numerous other related matters.

- writing policies, procedures, and post orders;
- preparing and delivering training programs for new staff, existing staff, supervisory staff, etc.;
- scheduling and conducting public tours;
- assisting in interviewing potential staff;
- testing equipment and observing its installation for training of staff on its operation;
- preparing the overall Transition Master Plan and schedules;
- orienting other law enforcement agencies, vendors, and other facility users for interaction at the new facility;
- finalizing and directing the actual move;
- preparing orientation material for inmates who will be transferred to the new facility;
- conducting facility shakedowns and "walking through" all operational scenarios;
- coordinating with maintenance staff on the operation of mechanical and electrical systems;
- **informing** existing staff of construction progress and of proposed changes in operational procedures;
- making on-site facility inspections during construction;
- developing emergency plans for evacuation that include inmate retention, emergency staff provisions, and fire drills for new staff;
- documenting that all new furniture, equipment, and forms have been ordered and installed.

New facility mechanical and electrical systems are typically far more complex than those found in other existing county buildings and the old jail. It is of critical importance that existing or additional county maintenance personnel who will be assigned to the new facility have an opportunity to monitor the on-site installation of mechanical, plumbing, and electrical systems. It is also important to involve local facility maintenance staff in all post-design activities involved in the construction phase.

SUMMARY

If the facility is to realize its full potential and serve the community as intended, team work, good communication, cooperation, and full commitment **& are** required from all those who were involved in pre-activation (planners, designers, contractors, and transition staff) as well as those involved in the activation and operation of the facility (the funding authority, management and line staff, support staff, maintenance personnel, volunteers, and the community). While not an easy proposition, failure is not an option.

USER FEEDBACK FORM

Please complete this form to assist the National Institute of Corrections in assessing the value and utility of its publications. Mail to:

Publications Feedback
National Institute of Corrections
320 First Street, NW
Washington, D.C. 20534

1. What is your general reaction to this document?

Excellent Good _____Average _____Poor _____Useless

2. To what extent do you see the document as being useful in terms of:

Very Useful Of Some Use Not Useful

Providing new or important information
Developing or implementing new programs
Modifying existing programs
Administering ongoing programs
Providing appropriate liaisons

3. Do you feel that more should be done in this subject area? If so, please specify what types of assistance are needed.

4. In what ways could the document be improved?

5. How did this document come to your attention?

6. How are you **planning** to use the information contained in the document?

7. Please check one item that best describes your affiliation with corrections or criminal justice. If a governmental program, please also indicate level of government.

____ Dept. of corrections or prison
____ Jail
____ Probation
____ Parole
C o m m u n i t y corrections
C o u r t
J u v e n i l e justice

____ Police
____ Legislative body
____ Professional organization
____ College/university
____ Citizen group
____ Other government agency
____ Other (please specify) _____

Federal State County Local Regional

8. **OPTIONAL:**

Name _____ Agency _____

Address _____

Telephone No. () _____

National Institute of Corrections

Advisory Board

Shay Bilchik
Administrator
Office of Juvenile Justice
and Delinquency Prevention
Washington, D.C.

Michael Brown
Attorney
New Hampshire Department of Corrections
Concord, New Hampshire

Norman A. Carlson
Stillwater, Minnesota

Sharon English
Deputy Director
California Youth Authority
Office of Prevention and Victims' Services
Sacramento, California

Newman Flanagan
Executive Director
National District Attorneys Association
Alexandria, Virginia

Michael Gaines
Chairman
U.S. Parole Commission
Chevy Chase, Maryland

Olivia Golden
Assistant Secretary for Children and Families
Department of Health and Human Services
Washington, D.C.

James H. Gomez
Deputy Executive Officer
California Public Employees Retirement System
Sacramento, California

Norval Morris
Professor
University of Chicago Law School
Chicago, Illinois

Barry J. Nidorf
Chief Probation Officer, Retired
Los Angeles Probation Department
Granada Hills, California

Gayle Ray
Sheriff
Davidson County
Nashville, Tennessee

Laurie Robinson
Assistant Attorney General
Office of Justice Programs
Washington, D.C.

Kathleen Hawk Sawyer
Director
Federal Bureau of Prisons
Washington, D.C.

Arthur M. Wallenstein
Director
King County Department of Adult Detention
Seattle, Washington

Odie Washington
Director
Illinois Department of Corrections
Springfield, Illinois

Judge Rya W. Zobel
Director
Federal Judicial Center
Washington, D.C.