

REPLACEMENT PARTS, BODY PARTS & ACCESSORIES FOR JEEP®



OMIX-ADA, Inc.

OVER 9,000 PRODUCTS INSIDE



460 HORIZON DR, SUITE 400
SUWANEE, GA 30024 USA

TEL: (770) 614-6101 OR 1-800-449-6649

FAX: (770) 614-6069 OR 1-800-808-6649

WEB: WWW.OMIX-ADA.COM EMAIL: INFO@OMIX-ADA.COM

OMIX-ADA
MANUFACTURER & WHOLESALE DISTRIBUTOR

CATALOG P/N 12503.01
© COPYRIGHT OMIX-ADA, INC.

JEEP® REPLACEMENT PARTS, BODY PARTS AND ACCESSORIES



1941 MB TO 2006 TJ RUBICON UNLIMITED, AND EVERYTHING IN BETWEEN!

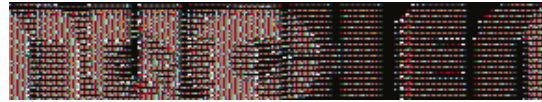

**This Emblem Is Mopar's "Seal Of Approval"
That The Product Meets Their Standards
And Is Truly A Licensed Product**

PARTS IDENTIFIED WITH THE MOPAR AUTHENTIC RESTORATION PRODUCT EMBLEM ARE THE ONLY PARTS IN THIS CATALOG OFFICIALLY AUTHORIZED AND LICENSED BY DAIMLERCHRYSLER.

THIS CATALOG REPRODUCED UNDER LICENSE FROM OMIX-ADA INC.

PARTS IDENTIFIED WITH THE MOPAR AUTHENTIC RESTORATION PRODUCT EMBLEM ARE THE ONLY PARTS IN THIS CATALOG OFFICIALLY AUTHORIZED AND LICENSED BY DAIMLERCHRYSLER.

ALL RIGHTS RESERVED. NO PART OF THIS CATALOG MAY BE REPRODUCED BY ANY MEANS, ELECTRONIC OR OTHERWISE, WITHOUT EXPLICIT WRITTEN AUTHORIZATION FROM OMIX-ADA, INC. © COPYRIGHT OMIX-ADA, INC.

THIS CATALOG IS BEING DELIVERED AS IS AND OMIX-ADA, INC. OR LICENSEE MAKE NO WARRANTIES, EXPRESSED OR IMPLIED, ON MERCHANTABILITY OR FITNESS FOR ANY PARTICULAR PURPOSE. OMIX-ADA, INC. OR LICENSEE DISCLAIM ALL LIABILITY FOR DIRECT OR INDIRECT DAMAGES ARISING FROM THE USE OR PERFORMANCE OF THIS CATALOG. OMIX-ADA OR LICENSEE ARE NOT RESPONSIBLE FOR TECHNICAL ERRORS, OMISSIONS OR PRINTING ERRORS. PRICES, AVAILABILITY AND BRAND NAMES ARE SUBJECT TO CHANGE WITHOUT NOTICE.

JEEP®, WILLYS®, AMC™, WRANGLER™, CHEROKEE™, GRAND CHEROKEE™, LIBERTY™, CJ™, YJ™, XJ™, TJ™, ZJ™, WJ™, SJ™, KJ™, JEEP® GRILLE DESIGN AND OTHER NAMES USED IN THIS CATALOG ARE REGISTERED TRADEMARKS OF DAIMLERCHRYSLER CORP. OMIX-ADA OR ITS LICENSEES ARE NOT AFFILIATED WITH DAIMLERCHRYSLER. ALL PARTS LISTED ARE AFTERMARKET REPLACEMENT PARTS. PART NUMBERS, ILLUSTRATIONS AND IMAGES USED FOR REFERENCE PURPOSE ONLY. NO IMPLICATION IS MADE THAT THESE ARE ORIGINAL EQUIPMENT PARTS, FROM THOSE SOURCES WHOSE PART NUMBERS ARE USED HERE FOR REFERENCE OR THAT THEY ARE APPROVED BY THOSE COMPANIES.

Nothing represents a Jeep® more than its very name! It's just not the same unless, well, it says "Jeep®"! The visual appearance of the name stands for a legacy and history that no other vehicle in the world can match. Now you can return your Jeep® to its original markings with these stamped—Hoods, Tailgates, Back Panels, Toolboxes, Body Tubs, Valve Covers, Grilles, Grille Covers and Dash Pads!



DMC-663188



DMC-670969

Willys® and Jeep® Marked Body Parts, Grilles and Grille Overlays

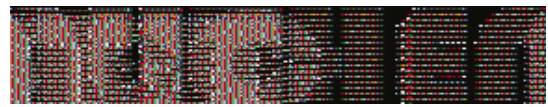

This Emblem Is Mopar's "Seal Of Approval" That The Product Meets Their Standards And Is Truly A Licensed Product

PARTS IDENTIFIED WITH THE MOPAR AUTHENTIC RESTORATION PRODUCT EMBLEM ARE THE ONLY PARTS IN THIS CATALOG OFFICIALLY AUTHORIZED AND LICENSED BY DAIMLERCHRYSLER.

Replaces Part No.

Hood Products: AUTHENTIC RESTORATION PRODUCT

- "Willys®" Marked Hood: For 1946-53 CJ2A, CJ3A
- "Willys®" Marked Hood: For 1953-64 CJ3B

Windshield Frame Products: AUTHENTIC RESTORATION PRODUCT

- "Willys®" Marked Windshield Frame: For 1946-53 CJ2A

Tailgate Products: AUTHENTIC RESTORATION PRODUCT

- "Willys®" Marked Tailgate: For 1946-71 CJ2A, CJ3A/3B, CJ5, CJ6
- "Willys®" Marked MB Back Panel
- "Jeep®" Marked Tailgate: For 1969-83 CJ5
- "Jeep®" Marked Tailgate: For 1976-86 CJ7

Body Tub Products: AUTHENTIC RESTORATION PRODUCT

- "Jeep®" Marked Body Tub: For 1955-69 CJ5
- "Jeep®" Marked Body Tub: For 1970-71 CJ5
- "Jeep®" Marked Body Tub: For 1972-75 CJ5
- "Jeep®" Marked Body Tub: For 1976-83 CJ5*
- "Jeep®" Marked Body Tub: For 1976-86 CJ7*

Toolbox Products: AUTHENTIC RESTORATION PRODUCT

- "Jeep®" Marked Toolbox: For 1946-75 CJ's

Valve Cover Products: AUTHENTIC RESTORATION PRODUCT

- "Jeep®" Marked Valve Cover: For 1981-87 6 CYL Engine
- "Jeep®" Marked Valve Cover, Pair: For 1966-91 V8 AMC Engine

Dashpad Products: AUTHENTIC RESTORATION PRODUCT

- "Jeep®" Marked Dashpad: For 1976-86 CJ's. Black
- "Jeep®" Marked Dashpad: For 1976-86 CJ's. Light Gray - paintable

Grille Products: AUTHENTIC RESTORATION PRODUCT

- For CJ2A - Early - 1945-46
- For CJ2A - Late - 1947-49
- For CJ3A - 1949-53
- For CJ3B - 1959-64 With "Willys®" Mar
- For CJ5, CJ6 - 1955-71
- For CJ5, CJ7, CJ8 - 1972-86



DMC-5752656

Grille Cover Products: AUTHENTIC RESTORATION PRODUCT

- Stainless Steel Grille Overlay: For 1972-86 CJ5, CJ7, CJ8
- Stainless Steel Grille Overlay: For 1987-95 YJ

- DMC-670969
- DMC-681334

- DMC-663628

- DMC-663188
- DMC-2758
- DMC-685459
- DMC-5454025

- DMC-680637
- DMC-680637-VC
- DMC-680637-VD
- DMC-5461335
- DMC-5464362

- DMC-3227K

- DMC-6914
- DMC-6920

- DMC-5760458
- DMC-5760459

- DMC-663536
- DMC-668124
- DMC-673149
- DMC-815398
- DMC-815385
- DMC-5752656

- DMC-5752247-ST
- DMC-55026587-ST



Windshield Frames:

- "Willys®" Marked Frame: For CJ2A
- DMC-663628



"Jeep®" Marked Tailgate



DMC-6914



DMC-5760458



DMC-5752247-ST



DMC-55026587-ST

GRILLE COVERS ARE REPRODUCTION ITEMS

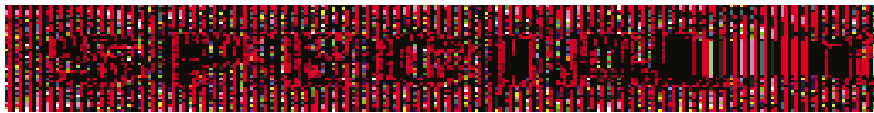

Can't Find What You Need For Your Jeep®?
Looking For Non-Jeep® Parts - Like GM, Ford, Dodge, Toyota, Nissan etc.?

Now You Can Get Any Product You Need From The Following List Of
Manufacturers - All At Competitive Prices!

Choose from these trusted name brands: CONTACT US FOR MORE DETAILS!



AEM
Brute Force Intake
Systems



AGR
Steering Boxes, Pumps
& Shafts



ARB
Bumpers, Air Lockers

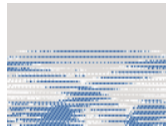

AUTO VENT SHADE
Vent Visors, Bug Deflec-
tors



BESTOP
Soft & Hardtops, Seats,
Storage & Rack Systems



BUSHWACKER
Fender Flares, Bedrail &
Tailgate Caps



ELECTRIC-LIFE
Power Window Kits



FLEX-A-LITE
Cooling Fans, Oil Coolers



GRANT
Steering Wheels

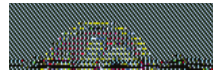

KC HiLites
Auxiliary Lighting



Kentrol
Stainless Steel Parts &
Accessories



K & N
Oil & Air Filters



LOCK-RIGHT
Differential Lockers



MEAN GREEN
Starters & Alternators



MOPAR
Original Equipment
Parts & Accessories



MSD
Ignition Products



NIFTY
Carpeting Products



PACESSETTER
Performance Exhaust
Products



PAINLESS
Wiring Harness
Products

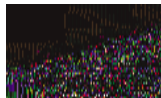

PAVEMENT ENDS
Soft & Hardtops

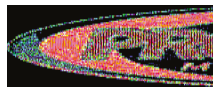

PROTHANE
Performance Urethane
Components



POWERTRAX
Differentials & Traction
Systems



SKYJACKER
Suspension Products



SUPERWINCH
Winch, Hub, Step and
Lighting Products



**TOTALLY
STAINLESS**
Fastners & Components

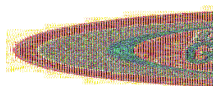

TRACHTECH
Differential & Traction
Products



TUFFY
Security Storage Prod-
ucts

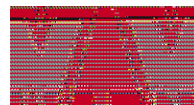

WARN
Winches, Hubs, Axles,
Fender Flares, Steps &
Lighting Products

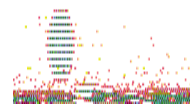

WARRIOR
Winches, Hubs & Light-
ing Products



XENON
Fender Flares



REPLACEMENT JEEP® SEATS

LOOKING FOR A HIGH QUALITY, COMFORTABLE AND AFFORDABLE REPLACEMENT FOR YOUR OLD FACTORY SEATS, WELL WE HAVE YOUR SOLUTION

MADE OF HIGH QUALITY TUBULAR STEEL, POWDER COATED FRAMES WITH HEAVY DUTY SPRINGS AND FIRM PADDING FOR SUPPORT. THESE NEW SEAT WILL GIVE YOU COMFORT AND DURABILITY ALL DAY LONG, WHETHER YOU ARE ON THE ROAD OR THE TRAIL.

1976-95 CJ/YJ STANDARD FRONT BUCKET SEAT

ALSO FITS 1997-02 TJ WHEN INSTALLED WITH ADAPTER BRACKETS

STOCK NO.	COLOR
13401.01	BLACK
13401.04	TAN
13401.05	BLUE
13401.07	NUTMEG
13401.09	GREY
13401.15	BLACK-DENIM
13401.37	SPICE



1976-95 CJ/YJ RECLINING FRONT SEAT

ALSO FITS 1997-02 TJ WHEN INSTALLED WITH ADAPTER BRACKETS

13402.01	BLACK
13402.04	TAN
13402.07	NUTMEG
13402.09	LIGHT GREY
13402.15	BLACK-DENIM
13402.37	SPICE



1976-95 CJ/YJ RECLINING FRONT SEAT W/ HEADREST

ALSO FITS 1997-02 TJ WHEN INSTALLED WITH ADAPTER BRACKETS

13403.09	LIGHT GREY
13403.15	BLACK-DENIM
13403.37	SPICE



1955-95 CJ/YJ STANDARD FIXED REAR SEAT

13461.01	BLACK
13461.04	TAN
13461.07	SPICE
13461.09	LIGHT GREY
13461.15	BLACK-DENIM

1976-95 CJ/YJ FOLD AND TUMBLE REAR SEAT

13462.01	BLACK
13462.04	TAN
13462.07	SPICE
13462.09	LIGHT GREY
13462.15	BLACK-DENIM
13462.37	SPICE



1997-02 TJ FOLD AND TUMBLE REAR SEAT

13463.09	LIGHT GREY
13463.15	BLACK-DENIM
13463.37	LIGHT GREY

1976-95 CJ & WRANGLER SEAT BRACKET, DRIVER SIDE (LH)	NEW	13201.01
1976-95 CJ & WRANGLER SEAT BRACKET, PASSENGER SIDE (RH)	NEW	13201.02
1976-95 CJ & WRANGLER SEAT SLIDER KIT (SINGLE KIT)	NEW	13201.03
1997-02 WRANGLER SEAT ADAPTER, DRIVER SIDE (LH)	NEW	13201.11
1997-02 WRANGLER SEAT ADAPTER, PASSENGER SIDE (RH)	NEW	13201.12
1997-02 WRANGLER ADAPTER KIT (SINGLE SEAT), LEFT OR RIGHT	NEW	13201.13



ACCESSORIES

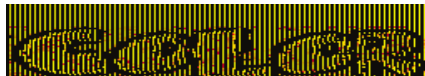

Black 01	White 02	Salmon 03	Tan 04	Blue 05	Mint 06	Nutmeg 07
Charcoal 09	Sand 10	Almond 14	B-Denim 15	Khaki 16	Dark Tan 33	
Blk Dia 35	Khaki Dia 36	Spice 37	W-Denim 52	Red 53	Orchid 55	Yellow 57
Sunlighter 38	Mickey 88	Green 89	Leads 99			

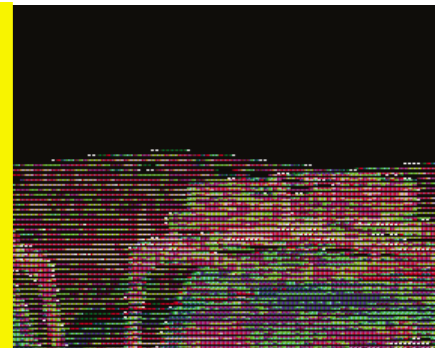

Bestop® Trailmax™ front seats



Fit all Jeep® Models from 1976-2002*. All Bestop® Trailmax™ seats are shipped pre-assembled with mounting hardware. Available in factory matched vinyl or vinyl with fabric inserts. Each sold separately. Add color code to end of part number when ordering.

* 1997-02 TJ Models require adapter #51256-01 for each seat.

trailmax™ classic



Patterned after the early model factory Jeep® seats this seat has all 21st century features. This fixed lowback seat boasts an Atlas Frame™, V-ROR™ springs and Ultimate Foam™ to ensure a comfortable trail ride while staying true to the period. Available in vinyl only.

ACCESSORIES

trailmax™ sport



A step up from the standard Trailmax™ seat, the Trailmax™Sport boasts all the same features of the standard seat but adds an infinitely adjustable backrest and rear elastic storage pocket. Available in either all vinyl or vinyl with fabric inserts.

For 1976-02 CJ and Wrangler

Trailmax Sport Vinyl
Stock No. : 39337-##
Color Code: 01, 04, 09, 15, 37

Trailmax Sport Fabric
Stock No. : 39347-##
Color Code: 04, 09, 15, 37

For 1976-02 CJ and Wrangler

Stock No: 39335-##
Color Code: 01, 04

trailmax™



This fixed highback seat is Bestop's® Entry level Trailmax™ seat. Atlas frame™, built-in headrest, V-ROR™ springs and Ultimate foam™ make this one of the best values in aftermarket seating. Available in vinyl only.

For 1976-02 CJ and Wrangler
Stock No. : 39334-##
Color Code: 01, 04, 09, 15, 37

trailmax™ aquasport



The Trailmax™ Aquasport seat offers the cushy feeling and water protection of wetsuit type neoprene with all the features of the Trailmax sport seat. A must for any serious watersports fanatic.

For 1976-02 CJ and Wrangler
Stock No. : 39327-##
Color Code: 15, 37

trailmax™ pro



The Trailmax™Pro is Bestop's flagship seat. Larger side bolsters with bolster boosters and sculpted lumbar support increase comfort tremendously. Add an adjustable headrest, map pocket and the performance features found in all Bestop seats and you have one of the best seats on the market today.

1976-02 Wrangler

Trailmax Pro Vinyl
Stock No. : 39336-##
color code: 01, 09, 15, 37

Trailmax Pro Fabric
Stock No. : 39346-##
color code: 09, 15, 37

Anatomy of a Trailmax™ Pro seat



1997-02 TJ Vehicles Require Adapter Bracket # 51256-01



trailmax™ thermal pro



How do you keep warm in the dead of winter? With Bestop's ThermalPro seat, heating elements in the back and seat provide an extra level of warmth at the flip of a switch. The ThermalPro includes all the features of Bestop's standard Pro seats. Hardwires directly to vehicles electrical system.

For 1976-02 CJ and Wrangler

Trailmax ThermalPro Vinyl
Stock No. : 39736-##
Color Code: 01, 09, 15, 37

Trailmax ThermalPro Fabric
Stock No. : 39746-##
Color Code: 09, 15, 37

1976-95 CJ and Wrangler Seat Riser, left
Stk. # 51253-01

1976-95 CJ and Wrangler Seat Riser, right
Stock No. : 51254-01

1976-95 CJ and Wrangler Seat Slider (Single Seat)
Stock No. : 51255-01

1997-02 CJ and Wrangler Seat Adapter Bracket (Single Seat)
Stock No. : 51256-01

BESTOP® TRAILMAX™ REAR SEATS



**TRAILMAX™ REAR SEATS
FOR 1955-95 CJ & YJ WRANGLER:**

Stock No.

TRAILMAX FOLD & TUMBLE VINYL 1955-95 CJ & WRANGLER COLOR CODE: 01, 04, 09, 15, 37	39333-##
---	----------

TRAILMAX FOLD & TUMBLE FABRIC 1955-95 CJ & WRANGLER COLOR CODE: 04, 09, 15, 37	39343-##
--	----------

TRAILMAX FIXED REAR SEAT VINYL 1955-95 CJ & WRANGLER COLOR CODE : 01, 04, 09, 15, 37	39353-##
--	----------

TRAILMAX AQUA FOLD & TUMBLE 1955-95 CJ & WRANGLERS COLOR CODE: 15, 37	39323-##
---	----------

**TRAILMAX™ FOLD & TUMBLE REAR
SEATS FOR 1997-02 TJ WRANGLER:**

TRAILMAX FOLD & TUMBLE VINYL 1997-02 WRANGLER COLOR CODE: 09, 15, 37	39331-##
--	----------

TRAILMAX FOLD & TUMBLE FABRIC 1997-02 WRANGLER COLOR CODE: 09,15, 37	39341-##
--	----------

TRAILMAX AQUA FOLD & TUMBLE 1997-02 WRANGLER COLOR CODE: 15, 37	39321-##
---	----------

BESTOP® SUNRIDER™

The Sunrider is a fully convertible top with a unique cam-action header to allow the front portion to open like a sunroof. Utilizes Bestop's patented belt rail system for a draft-free fit. An easy open tailgate design (86-02 Wranglers only) allows tailgate to be opened without unzipping the rear window. With sealed seams, factory matched colors and YYK zippers this top is feature packed. Designed to work with full steel doors, Supertop 1/2 and 2-piece doors and TJ factory upper soft doors (will not work with factory CJ/YJ soft upper doors). Installation video included. One year warranty. Made in the USA. *DOORS SOLD SEPARATELY*



Stock No.

1976-95 CJ-7 & YJ WRANGLER* COLOR CODE: 01, 09, 15, 37	51698-##
---	----------

1997-02 WRANGLER COLOR CODE: 09, 15, 33, 37	51699-##
--	----------

2003-06 WRANGLER COLOR CODE: 35, 36	51719-##
--	----------

*note: YJ/CJ vehicles with softtop must remove existing window channel to allow the Sunrider header system to function properly.

BESTOP® HALFTOP™

The Halftop is similar to the Bikini, Windjammer, Duster combo except it has a completely sealed cockpit. Allows more efficient interior heating and cooling and features a fold-back sunroof and zip-out rear window (complete with mesh screen) for open-air motoring. This top has all the features that make Bestop the leader in the industry: color-matched fabric, galvanized & powder-coated hardware, Bestop's belt-rail attachment and patented tailgate system. One year warranty. Made in the USA. *DOORS NOT INCLUDED*



Stock No.

1997-02 WRANGLER COLOR CODE: 15, 37	53809-##
--	----------

1997-02 WRANGLER W/HARDTOP* COLOR CODE: 15, 37	53819-##
---	----------

1992-95 YJ WRANGLER COLOR CODES: 15, 37	53818-##
--	----------

*note: for P/N 53809 the factory door surrounds and tailgate bar are required for installation.

BESTOP® SUPERTOP™

The Supertop is the industry standard in replacement softtops. The patented belt-rail mounting system ensures a tight, draft-free fit and it does not require drilling any snap holes. Adjustable bows prevent sagging and buffeting while zip out rear and side windows allow near instant open-air driving. Bestop's unique tailgate bar allow access to the trunk without unzipping the rear window (86-02 Wranglers only). Other features include: Haartz® mildew and stain resistant fabric, factory-matched colors, YYK Zippers and powder coated hardware. Each top comes with hardware, fabric and windows. One year warranty. Made in the USA



>>> NEW <<<

ACCESSORIES

SUPER TOP W/ 2-PIECE DOORS INCLUDED

1955-75 M-38A1 & CJ-5 ¹	51595-##
Color Codes: 01, 04, 15	
1976-83 CJ-5 ¹	51597-##
Color Codes: 01, 04, 09 or 15	
1976-86 CJ-7 ¹	51598-##
Color Codes: 01, 04, 09, 15	
1980-95 CJ-7 & YJ WRANGLER ²	51603-##
Color Codes: 09, 15, 37	
1997-02 TJ , WRANGLER ³	51703-##
Color Codes: 15, 37	
2003-06 TJ , WRANGLER ³	NEW 51713-##
Color Codes: 35, 36	

- 1=Doors come with paddle handles and Door strikers
- 2=Doors come with rotary-type paddle handles for steel door pins
- 3=Doors come with paddle handles for factory door pins

SUPERTOP WITHOUT DOORS (FOR USE WITH FACTORY FULL STEEL DOORS)

1976-95 CJ-7 & YJ WRANGLER	51599-##
Color Codes: 01, 09, 14, 15, 37	
1997-02 TJ , WRANGLER	51609-##
Color Codes: 09, 15, 33, 37	
2003-06 TJ , WRANGLER	51709-##
Color Codes: , 35, 36	

SUPERTOP REPLACEMENT SKIN W/ FABRIC (NOT UPPER DOOR SKINS)

1976-95 CJ7 & YJ CLEAR WINDOWS	NEW 55799-##
Color Codes: 15,37	
1976-95 CJ7 & YJ TINTED WINDOWS	NEW 55729-##
Color Codes: 15,37	
1997-02 TJ CLEAR WINDOWS	NEW 55609-##
Color Codes: 15,37	
1997-02 TJ TINTED WINDOWS	NEW 55629-##
Color Codes: 15,37	

SUPERTOP W/ UPPER SOFT DOORS INCLUDED



1988-95 YJ WRANGLER*	51600-##
Color Codes: 09, 14, 15, 37	
1997-02 TJ WRANGLER	51700-##
Color Codes: 15, 37	
2003-06 TJ , WRANGLER	51710-## NEW
Color Codes: , 35, 36	

*=1986 & 87 MODELS MUST HAVE STEEL DOOR RETAINERS

1976-95 CJ7 & YJ DOORS NOT INCLUDED, INCLUDES TINTED WINDOWS	NEW 54599-##
Color Codes: 09,15,37	
1988-95 YJ W/ FABRIC UPPER DOOR FRAMES & TINTED WINDOWS	NEW 54600-##
Color Codes: 09,15,37	
1980-95 CJ7 & YJ INCLUDES 2 PCS SOFT DOORS & TINTED WINDOWS	NEW 54603-##
Color Codes: 09,15,37	
1997-02 TJ DOORS NOT INCLUDED, INCLUDES TINTED WINDOWS	NEW 54609-##
Color Codes: 15,37	
1997-02 TJ W/ FABRIC UPPER DOOR FRAMES & TINTED WINDOWS	NEW 54700-##
Color Codes: 15,37	
1997-02 TJ INCLUDES 2 PCS SOFT DOORS & TINTED WINDOWS	NEW 54703-##
Color Codes: 15,37	
2003-06 TJ DOORS NOT INCLUDED, INCLUDES TINTED WINDOWS	NEW 54709-##
Color Codes: 15,36	
2003-06 TJ INCLUDES FABRIC UPPER DOOR FRAMES & TINTED WINDOWS	NEW 54710-##
Color Codes: 15, 36	
2003-06 TJ INCLUDES 2 PCS SOFT DOORS & TINTED WINDOWS	NEW 54713-##
Color Codes: 35,36	

SPECIALTY SUPERTOP

	Stock No.
1964-84 TOTOTA FJ40 LANDCRUISER WITHOUT DOORS	51464-##
Color Codes: 01, 15	
1966-77 FORD BRONCO, DOORS NOT INCLUDED	51533-##
Color Codes: 01 or 02 TINT	

>>> NEW <<<

BESTOP® REPLACE-A-TOP™



REPLACE-A-TOP FOR JEEP® VEHICLES:

1976-83 CJ-5 (INCLUDES DOOR SKINS) COLOR CODE: 01	51117-##
1976-86 CJ-7 (INCLUDES DOORSKINS) COLOR CODE: 01	51118-##
1986-87 WRANGLER (INCLUDES UPPER 1/2 DOOR SKINS) COLOR CODE: 01	51119-##
1988-95 WRANGLER (INCLUDES UPPER 1/2 DOOR SKINS) COLOR CODE: 09, 14, 15, 16, 37	51120-##
1988-95 WRANGLER WITH TINTED WINDOWS (INCLUDES UNTINTED UPPER 1/2 DOOR SKINS) COLOR CODE: 09, 14, 15, 37	51123-##
1997-02 WRANGLER (INCLUDES UPPER 1/2 DOOR SKINS) COLOR CODE: 15, 33, 37	51121-##
1997-02 WRANGLER WITH TINTED WINDOWS (INCLUDES UNTINTED UPPER 1/2 DOOR SKINS) COLOR CODE: 15, 33, 37	51124-##
1997-02 WRANGLER FOR FULL STEEL DOOR MODELS NO DOORS INCLUDED COLOR CODE: 15, 33, 37	51127-##
2003-06 WRANGLER INCLUDES 1/2 DOOR SKINS COLOR CODE: 35, 36	51128-##
2003-06 WRANGLER INCLUDES TINTED SIDE AND REAR CURTAINS AND UNTINTED 1/2 DOOR SKINS COLOR CODE: 35, 36	NEW 51129-##
2003-06 WRANGLER HALF DOOR SKINS NOT INCLUDED COLOR CODE: 35, 36	51178-##

If your bows and hardware are in good condition the Replace-a-top may be the solution to a worn and faded softtop. Since Bestop is the supplier to Jeep® (and most others) the Replace-A-Top is the only aftermarket soft top produced using OE specs and materials. Features no-drill installation, factory-matched colors and heavy-duty YYK zippers. Fits only factory bows and hardware. Optional 31% tinted windows available on some models. One year warranty (two year for wrangler models). Made in the USA.



REPLACE-A-TOP FOR IMPORTS:

1988-94 TRACKER & SIDEKICK COLOR CODE: 09, 15, 52	51362-##
1995-98 TRACKER & SIDEKICK COLOR CODE: 01, 02	51364-##
1999-02 TRACKER & SIDEKICK COLOR CODE: 01	51366-##
1998-02 ISUZU AMIGO COLOR CODE: 01	51157-##
ALL YEARS SUZUKI, SAMURAI COLOR CODE: 01, 09, 15, 52	51361-##
SPRINT REPLACE-A-TOP FOR SAMURAI, ALL YEARS, COLOR CODE: 01	53361-##

REPLACE WORN TOP BOWS WITH: RUGGEDRIDGE'S SOFT TOP DISCONNECT KIT (4 pcs) FOR 1997-02 TJ WRANGLER
Stock No. 11251.03

BESTOP® SAILCLOTH REPLACE-A-TOP™

1988-95 WRANGLER - INCLUDES 1/2 DOORS COLOR CODE: 01, 37	79120-##
1997-02 WRANGLER - INCLUDES 1/2 DOOR SKINS COLOR CODE: 01, 33, 37	79121-##
1988-95 WRANGLER WITH TINTED WINDOWS: SIDE AND REAR CURTAINS INCLUDES UNTINTED 1/2 DOOR SKINS COLOR CODE: 01, 37	79123-##
1997-02 WRANGLER WITH TINTED WINDOWS: SIDE AND REAR CURTAINS INCLUDES UNTINTED 1/2 DOOR SKINS COLOR CODE: 01, 33, 37	79124-##
2003-06 WRANGLER FITS FULL STEEL DOOR MODELS; UPPER DOOR SKINS NOT INCLUDED. COLOR CODE: 35, 36	79125-##
2003-06 WRANGLER - INCLUDES 1/2 DOOR SKINS COLOR CODE: 35, 36	79128-##
2003-06 WRANGLER WITH TINTED WINDOWS: SIDE AND REAR CURTAINS INCLUDES UNTINTED 1/2 DOOR SKINS COLOR CODE: 35, 36	79129-##
1997-02 WRANGLER HALF DOOR SKINS NOT INCLUDED COLOR CODED: 01, 33, 37	79122-##

Want a soft-top that's as quiet as a hardtop? The Sailcloth Replace-a-top's design and heavy 30oz. Haartz® fabric significantly reduce wind and road noise as well as increase insulation. The fabric also prevents buffeting, shows fewer waves and wrinkles and is easier to maintain than a standard softtop. This new material and design is so much better it is used as the factory material on all 2001 and newer Wranglers. Optional tinted windows available. Kit includes fabric and 1/2 door skins. Factory hardware required. 2 year warranty. Made in the USA.



BESTOP® WINDOW KITS

TINTED WINDOW KITS:

1988-95 WRANGLER TINTED WINDOW KIT FOR REPLACE-A-TOP #51120 INCLUDES SIDE AND REAR WINDOWS Color Codes: 09, 15, 37 (8 lbs)	58120-##
1997-02 WRANGLER TINTED WINDOW KIT FOR REPLACE-A-TOP #51121 INCLUDES SIDE AND REAR WINDOWS Color Codes: 15, 33, 37 (9 lbs)	58121-##
1976-95 CJ7 AND WRANGLER TINTED WINDOW KIT FOR SUPERTOP MODELS: 51598, 51599, 51600, 51603 Color Codes: 01, 09, 15, 37 (8 lbs)	58599-##
1997-04 WRANGLER TINTED WINDOW KIT FOR SUPERTOP MODELS: 51609, 51700, 51703, 51709, 51710, 51713 Color Codes: 15, 33, 35, 36, 37 (9 lbs)	58609-##
1976-95 CJ7 AND WRANGLER TINTED WINDOW KIT FOR SUNRIDER MODEL #51698 Color Codes: 01, 09, 15, 37 (8 lbs)	58698-##
1997-06 WRANGLER TINTED WINDOW KIT FOR SUNRIDER MODEL #51699, 51719 Color Codes: 15, 33, 35, 36, 37 (9 lbs)	58699-##
2003-06 WRANGLER TINTED WINDOW KIT FOR REPLACE-A-TOP MODEL #51128, 79128 Color Codes: 35, 36	NEW 58128-##
2003-06 WRANGLER TINTED WINDOW KIT FITS SUPERTOP 51709, 51710, 51713, 54709, 54710, 54700, 54703, 54713 COLOR CODE: 35, 36	58709-##

All window kits consist of two side windows and one rear window (except P/N 51160). The 31% tinted windows block the sun's harmful rays from damaging the interior as well as keeping the interior cool on hot summer days. Mesh window kits are made of vinyl coated polyester for strength and tear resistency. One year warranty. Made in the USA.



BESTOP® UPPER DOOR SLIDERS

Bestop's upper door sliders feature DOT approved, thermally insulated glass for reduced road noise and increased ventilation. Each kit comes with one pair of upper doors with latching sliding glass windows. High quality weatherstripping keeps out ice, snow, dirt and debris. YJ Wrangler version is single slide while the TJ version boasts dual sliding glass for maximum convenience.

Application	Stock No.
1988-95 WRANGLER UPPER DOOR SLIDER (FITS FACTORY TOP & REPLACE-A-TOP #51120 & 51123 ONLY) COLOR CODE: 09, 14, 15, 37 (38 lbs)	51785-##
1988-95 WRANGLER UPPER DOOR SLIDER (FITS SUNRIDERS AND SUPERTOPS) COLOR CODE: 09, 14, 15, 37 (38 lbs)	51786-##
1997-04 WRANGLER UPPER DOOR SLIDER* FITS FACTORY & ALL BESTOP TOPS COLOR CODE: 09, 15, 33, 35, 36, 37 (43 lbs)	51787-##



BESTOP® DOOR KITS

Soft upper doors feature adjustable pins and collars for a precise fit. Kit comes with pair of fabric skins and frames. Designed to work with factory steel half doors. Made in the USA.

SOFT UPPER DOORS:

	Stock No.
1988-95 WRANGLER WITH STEEL 1/2 DOORS FOR SUPERTOP #51600.	51780-##

COLOR CODE: 09, 15, 37. Weight 18.0 lbs

1997-06 WRANGLER WITH STEEL 1/2 DOORS	51790-##
---------------------------------------	----------

COLOR CODE: 15, 33, 35, 36, 37. Weight 25.0 lbs

1988-95 WRANGLER WITH STEEL 1/2 DOORS	51782-##
---------------------------------------	----------

COLOR CODE: 09, 15, 37. Weight 18.0 lbs



Two-piece soft doors fit Supertop, Sunrider and Halftop. They provide protection from the elements while offering two-piece door versatility. Velcro seals upper and lower doors together. Bestop rotary latch handles close on factory door pins; paddle handles close on provided door strikers. Made in the USA.

2-PIECE DOORS:

	Stock No.
1976-86 CJ-7 - FOR SUPERTOP #51598 & SUNRIDER #51698 Color Codes: 01, 15	51778-##

1980-95 CJ-7 & WRANGLER - FOR SUPERTOP #51603 & SUNRIDER #51698 CLOSES ON FACTORY PIN STYLE DOOR STRIKER	51783-##
---	----------

Color Codes: 01, 09, 15, 37

1997-04 WRANGLER FOR SUPERTOP & SUNRIDER FITS FACTORY TOP DOOR SURROUNDS & STRIKERS	51789-##
--	----------

Color Codes: 15, 33, 35, 36, 37

**BESTOP® HALF DOORS AND DOOR SKINS****HALF DOORS**

Kits include a pair of lower half doors to keep out dirt and debris. Adjustable door pins ensure an exact fit. Variety of door handles to close on factory or Bestop supplied strikers.



Application	Stock No.
1955-75 M-38A1, CJ-5 & CJ-6	53025-##

Color Codes: 01

1976-83 CJ-5	53027-##
--------------	----------

Color Codes: 01

1976-86 CJ-7 & CJ-8 SCRAMBLER	53028-##
-------------------------------	----------

Color Codes: 01, 04, 15

1980-86 CJ-7 & 1986-95 WRANGLER*	53038-##
----------------------------------	----------

Color Codes: 01, 09, 15, 37

1997-06 WRANGLER	53039-##
------------------	----------

Color Codes: 15, 33, 35, 36, 37

*NOTE: P/N 53038 fits hard door striker pin with rotary style paddle handle

DOOR SKINS

Re-skin your existing door frames for a renewed appearance. Kits fit over factory door frames with velcro attachments for a quick and easy installation. CJ-7 model includes upper and lower skins. Wrangler versions come with upper door skins only.



Application	Stock No.
1976-86 CJ-7	53118-##

Color Codes: 01

1988-95 WRANGLER	53120-##
------------------	----------

Color Codes: 09, 15, 37

1997-06 WRANGLER	53121-##
------------------	----------

Color Codes: 15, 33, 35, 36, 37

*NOTE: 2001 and up TJ factory top uses different fabric and will not match.

BESTOP® DOOR STORAGE JACKETS

Don't leave your expensive doors out to get scratched, faded or dented. Protect them with these heavy duty canvas jackets while in storage. Beefy zippers run smooth and last long while multiple handles allow easy carrying or hanging. The 51660-01 holds two soft upper doors while the 51665-01 comes as a pair for factory full steel doors. Available in black only. FOR 1986-04 CJ7 & Wranglers

Application	Stock No.
DOOR JACKET FOR SOFT UPPER 1/2 DOORS	51660-01

DOOR JACKETS (PAIR) FOR FULL STEEL DOORS	51665-01
--	----------



BESTOP® TIGERTOP™

ACCESSORIES

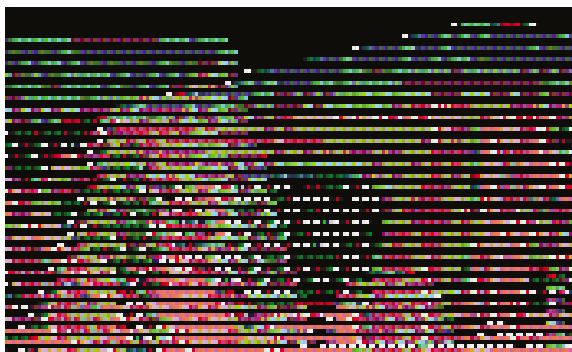

The Tigertop™ allows owners of early model vehicles to get the latest in softtop technology. Attaches to the vehicle using reinforced hidden snaps for a clean, custom appearance. Heat sealed, DOT approved windows roll up for ventilation and that "safari" look. Other features include Haartz® fabric, marine-grade thread, mandrel bent and powder coated hardware and large YYK® zippers. Comes with fabric and all hardware necessary for installation. Full soft doors included on Jeep® applications. Made in the USA.

Application	Stock No.
1941-49 MB & CJ2A Color Codes: 01 only	51402-01
1948-53 M-38 & CJ-3A Color Codes: 01 only	51403-01
1953-64 CJ-3B Color Codes: 01 only	51404-01
1955-75 M-38A1 & CJ-5 Color Codes: 01	51405-##
1976-83 CJ-5 Color Codes: 01	51407-##
1976-86 CJ-7 Color Codes: 01	51408-##
All CJ-6 Color Codes: 01 only	51306-01
All CJ-8 SCRAMBLER (Full Top) Color Codes: 01 only	52309-01
1967-73 JEEPSTER COMMANDO Doors not included Color Codes: 01 only	51311-01



Bestop

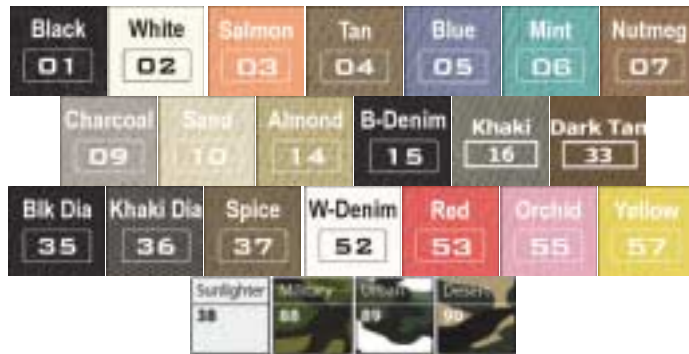

TIGERTOP'S CONTINUED:

Application	Stock No.
64-84 TOYOTA FJ40 (WITHOUT DOORS)	51440-01
64-84 TOYOTA FJ40 (WITH DOORS)	51443-01
1969-72 CHEVROLET BLAZER & GMC JIMMY (DOORS NOT AVAILABLE)	51315-01
1973-75 CHEVROLET BLAZER & GMC JIMMY (DOORS NOT AVAILABLE)	51316-01
1976-88 CHEVROLET BLAZER & GMC JIMMY (DOORS NOT AVAILABLE)	51317-01
1974-80 DODGE/PLYMOUTH RAMCHARGER/TRAILDUSTER (DOORS NOT AVAILABLE)	51318-01
1966-77 FORD BRONCO (DOORS NOT AVAILABLE)	51312-01
1972-80 INTERNATIONAL SCOUT (DOORS NOT AVAILABLE)	51320-01

BESTOP® SUNPORT®

The Sunport® for import vehicles can be configured for total sun or winter fun. Features include heat sealed, DOT approved windows and waterproof tape-sealed seams throughout. Big YYK® zippers and marine grade thread ensure extra long life. Tracker/Sidekick model offers 5-piece modular design for the ultimate in versatility. Includes fabric and center span channel (factory hardware is required). Doors not included; some drilling required. One year warranty. Made in the USA.

Application	Stock No.
1988-94 TRACKER & SIDEKICK	51762-##
Color Codes: 15, 52	
ALL YEARS SUZUKI SAMURAI	51761-##
Color Codes: 15, 52	



MISC. Bestop® ITEMS

Application	Stock No.
EXTEND-A-TRUNK: 44 lbs	
1987-95 WRANGLER	42625-01
1997-03 WRANGLER	42633-01
INST-A-TRUNK: 11" h x 11" d x 35" w, 5lbs	
1987-95 WRANGLER	42624-01
1997-03 WRANGLER	42632-01
2004-06 WRANGLER UNLIMITED	42634-01
FIBERGLASS BODY REAR GATE RETAINER	51249-00
PADDLE HANDLE ROTARY LATCH	51251-01
SNAP REPAIR KIT (INCLUDES SNAP SETTING TOOL)	93001-50

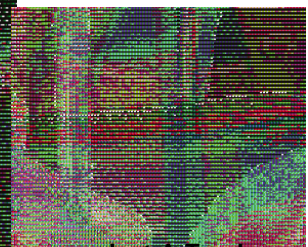
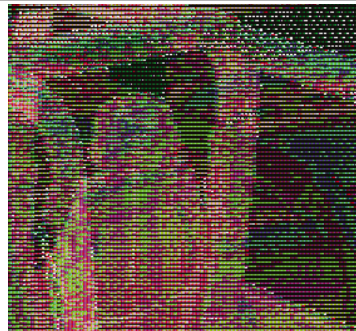

Extend-A-Trunk

Add 12.5 Cubic feet of Secure Storage to Your Jeep.

Inst-A-Trunk
2.7 Cubic feet of lockable Storage Space. 16 gauge heavy duty Steel



Snap Repair Kit
93001-50



Paddle handle kit
51251-01



Fiberglass Retainer 51249-00

AMP Research Power Step by Bestop

Wrangler & Unlimited, 03-06 **NEW** 75117-01

Bestop Cleaner/Protectant

Bestop Cleaner; Packed 12 - 16oz bottles per case **NEW** 11201-00
sold in case quantity only

Bestop Protectant, Packed 12 - 16oz bottles per case **NEW** 11202-00
sold in case quantity only



BESTOP® TRADITIONAL BIKINI®

The Traditional Bikini includes footman loops for rear strap tie-down. Reinforced edges reduce flapping and genuine Haartz® stretch and set fabric is perfectly color matched to original colors. Marine-grade thread, heavy-duty composite buckles and industrial-grade webbing ensure this bikini will last a very long time. Made in the USA.

NOTE: When removing a hardtop a windshield channel must be installed before installing a Bikini top.

Application	Stock No.
1955-75 M-38A-1, CJ-5 & CJ-6	52505-##
Color Codes: 01, 04	
1976-83 CJ-5	52507-##
Color Codes: 01, 04	
1976-86 CJ-7, CJ-8 SCRAMBLER & 1986-91 WRANGLER	52508-##
Color Codes: 01, 04, 09, 88, 89, 90	
1964-84 TOYOTA FJ-40 (black only)	52540-01
1966-77 FORD BRONCO	52542-##
Color Codes: 01	
1972-80 INTERNATIONAL SCOUT II	52550-##
Color Codes: 01	



Scout II and early Bronco owners can now enjoy the "open air" like your Jeep® friends do with Bestop's Traditional Bikini !

>>> NEW <<<

SUNLIGHTER BIKINI

Application	Stock No.
Sunlighter Traditional Bikini	52588-38
CJ-7 & WRANGLER, 76-91 (requires # 51209)	
Sunlighter Strapless Bikini	52589-38
Wrangler, 86-91 (Requires installation of # 51209)	
Sunlighter Strapless Bikini	52599-38
Wrangler, 92-95 (Requires installation of # 51209)	
Sunlighter Header Bikini	52595-38
Wrangler, 97-02 (Requires installation of #51238)	
Sunlighter Header Bikini	52598-38
Wrangler & Unlimited, 03-06 (Requires installation of # 51238)	



Revolutionary, semi-transparent, water-resistant fabric

BESTOP® STRAPLESS BIKINI®

The Strapless Bikini attaches directly to the sport bar for a clean look. Reinforced edges help eliminate flapping. Genuine Haartz® fabric, marine-grade thread and heavy duty composite buckles and fittings ensure a long life. Made in the USA.



Application	Stock No.
1980-83 CJ-5 (Black only)*	52517-01
1980-86 CJ-7 *	52518-##
Color Codes: 01, 04, 09, 15	
1986-91 WRANGLER *	52509-##
Color Codes: 01, 09, 14, 15, 88, 89, 90	
1992-95 WRANGLER *	52519-##
Color Codes: 09, 15, 37, 88, 89, 90	
1997-02 WRANGLER * (must use windshield channel #51210-01)	52521-##
Color Codes: 15, 33, 37	
ALL SAMURAI *	52561-##
Color Codes: 01, 15, 52	
1988-94 TRACKER & SIDEKICK *	52570-##
Color Codes: 15	
1995-98 TRACKER & SIDEKICK *	52562-##
Color Codes: 15	

*** When Removing An Existing Hardtop, A Windshield Channel Must be Installed before Installing a Bikini Top**

WINDSHIELD CHANNELS

To fit a bikini top to a hardtop vehicle a windshield channel must be installed. 51209-01 can also be used to replace old or worn channels.

TJ Wrangler notes: All 97-02 TJ Wrangler vehicles must install a channel regardless of whether the vehicle has a hardtop or soft top. If the vehicle has a Bestop Supertop the vehicle already has a 51235-01 channel. The drill-in channel must be removed when using a soft top or hardtop. Windshield channels and Bikini top combinations are not interchangeable.

Application	Stock No.
1976-95 CJ-5, CJ-7 & WRANGLER	51209-01
1964-84 TOYOTA LANDCRUISER	
1997-02 WRANGLER (DRILL IN STYLE)	51210-01
97-06 WRANGLER (NO DRILL)	51238-01
1972-80 INTERNATIONAL SCOUT II	51207-01
1966-77 FORD BRONCO	51206-01

BESTOP® SAFARI BIKINI®

The Safari Bikini® includes all the same features of the strapless Bikini® plus it extends rearward of the center sportbar to give rear seat passengers coverage. One year warranty. Made in the USA.

Application	Stock No.
1992-95 WRANGLER	52529-##
Color Codes: 09, 15, 37, 88, 89, 90	
1997-02 WRANGLER (Requires installation of 51210-01)	52530-##
Color Codes: 15, 33, 37	



BESTOP® HEADER BIKINI®

The header Bikini® attaches to the windshield frame with 51238-01 no-drill windshield channel (sold separately). Has all the features of Bestops® other Bikinies® including reinforced edges, Haartz® fabric and heavy-duty hardware. Made in the USA. **Note:** 51238-01 is required for installation



Application	Stock No.	
1976-91 CJ7 & YJ TRADITIONAL SUNLIGHTER BIKINI	52588-38	NEW
1987-91 WRANGLER STRAPLESS SUNLIGHTER BIKINI	52589-38	NEW
1992-95 WRANGLER, STRAPLESS SUNLIGHTER BIKINI	52599-38	NEW
1997-02 WRANGLER, HEADER SUNLIGHTER BIKINI	52595-38	NEW
2003-05 WRANGLER, HEADER SUNLIGHTER BIKINI	52598-35	NEW

Application	Stock No.
1997-02 WRANGLER (1)	52525-##
Color Codes: 15, 33, 37, 88, 89, 90	
1997-02 WRANGLER SAFARI VERSION (1)	52531-##
Color Codes: 15, 33, 37, 88, 89, 90	
2003-06 WRANGLER (2)	52528-##
Color Codes: 35, 36, 88, 89, 90	
2003-06 WRANGLER SAFARI VERSION (2)	52532-##
Color Codes: 35, 36, 88, 89, 90	
2004-06 WRANGLER SAFARI VERSION	NEW 52544-##
Color Codes: 35, 36	

BESTOP® DUSTER™

DUSTER FOR JEEP VEHICLES:

Wrangler with factory soft top bow folded down:

Application	Stock No.
1987-91 WRANGLER	90002-##
Color Codes: 09, 14, 15	
1992-95 WRANGLER	90018-##
Color Codes: 15, 37	
1997-02 WRANGLER	90019-##
Color Codes: 15, 33, 37	
2003-06 WRANGLER	90012-##
Color Codes: 35, 36	

CJ & Wrangler with Supertop® bow folded down:

Application	Stock No.
1980-91 CJ-7 & WRANGLER	90003-##
Color Codes: 01	
1992-95 WRANGLER	90008-##
Color Codes: 15, 37	
1997-02 WRANGLER	90011-##
Color Codes: 15, 33, 37	

CJ & Wrangler with hardtop replacement kit (includes belt rail attachment)

Application	Stock No.
1980-91 CJ-7 & WRANGLER	90005-##
Color Codes: 01, 09, 15	
1992-95 WRANGLER	90010-##
Color Codes: 15, 37	

TJ Wrangler with factory hardtop removed

Application	Stock No.
1997-02 WRANGLER	90020-##
Color Codes: 15, 33, 37	
2003-06 WRANGLER	90022-##
Color Codes: 35, 36	
2004-06 WRANGLER	NEW 90024-##
Color Codes: 35, 36	
2003 TJ WRANGLER	90012-##
Color Codes: 35, 36 (W/ Factory Soft top Bow Assembly)	



The Duster™ rear deck cover protects the rear cargo area from sun, rain and dirt and keeps prying eyes from seeing valuables. It also improves gas mileage by reducing drag while the top is down. Made of Genuine Haartz® fabric.



DUSTER FOR IMPORT VEHICLES:

Tracker & Sidekick with factory soft top removed

Application	Stock No.
1988-94 TRACKER & SIDEKICK	90009-##
Color Codes: 15	

1995-98 TRACKER & SIDEKICK	90029-##
Color Codes: 15	

Application	Stock No.
ALL YEARS SUZUKI SAMURAI	90006-##

Installs to factory snaps with bow folded down

Color Codes: 15

BESTOP® TRAIL COVER™

Keep dirt, rain and unwanted critters out of your Jeep® while out on the trail. The trail cover is designed as an easy to install cockpit cover for those times the vehicle needs a cover but you don't want to install the soft top. Can be used with Bikini, Windjammer and Duster in place. Will not fit over a Soft top.

Application	Stock No.
1992-95 WRANGLER	81030-##
Color Codes: 09, 37	
1976-91 CJ-7 & WRANGLER (Charcoal only)	81031-09
1997-06 WRANGLER	81032-##
Color Codes: 09, 37	
2004-06 WRANGLER	NEW 81034-##
Color Codes: 35, 36	

BESTOP® WINDJAMMER™

The Windjammer™ helps to shield the vehicles occupants from wind, rain and dust during warm weather and when used with a soft top can retain heat in the cabin during the winter months. Pass-through doggie door allows access to items in the rear. Attaches to center sport bar with straps and to the floor with Bestops patented belt-rail system.



Application	Stock No.
1980-83 CJ-5, 1980-86 CJ-7, 1981-86 CJ SCRAMBLER & 1986-95 WRANGLER Color Codes: 01, 04, 09, 14, 15, 37	80028-##
1997-02 WRANGLER Color Codes: 15, 33, 37	80030-##
2003-06 WRANGLER & WRANGLER UNLIMITED Color Codes: 35, 36	80032-##
ALL SAMURAI Color Codes: 15	80061-##
95-98 TRACKER & SIDEKICK Color Codes: 15	80062-##

BESTOP® SEAT, SPORT BAR & TIRE COVER

Replace that worn-out rollbar padding with Bestop® Sport Bar Covers. Closed cell foam resists hardening and rugged coil zippers make installation a snap. Factory color-matched Haartz® fabric and marine grade thread give fade mildew resistance. Made in the USA



Bestop's® Seat Covers are made from automotive grade vinyl color matched to OE colors. Easy bungee cord installation. Custom patterned for nice snug fit. Some applications include a map pocket.



SPORTBAR COVERS:

Application	Stock No.
1980-83 CJ-5, 1980-86 CJ-7 & 1981-86 SCRAMBLER Color Codes: 01, 04, 09, 15	80007-##
1986-90 WRANGLER (Covers all bars) Color Codes: 09, 14, 15	80008-##
1992-95 WRANGLER (Covers all bars) Color Codes: 09, 15, 37	80009-##
1992-95 WRANGLER (Center hoop only) Color Codes: 15	80019-##
1997-02 WRANGLER (With or without sound bar) Color Codes: 15, 33, 37	80020-##
2003-06 WRANGLER Color Codes: 35	80022-##

SEAT COVERS FOR JEEP® VEHICLES:

Application	Stock No.
1965-79 CJ-5 & 1976-80 CJ-7 (Low-Back buckets, pair) Color Codes: 15	29225-##
1980-83 CJ-5, 1976-86 CJ-7 & 1986-91 WRANGLER (High-Back buckets, pair) Color Codes: 04, 09, 15	29227-##
1992-94 WRANGLER (High-Back buckets, pair) Color Codes: 09, 15, 37	29224-##
1997-02 WRANGLER (High-Back buckets, pair) Color Codes: 09, 15, 33, 37	29226-##
2003-06 WRANGLER (High-Back buckets, pair) Color Codes: 35, 36	29228-##
1965-83 CJ-5, 1976-86 CJ-7 & 1986-95 WRANGLER (Rear bucket, Fold & Tumble only) Color Codes: 04, 05, 09, 15, 37	29223-##
1997-02 WRANGLER (Rear Bench) Color Codes: 09, 15, 33, 37	29221-##
2003-06 WRANGLER (Rear Bench) Color Codes: 35, 36	29229-##



Tire covers come in seven custom sizes color matched to Bestop® and factory colors. Tire covers have no print or logo.

TIRE COVERS:

Application	Stock No.
26.5" X 7.5" VERY SMALL Color Codes: 01, 15, 52	61026-##
28" X 8" SMALL Color Codes: 01, 04, 09, 14, 15, 33, 35, 36, 37, 52	61028-##
29" X 9" MEDIUM Color Codes: 01, 04, 09, 10, 14, 15, 33, 35, 36, 37	61029-##
30" X 10" LARGE Color Codes: 01, 04, 09, 14, 15, 33, 35, 36, 37	61030-##
31" X 11" EXTRA LARGE Color Codes: 01, 09, 15, 33, 35, 36, 37	61031-##
33" X 13" XX—LARGE Color Codes: 01, 09, 15, 35, 36, 37	61033-##
35" X 14" XXX—LARGE Color Codes: 01, 15	61035-##

HOSS (HARDTOP ORGANIZED SYSTEM STORAGE)

The all new inclusive-hardtop organized storage system from Bestop® helps eliminate the headache of removing and storing Jeep® hardtops. The HOSS™ is a one-of-a-kind, integrated storage system that has everything for Jeep® owners to protect, store and organize their hardtops, doors and accessories, all in one place.

HOSS (Hardtop Organized Storage System)

HOSS HardTop & Door Cart; Storage for 1 & 2 pc. hardtops. Includes Hardtop cart & Door Cart windows accessories	42801-01
HOSS HardTop Cart; Wrangler & Wrangler Unlimited 86-06 hardtops; Storage for 1 or 2 piece hardtops (HardTop Cart only)	42804-01
HOSS Cover Wrangler, 86-06; will not fit Unlimited Fits 1 piece hardtops	42802-09
HOSS Cover Wrangler, 86-06; will not fit Unlimited Fits 2 piece hardtop	42803-09



BESTOP® TAILGATE ORGANIZER

The tailgate organizer is a great way to store tools, flashlights, maps and any other small items that are rattling around on the floor of your Jeep®. Attaches to the tailgate using the patented Belt-Rail channel. Elastic pockets and snap-down cover keep everything in place.



BESTOP TAILGATE	Stock No.
1986-95 WRANGLER Color Codes: 15	54120-##
1997-02 WRANGLER Color Codes: 15	54122-##

BESTOP® SADDLE BAGS



Utilize the wasted space between the sport bar uprights with the Bestop Saddle Bags. Quickly straps to sport bars for easy installation and removal. Outer accessory pocket allow access to small, frequently used items. Genuine Haartz® fabric color matched to factory colors.

Application	Stock No.
1976-91 CJ5, CJ7, CJ8, & WRANGLER Sold in pairs Color Codes: 01, 09, 15	54105-##
1997-06 WRANGLER Sold individually Converts to shoulder strap duffel bag Color Codes: 09, 15, 33, 37	54108-##

HIGHROCK 4x4 BUMPER SYSTEM

Developed specifically for the hard core rock crawler, the Front and Rear Bumper feature high-access design for greater off road clearance. These durable and stylish bumpers have an E-Coat undercoating and a black powder-coat finish, which not only provides protection from moisture penetration, but also ensures a tough exterior finish - essential for extreme off road adventures.



HighRock 4x4 Bumper System

SlickRock 4x4 Front Bumper; Wrangler & Wrangler Unlimited, 97-06	42901-01
Slick Rock 4x4 Front Bumper; Wrangler 86-95	42908-01
HighRock 4x4 Tubular Grill Guard; (Fits SlickRock 4x4 Front Bumper (42901,42908)) Color Codes: 00, 01	42906-XX
HighRock 4x4 Approach Roller 2 (Fits SlickRock 4x4 Front Bumper (42901,42908))	42905-01
HighRock 4x4 Rear Bumper; Wrangler & Wrangler Unlimited, 86-06	42902-01
HighRock 4x4 Slideaway; Wrangler & Wrangler Unlimited, 97-06 Color Codes: 00, 01	42904-XX
HighRock 4x4 Slideaway Tray Bracket Kit (Fits 42904)	42907-01

>>> NEW <<<

BESTOP® TRAILMAX™ CONSOLES



BESTOP TRAILMAX™ CLASSIC

The Classic is Bestop's original center console. Covered in factory matching fabric it features a locking storage compartment, padded armrest, dual cup holders and a storage tray. One year warranty. Made in the USA.

Application	Stock No.
1976-83 CJ-5, 1976-86 CJ-7, CJ-8 & 1986-95 WRANGLER	81507-##
Dimensions: 23.5L X 7.5W X 12.75H	
Color Codes: 01, 04, 09, 15, 37	





BESTOP TRAILMAX™ AND TRAILMAX™ PRO

The successor to the Classic console is the new Trailmax™ and Trailmax™ Pro center consoles. Both are produced from injection molded plastic for durability and water resistance and feature a slide-out writing board, removable beverage cooler large enough for four 12 oz. cans, lockable, padded armrest oversized removable cupholders and multiple exterior storage trays. The Trailmax™ Pro console adds a 12V outlet for electronic equipment, a self-activating interior light and a first aid kit. One year warranty. Made in the USA.

Application	Stock No.
1952-95 CJ5, CJ7, WRANGLER TRAILMAX CONSOLE	81675-##
Dimensions: 24L X 10W X 13.5H	
Color Codes: 01, 04, 09, 15, 37	
1952-95 CJ5, CJ7, WRANGLER TRAILMAX PRO CONSOLE	81677-##
Dimensions: 24L X 10W X 13.5H	
Color Codes: 01, 04, 09, 15, 37	

BESTOP® SOUNDBARS

Bestop® has upgraded their Soundbar and Supersoundbar with better speakers, upgraded bracket design and covered U-bolts while lowering the price! New Cuspid® speakers feature beefier magnets for better power handling, stronger materials for longevity and built-in crossovers to ensure the right frequencies reach the correct driver. The upgraded bracketry ensures smooth and reliable operation and the covered U-bolts protect your sportbar covers from damage. The Soundbars still feature tuned SpiralPort™ chambers inspired by the human ear that deepen and enrich the music and tuned ports for truer more powerful bass response. Made in the USA.

The Super Soundbar:

3-Way 6 1/2" speakers with crossovers, SpiralPort™ design, Tuned Ports, dual adjustable map lights. 3 position settings. 4 factory matched colors.



Description	Stock No.
Bestop Super Soundbar	63715-##
Color Codes: 09, 15, 33, 37	



BESTOP® FENDER FLARES

Each Bestop fender flare kit comes with 4 flares and 2 stone guards (86-02 Wrangler). A Perimeter Frame™ adds structural integrity without compromising flex. The Mud Bulge™, also a Bestop trademark, helps to keep flying mud and water from landing in the vehicle. Made of flexible, impact resistant polyurethane Bestop flares provide up to 6" of fat tire coverage. Most applications do not require drilling.



Application	Stock No.
1955-86 CJ-5, 6, 7	49245-01
1987-95 WRANGLER WITH EXTENSIONS	49247-01
1997-06 WRANGLER WITH EXTENSIONS	49249-01

BESTOP® ENTRY STEPS & ENTRY GUARDS

This convenient entry step allows easy access in and out of your Jeep®. Heavily textured Polyurethane cap sits on top of a heavy-duty tubular nerf bar design to support up to 600 lbs! Bolts to the frame with unique no-drill system.

Protect your door sill from scratches and scuffs with these polyurethane entry guards. Attaches with a hidden adhesive strip.



Application	Stock No.
1976-86 CJ-7	49307-01
1986-02 Wrangler	49309-01
2003-06 Wrangler & Wrangler Unlimited	49310-01

Application	Stock No.
1976-95 CJ-7 & WRANGLER	51047-01
1997-06 WRANGLER	51049-01
1986-06 TAILGATE ENTRY GUARD NEW	51050-01

WRANGLER & UNLIMITED

BESTOP® OVERSIZED TIRE CARRIER

Bestop's tire carrier mounts to the body with reinforcing bracket so it can be used with a variety of aftermarket bumpers. It's unique design allows the carrier and the tailgate to open as one unit. Can hold up to a 35" tire and 200 lbs. Heavy duty tubular steel is powder coated in a black wrinkle finish for durability and good looks. An easily adjustable arm prevents wobble and play in the mechanism. Drilling and assembly required. One year warranty. Made in the USA.

Application	Stock No.
1986-06 WRANGLER & UNLIMITED	61960-01



BESTOP® MODULAR RACK SYSTEMS

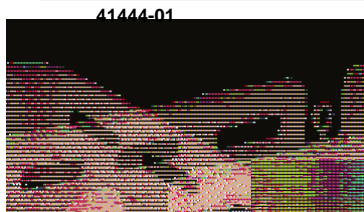

Receiver Hitch Bracket

Application	Stock No.
RECEIVER HITCH RACKS:	
RACK TRAY, UNIVERSAL - BRACKET REQUIRED	41444-01
1-1/4" RECEIVER HITCH RACK BRACKET	41409-01
2" RECEIVER HITCH RACK BRACKET	41410-01
COCKPIT RACK BRACKET - 1992-02 WRANGLER	41403-01
LOWER CARGO BRACKET - 1992-02 WRANGLER	41406-01
UPPER CARGO BRACKET - 1992-95 WRANGLER	41407-01
UPPER CARGO BRACKET - 1997-02 WRANGLER	41408-01
HINGED ROOF RACK - 1976-06 CJ-7 & WRANGLER	41430-01
HINGED ROOF RACK - 2004-06 UNLIMITED	41435-01
TAILGATE RACK BRACKET - 1986-02 WRANGLER	41411-01

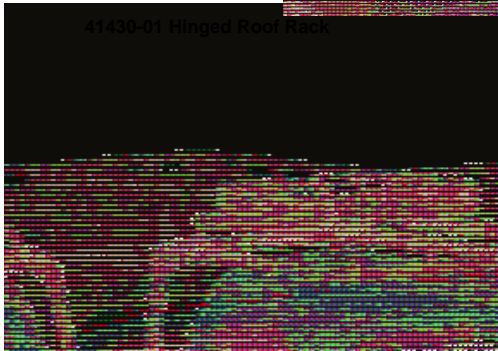

Hinged Roof Rack

Bestop's new Rack Systems provide you with convenient overhead storage for open-air driving. Rack Systems' modular design allows a universal tray to be installed in multiple locations around your Jeep® — the versatility to put storage where you want it. Depending on where they're installed, trays can each hold up to 200 pounds of gear. The thermoformed plastic tray is lighter than steel and has better impact resistance. Rounded corners help prevent injury if bumped. Cargo is tightly secured with tie-down straps anchored by installed I-bolts.

The Hinged Roof Rack can stay in place while dropping the soft top or while changing from soft top to hard top. The universal trays pivot off to the side to allow top changes without removing the rack system.

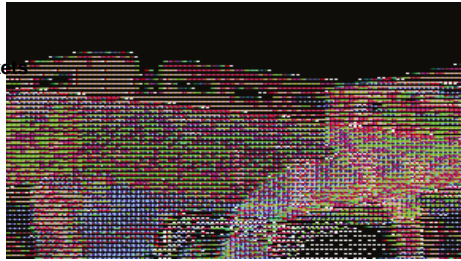

Cargo Bracket

BESTOP® HARDTOPS

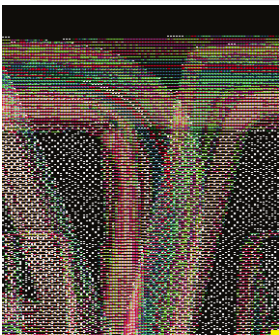

Introducing the new Bestop Hardtop - loaded with more unique features and progressive styling than any other top on the market. The one-of-a-kind design of this 2-piece hardtop lets you easily remove the front cockpit cover and store it on the optional roof rack, leaving your interior free for occupants and gear. The rear window features a defroster, while gas charged shocks hold the rear window up for easy loading. The rear window also locks without a key when the tailgate is closed. All windows are DOT-approved tinted glass. An automotive grade, washable headliner reduces noise while increasing insulation and an overhead dome light illuminates the interior of your Jeep®. Vents help keep the side windows clear of frost and a molded-in gel coat provides UV-resistant color. On the inside, overhead mesh pockets in the cockpit cover keep small items like sunglasses, CDs, cell phones and garage door openers handy. And on the outside, grooves in the cockpit cover and over the doors help channel water away from the door opening. Constructed of fiberglass-reinforced plastic, the Bestop Hardtop is available with or without matching upper doors. The upper doors feature dual sliding windows and a handy armrest for a comfortable ride.

Application	Stock No.
1986-95 WRANGLER: 180 lbs	41499-##
Without Upper Doors. Color Codes: 01,04	
1986-95 WRANGLER: 220 lbs	41500-##
With Upper Doors. Color Codes: 01,04	
1997-06 WRANGLER: 180 lbs	41509-##
Without Upper Doors. Color Codes: 01,04	
1997-06 WRANGLER: 220 lbs	41510-##
With Upper Doors. Color Codes: 01,04	

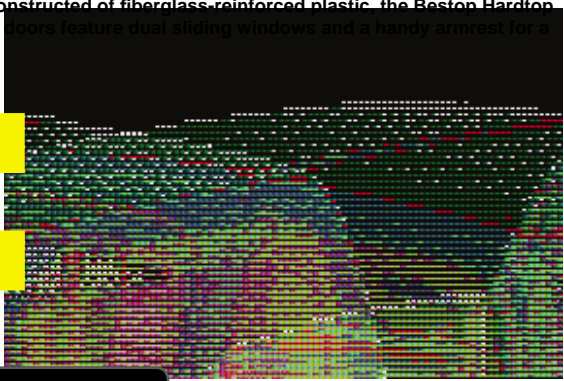

BESTOP® MOLDED BIKINI'S & DOORS

Bestop's Molded Products Are Constructed of Black Injection Molding On The Outside With Foam-Injected, Color Matching Inner Skins.



53739

Superior protection from the elements; keeps out road dirt and debris

Application	Stock No.
MOLDED DOORS:	
1986-95 WRANGLER	53738-##
Color Codes: 09, 15, 37	
1997-06 WRANGLER	53739-##
Color Codes: 09, 15, 33, 37,53	



Bestop® TRUCK PRODUCTS

CARGO CATCHER:

	Stock No.
FULL SIZE PICK-UPS, Black Only, 6 lbs	77900-01
COMPACT PICK-UPS, Black Only, 6 lbs	77950-01

CARGO CARRIER

ALL PICK-UPS, Black Only, 4 lbs	77350-01
---------------------------------	----------

UNDERSEAT STORAGE

Dodge - Ram Quad Cab: 1998-01, Black Only, 15 lbs	42660-01
Chevy / GMC - Extended Cab: 1998-04, Black Only, 15 lbs	42650-01
Ford - F-150 Extra Cab: 1998-04, Black Only, 15 lbs	42680-01



Organize your truck bed storage. Duffel / backpack straps for easy removal and transportation

462680-01

Fabric cross-bed divider neatly stores cargo. Fits all full size and compact pick-up trucks

77900-01



Organize your truck bed storage. Duffel / backpack straps for easy removal and transportation

77350-01

BESTOP® EXTENDABLE TOWING MIRRORS FOR TRUCKS

No more ugly tow mirrors! Bestop's Extendable Towing Mirrors are designed to provide greater visibility while towing large trailers and then retract when not in use. They provide a greater surface area for a better side view of both the vehicle and trailer and fold flat against the doors for tight maneuvering (built in stops prevent them from contacting doors). Made of tough impact-resistant ABS plastic they feature vibration damped bi-pillar design that provides crisper, clearer reflections. Available for American trucks in manual-tilt, power-tilt and power-tilt with defroster. Easy to install and fit just like OE mirrors.



MANUAL ADJUST

Application	Stock No.
1988-98 Chevrolet, CK pickup	73541-01
1992-99 Chevrolet Suburban	
1995-99 Chevrolet Tahoe	
2000 Chevrolet Tahoe LTD.	
1988-98 GMC Sierra	
1992-99 GMC Suburban	
1992-99 GMC Yukon	
1998-00 GMC Denali	

1999-02 Chevrolet Silverado	73542-01
2000-02 Chevrolet Suburban	
2000-02 Chevrolet Tahoe	
1999-02 GMC Sierra	
2000-02 GMC Yukon	
2000-02 GMC Yukon XL	

1994-01 Dodge Ram Pickup	73641-01
--------------------------	----------

1997-01 Ford F-150 Pickup	73841-01
---------------------------	----------



POWERTILT ADJUST

Application	Stock No.
1988-98 Chevrolet, CK pickup	73501-01
1992-99 Chevrolet Suburban	
1995-99 Chevrolet Tahoe	
2000 Chevrolet Tahoe LTD.	
1988-98 GMC Sierra	
1992-99 GMC Suburban	
1992-99 GMC Yukon	
1998-00 GMC Denali	
1999-02 Chevrolet Silverado	73502-01
2000-02 Chevrolet Suburban	
2000-02 Chevrolet Tahoe	
1999-02 GMC Sierra	
2000-02 GMC Yukon	
2000-02 GMC Yukon XL	
1994-97 Dodge Ram Pickup	73601-01
1998-01 Dodge Ram Pickup	73602-01
1997-02 Ford F-150 Pickup	73801-01

POWERTILT ADJUST WITH DEFROST

Application	Stock No.
1988-98 Chevrolet, CK pickup	73521-01
1992-99 Chevrolet Suburban	
1995-99 Chevrolet Tahoe	
2000 Chevrolet Tahoe LTD.	
1988-98 GMC Sierra	
1992-99 GMC Suburban	
1992-99 GMC Yukon	
1998-00 GMC Denali	
1999-02 Chevrolet Silverado	73522-01
2000-02 Chevrolet Suburban	
2000-02 Chevrolet Tahoe	
1999-02 GMC Sierra	
2000-02 GMC Yukon	
2000-02 GMC Yukon XL	
1998-01 Dodge Ram Pickup	73622-01

BESTOP® TRUCK ACCESSORIES



Application	Stock No.	Color Code
Supertop® for Truck:		
Toyota Tacoma Reg./Extd. Cab(6ft Bed) 2005-06	76301	35,36
Toyota SR5 1989-95, Tacoma Ext. Cab 1996-04 (6ft Bed)	76306	35,36
Ford Ranger (6ft Bed), 82-06; Mazda B-Series (6ft Bed), 94-06;	76302	35,36
Chevrolet/GMC S-10/Sonoma (6ft Bed), 94-04;		
Chevrolet/GMC Colorado/Canyon (6ft bed), 04-06		
Chevy Silverado 1500 (6ft Bed), 99-06; GMC Sierra (6ft Bed), 99-06	76303	35,36
Dodge Ram 1500/2500, Reg/Quad 02-06 (6.5 ft Bed)	76304	35,36
Ford F-150 (6ft Bed), 04-06	76305	35,36

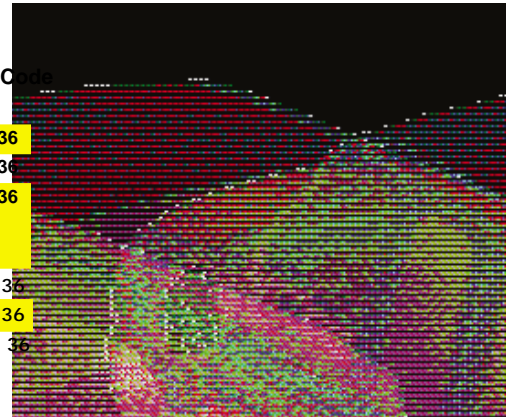

**PICK-UP TOPS
FEATURE:**
Sold with tinted windows only
Windows Zip out

ACCESSORIES

ROADRIDER PRO SEATS
FEATURE:
Adjustable Headrests
Adjustable Lumbar Support
Lever Recliner
Strong and Durable Atlas Framing
Elastic Map Pocket on Seatback
Available in Cloth or Leather
**REQUIRES BESTOP SUBFRAME/BUCKET
ASSEMBLY FOR INSTALLATION**



Application	Stock No.	Color Code
Full Size Pickup Trucks:		
Subframe/Bracket Assembly;	39800-##	01
Chevy Silverado/1500/GMC Sierra '88-'99		
Subframe/Bracket Assembly;	39801-##	01
Dodge Ram 1500 Reg Cab '94-01		
Subframe/Bracket Assembly;	39803-##	01
Ford F-150 Super Cab '97-'30		
RoadRider Bucket Seats		
Driver/Passenger; Jump Seat/Console; Vinyl	39804-##	04, 09
Driver/Passenger; Jump Seat/Console; Cloth	39805-##	04, 09
RoadRider Pro Bucket Seats		
Driver/Passenger; Jump Seat/Console; Cloth	39806-##	04, 09
Driver/Passenger; Jump Seat/Console; Leather	39807-##	04, 09

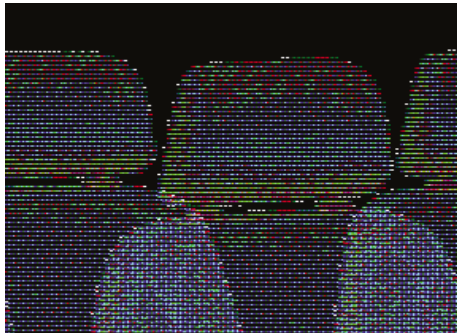

ROADRIDER PRO SEATS

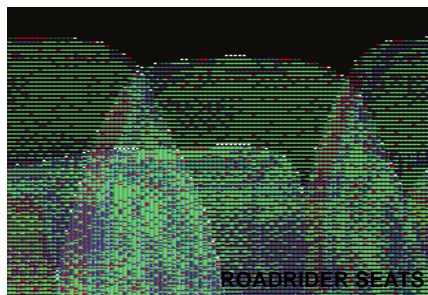

ROADRIDER SEATS



POWERSTEP: Kit includes wiring, mounting hardware and instructions
Lowers in one second when doors open, 600lb capacity, conceals when not in use

DODGE: RAM - 2002-04	75101-##	01
FORD: SUPERDUTY F-250/360, 2-Door - 1999-06	75102-##	01
FORD: SUPERDUTY F-250/360, Extended Cab - 1999-06	75103-##	01
FORD: SUPERDUTY F-250/360, Crew Cab - 1999-06	75104-##	01
FORD: F-150, Crew Cab - 2006	75105-##	01
FORD: F-150, 04-05 SuperCab	75109-##	01
FORD: Excursion, 00-05	75108-##	01
CHEVY: Silverado Z71, 1500, 2500HD, 3500, 99-05 Extended Cab	75112-##	01
CHEVY: Silverado 1500,2500, 2500HD, 3500, 99-05 Crew Cab	75113-##	01
CHEVY: Tahoe Z71, LS, LT, 01-05	75115-##	01
CHEVY: Avalanche Z71, 1500, 2500, 01-06 With Cladding	75114-##	01
CHEVY: Avalanche 1500, 01-06 Without Cladding	75115-##	01
GMC: Sierra 1500, 2500HD, 3500, Denali, 99-05 Extended Cab	75112-##	01
GMC: Yukon Base, Denali, 01-06	75114-##	01
GMC: Yukon XL, 01-05	75115-##	01
NISSAN: Titan, 04-05 King Cab	75106-##	01
NISSAN: Titan, 04-05 Crew Cab	75110-##	01
HUMMER: H2 & H2 SUT, 03-05	75107-##	01
CADILLAC: Escalade, 02-05	75114-##	01
CADILLAC: Escalade, 02-05 EXT/ESV	75115-##	01

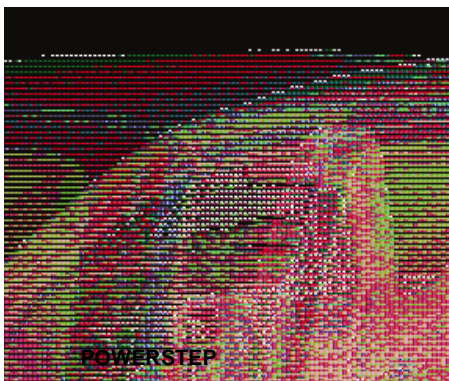

POWERSTEP

REPLACEMENT SOFT TOPS



Good Stuff. Great Deals.

The Flip top™

The Flip Top flips back offering the versatility of a sunroof and a full soft top. The Flip Top comes standard with a full bow system including framed upper doors (some models), zip-out rear and side windows, no bows in the rear windows for an unobstructed view and a patented Tuck Under™ attachment system. Features premium velcro, snaps and webbing and weatherproof fabric with DOT approved windows. Available with or without upper doors. One year warranty.

Flip Top Without Doors:

Application Stock No.

1986-95 WRANGLER 44523-##

Color Codes: 09, 15, 37

1997-02 WRANGLER 44527-##

Color Codes: 15, 37

Flip Top With Upper Doors:

Application Stock No.

1986-95 WRANGLER 44583-##

Color Codes: 09, 15, 37

1997-02 WRANGLER 44587-##

Color Codes: 15, 37



ACCESSORIES

Jeep® versions
Include upper
door skins



Application Stock No.

1988-95 YJ WRANGLER 51130-##

Color Codes: 09, 15, 37

1997-02 TJ WRANGLER 51131-##

Color Codes: 15, 33, 37

The replay™

The Replay™ replacement soft top beats out comparably priced competitors in a feature-to-feature comparison every time. Comes standard with the Patented Tuck Under™ attachment system, premium velcro, snaps and webbing and weatherproof fabric with DOT approved windows. Each kit includes fabric only, factory hardware is required. Upper door skins come standard on Wrangler models. One year warranty.



Application Stock No.

ALL SAMURAI 51133-#

Color Codes: 01, 15, 52

1988-94 TRACKER/SIDEKICK 51137-##

Color Codes: 15, 52

1988-94 AMIGO (Black only) 51139-01



Good Stuff. Great Deals.

All Pavement Ends™ hardtops are constructed using hand laid and rolled fiberglass and are reinforced with a honeycomb core for added strength and durability. Feature a spackle coat finish for a factory matched look, washable interior liner that increases insulation and decreases road noise, locking rear windows with dual gas shocks and smooth, flat, DOT approved tinted glass. One Year Warranty. **Note:** Due to their large size all Pavement Ends hardtops for Jeeps® are dropshipped from the manufacturer.

SUN CAP (BIKINI SOFT TOP):

Shelters Occupants from the Elements
Attaches to a Windshield Channel (Sold Separately)
Includes straps for Installation Around The Rollbar

Application	Stock No.
1987-91 WRANGLER	41504-##
Color Codes: 15	
1992-95 WRANGLER	41514-##
Color Codes: 15, 37	
1997-02 WRANGLER	41520-##
Color Codes: 15, 37	



SUN CAP PLUS (SAFARI STYLE SOFT TOP):

Full Length Sun Cap
Provides Front and Rear Coverage
Application

Application	Stock No.
1992-95 WRANGLER	41524-##
Color Codes: 15, 37	
1997-02 WRANGLER	41530-##
Color Codes: 15, 37	



CARGO COVER (DUSTER STYLE):

Adds a Sleek Appearance
Fits Over Factory Soft Top Bows When Folded Down

Application	Stock No.
1987-91 WRANGLER	41805-##
Color Codes: 15	
1992-95 WRANGLER	41815-##
Color Codes: 15, 37	
1997-02 WRANGLER	41825-##
Color Codes: 15, 37	



MISCELLANEOUS ITEMS:

Application Stock No

CAB CURTAIN (WIND-JAMMER STYLE)

1980-02 CJ7, WRANGLER, Color Codes: 15, 37 41805-##

CANOPY COVER (TRAIL COVER)

1976-91 CJ7, WRANGLER, Color Codes: 09 41727-##

1992-95 WRANGLER, Color Codes: 09 41728-##

1997-02 WRANGLER, Color Codes: 09 41729-##

CAB CURTAIN (WIND-JAMMER STYLE)

1980-02 CJ7, WRANGLER, Color Codes: 15, 37 41805-##

1988-98 TRACKER / SIDEKICK HARDTOP:

Application Stock No.

1988-94 TRACKER/SIDEKICK 2 PIECE HARDTOP 47635-##

Color Codes: 01, 02

1995-98 TRACKER/SIDEKICK 2 PIECE HARDTOP 47637-##

Color Codes: 01, 02

1999-02 TRACKER / VITARA HARDTOP:

Application Stock No

1999-02 TRACKER/VITARA 2 PIECE HARDTOP 47639-##

Color Codes: 01, 02

SUZUKI SAMURAI HARDTOP:

Application Stock No

ALL SAMURAI 2 PIECE HARDTOP 47653-##

Color Codes: 01, 02

ALL SAMURAI 2 PIECE SPORT HARDTOP 47655-##

Color Codes: 01, 02

BLACK POWDER COATED MIRROR KITS AND PARTS



1941-64 WILLYS & EARLY CJ:	Stock No.	Replaces
5" ROUND MIRROR KIT - With Arm	11001.01	663642K

1955-86 CJ:

	Stock No.	Replaces
MIRROR & ARM KIT L & R PAIR	11001.02	5462736K
MIRROR & ARM KIT L & R PAIR (W/RH CONVEX MIRROR)	11001.03	5462736XX
MIRROR & ARM KIT LEFT ONLY	11001.05	5455301K
MIRROR & ARM KIT RIGHT ONLY	11001.04	5455302K
CONVEX MIRROR & ARM KIT RIGHT	11001.06	5455302XK
SQUARE MIRROR HEAD	11002.01	5462736
SQUARE CONVEX MIRROR HEAD	11002.02	5462736X
ARM & BRACKET, LEFT	11003.01	5455301
ARM & BRACKET, RIGHT	11003.02	5455302

1987-02 YJ & TJ WRANGLER MIRROR KITS:

(Fit 87-02 1/2 door and 94-02 full steel door)	Stock No.	Replaces
MIRROR KIT LEFT & RIGHT PAIR	11002.03	82200834K
MIRROR KIT, LEFT ONLY	11002.05	82200833
MIRROR KIT, RIGHT ONLY	11002.04	82200834

CJ - Style Side Mirror kits (L & R Pair):

1987-95 YJ WRANGLER	11001.07	7618
1997-03 TJ WRANGLER	11001.08	7628

LED Mirrors - Add Distinction and Visibility to Your Vehicle!
Displays Light When Turn Signal and / or Parking Lamp Used!

LED MIRRORS:	For Half or Full Doors!	Stock No.	Replaces
1987-02 WRANGLER, Pair (Left & Right), Black		11015.01	MS-7794
1987-02 WRANGLER, Pair (Left & Right), Black, Dual Focal Lens		11015.02	MS-7795

WRANGLER HEATED SIDE MIRROR KITS PAIR	Stock No.
1987-02 YJ & TJ WRANGLER, BLACK	11002.20
1987-02 YJ & TJ WRANGLER, BLACK WITH LED	11015.20

1955-86 CJ:	Stock No.	Replaces
MIRROR & ARM KIT L & R PAIR	11005.01	5751193STKS
MIRROR & ARM KIT L & R PAIR (W/ RH CONVEX MIRROR)	11005.02	5751193STX
MIRROR & ARM KIT LEFT ONLY	11005.03	5751194STK
MIRROR & ARM KIT RIGHT ONLY	11005.04	5751195STK
CONVEX MIRROR & ARM KIT RIGHT	11005.10	5751195STXK
SQUARE MIRROR HEAD	11006.01	5751193ST
SQUARE CONVEX MIRROR HEAD	11006.02	5751193STK
ARM & BRACKET, LEFT	11007.01	5751194ST
ARM & BRACKET, RIGHT	11007.02	5751195ST



11005.06

STAINLESS STEEL MIRROR KITS AND PARTS

CJ-STYLE SIDE MIRROR KITS (L & R PAIR)	Stock No.	Replaces
1987-95 YJ WRANGLER	11005.06	7418
1997-03 TJ WRANGLER	11005.07	7428

1987-02 YJ & TJ WRANGLER

1/2 DOOR MIRROR KITS:	Stock No.	Replaces
MIRROR KIT, LEFT AND RIGHT PAIR, STAINLESS	11005.08	82200834K-ST



CHROME MIRROR KITS AND PARTS

1955-86 CJ	Stock No.	Replaces
MIRROR KIT L & R PAIR	11010.01	5751193K
MIRROR KIT LEFT ONLY	11010.03	5751194K
MIRROR KIT RIGHT ONLY	11010.02	575119SK
MIRROR HEAD, SQUARE	11011.01	5751193
ARM & BRACKET, LEFT	11012.01	5751194
ARM & BRACKET, RIGHT	11012.02	5751195



1987-02 YJ & TJ WRANGLER	Stock No.	Replaces
87-02 HALF-DOOR, MIRROR KIT L & R PAIR	11010.04	82200834CK
94-02 FULL-DOOR, MIRROR KIT L & R PAIR	11010.04	82200834CK
87-02 HALF DOOR, MIRROR KIT LEFT ONLY	11010.07	82200833C
87-02 HALF DOOR, MIRROR KIT RIGHT ONLY	11010.06	82200834C
1987-02 WRANGLER, Pair (Left & Right), Chrome	11016.01	MS-7796
1987-02 WRANGLER, Pair (Left & Right), Chrome, DualFocal Lens	11016.02	MS-7797

MISC. MIRROR KITS AND PARTS



INTERIOR REAR-VIEW MIRRORS AND MOUNTING KIT	Stock No.	Replaces
1941-75 WILLYS & CJ REAR VIEW MIRROR	11020.01	977680
1972-02 CJ & WRANGLER REAR VIEW MIRROR KIT INCLUDES MIRROR, BUTTON & GLUE	11020.02	8993023K
MIRROR MOUNTING GLUE	11021.01	8120995G

DUAL FOCAL MIRRORS
Applications: 1987-02 Wrangler with 1/2 steel door & 1994-02 Wrangler with Full steel door

	Stock No.	Replaces
BLACK PAIR	11017.01	76694
CHROME PAIR	11018.01	75504

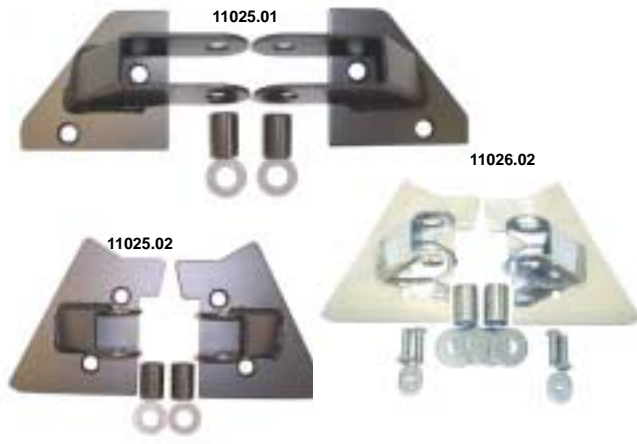
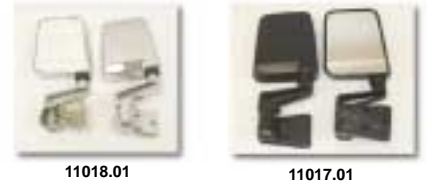

MIRROR RELOCATING BRACKETS	Stock No.	Replaces
1987-95 YJ WRANGLER HALF-DOOR, PAIR, Black	11025.01	957004
1994-95 YJ WRANGLER FULL-DOOR, PAIR, Black	11025.01	957004
1997-02 TJ WRANGLER HALF OR FULL DOOR, PAIR, Black	11025.02	857004
2003-2006 TJ MIRROR RELOCATION BRACKET PAIR Black	NEW 11025.03	
1987-95 YJ WRANGLER HALF-DOOR, PAIR, Stainless Steel	11026.01	7485
1994-95 YJ WRANGLER FULL-DOOR, PAIR, Stainless Steel	11026.01	7485
1997-02 TJ WRANGLER HALF OR FULL DOOR, PAIR, Stainless	11026.02	7491
2003-2006 TJ MIRROR RELOCATION BRACKET PAIR Stainless	NEW 11026.03	



1955-86 CJ SIDE MIRROR BUSHINGS	Stock No.	Replaces
PLASTIC BUSHING, EA. (2 NEEDED PER ARM)	11029.01	83500261
BILLET ALUMINUM BUSHING PAIR, CLEAR ANODIZED	11029.02	57005
BILLET ALUMINUM BUSHING PAIR, BLACK ANODIZED	11029.03	570052



LIGHT MOUNTING BRACKETS	Stock No.	Replaces
1976-95 CJ7 & YJ WRANGLER, PAIR, Stainless	11028.01	7489
1997-02 TJ WRANGLER, PAIR, Stainless	11028.02	7490
1997-02 YJ WRANGLER, PAIR, Black	11027.02	7608
1976-95 CJ7 & YJ WRANGLER, PAIR, Black	11027.01	7609



STAINLESS STEEL ACCESSORIES

Complete Hood Kits



Stainless Steel Hood Kits include cowl vent cover, hood hinges, hood catches (11101.01 only), footman loops and necessary hardware.

APPLICATION	Stock No.	Replaces
1976-95 CJ & WRANGLER	11101.01	7499
1997 TJ WRANGLER	11101.02	7498
1998-06 TJ WRANGLER	11101.03	7465



11106.03
TJ Wrangler

Bug Shields



11106.01
CJ



11106.02
YJ Wrangler

APPLICATION	Stock No.	Replaces
1955-86 CJ	11106.01	7410
1987-95 YJ WRANGLER	11106.02	7440
1997-06 TJ WRANGLER	11106.03	7439

Bumpers and Components



11107.01



11107.05



11108.01

FRONT BUMPER WITH HOLES:	Stock No.	Replaces
1955-86 CJ	11107.01	7429
1987-95 WRANGLER	11107.02	7436

FRONT BUMPER WITHOUT HOLES:	Stock No.	Replaces
1955-86 CJ	11107.03	7430
1987-95 WRANGLER	11107.04	7437
1997-06 TJ WRANGLER	11107.05	5E016T3X-ST

REAR BUMPERETTES & BUMPERS:	Stock No.	Replaces
1976-95 CJ & WRANGLER BUMPERETTE	11108.01	7438
1997-06 TJ WRANGLER REAR BUMPER	11107.06	5E018JX8AB-ST

FRONT BUMPER OVERLAY:	Stock No.	Replaces
1976-86 CJ	11109.01	7447
1987-95 WRANGLER	11109.02	7448

REAR CORNER GUARD, SHORT:	Stock No.	Replaces
1987-95 YJ WRANGLER, PAIR	11110.01	30435

Rust-free durability is what stainless steel is all about. Dress up your Jeep® with these polished stainless steel accessories. Designed to bolt on with no modification these items will make any Jeep® stand out.

Light Guards



11102.01
Wire Mesh Style



11102.04
Billet Style



11103.01
Euro Guards

APPLICATION	Stock No.	Replaces
1977-86 CJ, WIRE MESH	11102.01	7424
1987-95 YJ WRANGLER, WIRE MESH	11102.02	7425
1997-06 TJ WRANGLER, WIRE MESH	11102.03	7431
1987-95 YJ WRANGLER, BILLET STYLE	11102.04	7426

EURO TAILLIGHT GUARDS	Stock No.	Replaces
1976-06 CJ, YJ, TJ	11103.01	8460

Windshield Tie-Down Kits and Footman Loops



11104.01

11105.01

11104.02

STAINLESS WINDSHIELD TIE-DOWN KITS:	Stock No.	Replaces
1997-06 TJ WRANGLER	11104.01	7404
1955-95 CJ & WRANGLER	11104.02	7411

STAINLESS FOOTMAN LOOPS:	Stock No.	Replaces
1955-86 CJ & WRANGLER	11105.01	7423
Kit includes both short and long footman loops		
1955-86 CJ (short)	11105.02	7423C
1987-95 WRANGLER (long)	11105.03	7423Y

Hinge Sets



11111.01

11112.02

11113.02

11114.03

11115.01

11113.04

HOOD HINGE PAIRS:	Stock No.	Replaces
1976-95 CJ & WRANGLER	11111.01	7402
1997-06 TJ WRANGLER	11111.02	7432

WINDSHIELD HINGE PAIRS:	Stock No.	Replaces
1976-95 CJ & WRANGLER	11112.01	7403
1997-06 TJ WRANGLER	11112.02	7493

DOOR HINGE PAIRS:	Stock No.	Replaces
1976-93 CJ & WRANGLER W/ FULL DOOR	11113.01	7420
1987-06 WRANGLER W/ HALF STEEL DOOR	11113.02	7441
1995-99 WRANGLER W/ FULL STEEL DOOR	11113.03	7496
2000-06 WRANGLER W/ FULL DOOR	11113.02	7441
1976-06 CJ & WRANGLER, LOWER DOOR HINGE	11113.04	7407

TAILGATE HINGE PAIRS:	Stock No.	Replaces
1976-86 CJ LOWER	11114.01	7419
1987-95 WRANGLER	11114.02	7442
1997-02 TJ WRANGLER	11114.03	7459

HARDTOP LIFTGATE HINGE PAIR:	Stock No.	Replaces
1976-86 CJ	11115.01	7421

STAINLESS STEEL ACCESSORIES



>>> NEW <<<

ACCESSORIES

Hood Catches



HOOD CATCHES:	Stock No.	Replaces
1955-95 CJ & WRANGLER	11116.01	5751191STK
1997-06 TJ WRANGLER	11116.02	30489

Differential Covers



DIFFERENTIAL COVERS	Stock No.	Replaces
1987-95 YJ WRANGLER FRONT MODEL-30,	11118.01	7471
1941-86 CJ FRONT MODEL-30	11118.02	7470
1997-06 TJ WRANGLER FRONT MODEL-30	11118.02	7470
1955-86 CJ REAR MODEL-44	11118.03	7472
1976-86 CJ REAR AMC-20	11118.04	7474
1987-06 WRANGLER REAR MODEL-35	11118.05	7473

Entry Guards



ENTRY GUARDS:	Stock No.	Replaces
1955-83 CJ	11119.01	7415
1976-95 CJ7 & WRANGLER	11119.02	7416
1997-06 TJ WRANGLER	11119.03	7406

Hood Vent Covers



HOOD VENT COVERS	Stock No.	Replaces
1955-75 CJ	11117.01	986129-ST
1976-95 CJ & WRANGLER	11117.02	7406
1997 TJ WRANGLER	11117.03	7405
1998-06 TJ WRANGLER	11117.04	7469

Frame Covers

FRAME COVERS	Stock No.	Replaces
1976-86 CJ - FRONT	11120.01	7444
1987-95 YJ WRANGLER - FRONT	11120.02	7445
1997-06 TJ WRANGLER - FRONT	11120.03	7456
1976-86 CJ - REAR	11120.04	7449
1987-06 YJ & TJ WRANGLER - REAR	11120.05	7450



Wiper Motor Covers



WIPER MOTOR COVERS	Stock No.	Replaces
1968-75 CJ	11122.01	5756806E
1976-86 CJ	11122.02	5756806

Brake Caliper Dust shields



BRAKE DUST SHIELDS (PAIR)	Stock No.	Replaces
1977-78 CJ, w/6 bolt caliper plate	11121.01	5363379EK-ST
1978-86 CJ, w/2 bolt caliper plate	11121.02	5363379K-ST

STAINLESS STEEL ACCESSORIES

Miscellaneous Stainless Steel items

INTERIOR STAINLESS ACCESSORIES	Stock No.	Replaces
DASH GRAB BAR, 1955-95 CJ & WRANGLER	11123.01	7409
GAUGE COVER, 1976-86 CJ	11124.01	7412
GLOVE BOX DOOR, 1972-86 CJ	1125.01	5764164
GLOVE BOX PUSH BUTTON IT	11813.11	
INSTRUMENT KNOB SET, 6 PCS	11126.01	MS-30511
6 PCS DASH KNOB SET 1976-86 CJ	NEW 11126.02	MS-30511
STAINLESS STEEL W/ BLACK POWDER		
INTERIOR WINDSHIELD BRACKET PAIR, 1976-95 CJ & WRANGLER	11127.01	7408
STEERING COLUMN COVER, 1976-86 CJ	11128.01	7446
WINDSHIELD BRACKET KNOB, PAIR 1976-86 CJ	11129.01	MS-30510



LAMP GUARDS - 1997-06 TJ WRANGLER	Stock No.	Replaces
LAMP GUARD, HEADLIGHT, (PAIR)	11142.01	5661
LAMP GUARD, SIDE MARKER & PARK, (4 pcs) (will not fit Sahara Models)	11142.02	5671

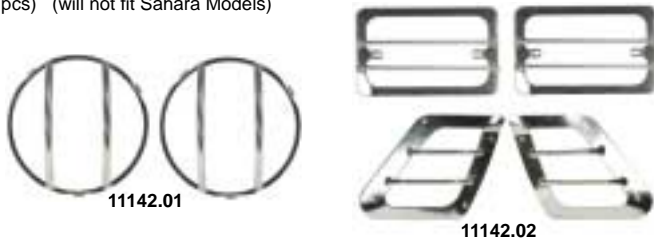

EXTERIOR STAINLESS ITEMS	Stock No	Replaces
AIR SCOOP, 1978-86 CJ AND 1987-95 YJ WRANGLER	11130.01	30507
AIR SCOOP, 1998-06 TJ WRANGLER	11130.02	30520
ANTENNA COVER KIT, 1997-UP TJ WRANGLER	11131.01	7468
BATTERY TRAY, 1976-86 CJ	11132.01	5764665K-ST
DOOR BRACKET, 1981-95 CJ AND YJ WRANGLER	11810.05	30513
GAS HATCH LID, 1997-06 TJ WRANGLER	11134.01	202400
GAS TANK FILLER COVER, 1976-95 CJ AND YJ WRANGLER	11135.01	5463803M
GAS TANK FILLER COVER, 1997-06 TJ WRANGLER	11135.02	30480
LICENSE PLATE BRACKET, 1976-86 CJ	11136.01	5764216
LICENSE PLATE BRACKET, FOR 1987-95 YJ	11136.02	55007403-ST
BODY GUARD, SHORT CORNER, PAIR, FOR 1987-95 YJ	11110.01	30435
LIGHT BAR, FULL W/S FRAME 1997-06 TJ WRANGLER	11138.01	7481
LIGHT BRACKET, 1976-95 CJ AND YJ WRANGLER	11028.01	7489
LIGHT BRACKET, 1997-06 TJ WRANGLER	11028.02	7490
MIRROR RELOCATION BRACKET, 1987-95 WRANGLER	11026.01	7485
MIRROR RELOCATION BRACKET, 1997-02 TJ WRANGLER	11026.02	7491
SIDE STEP PAIR, 1976-86 CJ	11139.01	8134436K
TIRE STOP, 1976-95 CJ AND YJ WRANGLER	11140.01	7414
TOW HOOK, 1976-06 CJ, YJ & TJ WRANGLER	11141.01	30509



>>> NEW <<<

**BLACK CHROME
STAINLESS STEEL**

Rugged Ridge Black Chromed Stainless Kits are designed to give your Jeep that rich, dynamic look found only in the most expensive vehicles. The unique Black Chrome process begins with prime 304 stainless steel polished to a mirror finish that is specially treated with black chrome. This process lets the beauty of the polished finish shine through the richness of the black chrome giving each piece a three-dimensional look!

The Rugged Ridge Program also features:

BC = BLACK CHROME

- Special designed kits that dress up portions of your Jeep. Gives you the true black chrome look throughout.
- A limited life time warranty against rust
- Individual tailgate hinge and Black Chromed mirrors to complete the look on your vehicle

BC Stainless, Door Kit-Door Hinges, W/S Hinges, lower door Bracket, 11180.02
97-06 Half Door models & 00-06 Full door models



11180.02

BC Stainless Euro-Guard Kit- Taillight Guards, 11180.05
Headlight/Side Marker Light Guards,97-06 Wrangler
(Eight Piece Kit)

BC Stainless Euro-Guard Kit- Taillight Guards, 11180.06
Headlight/Side Marker Light Guards,87-95 Wrangler
(Six Piece Kit)



11180.06

Black Chrome Stainless Tailgate Hinges 97-03 Wrangler 11180.04



11180.04



>>> NEW <<<

Description	Stock No.
BC Stainless, Door Kit- Door Hinges, W/S Hinges, Lower Door Bracket,76-93 Jeep Full door models	11180.01
BC Stainless Door Kit, Jeep Wrangler- Door Hinges, W/S Hinges, Lower Door Bracket, 87-95 Half Doors	11180.03
BC Stainless Hood Kit, 98-06 Wrangler (includes Cast Stainless Hood Catches)	11180.07
BC Stainless Hood Kit, 78-95 Wrangler	11180.08
Side Mirrors, 87-02 Jeep Wrangler w/ Factory Half Doors, 97-02 Full Doors, Black Chrome Finish (not actual stainless steel)	11090.01





BLACK POWDER ACCESSORIES



HINGES, BRACKETS & MISC.	Stock No	Replaces
DOOR HINGE SET, 1987-06 YJ & TJ WRANGLER, W/HALF DOOR	11202.01	7641
DOOR HINGE SET, (4 pcs) , 1976-93 CJ & YJ, W/HARD TOP	11202.02	7420-BL
DOOR HINGE, LOWER PAIR, 1976-06 CJ & WRANGLER	11202.03	7607
GRAB HANDLE, 1955-95 CJ & YJ WRANGLER	11203.01	7409-BL
GAUGE COVER, 1976-86 CJ	11204.01	7412-BL
HOOD HINGE, PAIR, 1976-95 CJ & YJ WRANGLER	11205.01	7402-BL
HOOD HINGE PAIR, 1997-06 TJ WRANGLER	11205.02	7632
HOOD VENT, 1976-95 CJ & YJ WRANGLER	11206.01	7606
HOOD VENT, 1997 TJ WRANGLER	11206.02	7405-BL
HOOD VENT, 1998-06 TJ WRANGLER	11206.03	7469-BL
TAILGATE HINGE, PAIR, 1976-86 CJ	11207.01	7419-BL
WINDSHIELD BRACKET, PAIR, INNER - 1976-95 CJ & YJ	11208.01	7408-BL
WINDSHIELD HINGE PAIR, OUTER, 1976-95 CJ & WRANGLER	11209.01	7603
WINDSHIELD HINGE PAIR, OUTER, 1997-06 TJ WRANGLER	11209.02	7693

Prefer the rugged look instead of the shine and polishing required of stainless steel? Get Mud & Shine's black powder coated accessories. Heavy duty semi-gloss coating resists scratches and looks great.

Windshield Tie-down Kit

	Stock No.	Replaces
1978-95 CJ & WRANGLER	11211.01	7611



LIGHT MOUNTING BRACKETS

	Stock No	Replaces
1997-02 TJ WRANGLER	11027.02	7608
1976-95 CJ & YJ WRANGLER	11027.01	7609



COMPLETE HOOD KIT	Stock No.	Replaces
1976-95 CJ & WRANGLER	11201.01	7699
1998-06 TJ WRANGLER	11201.02	7465-BL

No Hood Catches Included

Hood Catch Kits

	Stock No.	Replaces
1942-95 CJ & WRANGLER PAIR	11210.01	7601
1945-63 CJ, VERTICAL MOUNTING	11210.02	7601V
1987-95 WRANGLER, MATTE (EACH)	11210.03	HC4

BLACK OE STYLE LH = RH

1997-06 TJ HOOD CATCH BRACKET	11210.06	55176428AC	NEW
1997-06 TJ HOOD CATCH	11210.07	55176636AD	NEW
1997-06 TJ HOOD CATCH KIT	11210.08	55176636K	NEW
1997-06 TJ HOOD CATCH KIT PAIR	11210.09	55176636-K2	NEW



Brake Caliper Dust Covers

	Stock No	Replaces
CALIPER DUST COVER, 1977-78 CJ, w/6 bolt caliper plate	11212.01	5363379EK
CALIPER DUST COVER, 1978-86 CJ, w/2 bolt caliper plate	11212.02	5363379K



MIRROR RELOCATING BRACKETS	Stock No	Replaces
1987-95 YJ WRANGLER	11025.01	957004
1997-02 TJ WRANGLER	11025.02	857004

Bug Screens



	Stock No.	Replaces
1955-86 CJ	11213.02	7619
1987-95 WRANGLER	11213.01	7615
1997-06 TJ WRANGLER	11213.03	7639

Other Black Powder Accessories

FOR BUMPERS & NERF BARS
See Page 58

	Stock No	Replaces
BATTERY TRAY WITH ARM & CLAMP, 1976-86 CJ	11214.01	5764665K
BUMPERETTES, REAR, PAIR, 1976-03 CJ & WRANGLER	11215.01	5355457K
EUROGUARD TAIL LAMP GUARD, PAIR, 1976-03 CJ & WRANGLER	11226.01	8660
FOOTMAN LOOP, 1955-86 CJ	11227.01	7623C
GLOVE BOX DOOR, BLACK, 1976-86 CJ	11228.01	5764164-BLK
GLOVE BOX BOTTOM (NOT BLACK)	11813.11	
GAS HATCH, 1997-UP TJ WRANGLER	11229.01	MS-202401
LAMP GUARD, HEADLIGHT, 1997-UP TJ WRANGLER, (PAIR)	11230.01	5660
LAMP GUARD, SIDE MARKER & PARK, 1997-UP TJ WRANGLER (4 pcs) (will not fit Sahara Models)	11231.01	5670
LIGHT BAR (FULL FRAME), 1997-03 TJ WRANGLER	11232.01	7681
LICENSE PLATE BRACKET, FOR 1987-95 YJ, BLACK	11233.01	55007403



ACCESSORIES



	Stock No.	Replaces
HITCH BALL MOUNT CLIP & PIN NEW	11237.02	529
RECEIVER SHACKLE BRACKET, FITS ALL CLASS III RECEIVERS*	11234.01	2546
D-RING, PAIR	11235.01	2538
STONE GUARD SET (6 PCS), 1997-06 TJ WRANGLER	11236.01	7695
TOW HOOK, 1976-006 CJ & WRANGLER	11236.02	7605
TOW HOOK, PAIR, FRONT 1997-06 TJ WRANGLER	11236.03	7786
TOW HOOK, REAR 1997-06 TJ WRANGLER	11236.04	7783
TOW HOOK, REMOVABLE, FOR ALL 2" HITCH RECEIVERS (Does Not Incl Pin)	11237.01	15402

*DO NOT EXCEED HITCH CAPACITY

LICENSE PLATE BRACKET
STAINLESS STEEL W/ BLACK POWDER COAT
11233.02 55007403-ST-PC



CHROME AND TITANIUM ACCESSORIES



	DESCRIPTION	Stock No.	Replaces
	EUROGUARD TAIL LAMP GUARD, TITANIUM, PAIR, 1976-06 CJ & YJ & TJ WRANGLER	11301.01	866009
	HOOD CATCH KIT PAIR, CHROME, 1955-95 CJ & WRANGLER	11302.01	7501
	TOW HOOK, CHROME, FRONT, PAIR, 1997-06 TJ WRANGLER	11303.01	MS-202304
	TOW HOOK, CHROME, REAR, 1997-06 TJ WRANGLER	11303.02	MS-202303
	TOW HOOK, CHROME, 1976-06 CJ & WRANGLER	11303.03	7505
	INTERIOR WINDSHIELD KNOBS, CHROME, PAIR, 1976-86 CJ	11304.01	7527
	STEERING COLUMN COVER, CHROME, 1976-86 CJ	18090.01	5354777-CH
	HEADLIGHT RETAINING RING, CHROME, (EACH), 1972-86 CJ	12420.01	8128749
	HEADLIGHT BEZEL, CHROME, PAIR, 1972-86 CJ	12419.04	5460087K
	HEADLIGHT BEZEL, CHROME, PAIR, 1987-96 WRANGLER	12419.05	56003104K
	HEADLIGHT BEZEL, CHROME, PAIR, 1997-06 TJ WRANGLER	12419.08	55055046K
	HITCH BALL ASSEMBLY, 2" X 3/4"	11305.01	642
	HITCH BALL ASSEMBLY, 1-7/8" X 3/4"	11305.02	641



Sport Bar Dome Light

Large dome light mounts to sport bar using thick tie straps.

Stock No. Sport Bar Dome Light 11250.01 RB-1



Sport Bar Utility Hook

Keep your gear strapped down with this cleat style sport bar utility hook.

Stock No. Replaces Sport Bar Utility Hook 11250.02 RB-2



Hood Locks

Protect your engine compartment with these easy to install hood locks. No drilling is required and they hide neatly inside the grill. Cheap insurance against a problem as old as Jeep®. CJ and YJ Wrangler versions cannot be used with mesh bug screen.

11252.01

11252.02

11252.03



Application Stock No. Replaces

1972-86 CJ 11252.01 HL1

1987-95 YJ WRANGLER 11252.02 HL2

1997 TJ WRANGLER 11252.03 HL3

with side-side hood latch

1997-06 TJ WRANGLER 11252.04 HL4

with pull forward hood latch



11252.04

Stock No. Replaces

SOFT TOP DISCONNECT KIT

(4pcs), BLACK, ALUMINUM FOR 1997-06 TJ WRANGLER 11251.03 MS-857001



11251.03
4 pcs kit

piece enlarged for detail

Spreader Bars for YJ Wrangler

The adjustable spreader bar allows you to tighten or loosen the tension on the 1987-95 Wrangler factory soft top



11251.02



11251.01

Stock No. Replaces

1987-95 WRANGLER REPLACEMENT 11251.01 89998

1987-95 WRANGLER PAIR 11251.02 89999

TailGate Stopper, Billet Aluminum

1987-2006 YJ & TJ WRANGLER NEW 11238.11 57011



11238.11

Cup Holders

Now there is a convenient way to hold an open drink while in your Jeep® or on the go. (Not for hot beverages, not for open top cups)

FITS ALL JEEPS® WITH SPORT BAR 12101.01



12101.01

12101.02

Grab your small water bottle or cold soft drink and put it on your waist band bottle holder

Stock No. Replaces 12101.02 769901 (each)

Clinometer

Give yourself a little more confidence off road with this neat little gadget. Shows roll angle and pitch for off-camber and steep inclines/declines and includes a compass so you never get lost. Self adhesive backing allows easy installation virtually anywhere.

Stock No. Replaces

Clinometer 13309.01 791006



ALUMINUM HAWSE ROLLER

ALUMINUM HAWSE FAIRLEAD NEW 11238.01 RAF10

(FOR WINCH), HARDWARE INCLUDED



11238.01



SPORT BAR COAT HANGER HOOK, PAIR

1955-06 CJ AND WRANGLER NEW 11250.03



11250.03

Clip-on light to be attached to sun visor or a baseball hat

Stock No. Replaces 11309.02 (each) 769801



11309.02

Owners & Service

OWNERS MANUALS

Stock No.	Replaces
12601.01	5459830
12601.02	5461850
12601.03	5464387
12601.04	5750217
12601.05	5752419
12601.06	5758661
12601.07	5761950
12601.08	5764097
12601.09	52002009
12601.09	52002009
12601.09	52002009
12601.12	52001680
12601.12	52001680
12601.14	813269050
12601.15	813260050X
12601.16	813261050
12601.17	813269250
12601.18	813269350
12601.19	813269450
12601.20	813269550

Manuals

SERVICE MANUALS

Service manuals are sold as loose sheets and need to be put in a large 3 hole binder (Binder not included)

Stock No.	Replaces
12603.01	SM74
12603.02	SM75
12603.03	SM76
12603.04	SM77
12603.05	SM78
12603.06	SM79
12603.07	SM80
12603.08	SM81
12603.09	SM82
12603.10	SM83
MUST PURCHASE 12603.10	
12603.11	SM84-86
12603.12	SM87-88
12603.13	SM89
12603.14	SM90



DESCRIPTION

DESCRIPTION	Stock No.	Replaces
BEVERAGE CUP HOLDER: 1976-95 CJ & YJ	13306.01	57004
AIR SCOOP (Ram Air Induction Scoop), Black plastic: 1978-95 CJ & YJ	13307.01	57001
REMOVABLE TOW HOOK, Black: For ALL 2" Hitch Receivers (Pin Not Incl)	11237.01	15402



13307.01

WINDSHIELD CHANNELS

DESCRIPTION	Stock No.	Replaces
1976-95 CJ & WRANGLER	13308.01	5760259
1997-2002 TJ WRANGLER (DRILLING REQUIRED)	13308.02	MS-200201
1997-2002 TJ WRANGLER (NO DRILLING REQUIRED)	13308.03	MS-200301
1997-06 TJ WRANGLER (NO DRILLING REQUIRED)	NEW 13308.04	



13308.02

13308.04

CHROME & BILLET ALUMINUM GRILLE INSERTS

DESCRIPTION	Stock No.	Replaces
1987-95 WRANGLER, CHROME, 7 pcs	11306.01	7509
1987-95 YJ BLACK PLASTIC GRILLE INSERT KIT	NEW 13306.04	
1997-06 WRANGLER, CHROME, 7 pcs	11306.02	7511
1997-06 TJ WRANGLER BLACK PLASTIC	NEW 11306.03	
1987-95 WRANGLER, BILLET ALUMINUM, 7 pcs	11401.01	75509
1998-06 WRANGLER, BILLET ALUMINUM, 7 pcs	11401.02	75511
1998-06 TJ, KIT ALUMINUM W/ BLK POWDER COAT	NEW 11401.03	
1997-06 TJ BLK. HEADLIGHT BEZEL PAIR	NEW 12419.23	
1987-95 YJ BLACK HEAD LIGHT BEZEL PAIR	NEW 12419.24	



12419.23

12419.24

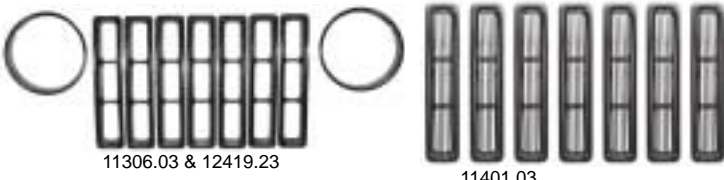

11306.03 & 12419.23

11401.03

11401.02

11306.02

SEAT RISERS & SEAT SLIDERS

DESCRIPTION	Stock No.	Replaces
1976-95 CJ & WRANGLER SEAT BRACKET, PASSENGER SIDE	NEW 13201.02	55027116
1976-95 CJ & WRANGLER SEAT BRACKET, DRIVER SIDE	NEW 13201.01	55027117



13201.02



SOFT TOP STORAGE BOOT

DESCRIPTION	Stock No.	Replaces
1992-06 YJ & TJ Black Denim	12104.15	600015
1992-06 YJ & TJ Spice	12104.37	600037
1946-91 CJ & YJ Black Denim	12105.15	590015
1946-91 CJ & YJ Spice	12105.37	590037



12104.15

OE STYLE INNER DOOR HANDLE, 1976-86 CJ

DESCRIPTION	Stock No.	Replaces
1976-86 CJ BLACK PLASTIC	11801.01	5457831

OE STYLE INNER DOOR HANDLES, 1987-95 YJ WRANGLER (FITS BOTH HALF DOOR AND FULL DOOR MODELS)

DESCRIPTION	Stock No.	Replaces
BLACK HANDLE	11815.01	55009801
BLACK HANDLE KIT*	11816.01	55009801k
SPICE HANDLE	11815.37	5AE50LTB
SPICE HANDLE KIT*	11816.37	5AE50LTBK
GRAY HANDLE	11815.09	5AE50JS1
GRAY HANDLE KIT*	11816.09	5AE50JS1K
HANDLE CAP (NEED 2 FOR EACH HANDLE)	11802.01	55009804
HANDLE SCREW (NEED 2 FOR EACH HANDLE)	11802.02	4007397



12104.37



11801.01



11816.01



KITS INCLUDE: (1) Handle, (2) Screws and (2) Caps

ACCESSORIES

SOUNDBARS AND SOFT ACCESSORIES FOR CJ, YJ & TJ WRANGLER

Deluxe 2-Way Soundbar 1987-02 YJ & TJ Wrangler

The Mud & Shine 2-way soundbar features marine grade 6 1/2" coaxial speakers capable of handling up to 80w peak power each. Designed to handle the rigors of off-roading and power of aftermarket amplifiers the speakers feature a polyurethane coated woofer, Mylar tweeter and butyl rubber surround for weather resistance as well as an ASV material, copper wound voice coil for distortion free power handling. Available in three high quality, factory matching colors: Black, Charcoal and Spice.



2-WAY SOUNDBAR	Stock No.	Replaces
BLACK	13001.15	792115
CHARCOAL	13001.09	792111
SPICE	13001.37	792117

Ultimate Six Speaker Soundbar 1987-02 YJ & TJ Wrangler

For the audiophiles out there Mud & Shine has developed the 6-speaker soundbar. Separating the frequencies means each speaker receives only those sounds it was designed for and in turn can handle more power with less distortion (up to 100w peak power per side). The 6 speaker system includes a 6" woofer that boasts a large 10 oz. magnet, a 3 1/2" high compliance midrange and a 1" tweeter with a neodymium magnet and ferrofluid for superior dispersion and efficiency. The tweeter also swivels to adjust imaging. Maplight not included. Now available in 3 factory matching colors: Black, Charcoal and Spice.



6-SPEAKER SOUNDBAR	Stock No.	Replaces
BLACK	13002.01	792301
CHARCOAL	13002.09	792309
SPICE	13002.37	792317

13003.01



97-06 WRANGLER

	BLACK	SPICE	
SOUND BAR WEDGE PAIR	13003.01	13003.37	NEW
SOUND BAR WEDGE W/ SPEAKER	13004.01	13004.37	NEW

BLACK SPICE

13004.37



Consoles

Countoured locking consoles
Convenient & economical

1976-95 CJ & WRANGLER:

BLACK	GRAY	BLACK DENIM	SPICE
13101.01 32001	13101.09 32009	13101.15 32015	13101.37 32037



Replacement Sun Visors

Replace those old, worn out or missing sun visors with these OE style replicas. Available in factory matching black, grey or spice. Sold in Pairs. Mounting screws not included.

1972-86 CJ	Stock No.	Replaces
BLACK VINYL	13301.01	78125-01
GRAY VINYL	13301.09	78125-09
SPICE VINYL	13301.37	78125-37

1987-95 YJ WRANGLER	Stock No.	Replaces
BLACK VINYL	13312.01	78126-01
GRAY VINYL	13312.09	78126-09
SPICE VINYL	13312.37	78126-37



Provides Cupholders For Front & Rear Passengers!



Ultimate Locking Console
Look, durability & functionality

Quality construction, sharp looks and neat features like: Padded Arm rest, locking console storage with removable storage trays, cup holder, coin holder and a flip-open sunglass holder make this a great accessory for your vehicle!

1976-95 CJ & WRANGLER:

BLACK	GRAY	BLACK DENIM	SPICE
13102.01 31501	13102.09 31509	13102.15 31515	13102.37 31537

Adjustable Door strap

Keeps any door in check. Made of tough nylon webbing they feature multiple adjustments so you can keep the door in any position you wish.



1976-96 CJ & YJ	Stock No.	Replaces
ADJUSTABLE DOOR STRAP PAIR	12103.01	769401

NO DOOR, LIGHTS OFF

1997-06 TJ WRANGLER, SPRING PAIR	NEW	11819.01	EE001
----------------------------------	-----	----------	-------



11819.01



ALUMINUM HAWSE ROLLER

ALUMINUM HAWSE FAIRLEAD (FOR WINCH), HARDWARE INCLUDED	NEW	11238.01	RAF10
--	-----	----------	-------

11238.01



Cover Lock Kit

Stock No.
13303.01



COMPRESSOR KITS

Compressor Kit 200P for 33 inch and smaller tires.

Every off road vehicle needs an on board compressor to air up after a ride, repair a leaking tire or inflate an air mattress in camp. This new air compressor will inflate a 33 inch tire from 15psi to 30psi in less than 3 minutes. With a 1.94cfm flow rate and maximum duty cycle at 20% with maximum pressure of 160psi and a thermal overload protection system, this compact compressor is quite powerful. The kit comes complete with an 18' coiled air supply line and inline gauge with screw on air chuck, 7.5' power cord with battery clamps and a sturdy, water resistant carrying case.

Compressor Kit 400P for 35 inch and larger tires

This new air compressor will inflate a 35 inch tire from 15psi to 30psi in less than 3 minutes. With a 2.5cfm flow rate and maximum duty cycle at 20% with maximum pressure of 160psi and a thermal overload protection system, this compact compressor is very powerful. The 25amp 12 volt motor has a continuous duty cycle of 30 minutes, which provides more than enough time to inflate your tires at the end of the ride and then some. The kit comes complete with an 18' coiled air supply line and inline gauge with screw on air chuck, 7.5' power cord with battery clamps and a sturdy, water resistant carrying case

>>> NEW <<<



Compressor Kit	Stock No.
PORTABLE 200P	NEW 15101.01
PORTABLE 400P	NEW 15101.02

ACCESSORIES

Ultimate Grab Handles

These extremely useful handles allow passengers to hold on during off-road adventures. Made of durable nylon webbing they feature easy hook and loop attachment to virtually any sport bar. Deluxe version features thick foam handle for extra comfort. Sold in Pairs.



Sport grab handle



Deluxe grab handle



Ultimate Grab Handle

DESCRIPTION	Stock No	Replaces
SPORT GRAB HANDLE PAIR	13305.01	769201
DELUXE GRAB HANDLE PAIR	13305.02	769301
ULTIMATE GRAB HANDLE PAIR (RED)	NEW 13505.03	
ULTIMATE GRAB HANDLE PAIR (BLACK)	NEW 13505.04	





9.5XP
Self-Recovery Winch
Stock No. **W68500**

The 9.5xp winch features an all new, High Output Parallel Series Wound winch motor that's the strongest and most durable in the industry. The 6 hp motor, 3-stage planetary gearing and continuous duty control pack work in sync to tackle the most demanding pulls. Full face contact drum seals, motor and end housing gaskets deliver extreme-duty water resistance.



XD9000i
Self-Recovery Winch
Stock No. **W27550**

You'll probably see more XD9000i winches on trail rigs than any other winch. No load line retrieval of 38 ft. per minute and three-stage planetary gearing are just a few reasons why. It's also a terrific fit in a hidden mounting system.



9.5ti
Thermometric Self-Recovery Winch
Stock No. **W67550**

The new 9.5ti packs 9500lbs of pulling capacity into a massive 12.5 lb 360-aluminum die-cast body. Seals at the key points give extreme-duty water resistance. A Gen II Bosch motor delivers just the right balance between torque and speed. The thermometric indicator gives the operator information about motor temperature during the winching operation.



M8274-50
Self-Recovery Winch
Stock No. **W38631**

Loved by off-roaders who compete for prizes, its Warn's fastest winch. No load retrieval speed is a very quick 73.4 ft per min and with 150 ft of 5/16" cable it has extremely long line capacity. The spur-gear drive-train and upright design make it very rugged while the braking system delivers smooth operation with superior heat rejection. 8000lb capacity.



M8000
Self-Recovery Winch
Stock No. **W20910**

Compact, tough and an outstanding value. Comes with hawse fairlead and 80 ft. 5/16" wire cable.

Winch Accessories

ALUMINUM HAWSE ROLLER

ALUMINUM HAWSE FAIRLEAD **NEW** 11238.01 RAF10
(FOR WINCH), HARDWARE INCLUDED



DESCRIPTION	Stock No.
SOFT WINCH COVER, XD9000i, X8000i, HS	W13917
SOFT WINCH COVER, M8000	W18250
SOFT WINCH COVER, M8274-50	W8557
ACCESSORY KIT IN RED NYLON WARN BAG	W25300
COVER, PLASTIC FOR ROLLER FAIRLEAD	W60390
ACCESSORY POWER INTERRUPT KIT	W32959
ROLLER FAIRLEAD	W5742
SNATCH BLOCK	W8555



Winch Mounts For Jeep®

WINCH MOUNTING KITS	Stock No.
FOR M8274 1945-86 CJ	W11310
FOR ALL (EXCEPT M8274) CJ	W13910
FOR ALL (EXCEPT M8274) YJ	W21390
FOR M8274 1987-95 YJ	W21395
FOR ALL (EXCEPT M8274) 97-06 TJ	W37170
FOR M8274 97-06 TJ	W38671

TUBULAR GRILLE GUARD FOR TJ FACTORY BUMPER	Stock No.
98-06 TJ (requires part # W37170)	W37171





Rock Crawler Bumpers

Warn incorporates years of off-road experience to deliver well engineered, durable and great looking bumpers. The first thing you'll notice are the tapered ends which dramatically increase approach angles. Other features include welded eyelets to mount D-ring shackles and pre-drilled holes for lights in front. Outback a 2" receiver for portable winch or shackle bracket increase recovery options. Both are laser cut from 3/16" steel, CNC formed and robotically welded for precise fit and powder coated black for durability.

NOT RATED FOR TOW-



FRONT BUMPER Stock No.

1997-06 TJ WRANGLER	W61853
1987-95 YJ WRANGLER	W61856
1976-86 CJ	W61859

REAR BUMPER Stock No.

1997-06 TJ WRANGLER	W61854
1987-95 YJ WRANGLER	W61857
1976-86 CJ	W61860

Rock Sliders

One of the most vulnerable parts of your Jeep's body are it's rocker panels. The Rock Sliders are designed to protect your sheetmetal during off road excursions while not adding anything for your Jeep to get hung up on. Made from thick 3/16" reinforced steel they bolt directly to the body and are powder coated black for durability. Mounting hardware included. Some drilling required.



R O C K SLIDERS Stock No.

1997-06 TJ WRANGLER	W63002
1987-96 YJ WRANGLER	W63003
1976-86 CJ	W63004
2005-06 UNLIMITED	W6875

Rock Crawler Bumpers & Tire Carriers

Designed to carry the oversized tires all serious off roaders use, the new WARN tire carrier can handle heavier tires up to 36". It pivots on a large 1.5" welded, solid steel shaft pin which rises from the bumper into the carrier frame.

Structural t-joint welds (vs. corner welds) ensures long, trouble-free operation. Polyurethane pad reduces rattling. Includes frame reinforcing brackets.



Lockout Hub Sets



Premium Hub

All metal construction and ZA alloy dial ensure years of reliable operation. Features include full 9/10th turn for robust engagement/disengagement, wave spring technology that increases reliability, heavy detents for positive engagement. Built to last. Limited Lifetime warranty

Standard Hub

The ideal choice for OEM hub replacement and virtually the same hub supplied by WARN to the OEM's for years. Features 4140 steel clutch and inner drive gear as well as a precision cast



DESCRIPTION	Stock No.
PREMIUM LOCKOUT HUB SET 1941-71 CJ	W29062
PREMIUM LOCKOUT HUB SET 1972-80 CJ	W9062
PREMIUM LOCKOUT SET SJ 19 SPLINE	W20990
STANDARD LOCKOUT HUB SET 1981-86 CJ	W28751

Heavy Duty Front Axle Shafts

Made of super high strength 4340 aircraft alloy steel. Machined to accept full-circle u-joint retaining rings and allows owners of earlier Dana 30 front axles to upgrade to the stronger 297X u-joint

FRONT INNER AXLE SHAFTS	LEFT	RIGHT
1972-83 CJ5, 76-81 CJ7	W38789	W38803
1982-86 CJ7 & CJ8	W38804	W38805
1987-06 YJ & TJ	W38821	W38875

FRONT OUTER AXLE SHAFTS RH=LH	Stock No
1972-86 CJ	W39105



W61746



TIRE CARRIER BUMPER	Stock No.
1997-04 TJ WRANGLER	W65508
1987-95 YJ WRANGLER	W65509
1976-86 CJ	W62947

TIRE CARRIER FOR ABOVE*	Stock No.	* Requires use of Warn Bumpers
1976-86 CJ7	W63253	
1987-04 YJ & TJ WRANGLER	W64337	

Front Hub Conversion Kits

Hub conversions improve vehicle flat towing and reduces driveline wear by allowing complete front end disengagement. High strength alloy axles help increase front end strength and durability. CJ kit converts hubs to 5x5.5 premium internal hubs. Cherokee and Wrangler kits uses standard flange mount hubs. NOTE: P/N W38006 & 7 lose ABS ability and require new brake rotors.



W38007

5x5.5 27 spline CJ kit

FRONT HUB CONVERSION KITS	Stock No
1972-86 CJ, 27 SPLINE HUB	W37132
1987-94 YJ & XJ, 260 U-JOINT	W38006
27 SPLINE, 5x4.5 BOLT PATTERN	
1995-06 YJ & TJ, 297 U-JOINT	W38007
27 SPLINE, 5x4.5 BOLT PATTERN	



Floating the axles eliminates the axle shaft from having to support the vehicle weight as well as hold the wheels on. These kits use high yield strength axles and feature the largest spline count possible, limited only by the differential. Internal splined wheel hubs eliminate bolts and are guaranteed never to loosen. Other features include spring-loaded lip seals in the wheel hubs and spindles as well as o-ring seals on the hub lock interface. Now sold as a two-part system: the "foundation kit" and either drive flanges or hubs. Drive flanges are designed for people who do not flat tow or who experience excessive driveline backlash from a mechanical locker.



Deluxe Stereo Security Console

16 gauge steel console has a separate compartment for mounting a stereo or other DIN sized electronic equipment. Lockable rear storage space has enough space for a CD changer, tools and other valuables. Other features include the exclusive pry-guard locking system, weather proof lid and durable powder coat finish. Removable shelf and a rubber mat for rear compartment included. Other accessories sold separately. Drilling required. STEREO NOT INCLUDED. **PLEASE SPECIFY COLOR CODE WHEN ORDERING.**



DELUXE STEREO SECURITY CONSOLE	Stock No.
1976-90 CJ & YJ WRANGLER COLOR CODE: 01, 09, 37 24"L x 10"W x 18 1/2" H	TUF-033-##
1991-95 YJ WRANGLER COLOR CODE: 01, 09, 37 24"L x 8"W x 18 1/2" H	TUF-013-##
1997-06 TJ WRANGLER COLOR CODE: 01, 09, 25, 37 35 1/2"L x 7 3/4"W x 14 1/2" H	TUF-041-##

REAR CUP HOLDER Stock No.
FOR DELUXE STEREO OR SERIES II CONSOLES (HOLDS 2 CUPS)
COLOR CODE: 01, 09, 37
PLEASE SPECIFY COLOR CODE WHEN ORDERING.



TUF-03409

Security Glove Compartments



APPLICATION	Stock No.	Replaces factory plastic or cardboard glove box. Made of 16-gauge steel it can be latched closed without locking and is secured with the Pry-guard lock.
1976-86 CJ	TUF-03501	
1987-95 YJ WRANGLER (INCLUDES GRAB BAR)	TUF-03601	
1997-06 TJ WRANGLER	TUF-04901	

Overhead Consoles

Here's a great way to mount your CB, radio or any DIN sized electronics. These expandable (from 32 1/2" - 36 1/2") overhead consoles mount between the sport bar and the windshield frame. The compartments swing up flush when not in use and are secured with the Pry-Guard locking system. They use unique U-bolts for the sport bar and existing footman holes on the windshield frame (bracket for TJ Wrangler included). No drilling required! Available in black only.



OVERHEAD CONSOLES	Stock No.
DOUBLE COMPARTMENT, BLACK: 1976-06 CJ & WRANGLER	TUF-04801
SINGLE COMPARTMENT, BLACK 1976-06 CJ & WRANGLER (will not fit 03-06 TJ)	TUF-10301

Series II Security Console

The Series II console is perfect for those who do not need the stereo compartment. It boasts more overall storage space, front drink holder with anti-rattle stabilizers, removable storage tray and inside rubber floor mat. The exclusive pry-guard 2 locking and hinging lid with built-in stop keep the console from prying eyes. **PLEASE SPECIFY COLOR CODE WHEN ORDERING.**



TUF-03201



TUF-01209



SERIES II SECURITY CONSOLE	Stock No.
1976-90 CJ & YJ WRANGLER COLOR CODE: 01, 09, 37 24"L x 10"W x 18 1/2"H	TUF-032-##
1991-95 YJ WRANGLER COLOR CODE: 01, 09, 37 24"L x 8"W x 18 1/2"H	TUF-012-##
1997-04 TJ WRANGLER COLOR CODE: 01, 09, 25, 37 35 1/2"L x 7 3/4"W x 14 1/2"H	TUF-040-##

Security Console Insert

The console insert replaces the factory plastic insert in 1997-00 TJ Wranglers. This creates a secure locking storage area while retaining the look and fit of the factory center console. Made of 16 gauge steel with the pry guard locking system. Some drilling required. Cannot be used on 2001-02 Wranglers with factory subwoofer.

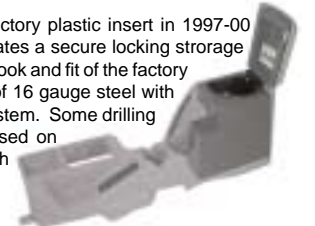

SECURITY CONSOLE INSERT	Stock No.
1997-00 TJ WRANGLER	TUF-06201

Speaker and Storage Lock Box Set

Use the wasted space on top of your wheel well to mount a set of 6x9" speakers and store valuables safely. Includes removable partition that separates the speaker from storage area for improved, distortion free sound and special cloth to help protect speakers from dirt and moisture. Pry-guard lock with durable black powder coat. Drilling required. Speakers not included.



SPEAKER & STORAGE LOCK BOX	Stock No.
1976-91 CJ & WRANGLER	TUF-01501
1992-95 WRANGLER	TUF-02001

DO NOT OPERATE VEHICLE WITHOUT COMPARTMENTS SECURELY CLOSED.



TUF-10301

Maximum Storage Security Trunk



These steel trunks are made of 16 guage steel and mount conveniently behind the rear seat. Two removable trays for smaller items are included. Features a dual latch, Pry-guard locking system. **PLEASE SPECIFY COLOR CODE WHEN ORDERING.**



REAR STORAGE TRUNK	Stock No.
1976-95 CJ & YJ WRANGLER	TUF-014-##
COLOR CODE: 01, 09, 37	
7 3/4"L(top), 12"L(Bottom) x 42 1/2"W (top), 33 3/8"W (Bottom) x 16"H	
1997-06 TJ WRANGLER	TUF-039-##
COLOR CODE: 01, 09, 25, 37	
7"L(top), 11"L(Bottom) x 34 1/2"W x 15"H	

Underseat Security Drawer



This drawer mounts under the rear seat and provides a great place to store tools and other valuables securely. New latch design allows drawer to latch closed without locking. Wrangler models fold and tumble feature will still function. Mounts to floor under rear seat. Seat then mounts to drawer. Drawer will raise rear seat 2-3". Black only.

UNDERSEAT SECURITY DRAWER	Stock No.
1976-06 CJ & WRANGLER*	TUF-02101
*Must purchase mounting kit below	

MOUNTING KITS FOR TUF-01401	Stock No.
1976-86 CJ	TUF-02601
1987-95 YJ WRANGLER	TUF-04501
1997-01 TJ WRANGLER	TUF-03801
2003-06 TJ Wrangler	TUF 07801

Rear Cargo Security Box



This oversized lock box provides secure storage for the entire cargo bed area of your Jeep® and is perfect for camping gear, spare parts and tools. It mounts using the existing holes for the rear seat and features a gas shock supported top lid and quick access tailgate both protected by the pry-guard lock system. Exterior dimensions: 27"L x 35 3/8"W x 16"H.



REAR CARGO SECURITY BOX	Stock No.
1976-06 CJ & WRANGLER	TUF-04601

Rear Cargo Security Drawer

The Rear Cargo Security Drawer mounts in place of the rear seat. Features heavy duty roller bearing slides and the pry-guard lock system for secure, trouble free operation. Exterior Dimensions: 30"L x 35 3/8"W x 8"H. 3" riser brackets (sold separately) provide convenient place to store items such as upper 1/2 doors. Divider kit (sold separately) splits drawer into smaller sections for more organized storage.

REAR CARGO SECURITY DRAWER	Stock No.
1976-06 CJ & WRANGLER	TUF-05801
ACCESSORIES FOR REAR CARGO SECURITY DRAWER	
3" RISER BRACKETS	TUF-05901
DIVIDER KIT	TUF-06001



Under Hood Security Lock Box



The Under Hood Security Lock Box mounts on top of the front fender inside the engine compartment (uses factory jack location in YJ models) and provides secure, easy to reach location for expensive tools and spare parts. Some drilling required. Exterior Dimensions: 17"L x 8 1/4"W (rear), 4"W (front) x 4 3/4"H.

UNDERHOOD LOCK BOX	Stock No.
1987-95 CJ & WRANGLER	TUF-02701

Security Door Lockers



Door Lockers prevent vulnerable Jeep® doors from being lifted off. Pick proof lock and stainless steel torx bit mounting. Works with factory 1/2 and full steel doors. Available in black only. **Will not work with stainless steel hinges.**

DOOR LOCKERS	Stock No.
1976-95 CJ7/8 & YJ WRANGLER	TUF-03701
1997-06 TJ WRANGLER	TUF-04301





Safari Sport Rack System

Get one piece now and add on later... These elements all fit together

"Safari" Sport Rack

The ultimate sport rack will hold up to 400lbs highway, 150lbs off road. Quick pin disconnects allow rack to be removed easily. Cross bars have tabs for 4 lights in front, 2 in rear. You can also remove the basket to create a great canoe/sailboard rack. Black powder coat looks great and is extremely durable.



"SAFARI" SPORT RACK:	Stock No.
1980-96 CJ5/7 & YJ WRANGLERS	WAR849
1997 & UP TJ WRANGLERS	WAR873
BASKET ONLY	WAR874
2004 - UP UNLIMITED	WAR876

**"Safari" Canoe Rack**

This all-purpose rack can handle a variety of loads up to 175 lbs such as a canoe, sailboard or a small load of lumber. Made of 1" steel tubing and powder coated for long lasting durability. Quick pins allow cross bars to be removed easily for removing your top. Cross bars include tabs for 4 lights in front and two in the rear.

"SAFARI" CANOE RACK:	Stock No.
80-96 CJ & YJ WRANGLER	WAR848
1997 & UP TJ UNLIMITED	WAR871

"Safari" Light Bars

The front light bar features tabs for four lights in front and the rear has two. Quick pin disconnects allow quick removal for folding you top down. Durable black powder coat ensures longevity.

"SAFARI" LIGHT BARS	Stock No.
1980-96 CJ7 & YJ WRANGLER FRONT	WAR844
1997 & UP TJ UNLIMITED FRONT	WAR872
1987 & UP YJ/TJ REAR	WAR843

**Safari Roof Rack**

The standard Safari Roof Rack from Warrior has a 400 lb. capacity (150 lb. off road) and is specifically designed to allow removal of the softtop or hardtop (on CJ and YJ Wrangler models only) without having to remove the rack. This rack is built for strength and is black powder coated for durability.

APPLICATION	Stock No.
CJ-7 & WRANGLERS	WAR856
1997-UP TJ WRANGLERS*	WAR858

Cargo Hitch Rack

The cargo hitch rack conveniently uses the standard 2" hitch receiver making installation and removal a snap. Available in two different widths in either standard or 8" lift for extra

DESCRIPTION	Stock No.
36" STANDARD	WAR836
46" STANDARD	WAR846
36"-8" RAISED	WAR837
46"-8" RAISED	WAR847

Adventure Rack

The Adventure Rack is a rear bolt-on cargo rack that mounts over the spare tire. It is perfect for tents, coolers or just about anything else you need to bring along. It has a 200 lb capacity and features two brackets for water/fuel cans. Standard rack will fit most CJ's with some minor modification.

ADVENTURE RACK:	Stock No.
MOST CJ 'S STANDARD RACK & CJ-7 WITH SWING AWAY TIRE	WAR832
1987-96 YJ WRANGLERS*	WAR833
1997 & UP TJ WRANGLERS*	WAR834

**Spare Tire Spacer**

APPLICATION	Stock No.
1987- UP YJ & TJ WRANGLERS	WAR91625

Class III Receiver Hitch

RECEIVER HITCH	Stock No.
1976-86 CJ	WAR1031
1987-95 WRANGLER	WAR1030
1997-UP WRANGLER	WAR1085

Bolt on class III hitch for Jeeps, with a 3500 lb. capacity. Will work with factory bumpers, bumperettes or aftermarket tubular bumpers.

Tow Bar

This universal tow bar collapses when not in use for easy storage and features pin disconnects for quick removal. It is designed to be used with a standard 2" ball and will mount to any strong, flat surface with the WAR861 mounting brackets.



DESCRIPTION	Stock No.
TOW BAR	WAR860
MOUNTING BRACKETS FOR ABOVE	WAR861

Warrior Bumpers

Here is a solution if you need lightweight towing capacity and want the convenience of a bolt on bumper system. These great looking bumpers are available with or without a class III style 2" receiver rated at a conservative 1000 lbs. The bumpers are contoured to the body and offer a very clean look. Manufactured from 3/16" steel plate HRP&O and black powder coated for durability.

APPLICATION	FRONT	REAR
1976-86 CJ WITH RECEIVER	WAR490	WAR520
1976-86 CJ WITHOUT RECEIVER	WAR485	WAR515
1987-95 WRANGLER WITH RECEIVER	WAR535	WAR510
1987-95 WRANGLER WITHOUT RECEIVER	WAR540	WAR505
1997-UP TJ UNLIMITED WITH RECEIVER	WAR525	WAR495
1997-UP TJ UNLIMITED WITHOUT RECEIVER	WAR530	WAR500

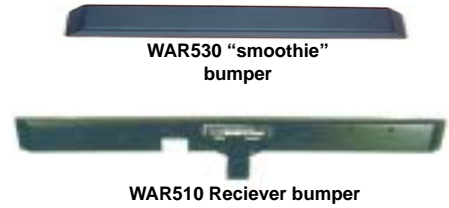

Rock Barz

Rock Barz are a combination entry step and rocker guard protector. The heavy duty steel entry step protects from wheel well to wheel well without drastically reducing clearance or drilling holes in the body. Includes diamond plate non-skid step plate and polyurethane end caps. Black powder coated.

APPLICATION	Stock No.
1953-75 CJ5	WAR7450
1976-83 CJ5	WAR7460
1976-86 CJ7	WAR7470
1987-96 YJ WRANGLER	WAR7490
1997-UP TJ WRANGLER	WAR7500
2004-UP UNLIMITED	WAR7510



ACCESSORIES

Diamond Plate Accessories by Warrior Products

Made from #3003 Aluminum Treadbite, Warrior Diamond Plate Accessories enhance the appearance of your Jeep® and offer great protection from trail hazards. Put them on your CJ to cover up years of abuse or dress up your TJ Wrangler to protect it from the elements both on and off road. Warrior Aluminum Diamond Plate Accessories are polished to a high luster that looks like chrome both will never peel, flake or rust. All corners, side plates and doors are sold in pairs.

Corner Plates

APPLICATION	Stock No.
CJ-2A & CJ-3A (WITHOUT HOLES)	WAR903
M38 & CJ-5 (WITHOUT HOLES)	WAR902
M38 & CJ-5 (FULL WRAP AROUND)	WAR902FW
CJ-7 (WITHOUT HOLES)	WAR904
CJ-7 (WITH HOLES)	WAR904A
CJ-7 12 GA. STEEL BLACK POWDER COAT (WITH HOLES)	WAR904A
CJ-7 BLACK POWDER COAT (WITH HOLES)	WAR904APC
CJ-8 (WITHOUT HOLES)	WAR910
1987-96 YJ WRANGLER (WITHOUT HOLES)	WAR907
1987-96 YJ WRANGLERS (WITH HOLES)	WAR907A
1987-96 YJ WRANGLERS BLACK POWDER COAT (WITH HOLES)	WAR907APC
1997-03 TJ WRANGLER (WITH HOLES)	WAR916A
2004-UP TJ UNLIMITED	WAR918APC



Side Plates

APPLICATION	Stock No.
1945-53 CJ-2A & CJ-3A	WAR912
1955-71 CJ-5	WAR905
1972-83 CJ-5	WAR906
1976-86 CJ-7	WAR913
1981-86 CJ-8	WAR913B
1987-96 YJ WRANGLER	WAR908
1997-UP TJ WRANGLER	WAR909
2004-UP TJ UNLIMITED	WAR919



Side Plates With Lip Under Tub

DESCRIPTION	Stock No.
1976-86 CJ-7	WAR913U
1976-86 CJ-7 BLACK POWDER COATED	WAR913UPC





Backplates

Backplates cover the tub section beneath the tailgate



1987-96 YJ WRANGLER WAR908C
CJ-7 & CJ-8 WAR913C

Front Bumper Cover



FRONT BUMPER COVER	Stock No.
1976-86 CJ5/7/8	WAR904FB
1997-UP TJ	WAR916C
2004-UP UNLIMITED	WAR918C

Half Doors

Half Doors are complete replacement door assemblies and come with paddle handles and both hinges. Doors are sealed with included weatherstripping to prevent rattling.

*1980-95 models come with rotary style paddle handles for factory door pins.

HALF DOORS:	Stock No.
1955-75 CJ-5	WAR902DOOR
1976-83 CJ-5	WAR905DOOR
1980-95 CJ-7 & WRANGLER*	WAR907DOOR
1980-95 CJ-7 & WRANGLER* (BLACK POWDER COAT)	WAR907DOORPC
1997-UP TJ & UNLIMITED	WAR916DOOR
1997-UP TJ & UNLIMITED	WAR916DOORPC

Running Board Step



These diamond plate step inserts fit the factory running boards and compliment other warrior diamond plate accessories.

RUNNING BOARD STEP:	Stock No.
1987-96 YJ WRANGLERS	WAR908S
1997-02 TJ WRANGLERS	WAR916S

Entry Guards

Protects bottom of the front door opening.
For full soft doors only, will not work with factory full or half steel doors.

ENTRY GUARDS:	Stock No.
1951-83 CJ-5	WAR901S
1976-86 CJ-7	WAR901T



Frame Covers



Covers front portion of frame under front grill.

FRAME COVERS:	Stock No.
CJ-7 & CJ-8	WAR904FC
87-96 YJ WRANGLER	WAR907FC
1997-UP TJ	WAR916FC
2004-UP UNLIMITED	WAR918FC



Short Corners

When a full corner plate isn't needed the short corners match the height of the back plate and sideplates perfectly.

SHORT CORNERS:	Stock No.
CJ-5	WAR802
CJ-7	WAR804
YJ WRANGLER	WAR807
TJ WRANGLER	WAR816



Tailgate Covers

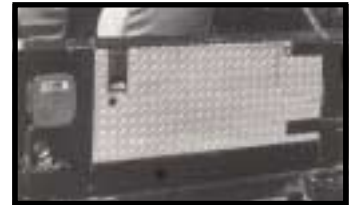

TAILGATE COVERS:	Stock No.
1987-95 WRANGLER	WAR908D
1976-86 CJ-7	WAR913D
1997-UP TJ WRANGLER	WAR909D NEW
2004-UP UNLIMITED	WAR918D

Gas Tank Cover

Covers stock gas tank and provides an additional layer of protection the elements and increases impact protection. Uses factory mounting hardware.



GAS TANK COVERS:	Stock No.
C J-7 (15 Gallon)	WAR904GTC
1987-96 YJ WRANGLER (15 Gallon)	WAR907GTC
CJ-7 & 87-96 WRANGLER (20 Gallon)	WAR907GTC20
1997-02 TJ WRANGLER (20 Gallon)	WAR916GTC20

Front Floor Boards

Cover up repairs with these diamond plate floor boards. Built for both the passenger and driver side front floor pan area. Contoured to the floor for custom



FLOOR BOARDS	Stock No.
1976-86 CJ-7	WAR904BRD

Tubular Nerf Bar Step Plates

Heavy duty polished aluminum for rugged service on 3" nerf bars. Provide safe, non-skid surface to step on.

Stock No.	
12"	WAR712
18"	WAR718



See Warrior Suspension Items on Page: 148



ARB has been challenging the conventional thinking of off road equipment for over 26 years, and the ARB Air Locker has been a success from the very beginning. Created to provide 100% traction on demand, without sacrificing any of the vehicles highway driving performance. ARB Air Lockers employ a 12 volt air compressor (sold separately) to activate, and deactivate, a solid and durable locking mechanism inside the differential. This provides the traction you need, when you need it, the flip of a switch, all within the comfort and safety of the drivers seat. Each locker is manufactured from the highest quality alloy steels and when purchased with the

compressor, includes everything required for proper installation such as switches, air lines and fittings. Professional installation recommended but not required.

ARB Air Locker: 'CAUSE THE EARTH AIN'T FLAT



APPLICATION	Stock No.
1970-03 DANA 44 30 SPLINE 3.92 & UP RATIO FITS: CJ, MJ, TJ, ZJ, WJ, SJ	ARB-RD06
1970-03 DANA 44 30 SPLINE 3.73 & DOWN RATIO FITS: CJ, MJ, TJ, ZJ, WJ, SJ	ARB-RD07
1972-03 DANA 30 27 SPLINE 3.73 & UP RATIO FITS: CJ, XJ, YJ, TJ, ZJ, WJ	ARB-RD100
1972-03 DANA 30 27 SPLINE 3.54 & DOWN RATIO FITS: CJ, XJ, YJ, TJ, ZJ, WJ	ARB-RD101
1976-86 AMC 20 29 SPLINE 3.08 & UP RATIO FITS: CJ & SJ	ARB-RD60
1990-03 DANA 35 W/C-CLIP 27 SPLINE 2.73-3.31 RATIO FITS: YJ, TJ, XJ, ZJ	ARB-RD103
1990-03 DANA 35 W/C-CLIP 27 SPLINE 3.54 & UP RATIO FITS: YJ, TJ, XJ, ZJ	ARB-RD102
1997-UP CHRYSLER 8.25" 29 SPLINE, ALL RATIOS FITS: ZJ, WJ, KJ	ARB-RD93
SUPER DANA 30, 3.73 AND UP RATIO	ARB-RD104
SUPER DANA 35, 3.54 AND UP RATIO	ARB-RD105



SNORKEL	NEW	Stock No.
2000-06 TJ (BOTH 4 & 6 CYL)		ARB-SS1055HF



ARB LOCKER ACCESSORIES:	Stock No.
12V AIR COMPRESSOR KIT	ARB-RDCKA
PORTABLE 12V AIR COMPRESSOR KIT	ARB-RDCPA
AIR LINE SERVICE KIT	ARB-ASK001
HEAVY DUTY AIR LINE KIT	ARB-HDAL
REPLACEMENT SOLENOID	ARB-180103
REPLACEMENT 40 AMP ELECTRIC RELAY	ARB-CO42
TIRE INFLATION KIT	ARB-PUKT

ARB Bull Bars

Absolutely the highest quality aftermarket bumper ever. Each bar is made from premium cold rolled sheet steel and 250 grade heavy wall tubing. Computer controlled laser cutting equipment, mandrel bending and MIG welders shape the material into a structurally sound shell. Additional reinforcements and gusseting are then added along with provisions for lighting and recovery points. They feature fully integrated or recessed winch mounting systems (designed for use with Warn XD and XD model winches) able to withstand the high stresses incurred when winching. Finished in a 3 stage, ultra high quality powder coating for long lasting durability and good looks.

Bull Bars....Protection Without Compromise.



ALL JEEP
BUM-
PERS ARE
AIRBAG AP-
PROVED!



APPLICATION	Stock No.
1984-96 XJ CHEROKEE	ARB-3450010
1987-96 YJ WRANGLER	ARB-3450040
1993-98 ZJ GRAND CHEROKEE	ARB-3450060
1997-01 XJ CHEROKEE W/SRS	ARB-3450080
1997-04 TJ WRANGLER	ARB-3450070
1999-03 WJ GRAND CHEROKEE	ARB-3450100*
1999-00 WJ GRAND CHEROKEE	ARB-3450090
2001-UP KJ LIBERTY	ARB-3450110

LIMITED QUANTITIES!

*IMPORTANT: FITMENT OF BULL BAR TO 1999-2000 WJ REQUIRES UPGRADE TO HYDRAULIC SYSTEM FROM LATER MODEL

ACCESSORIES



K & N Air Filters:
Deliver High Airflow
And
Superior Dirt Protection!



Featuring a
10 Year/
Million Mile
Limited
Warranty



APPLICATION

AIR FILTER, 1987-96 XJ CHEROKEE, BOTH 2.5L 4-CYL & 4.0L 6-CYL	KN-332018
AIR FILTER, 1987-95 YJ 2.5L 4 CYL & 1991-95 YJ 4.0L 6-CYL	KN-332046
AIR FILTER, 1993-98 ZJ GRAND-CHEROKEE V8 (BOTH 5.2L & 5.9L)	KN-332048
AIR FILTER, 1997-04 TJ, BOTH 2.5L 4-CYL & 4.0L 6-CYL	KN-332114
AIR FILTER, 1997-01 XJ CHEROKEE, BOTH 2.5L 4-CYL & 4.0L 6-CYL	KN-332122
AIR FILTER, 1999-04 WJ GRAND-CHEROKEE 4.0L & 4.7L (except 02&03 4.7L high output)	KN-332139
AIR FILTER, 2002-UP 3.7L V6 KJ LIBERTY	KN-332233
AIR FILTER, 1980-86 4-CYL CJ, 1972-86 6-CYL CJ, 1987-90 6-CYL YJ	KN-E1080
AIR FILTER, 1972-83 AMC-V8 CJ	KN-E1100
FILTER CARE SERVICE KIT	KN-995050
OIL FILTER, 2002-UP 2.4L 4-CYL KJ LIBERTY	KN-HP1002
OIL FILTER, 1972-80 6-CYL CJ, 1972-86 AMC-V8	KN-HP2003
OIL FILTER, 1991-04 2.5L, 1991-03 4.0L, 1993-98 V8 ZJ 5.2L & 5.9L, 1999-04 V8 WJ 4.7L	KN-HP2004
OIL FILTER, 1981-86 6-CYL AMC (CJ,...)	KN-HP2006
OIL FILTER, 1987-90 2.5L, 1987-90 4.0L, 1987-90 4.2L, 1986 2.8L XJ, 1987-90 V8 SJ	KN-HP2007
OIL FILTER, 2002-UP V6 3.7L KJ LIBERTY	KN-HP2009
FUEL INJECTION PERFORMANCE KIT (FIPK), 1997-03 4.0L WRANGLER	KN-5715141
FUEL INJECTION PERFORMANCE KIT (FIPK), 1991-95 4.0L WRANGLER	KN-571521
7" CHROME AIR CLEANER, 1972-86 6-CYL CJ, 1/2" OD VENT TUBE 2-5/8" NECK FLANGE	KN-601030
9" CHROME AIR CLEANER, 1972-86 6-CYL CJ, 3/4" OD VENT TUBE 2-5/8" NECK FLANGE	KN-601080
14" CHROME AIR CLEANER, V8 AMC	KN-601264



AIR FILTERS, OIL FILTERS, INTAKE KITS & MORE...!

AUTO VENT SHADE

VENT SHADES:

APPLICATION	Stock No.
1976-95 CJ & YJ (FULL STEEL DOORS)	AVS-12415
1984-96 X 4 DOOR	AVS-14412



BUG DEFLECTOR II:



APPLICATION	Stock No.
1972-86 CJ	AVS-24925
1987-04 YJ & TJ WRANGLER	AVS-24700
1984-01 XJ CHEROKEE	AVS-24313
1993-98 ZJ GRAND CHEROKEE	AVS-25526
1999-04 WJ GRAND CHEROKEE	AVS-25502

VENT VISORS:

APPLICATION	Stock No.
1976-95 CJ & YJ WRANGLER W/ FULL STEEL DOOR	AVS-92855
1997-04 TJ WRANGLER	AVS-92054
1984-01 XJ CHEROKEE 2-DOOR	AVS-92111
1984-01 XJ CHEROKEE 4 DOOR	AVS-94212
1993-98 ZJ GRAND CHEROKEE	AVS-94320
1999-04 WJ GRAND CHEROKEE	AVS-94650

CARGO LINERS:



APPLICATION	Stock No.
1984-01 XJ CHEROKEE	AVS-74339
1993-98 ZJ GRAND CHEROKEE	AVS-74557
1999-04 WJ GRAND CHEROKEE	AVS-75825



TAILLIGHT COVERS:

APPLICATION	Stock No.
1976-86 CJ	AVS-36244
1987-04 YJ & TJ WRANGLER	AVS-36557
1984-96 XJ CHEROKEE	AVS-36025
1997-01 XJ CHEROKEE	AVS-36143
1993-98 ZJ GRAND CHEROKEE	AVS-36837
1999-01 WJ GRAND CHEROKEE	AVS-36702

TINTED HEADLIGHT COVERS:



APPLICATION	Stock No.
1991-95 YJ WRANGLER	AVS-37636
1997-04 TJ WRANGLER	AVS-37040
1991-96 XJ CHEROKEE	AVS-37545
1997-01 XJ CHEROKEE	AVS-37624
1993-98 ZJ GRAND CHEROKEE	AVS-37517
1999-04 WJ GRAND CHEROKEE	AVS-37731

STEPSHIELD ENTRY GRAND:

APPLICATION	Stock No.
1976-95 CJ & YJ WRANGLER	AVS-88015
1997-04 TJ WRANGLER	AVS-88106



2006

Xynet Floor Cover Kit

The Pro-Line Floor Covering kit, is a 1 piece molded Xynet floor covering with the look and feel of heavy duty rubber. Simply hose off for easy cleaning.

WRANGLER YJ & CJ7 1976-1995

Black - NP-65701X

WRANGLER CJ & YJ 1976-1995

Gray - NP-650-11
Charcoal - NP-650-13
Black - NP-650-01
Coffee - NP-650-08
Sand - NP-650-10



ACCESSORIES

CATCH-ALL PREMIUM

	Front Set - 2pcs	Rear Seat	Rear Cargo
1976-1995 CJ & YJ WRANGLER	Grey - NP-60443-0 Beige - NP-60443-3 Charcoal - NP-60443-4	Grey - NP-62443-0 Beige - NP-62443-3 Charcoal - NP-62443-4	Grey - NP-61443-0 Beige - NP-61443-3 Charcoal - NP-61443-4
1997-UP TJ WRANGLER	Grey - NP-60423-0 Beige - NP-60423-3 Charcoal - NP-60423-4	Grey - NP-62423-0 Beige - NP-62423-3 Charcoal - NP-62423-4	Grey - NP-61423-0 Beige - NP-61423-3 Charcoal - NP-61423-4
1995-2001 CHEROKEE	Grey - NP-60403-0 Beige - NP-60403-3 Charcoal - NP-60403-4	Grey - NP-62403-0 Beige - NP-62403-3 Charcoal - NP-62403-4	Grey - NP-61403-0 Beige - NP-61403-3 Charcoal - NP-61403-4
1996-1998 GRAND CHEROKEE	Grey - NP-60413-0 Beige - NP-60413-3 Charcoal - NP-60413-1	Grey - NP-62413-0 Beige - NP-62413-3 Charcoal - NP-62413-1	Grey - NP-61413-0 Beige - NP-61413-3 Charcoal - NP-61413-1
1999-UP GRAND CHEROKEE	Grey - NP-60433-7 Charcoal - NP-60433-4	Grey - NP-62433-7 Charcoal - NP-62433-4	Grey - NP-62433-7 Charcoal - NP-62433-4
2000-UP LIBERTY	Grey - NP-6079-37 Charcoal - NP-6079-49	Grey - NP-6279-37 Charcoal - NP-6279-49	Grey - NP-6179-37 Charcoal - NP-6179-49

Cargo-Logic™
Cargo Area Protection



FLOOR PROTECTION & CARGO PROTECTION IN ONE

Cargo Logic offers total cargo bay protection for your Jeep floor and cargo. This molded liner is stain and moisture resistant barrier, while the Cargo-Loks protect cargo from shifting while in transit.



CATCH-ALL X-RACING

X-Racing: Front Set - 2 pcs.

CJ & YJ Wrangler 1976-1995

Blk/Yellow - NP-604401YL
Blk/Red - NP-604401RD
Blk/Blue - NP-604401BL

TJ Wrangler 1997-UP

Blk/Yellow - NP-604201YL
Blk/Red - NP-604201RD
Blk/Blue - NP-604201BL

X-Racing: Rear Set - 2 pcs.

CJ & YJ Wrangler 1976-1995

Blk/Yellow - NP-624401YL
Blk/Red - NP-624401RD
Blk/Blue - NP-624401BL

TJ Wrangler 1997-2000

Blk/Yellow - NP-624201YL
Blk/Red - NP-624201RD
Blk/Blue - NP-624201BL

Cherokee 1995-2001

Grey - NP-7240-02
Tan - NP-7240-12
Charcoal - NP-7240-00

Grand Cherokee 1996-1998

Grey - NP-7241-02
Tan - NP-7241-12
Charcoal - NP-7241-00

Grand Cherokee 1999-UP

Grey - NP-7243-02
Tan - NP-7243-12
Charcoal - NP-7243-00

Liberty 2002-UP

Grey - NP-7279-02
Charcoal - NP-7279-00

CATCH - ALL-XTREME

CJ & YJ Wrangler 1976-1995 TJ Wrangler 1997-UP

Front Set - 2 pcs.	Grey - NP-4044-02 Tan - NP-4044-12 Black - NP-4044-01	Grey - NP-4042-02 Tan - NP-4042-12 Black - NP-4042-01
Rear Set - 2 pcs.	Grey - NP-4244-02 Tan - NP-4244-12 Black - NP-4244-01	Grey - NP-4242-02 Tan - NP-4242-12 Black - NP-4242-01
Rear Cargo	Grey - NP-4144-02 Tan - NP-4144-12 Black - NP-4144-01	Grey - NP-4142-02 Tan - NP-4142-12 Black - NP-4142-01



CATCH-ALL XTREME

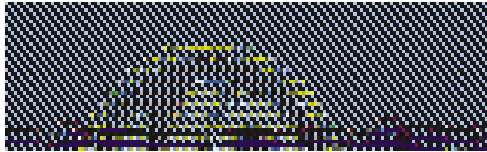

2006



* All Light Kits include:
(2) Lights, (2) Stone Guards,
Complete Wiring Harness,
relay and switch

SLIMLITE LAMPS:

APPLICATION	Stock No.
6" Round, 100 Watt Driving Light Kit*, Chrome	KCH-123
6" Round, 100 Watt Driving Light Kit*, Black	KCH-124
6" Round, 100 Watt Fog Light Kit*, Chrome	KCH-126
6" Round, 100 Watt Fog Light Kit*, Black	KCH-127
6" Round, 130 Watt Ice Blue Halogen Light Kit*, Titanium	KCH-110

LONG RANGE LAMPS:

APPLICATION	Stock No.
6" Round, Long Range, 130 Watt Light Kit*, Chrome	KCH-120
6" Round, Long Range, 130 Watt Light Kit*, Black	KCH-121
6" Round, Long Range, 130 Watt Ice Blue Halogen Driving Light Kit*, Titanium	KCH-122
6" Round, Long Range, 130 Watt Ice Blue Halogen Fog Light Kit*, Titanium	KCH-125
5" x 7" Rectangular, 100 Watt, Light Kit*, Chrome	KCH-739
5" x 7" Rectangular, 100 Watt, Light Kit*, Black	KCH-740
6" x 9" Rectangular, 100 Watt, Light Kit*, Black	KCH-241



KCH-123



KCH-124

The Night Comes Alive With KC's!

DAYLIGHTER LAMPS:

APPLICATION	Stock No.
6" Round, 100 Watt Light Kit*, Chrome	KCH-237
6" Round, 150 Watt Light Kit*, Chrome	KCH-622
6" Round, 100 Watt Light Kit*, Black	KCH-238
6" Round, 150 Watt Light Kit*, Black	KCH-623
6" Round, 100 Watt Light Kit*, Stainless Steel	KCH-239
6" Round, 150 Watt Light Kit*, Stainless Steel	KCH-624
6" Round, 130 Watt Light Kit*, Titanium	KCH-250

ALL SEASON LAMPS:

APPLICATION	Stock No.
2" x 6" Rectangular, 55 Watt Light Kit*, Black	KCH-516
5" x 7" Rectangular, 55 Watt Light Kit*, Black	KCH-735
46 Series All Season 4" x 6" Rectangular, with Quartz Halogen 55 Watt bulbs Light Kit*, Black	KCH-772

LIGHT COVERS:

APPLICATION	Stock No.
6" Round, With White KC Logo, Black, Pair	KCH-5100
6" Round, With Red KC Logo, Black, Pair	KCH-5110
6" Round, With White Brushed KC Logo, Black, Pair	KCH-5117
6" Round, With Blue Brushed KC Logo, Black, Pair	KCH-5121
6" Round, With Green Brushed KC Logo, Black, Pair	KCH-5123
6" Round, With Sunglass KC Logo, Black, Pair	KCH-5205
5" x 7" Rectangular, W/ Red Brushed KC Logo, Black, Pair	KCH-5310
6" Round, Clear Acrylic Light Shield, Pair	KCH-7207
6" Round, With White Brushed KC Logo, Black, Pair	KCH-5117
6" Round, With Black KC Logo, Yellow, Pair	KCH-5101
6" Round, With Patriotic KC Logo, White, Each	KCH-5116
6" Round, With Black Brushed KC Logo, White, Pair	KCH-5120
6" Round, With Red KC Logo, White, Pair	KCH-5122
6" Round, With Smiley Face KC Logo, Yellow, Each	KCH-5202
6" Round, Chrome Rock Shield, Pair	KCH-7203
5" x 7" Rectangular, With White Brushed KC Logo, Black, Pair	KCH-5317

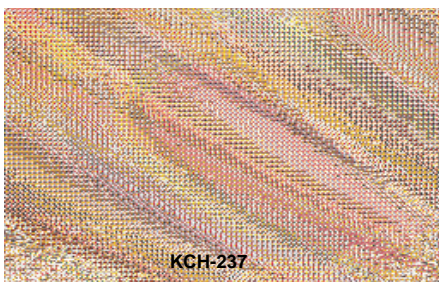

KCH-237

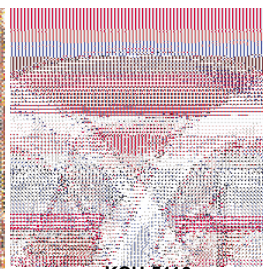

KCH-5116

MISCELLANEOUS ITEMS:

APPLICATION	Stock No.
Lock Set (For All Daylighters EXCEPT Stainless Steel)	KCH-7220
Lock Set (For 6" x 9" and 6" Round Daylighters EXCEPT Slimlites)	KCH-7221
6" Round High Impact Plastic Stone Guard, Each: Black	KCH-7210
6" Round High Impact Plastic Stone Guard, Each: Chrome	KCH-7211
6" Round High Impact Plastic Stone Guard, Each: White	KCH-7212
6" Round High Impact Plastic Stone Guard, Each: Yellow	KCH-7213
130 Watt Replacement Bulb, Each	KCH-2766



KCH-2766

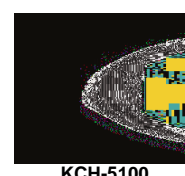

KCH-5100

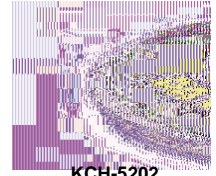

KCH-5202

CJ Side Marker Lamps



1976-86 CJ MARKER LIGHTS	Stock No.	Replaces
AMBER SIDE-MARKER LENS, FRONT	12401.01	994020
AMBER SIDE-MARKER KIT	12401.02	994020k
SOCKET, WIRING, BULB & LENS		
RED SIDE-MARKER LENS, REAR	12401.03	994021
RED MARKER KIT	12401.04	994021k
SOCKET, WIRING, BULB, & LENS		
SOCKET & WIRING FOR SIDE-MARKERS	12401.05	5455853

Headlight Bucket Assembly Fits Driver & Passenger Sides

1972-86 CJ HEADLIGHT ASSY, With Light, ea	12402.01	998972
1972-86 CJ HEADLIGHT ASSY, With Light, pair	12402.02	998972K
1997-UP TJ Wrangler HEADLIGHT ASSY, With Light, RH	12402.04	55055032AC
1997-UP TJ Wrangler HEADLIGHT ASSY, With Light, LH	12402.03	55055033AC
MB & GPW HEADLIGHT ASSY, Without Light	12402.05	A-1304



YJ Wrangler Side Marker Lamp



1987-95 YJ WRANGLER MARKER LIGHTS	Stock No.	Replaces
FRONT SIDE MARKER (AMBER)	12401.06	56001424



Early CJ Tail Lamps

1946-75 CJ TAIL LAMPS	Stock No.	Replaces
ROUND TAIL LAMP, LEFT	12403.01	801157
ROUND TAIL LAMP, RIGHT	12403.02	801158
TAIL LAMP BUCKET ASSY, (W/O LENS OR BULB) MB AND GPW, RH=LH	12403.50	A1073



TJ Wrangler Side Marker Lamp



1997-03 TJ WRANGLER MARKER LIGHTS	Stock No.	Replaces
FRONT SIDE MARKER, RIGHT	12401.08	55155628AB
FRONT SIDE MARKER, LEFT	12401.07	55155629AB

1976-86 CJ Tail Lamps



CJ TAIL LAMPS	Stock No.	Replaces
1976-80 TAIL LAMP, LEFT, BLACK	12403.03	5457197
1976-80 TAIL LAMP, LEFT, CHROME	12403.05	5457197C
1976-80 TAIL LAMP, RIGHT, BLACK	12403.04	5457198
1976-80 TAIL LAMP, RIGHT, CHROME	12403.06	5457198C
1981-86 TAIL LAMP, RIGHT, BLACK	12403.08	5758254
1981-86 TAIL LAMP, RIGHT, CHROME	12403.10	5758254C
1981-86 TAIL LAMP, LEFT, BLACK	12403.07	5758255
1981-86 TAIL LAMP, LEFT, CHROME	12403.09	5758255C

1987-95 YJ Wrangler Tail Lamps



YJ WRANGLER TAIL LAMPS	Stock No.	Replaces
1987-90 TAIL LAMP, RIGHT, BLACK	12403.12	TBA
1987-90 TAIL LAMP, LEFT, BLACK	12403.11	TBA
1991-95 TAIL LAMP, RIGHT, BLACK	12403.14	56018648
1991-95 TAIL LAMP, RIGHT, CHROME	12403.16	56018648C
1991-95 TAIL LAMP, LEFT, BLACK	12403.13	56018649
1991-95 TAIL LAMP, LEFT, CHROME	12403.15	56018649C

1955-71 CJ Park & Signal Lamps



	Stock No.	Replaces
1955-71 CJ LAMP ASSEMBLY (AMBER)	12405.01	938897
1955-71 CJ LAMP ASSEMBLY (CLEAR)	12405.02	938897-CL
1955-71 CJ LENS ONLY (AMBER)	12405.03	935924
1955-71 CJ LENS ONLY (CLEAR)	12405.04	931594
1972-75 CJ LAMP ASSEMBLY	12405.05	989852

1976-95 Tail Lamp Lens

	Stock No.	Replaces
LENS FOR ALL TAIL LAMPS	12404.01	8129642



1987-93 Wrangler Park & Signal Lamps



	Stock No.	Replaces
1987-93 YJ WRANGLER	12405.10	56001378
1997-02 TJ WRANGLER	12405.11	55055020AC

1976-86 CJ Park & Signal Lamps



	Stock No.	Replaces
LAMP ASSEMBLY WITH CLEAR LENS	12405.06	5752771
LAMP ASSEMBLY WITH AMBER LENS (EXPORT)	12405.07	5752771A
LENS ONLY, CLEAR	12405.08	8127449
LENS ONLY, AMBER (EXPORT)	12405.09	8127449A

1946-75 CJ Back-up Lamps



	Stock No.	Replaces
ASSEMBLY (INCL. SOCKET, BULB AND WIRING)	12406.01	945659
LENS ONLY	12405.04	931594



Tail Lamps



Stock No. Replaces

1984-96 XJ CHEROKEE, RIGHT	12403.18	83504316
1984-96 XJ CHEROKEE, LEFT	12403.17	83504317
1997-01 XJ CHEROKEE, RIGHT	12403.20	4897398AA
1997-01 XJ CHEROKEE, LEFT	12403.19	4897399AA

1984-01 XJ CHEROKEE



12405.12

XJ Cherokee Parking Lamps

Stock No. Replaces

1984-96 XJ CHEROKEE, RIGHT	12405.12	56000098
1984-96 XJ CHEROKEE, LEFT	12405.13	56000099
1997-01 XJ CHEROKEE, RIGHT	12405.14	55055142
1997-01 XJ CHEROKEE, LEFT	12405.15	55055143



12405.14



Side Lamps



Stock No. Replaces

1984-96 XJ CHEROKEE, RIGHT	12401.10	56000110K
1984-96 XJ CHEROKEE, LEFT	12401.09	56000111K
1997-01 XJ CHEROKEE, RIGHT	12401.12	55055146
1997-01 XJ CHEROKEE, LEFT	12401.11	55055147

XJ Cherokee Fog Lamps

Stock No. Replaces

1997-01 XJ CHEROKEE, RIGHT	12407.02	55055274AB
1997-01 XJ CHEROKEE, LEFT	12407.01	55055275AB
1993-95 XJ CHEROKEE RH=LH	NEW 12407.09	4713582
1993-95 ZJ GRAND CHEROKEE	NEW 12407.09	4713582



12407.02

1993-04 ZJ & WJ Grand Cherokee

Grand Cherokee Headlamps



ZJ



ZJ Grand Cherokee Parking Lamps

1993-98 ZJ GRAND CHEROKEE

CORNER PARKING LAMP

Stock No. Replaces

PARKING LAMP, RIGHT	12405.16	56005104
PARKING LAMP, LEFT	12405.17	56005105

GRAND CHEROKEE HEADLAMPS

Stock No. Replaces

1993-98 ZJ GRAND CHEROKEE, RIGHT	12402.06	56005092
1993-98 ZJ GRAND CHEROKEE, LEFT	12402.07	56005093
1999-04 WJ GRAND CHEROKEE LAREDO, RIGHT	12402.08	55155128
1999-04 WJ GRAND CHEROKEE LAREDO, LEFT	12402.09	55155129
1999-04 WJ GRAND CHEROKEE LIMITED, RIGHT	12402.10	55155552
1999-04 WJ GRAND CHEROKEE LIMITED, LEFT	12402.11	55155553

FOG LAMP GRAND CHEROKEE

Stock No. Replaces

1999-03 WJ GRAND CHEROKEE, RIGHT	12407.04	55155136AB
1999-03 WJ GRAND CHEROKEE, LEFT	12407.03	55155137AB
1997-98 ZJ GRAND CHEROKEE, RIGHT	12407.06	55155312
1997-98 ZJ GRAND CHEROKEE, LEFT	12407.05	55155313
1993-95 XJ CHEROKEE RH=LH	NEW 12407.09	4713582
1993-95 ZJ GRAND CHEROKEE	NEW 12407.09	4713582

ZJ Grand Cherokee Front Turn Signals 2002-2003



1993-98 ZJ GRAND CHEROKEE

FRONT TURN SIGNALS

Stock No. Replaces

CLEAR (US), RIGHT	12401.14	56005098
CLEAR (US), LEFT	12401.13	56005099
AMBER (EXPORT), RIGHT	12401.16	55054580
AMBER (EXPORT), LEFT	12401.15	55054581

ZJ

Grand Cherokee Tail Lamps



WJ

Liberty Lamps

LIBERTY 2002-UP LAMPS:

Stock No. Replaces

THROUGH OCT 5, 2002) HEADLAMP ASSY, RIGHT	12402.12	55155808AA
2002-03 (THROUGH OCT 5, 2002) HEADLAMP ASSY, RIGHT	12402.12	55155808AA
2003-UP (STARTING OCT 6, 2002) HEADLAMP ASSY, RIGHT	12402.14	55155808AB
2002-03 (THROUGH OCT 5, 2002) HEADLAMP ASSY, LEFT	12402.13	55155809AA
2003-UP (STARTING OCT 6, 2002) HEADLAMP ASSY, LEFT	12402.15	55155809AB
2005-06 KJ LIBERTY RH HEADLGT ASSY.	12402.16	55157140AA
2005-06 KJ LIBERTY LH HEADLING ASSY.	NEW 12402.17	55157141AA
2002-UP PARK-SIGNAL-SIDE MARKER, RIGHT	NEW 12401.18	55155910AA
2002-UP PARK-SIGNAL-SIDE MARKER, LEFT	12401.17	55155911AA
2005 KJ LIBERTY RH, SIDE MARKER LAMP	NEW 12401.20	55156882AB
2005 KJ LIBERTY LH, SIDE MARKER LAMP	NEW 12401.21	55156883AB

LIBERTY 2002-UP TAIL LAMPS

Stock No. Replaces

2005 KJ LIBERTY, W/O AIR DAM LH	NEW 12403.29	55157061AC
2005 KJ LIBERTY, W/O AIR DAM RH	NEW 12403.28	55157060AC
2002-04 TAILAMP, RIGHT	12403.26	55155828AE
2002-04 TAILAMP, LEFT	12403.25	55155829AE

LIBERTY 2002-UP FOG LAMPS

Stock No. Replaces

2002-UP FOG LAMP, RIGHT	12407.08	55155822AB
2002-UP FOG LAMP, LEFT	12407.07	5515583AB

SEALED BEAM LAMPS AND REPLACEMENT BULBS

REPLACEMENT LIGHT BULBS

	Stock No.	Replaces
1972-86 CJ-FRONT PARKING LAMP BULB, AMBER	12408.01	G9428904
1987-93 YJ WRANGLER-FRONT PARKING LAMP BULB	12408.02	9438848
1994-95 YJ WRANGLER-FRONT PARKING LAMP BULB	12408.03	3157
1976-98 CJ, WRANGLER (YJ & TJ)-REAR BACK-UP BULB	12408.04	3209543
1976-98 CJ, WRANGLER (YJ & TJ)-REAR STOP, TURN & TAIL LIGHT BULB	12408.05	3209544
1972-98 CJ, WRANGLER (YJ & TJ)-SIDEMARKER BULB	12408.06	994037



FLASHER RELAYS



1976-95 CJ & YJ FLASHERS	Stock No.	Replaces
2 BLADE (552)	12411.01	5452266
2 BLADE (224)	12411.02	3212068
3 BLADE (550)	12411.03	56000903

ROUND SEALED BEAM HEADLIGHTS

	Stock No.	Replaces
1965-86 CJ SEALED	12409.01	8124687
1946-64 CJ SEALED, 6 VOLT	12409.02	924212
MB SEALED BEAM, 6 VOLT	12409.03	911842
1965-86 CJ HALOGEN	12409.04	83500341
1997-06 TJ WRANGLER	12409.04	83500341
1972-86 CJ HEAD LIGHT BUCKET ASSY	12402.01	998972

RECTANGULAR HALOGEN

1987-95 YJ WRANGLER	12409.05	8134319
1984-01 XJ CHEROKEE HALOGEN	12409.05	8134319

MISCELLANEOUS ITEM

HEADLIGHT ADJUSTING SCREW, 1972-86 CJ	12410.01	4005808
---------------------------------------	----------	---------

LIGHT BEZELS, HOUSINGS AND RETAINING RINGS



12420.01



12419.05



12419.03



12420.03 / 12421.02 / 12421.01

	Stock No.	Replaces
1945-53 CJ2A, CJ3A, HEADLIGHT BEZEL, CHROME, EACH	12419.01	643732
1953-71 CJ3B, CJ5, CJ6, HEADLIGHT BEZEL, CHROME, EACH	12419.02	649518
1972-86 CJ HEADLIGHT BEZEL, CHROME, EACH	12419.03	5460087
1972-86 CJ HEADLIGHT RETAINING RING, EACH	12420.01	8128749
1988-06 TJ WRANGLER HEADLIGHT RETAINING RING, EACH	12420.02	4874378
1987-96 YJ WRANGLER HEADLIGHT BEZEL, CHROME, PAIR	12419.05	56003104K
1997-06 TJ WRANGLER HEADLIGHT BEZEL, RH, CHROME	12419.06	55055046
1997-06 TJ WRANGLER HEADLIGHT BEZEL, LH, CHROME	12419.07	55055047
1997-06 TJ WRANGLER HEADLIGHT BEZEL, PAIR, CHROME	12419.08	55055046K
1997-06 TJ WRANGLER HEADLIGHT BEZEL PAIR, BLACK	12419.23	
1997-06 YJ HEADLIGHT BEZEL BEZEL PAIR, BLACK	12419.24	
1987-96 YJ WRANGLER HEADLIGHT RETAINING RING	12420.03	56001260
1987-96 YJ WRANGLER HEADLIGHT HOUSING, RH	12421.02	56001278
1987-96 YJ WRANGLER HEADLIGHT HOUSING, LH	12421.01	56001279



12419.08



12419.23



12419.24

XJ CHEROKEE

HEADLIGHT BEZELS & RETAINING RINGS

Stock No. Replaces

1984-01 XJ CHEROKEE HEADLIGHT RETAINING RING	12420.03	56001260
1984-01 XJ CHEROKEE HEADLIGHT HOUSING, RH	12421.02	56001278
1984-01 XJ CHEROKEE HEADLIGHT HOUSING, LH	12421.01	56001279
1984-90 XJ CHEROKEE HEADLIGHT BEZEL, GRAY, RIGHT	12419.10	55000682
1984-90 XJ CHEROKEE HEADLIGHT BEZEL, GRAY, LEFT	12419.09	55000683
1984-90 XJ CHEROKEE HEADLIGHT BEZEL, CHROME, RIGHT	12419.12	55002244
1984-90 XJ CHEROKEE HEADLIGHT BEZEL, CHROME, LEFT	12419.11	55002245
1991-96 XJ CHEROKEE HEADLIGHT BEZEL, BLACK/CHROME, RIGHT	12419.14	55034078
1991-96 XJ CHEROKEE HEADLIGHT BEZEL, BLACK/CHROME, LEFT	12419.13	55034079
1993-96 XJ CHEROKEE HEADLIGHT BEZEL, BLACK, RIGHT	12419.16	55054930
1993-96 XJ CHEROKEE HEADLIGHT BEZEL, BLACK, LEFT	12419.15	55054931
1997-01 XJ CHEROKEE HEADLIGHT BEZEL, BLACK, RIGHT	12419.18	55055136
1997-01 XJ CHEROKEE HEADLIGHT BEZEL, BLACK, LEFT	12419.17	55055137
1997-01 XJ CHEROKEE HEADLIGHT BEZEL, RIGHT *	12419.20	5EM72SW1
1997-01 XJ CHEROKEE HEADLIGHT BEZEL, LEFT *	12419.19	5EM73SW1



12419.10



12419.13



12419.12



12419.16

* NEUTRAL - PAINT TO MATCH



WINDSHIELD GLASS SEALS AND HARDWARE	Stock No.	Replaces
1941-49 MB, CJ2A (SEAL BETWEEN INNER AND OUTER W/S)	12301.01	A-2250
1941-49 MB, CJ2A GLASS SEAL (2 NEEDED)	12301.02	A-2479
1951-75 M38, M38-A1, CJ3A, CJ3B, CJ5, CJ6	12301.03	978995K
1976-86 CJ	12301.04	5453949
1987-95 WRANGLER, GLASS SEAL	12301.05	55019988
1987-95 WRANGLER GLASS SEAL LOCK ONLY	12301.06	55134655
1987-95 WRANGLER WINDSHIELD GLASS SEAL CLIP	12301.07	55134656
1997-06 TJ WINDSHIELD REVEAL MOLDING	NEW 12301.08	55176567AC
1997-06 TJ SEAL, INNER WINDSHIELD	NEW 12301.09	55176430AD

COWL RUBBER SEALS	Stock No.	Replaces
1941-1963 MB, M38, 2A, 3A, 3B	12302.01	A-2476
1951-75 CJ5, CJ6	12302.02	989844
1976-86 CJ	12302.03	5453950
1987-95 YJ WRANGLER	12302.04	55009127
1997-2002 TJ WRANGLER	NEW 12302.05	55176566AE

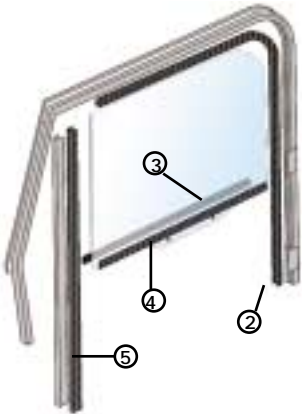

DOOR SEALS AND WEATHERSTRIPS:		
FOR CJ-7, CJ-8 AND YJ WRANGLER WITH FACTORY HARDTOP		
ITEM #		Stock No. Replaces
1	1976-95 CJ & WRANGLER DOOR WEATHER SEAL PASSENGER SIDE (RH)	12303.02 55176222
1	1976-95 CJ & WRANGLER DOOR WEATHER SEAL DRIVER SIDE (LH)	12303.01 55176223
	1997-06 TJ WITH FULL DOOR, RH, WEATHERSTRIP OUTER DOOR	NEW 12303.12 5017462AF
	1997-06 TJ WITH FULL DOOR, LH, WEATHERSTRIP OUTER DOOR	NEW 12303.13 5017463AF
1	1987-95 YJ WRANGLER 1/2 DOOR WEATHER SEAL (RH)	12303.04 55009828
1	1987-95 YJ WRANGLER 1/2 DOOR WEATHER SEAL (LH)	12303.03 55009829
	1997-06 TJ RH, HALF DOOR, OUTER SEAL	NEW 12303.14 5017010AB
	1997-06 TJ LH, HALF DOOR, OUTER SEAL	NEW 12303.15 5017011AB
2	1976-95 CJ & WRANGLER, REAR DOOR SEAL, LH=RH	12303.05 5457057
3	1976-95 CJ & WRANGLER, DOOR GLASS OUTER SEAL, RH	12303.06 55024254
3	1976-95 CJ & WRANGLER, DOOR GLASS OUTER SEAL, LH	12303.07 55024255
4	1976-95 CJ & WRANGLER, DOOR GLASS INNER SEAL, RH	12303.08 5762384
4	1976-95 CJ & WRANGLER, DOOR GLASS INNER SEAL, LH	12303.09 5762385
5	1982-95 CJ & WRANGLER, DOOR EDGE SEAL WITH MOVABLE VENT WINDOW LH=RH	12303.10 8134851
5	1978-81 CJ, DOOR GLASS EDGE SEAL For CJ W / STATIONARY VENT WINDOW	12303.11 5454164

BODY PARTS

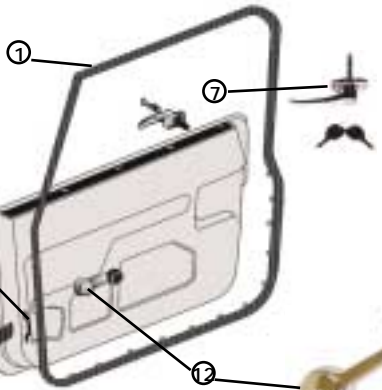

OUTER DOOR HANDLES: FOR FACTORY HALF DOORS	Stock No.	Replaces
1987-2004 WRANGLER, PASSENGER SIDE	11812.08	55176548AB
1987-2004 WRANGLER, DRIVER SIDE	11812.09	55176549AB
OUTER TAILGATE HANDLES:		
1987-95 YJ WRANGLER	11812.08	55176548AB
1997-04 TJ WRANGLER	11812.10	55176547AB



One Key Opens Either Door!



11810.05



81-95 CJ & WRANGLER DOOR HANDLES, LATCHES AND PARTS		
ITEM #	FOR HARDTOPS AND FULL STEEL DOORS	Stock No. Replaces
6	1981-95 CJ & WRANGLER FULL DOOR, LATCH BRACKET KIT, LH	11810.01 55029455K
6	1981-95 CJ & WRANGLER STAINLESS STEEL DOOR BRACKET KIT, LH	11810.03 55029455K-ST
6	1981-95 CJ & WRANGLER FULL DOOR, LATCH BRACKET KIT, RH	11810.02 55029454K
6	1981-95 CJ & WRANGLER STAINLESS STEEL DOOR BRACKET KIT, RH	11810.04 55029454K-ST
6	1981-95 CJ & WRANGLER STAINLESS STEEL DOOR BRACKET KIT, RH, LH PAIR	11810.05 30513
7	1981-95 CJ & WRANGLER FULL DOOR, LATCH PLATE, RH=LH	11811.01 5758194
8	1981-95 CJ & WRANGLER FULL DOOR, LATCH PIN, RH=LH	11811.02 55076217
9	1976-80 CJ WITH HARDTOP, DOOR HANDLE WITH KEY	11812.01 8128461
9	1976-80 CJ W / HARDTOP, DOOR HANDLE W / KEY, PAIR (PAIR USES SAME KEY)	11812.02 8128461-K2
10	1981-90 CJ & WRANGLER, HARDTOP DOOR LOCK & KEY SET, ONE SIDE ONLY	11813.01 8122874
10	1981-90 CJ & WRANGLER, HARDTOP DOOR LOCK & KEY SET, PAIR (BOTH SIDES)	11813.02 8122874K2
11	1981-95 CJ & WRANGLER, FULL STEEL DOOR PADDLE HANDLE, CHROME RH	11812.04 5758172
11	1981-95 CJ & WRANGLER, FULL STEEL DOOR PADDLE HANDLE, BLACK RH	11812.06 5758172-BLK
11	1981-95 CJ & WRANGLER, FULL STEEL DOOR PADDLE HANDLE, CHROME LH	11812.03 5758173
11	1981-95 CJ & WRANGLER, FULL STEEL DOOR PADDLE HANDLE, BLACK, LH	11812.05 5758173-BLK
12	1976-91 CJ & WRANGLER, WINDOW CRANK HANDLE	11814.01 3678907
13	1976-95 CJ & WRANGLER, DOOR STRAP (EACH)	11817.01 5459207
13	1976-95 CJ & WRANGLER, ADJUSTABLE DOOR STRAP (PAIR)	12103.01 769401
14	1976-95 CJ & WRANGLER, DOOR FOOTMAN LOOP, STAINLESS (KIT)	11105.01 7423

12304.06

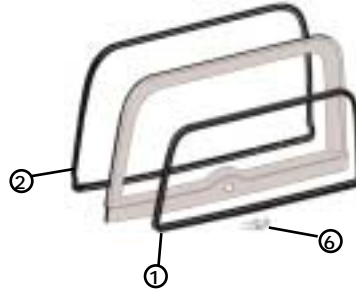
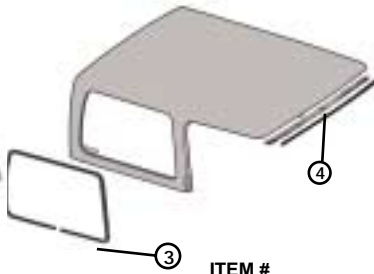

HARDTOP, TAILGATE, LIFTGATE SEALS & COMPONENTS



12305.01



11901.02

12306.07

EACH PIECE SOLD INDIVIDUALLY



11816.01

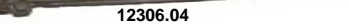

12306.04

SOFT TOP SEALS AND HARDWARE

ITEM #	DESCRIPTION	Stock No.	Replaces
1	1977-86 CJ7 LIFTGATE OUTER SEAL WITH PLASTIC LOCKS	12304.01	5454184
	1987-95 YJ WRANGLER, WEATHERSTRIP, REAR LIFT-GATE GLASS	12304.08	55010064 NEW
2	1977-86 CJ7 LIFTGATE INNER GLASS SEAL	12304.02	5758072
3	1976-06 CJ & WRANGLER HARDTOP REAR SIDE WINDOW SEAL, RH=LH	12304.03	5461835
4	1977-95 HARDTOP TO WINDSHIELD FRAME SEAL	12304.04	55052607
5	1977-86 CJ HARDTOP LIFTGATE HINGE	11901.01	8128520
6	1977-86 CJ HARDTOP T-HANDLE	11901.02	8133802
7	1976-86 CJ7 & CJ8 TAILGATE SEAL	12305.01	5457112
7	1987-95 WRANGLER TAILGATE SEAL	12305.02	55009742
	1987-95 YJ TAILGATE'S UPPER WEATHERSTRIP (BETWEEN LIFT-GATE & TAIL-GATE)	12304.09	55009398 NEW
8	1987-95 YJ WRANGLER CORNER HARTOP SEAL, RH	12304.06	55134537
8	1987-95 YJ WRANGLER CORNER HARTOP SEAL, LH	12304.05	55134537
9	HARDTOP SEAL KIT, FOR CJ, YJ & TJ	12304.07	41190



11817.01



11801.01

11812.13



12306.08

OE STYLE INNER DOOR HANDLES

DESCRIPTION	Stock No.	Replaces
1976-86 CJ BLACK, Without Hardware	11801.01	5457831
1987-95 YJ HANDLE KIT, BLACK, With Hardware (2 screws & 2 cover pieces), For Half or Full Doors	11816.01	55009801K
1987-95 YJ HANDLE KIT, SPICE, With Hardware (2 screws & 2 cover pieces), For Half or Full Doors	11816.37	5AE50LTBK
1987-95 YJ HANDLE KIT GRAY, With Hardware (2 screws & 2 cover pieces), For Half or Full Doors	11816.09	5AE50JS1K
1991-02 YJ & TJ WRANGLER, PASSENGER SIDE, For Half or Full Doors	11812.12	55176476AB
1991-02 YJ & TJ WRANGLER, DRIVER SIDE, For Half or Full Doors	11812.13	55176477AB



11813.04

LOCKS & CYLINDERS FOR DOOR & TAILGATE

DESCRIPTION	Stock No.	Replaces
1976-86 LATCH BRACKET, CJ, -GLOVE BOX LOCK NEW	13317.01	957276
1972-86 CJ, LOCK ASSY GLOVE BOX (PUSH BUTTON, NON-LOCKABLE VERSION) NEW	11813.11	5450252K
DOOR CYLINDER & LOCK: 1991-94 YJ WRANGLER, XJ CHEROKEE, ZJ GRAND CHEROKEE	11813.03	4720931
DOOR CYLINDER & LOCK: 1995-01 YJ & TJ WRANGLER, 1995-97 XJ CHEROKEE, 1995 ZJ GRAND CHEROKEE	11813.04	4778123
DOOR CYLINDER & LOCK: 2002-04 TJ WRANGLER, 1998-01 XJ CHEROKEE, 1996-98 ZJ GRAND CHEROKEE	11813.05	4864651
DOOR CYLINDER & LOCK: 1999-04 WJ GRAND CHEROKEE, 2004 KJ LIBERTY	11813.06	5013682AA
DOOR CYLINDER & LOCK: 2002-03 KJ LIBERTY	11813.07	5072294AA
DOOR CYLINDER & LOCK: 1974-91 SJ (CHEROKEE, WAGONEER, J10, J20)	11813.08	8128289K
TAILGATE CYLINDER & LOCK: 1991-94 YJ WRANGLER	11813.09	4723586
TAILGATE CYLINDER & LOCK: 1995 YJ WRANGLER, 1997 TJ WRANGLER	11813.10	4746311
TAILGATE CYLINDER & LOCK: 1995-01 TJ WRANGLER	11813.04	4778123
TAILGATE CYLINDER & LOCK: 2002-04 TJ WRANGLER	11813.05	4864651



11813.08

11813.11

GROMMETS FOR DOOR TRIM PANELS 1987-95 YJ WRANGLER, W / HALF DOORS

DESCRIPTION	Stock No.	Replaces
SPICE (REQUIRE 6)	11818.37	5FB63RTB
GRAY (REQUIRE 6)	11818.09	5FB63JS1
BLACK (REQUIRE 6)	11818.01	5FB63RXA



11818.37

SOLD INDIVIDUALLY

Dashpads: For Vehicles W / Wout Movable Vent Windows Replaces DCX No.

- "Jeep" Marked Dashpad: For 1976-86 CJ's. Black DMC-5760458
- "Jeep" Marked Dashpad: For 1976-86 CJ's. Light Gray - paintable DMC-5760459

Dashpad Covers:

- DASHPAD COVER, MODELS WITH MOVABLE VENT WINDOWS 13314.01 DTP501-01
- DASHPAD COVER, MODELS WITHOUT MOVABLE VENT WINDOWS 13314.02 DTP502-01

DMC-5760458



13314.01



13314.02

Dashpads and covers work with movable or non-movable vent windows

Dash n' Store Storage Dash



Stock No.

- 1976-86 CJ DASH AND STORE 13315.01 M1033
- PLASTIC STORAGE DASH

CJ Steel Dash Panel



Stock No.

- 1976-86 CJ STEEL DASH PANEL 13320.01 5763630
- CUT-OUT FOR GLOVE BOX ONLY

CJ Indicator Lamps



1976-86 CJ INDICATOR LAMPS	Stock No.	Replaces
FULL KIT (6 PCS)	13319.01	5752813K
"LIGHTS"	13319.02	5752813
"WIPER WASHER"	13319.03	5752814
"AIR"	13319.04	5752815
"TEMP"	13319.05	5752816
"DEFROST"	13319.06	5752817
"FAN"	13319.07	5752818

Plastic Glove Box Inserts and Doors



13316.01

13316.03

13316.02

13316.04

1125.01

PLASTIC REPLACEMENT GLOVE BOX INSERTS

	Stock No.	Replaces
1972-86 CJ	13316.01	M1093
1955-71 CJ	13316.02	M1092
1955-71 CJ, EXTRA LARGE	13316.03	M1091
1972-73 COMMANDO	13316.04	M1097
JEEPSTER, Early Model Wagon, Pick-up	13316.05	M1094

GLOVE BOX DOORS

1972-86 CJ STAINLESS	1125.01	5764164
1972-86 CJ BLACK	11228.01	5764164-BLK

BODY PARTS

Interior Replacement Parts



13318.05

13318.06

11814.01

11813.11

13318.01

13318.08

13318.02

13318.07

Glove Box Door Push Button

REPLACEMENT INTERIOR ITEMS	Stock No.	Replaces
1976-86 CJ INTERIOR WINDSHIELD BRACKET KNOB (EACH)	13318.01	5457045
1976-86 CJ WIPER PIVOT COVER PLASTIC (EACH)	13318.02	5459153
1976-86 CJ RADIO DELETE PANEL	13318.03	5462707
1976-86 CJ DELETE PANEL HDW 2 NUTS, 2 WASHERS	13318.04	5462707-HW
1976-86 CJ INTERIOR DOOR HANDLE	11801.01	5457831
1976-91 CJ & YJ WRANGLER HARD TOP DOOR WINDOW CRANK HANDLE	11814.01	3678907
1968-86 CJ KNOB FOR HEATER & WIPER SWITCH (EACH)	13318.05	5459189
1973-86 CJ HEADLIGHT SWITCH KNOB W/ROD	13318.06	5752810
1976-86 CJ TURN SIGNAL LEVER	13318.07	5362173
1976-86 CJ STEERING COLUMN COVER PLASTIC (OE STYLE)	13318.08	5354777
1976-86 CJ GLOVE BOX DOOR	11228.01	5764164-BLK

Replacement Seat Belts



13202.02

13202.04

13202.01

13202.03

SEAT BELTS FOR CJ AND WRANGLER

	Stock No.	Replaces
1982-95 CJ & WRANGLER FRONT 3 POINT SHOULDER HARNESS	13202.01	BELT3
1976-81 CJ FRONT RETRACTABLE LAP BELT	13202.02	BELT2
6" BRACKET FOR BELT3 & BELT2-ADDS HEIGHT TO FEMALE END TO CLEAR CONSOLES & LARGE SEATS	13202.03	BELT-BLK
1976-95 CJ & WRANGLER REAR BELT, 60"	13202.04	BELT1
SEAT BELT HARNESS FLOOR MOUNT, ROUND WASHER W/WELDED NUT	13202.05	40
SEAT BELT HARNESS FLOOR MOUNT, OVAL WASHER W/WELDED NUT	13202.06	41



13202.05

13202.06



Rear View Mirrors



INTERIOR REAR-VIEW MIRRORS AND MOUNTING KIT	Stock No.	Replaces
1941-75 WILLYS & CJ REAR VIEW MIRROR	11020.01	977680
1972-06 CJ & WRANGLER REAR VIEW MIRROR KIT INCLUDES MIRROR, BUTTON & GLUE	11020.02	8993023K
MIRROR MOUNTING GLUE	11021.01	8120995G



ARM RESTS	Stock No
PADDED ARM REST PAIR (FOR TRAIL DOORS HALF DOORS ONLY)	NEW 11820.01
ARM REST W/ PAD (SOLD INDIVIDUALLY FITS LEFT OR RIGHT SIDE)	NEW 11820.20

MISCELLANEOUS ITEMS	Stock No	Replaces
1976-86 CJ, RADIO DELETE	NEW 13318.03	5462707
1976-86 CJ, HARDWARE KIT FOR RADIO COVER	NEW 13318.04	5462707-HW
1972-95 CJ & YJ, BOLT (TORX HEAD), INSTRUMENTAL PANEL	NEW 17258.01	4004991

RUBBER FLOOR MATS	Stock No	Replaces
1945-75 FRONT CJ2A, CJ3A, CJ3B, CJ5, CJ6, M38 & M38A1	13601.01	554995
1976-95 FRONT CJ & YJ WRANGLER	13601.02	554992
1945-81 REAR CARGO AREA CJ2A, CJ3A, CJ3B, CJ5, CJ7, M38 & M38A1	13601.03	550995

Miscellaneous Interior Accessories



MISCELLANEOUS INTERIOR ACCESSORIES	Stock No	Replaces
1976-86 CJ INTERIOR WINDSHIELD BRACKET KNOB PAIR, CHROME	11304.01	7527
1976-95 CJ & YJ WRANGLER INTERIOR WINDSHIELD HINGE BRACKET PAIR, STAINLESS STEEL	11127.01	7408
1968-75 CJ WIPER MOTOR COVER STAINLESS STEEL	11122.01	5756806E
1976-86 CJ WIPER MOTOR COVER STAINLESS STEEL	11122.02	5756806
1976-86 CJ WIPER MOTOR COVER, BLACK	19135.01	5756806-BL
1976-95 CJ & YJ WRANGLER GRAB BAR HANDLE, STAINLESS STEEL	11123.01	7409
1977-86 CJ GAUGE COVER PANEL, STAINLESS STEEL	11124.01	7412
1976-86 CJ STEERING COLUMN COVER CHROME PLASTIC	18090.01	5354777-CH
1976-86 CJ STEERING COLUMN COVER STAINLESS STEEL	11128.01	7446
1976-86 CJ GLOVE BOX DOOR, STAINLESS STEEL	11125.01	5764164
1976-86 CJ, LATCH BRACKET, GLOVE LOCK BOX	NEW 13317.01	957276
1972-86 CJ, LOCK ASSY GLOVE BOX (PUSH BUTTON, NON-LOCKABLE VERSION)	NEW 11813.11	5450252K

Replacement Sun Visors

Replace those old, worn out or missing sun visors with these OE style replicas. Available in factory matching black, grey or spice. Sold in Pairs. Mounting screws not included.



1972-86 CJ	Stock No	Replaces
BLACK VINYL	13301.01	78125-01
GRAY VINYL	13301.09	78125-09
SPIICE VINYL	13301.37	78125-37
1987-95 YJ WRANGLER	Stock No	Replaces
BLACK VINYL	13312.01	78126-01
GRAY VINYL	13312.09	78126-09
SPIICE VINYL	13312.37	78126-37

SEAT BACK ADAPTER
UNIVERSAL, MUST BE USED WITH FACTORY STYLE SEAT TRACK SLIDERS

Stock No. 13203.01



CJ Billet Dash Knobs



1976-86 CJ BILLET ALUMINUM DASH KNOBS	Stock No	Replaces
6 PIECES-CLEAR COAT	11420.01	AL8880
6 PIECES-BLACK	11420.02	AL8880BL
6 PIECES-STAINLESS STEEL	11126.01	30511
6 PCS. STAINLESS STEEL BLK.	11126.02	

Adjustable Door Strap

Keeps any door in check. Made of tough nylon webbing they feature multiple adjustments so you can keep the door in any position you wish.



ADJUSTABLE DOOR STRAP 12103.01 769401

Sport Bar Grab Handles

These extremely useful handles allow passengers to hold on during off-road adventures. Made of durable nylon webbing they feature easy hook and loop attachment to virtually any sport bar. Deluxe version features thick foam handle for extra comfort. Sold in Pairs.



DESCRIPTION	Stock No	Replaces
SPORT GRAB HANDLE PAIR	13305.01	769201
DELUXE GRAB HANDLE PAIR	13305.02	769301
ULTIMATE GRAB HANDLE PAIR (RED)	NEW 13505.03	
ULTIMATE GRAB HANDLE PAIR (BLACK)	NEW 13505.04	



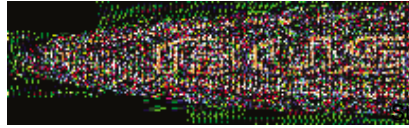

BUSHWACKER FENDER FLARE KITS

Application	Stock No.
1997-06 TJ WRANGLER, Pocket Style Kit, 6" Wide, No Drilling Required	BSW-1090807
1997-06 TJ WRANGLER, Pocket Style Kit, 4.75" Wide, No Drilling Required	BSW-1091707
1997-06 TJ WRANGLER (Except Sahara), Rubicon Style Kit, 6" Wide, No Drilling Required. Includes Stone Guard, Bumper Corners and hardware	BSW-1091307
1987-95 YJ WRANGLER, Cut Out Style Kit, 6" Wide, Drilling and Cutting Required	BSW-1090907
1976-86 CJ, Cut Out Style Kit, 6" Wide, Drilling and Cutting Required	BSW-1091007
1984-96 XJ 4 Door, Cut Out Style Kit, 6" Wide, Drilling and Cutting Required	BSW-1091107
1986-94 XJ 2 Door, Cut Out Style Kit, 6" Wide, Drilling and Cutting Required	BSW-1091207

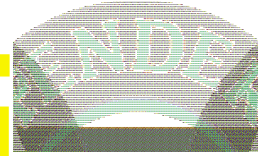

For The most aggressive tire and wheel packages, Choose Cut-Out Style™! These Flares give the TJ® wide coverage and tough, bold looks. They extend from 2" to 5" beyond the wheel-well opening!

BLACK MATTE FINISH!



Pocket Style



For Classic Wrangler® Look, Choose Pocket Style™! These Flares give that squared-off rugged look of the classic Wrangler® body. Offers 6" of extended tire coverage, they install in minutes!



Cut-Out Style

Xenon Fender Flare Kits



XN8260



XN8200

Unbreakable, flexible polyurethane material. Comes in paintable black matte finish. Hardware included, no drilling required.

XENON FLARE KITS	# OF	WIDTH	STOCK NO.
FOR CJ & WRANGLER	PCS		
1955-86 CJ-5, CJ-6, CJ-7	4	5.0	XN8260
1987-95 YJ WRANGLER	4	6.5	XN8200
1987-95 YJ WRANGLER	6	6.5	XN8710
TJ STYLE UPGRADE			
1997-06 TJ WRANGLER	4	6.0	XN8300
1997-06 TJ WRANGLER*	8	6.0	XN8360
1981-86 CJ-8 SCRAMBLER	4	FR5 RR6.5	XN8310

XENON FENDER FLARE KITS

Application	Stock No.
1997-06 TJ WRANGLER, Flare Kit, 4 pcs	XN8730
1997-06 TJ WRANGLER, Flare Kit w / Side Skirts, 6 pcs	XN8740
1997-06 TJ WRANGLER, Flare Kit w/ 2 Side Skirts, and 2 Bumper Covers	XN8750
1997-06 TJ WRANGLER, Side Skirt, Passenger (RH)	XN8742
1997-06 TJ WRANGLER, Side Skirt, Driver (LH)	XN8743
1997-06 TJ WRANGLER, Bumper Cover, Front	XN8741
1997-06 TJ WRANGLER, Bumper Cover, Rear	XN8744

Want extra coverage? Bestop now offers their flare kit with rocker extensions. These flares provide and extra 45 inches of coverage to protect the rocker panels from sand and gravel kick-up. Made of the same heavy-duty polyurethane as the standard flare kits. Some drilling is required.

Application	Stock No.
1987-96 YJ WRANGLER	49647-01
1997-06 TJ WRANGLER	49649-01



Finally, A Fender Flare Kit for The XJ Cherokee Series!

1984-96 XJ FENDER FLARES AND KITS:	Stock No.	Replaces
4 pcs Kit	11605.01	5AG-K4
Front Passenger Side	11605.02	5AG24JX9
Front Driver Side	11605.03	5AG25JX9
Rear Passenger Side	11605.04	5AG30JX9
Rear Driver Side	11605.05	5AG31JX9



Each Bestop fender flare kit comes with 4 flares and 2 stone guards (86-02 Wrangler). A Perimeter Frame™ adds structural integrity without compromising flex. The Mud Bulge™, also a Bestop trademark, helps to keep flying mud and water from landing in the vehicle. Made of flexible, impact resistant polyurethane Bestop flares provide up to 6" of fat tire coverage. Most applications do not require drilling.

Application	Stock No.
1955-86 CJ-5, CJ-6, CJ-7, 4 pcs	49245-01
1987-95 WRANGLER, 4 pcs, with Stone Guards	49247-01
1997-06 WRANGLER, 4 pcs, with Stone Guards	49249-01



XJ FENDER FLARES
11605.01



1997-06 TJ Wrangler OE Style Replacement Fender Flares

11603.02



1997-06 TJ WRANGLER REPLACEMENT FLARES AND PARTS	Stock No.	Replaces
FLARE KIT (6 PCS) INCLUDES * 4 FLARES, 2 EXTENSIONS & HARDWARE	11603.01	4207
FLARE KIT (4 PCS) FLARES ONLY* HARDWARE NOT INCLUDED	11603.02	55254918K
FLARE-FRONT PASSENGER SIDE*	11603.04	55254918
FLARE-FRONT DRIVER SIDE*	11603.03	55254919
FLARE-REAR PASSENGER SIDE	11603.06	55175726
FLARE-REAR DRIVER SIDE	11603.05	55175727
FLARE EXTENSION-PASSENGER SIDE	11603.08	55254928
FLARE EXTENSION-DRIVER SIDE	11603.07	55254929
HARDWARE KIT FOR TJ	11603.09	OMIX-T-FHW

*Will not fit Sahara Models

1987-95 YJ Wrangler OE Style Replacement Fender Flares



1987-95 YJ WRANGLER FLARES AND PARTS	Stock No.	Replaces
FLARE KIT: INCLUDES 4 FLARES, 2 EXTENSIONS, BRACKETS AND HARDWARE KIT	11602.01	4206
FLARE KIT (4 PCS) INCLUDES: 4 FLARES & HARDWARE KIT	11602.02	5AHK
FLARE-FRONT DRIVER SIDE	11602.03	5AH15JX9
FLARE-FRONT PASSENGER SIDE	11602.04	5AH14JX9
FLARE-REAR DRIVER SIDE	11602.05	5AH17JX9
FLARE-REAR PASSENGER SIDE	11602.06	5AH16JX9
FRONT EXTENSION-DRIVER SIDE	11602.07	55007317
FRONT EXTENSION-PASSENGER SIDE	11602.08	55007316
HARDWARE KIT (PLASTIC LOCKS & SCREWS) EXTENSION BRACKET NOT INCLUDED	11601.06	7109K
FRONT EXTENSION BRACKET	11602.09	6030441



1955-86 CJ OE Style Replacement Fender Flares

1955-86 CJ-5, CJ-7, FENDER FLARES AND KITS:	Stock No.	Replaces
CJ-5 & CJ-7-4 PCS COMPLETE KIT WITH HARDWARE	11601.01	8997109
CJ-5, CJ-7 - FRONT DRIVER SIDE FLARE	11601.03	5455071
CJ-5, CJ-7 - FRONT PASSENGER SIDE FLARE	11601.02	5455072
CJ-5 & CJ-7 - REAR DRIVER SIDE FLARE	11601.05	5455073
CJ-5 & CJ-7 - REAR PASSENGER SIDE FLARE	11601.04	5455074
HARDWARE KIT (PLASTIC LOCKS & SCREWS)	11601.06	7109K

CJ-8 Scrambler OE Style Replacement Fender Flares

CJ-8 FENDER FLARES AND KITS:	Stock No.	Replaces
1981-86 CJ-8 SCRAMBLER, Kit, 4 pcs, Includes Hardware	11604.01	5455072K
1981-86 CJ-8 SCRAMBLER, Passenger Side, Rear	11604.02	5757020
1981-86 CJ-8 SCRAMBLER, Driver Side, Rear	11604.03	5757021
1955-86 CJ-8, Driver side Flare, Front	11601.03	5455071
1955-86 CJ-8 - Passenger side Flare, Front	11601.02	5455072

Improve your vehicles aggressive, rugged looks with Rugged Ridge 7" Fender Flares. Not just for looks - These durable thermoplastic flares also provide added protection from road debris and stone chips

OMIX 7" FENDER FLARES AND KITS:	Stock No.	REPLACES
7" Flare, CJ Kit: 4 pcs w/ Hardware	NEW 11606.01	
7" Front Passenger Side (RH) Flare, 55-86 CJ	NEW 11606.02	FC7-FR
7" Front Driver Side (LH) Flare, 55-86 CJ	NEW 11606.03	FC7-FL
7" Flare, YJ Wrangler Kit: 6 pcs w/ Hardware	NEW 11607.01	
7" FENDER FLARE, FRONT RH YJ WRANGLER W/O HARDWARE	NEW 11607.02	FY7-FR
7" FENDER FLARE FRONT LH YJ WRANGLER W/O HARDWARE	NEW 11607.03	FY7-FL
7" Flare, TJ Wrangler Kit: 6 pcs : (2) Front, RH & LH and (2) Rear, RH & LH, (2) Extension, RH & LH*	NEW 11608.01	
1997-06 TJ WRANGLER, 7" FLARE FRONT RH*	NEW 11608.02	FT7-FR
1997-06 TJ WRANGLER, 7" FLARE FRONT LH*	NEW 11608.03	FT7-FL
1997-06 TJ WRANGLER, 7" FLARE REAR RH*	NEW 11608.04	FT7-RR
1997-06 TJ WRANGLER, 7" FLARE REAR LH*	NEW 11608.05	FT7-RL

*Will not fit Sahara Models

7" Flare, Rear TJ

7" Flare, CJ-7



RuggedRidge's 7" CJ & YJ Fender Flares use a TJ Style Rear Flare enabling it to cover a larger wheel space. This feature also makes it necessary to cut the wheel housings to accept a larger size tire. Cutting & Drilling required



7" Flare, YJ Wrangler



7" Flare, Front TJ

HI-LIFT JACKS & ACCESSORIES

	Stock No.
48" HEIGHT, MULTI FUNCTIONAL, EASY TO USE JACK	HL484
FRONT BUMPER MOUNTING KIT	4X400
BUMPER LIFT ATTACHMENT KIT	BL250
JACK COVER; PROTECTIVE COVER FOR STORAGE	JP350
LOCK-RAC; KIT TO LOCK THE JACK	LR200
HI-LIFT CASTING JACK, 48"	HL485
HI-LIFT CASTING JACK, 60"	HL605
HI-LIFT OFF-ROAD KIT	ORK
HI-LIFT OFF-ROAD BASE	ORB



Jack and Accessories

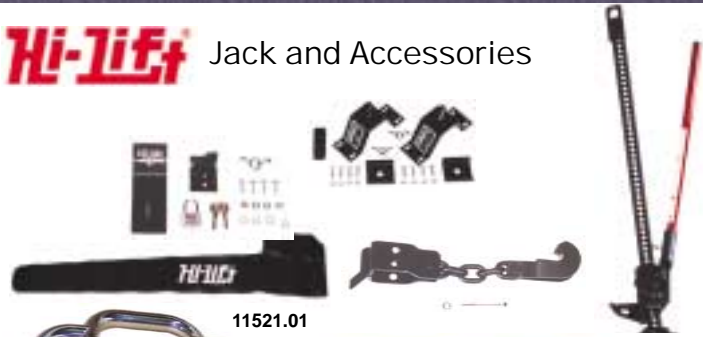

Stainless Steel 3" Tubular Bumpers and Nerf Bars

	Stock No.	Replace
1955-06 CJ & WRANGLER, FRONT WITH HOOP	11520.01	MS-8420
1955-06 CJ & WRANGLER FRONT DEFENDER	11521.01	MS-9420
1955-06 CJ & WRANGLER REAR	11522.01	MS-9425
1976-83 CJ5 SIDE BARS, PAIR	11522.02	MS-9430
1976-86 CJ7 & CJ8 SIDE BARS, PAIR	11522.03	MS-9431
1987-06 WRANGLER SIDE BARS, PAIR	11522.04	MS-9432
1987-06 WRANGLER EUROGUARD	11523.01	7659-ST



Need A Spare End Cap?

Plastic End Cap fits ALL 3" Tubular Bumpers Front or Rear
Replace those damaged or missing caps today!
Stk. # 11525.01



Titanium Look 3" Tubular Bumpers and Nerf Bars

	Stock No.	Replaces
1955-06 CJ & WRANGLER, FRONT WITH HOOP	11530.01	MS-52450
1955-06 CJ & WRANGLER, REAR WITH RECEIVER	11531.01	MS-52460
1976-86 CJ7, CJ8 SIDE NERFBAR, PAIR, WITH STEP	11532.01	MS-52472
1987-06 WRANGLER SIDE NERFBAR, PAIR, WITH STEP	11532.02	MS-52473



Black Textured or Glossy 3" Tubular Guards

	Stock No.	Replaces
1997-06 TJ WRANGLER, FRONT GUARD, TEXTURED, BLACK	11511.01	6101215
1997-06 TJ WRANGLER, BRUSH GUARD, TEXTURED, BLACK	11512.01	6701215
1997-06 TJ WRANGLER, FRONT GUARD, GLOSSY, BLACK	11511.02	610121
1997-06 TJ WRANGLER, BRUSH GUARD, GLOSSY, BLACK	11512.02	670121
1987-95 YJ WRANGLER, FRONT GUARD, GLOSSY, BLACK	11511.04	610111
1987-95 YJ WRANGLER, BRUSH GUARD, GLOSSY, BLACK	11512.04	670111
1987-95 YJ WRANGLER, FRONT GUARD, TEXTURED, BLACK	11511.03	6101115
1987-95 YJ WRANGLER, BRUSH GUARD, TEXTURED, BLACK	11512.03	670115

Black Powder Coated 3" Tubular Bumpers and Nerf Bars

These black powder coated bumpers and bars are constructed of thick 3" tubular steel and includes end caps. These bumpers and nerf bars as tough as they look. Include all necessary hardware. Rear bumper hitch has a maximum tongue weight of 250lbs. Kits come with front bumper, rear bumper, side nerf bars and hardware.

BUMPER KITS

	Stock No.	Replaces
1955-75 CJ-5, CJ-6	11501.01	52403K5E
1976-83 CJ-5	11501.02	52403K5L
1976-86 CJ-7 & CJ-8	11501.03	52403K7&8
1987-06 YJ & TJ WRANGLERS	11501.04	52403KY&T

FRONT TUBULAR BUMPER

1955-06 CJ & WRANGLER	11502.01	52403
1987-06 WRANGLER EUROGUARD	11510.01	7659

REAR TUBULAR BUMPER

1955-04 CJ & WRANGLER	11503.01	52407
-----------------------	----------	-------

NERF BAR SETS (PAIR)

1955-75 CJ5	11504.01	563962
1976-83 CJ5	11504.02	564162
1976-86 CJ7 & CJ8	11504.03	564062
1987-06 YJ & TJ WRANGLER	11504.04	564462

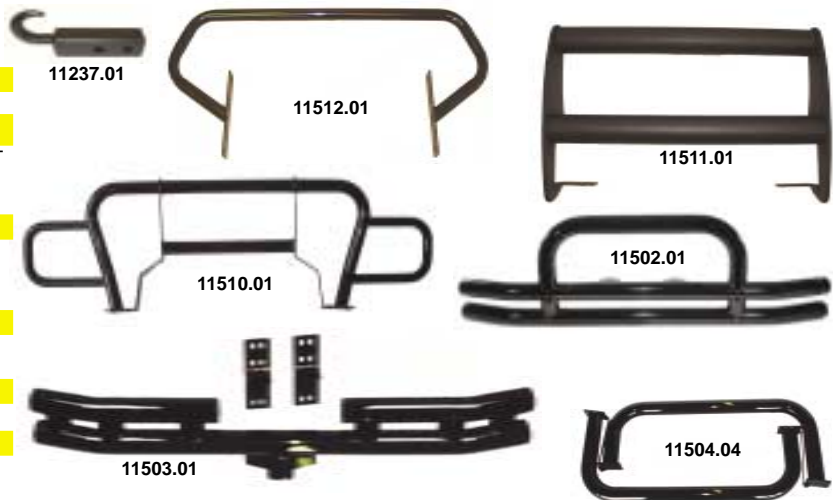

TOW HOOK, REMOVABLE, FOR ALL 2" HITCH RECEIVERS (Does Not Incl Pin) 11237.01

BODY PARTS

HEAVY DUTY TOW HOOK KIT PAIR

Don't get your Cherokee or Grand Cherokee stuck on the trails without an Rugged Ridge Heavy Duty XJ or ZJ Tow Hook Kit on the front. The ¼ inch steel plate is form bent for maximum strength and then powder coated black to protect it from the elements.



1984-01 XJ FRONT HEAVY DUTY TOW HOOK PAIR KIT	NEW	11236.05
1983-98 ZJ FRONT HEAVY DUT TOW HOOK PAIR KIT	NEW	11236.06

HEAVY DUTY TRANSFER CASE CROSS MEMBER

Protect your transfer case and add durability at the same time. The Rugged Ridge Heavy Duty Transfer Case Crossmember is made of 3/16 inch steel, welded, reinforced and powder coated black to protect it and the soft underbelly of your XJ from the elements.



1984-01 XJ HEAVY DUTY TRANSFER CASE CROSSMEMBER	NEW	12035.60
---	-----	----------

HEAVY DUTY OFF ROAD BUMPER

Replace that stock TJ bumper with a rugged and durable Heavy Duty Off Road Bumper from Rugged Ridge. Our low profile bumpers are ideal for tight approach angles and will fight off the rocks with sturdy 3/16 inch laser cut steel. Bumpers have integrated and welded eyelets for attaching D-Ring shackles, top holes for mounting tow hooks, and they are predrilled for mounting off road lights. Bumpers are powder coated black for superior appearance and durability.



1997-06 TJ FRONT HEAVY DUTY OFF ROAD BUMPER	NEW	11545.01
1997-06 TJ REAR HEAVY DUTY OFF ROAD BUMPER	NEW	11546.01

NEW SERIES BUMPERS FROM RUGGED RIDGE

	BLACK	TITANIUM
1987-06 WRANGLER , BUMPER FRONT	NEW 11502.11	11502.12
1987-06 YJ & TJ WRANGLER, REAR ROCK CRAWLER BUMPER W/O CARRIER	NEW 11503.11	11503.12
1987-06 YJ & TJ WRANGLER, REAR ROCK CRAWLER BUMPER W CARRIER	NEW 11503.13	11503.14
1987-06 YJ & TJ ROCKER GUARD PAIR	NEW 11504.11	11504.12
1987-06 YJ & TJ WRANGLER SIDE ARMOR PAIR	NEW 11504.13	11504.14



	Stock No.	
1997-06 WRANGLER FRONT HD Rugged Ridge Bumper	11540.01	NEW
1997-06 WRANGLER HEAVY DUTY TUBE FLAT FENDER, DRIVER SIDE (LH)	12004.51	NEW
1997-06 WRANGLER HEAVY DUTY TUBE FLAT FENDER, PASSENGER SIDE (RH)	12004.52	NEW
1997-06 WRANGLER HEAVY DUTY TUBE FLAT FENDER, PAIR LH & RH	12004.53	NEW



BODY PARTS

TJ BODY ARMOR KIT

Rugged Ridge[®] FEATURED PRODUCT

BODY ARMOR

11650.50

- ADD RUGGED, DURABLE AND DISTINCTIVE LOOKS TO YOUR 1997-2006 TJ WRANGLER WITH THIS NEW, EASY TO INSTALL BODY ARMOR KIT
- THE BLACK, TEXTURED THERMOFORMED ABS PLASTIC IS 100% UV PROTECTED AND THE FULL 9 PIECE KIT COMES WITH PRE-INSTALLED 3M ADHESIVE
- AN EASY, INEXPENSIVE WAY TO ADD PROTECTION AND A UNIQUE APPEARANCE TO YOUR TJ.
(DOES NOT FIT RUBICON EDITION WITHOUT MODIFICATIONS)



TJ BODY ARMOR KIT



ENHANCE THE LOOK AND DURABILITY OF YOUR TJ WRANGLER WITH THIS RUGGED BODY ARMOR KIT. THE RICH BLACK, TEXTURED FINISHED PLASTIC PANELS HAVE AN EASY ADHESIVE APPLICATION TO UPGRADE YOUR TJ IN MINUTES. LOOKS GREAT AND PROTECTS AGAINST LIGHT SCRATCHES. AND WITH 100% UV PROTECTION, THEY WILL REMAIN LOOKING GREAT FOR YEARS TO COME.

- 
- A) 11650.01 - REAR TALL CORNER PAIR KIT (CANNOT BE USED WITH BUSHWACKER REAR FLARES)
 - B) 11650.05 - ROCKER SIDE PANEL PAIR KIT (FITS BOTH FACTORY OR BUSHWACKER FLARES)
 - C) 11650.10 - FRONT FRAME COVER (FITS BOTH FACTORY OR BUSHWACKER FLARES)
 - D) 11650.15 - REAR TAILGATE SILL (FITS BOTH FACTORY OR BUSHWACKER FLARES)
 - E) 11650.17 - HOOD STONE GUARD (FITS BOTH FACTORY OR BUSHWACKER FLARES)
 - F) 11650.20 - FRONT FENDER CORNER PAIR KIT (FITS BOTH FACTORY AND BUSHWACKER FLARES)
- KIT1)**
11650.50 - FULL KIT MADE OF ABOVE 6 ITEMS (ITEMS CANNOT BE USED WITH BUSHWACKER REAR FLARES)
- KIT2)**
11650.51 - KIT MADE OF A,B,C & D (CANNOT BE USED WITH BUSHWACKER FLARES)
- KIT3)**
11650.52 - KIT MADE OF E & F (FITS BOTH FACTORY OR BUSHWACKER FLARES)
- KIT4)**
11650.53 - KIT MADE OF C & D (FITS BOTH FACTORY AND BUSHWACKER FLARES)

Nothing represents a Jeep® more than its very name! It's just not the same unless, well, it says "Jeep®"! The visual appearance of the name stands for a legacy and history that no other vehicle in the world can match. Now you can return your Jeep® to its original markings with these stamped—Hoods, Tailgates, Back Panels, Toolboxes, Body Tubs, Valve Covers, Grilles and Grille Covers and Dash Pads!



DMC-663188

Willys® and Jeep® Marked Body® Parts, Grilles and Grille Overlays



DMC-670969

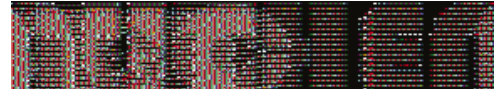

This Emblem Is Mopar's "Seal Of Approval" That The Product Meets Their Standards And Is Truly A Licensed Product

PARTS IDENTIFIED WITH THE MOPAR AUTHENTIC RESTORATION PRODUCT EMBLEM ARE THE ONLY PARTS IN THIS CATALOG OFFICIALLY AUTHORIZED AND LICENSED BY DAIMLERCHRYSLER.



Windshield Frames:

"Willys®" Marked Frame: For CJ2A DMC-663628

Hood Products:



"Willys®" Marked Hood: For 1946-53 CJ2A, CJ3A
"Willys®" Marked Hood: For 1953-64 CJ3B

DMC-670969
DMC-681334

Windshield Frame Products:



"Willys®" Marked Windshield Frame: For 1946-53 CJ2A

DMC-663628

Tailgate Products:



"Willys®" Marked Tailgate: For 1946-71 CJ2A, CJ3A/3B, CJ5, CJ6
"Willys®" Marked MB Back Panel
"Jeep®" Marked Tailgate: For 1969-83 CJ5
"Jeep®" Marked Tailgate: For 1976-86 CJ7

DMC-663188
DMC-2758
DMC-685459
DMC-5454025



"Jeep®" Marked Tailgate

Body Tub Products:



"Jeep®" Marked Body Tub: For 1955-69 CJ5
"Jeep®" Marked Body Tub: For 1970-71 CJ5
"Jeep®" Marked Body Tub: For 1972-75 CJ5
"Jeep®" Marked Body Tub: For 1976-83 CJ5*
"Jeep®" Marked Body Tub: For 1976-86 CJ7*

DMC-680637
DMC-680637-VC
DMC-680637-VD
DMC-5461335
DMC-5464362



* The "Jeep®" script used for the 1976-86 CJ body tubs is based on the design originally manufactured for 1976-80 production years.

Toolbox Products:



"Jeep®" Marked Toolbox: For 1946-75 CJ's

DMC-3227K



DMC-6914

Valve Cover Products:



"Jeep®" Marked Valve Cover: For 1981-87 6 CYL Engine
"Jeep®" Marked Valve Cover, Pair: For 1966-91 V8 AMC Engine

DMC-6914
DMC-6920



DMC-5760458

Dashpad Products:



"Jeep®" Marked Dashpad: For 1976-86 CJ's. Black
"Jeep®" Marked Dashpad: For 1976-86 CJ's. Light Gray - paintable

DMC-5760458
DMC-5760459

DMC-55026587-ST

Grille Products:



For CJ2A - Early - 1945-46
For CJ2A - Late - 1947-49
For CJ3A - 1949-53
For CJ3B - 1959-64 With "Willys®" Mark
For CJ5, CJ6 - 1955-71
For CJ5, CJ7, CJ8 - 1972-86
For YJ Wrangler - 1987-95



DMC-5752656

DMC-663536
DMC-668124
DMC-673149
DMC-815398
DMC-815385
DMC-5752656
DMC-55345192



DMC-5752247-ST



GRILLE COVERS ARE REPRODUCTION ITEMS

Grille Cover Products:

Stainless Steel Grille Overlay: For 1972-86 CJ5, CJ7, CJ8
Stainless Steel Grille Overlay: For 1987-95 YJ

DMC-5752247-ST
DMC-55026587-ST



Notice: body kits, body tubs and body parts are sold "as is". Drilling, cutting and other modifications may be required for proper installation. Claims for freight damage must be placed with freight carriers.



Kits include: Body Tub, Hood, 2 fenders and windshield frame. **Top Bow and other body parts sold separately.**

STEEL BODY KITS	Stock No.	Replaces
MINI-MB BODY KIT (ALSO INCLUDES TOP BOW ASSEMBLY & SEAT FRAME)	12001.01	MINI-MB
MB STANDARD STEEL BODY KIT (1941 AND EARLY 1942)	12001.02	A-12237
MB EARLY STEEL BODY KIT W/ SLAT GRILL (LATE 1942/EARLY 1945)	12001.03	A-12237-WLS
GPW STEEL BODY KIT	12001.04	A-1237-GPW

STEEL FENDERS AND HOODS	Stock No.	Replaces
MB, GPW HOOD	12003.01	A-3225
MB, GPW HOOD HINGE	12021.01	673442-H
MB, GPW FRONT FENDER DRIVER SIDE	12004.01	A-2943
MB, GPW FRONT FENDER PASSENGER SIDE	12004.02	A-2942
MB, FENDER BRACE, DRIVER SIDE (LH)	12021.03	A-2843
MB, FENDER BRACE, PASS. SIDE (RH)	12021.02	A-2844

STEEL BODY TUBS	Stock No.	Replaces
MB STANDARD STEEL TUB ONLY	12002.01	A-12233B0
MB EARLY STEEL TUB ONLY	12002.02	A-12237B0-WLS
GPW STEEL TUB ONLY	12002.03	A-12233B0-GPW

BACK PANELS	Stock No.	Replaces
"WILLYS" MARKED MB BACK PANEL	DMC-2758	
MB, GPW BACK PANEL	12005.01	A-2758

BODY PARTS

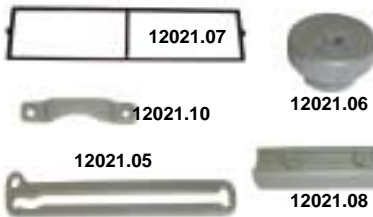

Windshield Frames and Parts

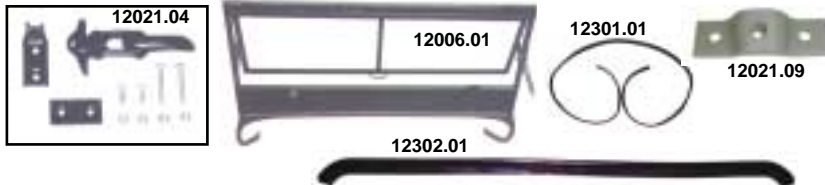

WINDSHIELD FRAME AND PARTS	Stock No.	Replaces
MB, GPW STEEL WINDSHIELD FRAME (INNER & OUTER)	12006.01	A-3210
MB, GPW WINDSHIELD CLAMP & HOOK (EACH SIDE)	12021.04	A-2227
MB, GPW COWL RUBBER	12302.01	A-2476
MB, GPW INNER & OUTER WINDSHIELD SEAL	12301.01	A-2250
MB, GPW GLASS SEAL (2 NEEDED)	12301.02	A-2479
MB, GPW WINDSHIELD ADJ ARM	12021.05	A-2235

WINDSHIELD FRAME AND PARTS	Stock No.	Replaces
MB, GPW WINDSHIELD ADJ KNOB	12021.06	A-2238
MB, GPW WINDSHIELD INNER FRAME	12021.07	A-2255
MB, GPW WINDSHIELD HOOD REST W/O CANVAS	12021.08	A-4680
MB, GPW WINDSHIELD BRACKET TO COWL	12021.09	A-2213
MB, GPW WINDSHIELD HOLD DOWN BRACKET	12021.10	A-2234

Replacement Steel Body Panels



STEEL REPLACEMENT PANELS	Stock No.	Replaces
MB, GPW FLOOR PANEL ASSEMBLY, FRONT	12007.01	671019-MB
MB, GPW FLOOR PANEL ASSEMBLY, REAR	12008.01	670381-MB
MB, GPW SIDE PANEL, DRIVER SIDE (W/AXE SHEATH)	12009.01	A-2756
MB, GPW SIDE PANEL, PASSENGER SIDE	12009.02	A-2757
MB, GPW SIDE COWL PANEL WITH STEP, DRIVER SIDE	12010.01	A-3008
MB, GPW SIDE COWL PANEL WITH STEP, PASSENGER SIDE	12010.02	A-3309
MB, GPW FRONT STEP ONLY, DRIVER SIDE	12021.15	A-3008-STEP
MB, GPW FRONT STEP ONLY, PASSENGER SIDE	12021.16	A-3309-STEP

Tire Carriers

TIRE CARRIERS AND PARTS	Stock No.	Replaces
LATE MB, GPW SPARE TIRE CARRIER, 3 BOLT	12021.11	A-2359B
EARLY MB, GPW SPARE TIRE CARRIER, 2 BOLT	12021.12	A-2359
EARLY MB SUPPORT BRACKET FOR 2 BOLT SPARE CARRIER	12021.13	A-11701
EARLY MB PLATE FOR 2 BOLT SPARE TIRE CARRIER	12021.14	A-2359-1



BODY MOUNTING KIT	Stock No.	Replaces
MB, GPW	12201.01	10599050



Seat Frames and Parts

SEAT FRAMES AND PARTS	Stock No	Replaces
MB, GPW DRIVER SEAT FRAME	12011.01	A-2286
MB, GPW PASSENGER SEAT FRAME	12011.02	A-2925
MB, GPW REAR SEAT FRAME	12011.03	A-2782
AUTHENTIC GPW, REAR SEAT FRAME	12011.15	A2782-GPW
MB, GPW REAR SEAT TO WHEELHOUSE SUPPORT	12021.17	A-2830
MB, GPW REAR SEAT PIVOT BRACKET	12021.18	A-2033
MB, GPW REAR SEAT PIVOT RETAINER	12021.19	A-2945
MB, GPW REAR SEAT HOOK	12021.20	A-2787

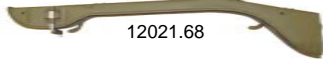

MB GUN RACK	Stock No.
ORIGINAL STYLE REPRODUCTION	12021.68



Crossmembers and Bumper Parts

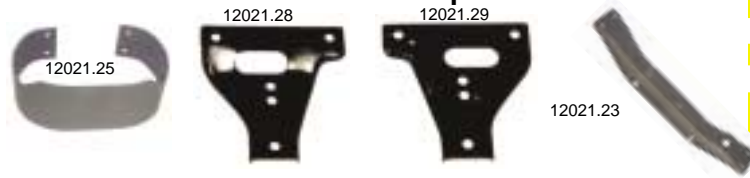

CROSSMEMBERS, BUMPER AND FRAME PARTS	Stock No	Replaces
MB, GPW TM/TC CROSSMEMBER	12021.23	A-5127
MB, GPW REAR CROSSMEMBER	12021.24	A-547
MB, GPW REAR BUMPERETTE (EACH)	12021.25	A-1157
MB, GPW FRONT BUMPER	12021.26	A-1117
MB, FRONT BUMPER WOOD FILL	12021.69	A1147
GPW, FRONT BUMPER WOOD FILL	12021.70	GPW-17751
MB, GPW BUMPER GUSSET, UPPER, DRIVER SIDE	12021.27	A-1127
MB, GPW BUMPER GUSSET, UPPER, PASSENGER SIDE	12021.28	A-1128
MB, GPW BUMPER GUSSET, LOWER, DRIVER SIDE	12021.29	A-1129
MB, GPW BUMPER GUSSET, LOWER, PASSENGER SIDE	12021.30	A-1130
MB CHASSIS FRAME RAIL (TIP), 18.5", LH	12021.31	A-111143
MB CHASSIS FRAME RAIL (TIP), 18.5", RH	12021.32	A-111144

Top Bow Assemblies

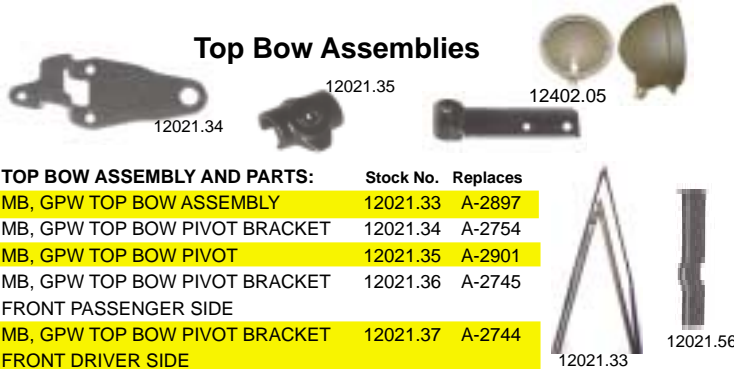

TOP BOW ASSEMBLY AND PARTS:	Stock No.	Replaces
MB, GPW TOP BOW ASSEMBLY	12021.33	A-2897
MB, GPW TOP BOW PIVOT BRACKET	12021.34	A-2754
MB, GPW TOP BOW PIVOT	12021.35	A-2901
MB, GPW TOP BOW PIVOT BRACKET	12021.36	A-2745
FRONT PASSENGER SIDE		
MB, GPW TOP BOW PIVOT BRACKET	12021.37	A-2744
FRONT DRIVER SIDE		

MB & GPW Body Accessories

MB & GPW Body Accessories	Stock No.	Replaces
MB, GPW AXE CLAMP, FRONT	12021.39	A-2995
MB, GPW AXE CLAMP, REAR	12021.40	A-2984
MB, GPW AXE SHEATH	12021.41	A-2968
MB, GPW SHOVEL BRACKET	12021.42	A-3082
MB, GPW FOOTMAN LOOP	12021.43	A-2176
MB TOOL COMPARTMENT LID	12021.44	A-3227
GPW TOOL COMPARTMENT LID	12021.45	A-3227-GPW
MB, GPW GLOVE COMPARTMENT LID	12021.46	A-3825
MB, GPW BODY HANDLE, CORNER	12021.47	A-2389
MB, GPW BODY HANDLE, SIDE	12021.48	A-2390
MB, GPW BLACKOUT DRIVE LAMP BRACKET	12021.49	A-4118
MB, GPW HEADLAMP BRACKET		
PASSENGER SIDE	12021.50	A-2970
MB, GPW HEADLAMP BRACKET	12021.51	A-2971
DRIVER SIDE		

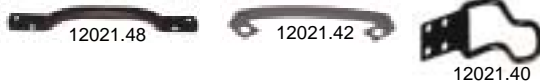

DESCRIPTION	Stock No	Replaces
MB, GPW SHOCK PLATE, REAR DRIVER SIDE	12021.53	A-484
MB, GPW SHOCK PLATE, REAR PASSENGER SIDE	12021.52	A-485
MB, GPW MACHINE MOUNTING PLATE	12021.54	A-1151
MB, GPW REAR FLOOR BRACKET SHORT	12021.55	A-3120
MB, GPW REAR FLOOR BRACKET, LONG	12021.56	A-2336
MB, GPW FOOTREST	12021.57	A-3144
MB, GPW AIR HORN	12021.58	641918
MB, GPW AIR CLEANER TUBE & BRACKET	12021.59	A-6911
MB, GPW MASTER CYL COVER PLATE	12021.60	A-2990
GPW (WILL NOT FIT MB) BATTERY TRAY	12021.61	A-5452
MB, GPW JERRY CAN CARRIER	12021.62	A-4123
JERRY CAN NOT INCLUDED		
MB, OIL CAN BRACKET	12021.63	A-313
MB, CJ2A, CJ3A, CJ3B "V" FRAME BRACKET	12021.64	A-1154
MB, FRONT AXLE, OIL SEAL (WHEEL END)	16526.04	A778



MB Trailer

	DESCRIPTION	Stock No	Replaces
NEW	MB TRAILER ASSY. W/O CHASSIS	12021.71	MB-TRAILER-1
NEW	MB TRAILER ASSY. W CHASSIS	12021.72	MB-TRAILER-2
NEW	MB TRAILER EYE LUNETTE	12021.73	MB-TR-LUNETTE
NEW	MB TRAILER LEG SUPPORT	12021.74	MB-TR-LEG
NEW	MB TRAILER DRAW BAR BRACKET	12021.75	MB-TR-BRKT

Fuel Tanks

	GAS TANK PARTS	Stock No	Replaces
	EARLY MB GAS TANK, SMALL SPOUT	17720.01	A-1221
	LATE MB, GPW GAS TANK, BIG SPOUT	17720.02	A-6618
	EARLY MB GAS TANK WELL	12021.21	A-3497E
	LATE MB, GPW GAS TANK WELL	12021.22	A-3497
	LATE MB, GPW FUEL CAP	17726.01	A-6333
	FOR BIG SPOUT TANK		



Replacement Combat Wheel

Description	Stock No	Replaces
MB, SPLIT STYLE	16725.02	640800-MB
HEADLIGHT & TAIL-GATE	Stock No	Replaces
MB, GPW - Headlight Bucket (w/o Light)	12402.05	A-1304
TAIL-LAMP BUCKET ASSY. MB & GPW, RH=LH	12403.50	A1073
(W/O LENS OR BULB)		
	11550.01	
PINTLE HOOK	Stock No	
PINTLE HOOK	11550.01	

Miscellaneous MB & GPW Parts



BODY PARTS

Body Parts for M38

Notice: body kits, body tubs and body parts are sold "as is". Drilling, cutting and other modifications may be required for proper installation. Claims for freight damage must be placed with freight carriers.



Kits include: Body Tub, Hood, 2 fenders and windshield frame.
Top Bow and other body parts sold separately.

DESCRIPTION	Stock No	Replaces
M38 STEEL BODY KIT	12001.05	673859-38
M38 STEEL BODY TUB ONLY	12002.04	A-12277B0-38
M38 BODY MOUNTING KIT	12201.01	10599050

HOOD, FENDERS & TAILGATE	Stock No	Replaces
M38 STEEL HOOD	12003.02	673442
M38 HOOD HINGE	12021.01	673442-H
M38 STEEL TAILGATE	12005.02	663188-38
AUTHENTIC M38 STYLE FENDER		
M38 STEEL FENDER, DRIVER SIDE	12004.03	681229-3A
M38 STEEL FENDER, PASSENGER SIDE	12004.04	681230-3A

Windshield Frame and Parts

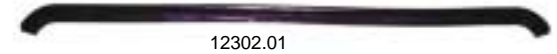
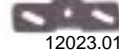

WINDSHIELD FRAME AND PARTS	Stock No	Replaces
M38 WINDSHIELD FRAME	12006.02	673286-38
M38 WINDSHIELD RIGHT PIVOT BRACKET	12023.02	7375313
M38 WINDSHIELD LEFT PIVOT BRACKET	12023.01	7375360
M38 WINDSHIELD FRAME PIVOT BOLT	12023.03	7375087A
M38 WINDSHIELD FRAME CLAMP & HOOK	12023.04	7375312
M38 WINDSHIELD FRAME TO COWL RUBBER	12302.01	A-2476
M38 WINDSHIELD GLASS SEAL KIT	12301.03	978995K
M38 WINDSHIELD FRAME HOOD REST	12023.05	7697482
M38 WINDSHIELD FRAME VENTILLATOR COVER	12023.06	674876

Seat Frames and Parts

SEAT FRAMES AND PARTS	Stock No	Replaces
M38 FRONT DRIVER SIDE SEAT FRAME	12011.05	A-2286-38
M38 FRONT PASSENGER SIDE SEAT FRAME	12011.06	A-2925-38
M38 REAR SEAT FRAME	12011.07	A-2782-38
M38 REAR SEAT WHEELHOUSE SUPPORT	12023.07	A-33029
M38 REAR SEAT PIVOT BRACKET	12023.08	7697487
M38 REAR SEAT PIVOT RETAINER	12023.09	7697510
M38 REAR SEAT SPRING RETAINER	12023.10	7697509



Replacement Panels

STEEL REPLACEMENT PANELS	Stock No	Replaces
M38 FLOOR PANEL ASSEMBLY, FRONT	12007.02	671019-M38
M38 FLOOR PANEL ASSEMBLY, REAR	12008.02	670381-M38
M38 SIDE COWL PANEL WITH STEP DRIVER SIDE	12010.03	671059-M38
M38 SIDE COWL PANEL WITH STEP PASSENGER SIDE	12010.04	671060-M38
M38 SMALL SIDE COWL STEP DRIVER SIDE	12021.15	A-3309-STEP
M38 SMALL SIDE COWL STEP PASSENGER SIDE	12021.16	A-3309-STEP
M38 SIDE PANEL, DRIVER SIDE	12009.03	671071-M38
M38 SIDE PANEL, PASSENGER SIDE	12009.04	671072-M38

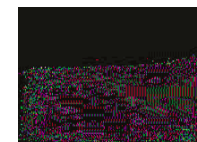
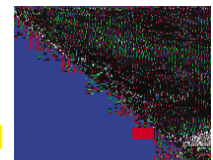

BODY PARTS



12021.16





Gas Tank and Parts

	17720.03		12023.11
DESCRIPTION	Stock No	Replaces	
M38 GAS TANK	17720.03	649759	
M38 GAS TANK GROMMET	12023.11	673415	

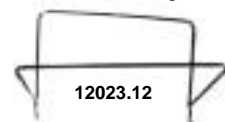

Replacement Wheel

	16725.01	
REPLACEMENT WHEEL	Stock No	Replaces
MB,GPW ONE-PIECE REPLACEMENT	16725.01	640800
CIVILIAN STYLE WHEEL, (16")		

Top Bow Assembly and Parts

	12023.12		12023.13		12023.14		12023.15
DESCRIPTION	Stock No	Replaces					
M38 TOP BOW ASSEMBLY	12023.12	7372859					
M38 TOP BOW SOCKET	12023.13	7372890					
M38 REAR TOP BOW STORAGE BRACKET	12023.14	674300					
M38 FRONT TOP BOW BRACKET	12023.15	673765					

Spare Tire Carrier

	12023.16		12023.17
DESCRIPTION	Stock No	Replaces	
M38 SPARE TIRE CARRIER	12023.16	673337	
M38 SPARE TIRE VIBRATION BUMPER	12023.17	7697437	

Crossmembers and Bumpers

DESCRIPTION	Stock No	Replaces
M38 TM/TC CROSSMEMBER	12023.18	7372507
M38 FRONT BUMPER	12023.19	801386
M38 REAR CROSSMEMBER	12023.20	7372819

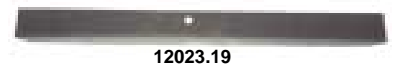

Miscellaneous M38 Body Parts



ITEM #	DESCRIPTION	Stock No	Replaces
1	M38 HEADLIGHT GUARD	12023.21	674875
2	M38 GRILLE/TAILGATE HINGE	12023.22	7697592
3	M38 BLACKOUT DRIVE LAMP BRACKET	12023.23	7372820
4	M38 AXE CLAMP, FRONT	12023.24	7375168
5	M38 AXE SHEATH	12023.25	767341
6	M38 SHOVEL BRACKET	12023.26	A-67341
7	M38 FOOTMAN LOOP, OLIVE GREEN	12023.27	7697591
7	M38 FOOTMAN LOOP, SILVER FINISH	12023.28	7697591-SL
8	M38 RADIO RECEPTACLE BRACKET	12023.29	A-674656
9	M38 FUEL GUARD	12023.30	7372881
10	M38 MACHINE HOLDER BRACKET	12023.31	7375160
11	M38 DOOR CHANNEL TO COWL DRIVER SIDE	12023.33	7377540
11	M38 DOOR CHANNEL TO COWL PASSENGER SIDE	12023.32	7377541
12	M38 DOOR SOCKET HINGE DRIVER SIDE	12023.35	7372896
12	M38 DOOR SOCKET HINGE PASSENGER SIDE	12023.34	7372897
13	M38 INSTRUMENT PANEL	12023.36	7673448
14	M38 MASTER CYL ACCESS PLATE	12023.37	7697522
15	M38 DRAIN HOLE COVER	12023.38	7697520
16	M38 CENTER FRONT TRANS. PANEL	12023.39	673474
17	M38 FIRST AID KIT BRACKET	12023.40	7372677
18	M38 GLOVE BOX DOOR ASSEMBLY	12023.41	7673964
19	M38 TOOL COMPARTMENT LID	12023.42	7375350
20	M38 JERRY CAN CARRIER	12021.62	A-4123
	CAN NOT INCLUDED		

Wiper Motor Kits

UNIVERSAL WIPER MOTORS	Stock No.	Replaces
M38 6-VOLT ELECTRIC WIPER KIT INCLUDES MOTOR, ARM & BLADE	19101.01	6V
M38 12-VOLT ELECTRIC WIPER KIT INCLUDES MOTOR, ARM & BLADE	19101.02	12V
M38 12-VOLT STAINLESS STEEL WIPER KIT INCLUDES MOTOR, ARM & BLADE	19101.03	12V-ST
M38 24-VOLT WIPER KIT INCLUDES MOTOR, ARM & BLADE	19101.04	24V
M38 SPARE WIPER ARM AND BLADE	19102.01	WSHA-1K
FITS ALL ABOVE KITS		

BODY PARTS

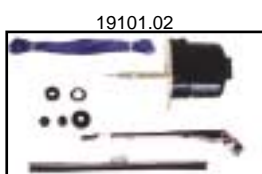

Notice: body kits, body tubs and body parts are sold "as is". Drilling, cutting and other modifications may be required for proper installation. Claims for freight damage must be placed with freight carriers.

Body Kits and Tubs



Kits includes: Body Tub, Hood, 2 fenders and windshield frame. **Top Bow and other body parts sold separately.**

STEEL BODY KITS	Stock No	Replaces
CJ2A	12001.07	673859-2A
CJ3A	12001.08	673859-3A
CJ3B	12001.09	693197

STEEL BODY TUBS	Stock No	Replaces
CJ2A	12002.06	A-12277B0-2A
CJ3A	12002.07	A-12277B0-3A
CJ3B	12002.08	A-12279B0



BODY MOUNTING KIT
CJ2A, CJ3A, CJ3B
Stock No. 12201.01

Fenders, Hoods and Tailgate

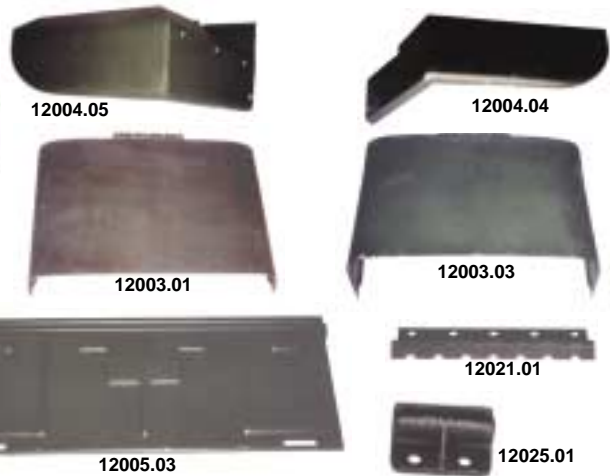

STEEL HOOD, FENDERS AND TAILGATE

	Stock No	Replaces
CJ2A & CJ3A HOOD	12003.01	A-3225
CJ3B HOOD	12003.03	681334
CJ2A, CJ3A, CJ3B HOOD HINGE	12021.01	673442-H
CJ2A, CJ3A, CJ3B TAILGATE	12005.03	663188
CJ2A, CJ3A, CJ3B TAILGATE HINGE (EACH SIDE)	12025.01	7697592
CJ2A FRONT FENDER-DRIVER SIDE	12004.05	681229
CJ2A FRONT FENDER-PASSENGER SIDE	12004.06	681230
CJ3A, CJ3B FRONT FENDER-DRIVER SIDE	12004.03	681229-3A
CJ3A, CJ3B FRONT FENDER-PASSENGER SIDE	12004.04	681230-3A

Windshield Frames and Parts



WINDSHIELD FRAMES AND PARTS

	Stock No	Replaces
CJ2A (INNER & OUTER), WINDSHIELD FRAME	12006.03	673286-2A
CJ3A WINDSHIELD FRAME	12006.04	673286-3A
CJ3B WINDSHIELD FRAME	12006.05	681446
CJ2A, CJ3A, CJ3B WINDSHIELD COWL RUBBER SEAL	12302.01	A-2476
CJ2A WINDSHIELD INNER-OUTER WEATHERSTRIP	12301.01	A-2250
CJ2A WINDSHIELD GLASS SEAL (2 NEEDED)	12301.02	A-2479
CJ3A, CJ3B WINDSHIELD GLASS WEATHERSTRIP	12301.03	978995K
CJ2A INNER WINDSHIELD FRAME	12025.03	663694
CJ2A CENTER WINDSHIELD FRAME LATCH	12025.04	664793
CJ2A WINDSHIELD ADJUSTING ARM KIT LEFT	12025.05	669031K-L
CJ2A WINDSHIELD ADJUSTING ARM KIT RIGHT	12025.06	669031K-R
CJ2A WINDSHIELD ADJUSTING ARM SPARE T-BOLT	12025.07	669031
CJ3A WINDSHIELD VENTILATION COVER & HANDLE KIT	12025.08	671240K
CJ3A WINDSHIELD VENT HANDLE KIT W/O COVER	12025.09	671381K
CJ2A, CJ3A, CJ3B WINDSHIELD CLAMP KIT (EACH SIDE)	12021.04	A-2227
CJ2A, CJ3A, CJ3B WINDSHIELD PIVOT BRACKET LH	12023.01	7375360
CJ2A, CJ3A, CJ3B WINDSHIELD PIVOT BRACKET RH	12023.02	7375313

LICENSED RESTORATION ITEMS:

HOOD PRODUCTS:

- "Willys[®]" Marked Hood: For 1946-53 CJ2A, CJ3A
DMC-670969
- "Willys[®]" Marked Hood: For 1953-64 CJ3B TBA
DMC-681334

TAILGATE PRODUCTS:

- "Willys[®]" Marked Tailgate: For 1946-71 CJ2A, CJ3A/3B
DMC-663188

TOOLBOX PRODUCTS:

- "Jeep[®]" Marked Toolbox: For 1946-75 CJ's
DMC-3227K **NEW**

GRILLE PRODUCTS:

- For CJ2A - Early - 1945-46 DMC-663536 **NEW**
- For CJ2A - Late - 1947-49 DMC-668124 TBA
- For CJ3A - 1949-53 DMC-673149 TBA
- For CJ3B - 1953-64 With "Willys[®]" Mark DMC-681798 **NEW**

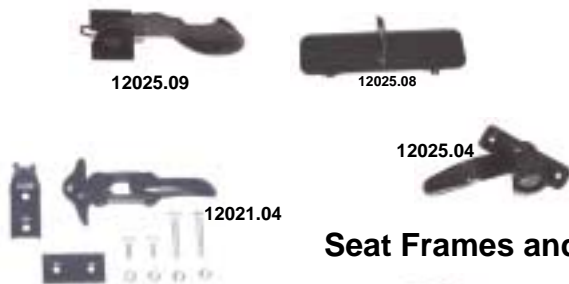
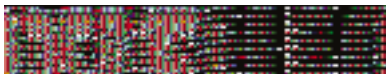

Seat Frames and Parts

SEAT FRAMES

	Stock No.	Replaces
CJ2A REAR SEAT FRAME	12011.08	A-2782-3A
CJ2A FRONT DRIVER SEAT FRAME	12011.09	A-2286-2A
CJ2A FRONT PS SEAT FRAME	12011.10	A-2925-2A
CJ2A, CJ3A, CJ3B UNDERSEAT TOOL COMPARTMENT WITH LID	12025.10	A-3227K-2A

SEAT FRAMES

	Stock No	Replaces
CJ3A REAR SEAT FRAME	12011.12	A-2782-3A
CJ3A FRONT SEAT FRAME, DRIVER	12011.13	A-2286-3A
CJ3A FRONT SEAT FRAME, PASSENGER	12011.14	A-2925-3A

Steel Replacement Panels



12025.11



12009.05



12025.16



12025.21

REPLACEMENT BODY PANELS

	Stock No.	Replaces
CJ2A, CJ3A REAR CENTER FLOOR PANEL	12008.03	670381
CJ2A, CJ3A FRONT FLOOR PANEL	12007.03	671019
CJ2A, CJ3A TOP COWL PLATE	12025.11	671061
CJ2A, CJ3A SIDE BODY PANEL DRIVER SIDE	12009.05	671071
CJ2A, CJ3A SIDE BODY PANEL PASSENGER SIDE	12009.06	671072
CJ2A, CJ3A SIDE COWL PANEL DRIVER SIDE	12010.05	671059
CJ2A, CJ3A SIDE COWL PANEL PASSENGER SIDE	12010.06	671060
CJ2A, CJ3A, CJ3B SIDE COWL STEP ONLY DRIVER SIDE	12021.15	A-3008-STEP
CJ2A, CJ3A, CJ3B SIDE COWL STEP ONLY PASSENGER SIDE	12021.16	A-3309-STEP
CJ2A, CJ3A DASHBOARD PLATE	12025.15	PLATE-2A-1
CJ2A, CJ3A FIREWALL PLATE	12025.16	PLATE-2A-2
CJ2A, CJ3A PANEL TAIL-LIGHT DRIVER SIDE	12025.17	663121
CJ2A, CJ3A PANEL TAIL-LIGHT PASSENGER SIDE	12025.18	663122
CJ3A WHEEL GUARD UPPER DRIVER SIDE	12025.19	663223
CJ3A WHEEL GUARD UPPER PASSENGER SIDE	12025.20	663224
CJ3A WHEEL GUARD LOWER DRIVER SIDE	12025.21	663223-L
CJ3A WHEEL GUARD LOWER PASSENGER SIDE	12025.22	663224-L
CJ2A TOP BOW FRONT, LH, BRACKET ASSY	NEW 12025.35	663089
CJ2A TOP BOW FRONT, RH, BRACKET ASSY	NEW 12025.36	663090
CJ2A TOP BOW FRONT STORAGE BRACKET ASSY.	NEW 12025.37	663107
CJ2A TOP BOW REAR, RH BRACKET ASSY.	NEW 12025.38	663680-R
CJ2A TOP BOW REAR, LH BRACKET ASSY.	NEW 12025.39	663685-L
CJ2A TOP BOW REAR STORAGE BRACKET ASSY.	NEW 12025.40	663685

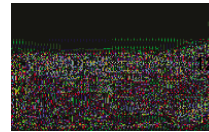

12010.05

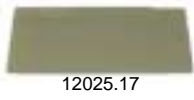

12025.17



12008.03



12007.03

12025.19



12025.15

Fuel Tank and Parts

FUEL TANKS AND PARTS

	Stock No.	Replaces
CJ2A, CJ3A AND EARLY CJ3B STEEL GAS TANK	17720.04	640685
LATE 3B GAS TANK STEEL GAS TANK	17720.05	911895
CJ2A, CJ3A AND EARLY CJ3B POLYETHYLENE GAS TANK	17722.01	640685PL
LATE 3B POLYETHYLENE GAS TANK	17722.03	911895PL
CJ2A, CJ3A, CJ3B GAS TANK GROMMET	12025.23	663502
CJ2A, CJ3A, CJ3B GAS TANK STRAP KIT	12025.24	A-1472K
CJ2A, CJ3A, CJ3B FUEL NECK HOUSING	12025.25	663505



17722.01



12025.24



12025.23



Replacement Steel Wheel

	Stock No.
CJ-2A, 3A, 3B ONE-PIECE REPLACEMENT CIVILIAN STYLE WHEEL, (16")	16725.01



12021.64

Miscellaneous Parts

ITEM #	DESCRIPTION	Stock No.	Replaces
1	CJ2A, CJ3A, CJ3B (CJ5 STYLE) SIDE STEP, LEFT OR RIGHT	12025.26	646150
2	CJ2A, CJ3A, CJ3B SPARE TIRE CARRIER	12025.27	982009
3	CJ2A, CJ3A AIR HORN, L-HEAD	12021.58	641918
3	CJ3B AIR HORN, F-HEAD	12025.29	809785
4	CJ2A, CJ3A AIR CLEANER TUBE & BRACKET	12025.30	641930
5	CJ2A, CJ3A, CJ3B BODY OUTRIGGER, LEFT OR RIGHT	12025.31	645072
6	CJ2A, CJ3A CHROME HEADLIGHT BEZEL (EACH)	12419.01	643732
6	CJ3B CHROME HEADLIGHT BEZEL (EACH)	12419.02	649518
7	CJ2A, CJ3A, CJ3B FOOTMAN LOOP, SILVER FINISH	12023.28	7697591-SL
8	CJ2A, CJ3A, CJ3B REAR FLOOR "L" BRACKET	12021.55	A-3120
9	CJ2A, CJ3A, CJ3B JERRY CAN CARRIER (CAN NOT INCLUDED)	12021.62	A-4123
10	CJ2A WIPER TUBE SET	12025.33	MSO1106
11	PINTLE HOOK	11550.01	A-593
12	CJ2A, CJ3A, CJ3B "V" FRAME BRACKET	12021.64	A-1154



Wiper Motor Kits

UNIVERSAL WIPER MOTORS	Stock No.	Replaces
CJ-2A, 3A, 3B 6-VOLT ELECTRIC WIPER KIT INCLUDES MOTOR, ARM & BLADE	19101.01	6V
CJ-2A, 3A, 3B 12-VOLT ELECTRIC WIPER KIT INCLUDES MOTOR, ARM & BLADE	19101.02	12V
CJ-2A, 3A, 3B 12-VOLT STAINLESS STEEL WIPER KIT INCLUDES MOTOR, ARM & BLADE	19101.03	12V-ST
CJ-2A, 3A, 3B SPARE WIPER ARM AND BLADE FITS ALL ABOVE KITS	19102.01	WSHA-1K



19101.03

12021.64

BODY PARTS

Body Parts for 1955-75 CJ5, CJ6 & M38A1

Notice: body kits, body tubs and body parts are sold "as is". Drilling, cutting and other modifications may be required for proper installation. Claims for freight damage must be placed with freight carriers.

CJ-5
BODY KIT



Kits includes: Body Tub, Hood, 2 fenders and windshield frame.
Top Bow and other body parts sold separately.

STEEL BODY KITS	Stock No.	Replaces
1955-68 CJ5 STEEL BODY KIT	12001.10	680637KA
FENDERS W/O SIDEMARK INDENTS		
1969 CJ5 STEEL BODY KIT	12001.11	680631KB
FENDERS W/SIDEMARK INDENTS		
1970-71 CJ5 STEEL BODY KIT	12001.12	680637KC
FENDERS W/ SIDEMARK INDENTS		
1972-75 CJ5 STEEL BODY KIT	12001.13	680637KD
FENDERS W/ SIDEMARK INDENTS		
1955-71 CJ6 STEEL BODY KIT	12001.14	680637-6K
FENDERS W/O SIDEMARK INDENTS		
1952-68 M38A1 STEEL BODY KIT	12001.15	680637K-38A-1
SOME MODIFICATIONS NECESSARY		

LICENSED RESTORATION ITEMS:

Tailgate Products:

"Jeep." Marked Tailgate: For 1969-83 CJ5 DMC-685459 **NEW**

Body Tub Products:

"Jeep." Marked Body Tub: For 1955-69 CJ5 DMC-680637 **NEW**

"Jeep." Marked Body Tub: For 1970-71 CJ5 DMC-680637-VC **NEW**

"Jeep." Marked Body Tub: For 1972-75 CJ5 DMC-680637-VD **NEW**

Toolbox Products:

"Jeep." Marked Toolbox: For 1946-75 CJ's DMC-3227K **NEW**

Grille Products:

For CJ5, CJ6 - 1955-71 DMC-815385
For CJ5, CJ7, CJ8 - 1972-86 DMC-5752656

SEE PAGE 3
FOR OUR
COMPLETE
LINE OF
LICENSED
PRODUCTS

Grille Cover Products:

Stainless Steel Grille Overlay:
For 1972-86 CJ5, CJ7, CJ8 DMC-5752247-ST
GRILLE COVERS ARE RE-
PRODUCTION ITEMS

BODY MOUNTING KIT	Stock No.	Replaces
CJ2A, CJ3A, CJ3B	12201.01	10599050

CJ-6 BODY TUB



12201.01

TAILGATE NOT INCLUDED

STAINLESS STEEL BODY FASTENER KITS	Stock No.	Replaces
1955-71 CJ5 & CJ6, 405 PCS	12215.01	62108
1972-75 CJ5 & CJ6 WITH TAILGATE, 539 PCS	12215.02	62116
1972-75 CJ5 WITHOUT TAILGATE, 456 PCS	12215.03	62112
1972-75 CJ5 2" BODY MOUNTING WASHER, 8 PCS	12217.01	64270

STEEL BODY TUBS	Stock No.	Replaces
1955-69 CJ5	12002.09	680637
SIDE GAS FILL, NO COWL VENT		
1970-71 CJ5	12002.10	680637-VC
NO SIDE GAS FILL, NO COWL VENT		
1972-75 CJ5	12002.11	680637-VD
NO SIDE GAS FILL, HAS COWL VENT		
1955-71 CJ6	12002.12	680637-6
NO SIDE GAS FILL, HAS COWL VENT		

12025.01



12004.07



12003.05



12005.03



12004.09



12005.04

DESCRIPTION	Stock No.	Replaces
1955-71 CJ5, CJ6, M38A1 STEEL HOOD	12003.04	986330
1972-75 CJ5 STEEL HOOD	12003.05	5761180
1972-75 GRILLE TO HOOD GROMMET (4 NEEDED)	12029.01	5455348
1955-75 CJ5, CJ6 STEEL TAILGATE	12005.03	663188
1955-75 CJ5, CJ6 TAILGATE HINGE, EACH (NEED 2)	12025.01	7697592
1953-68 M38A1 REAR TAILGATE PANEL	12005.04	A-2758-38A1
1953-68 CJ5, CJ6 FENDER, DRIVER SIDE WITHOUT SIDEMARKER INDENT	12004.07	688233
1953-68 CJ5, CJ6 FENDER, PASSENGER SIDE WITHOUT SIDEMARKER INDENT	12004.08	688234
1969-71 CJ5, CJ6 FENDER, DRIVER WITH SIDEMARK INDENT	12004.09	984705
1969-71 CJ5, CJ6 FENDER, PASSENGER WITH SIDEMARK INDENT	12004.10	984706
1972-75 CJ5, CJ6 FENDER, DRIVER SIDE	12004.11	5758965
1972-75 CJ5, CJ6 FENDER, PASSENGER SIDE	12004.12	5758964



12003.04



12004.12

1955-75 CJ FENDER FLARES	Stock No.	Replaces
1955-75 CJ5 4-PCS FENDER FLARE KIT W/HARDWARE	11601.01	8997109
1955-75 CJ5, CJ6 FRONT FENDER FLARE, DRIVER SIDE	11601.03	5455071
1955-75 CJ5, CJ6 FRONT FENDER FLARE, PASSENGER SIDE	11601.02	5455072
1955-75 CJ5 REAR FENDER FLARE, DRIVER SIDE	11601.05	5455073
1955-75 CJ5 REAR FENDER FLARE, PASSENGER SIDE	11601.04	5455074
1955-75 CJ SPARE HARDWARE KIT FOR FENDER FLARES	11601.06	7109K

11601.01



BODY PARTS

Windshield Frames and Parts

WINDSHIELD FRAMES AND PARTS

	Stock No.	Replaces
1955-68 CJ5, CJ6 WINDSHIELD FRAME TOP WIPERS	12006.06	973727
1969-75 CJ5, CJ6 WINDSHIELD FRAME BOTTOM WIPERS	12006.07	987996
1951-75 CJ5, CJ6 COWL RUBBER SEAL	12302.02	989844
1951-75 M38-A1, CJ5, CJ6 WINDSHIELD GLASS SEAL	12301.03	978995K



Bumpers and Crossmembers



BUMPERS AND CROSSMEMBERS

	Stock No.	Replaces
1955-75 CJ5, CJ6, CJ7, CJ8 FRONT BUMPER OE STYLE	12029.03	5355342
1955-75 CJ REAR CROSSMEMBER	12027.01	8127710

Replacement Panels and Miscellaneous Parts



DESCRIPTION

	Stock No.	Replaces
1955-75 CJ5 FRONT FLOOR PANEL	12007.04	989291
1955-75 CJ5 REAR FLOOR PANEL	12008.04	5456536
1955-71 CJ5, CJ6 TOOL COMPARTMENT WITH LID	12025.10	A-3227K-2A
1955-71 CJ5, CJ6 CENTER FRONT TRANSMISSION PANEL	12027.02	688966
1955-71 CJ5, CJ6 SIDE STEP, LEFT OR RIGHT	12025.26	646150
1955-71 CJ5, CJ6 SPARE TIRE CARRIER	12025.27	982009
1955-71 CJ5, CJ6 FUEL NECK HOUSING	12025.25	663505
1955-75 CJ5, CJ6, M38A1 JERRY CAN CARRIER	12021.62	A-4123
JERRY CAN NOT INCLUDED		
PINTLE HOOK	11550.01	A-593

REPLACEMENT WHEEL

	Stock No.	Replaces
1955-75 CJ-5, CJ-6 ONE-PIECE REPLACEMENT CIVILIAN STYLE WHEEL, (16")	16725.01	640800

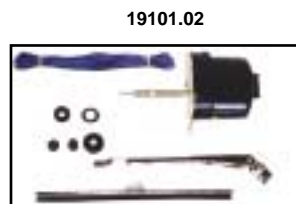

UNIVERSAL WIPER MOTORS

	Stock No.	Replaces
1955-67 CJ 6-VOLT ELECTRIC WIPER KIT INCLUDES MOTOR, ARM & BLADE	19101.01	6V
1955-67 CJ 12-VOLT ELECTRIC WIPER KIT INCLUDES MOTOR, ARM & BLADE	19101.02	12V
1955-67 CJ 12-VOLT STAINLESS STEEL WIPER KIT INCLUDES MOTOR, ARM & BLADE	19101.03	12V-ST
1955-67 CJ SPARE WIPER ARM AND BLADE	19102.01	WSHA-1K
FITS ALL ABOVE KITS		

Notice: body kits, body tubs and body parts are sold "as is". Drilling, cutting and other modifications may be required for proper installation. Claims for freight damage must be placed with freight carriers.



BODY MOUNTING KIT	Stock No.	Replaces
1976-86 CJ-5, CJ-7, CJ-8	12201.02	5462446K
1976-86 CJ-7 & 1987-95 YJ FIBER GLASS BODIES ONLY	12201.03 NEW	76867K

STAINLESS STEEL BODY MOUNT WASHERS	Stock No.	Replaces
1976-83 CJ5 2" (8 PCS)	12217.01	64270
1976-86 CJ7 & CJ8 2" (10 PCS)	12217.02	64271

Kits includes: Body Tub, Hood, 2 fenders and windshield frame.
Top Bow and other body parts sold separately.



Late CJ-5 Body Kit

CJ-7 Body Kit

SEE PAGE 3
FOR OUR
COMPLETE
LINE OF
LICENSED
PRODUCTS

LICENSED RESTORATION ITEMS:

Grille Products:

For CJ5, CJ7, CJ8 - 1972-86 **DMC-5752656**

Grille Cover Products:

Stainless Steel Grille Overlay:
For 1972-86 CJ5, CJ7, CJ8 **DMC-5752247-ST**

GRILLE COVERS
ARE REPRODUC-
TION ITEMS

STEEL BODY KITS	Stock No.	Replaces
1976-83 CJ-5	12001.16	5461335K
1976-86 CJ-7	12001.17	5464362K
1981-86 CJ-8	12001.18	5763816K

STEEL BODY TUBS	Stock No.	Replaces
1976-83 CJ-5	12002.13	5461335
1976-86 CJ-7	12002.14	5464362
1981-86 CJ-8	12002.15	5763816

LICENSED RESTORATION ITEMS:

Body Tub Products*:

"Jeep®" Marked Body Tub: For 1976-83 CJ5

"Jeep®" Marked Body Tub: For 1976-86 CJ7



DMC-5461335 TBA
DMC-5464362 TBA

* The "Jeep®" script used for the 1976-86 CJ body tubs is based on the design originally manufactured for 1976-80 production years.

STAINLESS STEEL FASTENER KITS	Stock No.	Replaces
1976-83 CJ5 (MODELS WITH TAILGATE), 624 PCS	12215.04	62124
1976-83 CJ5 (MODELS W/O TAILGATE), 592 PCS	12215.05	62120
1976-86 CJ7 WITH HARDTOP, 785 PCS	12215.06	62132
1976-86 CJ7 WITH SOFT TOP, 620 PCS	12215.07	62128
1981-86 CJ8 WITH HARDTOP, 714 PCS	12215.09	62140
1981-86 CJ8 WITH SOFT TOP, 640 PCS	12215.10	62136

LICENSED RESTORATION ITEMS:

Tailgate Products:

"Jeep®" Marked Tailgate:

For 1969-83 CJ5 **DMC-685459** **NEW**

For 1976-86 CJ7 **DMC-5454025**



12005.05

12029.03

12029.04

Hood and Tailgate Parts



12025.01 12029.01



12005.03



12029.27

DESCRIPTION	Stock No.	Replaces
1976-86 CJ5, CJ7, CJ8 STEEL HOOD	12003.05	5761180
1976-95 CJ & YJ BOLT	12029.30 NEW	4004455
HINGE TO HOOD, FENDER TO CAWL, FENDER TO GRILLE		
1976-86 CJ GRILL TO HOOD GROMMET (4 NEEDED)	12029.01	5455348
1976-83 CJ5 STEEL TAILGATE	12005.03	663188
1976-83 CJ5 TAILGATE HINGE, EACH	12025.01	7697592
1976-86 CJ7, CJ8 STEEL TAILGATE	12005.05	5454025
1976-86 CJ7 & CJ8 TAILGATE CABLE (2 NEEDED)	12029.02	5752617
TAILGATE LATCH BRACKET, CJ7 & CJ8	12029.25 NEW	5454030
1976-86 CJ7 & CJ8, LATCH BRACKET KIT (ONE SIDE) (INCLUDES BOLT AND WAVE WASHERS)	12029.26 NEW	5454030K
76-86 CJ7 & CJ8 BRACKET KIT (PAIR) (INCLUDES BOLT AND WAVE WASHERS)	12029.27 NEW	5454030-K2
1976-86 CJ7 & CJ8 BOLT FOR TAILGATE LATCH	12029.28 NEW	957717
1976-86 CJ7 & CJ8 WAVE WASHER FOR TAILGATE LATCH	12029.29 NEW	958649

12003.05

Bumpers and Crossmembers

BUMPERS AND CROSSMEMBERS	Stock No.	Replaces
1955-86 CJ5, CJ6, CJ7 & CJ8 FRONT BUMPER (OE STYLE)	12029.03	5355342
1976-86 CJ5, CJ7, CJ8 REAR CROSSMEMBER	12029.04	8127711
1976-86 CJ BUMPERETTES PAIR, BLACK	11215.01	5355457K



12004.12



12029.02

SEE OUR 7" CJ
FLARES ON PAGE
PAGE 53

Fenders and Flares

FENDERS AND FLARES	Stock No.	Replaces
1976-86 CJ5, CJ6, CJ7, CJ8 STEEL FENDER DRIVER SIDE	12004.11	5758965
1976-86 CJ5, CJ6, CJ7, CJ8 STEEL FENDER PASSENGER SIDE	12004.12	5758964
1976-86 CJ5, CJ6, CJ7 4-PCS FENDER FLARE KIT INCLUDES ALL NECESSARY HARDWARE	11601.01	8997109
1976-86 CJ5, CJ6, CJ7, CJ8 FRONT FENDER FLARE DRIVER SIDE	11601.03	5455071
1976-86 CJ5, CJ6, CJ7, CJ8 FRONT FENDER FLARE PASSENGER SIDE	11601.02	5455072
1976-86 CJ5, CJ6, CJ7 REAR FENDER FLARE DRIVER SIDE	11601.05	5455073
1976-86 CJ5, CJ6, CJ7 REAR FENDER FLARE PASSENGER SIDE	11601.04	5455074
1976-95 CJ & WRANGLER SPARE HARDWARE KIT	11601.06	7109K



11601.01

12029.05

LICENSED RESTORATION ITEMS:

Dashpad Products:

"Jeep®" Marked Dashpad:

For 1976-86 CJ's. Black **DMC-5760458**

For 1976-86 CJ's. Light Gray **DMC-5760459**

paintable

1976-86 CJ screw for Dashpad **12029.31** **NEW**
(8 needed) **974764**

1976-86 CJ screw kit dash pad **12029.32** **NEW**
(Total 8 pieces) **974764-K8**



DMC-5760458

Windshield Parts

WINDSHIELD FRAME AND PARTS	Stock No.	Replaces
1976-86 CJ5, CJ7, CJ8 STEEL WINDSHIELD FRAME	12006.08	5453941
1976-86 CJ5, CJ7, CJ8 WINDSHIELD GLASS SEAL	12301.04	5453949
1976-95 CJ WINDSHIELD HINGE SCREW (16 Required)	12029.06	4004956
1976-86 CJ5, CJ7, CJ8 WINDSHIELD HINGE SET BARE METAL-LEFT AND RIGHT SET	12029.07	5462426
1976-86 CJ5, CJ7, CJ8 WINDSHIELD HINGE BARE METAL-LEFT ONLY	12029.09	5462425
1976-86 CJ5, CJ7, CJ8 WINDSHIELD HINGE BARE METAL-RIGHT ONLY	12029.08	5462424
1976-86 CJ5, CJ7, CJ8 COWL RUBBER SEAL	12302.03	5453950
1976-86 CJ5, CJ7, CJ8 WINDSHIELD FRAME KNOB, BLACK	13318.01	5457045
1976-86 CJ5, CJ7, CJ8 WIPER PIVOT COVER	13318.02	5459153
1976-86 CJ5, CJ7, CJ8 WIPER MOTOR COVER, BLACK	19135.01	5756806-BL
1976-86 CJ WINDSHIELD GLASS	12029.10	5453847



1976-86 ALL CJ'S, KIT, BLACK (INCLUDES CLAMP)
11214.01 5764665K

Replacement Side Panels

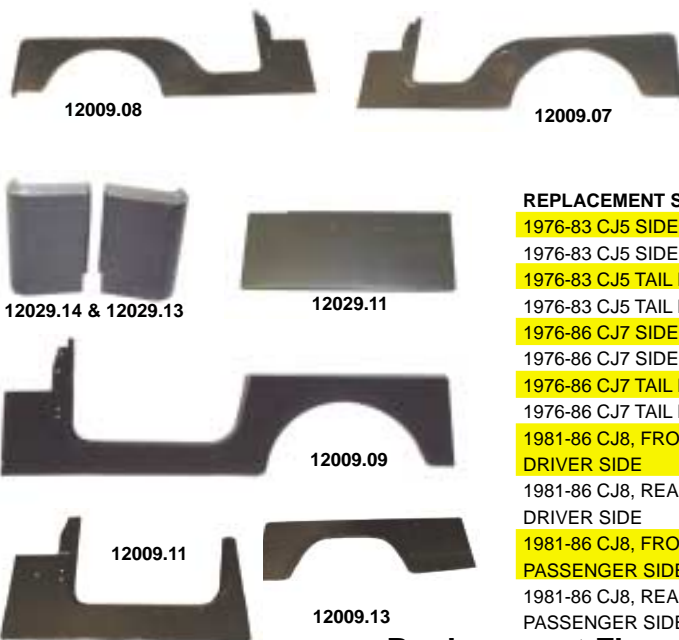

Description	Stock No.	Replaces
CAM & CABLE, CJ7 HARDTOP	11901.03	8128163
LATCH ASSEMBLY, CJ7 HARDTOP	11901.04	8128164

REPLACEMENT SIDE AND CORNER PANELS	Stock No.	Replaces
1976-83 CJ5 SIDE PANEL DRIVER SIDE	12009.07	8133112
1976-83 CJ5 SIDE PANEL PASSENGER SIDE	12009.08	8133337
1976-83 CJ5 TAIL LIGHT PANEL, DRIVER SIDE	12029.11	5463647
1976-83 CJ5 TAIL LIGHT PANEL, PASSENGER SIDE	12029.12	5463648
1976-86 CJ7 SIDE PANEL, DRIVER SIDE	12009.09	8133339
1976-86 CJ7 SIDE PANEL PASSENGER SIDE	12009.10	8133338
1976-86 CJ7 TAIL LIGHT PANEL DRIVER SIDE	12029.14	5764220
1976-86 CJ7 TAIL LIGHT PANEL PASSENGER SIDE	12029.13	5764221
1981-86 CJ8, FRONT PORTION OF SIDE PANEL DRIVER SIDE	12009.11	8133343-F
1981-86 CJ8, REAR PORTION OF SIDE PANEL DRIVER SIDE	12009.13	8133343-RR
1981-86 CJ8, FRONT PORTION OF SIDE PANEL PASSENGER SIDE	12009.12	8133342-F
1981-86 CJ8, REAR PORTION OF SIDE PANEL PASSENGER SIDE	12009.14	8133342-RR

Replacement Floor Panels

REPLACEMENT FLOOR PANELS	Stock No.	Replaces
1976-83 CJ5 FRONT FLOOR PANEL	12007.05	5766128
1973-83 CJ5 REAR FLOOR PANEL	12008.05	8133142
1976-86 CJ7, CJ8 FRONT FLOOR PANEL	12007.06	5756105
1976-86 CJ7 REAR FLOOR PANEL	12008.06	5766471



Miscellaneous Replacement Panels

MISCELLANEOUS REPLACEMENT PANELS	Stock No.	Replaces
1976-86 CJ7 REAR WHEEL HOUSING PASSENGER SIDE	12029.16	55010578
1976-86 CJ7 REAR WHEEL HOUSING DRIVER SIDE	12029.15	55010579
1976-86 CJ6, CJ7 & CJ8 TOP COWL PLATE	12029.17	5758706
1976-86 CJ5, CJ7 & CJ8 DASHBOARD PLATE	13320.01	5763630
1976-86 CJ5, CJ7 & CJ8 FIREWALL PLATE	12029.18	5763510
1976-86 CJ GLOVE BOX LOCK, LATCH BRACKET	13317.01	957276
1976-86 CJ GLOVE BOX BUTTON	11813.11	5450252K

Miscellaneous Seals and Plugs

MISCELLANEOUS SEALS AND PLUGS	Stock No.	Replaces
1976-86 CJ 1" FLOOR PLUGS (EACH)	12029.19	4005695
1977-86 CJ7 LIFTGATE OUTER SEAL WITH PLASTIC LOCKS	12304.01	5454184
1977-86 CJ7 LIFTGATE INNER GLASS SEAL	12304.02	5758072
1976-86 CJ DOOR WEATHER SEAL PASSENGER	12303.02	55176222
1976-86 CJ DOOR WEATHER SEAL DRIVER SIDE	12303.01	55176223
1976-86 CJ7 & CJ8 TAILGATE SEAL	12305.01	5457112

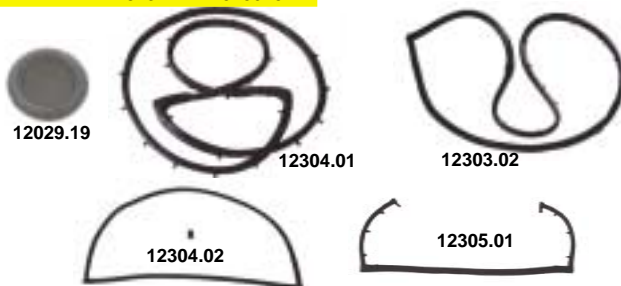

BODY PARTS

Notice: body kits, body tubs and body parts are sold "as is". Drilling, cutting and other modifications may be required for proper installation. Claims for freight damage must be placed with freight carriers.



12031.01



REPLACEMENT

STEEL FENDERS

	Stock No.	Replaces
1987-95 YJ WRANGLER DRIVER SIDE	12004.13	55013315
1987-95 YJ WRANGLER PASSENGER SIDE	12004.14	55013514
1997-06 TJ WRANGLER DRIVER SIDE	12004.15	5003951AD
1997-06 TJ WRANGLER PASSENGER SIDE	12004.16	5003950AD



Omix-Ada, Inc.

REPLACEMENT HOOD PARTS

	Stock No.	Replaces
1987-95 YJ WRANGLER STEEL HOOD	12003.06	55013508
1998-00 TJ WRANGLER HOOD	12003.07	55176594
2001-06 TJ WRANGLER HOOD WITH SPRAY NOZZLE HOLES	12003.08	5066182AA
1987-95 WRANGLER HOOD GROMMET GRILL TO HOOD (2 NEEDED)	12031.01	4007504
1976-95 CJ & YJ BOLT, HINGE TO HOOD FENDER TO CAWL, FENDER TO GRILL	12029.30	NEW 4004455
1987-02 WRANGLER HOOD TO FENDER GROMMET	12031.02	4007541



CHROME GRILL COVER

	Stock No.
1997-06 TJ WRANGLER (GENUINE MOPAR BRAND)	12033.01



12009.09



12029.15

BODY PANELS

	Stock No.	Replaces
1987-96 YJ WRANGLER SIDE PANEL DRIVER SIDE	12009.09	8133339
1987-96 YJ WRANGLER SIDE PANEL PASSENGER SIDE	12009.10	8133338
1987-96 YJ WRANGLER REAR WHEEL HOUSING PASSENGER SIDE	12029.16	55010578
1987-96 YJ WRANGLER REAR WHEEL HOUSING DRIVER SIDE	12029.15	55010579

LICENSED RESTORATION ITEMS:

Grille Cover Products:

For YJ Wrangler

DMC-55026587-ST

GRILLE COVERS
ARE REPRODUCTION
ITEMS



12005.06

STEEL TAILGATES

	Stock No.	Replaces
1987-95 YJ WRANGLER	12005.06	57001412
1997-06 TJ WRANGLER	12005.07	55176340AD

SEE PAGE 3
FOR OUR
COMPLETE
LINE OF
LICENSED
PRODUCTS



12006.09

WINDSHIELD FRAMES

	Stock No.	Replaces
1987-95 YJ WRANGLER	12006.09	55023067
1997-02 TJ WRANGLER	12006.10	55174607AB
1976-95 CJ & YJ WINDSHIELD HINGE SCREW (16 Required)	12029.06	4004956



11602.02

SEE PAGES
52-53
FOR OUR
COMPLETE
LINE OF
FLARES

SPREADER BARS

	Stock No.	Replaces
1987-95 WRANGLER, FACTORY STYLE EACH	11251.01	89998
1987-95 WRANGLER, ADJUSTABLE, PAIR	11251.02	89999



11603.02

1987-95 YJ WRANGLER FLARES AND PART

	Stock No.	Replaces
FLARE KIT: INCLUDES 4 FLARES, 2 EXTENSIONS, BRACKETS AND HARDWARE KIT	11602.01	4206
FLARE KIT (4 PCS) INCLUDES: 4 FLARES & HARDWARE KIT	11602.02	5AHK
FLARE-FRONT DRIVER SIDE	11602.03	5AH15JX9
FLARE-FRONT PASSENGER SIDE	11602.04	5AH14JX9
FLARE-REAR DRIVER SIDE	11602.05	5AH17JX9
FLARE-REAR PASSENGER SIDE	11602.06	5AH16JX9
FRONT EXTENSION DRIVER SIDE	11602.07	55007317
FRONT EXTENSION PASSENGER SIDE	11602.08	55007316
HARDWARE KIT (PLASTIC LOCKS & SCREWS) EXTENSION BRACKET NOT INCLUDED	11601.06	7109K
FRONT EXTENSION BRACKET	11602.09	6030441

1997-06 TJ WRANGLER REPLACEMENT

FLARES AND PARTS

	Stock No.	Replaces
FLARE KIT (6 PCS) INCLUDES 4 FLARES, EXTENSIONS & HARDWARE	11603.01	4207
FLARE KIT (4 PCS) FLARES ONLY HARDWARE NOT INCLUDED	11603.02	55254918K
FLARE-FRONT PASSENGER SIDE	11603.04	55254918
FLARE-FRONT DRIVER SIDE	11603.03	55254919
FLARE-REAR PASSENGER SIDE	11603.06	55175726
FLARE-REAR DRIVER SIDE	11603.05	55175727
FLARE EXTENSION PASSENGER SIDE	11603.08	55254928
FLARE EXTENSION DRIVER SIDE	11603.07	55254929
HARDWARE KIT FOR TJ	11603.09	OMIX-T-FHW

*WILL NOT FIT SAHARA MODELS

SEE PAGES 52-53 FOR OUR COMPLETE LINE OF FLARES

Improve your vehicles aggressive, rugged looks with Omix's 7" Fender Flares. Not just for looks - These durable thermoplastic flares also provide added protection from road debris and stone chips

OMIX 7" FENDER FLARES AND KITS:	Stock No.	Replaces
7" Flare, YJ Wrangler Kit: 6 pcs w/ Hardware	NEW 11607.01	
7" FENDER FLARE, FRONT RH YJ WRANGLER W/O HARDWARE	NEW 11607.02	FY7-FR
7" FENDER FLARE FRONT LH YJ WRANGLER W/O HARDWARE	NEW 11607.03	FY7-FL
7" Flare, TJ Wrangler Kit: 6 pcs : (2) Front, RH & LH and (2) Rear, RH & LH, (2) Extension, RH & LH	NEW 11608.01	
1997-06 TJ WRANGLER, 7" FLARE FRONT RH	NEW 11608.02	FT7-FR
1997-06 TJ WRANGLER, 7" FLARE FRONT LH	NEW 11608.03	FT7-FL
1997-06 TJ WRANGLER, 7" FLARE REAR RH	NEW 11608.04	FT7-RR
1997-06 TJ WRANGLER, 7" FLARE REAR LH	NEW 11608.05	FT7-RL



7" Flare, YJ Wrangler

RuggedRidge 7" YJ Fender Flares use a TJ Style Rear Flare enabling it to cover a larger wheel space (as may be required by law). This feature also makes it necessary to cut the wheel housings to accept a larger size tire. Cutting & Drilling Required

STAINLESS STEEL FASTENER KITS	Stock No.	Replaces
1987-95 YJ WRANGLER WITH HARDTOP, 754 PCS	12215.11	62406
1987-95 YJ WRANGLER WITH SOFT TOP, 703 PCS	12215.12	62402
1987-95 YJ WRANGLER 2" BODY MOUNTING WASHER KIT (8 PCS)	12217.03	64272

BUMPER PARTS	Stock No.	Replaces
1987-95 YJ WRANGLER FRONT BUMPER (OE STYLE)	12031.03	55234777
1987-95 YJ WRANGLER FRONT BUMPER ENDS LEFT & RIGHT PAIR, OE STYLE	12031.04	82200529
1987-95 YJ WRANGLER BUMPERETTES (PAIR)	11215.11	5355457K
1997-06 TJ WRANGLER FRONT BUMPER, (W/O HARDWARE), BLACK	NEW 12033.02	5ED16T3X
1997-06 TJ WRANGLER FRONT BUMPER, (W/O HARDWARE), STAINLESS	NEW 11107.05	5ED16T3X-ST
1997-06 TJ WRANGLER REAR BUMPER, (W/O HARDWARE), STAINLESS	NEW 11107.06	5ED18JX8AB-ST
1997-06 TJ WRANGLER REAR BUMPER, (W/O HARDWARE), BLACK	NEW 12033.03	5ED18JX8AB
1997-06 TJ WRANGLER FRONT LH BUMPER PLASTIC EXTENSION	NEW 12031.07	55155757AA
1997-06 TJ WRANGLER FRONT RH BUMPER PLASTIC EXTENSION	NEW 12031.08	55155756AA
1997-06 TJ WRANGLER REAR LH BUMPER PLASTIC EXTENSION	NEW 12031.09	55155761AB
1997-06 TJ WRANGLER REAR RH BUMPER PLASTIC EXTENSION	NEW 12031.10	55155760AB
SCREW (EACH), TJ BUMPER CORNER TO BUMPER BOTH FRONT AND REAR	12032.01	6504212



12031.03

11107.06

DOOR INSERTS	Stock No	Replaces
1987-06 YJ & TJ, DOOR INSERTS (GROMMETS) (BLACK)	NEW 11818.01	5FB63RXA
1987-06 YJ & TJ, DOOR INSERTS (GROMMETS) (GRAY)	NEW 11818.09	5FB63JS1
1987-06 YJ & TJ, DOOR INSERTS (GROMMETS) (SPICE)	NEW 11818.37	5FB63RTB

HOOD CATCH KITS	Stock No.	Replaces
1997-06 TJ HOOD CATCH BRACKET BLACK OE STYLE LH = RH	NEW 11210.06	55176428AC
1997-06 TJ HOOD CATCH BLACK OE STYLE LH = RH	NEW 11210.07	55176636AD
1997-06 TJ HOOD CATCH KIT BLACK OE STYLE LH = RH	NEW 11210.08	55176636K
1997-06 TJ HOOD CATCH KIT PAIR, BLACK OE STYLE LH = RH	NEW 11210.09	55176636-K2



11818.01

11818.09

11818.37



BODY LIFT KIT 18303.10

1997-04 TJ BODY LIFT KIT 2-3 INCH 18303.10

WEATHERSTRIP SEALS AND MISCELLANEOUS PARTS	Stock No.	Replaces
1987-95 YJ WRANGLER COWL RUBBER SEAL	12302.04	55009127
1987-95 YJ WRANGLER YJ GLASS SEAL	12301.05	55019988
1987-95 YJ WRANGLER WINDSHIELD GLASS LOCK SEAL (ONLY)	12301.06	55134655
1987-95 YJ WRANGLER WINDSHIELD GLASS SEAL CLIP	12301.07	55134656
1987-95 YJ WRANGLER DOOR WEATHER SEAL PASSENGER	12303.02	55176222
1987-95 YJ WRANGLER DOOR WEATHER SEAL DRIVER SIDE	NEW 12303.03	55009829
1997-UP TJ WITH FULL DOOR, RH, WEATHERSTRIP OUTER DOOR	NEW 12303.12	5017462AF
1997-UP TJ WITH FULL DOOR, LH, WEATHERSTRIP OUTOR DOOR	NEW 12303.13	5017463AF
1997-UP TJ RH, HALF DOOR, OUTER SEAL	NEW 12303.14	5017010AB
1997-UP TJ LH, HALF DOOR, OUTER SEAL	12303.15	5017011AB
1987-95 YJ WRANGLER TAILGATE SEAL	12305.02	55009742
1987-95 YJ WRANGLER FLOOR PLUG (EACH)	12031.05	55006578
1987-95 LIFT GATE SUPPORT	12012.01	G0004761
1997-04 TJ, WITH HARDTOP: LIFT GATE SUPPORT	NEW 12012.02	55076310AB
1987-95 YJ, TAILGATE'S UPPER WEATHERSTRIP	12304.09	55009398



12031.10

12031.04

11215.11



12302.04

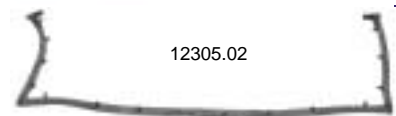

12305.02

BODY PARTS

1984-96 XJ FENDER FLARES AND KITS..

4 pcs Kit	11605.01	5AG-K4
Front Passenger Side	11605.02	5AG24JX9
Front Driver Side	11605.03	5AG25JX9
Rear Passenger Side	11605.04	5AG30JX9
Rear Driver Side	11605.05	5AG31JX9

XJ FENDER FLARES
11605.01

HEAVY DUTY TOW HOOK PAIR KIT

1984-01 XJ , FRONT **NEW** 11236.05

11236.05

HEAVY DUTY STEERING GEAR BOX BRACE

1984-01 XJ CHEROKEE **NEW** 18021.05

18021.05

HEAVY DUTY TRANSFER CASE CROSSMEMBER

1984-01 XJ **NEW** 12035.60

12035.60

XJ CHEROKEE HOODS	Stock No.	Replaces
1984-86 XJ CHEROKEE	12035.01	57000051
1987-96 XJ CHEROKEE	12035.02	55254574
1997-01 XJ CHEROKEE	12035.03	55235439



12035.12

XJ CHEROKEE SIDE MIRRORS

YEAR	SIDE	FINISH	REMOTE	PWR	HEAT	Stock No.
1984-96	PASS	BLK				12035.08
1984-96	DR	BLK				12035.09
1984-96	PASS	BLK	X			12035.10
1984-96	DR	BLK	X			12035.11
1984-96	PASS	BLK	X	X		12035.12
1984-96	DR	BLK	X	X		12035.13
1984-96	PASS	CHR	X			12035.14
1984-96	DR	CHR	X			12035.15
1997-01	PASS	BLK	X			12035.16
1997-01	DR	BLK	X			12035.17
1997-01	PASS	BLK	x	X		12035.18
1997-01	DR	BLK	X	X		12035.19
1997-01	PASS	BLK	X	X	X	12035.20
1997-01	DR	BLK	X	X	X	12035.21



XJ CHEROKEE FRONT

GRILLE SUPPORT	Stock No.	Replaces
1984-90	12035.22	83506616
1991-96	12035.23	55294926
1997-01	12035.24	55055233AD

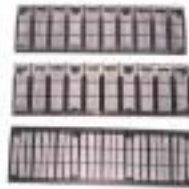

XJ CHEROKEE GRILLE INSERTS

	Stock No.	Replaces
1984-87 BLACK/GRAY	12035.25	55000153
1984-90 BLACK/CHROME	12035.26	55002229
1987-90 BLACK/BLACK	12035.27	55013145
1991-92 BLACK	12035.28	55034044
1993-96 BLACK	12035.29	55054945
1991-96 BLACK/CHROME	12035.30	55034046
1997-01 BLACK (COUNTRY MODELS)	12035.31	5EM65DX8
1997-01 BLACK (SE & SPORT MODELS)	12035.32	55055150

LOCKS & CYLINDERS FOR DOOR & TAILGATE

	Stock No.	Replaces
DOOR CYLINDER & LOCK: 1991-94 XJ CHEROKEE, ZJ GRAND CHEROKEE	11813.03	4720931
DOOR CYLINDER & LOCK: 1995-97 XJ CHEROKEE, 1995 ZJ GRAND CHEROKEE	11813.04	4778123
DOOR CYLINDER & LOCK: 1998-01 XJ CHEROKEE, 1996-98 ZJ GRAND CHEROKEE	11813.05	4864651
DOOR CYLINDER & LOCK: 1999-04 WJ GRAND CHEROKEE, 2004 KJ LIBERTY	11813.06	5013682AA
DOOR CYLINDER & LOCK: 2002-03 KJ LIBERTY	11813.07	5072294AA



11813.05

12035.34 & 12035.35



BUMPER GUARDS

	Stock No.	Replaces
1984-96 FRONT, PASSENGER SIDE	12035.34	52000462
1984-96 FRONT, DRIVER SIDE	12035.35	52000463
1984-96 REAR, PASSENGER SIDE	12035.36	52000468
1984-96 REAR, DRIVER SIDE	12035.37	52000469

OUTER DOOR HANDLE

	Stock No.	Replaces
1984-96 FRONT OR REAR DOOR, RH	12035.38	55024926
1984-96 FRONT OR REAR DOOR, LH	12035.39	55024927



12035.38

BUMPER END CAPS

	Stock No.	Replaces
1984-96 FRONT, PASSENGER SIDE	12035.46	52000178
1984-96 FRONT, DRIVER SIDE	12035.47	52000179
1984-96 REAR, PASSENGER SIDE	12035.48	52000192
1984-96 REAR, DRIVER SIDE	12035.49	55022077

XJ CHEROKEE

BUMPERS

	Stock No.	Replaces
1984-96 FRONT BUMPER, BLACK	12035.40	52000185
1984-96 REAR BUMPER, BLACK	12035.41	55026257
1984-96 FRONT BUMPER, CHROME	12035.42	52000177
1984-96 REAR BUMPER, CHROME	12035.43	55234619
1997-01 FRONT BUMPER, BLACK	12035.44	5EE85DX8AB
1997-01 REAR BUMPER, BLACK	12035.45	5EE84SW1AC



12035.50

LIFTGATE SUPPORTS RH=LH

EACH (2 NEEDED)	Stock No.	Replaces
1984-94	12012.03	55027180
1995-96	12012.04	G0004218
1997-01	12012.05	55076208AB

LIFTGATE
SUPPORTS SOLD
SEPARATELYCUP-HOLDER FOR FACTORY
XJ CONSOLE (W/O HARDWARE)

1984-96 XJ CHEROKEE 12035.50 CH-1



ZJ

HEAVY DUTY TOW HOOK PAIR
1983-98 ZJ

Stock No.
NEW 11236.06



11236.06

HOOD:

1993-98 ZJ
1999-04 WJ

Stock No. Replaces
12037.01 55295753
12039.01 55076470AAD

LOCKS & CYLINDERS FOR DOOR & TAILGATE

	Stock No.	Replaces
DOOR CYLINDER & LOCK: 1991-94 ZJ GRAND CHEROKEE	11813.03	4720931
DOOR CYLINDER & LOCK: 1995 ZJ GRAND CHEROKEE	11813.04	4778123
DOOR CYLINDER & LOCK: 1996-98 ZJ GRAND CHEROKEE	11813.05	4864651
DOOR CYLINDER & LOCK: 1999-04 WJ GRAND CHEROKEE, 2004 KJ LIBERTY	11813.06	5013682AA

FENDERS

	Stock No.	Replaces
1993-98 ZJ PASSENGER SIDE	12037.02	55031834
1993-98 ZJ DRIVER SIDE	12037.03	55031835
1999-04 WJ PASSENGER SIDE	12039.02	55135900AC
1999-04 WJ DRIVER SIDE	12039.03	55135901AC



11813.04

HEADER PANEL (GRILLE SUPPORT)

	Stock No.	Replaces
1993-95 ZJ	12037.04	55054886
1996-98 ZJ	12037.05	55054996
1999-03 WJ	12039.04	55155498



12037.10

BUMPERS:

	Stock No.	Replaces
1993-98 ZJ REAR, BLACK	12037.10	4713456
1993-98 ZJ REAR, GRAY	12037.11	55032692

FENDER SUPPORT:

	Stock No.	Replaces
1993-98 ZJ RH	12037.06	55254738

CROSS MEMBERS:

	Stock No.	Replaces
1993-98 ZJ FRONT	12037.08	55255200
1993-98 ZJ LOWER RADIATOR	12037.09	55254739

MIRRORS:

	Stock No.	Replaces
1993-96 ZJ POWER W/O HEATER, RH	12037.16	55154810
1993-96 ZJ POWER W/O HEATER, LH	12037.17	55154811
1993-95 ZJ POWER W/ HEATER, RH	12037.18	4883022
1993-95 ZJ POWER W/ HEATER, LH	12037.19	4883023
1996-98 ZJ POWER W/ HEATER, RH	12037.20	55154802
1996-98 ZJ POWER W/ HEATER, LH	12037.21	55154803
1999-02 WJ POWER W/O HEATER, RH	12039.06	55155446
1999-02 WJ POWER W/O HEATER, LH	12039.07	55155447
1999-02 WJ POWER W/ HEATER, RH	12039.08	55155232
1999-02 WJ POWER W/ HEATER, LH	12039.09	55155233

GRILLES

	Stock No.	Replaces
1993-95 ZJ CHROME-SILVER-GRAY	12037.12	55054890
1993-95 ZJ PAINTED BLACK	12037.13	5DF54MX8
1996-98 ZJ CHROME DARK, ARGENT	12037.14	55055059
1996-98 ZJ DARK, ARGENT	12037.15	5DN46SX8
1999-04 WJ INNER GRILLE SUPPORT	12039.05	5FT350X9

LIFTGATE DOOR SUPPORT SHOCKS

	Stock No.	Replaces
1993-98 ZJ, PASSENGER SIDE	12012.06	55074782
1993-98 ZJ, DRIVER SIDE	12012.07	55074783
1999-04 WJ, FITS EITHER SIDE	12012.08	55137022AB



12012.08

LIFTGATE GLASS SUPPORT SHOCKS

	Stock No.	Replaces
1996-98 ZJ, FITS EITHER SIDE	12012.09	55076210
1999-04 WJ, FITS EITHER SIDE	12012.10	55136965AA

HOOD SUPPORT SHOCKS

	Stock No.	Replaces
1999-03 WJ, FITS EITHER SIDE	12012.11	5513674AA
2004 WJ, FITS EITHER SIDE	12012.12	TBA



12037.22

EXTERIOR DOOR HANDLES

	Stock No.	Replaces
1993-98 ZJ, PASSENGER SIDE (RH) - FRONT	12037.22	55075652
1993-98 ZJ, DRIVER SIDE (LH) - FRONT	12037.23	55075653
1993-98 ZJ, PASSENGER SIDE (RH) - REAR	12037.24	55075654
1993-98 ZJ, DRIVER SIDE (LH) - REAR	12037.25	55075655

WJ



1972-86
CJ Front
Dana 30



ITEM #	Description	Stock No.	Replaces
15	SPINDLE BEARING (BEARING ALONE W/O HARDWARE)	16529.03	8121402
	SPINDLE BEARING-SEAL-WASHER KIT, LEFT OR RIGHT, 1977-86 CJ	16529.04	8127356
	SPINDLE THRUST WASHER 1972-77 CJ WITH FRONT DRUM BRAKE	16529.05	8121398
16	SPINDLE 1972-77 CJ WITH DRUM BRAKE	16529.06	8121403
	SPINDLE 1977-86 CJ WITH DISC BRAKE	16529.07	8128147
17	YOKE, 1972-86 CJ (U-BOLT STYLE)	16580.02	935685
	YOKE, 1981-86 CJ (STRAP & BOLT STYLE)	16580.03	8131656
	U-BOLT PAIR KIT FOR 935685 YOKE	16582.01	A-490K
	U-BOLT PAIR KIT FOR 935685 YOKE-SPICER	16582.02	A-490KS
	STRAP & BOLT KIT FOR 8131656 YOKE	16582.03	3240553K
19	U-JOINT KIT FOR AXLE, LEFT OR RIGHT, GREASABLE	16525.01	8126637
	U-JOINT KIT FOR AXLE, LEFT OR RIGHT, GREASABLE SPICER	16525.02	8126637S-G
	U-JOINT KIT FOR AXLE, LEFT OR RIGHT, NON-GREASABLE SPICER	16525.03	8126637S
20	FRONT OUTER AXLE SHAFT, LEFT OR RIGHT	16523.03	36617
21	FRONT AXLE SHAFT ASSEMBLY 1977-82 DISC BRAKE, DRIVER SIDE	16523.05	8127599
	FRONT AXLE SHAFT ASSEMBLY 1977-82 DISC BRAKE, PASS. SIDE	16523.04	8127598
	FRONT AXLE SHAFT ASSEMBLY, 1982-86 CJ7, CJ8, DRIVER SIDE	16523.07	8134293
	FRONT AXLE SHAFT ASSEMBLY, 1982-86 CJ7, CJ8, PASS. SIDE	16523.06	8134294
22	GASKET, DRIVE FLANGE	16727.02	649784
23	DIFFERENTIAL COVER KIT STAINLESS ST, INCLUDES GASKET & H/W	11118.02	7470
	PERFORMANCE LOCK-RIGHT LOCKER KIT	LR2210	
	ZYTANIUM CROSS SHAFT	LRSD2210	
	POWERTRAX NO-SLIP TRACTION SYSTEM	LR302700	
	WARN PREMIUM LOCKOUT HUB SET, 1972-80 CJ	W9062	
	WARN STANDARD LOCKOUT HUB SET, 1981-86 CJ	W28751	
	SUPERWINCH LOCKOUT HUB SET, 1972-80 CJ	400502	
	SUPERWINCH LOCKOUT HUB SET, 1981-86 CJ	400526	
	WARN FRONT HUB CONVERSION KIT (LOCK OUT HUBS INCLUDED BUT NOT STOCK BEARINGS)	W37132	
	WARN OUTER AXLE SHAFT LH=RH, 1972-86 CJ	W39105	
	WARN INNER AXLE SHAFT, PASSENGER SIDE 1976-83 CJ5, 1976-81 CJ7	W38803	
	WARN INNER AXLE SHAFT, DRIVER SIDE 1976-83 CJ5, 1976-81 CJ7	W38789	
	WARN INNER AXLE SHAFT, PASSENGER SIDE 1982-86 CJ7 & CJ8	W38804	
	WARN INNER AXLE SHAFT, DRIVER SIDE, 1982-86 CJ7 & CJ8	W38805	
	AVM LOCKOUT HUB SET, 1972-80 CJ	15001.02	
	AVM LOCKOUT HUB SET, 1981-86 CJ	15001.26	

TIMKEN

HARD PARTS



SEE PAGE 100 FOR DETROIT
AND ARB PERFORMANCE
LOCKER KITS



ITEM #	DESCRIPTION	Stock No.	Replaces
1	GASKET, FRONT AXLE COVER	16502.01	8120360
2	CASE, STANDARD DIFFERENTIAL:		
	DANA-25	16503.01	A-793
	DANA-27 3.31 TO 3.73 RATIO	16503.02	934934
	DANA-27 3.92 TO 5.38 RATIO	16503.03	926797
3	SPIDER GEAR KIT STANDARD DIFFERENTIAL	16507.01	926544
4	BEARING, DIFFERENTIAL SIDE, DANA -25 (2 NEEDED)	16509.01	3105346
	BEARING, DIFFERENTIAL SIDE, DANA-27 (2 NEEDED)	16706.02	3156052
5	CUP, DIFFERENTIAL SIDE, DANA-25 (2 NEEDED)	16509.03	52881
	CUP, DIFFERENTIAL SIDE, DANA-27 (2 NEEDED)	16509.04	3157273
6	SHIM KIT DIFFERENTIAL SIDE BEARINGS	16511.01	648061
7	RING & PINION:		
	DANA-25 4.27 RATIO, 47X11 TEETH	16513.01	910064
	DANA-25 4.88 RATIO, 39X8 TEETH (LIMITED QNTY)	16513.02	801925
	DANA-25 5.38 RATIO, 43X8 TEETH (LIMITED QNTY)	16513.03	801928
	DANA-27 3.73 RATIO, 41X11 TEETH	16513.04	934894
	DANA-27 4.27 RATIO, 47X11 TEETH	16513.05	TBA
	DANA-27 4.88 RATIO, 39X8 TEETH	16513.06	933901
	DANA-27 5.38 RATIO, 43X8 TEETH	16513.07	936166
8	INNER PINION BEARING & CUP KIT:		
	DANA-25	16515.01	8124051
	DANA-27	16515.02	8126499
9	OUTER PINION BEARING & CUP KIT		
	DANA-25 & DANA-27	16517.01	8124052
10	SHIM KIT PINION BEARING	16519.01	649228
11	PINION NUT	16584.01	801367
12	PINION WASHER	16584.02	636570
13	PINION OIL SEAL	16521.01	998092
13	PINION OIL SEAL-NATIONAL BRAND	16521.02	998092N

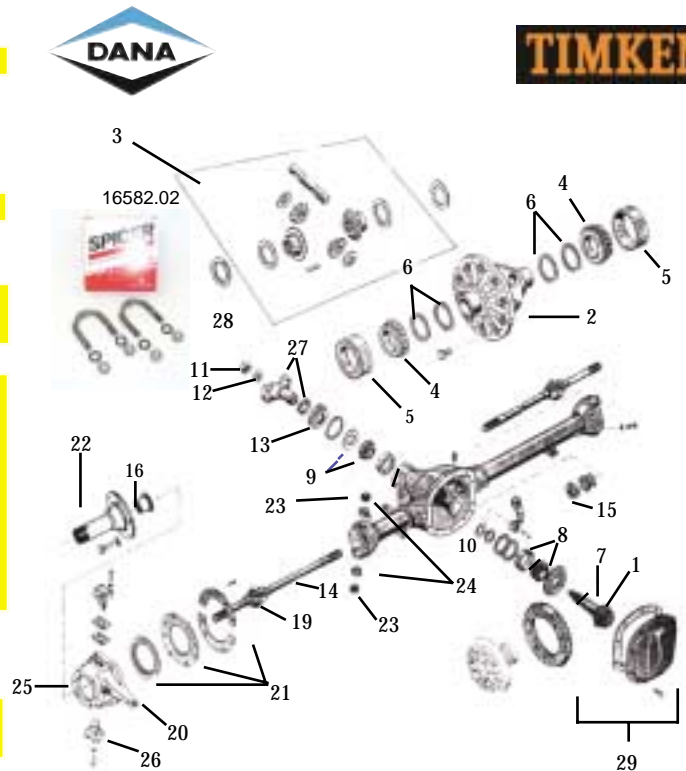

ITEM #	DESCRIPTION	Stock No.	Replaces
14	FRONT AXLE SHAFT ASSEMBLY INNER & OUTER WITH U-JOINT:		
	PASSENGER SIDE (SHORT)	16523.02	909460
	DRIVER SIDE (LONG)	16523.01	909459
15	OIL SEAL, INNER AXLE	16526.01	A-779
16	BUSHING, SPINDLE	16529.02	649783
17	GASKET, AXLE SHAFT FLANGE DRIVE (NOT SHOWN)	16727.02	649784
18	FLANGE, AXLE SHAFT DRIVE, LEFT OR RIGHT (NOT SHOWN)	16750.08	A-868
19	U-JOINT, FRONT AXLE, GREASABLE, LEFT OR RIGHT	16525.01	8126637
	U-JOINT, FRONT AXLE, GREASABLE, LEFT OR RIGHT - SPICER	16525.02	8126637S-G
	U-JOINT, FRONT AXLE, NON-GREASABLE, LEFT OR RIGHT - SPICER	16525.03	8126637S
20	KNUCKLE (LATE CJ2A,3A,3B,CJ5,CJ6)		
	LEFT	18026.01	805783
	RIGHT	18026.02	805784
21	STEERING KNUCKLE SEAL KIT (EACH SIDE)	18026.03	915664
22	SPINDLE WITH BUSHING	16529.01	8120362
23	BEARING, KING PIN (EACH)	18026.05	52940
24	CUP, KING PIN (EACH)	18026.06	52941
25	SHIM SET, KING PIN BEARING (EACH)	18026.07	A-6882
26	CAP, KING PIN	18026.04	910901
27	YOKE:		
	DANA-25 (10 SPLINE)	16580.04	A-1445
	DANA-27 (10 SPLINE)	16580.01	A-1106
28	U-BOLT PAIR KIT FOR U-BOLT STYLE YOKE	16582.01	A-490K
28	U-BOLT PAIR KIT FOR U-BOLT STYLE YOKE-SPICER	16582.02	A-490KS
29	DIFFERENTIAL COVER KIT STAINLESS ST, INCLUDES GASKET & HDW	11118.02	7470
	PERFORMANCE LOCK-RIGHT LOCKER KIT	LR2115	
	WARN PREMIUM LOCKOUT HUB SET (1945-71)	W29062	
	SUPERWINCH LOCKOUT HUB SET (1942-71)	400501	
	AVM LOCKOUT HUB SET	15001.01	

FRONT DANA 44 SJ (WAGONEER) 1974-92:

DESCRIPTION	Stock No.	Replaces
SPINDLE WASHER	16527.35	4004815
SPINDLE INNER NUT	16527.36	4004816
SPINDLE OUTER NUT	16527.37	5352169
UPPER BALL JOINT	18037.01	8122495
LOWER BALL JOINT	18038.01	8122496
WARN PREMIUM LOCKOUT HUB SET	W20990	
SUPERWINCH LOCKOUT HUB SET	16709.04	400518

TBA= TO BE ANNOUNCED

HARD PARTS

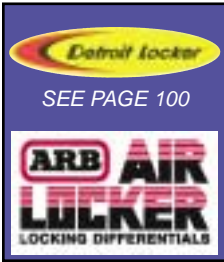
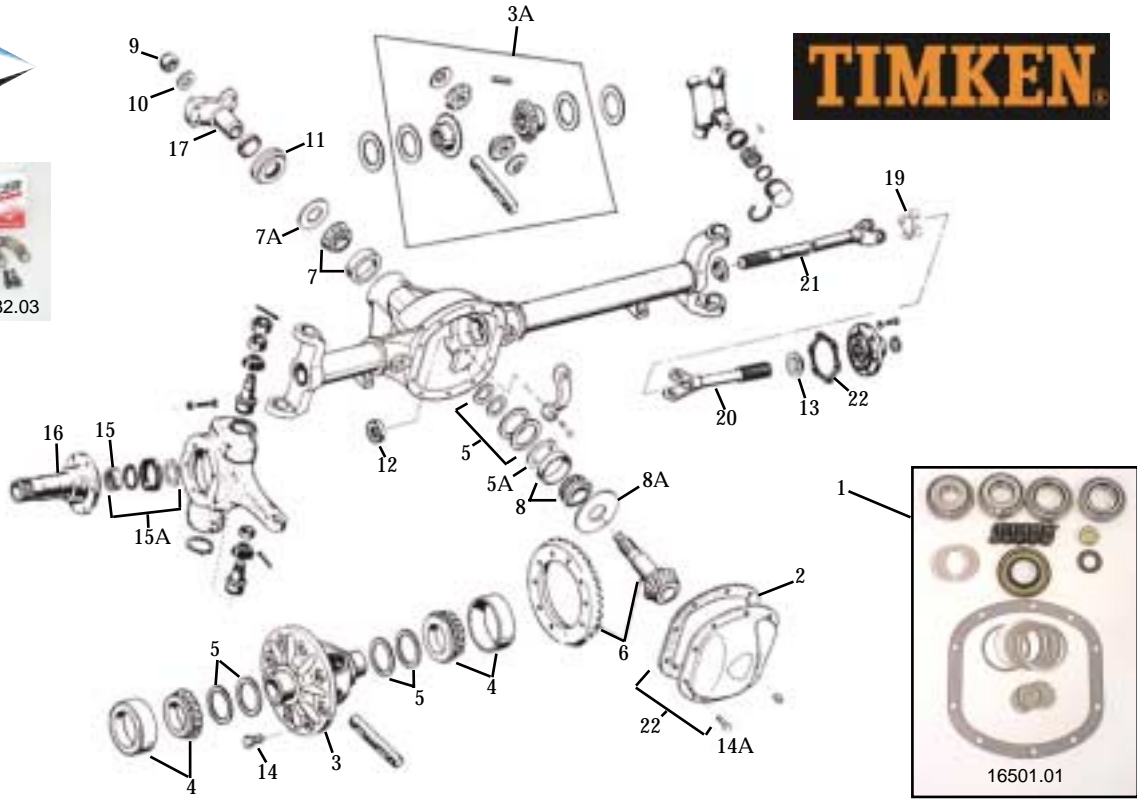

1972-86 CJ Front Dana 30:

ITEM #	DESCRIPTION	Stock No.	Replaces
1	MASTER REBUILD KIT, (BEARINGS, SEAL, SHIM SET & HARDWARE)	16501.01	DRK334MK
2	GASKET, FRONT AXLE COVER	16502.01	8120360
3	CASE, STANDARD DIFFERENTIAL (W GASKET, SHIMS & RING BOLTS) WITH 2.72 TO 3.54 RATIO	16503.04	8126515
	1976-80 4.09 & 4.10 CJ, 1981 3.73 CJ - DIFF. CASE ASSY.	NEW 16503.49	8126495
	FRONT DANA-30		
	WITH 3.73 TO 5.38 RATIO	16503.05	8126496
3A	SPIDER GEAR KIT STANDARD DIFFERENTIAL (WITH GASKET & BOLTS)	16507.02	8126497
4	BEARING KIT DIFFERENTIAL SIDE (2 BEARINGS & 2 CUPS)	16509.05	8126500
5	SHIM SET KIT, FOR SIDE BEARINGS & PINION BEARINGS + H/W	16512.01	8126506
5A	INNER PINION BEARING BAFFLE	16512.51	916372
6	RING & PINION KIT (INCLUDES PINION BEARINGS & CUPS, PINION NUT & WASHER, OIL SEAL & SLINGER, RING BOLTS, SHIM KIT)		
	3.31 RATIO (43X13 TEETH)	16513.10	8132601
	3.54 RATIO (46X13 TEETH)	16513.11	8126518
	3.73 RATIO (41X11 TEETH)	16513.12	945345
	4.10 RATIO (41X10 TEETH)	16513.13	8126494
	4.27 RATIO (47X11 TEETH)	16513.14	8126946
	4.56 RATIO (41X9 TEETH)	16513.15	8134385
	4.88 RATIO (39X8 TEETH)	16513.16	7065036X
7	OUTER PINION BEARING KIT (1 BEARING + 1 CUP)	16517.01	8124052
7A	OUTER PINION OIL SLINGER	16512.52	636566
8	INNER PINION BEARING KIT (1 BEARING + 1 CUP)	16515.02	8126499
8A	INNER PINION OIL SLINGER	16512.53	934937
9	NUT, PINION	16584.01	801367
10	WASHER, PINION	16584.02	636570
11	OIL SEAL, PINION	16521.01	998092
11	OIL SEAL, PINION-NATIONAL BRAND	16521.02	998092N
12	OIL SEAL, INNER SIDE OF THE AXLE	16526.02	8121781
13	DUST SHIELD, INNER AXLE, LEFT OR RIGHT	16527.04	8126232
14	BOLT FOR RING GEAR (EACH, 10 NEEDED)	16522.01	649454
14A	DIFF COVER BOLT, DANA-30, 35, 44, AMC-20	NEW 16522.02	991546



HARD PARTS

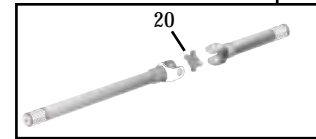
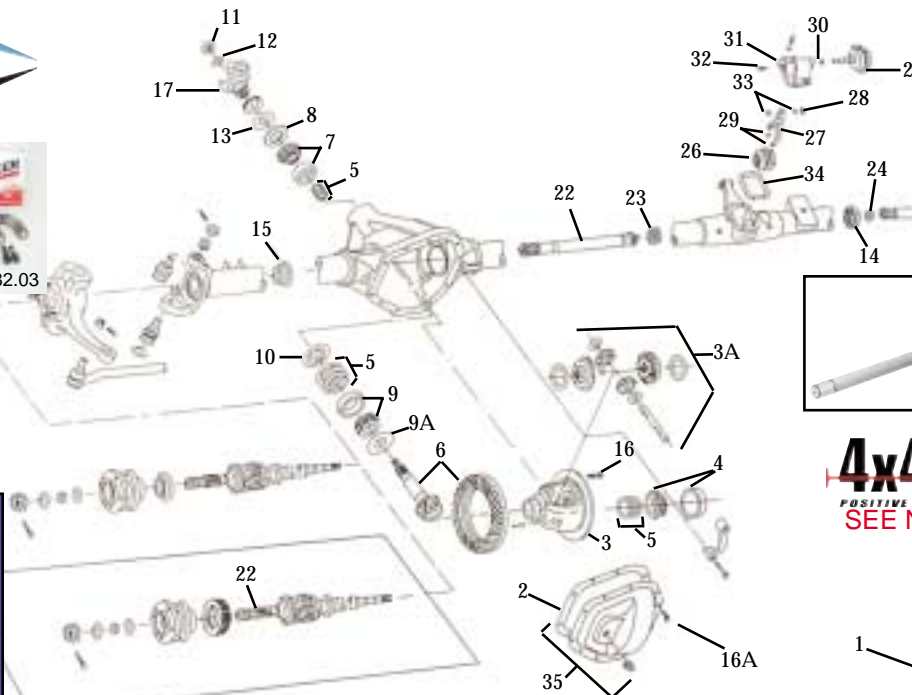
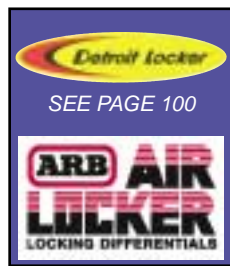

FRONT DANA-30 WITH DISCONNECT:

FITS 1987-95 YJ WRANGLER AND 1984-01 XJ CHEROKEE WITH DISCONNECT .

ITEM #	DESCRIPTION	Stock No.	Replaces
1	REBUILD KIT (BEARINGS, SEAL, SHIMS & HARDWARE)	16501.02	DRK35DSMK
2	GASKET, FRONT AXLE COVER	16502.01	8120360
3	CASE, STANDARD DIFFERENTIAL (W/ GASKET, SHIMS & RING BOLTS) WITH 2.73 TO 3.55 RATIO	16503.04	8126515
	WITH 3.73 TO 4.56 RATIO	16503.05	8126496
3A	SPIDER GEAR KIT STANDARD DIFFERENTIAL (WITH SEAL & BOLTS)	16507.03	83500190
3B	CASE ASSEMBLY KIT:		
	1990-96, STD DIFF, 3.07 - 3.55 RATIO, SPICER (ITEM # 3 + 3A)	16505.01	5252582
	1990-96 STD DIFF, 3.73 - 4.10 RATIO, SPICER (ITEM # 3 + 3A)	16505.02	5252590
	1987-89 STD DIFF, 3.07 - 3.55 RATIO, SPICER (ITEM # 3 + 3A)	16505.03	83500168
	1987-89 STD DIFF, 3.73 - 4.10 RATIO, SPICER (ITEM # 3 + 3A)	16505.04	83500169
4	BEARING KIT DIFFERENTIAL SIDE (2 BEARINGS & 2 CUPS)	16509.05	8126500
5	SHIM SET KIT, FOR SIDE BEARINGS & PINION BEARINGS + H/W	16512.02	83500191K
6	RING & PINION KIT (INCLUDES PINION BEARINGS & CUPS, PINION NUT & WASHER, OIL SEAL & SLINGER, RING BOLTS, SHIM KIT (ALL RING & PINIONS ARE REVERSE ROTATION)		
	3.07 RATIO (43X14 TEETH)	16513.20	83500187
	3.54 RATIO (39X11 TEETH)	16513.21	83505480
	3.73 RATIO (41X11 TEETH)	16513.22	83500189
	4.10 RATIO (41X10 TEETH)	16513.23	83502353
	4.56 RATIO (41X9 TEETH)	16513.24	83503424
	4.88 RATIO (RING & PINION ONLY, NEED SEPARATE REBUILD KIT)	16513.25	D30-488R
7	OUTER PINION BEARING KIT (1 BEARING + 1 CUP)	16517.01	8124052
8	OUTER PINION BEARING OIL SLINGER	16512.52	636566
9	INNER PINION BEARING KIT (1 BEARING + 1 CUP)	16515.02	8126499
9A	INNER PINION OIL SLINGER	16512.51	916372
10	INNER PINION BEARING BAFFLE	16512.53	934937
11	NUT, PINION	16584.01	801367
12	WASHER, PINION	16584.02	636570
13	OIL SEAL, PINION	16521.01	998092
13	OIL SEAL, PINION-NATIONAL BRAND	16521.02	998092N
14	OIL SEAL, INNER SIDE OF THE AXLE, RIGHT	16526.03	83503504
15	OIL SEAL, INNER SIDE OF THE AXLE, LEFT	16526.02	8121781
16	BOLT FOR RING GEAR (EACH, 10 NEEDED)	16522.01	649454
16A	DIFF COVER BOLT, DANA-30, 35, 44, & AMC-20	NEW 16522.02	991546
17	YOKE, U-BOLT STYLE	16580.02	935685
17	YOKE, STRAP & BOLT STYLE	16580.07	2465611

CONTINUED ON NEXT PAGE

HARD PARTS

DANA MODEL 30 WITH DISCONNECT (CONTINUED FROM PREVIOUS PAGE):

FITS 1987-95
YJ WRANGLER
AND XJ
CHEROKEE
WITH
DISCONNECT.
LISTINGS
ARE FOR YJ
WRANGLER
ONLY.

ITEM #	DESCRIPTION	Stock No.	Replaces
18	U-BOLT PAIR KIT FOR U-BOLT STYLE YOKE	16582.01	A-490K
18	U-BOLT PAIR KIT FOR U-BOLT STYLE YOKE, SPICER BRAND	16582.02	A-490KS
19	STRAP & BOLT KIT FOR STRAP & BOLT STYLE YOKE	16582.03	3240553K
20	1987-94 U-JOINT KIT, GREASABLE, LEFT OR RIGHT	16525.01	8126637
20	1987-94 U-JOINT KIT, GREASABLE, LEFT OR RIGHT, SPICER BRAND	16525.02	8126637S-G
20	1987-94 U-JOINT KIT, NON-GREASABLE, LEFT OR RIGHT, SPICER BRAND	16525.03	8126637S
20	1995 U-JOINT KIT, GREASABLE, LEFT OR RIGHT	16525.04	8126638
20	1995 U-JOINT KIT, NON-GREASABLE, LEFT OR RIGHT, SPICER BRAND	16525.05	8126638S
20	1995-UP U-JOINT KIT, GREASABLE, LEFT OR RIGHT, SPICER BRAND	16525.06	8126638S-G
21	AXLE SHAFT ASSEMBLY OUTER PASSENGER SIDE, 1987-95 W/O ABS	16523.08	5252145
21	AXLE SHAFT ASSEMBLY, OUTER PASSENGER SIDE, 1990-95 W/ABS	16523.10	4741033
21	AXLE SHAFT ASSEMBLY, DRIVER SIDE, 1987-95 W/O ABS	16523.09	83506205
21	AXLE SHAFT ASSEMBLY, DRIVER SIDE, 1990-95 W/ABS	16523.11	4713189
22	AXLE SHAFT, INNER PASSENGER SIDE (ALL MODELS)	16523.12	5252594
22	OUTER AXLE SHAFT, 1987-94 (W/O ABS), FITS LEFT OR RIGHT	16523.13	83500184
23	1987-89 INNER BUSHING BEARING	16527.05	TBA
23	1990-95 INNER BUSHING BEARING (W/O ABS)	16527.06	5252686
24	1987-89 OUTER BEARING	16527.07	8134213
24	1990-95 OUTER BEARING	16527.08	5252687
25	1987-90 AXLE DISCONNECT MOTOR ASSEMBLY	16527.09	TBA
25	1991-95 AXLE DISCONNECT MOTOR ASSEMBLY	16527.10	4506116
26	1987-95 AXLE DISCONNECT SHIFT FORK COLLAR	16527.11	TBA
27	1987-95 AXLE DISCONNECT SHIFT FORK	16527.12	5252599
28	1987-95 AXLE DISCONNECT MOTOR RETAINING CLIP	16527.13	8133619
29	1987-95 AXLE DISCONNECT SHIFT FORK INSERT	16527.14	8133708
30	1987-95 AXLE DISCONNECT SERVO RING	16527.15	TBA
31	1991-95 AXLE DISCONNECT HOUSING COVER	16527.16	TBA
32	1991-95 AXLE DISCONNECT SWITCH ASSEMBLY	16527.17	TBA
33	1987-95 AXLE DISCONNECT SHIFT FORK SNAP RING	16527.18	8133618
34	1987-95 AXLE DISCONNECT HOUSING COVER GASKET	16527.19	4137732
35	DIFFERENTIAL COVER KIT STAINLESS ST, INCLUDES GASKET & BOLTS	11118.01	7471
	PERFORMANCE LOCK-RIGHT LOCKER KIT	LR2210	
	ZYTANIUM CROSS SHAFT	LRSD2210	
	POWERTRAX NO-SLIP TRACTION SYSTEM	LR302700	
	WARN INNER AXLE SHAFT, DRIVER SIDE	W38821	
	WARN INNER AXLE SHAFT, PASSENGER SIDE	W38875	
	1987-95 YJ WRANGLER POSI-LOK VACUUM ACTUATOR ELIMINATOR KIT	PSL900	
	1987-95 DANA-30, FOR YJ & XJ WITH 3" TO 6" LIFT (POSI-LOK)	PSL920	
	YJ, XJ POSI LOCK CAST IRON SHIFT FORK, FRONT D30 W/ DISCONNECT	PSL100	



16582.01



11118.01

NEW

NEW

NEW

NEW

NEW



HARD PARTS



PSL900

16525.06



PSL100



16582.03



SEE PAGE 100 FOR DETROIT AND ARB PERFORMANCE LOCKER KITS



TBA= TO BE ANNOUNCED

FITS 1997-06 TJ WRANGLER & 1993-98 ZJ GRAND CHEROKEE.

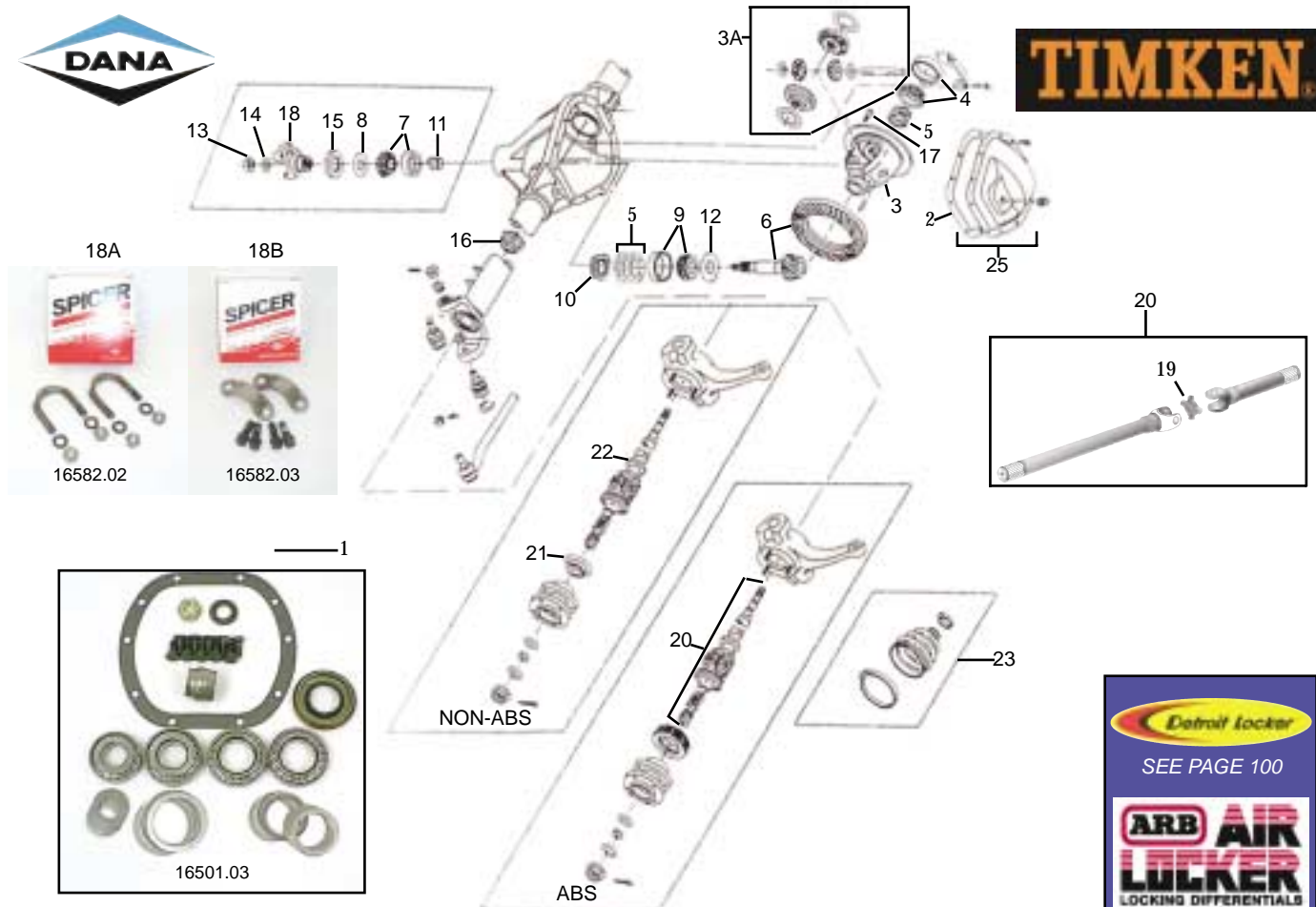

FRONT DANA-30 WITHOUT DISCONNECT:

ITEM #	DESCRIPTION	Stock No.	Replaces
1	REBUILD KIT (BEARINGS, SEAL, SHIMS & HARDWARE)	16501.03	DRK334TJMK
2	GASKET, FRONT AXLE COVER	16502.01	8120360
3	CASE, STANDARD DIFFERENTIAL (W/ GASKET, SHIMS & RING BOLTS)		
	WITH 2.73 TO 3.55 RATIO	16503.04	8126515
	WITH 3.73 TO 4.56 RATIO	16503.05	8126496
3A	SPIDER GEAR KIT STANDARD DIFFERENTIAL (WITH SEAL & BOLTS)	16507.04	5252591
4	BEARING KIT DIFFERENTIAL SIDE (2 BEARINGS & 2 CUPS)	16509.05	8126500
5	SHIM SET KIT, FOR SIDE BEARINGS & PINION BEARINGS + H/W	16512.03	706377X
6	RING & PINION KIT (INCLUDES PINION BEARINGS & CUPS, PINION NUT & WASHER, OIL SEAL & SLINGER, RING BOLTS, & SHIM KIT)		
	3.07 RATIO (43X14 TEETH)	16513.30	4864853
	3.55 RATIO (39X11 TEETH)	16513.31	4864906
	3.73 RATIO (41X11 TEETH)	16513.32	4864843
	4.10 RATIO (41X10 TEETH)	16513.33	4864913
	4.56 RATIO (41X9 TEETH) (RING & PINION ONLY, NEED REBUILD KIT)	16513.34	7065035X-T
	4.88 RATIO (RING & PINION ONLY, NEED REBUILD KIT)	16513.35	D30-488TJ
	3.07 RATIO 1993-96 ZJ GRAND CHEROKEE	16513.36	TBA
	3.31 RATIO 1993-96 ZJ GRAND CHEROKEE	16513.37	TBA
	3.55 RATIO 1993-96 ZJ GRAND CHEROKEE	16513.38	7073004X
	3.73 RATIO 1993-96 ZJ GRAND CHEROKEE	16513.39	4741015
7	OUTER PINION BEARING KIT (1 BEARING + 1 CUP)	16517.02	5252508
8	OUTER PINION BEARING OIL SLINGER	16512.52	636566
9	INNER PINION BEARING KIT (1 BEARING + 1 CUP)	16515.02	83500191K
10	INNER PINION BEARING BAFFLE	16512.53	934937
11	COLLAPSIBLE PINION SPACER	16512.54	4864845

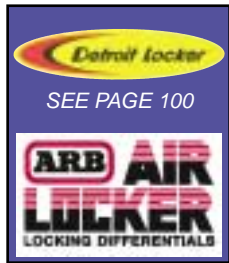

HARD PARTS

FITS 1997-01 TJ WRANGLER, 1994-99 XJ CHEROKEE & 1993-98 ZJ GRAND CHEROKEE.

CONTINUED FROM PREVIOUS PAGE

FRONT DANA-30 WITHOUT DISCONNECT:

ITEM #	DESCRIPTION	Stock No.	Replaces
12	INNER PINION OIL SLINGER	16512.51	916372
13	NUT, PINION	16584.01	801367
14	WASHER, PINION	16584.02	636570
15	OIL SEAL, PINION	16521.01	998092
	OIL SEAL, PINION-NATIONAL BRAND	16521.02	998092N
16	OIL SEAL, INNER SIDE OF THE AXLE, LH=RH	16526.02	8121781
17	BOLT FOR RING GEAR (EACH, 10 NEEDED)	16522.01	649454
18	YOKE, U-BOLT STYLE	16580.02	935685
	YOKE, STRAP & BOLT STYLE	16580.07	2465611
18A	U-BOLT PAIR KIT FOR U-BOLT STYLE YOKE	16582.01	A-490K
	U-BOLT PAIR KIT FOR U-BOLT STYLE YOKE, SPICER BRAND	16582.02	A-490KS
18B	STRAP & BOLT KIT FOR STRAP & BOLT STYLE YOKE	16582.03	3240553K
19	U-JOINT KIT, GREASABLE, LEFT OR RIGHT	16525.04	8126638
	U-JOINT KIT, NON-GREASABLE, LEFT OR RIGHT, SPICER BRAND	16525.05	8126638S
	U-JOINT KIT, GREASABLE, LEFT OR RIGHT, SPICER BRAND	16525.06	8126638S-G
20	AXLE SHAFT ASSEMBLY PASSENGER SIDE, W/O ABS	16523.16	5252584
	AXLE SHAFT ASSEMBLY, PASSENGER SIDE, W/ ABS	16523.18	4874306
	AXLE SHAFT ASSEMBLY DRIVER SIDE, W/O ABS	16523.09	83506205
	AXLE SHAFT ASSEMBLY, DRIVER SIDE, W/ ABS	16523.11	4713189
	AXLE SHAFT ASSEMBLY, FRONT, PASSENGER SIDE	16523.20	4720380
	AXLE SHAFT ASSEMBLY, FRONT, DRIVER SIDE	16523.21	4720381
	1993-98 ZJ FRONT AXLE CV JOINT (OUTER SHAFT ONLY) (BOOT + CLAMP + GREASE)	NEW 16523.22	8081-SK
21	OUTER AXLE DUST SHIELD	16527.21	46988
22	INNER AXLE DUST SHIELD	16527.22	4797769
23	BOOT KIT, XJ CHEROKEE CV STYLE AXLE	16527.30	4796233
24	DIFFERENTIAL COVER KIT STAINLESS ST, INCLUDES GASKET & BOLTS	11118.02	7470
	PERFORMANCE LOCK-RIGHT LOCKER KIT	LR2210	
	ZYTANIUM CROSS SHAFT	LRSD2210	
	POWERTRAX NO-SLIP TRACTION SYSTEM	LR302700	
	WARN INNER AXLE SHAFT DRIVER SIDE	W38821	
	WARN INNER AXLE SHAFT PASSENGER SIDE	W38875	



16523.22



11118.02

HARD PARTS



SEE PAGE 100 FOR DETROIT AND ARB PERFORMANCE LOCKER KITS



FOR 1999-04 WJ GRAND-CHEROKEE

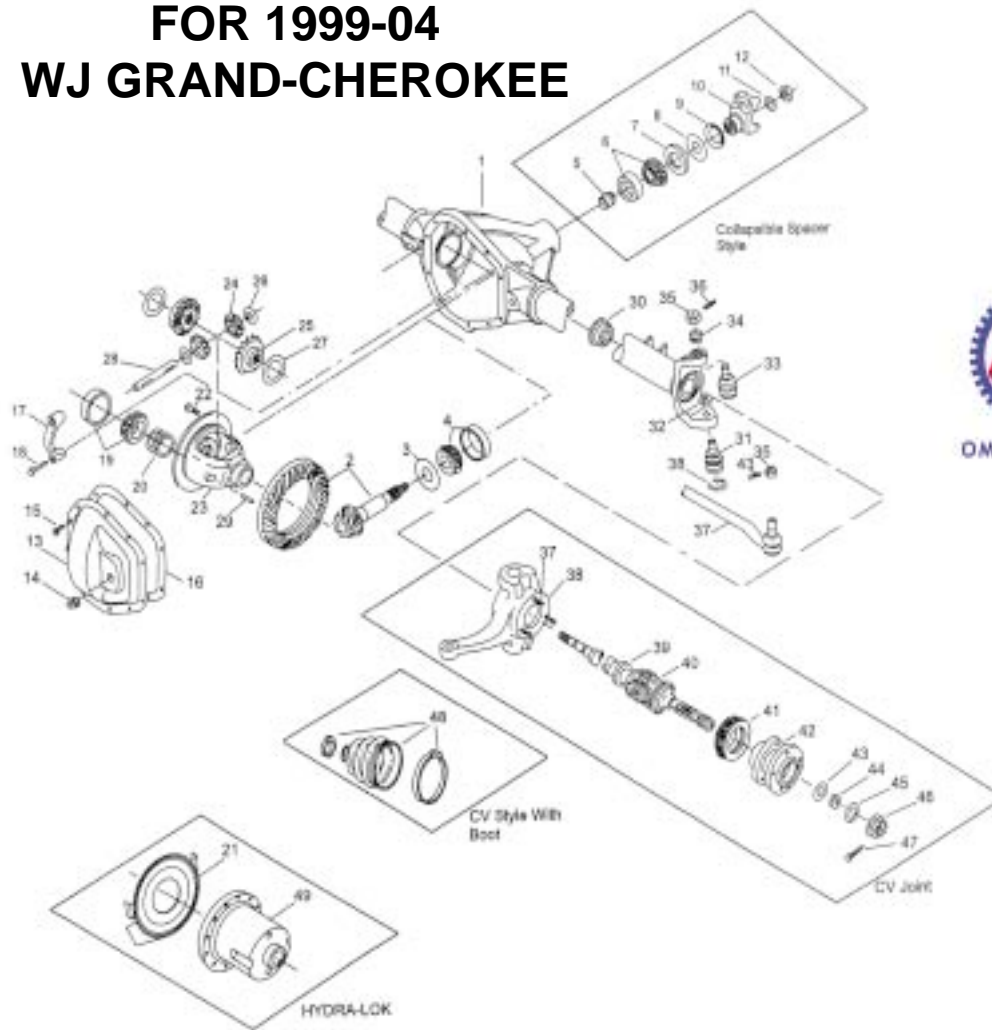

MODEL SUPER 30 / 186:

ITEM #	DESCRIPTION	Stock No.	Replaces
2	RING & PINION KIT 3.55 RATIO	16513.45	5012476AA
	3.73 RATIO	16513.46	5012447AB
	3.91 RATIO (R&P ONLY)	16513.47	5014402AA
4	INNER PINION BEARING KIT	16515.02	8126499
5	COLLAPSIBLE SPACER	16512.54	4864845
6	OUTER PINION BEARING KIT	16517.02	5252508
7	SLINGER	16512.52	636566
8	SEAL PINION INNER	16521.03	5012454AA
9	SEAL PINION OUTER	16521.04	5012453AA
10	YOKE	16580.08	5012444AA
11	PINION WASHER	16584.02	636570
12	PINION NUT	16584.01	801367
19	DIFFERENTIAL BEARING KIT	16509.05	8126500
20	SHIM KIT	16511.02	5012450AA
40	AXLE SHAFT (W/O HYDRA-LOK) RH	16523.30	5012504AA
	AXLE SHAFT (W/O HYDRA-LOK) LH	16523.31	5012505AA
	FRONT AXLE ASSEMBLY, WJ GRAND CHEROKEE, W/O VARIABLE LOCK, RH	16523.32	5012456AA
	FRONT AXLE ASSEMBLY, WJ GRAND CHEROKEE, W/O VARIABLE LOCK, LH	16523.33	5012457AA
	FRONT AXLE ASSEMBLY, WJ GRAND CHEROKEE, W/ VARIABLE LOCK, RH	16523.34	5012748AA
	FRONT AXLE ASSEMBLY, WJ GRAND CHEROKEE, W/ VARIABLE LOCK, LH	16523.35	5012749AA
A	SPIDER GEAR SET	16507.04	5252591
B	CASE ASSY KIT, STD 3.55 RATIO	16505.07	5012477AA
	CASE ASSY KIT, STD 3.73 RATIO	16505.08	7071591X
	CASE ASSY KIT, HYDRA-LOK	16505.09	76739X

HARD PARTS

FITS 1941-47 MB & EARLY CJ-2A (FULL FLOATING TYPE)

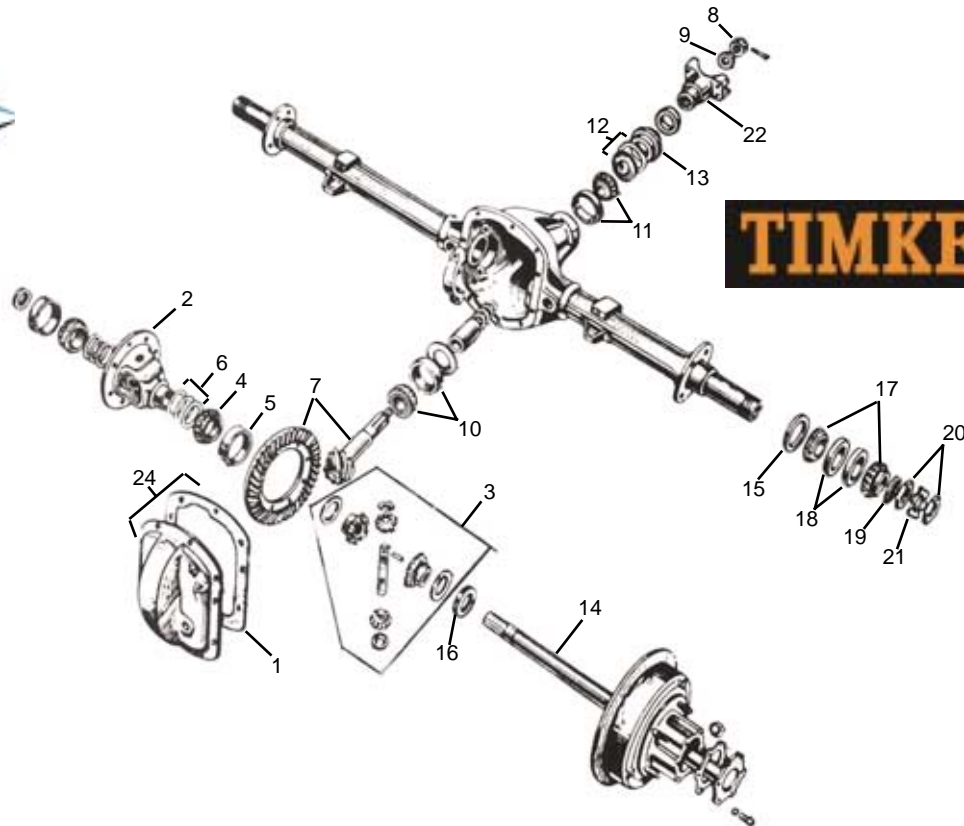

REAR DANA-27:

ITEM #	DESCRIPTION	Stock No.	Replaces
1	GASKET, AXLE COVER	16502.01	8120360
2	CASE, STANDARD DIFFERENTIAL	16503.01	A-793
3	SPIDER GEAR KIT STANDARD DIFFERENTIAL	16507.01	926544
4	BEARING, DIFFERENTIAL SIDE	16509.01	3105346
5	CUP, DIFFERENTIAL SIDE	16509.03	52881
6	SHIM KIT DIFFERENTIAL SIDE BEARINGS	16511.01	648061
7	RING & PINION 4.88 RATIO 39X8	16513.02	801925
8	PINION NUT	16584.05	TBA
9	PINION WASHER	16584.02	636570
10	INNER PINION BEARING & CUP KIT	16515.01	8124051
11	OUTER PINION BEARING & CUP KIT	16517.01	8124052
12	SHIM KIT PINION BEARING	16519.01	649228
13	PINION OIL SEAL	16521.01	998092
14	AXLE SHAFT PASSENGER SIDE (SHORT)	16530.02	A-901
	AXLE SHAFT DRIVER SIDE (LONG)	16530.01	A-902
15	OIL SEAL, REAR OUTER WHEEL	16708.01	805150
16	OIL SEAL, REAR INNER	16526.01	A-779
17	BEARING, AXLE SHAFT	16706.01	52942
18	CUP, AXLE SHAFT	16707.01	52943
19	LOCK WASHER, WHEEL BEARING	16710.02	A-865
20	NUT, WHEEL BEARING (EACH)	16710.03	A-866
21	LOCK WASHER, WHEEL BEARING NUT	16710.04	A-867
22	YOKE	16580.04	A-1445
23	U-BOLT KIT PAIR FOR YOKE	16582.01	A-490K
23	U-BOLT KIT PAIR FOR YOKE, SPICER BRAND	16582.02	A-490KS
24	DIFFERENTIAL COVER KIT STAINLESS ST, INCLUDES GASKET & H/W	11118.02	7470
	PERFORMANCE LOCK-RIGHT LOCKER KIT	LR2416	



11118.02



LR2416

HARD PARTS

TBA= TO BE ANNOUNCED

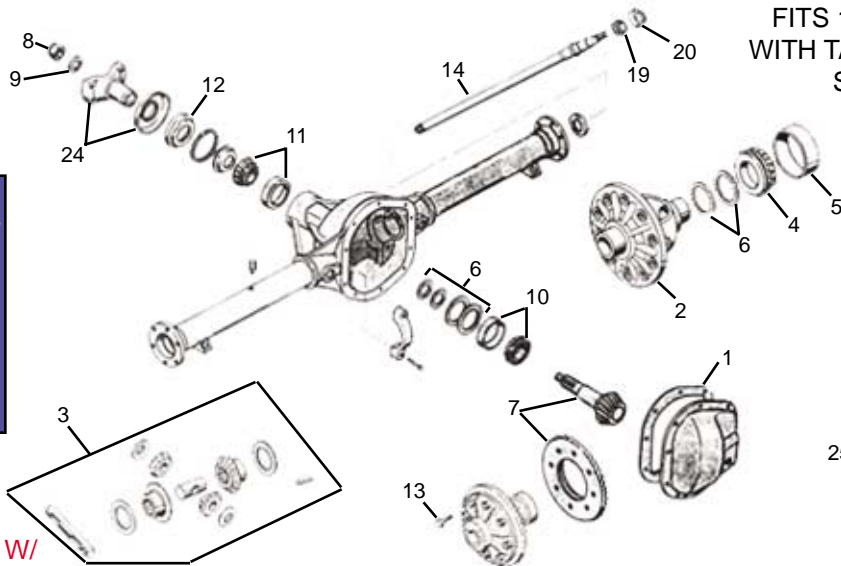
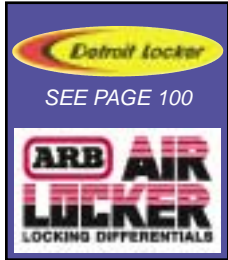

FITS 1948-69 CJ'S WITH TAPERED AXLE SHAFTS

REAR DANA-44 W/ TAPERED AXLE SHAFTS:

ITEM#	DESCRIPTION	Stock No.	Replaces
1	GASKET, AXLE COVER	16502.02	8122409
2	CASE, STANDARD DIFFERENTIAL 3.92 TO 5.38 RATIO	16503.20	802562
3	SPIDER GEAR KIT STANDARD DIFFERENTIAL 10 SPLINE	16507.15	802260
3	SPIDER GEAR KIT STANDARD DIFFERENTIAL 19 SPLINE	16507.16	916361
4	BEARING, DIFFERENTIAL SIDE (2 NEEDED)	16509.20	52979
5	CUP, DIFFERENTIAL SIDE (2 NEEDED)	16509.21	52980
6	SHIM KIT, DIFFERENTIAL SIDE & PINION BEARING	16512.20	8125924
7	RING & PINION:		
	5.38 RATIO,43X8 TEETH 10 SPLINE	16513.60	802568
	4.27 RATIO,47X11 TEETH 10 SPLINE	16513.61	910073
	3.73 RATIO,41X11 TEETH 26 SPLINE	16513.62	935650
8	PINION NUT	16584.01	801367
9	PINION WASHER	16584.02	636570
10	INNER PINION BEARING & CUP KIT	16515.01	8124051
11	OUTER PINION BEARING & CUP KIT	16517.01	8124052
12	PINION OIL SEAL	16521.01	998092
13	BOLT FOR RING GEAR	16522.01	649454
14	AXLE SHAFT PASSENGER SIDE,10 SPLINE	16530.04	640969
	AXLE SHAFT PASSENGER SIDE,19 SPLINE	16530.06	912626
	AXLE SHAFT DRIVER SIDE,10 SPLINE	16530.03	640968
	AXLE SHAFT DRIVER SIDE,19 SPLINE	16530.05	912625
15	AXLE SHAFT NUT	16533.01	636344
16	AXLE HUB KEY	16533.02	636374
17	OIL SEAL, REAR OUTER AXLE	16534.01	914802
18	OIL SEAL, REAR INNER AXLE	16535.01	640959
19	BEARING, AXLE SHAFT	16536.01	52799
20	CUP, AXLE SHAFT	16536.02	52800
21	SHIM KIT REAR AXLE RETAINER	16533.03	805524
22	REAR AXLE HUB	16537.01	811351
23	WHEEL STUD, RIGHT THREAD, EACH	16714.03	5353025
24	YOKE 10 SPLINE	16580.04	A-1445
	YOKE 26 SPLINE	16580.02	935685
25	U-BOLT KIT FOR YOKE (PAIR)	16582.01	A-490K
	U-BOLT KIT FOR YOKE (PAIR), SPICER BRAND	16582.02	A-490KS
26	DIFFERENTIAL COVER KIT STAINLESS ST, INCLUDES GASKET & HDW	11118.03	7472
	1945-62 PERFORMANCE LOCK-RIGHT LOCKER KIT, 10 SPLINE	LR2415	
	1955-69 PERFORMANCE LOCK-RIGHT LOCKER KIT, 19 SPLINE	LR2413	



HARD PARTS

REAR DANA-44 WITH FLANGED AXLES

FITS 1970-75 CJ, 1986 CJ7
W/ DANA-44, 1997-03 TJ
WRANGLER W/ DANA-44
(ALSO XJ & ZJ 1994 & UP)

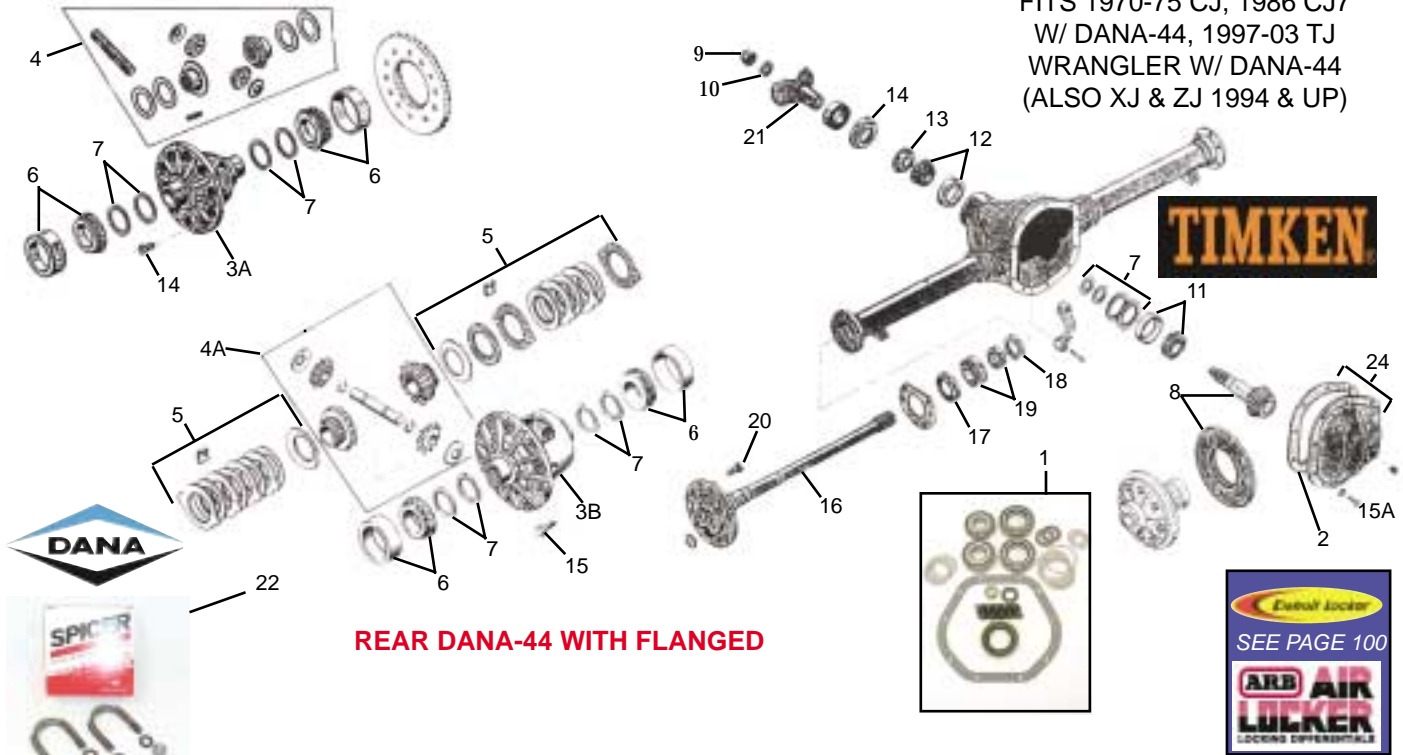

REAR DANA-44 WITH FLANGED

ITEM #	DESCRIPTION	Stock No.	Replaces
1	REBUILD KIT (BEARINGS, SEAL, SHIMS & HARDWARE)	16501.04	DRK339BMK
2	GASKET, AXLE COVER (ALL)	16502.02	8122409
3A	CASE, STANDARD DIFFERENTIAL (WITH GASKET & BOLTS) 2.87 TO 3.73 RATIO, CJ ONLY 3.92 TO 5.38 RATIO, CJ ONLY	16503.25 16503.26	8124039 8124078
3B	CASE, TRAC LOCK DIFFERENTIAL (WITH GASKET & BOLTS) 2.87 TO 3.73 RATIO, CJ ONLY 3.92 TO 5.38 RATIO, CJ ONLY 3.07, 3.53, 3.73 & 4.10 RATIO, TJ ONLY	16503.27 16503.28 16503.27	8124424 8124414 8124424
4	SPIDER GEAR KIT STANDARD DIFF., CJ ONLY	16507.17	8124045
4A	SPIDER GEAR KIT TRAC-LOC (WITH DISC KIT), CJ ONLY SPIDER GEAR KIT TRAC-LOC (WITH DISC KIT), TJ ONLY	16507.18 16507.19	8124045 8124415
5	TRAC LOC DISC KIT (ALL)	16508.01	83505432
6	BEARING & CUP KIT, DIFFERENTIAL SIDE (2 BEARINGS + 2 CUPS) (ALL)	16509.22	994345
7	SHIM KIT, DIFFERENTIAL SIDE & PINION BEARING (ALL)	16512.20	8124071
8	RING & PINION: 3.31 RATIO (INCLUDES BEARINGS, SHIMS, SEALS & HARDWARE) 3.54 RATIO, 46X13 TEETH (INCLUDES BEARINGS, SHIMS & HW), CJ ONLY 3.55 RATIO, 39X11 TEETH (INCLUDES BEARINGS, SHIMS & HW), TJ ONLY 3.73 RATIO, 41X11 TEETH (INCLUDES NUT, WASHER & BOLTS), ALL CJ & TJ 4.09 RATIO, 45X11 TEETH (WITH BEARINGS, SHIMS, SEALS & H/W), CJ ONLY 4.10 RATIO, 41X10 TEETH (INCLUDES NUTS AND BOLTS ONLY), TJ ONLY 4.27 RATIO, 47X11 TEETH (NUT, WASHER & BOLTS), CJ ONLY 4.55 RATIO, 50X11 TEETH (W/ BEARINGS, SHIMS, SEAL & H/W), CJ ONLY 4.89 RATIO, 44X9 TEETH (NUT, WASHER & BOLTS), CJ ONLY 5.38 RATIO, 43X8 TEETH (NUT, WASHER & BOLTS), CJ ONLY	16513.65 16513.66 16513.67 16513.62 16513.68 16513.69 16513.70 16513.71 16513.72 16513.73	8134219 7060173X 4882841 735650 8124076 4882844 935652 70601721X 936137 224045X
9	PINION NUT (ALL)	16584.01	801367
10	PINION WASHER (ALL)	16584.02	636570
11	INNER PINION BEARING & CUP KIT (ALL)	16515.01	8124051
12	OUTER PINION BEARING & CUP KIT (ALL)	16517.01	8124052
13	OUTER PINION BEARING SLINGER (ALL)	16512.52	636566
14	PINION OIL SEAL, CJ ONLY PINION OIL SEAL, CJ ONLY-NATIONAL BRAND PINION OIL SEAL, TJ ONLY	16521.01 16521.02 16521.08	998092 998092N 4746772
15	BOLT RING GEAR (ALL)	16522.01	649454
15A	DIFF COVER BOLT, DANA-30, 35, 44, AMC-20	16522.02	991546

HARD PARTS

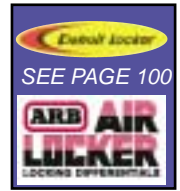

NEW

continued from previous page

FITS 1970-75 CJ, 1986 CJ7 W/ DANA-44,
1997-03 TJ WRANGLER W/ DANA-44
(ALSO XJ & ZJ 1994 & UP)

Rear Dana-44 with Flanged Axles:

ITEM #	DESCRIPTION	Stock No.	
16	AXLE SHAFT, LEFT OR RIGHT, 1972-75 CJ ONLY	16530.07	994252
	(W/ BEARING, RETAINERS, OIL SEALS, STUDS) LH OR RH, 1972-75 CJ ONLY	16530.08	8124778
	AXLE SHAFT, DRIVER SIDE, 1997-99 TJ, NON ABS	16530.09	4882351
	AXLE SHAFT, PASSENGER SIDE, 1997-99 TJ, NON ABS	16530.10	4882350
	1994 & UP ZJ GRAND-CHEROKEE, PASSENGER SIDE	16530.12	4856332
	1994 & UP ZJ GRAND-CHEROKEE, DRIVER SIDE	16530.11	4856333
	AXLE SHAFT PASSENGER SIDE, 1999-UP WJ GRAND CHEROKEE	16530.14	5012872AA
	AXLE SHAFT DRIVER SIDE, 1999-UP WJ GRAND-CHEROKEE	16530.13	5012873AA
17	OIL SEAL, REAR OUTER AXLE (ALL)	16534.02	994261
18	OIL SEAL, REAR INNER AXLE, 1970-75 CJ ONLY	16535.02	994258
19	BEARING & CUP WITH RETAINER, AXLE SHAFT (ALL)	16536.05	994262K
20	WHEEL STUD, RIGHT THREAD, EACH, CJ ONLY	16714.06	5355719
	WHEEL STUD, RIGHT THREAD, EACH, TJ W/ DRUM BRAKES ONLY	16714.08	83503053
	WHEEL STUD, RIGHT THREAD, EACH, TJ W/ DISC BRAKES ONLY	16714.09	4762841
21	YOKE 26 SPLINE (U-BOLT STYLE), CJ ONLY	16580.02	935685
	YOKE 26 SPLINE (STRAP & BOLT DESIGN), 1997 TJ ONLY	16580.07	2465611
	YOKE 26 SPLINE (STRAP & BOLT DESIGN), 1998-UP TJ ONLY	16580.15	2481411
22	U-BOLT KIT (PAIR) FOR 935685, CJ ONLY	16582.01	A-490K
	U-BOLT KIT (PAIR) FOR 935685, CJ ONLY, SPICER BRAND	16582.02	A-490KS
23	STRAP & BOLT KIT, FOR TJ	16582.03	3240553K
24	DIFFERENTIAL COVER KIT STAINLESS ST, INCLUDES GASKET & H/W	11118.03	7472
	PERFORMANCE LOCK-RIGHT LOCKER KIT	LR2410	
	ZYTANIUM CROSS SHAFT	LRSD2410	
	POWERTRAX NO-SLIP TRACTION SYSTEM, OPEN CARRIER (ALL)	LR443000	
	POWERTRAX NO-SLIP TRACTION SYSTEM, TRAC-LOC CARRIER (ALL)	LR443020	
	WARN FULL FLOATING AXLE CONVERSION PAIR KIT, 1972-75 CJ	W36315	
	WARN FULL FLOATING AXLE CONVERSION PAIR KIT, 1997-00	W38257	



RING & PINION, FOR TJ RUBICON W / DANA-44 (FRONT OR REAR), 4.89 RATIO	16513.75	RP489-D44RUB
CARRIER SHIMS FOR ABOVE RING & PINION	16519.08	708143



SEE PAGE 100 FOR DETROIT AND ARB
PERFORMANCE LOCKER KITS



HARD PARTS

1976-86 CJ

TIMKEN

ONE-PIECE AXLE KITS FEATURING TIMKEN SET-9 BEARINGS. ONE KIT REQUIRED PER VEHICLE. KIT INCLUDES LEFT AND RIGHT PAIR. KIT INCLUDES: 1 LEFT AXLE, 1 RIGHT AXLE, 2 TIMKEN SET-9 BEARINGS, 2 BEARING RETAINERS, 2 SPACERS, 2 INNER OIL SEALS, 2 OUTER OIL SEALS, 10 STUDS, SILCON SEALANT AND DETAILED INSTRUCTIONS.

5 YEAR LIMITED WARRANTY
TO ORIGINAL CONSUMER ON 16530.20,
16530.21 & 16530.22 AMC ONE-PIECE AXLE
KITS WITH TIMKEN BRAND BEARINGS.

AMC MODEL-20 ONE-PIECE AXLE CONVERSION KITS:

DESCRIPTION	Stock No.	Replaces
NARROW-TRACK 1976-83 CJ5, 1976-81 CJ7, 1981 CJ8 (W/O QUADRATRAC)	16530.20	7071K
WIDE-TRACK 1982-86 CJ7, 1982-86 CJ8	16530.21	8586K
QUADRATRAC 1976-79 CJ7, W/FACTORY T-400 AUTOMATIC TRANNY	16530.22	7981K
SPARE BEARINGS & HARDWARE KIT (BOTH SIDES)	16536.06	1-PIECE-K
SPARE BEARINGS & HARDWARE KIT (ONE SIDE)	16536.07	1-PIECE-K/2
SPARE BEARING (EACH)	16536.08	U298
SPARE BEARING RETAINER (EACH)	16536.09	H1012
SPARE SPACER (EACH)	16536.10	H1011
SPARE INNER OIL SEAL (EACH)	16535.03	3170700
SPARE OUTER OIL SEAL (EACH)	16534.03	4485691



REAR AMC-20 1-PIECE AXLE KIT

ONE-PIECE KITS ARE ALSO AVAILABLE WITH GREEN BRAND BEARINGS. PLEASE USE
16530.41, 16530.42, 16530.43 FOR KITS WITH GREEN BEARINGS



REAR AMC-20 STOCK 2-PIECE AXLE KIT

**REAR AMC-20
REPLACEMENT
2-PIECE AXLE
KITS, HUBS &
COMPONENTS:**

2-PIECE STOCK REPLACEMENT AXLE SHAFT KITS (KITS ARE PER SIDE). EACH KIT INCLUDES: 1 AXLE SHAFT, 1 HUB, 1 BEARING, 1 CUP, 1 INNER OIL SEAL, 1 OUTER OIL SEAL & NUT-WASHER-KEY KIT.

DESCRIPTION	Stock No	Replaces
1976-83 CJ 5, 1976-81 CJ7 & CJ8 (W/O QUADRATRAC), 26.25", DS SHAFT	16530.25	8127070
1976-83 CJ 5, 1976-81 CJ7 & CJ8 (W/O QUADRATRAC), 26.25", DS KIT	16530.27	8127070K
1976-83 CJ 5, 1976-81 CJ7 & CJ8 (W/O QUADRATRAC), 29.25", PS SHAFT	16530.26	8127071
1976-83 CJ 5, 1976-81 CJ7 & CJ8 (W/O QUADRATRAC), 29.25", PS KIT	16530.28	8127071K
1982-86 CJ7 & CJ8, 28.5", DS SHAFT	16530.29	8133885
1982-86 CJ7 & CJ8, 28.5", DS KIT	16530.31	8133885K
1982-86 CJ7 & CJ8, 31.5", PS SHAFT	16530.30	8133886
1982-86 CJ7 & CJ8, 31.5", PS KIT	16530.32	8133886K
1976-79 CJ7 WITH QUADRA-TRAC, 33.5", DS SHAFT	16530.33	8127079
1976-79 CJ7 WITH QUADRA-TRAC, 33.5", DS KIT	16530.35	8127079K
1976-79 CJ7 WITH QUADRA-TRAC, 22", PS SHAFT	16530.34	8127081
1976-79 CJ7 WITH QUADRA-TRAC, 22", PS KIT	16530.36	8127081K
1976-86 HUB WITH STUDS (FOR ALL ABOVE MODELS)	16537.02	8133730
1976-86 HUB KIT (WITH BEARING, CUP, 2 OIL SEALS, NUT-WASHER-KEY)	16537.03	8133730K
1976-86 AXLE SHAFT BEARING & CUP (ONE OF EACH)	16536.15	8134015
1976-86 INNER AXLE OIL SEAL (EACH)	16535.03	3170700
1976-86 OUTER AXLE OIL SEAL (EACH)	16534.03	4485691
1976-86 AXLE NUT-WASHER-KEY KIT (EACH SIDE)	16533.04	3155675K
1976-86 REAR AXLE SHIM, 0.0003"	16533.05	3141319
1976-86 REAR AXLE SHIM, 0.010"	16533.06	3141320
1976-86 REAR AXLE SHIM KIT (1 0.003" & 1 0.010")	16533.07	3141319K
1976-86 OUTER AXLE DUST SHIELD (EACH SIDE)	16533.08	3184573
1976-80 METAL DUST CAP	16533.09	5362283
1981-86 DUST CAP, PLASTIC	16533.10	5362142

MORE AMC-20 AXLE COMPONENTS ON THE NEXT PAGE

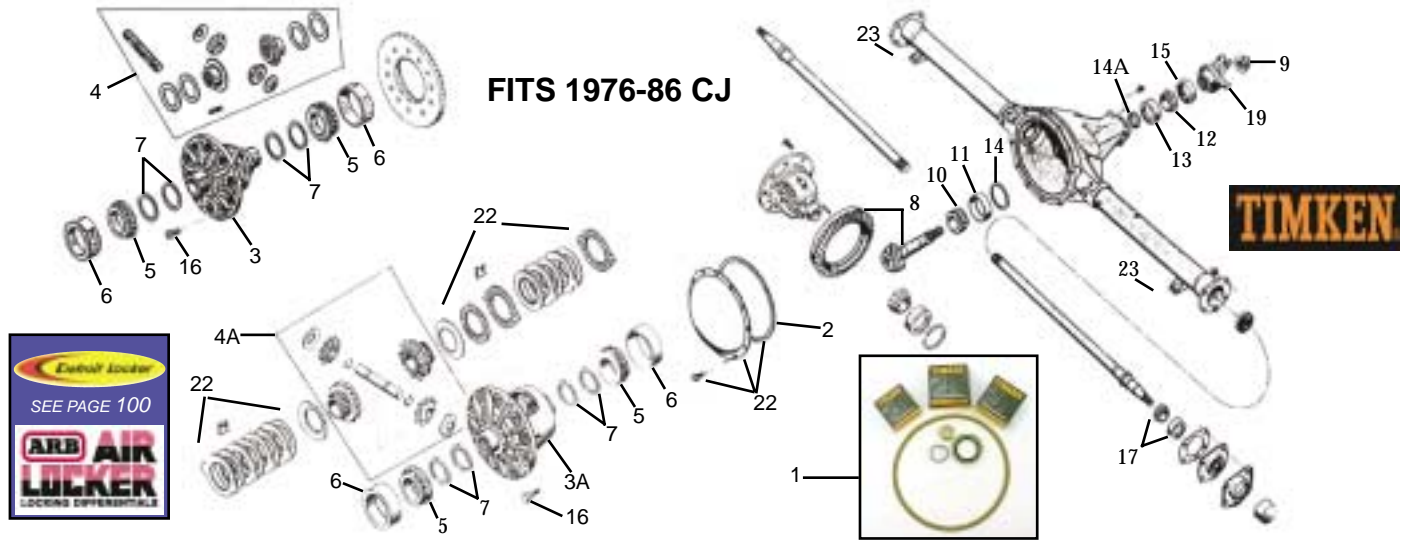

REAR AMC-20:

ITEM #	DESCRIPTION	Stock No.	Replaces
1	AMC-20 REBUILD KIT (BEARINGS, SEALS, HDW (SHIMS NOT INCLUDED))	16501.05	DRK311J
2	GASKET, AXLE COVER	16502.03	3172122
3	CASE, STANDARD DIFF (2.73 RATIO)	16503.30	3226978
	CASE, STANDARD DIFF (ALL EXCEPT 2.73 RATIO)	NEW 16503.31	3212051
3A	CASE, TRAC-LOC DIFF (2.73 RATIO)	16503.32	3212192
	CASE, TRAC-LOC DIFF (ALL EXCEPT 2.73 RATIO)	16503.33	8120280
4	SPIDER GEAR KIT STANDARD DIFFERENTIAL	16507.22	8127092
4A	SPIDER GEAR KIT TRAC-LOC DIFF	NEW 16507.23	8120326
5	BEARING, DIFFERENTIAL SIDE (2 NEEDED)	16509.25	3172565
6	CUP, DIFFERENTIAL SIDE (2 NEEDED)	16509.26	3172566
7	SHIM KIT DIFFERENTIAL SIDE	16511.04	TBA
8	RING & PINION (RING PINION ONLY)		
	2.73 RATIO 41X15 TEETH	16513.80	8132699
	3.31 RATIO 43X13 TEETH	16513.81	8132700
	3.54 RATIO 39X11 TEETH	16513.82	4486825
	3.73 RATIO 41X11 TEETH	16513.83	8133179
	4.10 RATIO 41X10 TEETH	16513.84	8127072
	4.56 RATIO 41X9 TEETH	16513.85	8134410
	4.88 RATIO	16513.86	AMC-488
9	PINION NUT	16584.03	3182601
10	INNER PINION BEARING	16515.20	3172563
11	INNER PINION CUP	16515.21	3172564
12	OUTER PINION BEARING	16517.20	3172135
13	OUTER PINION CUP	16517.21	3172134
14	PINION BEARING SHIM SET	16519.20	3205533K
14A	SPACER, COLLAPSIBLE PINION	16512.60	3185971
15	PINION OIL SEAL W/ PINION NUT	16521.07	3208474
16	BOLT RING GEAR (EACH)	16522.09	TBA
17	BEARING & CUP WITH RETAINER, AXLE SHAFT	16536.15	8134015
18	WHEEL STUD, RIGHT THREAD, EACH	16714.06	5355719
19	YOKE, U-BOLT DESIGN	16580.05	243741
	YOKE-STRAP & BOLT DESIGN	16580.16	8129201
20	U-BOLT KIT (PAIR) FOR O.E YOKE	16582.01	A-490K
21	U-BOLT KIT (PAIR) FOR O.E YOKE, SPICER BRAND	16582.02	A-490KS
	STRAP & BOLT KIT FOR 16580.16	16582.03	3240553K
22	DIFFERENTIAL COVER KIT STAINLESS ST, INCLUDES GASKET & HW	11118.04	7474
	DIFF COVER BOLT, DANA-30, 35, 44, AMC-20	NEW 16522.02	991546
	PERFORMANCE LOCK-RIGHT LOCKER KIT	LR1710	
	ZYTANIUM CROSS SHAFT	LRSA1710	
	POWERTRAX NO-SLIP TRACTION SYSTEM, OPEN CARRIER MODELS	LR202900	
	POWERTRAX NO-SLIP TRACTION SYSTEM, TRAC-LOC CARRIER MODELS	LR202920	
	WARN FULL FLOATING AXLE PAIR KIT, 1976-83 CJ5, 1976-81 CJ7	W37111	
	WARN FULL FLOATING AXLE PAIR KIT, 1982-86 CJ7 & CJ8	W36333	
23	AXLE HOUSING SPRING PAD SET (PAIR)	16527.40	MG-6280
24	DISC KIT FOR TRAC-LOC IN AMC-20	16508.05	8120325

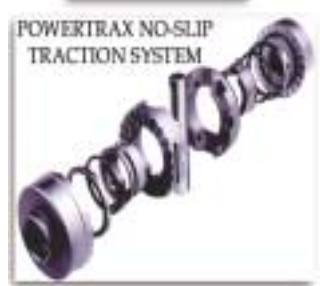

HARD PARTS

TBA= TO BE ANNOUNCED

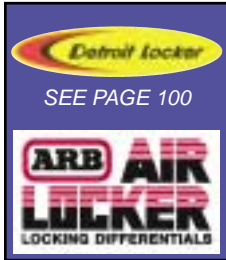

FITS 1987-03 WRANGLER, 1984-01 XJ CHEROKEE & 1993-98 JJ GRAND CHEROKEE, 1999-UP WJ LISTINGS ARE FOR WRANGLER ONLY.

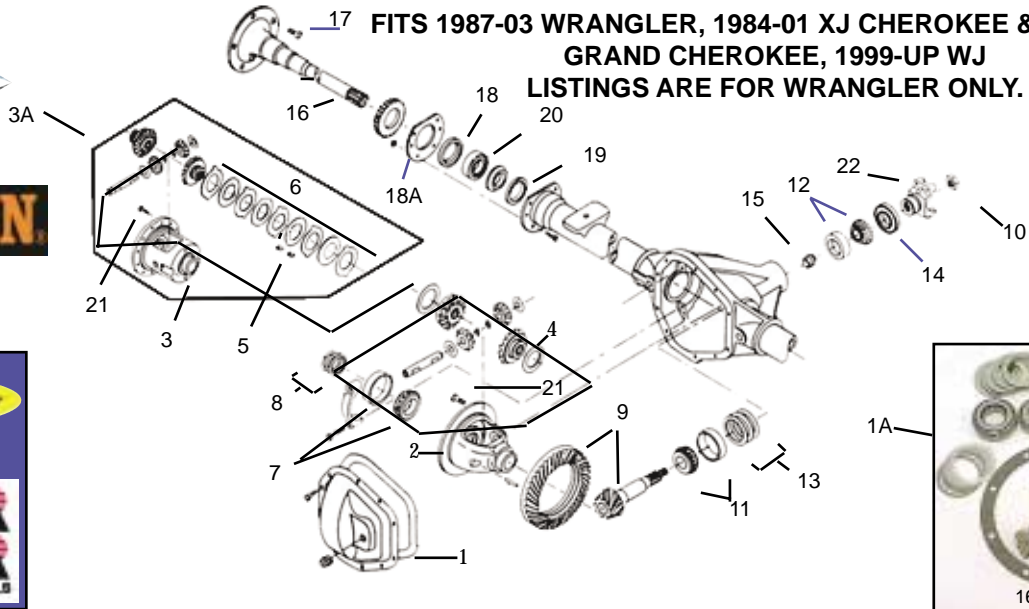

REAR DANA-35:

ITEM #	DESCRIPTION	Stock No	Replaces
1A	REBUILD KIT (BEARINGS, SEAL, SHIMS & HARDWARE)	16501.06	DRK335JMK
1	GASKET, SILICON TUBE	19201.01	8993317
	GASKET, EXACT CUT	16502.04	3229429
2	CASE, STANDARD DIFFERENTIAL		
	1987-93, 2.73 TO 3.31 RATIO, (NOT FOR 1993 YJ BOM 605528) 43219	16503.40	83502880
	1994-00, 2.73 TO 3.31 RATIO (ALSO 1993 YJ W/ 605528 BOM)	16503.41	44649
	1987-89, 3.55 TO 4.56 RATIO (SPICER #41993)	16503.42	83503001
	1990-93, 3.55 TO 4.56 RATIO (NOT FOR 1993 YJ W/ BOM 605528)	16503.43	43218
	1994-00, 3.55 TO 4.56 RATIO (ALSO 1993 YJ W/ 605528 BOM)	16503.44	44590
2A	CASE ASSY KIT, STANDARD DIFF., 3.31-4.56 RATIO, 1987-93 YJ, XJ,...	16505.20	74209X
	CASE ASSY KIT, STANDARD DIFF., FOR SOME 1992-94 XJ, SPICER	16505.21	5252494
	CASE ASSY KIT, STANDARD DIFF., 2.73 - 3.07 RATIO 1986-93, SPICER	16505.22	5252510
	CASE ASSY KIT, STANDARD DIFF., 3.07 RATIO 1994/06 YJ	16505.23	75053X
	CASE ASSY KIT, STANDARD DIFF., 3.55-4.56 RATIO 1994/06 YJ,XJ,ZJ	16505.24	75054X
	CASE ASSY KIT, STANDARD 3.55 OR 3.73 RATIO WJ GRAND CHEROKEE	16505.25	5012808AA
3	1987-00 CASE ONLY,TRAC LOK, 3.55-4.56 (WILL NOT FIT 1992-93 YJ)	16503.48	5252496C
3A	1987-00 CASE ASSY WITH GEAR KIT, TRAC-LOC 2.73-3.31	16505.29	74215X
	1987-00 CASE ASSY WITH GEAR KIT, TRAC-LOC 3.55-4.56	16505.30	5252496
	CASE ASSY KIT, TRACLOK, WJ GRAND CHEROKEE	16505.31	5012831AA
4	1987-93 SPIDER GEAR KIT STANDARD DIFF (NOT FOR 1993 YJ 605528)	16507.30	83503002
	1994-00 SPIDER GEAR KIT STANDARD DIFF (ALSO 1993 YJ 605528 BOM)	16507.31	4740670
5	1987-00 SPIDER GEAR KIT WITH DISC KIT TRAC LOK DIFFERENTIAL	16507.32	5252497
6	1987-89 TRAC-LOC DISC KIT	16508.10	83500263
	1990-00 TRAC-LOC DISC KIT	16508.11	5252506
7	BEARING & CUP KIT, DIFFERENTIAL CASE (2 BEARINGS & 2 CUPS)	16509.05	8126500
8	SHIM KIT DIFFERENTIAL SIDE	16511.10	83503004
9	RING & PINION KIT: KIT INCLUDES BEARINGS, CUPS, SHIMS, SEALS & H/W		
	3.07 RATIO 43X14 TEETH	16514.01	83505472K
	3.55 RATIO 39X11 TEETH 1987-93 YJ	16514.02	83504376K
	3.55 RATIO 39X11 TEETH 1994 & 06 YJ, TJ, XJ, ZJ	16514.03	7072447K
	3.73 RATIO 1994 & 06 YJ, TJ, XJ, ZJ	16514.04	4761678
	4.11 RATIO 37X9 TEETH	16514.05	83504938K
	4.56 RATIO 441X9 TEETH	16514.06	7072445K
	4.88 RATIO (RING & PINION ONLY) (NEED REBUILD KIT FOR FULL SET)	16514.07	D35-488
	3.55 RATIO WJ GRAND CHEROKEE (RING & PINION ONLY)	16514.08	5012828AA
	3.73 RATIO WJ GRAND CHEROKEE (RING & PINION ONLY)	16514.09	5012807AA
10	PINION NUT	16584.03	3182601
11	INNER PINION BEARING & CUP KIT	16515.15	5252507
12	OUTER PINION BEARING & CUP KIT	16517.02	5252508
13	PINION BEARING SHIM SET	16519.10	83503003
14	PINION OIL SEAL	16521.10	83504946
15	COLLAPSIBLE PINION SPACER	16512.59	3175779

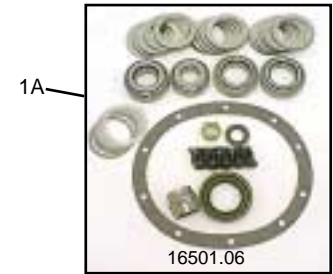

HARD PARTS

CONTINUED ON NEXT PAGE

**FITS 1987-01 WRANGLER, 1984-01 XJ CHEROKEE & 1993-98 ZJ GRAND CHEROKEE.
LISTINGS ARE FOR WRANGLER ONLY.**

CONTINUED
FROM
PREVIOUS
PAGE

REAR DANA-35

ITEM #	DESCRIPTION	Stock No.	Replaces
16	AXLE SHAFTS:		
	1987-89 YJ (ALSO 1984-89 XJ) PASSENGER SIDE WITH BEARING & SEAL	16530.50	83502882
	1987-89 YJ (ALSO 1984-89 XJ) DRIVER SIDE, WITH BEARING & SEAL	16530.51	83502883
	1990-00 (ALL) PASSENGER SIDE W/O ABS (C-CLIP STYLE)	16530.52	5252956
	1990-00 (ALL) DRIVER SIDE W/O ABS (C-CLIP STYLE)	16530.53	5252957
	1990-91 YJ & XJ, PASSENGER SIDE W/ ABS	16530.54	5252948
	1990-91 YJ & XJ, DRIVER SIDE W/ ABS	16530.55	5252949
	1992-00 YJ, TJ, XJ, ZJ (W/ BRAKE DRUM), PASSENGER SIDE W/ ABS	16530.56	4713192
	1992-00 YJ, TJ, XJ, ZJ (W/ BRAKE DRUM), DRIVER SIDE W/ ABS	16530.57	4713193
	1994-98 ZJ (W/ REAR DISC BRAKE), PASSENGER SIDE W/ ABS	16530.58	4762194
	1994-98 ZJ (W/ REAR DISC BRAKE), DRIVER SIDE W/ ABS	16530.59	4762195
	1999-UP WJ GRAND CHEROKEE, RH	16530.60	5012820AA
	1999-UP WJ GRAND CHEROKEE, LH	16530.61	5012821AA
	1991-00 C CLIP	16533.20	5252505
17	WHEEL STUD (WITH DRUM BRAKES)	16714.08	83503053
	WHEEL STUD (WITH DISC BRAKES)	16714.09	4762841
18	AXLE OIL SEAL, OUTER 1987-89 YJ (ALSO 1984-86 XJ)	16534.10	53000477
	AXLE OIL SEAL, OUTER 1990-00 ALL (EACH)	16534.11	5252499
18A	RETAINER, 1984-89 XJ & YJ	16536.20	83503022
19	AXLE OIL SEAL, INNER, 1987-89 YJ (ALSO 1984-89 XJ)	16535.10	83503010
20	WHEEL BEARING:		
	1987-89 YJ (ALSO 1984-89 XJ), BEARING, CUP & RETAINER (EACH SIDE)	16536.21	83501451
	1990-00 ALL, BEARING (EACH SIDE)	16536.22	8134036
21	BOLT RING GEAR (EACH)	16522.01	649454
	DIFF COVER BOLT, DANA-30, 35, 44, AMC-20	NEW 16522.02	991546
22	1987-93 YJ, 1996-97 YJ & TJ YOKE, STRAP & BOLT DESIGN	16580.20	83503318
	1994-96 YJ & TJ YOKE (USE WITH 3-5/8" U-JOINTS)	16580.21	4746835
	1997-00 TJ YOKE (USE WITH 3-7/32" U-JOINTS)	16580.22	2479911
	U-BOLT DESIGN PINION YOKE YOKE KIT 1987-93 YJ, 1997-02TJ	16580.23	D35-YOKE-K1
	1999-UP WJ GRAND CHEROKEE YOKE	16580.24	4797552
23	STRAP & BOLT KIT	16582.03	3240553K
	1991-2004 DANA-35, CROSS SHAFT LOCKING BOLT	NEW 16507.33	5252502
24	DIFFERENTIAL COVER KIT STAINLESS ST, INCLUDES GASKET & H/W	11118.05	7473
	PERFORMANCE LOCK-RIGHT LOCKER KIT (WITH ZYTANIUM SHAFT):		
	1987-93 (WILL NOT FIT 1993 YJ W/ 605528 BOM)	LR2310S	
	1994-01 (ALSO FOR 1993 YJ WITH 605528 BOM)	LR2311S	
	POWERTRAX NON-SLIP TRACTION SYSTEM:		
	1987-89 YJ OPEN CARRIER	LR352700	
	1990-93 YJ OPEN CARRIER	LR352705	
	1994-01 YJ & TJ OPEN CARRIER	LR352706	
	1991-01 YJ & TJ TRAC-LOC	LR352725	
	1987-89 WARN FULL FLOATING AXLE KIT	W38004	
	1990-00 WARN FULL FLOATING AXLE KIT	W38005	



11118.05



W38005



16530.50



SEE PAGE 100 FOR DETROIT
AND ARB PERFORMANCE
LOCKER KITS

HARD PARTS

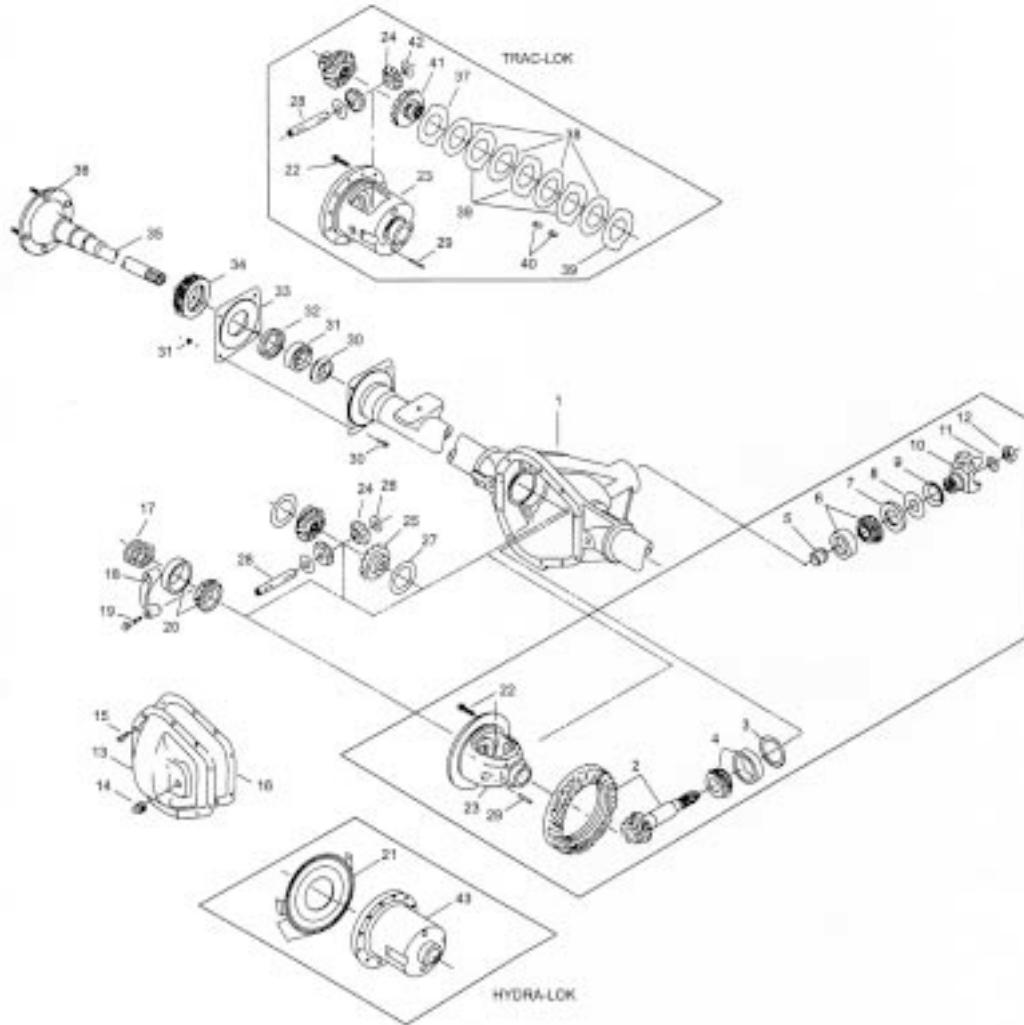

ITEM #	DESCRIPTION	ZJ 1996-98		WJ 1999-UP	
		Stock No.	Replaces	Stock No.	Replaces
2	RING & PINION KIT				
	3.55 RATIO	16514.20	4856362	-----	
	3.73 RATIO	16514.21	4856346	16514.25	5012841AA
	3.91 RATIO (R&P ONLY)	-----		16514.26	5014357AA
4	INNER PINION BEARING KIT	16515.26	4746979	16515.26	4746979
5	COLLAPSIBLE SPACER	16512.62	4626721	16512.62	4626721
6	OUTER PINION BEARING SET	16517.30	4626725	16517.30	4626725
8	PINION OIL SEAL INNER	16521.30	4384188	16521.31	5012846AA
9	PINION SEAL OUTER	-----		16521.32	4764213
20	DIFFERENTIAL BEARING KIT	16525.30	4764213	16525.30	5072894AA
30	REAR AXLE SHAFT RETAINER	-----		16534.21	5072894AA
31	BEARING, REAR AXLE SHAFT	16536.31	5012825AA	16534.31	
32	OIL SEAL, REAR AXLE SHAFT	16534.20	5252499	16534.21	5072894AA
35	AXLE SHAFT, RH (W/O HYDRA-LOK)	16530.12	4856332	16530.72	5012850AA
	AXLE SHAFT, LH (W/O HYDRA-LOK)	16530.11	4856333	16530.73	5012851AA
	AXLE SHAFT, RH (W/ HYDRA-LOK)	-----		16530.14	5012872AA
	AXLE SHAFT, LH (W/ HYDRA-LOK)	-----		16530.13	5012873AA
A	CASE ASSY KIT, STD DIFFERENTIAL	16505.35	4856357	16505.35	4856357
	CASE ASSY KIT, TRAC-LOK	16505.36	4856355	16505.36	4856355
B	CASE STD DIFFERENTIAL	16505.37		TBA	16505.37
	CASE TRAC-LOK DIFFERENTIAL	16505.38		TBA	16505.38
	CASE HYDRA-LOK DIFFERENTIAL	-----		16505.39	5012869AA
C	SPIDER GEAR SET, STANDARD DIFFERENTIAL	16507.40	4856366	16507.40	4856366
	SPIDER GEAR SET, TRAC-LOK	16507.41	4856372	16507.41	4856372
D	TRAC-LOK DISK KIT	16508.20	707018X	16508.20	707018X

HARD PARTS

ULTRA AXLE SHAFTS FOR GM, FORD & DODGE

These axle shafts are made with the highest quality materials and with the latest technology to ensure superior fit, performance and appearance. These axle shafts are manufactured from 4140 Chromemoly Alloy Steel, forgings Normalized for Uniform Grain Flow, CNC machined and Induction Hardened on a medium frequency hardening machine. Splines are Rolled (versus Hobbing) to add durability for the differential side. Smooth bright surface finish enhances its look and prevents rust. And continued to be offered at our customary low prices:

Stock No.

ULT-26013882	10 BOLT 7.5" GM, 28 SPLINE, 29": 4WD 1988-98 S-SERIES BLAZER & JIMMY, CHEVY S10, GMC S15, SONOMA, 1994-96 OLDS. BRAVADO, LH=RH
ULT-14071750	12 BOLT 8.875", GM TRUCK, 30 SPLINE, 4WD 1970-81, LH=RH
ULT-14071751	12 BOLT 8.875" GM, 30 SPLINE, 31-5/16" 2WD 1971-81 BLAZER & SUBURBAN, LH=RH
ULT-3969285	12 BOLT 8.875" 1968-72 CHEVELLE, 1968-72 EL CAMINO, 1970-72 CAMARO, LH=RH
ULT-3969349	12 BOLT 8.875" 1965-67 CHEVELLE, 1968-72 CHEVELLE II, 1967-69 CAMARO, LH=RH
ULT-14039547	10 BOLT 8.5" GM, 28 SPLINE, 31-5/16": 4WD 1982-88 JIMMY/BLAZER, 1981-88 CHEV P/U 10 SERIES, LH=RH 4WD 1981-87 GMC 1500 SERIRS, 1981-88 SUBUBAN 10 SERIES, LH=RH
ULT-26010414	10 BOLT 8.5" GM, 30 SPLINE, 31-5/16" 4WD 1988-91 JIMMY/BLAZER, 1988-91 SUBURBAN 1500 SERIES, 6 HOLE (STUDS), LH=RH,
ULT-14042690	10 BOLT 8.5" GM, 28 SPLINE, 33-5/16" 2WD '75-88 CHEVY VAN 10 & GMC VAN 1500 SERIES '79-88 CHEVY VAN 20 & GMC VAN 2500 SERIES, LH=RH
ULT-26013313	10 BOLT 8.5" GM, 30 SPLINE, 33-5/8" 2WD 1988-95 CHEVY VAN 10 & 20 SERIES, 2WD 1988-95 GMC VAN 1500 & 2500, LH=RH
ULT-E7TZ4234A	10 BOLT 8.8" FORD, 31 SPLINE, 31-1/16" 1987-96 F150/BRONCO, 1987-97 E150, RH, 2WD/4WD
ULT-E7TZ4234B	10 BOLT 8.8" FORD, 31 SPLINE, 33-3/16" 1987-96 F150/BRONCO, 1987-97 E150, LH 2WD/4WD
ULT-E3TZ4234B	10 BOLT 7.5" FORD, 28 SPLINE, 26-1/4" 1983-92 RANGER, RH 2WD/4WD
ULT-E3TZ4234C	10 BOLT 7.5" FORD, 28 SPLINE, 29-1/8" 1983-92 RANGER, LH 2WD/4WD, ALSO FITS 1983-92 BRONCO II, LH
ULT-E3TZ4234D	10 BOLT 8.8" FORD, 31 SPLINE, 31-1/16" 1983-86 BRONCO, 1983 F100, 1983-86 F150, RH, 2WD/4WD
ULT-E3TZ4234E	10 BOLT 8.8" FORD, 31 SPLINE, 33-3/16" 1983-86 BRONCO, 1983 F100, 1983-86 F150, LH, 2WD/4WD
ULT-4137429	12 BOLT 9.25" CHRYSLER/DODGE, 31 SPLINE, 31-5/8" LONG, 4/3/1984-1993 TRUCK 100/150, 4/3/1984-93 RAMCHARGER, 2W/4WD, RH=LH
ULT-D6TZ4234A	9" FORD, 1974-86 F-150 & E-150 LH=RH

LOCKING HUBS

Chevrolet/GMC/Geo

Model	Year	Spline/Bolt Count	Hub #	AVM Hub #	Caution Notes
Blazer/Jimmy/Suburban	1969-91	19 - Internal	400518	15001.18	A
1/2 Ton Pickup	1969-87	19 - Internal	400518	15001.18	A
3/4 Ton Pickup	1960-76	19 - 6	400517		A
3/4 Ton Pickup	1977-87	19 - Internal	400518		A
1 Ton Pickup	1976-91	30 - Internal	400439		A
Geo Tracker	All	26-6	400538	15001.38	--



In 1988 all Chevrolet pickups are equipped with an automatic system which can not be converted.

Dodge / Chrysler

Model	Year	Spline/Bolt Count	Hub #	AVM Hub #	Caution
Notes					
1/2 Ton Pickup	1947-68	19 - 6	400517		--
1/2 Ton Pickup & Ramcharger	1969-75	19 - Internal	400518	15001.18	--
3/4 Ton Pickup	1957-75	19-6	400517		--
Power Wagon WC 50 & 60	1942-56	16	400508	15001.08	--
D-50 Ram 50 4x4	1982-93	28	400543	15001.43	--
Arrow, D-50 4x4	Thru-1981	28	400528		--
1/2, 3/4 Ton Pickup & Ramcharger	1980-93	19 - Internal	400518	15001.18	--
3/4 Ton Pickup	1990-93	30 - Internal	400439		--
1 Ton Pickup (Dana 60)	1990-93	30 - Internal	400439		--
1 Ton Pickup (Dana 70)	1980-93	30 - 8	400541		--



Ford

Model	Year	Spline/Bolt Count	Hub #	AVM Hub #	Caution Notes
Bronco (Not Bronco II)	1966-96	19 - Internal	400518	15001.18	A, D
1/2 Ton F-100 Pickup	1959-86	19 - Internal	400518	15001.18	A
1/2 Ton F-150 Pickup	1959-86	19 - Internal	400518	15001.18	A, D
3/4 Ton F-250 Pickup (D-44)	1959-75	19 - Internal	400518	15001.18	A
3/4 Ton F-250 Pickup (D-44HD)	1963-77	19 - 6	400517		A
3/4 Ton F-250 Pickup (D-44)	1978-86	19 - Internal	400518	15001.18	A
3/4 Ton F-250 Pickup (D-60)	1978-97	30 - Internal	400439		A, D
1 Ton F-350 Pickup	1976-97	30 - Internal	400439		A, D
Super Duty F-250 & F-350	1959-86	19 - Internal	400518	15001.18	A, D

International-Harvester

Model	Year	Spline/Bolt Count	Hub #	AVM Hub #	Caution Notes
Scout	1960-71	10 - 6	400501	15001.01	--
Scout II, Terra, Traveler	1972-80	27 - 6	400502	15001.02	--
1/2, 3/4 Ton Pickup	1956-67	19 - 6	400517		--
1/2, Ton Pickup	1968-75	19 - Internal	400518	15001.18	--
Travel All	1968-75	19 - Internal	400518	15001.18	--

Land Rover

Model	Year	Spline/Bolt Count	Hub #	AVM Hub #	Caution Notes
Series I, IIA, III ALL W.B	1959-80	10 - 6	400405		--
Series I, IIA, III ALL W.B	1981-93	---	400406		--

Isuzu

Model	Year	Spline/Bolt Count	Hub #	AVM Hub #	Caution Notes
4X4 Pickup	Thru-1985	24 - 6	400522		--
4X4 Pickup	1972-80	24 - 6	400532		--
Trooper I, II	1983-86	24 - 6	400532		--
Trooper II	1987-99	17 - 6	400533	15001.33	E
Rodeo	1991-99	17 - 6	400533	15001.33	E

**Cautionary Notes:**

- A. When replacing Fulltime 4WD (NP203 only) requires conversion kit (see chart)
 B. Very early vehicles may require that the threaded axle end be cut off.
 C. Not compatible with Quadra-Trac equipped models.
 D. When replacing automatic 3 hole cap screw hubs, one will need to convert their spindle nuts.
 E. One must obtain special snap ring (26 mm or 11/16).
 F. When replacing automatic hubs with manual hubs, one must also change their spindle nuts (dealer item).

LOCKING HUBS

Mitsubishi

Model	Year	Spline/Bolt Count	Hub #	AVM Hub #	Caution Notes
Montero	1982-98	28 - 6	400543	15001.43	--
4X4 Pickup	1982-80	28 - 6	400543	15001.43	--

Nissan

Model	Year	Spline/Bolt Count	Hub #	AVM Hub #	Caution Notes
Patrol	1969-79	10 - 6	400507		--
Patrol	1980-87	29 - 6	400523	15001.23	--
4X4 Pickup	1972-82	24 - 6	400524		--
4X4 Pickup	1983-86	26 - 6	400544		--
4X4 Pickup W / 4 cyl	1986 1/2 - 93	27 - 6	400529	15001.29	--
4X4 Pickup, Pathfinder W / 6 cyl and Automatic Hubs (31 Spline)	--	31 - 6	400545	15001.45	--

Toyota

Model	Year	Spline/Bolt Count	Hub #	Caution Notes
Land Cruiser	1978-97	6 - 6	400504	--
Land Cruiser, Pickup	1976-87	30 - 6	400519	--
Pickup, 4 Runner	1976-85	30 - 6	400521	F
4X4 Pickup, 4 Runner (Excl. Tacoma)	1986-95	26 - 6	400513	F
Mid-size Pickup T100	1993-00	26 - 6	400513	F
Van, Previa	1986-94	26 - 6	400513	F
Tacoma (W/Factory Man. Hubs)	1995-00	26 - 6	400513	--

Suzuki / Geo

Model	Year	Spline/Bolt Count	Hub #	AVM Hub #	Caution Notes
Samurai / Sierra	1982-94	26 - 6	400538	15001.38	--
Sidekick / Tracker (ALL)	ALL	26 - 6	400538	15001.38	--

Commercial Trucks and Heavy Duty Axles

	AVM
Dana 25 / 27 Axle, 10 Spline	400501 15001.01
Dana 30 Axle, 27 Spline	400502 15001.02
Dana 44 Axle, 19 Spline (Internal)	400518 15001.18
Dana 44 Axle, 19 Spline (External)	400517
Dana 60 Axle, 30 Spline (Internal)	400439
Dana 70 Axle, 30 Spline (External)	400541



Chrysler Hub Assemblies

	Stock No.	Replaces
1995 Chrysler Lebaron Conv. Front Hub	16705.50	4340334
2000-02 Plymouth Prowler, Rear Hub	16705.51	4593450AA
2000-04 Concorde, Intrepid, LHS, 300M, Front Hub	16705.51	4593450AA
1995-97 Stratus, Cirrus, Plymouth Breesze, Front Hub	16705.52	459377
1996-99 Sterling Convertible, Front Hub	16705.52	459377
1992-95 All Mini-Van, With 15" Wheel, Front Hub	16705.53	4641196
1996-00 All Mini-Van, With 14" Wheel, Front Hub	16705.54	4641516
1997-04 All Mini-Van, With 15" or 16" Wheel, Front Hub	16705.53	4641196

DANA 60 Misc. Items

	Stock No.	Replaces
Oil Seal, Rear Axle - Outer, J-Truck	16534.35	994912
Bearing, Rear Wheel, J-Truck	16536.37	994913
Ring, Axle Shaft Bearing, J-Truck	16536.36	994914

Locking Hub Assemblies

	Stock No.	AVM
With Dana 60 Axle, 1 Ton Vehicles	400439	
With Dana 44 H.D.Axle, 3/4 Ton Vehicles (External)	400517	
Isuzu Trooper I, II: 1987-92	400533	15001.33
Montero, Hyundai, D-50 4X4 Dodge Raider 1982-92	400543	15001.43
Ford Ranger 1990-97, Ford Explorer 1990-94	400565	
Spindle Nut Kit, For above Ford (when replacing Auto Hubs)	404465	



POSI-LOK

	Stock No.
Dodge 1500-3500 Series. All with Dana 44 or Dana 60 with central disconnect	PSL400
Dodge 1985-93 1/2 or 3/4 Ton. All with central disconnect	PSL450
GM 1983-99 S/T 10-15, Blazer, Jimmy, All with vacuum actuators	PSL500
GM 1988-98 K1500, K2500 (6-LOG), 4WD Suburban, All w/thermal linear actuator	PSL600
GM 1988-99 K2500, K3500 (8-LOG), 1992-99 Suburban, All w/thermal linear actuator	PSL800
Ford 1973-93 F150. This kit replaces factory vacuum unit	PSL750
1987-95 DANA-30, YJ, XJ Jeeps®	PSL900
1987-95 DANA-30 YJ, XJ Jeeps® with 3" to 6" lift	PSL920
XJ, YJ POSI LOCK CAST IRON SHIFT FORK, FRONT D30 WITH DISCONNECT	PSL100

NEW

HARD PARTS



NEW AVM LOCKING HUBS

>>> **NEW** <<<



OMIX #	APPLICATION
15001.01	1942-71 CJ, M38-A1, WILLYS; 1960-71 SCOUT, 1966-71 JEEPSTER C101 COMMANDO, ALL YEARS UP TO 1973 WAGONEER
15001.02	1972-80 CJ; 1972-80 SCOUT II, TERRA, TRAVELER, 1972-73 JEEPSTER C104 COMMANDO
15001.26	1981-86 CJ
15001.18	DANA-44: 1969-91 CHEVY BLAZER, JIMMY, SUBURBAN 1969-87 CHEVY 1/2 TON PICKUP 1977-87 CHEVY 3/4 TON PICKUP 1969-75 DODGE 1/2 TON PICKUP 1980-93 DODGE 1/2, 3/4 PICKUP AND RAMCHARGER 1966-96 FORD BRONCO 1959-86 FORD F-100 & F-150 1/2 TON PICKUPS 1959-75, 78-86 FORD F-250 3/4 TON PICKUP 1959-86 FORD SUPERDUTY F-250 & F-350 PICKUPS 1968-75 81 1/2 TON PICKUP AND TRAVELALL 1974-91 J-10 PICKUPS 1977-87 J-20 PICKUPS
15001.08	1941-75 DODGE POWERWAGON
15001.23	NISSAN PATROL, 1980-87
15001.29	NISSAN 4X4 PICKUP, KING CAB, PATHFINDER H.B.
15001.33	ISUZU TROOPER 1987-2
15001.38	GED TRACKER, SUZUKI
15001.43	MONTERO, HYUNDAI, DODGE D-50 4X4
15001.45	NISSAN 4X4 PICKUP AND PATROL 1990 AND UP

MADE IN BRAZIL

MILITARY SPEC. HARDENED NYLON CENTER DIAL THAT WILL NOT DAMAGE OTHER PARTS IN UNLIKELY EVENT OF A FAILURE.

HARD PARTS



CJ FRONT DRIVE SHAFTS:

YEAR	MODEL	ENGINE	TRANS	LENGTH	Stock No.	Replaces
1946-56	CJ3A & EARLY CJ3B	(LTD. AVAILABILITY)			16590.01	908820
1976-79	CJ7	6 OR 8 CYL	AUTO	36-5/8 "	16590.02	5359382
1976-79	CJ7, CJ5	6 OR 8 CYL	T150	26.50 "	16590.03	5356500
1976-79	CJ7, CJ5	6 OR 8 CYL	T18	30.25 "	16590.04	5356501
1981	CJ7, CJ8	4 CYL	AUTO	30.25 "	16590.04	5356501
1980	CJ7	4 CYL	AUTO	32-5/8 "	16590.05	5360985
1980-81	CJ7, CJ8	6 OR 8 CYL	AUTO	32-5/8 "	16590.05	5360985
1980-81	CJ7, CJ8	4 OR 6 CYL	SR4	31.75 "	16590.06	5360982
1982-86	CJ7, CJ5, CJ8	6 CYL	T4 OR T5	31.75 "	16590.06	5360982
1980-81	CJ7, CJ5, CJ8	8 CYL	T170	29.50 "	16590.07	5360986
1981-86	CJ7, CJ5, CJ8	6 CYL	T170	29.50 "	16590.07	5360986
1982-86	CJ7, CJ5	4 CYL	T176	27.25 "	16590.08	5362815
1983-86	CJ7, CJ5, CJ8	4 CYL	T4 OR T5	29.50 "	16590.07	5360986



CJ REAR DRIVESHAFTS:

YEAR	MODEL	ENGINE	TRANS	LENGTH	Stock No.	Replaces
1976-79	CJ7	6 OR 8 CYL	T150	26.50 "	16591.01	5356508
1980	CJ7	4, 6 OR 8 CYL	AUTO	20.75 "	16591.02	5360987
1981	CJ7	4, 6 OR 8 CYL	SR4	20.75 "	16591.02	5360987
1982-86	CJ7	6 CYL	T4 OR T5	20.75 "	16591.02	5360987
1980	CJ7	6 OR 8 CYL	T170	23-5/8 "	16591.03	5360988
1980	CJ7	4 CYL	SR4	23-5/8 "	16591.03	5360988
1981-86	CJ7	4 CYL	T4 OR T5	23 "	16591.04	5362281
1981-86	CJ7	4, 6 OR 8 CYL	T170	23 "	16591.04	5362281
1981-86	CJ7	6 OR 8 CYL	AUTO		16591.05	5362280
1976-79	CJ5	6 OR 8 CYL	T150	18.25 "	16591.06	5356509
1980	CJ5	4 OR 6 CYL	SR4	13-7/8 "	16591.07	5360983
1981	CJ5	4 OR 6 CYL	SR4	13 "	16591.08	5362276
1982-86	CJ5	4 OR 6 CYL	T4 OR T5	13 "	16591.08	5362276
1981	CJ8	4 OR 6 CYL	T170	33 "	16591.09	5362278
1982-86	CJ8	4 CYL	T4 OR T5	33 "	16591.09	5362278
1981-82	CJ8	4 OR 6 CYL	SR4	30.75 "	16591.10	5362277
1982-86	CJ8	6 CYL	T4 OR T5	30.75 "	16591.10	5362277
1948-71	CJ5(CJ2A SERIAL# 13453 & UP)	4-CYL & 3-SPEED			16591.11	906932



OTHER REPLACEMENT DRIVESHAFTS:

WRANGLER DRIVE SHAFTS:

DESCRIPTION	Stock No.	Replaces
1987-95 6 CYL. YJ WRANGLER WITH MANUAL, FRONT	16590.20	52088027
1987-95 6 CYL. YJ WRANGLER WITH AUTO, FRONT	16590.21	52088028
1997-02 6 CYL. TJ WRANGLER WITH AX15 TRANS., FRONT	16590.22	52098377
1997-02 6 CYL. TJ WRANGLER WITH AUTO, FRONT	16590.23	52098378
2003-05 4.0L TJ W/ MANUAL TRANS., FRONT	NEW 16590.24	52098377AE
2001-02 TJ 2.5L BOTH AUTO AND MANUAL TRANS., FRONT	NEW 16590.25	52098378AC
2003-04 TJ WITH AUTO TRANS., FRONT 2.4L	NEW 16590.27	52853401AB
2003-05 2.4L TJ WITH MANUAL TRANS., FRONT	NEW 16590.28	52853402AB
1987-93 6 CYL. YJ WRANGLER WITH MANUAL, REAR	16591.20	TBA
1993-95 6 CYL. YJ WRANGLER WITH AX15 TRANS., REAR	16591.21	52098218
1987-93 YJ WRANGLER WITH AUTO, REAR, 6-CYL	16591.22	53005397
1994-96 YJ MANUAL, W/ 3" SLIP YOKE	S-52098221	52098221
2001-05 TJ 4.0L WITH MANUAL TRANS. REAR	NEW 16591.23	52098787AC



16592.05

CV REAR DRIVESHAFT FOR 1987-04 WRANGLERS
THESE DRIVESHAFTS ARE A MUST WHEN USING SLIP YOKE ELIMINATOR KITS ON NEW PROCESS 231

XJ CHEROKEE DRIVE SHAFTS

1989-00 XJ CHEROKEE, 6 CYL 4.0L MANUAL TRANNY, FRONT	16590.30	53005543
1989-00 XJ CHEROKEE, 6 CYL 4.0L AUTOMATIC, FRONT	16590.31	53005542
1995-00 XJ CHEROKEE, 2.5 DIESEL (EXPORT), FRONT	16590.32	52098208
1989-92 XJ CHEROKEE, 6 CYL 4.0L MANUAL, EXPORT, FRONT	16590.33	53005544
1989-92 XJ CHEROKEE, 6 CYL 4.0L AUTOMATIC, EXPORT, FRONT	16590.34	53005545
1987-92 XJ CHEROKEE, 6 CYL 4.0L 4WD, AUTOMATIC & DANA-35, REAR	16591.30	53003246

ZJ GRAND CHEROKEE DRIVE SHAFTS:

1992-93 6-CYL WITH AUTOMATIC TRANNY, FRONT	16590.40	52098341
1992-96 6-CYL WITH AX15 MANUAL TRANNY, FRONT	16590.41	52098344
1994 6-CYL WITH A500 TRANNY, FRONT	16590.42	52098790
1993-95 V8 WITH AUTOMATIC TRANNY, FRONT	16590.43	53008427
1994-95 V8 WITH A500 AUTOMATIC TRANNY, FRONT	16590.44	52087805
1993 6-CYL, 4WD WITH AX15 MANUAL TRANNY, REAR	16591.40	52098163

1987-93 WRANGLER WITH UP TO 3" LIFT	16592.01	CV-8793YJ23
1987-93 WRANGLER WITH OVER TO 3" LIFT	16592.02	CV-8793YJ45
1994-95 WRANGLER WITH UP TO 3" LIFT	16592.03*	CV-9495YJ23
1994-95 WRANGLER WITH OVER TO 3" LIFT	16592.04*	CV-9495YJ45
1997-04 TJ WRANGLER WITH 2" TO 6" LIFT	16592.05	CV-97011J26
1987-04 SLIP YOKE ELIMINATOR KIT FOR MP231	18676.60	52231
YOKE FOR SLIP YOKE ELIMINATOR KIT	18676.61	245341

* THESE DRIVESHAFTS USE 3-5/8" WIDE U-JOINT, PLEASE VERIFY THE UJ SIZE

TBA= TO BE ANNOUNCED

HARD PARTS

MISC. AXLE COMPONENTS:

DESCRIPTION	Stock No.	Replaces
CV BOOT KIT (BOOT & CLAMP)	16527.30	4796233
1941-86 CJ FRONT & REAR DRIVESHAFT (EXCEPT 1967-71 FR CJ) U-JOINT	16585.01	8126614S
1941-86 SAME AS ABOVE, SPICER BRAND U-JOINT	16585.02	8126614S
1967-71 CJ FRONT DRIVESHAFT U-JOINT	16585.03	8126610
1967-92 WAGONEER, GRAND CHEROKEE, U-JOINT	16585.04	8126636
1987-93 YJ, 1997-99 TJ, FR OR REAR DRIVESHAFT 3-7/32" U-JOINT	16585.01	8126614
1987-93 YJ, 1997-99 TJ, FR OR REAR DRIVESHAFT 3-7/32" U-JOINT, SPICER	16585.02	8126614S
1955-99 3-7/32" U-JOINT KIT, GREASE FEEDER ON BEARING, SPICER	16585.05	8130750S
1994-97 YJ & TJ REAR DRIVESHAFT 3-5/8" U-JOINT	16585.06	5-213X
1945-95 U-BOLT KIT ALL MODELS (FOR U-BOLT STYLE YOKES), PAIR	16582.01	A-490K
1945-95 U-BOLT KIT ALL MODELS (FOR U-BOLT STYLE YOKES), PAIR, SPICER	16582.02	A-490KS
1980-95 STRAP & BOLT KIT PAIR	16582.03	3240553K
1946-71 CJ REAR DRIVESHAFT FLANGE YOKE	16580.50	22939
1946-65 CJ SLIDING YOKE FOR FRONT DRIVE SHAFT	16580.51	909213
1946-71 CJ SLIDING YOKE FOR REAR DRIVE SHAFT	16580.51	909213
1974-86 CJ SLIDING YOKE FRONT OR REAR DRIVE SHAFT	16580.52	932209
1987-95 YJ WRANGLER SLIDING YOKE	16580.53	83502855
1975-86 CJ & SJ, FRONT DRIVESHAFT CONSTANT VELOCITY YOKE	16580.54	8126796
1972-92 SJ WAGONEER OR CHEROKEE, REPAIR KIT, REAR DRIVESHAFT	16580.55	940800
THREADLOCKER, PERMANENT, 5ML., USA MADE	NEW 19201.02	732744



YOKE & YOKE DUST SHIELDS:

DESCRIPTION	Stock No.	Replaces
YOKE	16580.04	A-1445
YOKE, 10 SPLINE	16580.01	A-1106
YOKE, DANA-18	18670.27	116714
YOKE (SAME AS # 938685) EXCEPT WITH LARGER DUST SHIELD	16580.40	935685-L



YJ WRANGLER HUB CONVERSION

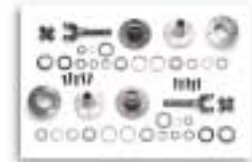

WARN HUB SETS:

ALL WARN MANUAL HUBS FEATURE 4140 CHROME-MOLY STEEL INNER DRIVE GEAR AND CLUTCH RING, HIGH QUALITY O-RINGS AND GASKETS ON ALL MATING SURFACES AND COME WITH A LIFETIME WARRANTY

DESCRIPTION	Stock No.
1941-71 CJ PREMIUM HUB SET	W29062
1972-80 CJ PREMIUM HUB SET	W9062
1981-86 CJ STANDARD HUB SET	W28751
SJ 19 SPLINE PREMIUM HUB SET	W20990



WARN FULL FLOAT REAR AXLE CONVERSIONS:

ELIMINATE THE SOLID AXLE FROM SUPPORTING THE WEIGHT OF THE VEHICLE AS WELL AS HOLD THE WHEELS ON. HIGH YIELD STRENGTH AXLES AND INTERNAL SPLINED HUBS ELIMINATE BOLTS AND ARE GUARANTEED NEVER TO LOOSEN.

DESCRIPTION	Stock No.
1972-75 DANA-44	W61755
AMC-20 NARROW TRACK	W61754
AMC-20 WIDE TRACK	W61752
1984-89 DANA-35	W61750
1990-03 DANA-35	W61748
1997-02 DANA-44	W61746

WARN FRONT HUB CONVERSIONS:

MAKE YOUR VEHICLE MORE FUNCTIONAL AND DURABLE. THE ABILITY TO DISENGAGE THE FRONT DRIVELINE IMPROVES DRIVABILITY, REDUCES WEAR AND INCREASES MILAGE. HIGHLY RECOMMENDED WHEN USING A FRONT DIFFERENTIAL LOCKER.

DESCRIPTION	Stock No.
1972-86 CJ 27 SPLINE	W37132
1987-94 YJ WRANGLER & XJ CHEROKEE 27 SPLINE	W38006
1995-03 YJ AND TJ WRANGLER 27 SPLINE	W38007



SUPERWINCH & AVM HUB SETS:

SUPERWINCH OFFERS THESE HIGH QUALITY MANUAL HUBS WITH METAL CENTERS. BETTER THAN THE OE VERSIONS THESE HUBS OFFER GREAT 4WD TRACTION AS WELL AS 2WD DRIVABILITY AND ECONOMY.

DESCRIPTION	SUPERWINCH	AVM
1942-71 CJ 10 SPLINE, PAIR	400501	15001.01
1972-80 CJ 27 SPLINE, 6 BOLT, PAIR	400502	15001.02
1981-86 CJ 27 SPLINE, 5 BOLT, PAIR	400526	15001.26
1974-91 SJ CHEROKEE, PAIR	400518	15001.18



HARD PARTS

WARN HEAVY-DUTY FRONT AXLES:

WARN'S HEAVY DUTY FRONT AXLES ARE THE TOUGHEST MADE. 4340 CHROME/NICKEL AIRCRAFT ALLOY AND A YIELD STRENGTH OF 230,000 PSI MEAN THESE AXLES WILL SURVIVE ALMOST ANYTHING YOU CAN THROW AT THEM. DESIGNED TO ACCEPT FULL-CIRCLE RETAINING RINGS (REDUCES U-JOINT FAILURES) AND FOR THOSE WITH THE EARLY DANA-30 YOU CAN UPGRADE TO THE LARGER 297X U-JOINT.

DESCRIPTION	Stock No.
1972-83 CJ5 & 1976-81 CJ7 FRONT INNER AXLE RH	W38803
1972-83 CJ5 & 1976-81 CJ7 FRONT INNER AXLE LH	W38789
1982-86 CJ7 & CJ8 FRONT INNER AXLE RH	W38805
1982-86 CJ7 & CJ8 FRONT INNER AXLE LH	W38804
1972-86 CJ FRONT OUTER AXLE RH OR LH	W39105
1987-03 YJ & TJ WRANGLER FRONT INNER AXLE RH	W38875
1987-03 YJ & TJ WRANGLER FRONT INNER AXLE LH	W38821



WARN FRONT OUTER AXLE

LOCK-RIGHT PERFORMANCE LOCKERS:

THE LOCK-RIGHT PERFORMANCE TRACTION DEVICE DIFFERENTIATES ITSELF FROM OTHER LOCKERS WITH ITS EASE OF INSTALLATION. NO SHIMMING OR LASH ADJUSTMENTS ARE NEEDED BECAUSE THE RING AND PINION ARE NEVER TOUCHED. REQUIRES NO SPECIAL TOOLS AND CAN BE INSTALLED IN JUST A FEW HOURS. DESIGNED TO RE-USE ORIGINAL CROSS SHAFT. CROSS SHAFT IS NOT INCLUDED IN MOST CASES.

DESCRIPTION	Stock No.
FRONT 1945-64 CJ 'S DANA-25 & 1964-71 CJ DANA-27	LR2115
FRONT 1972-03 CJ, YJ, TJ	LR2210
REAR 1945-49 CJ 'S WITH DANA-41	LR2416
REAR 1945-62 CJ 'S WITH 10-SPLINE DANA-44	LR2415
REAR 1955-69 CJ 'S WITH 19-SPLINE DANA-44	LR2413
REAR 1970-86 CJ 'S WITH 30-SPLINE DANA-44, ALSO 1997-02 TJ	LR2410
REAR 1976-86 CJ 'S WITH AMC-20	LR1710
REAR 1987-93 YJ DANA-35 (EXCEPT 1993 W/ 605528 BOM) (PLUS Z-SHAFT)	LR2310S
REAR 1994-03 YJ & TJ DANA-35 (ALSO 1993 YJ 605528 BOM) (PLUS Z-SHAFT)	LR2311S
ZYTANIUM CROSSSHAFT, REAR AMC-20	LRSA1710
ZYTANIUM CROSSSHAFT, FRONT DANA-30	LRSD2210
ZYTANIUM CROSSSHAFT, REAR DANA-44	LRSD2410



LOCK-RIGHT LOCKERS

POWERTRAX NO-SLIP TRACTION SYSTEM:

NO MORE RATCHETING SOUND!! REVOLUTIONARY DESIGN ALLOWS THE NO-SLIP TO COMPLETELY DISENGAGE WITHOUT A SOUND WHEN THE WHEELS BEGIN TO TURN AT DIFFERENT SPEEDS BUT REMAIN FULLY LOCKED WHEN POINTED STRAIGHT. IT DOESN'T USE CLUTCHES OR FRICTION PLATES THAT EVENTUALLY WEAR AND IT INSTALLS JUST AS EASILY AS THE LOCK-RIGHT.

DESCRIPTION	Stock No.
FRONT 1972-01 DANA-30 CJ, YJ, TJ, XJ, ZJ, OPEN CARRIER	LR302700
REAR 1976-86 AMC-20 CJ, OPEN CARRIER (NOT WITH 1-PIECE AXLES)	LR202900
REAR 1976-86 AMC-20 CJ, TRAC-LOC (NOT WITH 1-PIECE AXLES)	LR202920
REAR 1972-75 CJ, 1986 CJ, 1997-00 TJ, DANA-44 OPEN CARRIER	LR443000
REAR 1972-75 CJ, 1986 CJ, 1997-03 TJ, DANA-44 TRAC-LOC	LR443020
REAR 1987-89 YJ DANA-35, OPEN CARRIER	LR352700
REAR 1990-93 YJ DANA-35, OPEN CARRIER	LR352705
REAR 1994-03 YJ & TJ DANA-35, OPEN CARRIER	LR352706
REAR 1990-03 YJ & TJ DANA-35, TRAC-LOC	LR352725



POWERTRAX NO-SLIP

4X4 POSI-LOK IS A CABLE OPERATED AXLE ENGAGEMENT SYSTEM TO REPLACE THE FAILURE PRONE VACUUM C.A.D. SYSTEM. IT ALSO ALLOWS THE USE OF 2 WHEEL (REAR) LOW RANGE AND A FRONT LOCKER.

4X4 POSI-LOK AXLE ENGAGEMENT KIT:

DESCRIPTION	Stock No.
1987-95 YJ WITH CENTRAL AXLE DISCONNECT	PSL900
ALSO FITS: 84-91 XJ & 86-91 MJ WITH FRONT DANA 30	
1987-95 YJ WITH 3-6" LIFT	PSL920
XJ, YJ POSI LOCK CAST IRON SHIFT FORK	NEW PSL100
FRONT D30 WITH DISCONNECT	



PSL100



POSITIVE AXLE ENGAGEMENT

See Page 89
For Other Posi-Lok
Applications

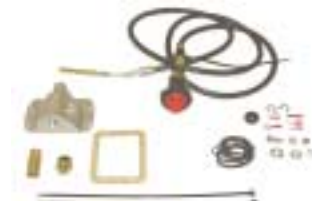

THE ARB AIR LOCKER IS THE BEST METHOD OF ATTAINING 100% LOCKED DIFFERENTIAL TRACTION FOR OFF ROADING WHILE STILL MAINTAINING THE STOCK HANDLING CHARACTERISTICS ON THE STREET. UTILIZING A 12 VOLT AIR COMPRESSOR (SOLD SEPARATELY), THE SYSTEM IS DESIGNED TO ACTIVATE (AND DEACTIVATE) A LOCKING MECHANISM IN THE DIFFERENTIAL WHICH ALLOWS THE DIFFERENTIAL TO BE FULLY LOCKED OR FULLY OPEN AT THE FLIP OF A SWITCH. IT IS MANUFACTURED FROM THE HIGHEST QUALITY MATERIALS AND TESTED IN THE MOST EXTREME CONDITIONS. LET ARB TAKE YOU WHERE YOU WANT TO GO.

ARB AIR LOCKERS:

APPLICATION	Stock No.
1970-03 DANA 44 30 SPLINE 3.92 & UP RATIO FITS: CJ, MJ, TJ, ZJ, WJ, SJ	ARB-RD06
1970-03 DANA 44 30 SPLINE 3.73 & DOWN RATIO FITS: CJ, MJ, TJ, ZJ, WJ, SJ	ARB-RD07
1972-03 DANA 30 27 SPLINE 3.73 & UP RATIO FITS: CJ, XJ, YJ, TJ, ZJ, WJ	ARB-RD100
1972-03 DANA 30 27 SPLINE 3.54 & DOWN RATIO FITS: CJ, XJ, YJ, TJ, ZJ, WJ	ARB-RD101
1976-86 AMC 20 29 SPLINE 3.08 & UP RATIO FITS: CJ & SJ	ARB-RD60
1990-03 DANA 35 W/C-CLIP 27 SPLINE 2.73-3.31 RATIO FITS: YJ, TJ, XJ, ZJ	ARB-RD103
1990-03 DANA 35 W/C-CLIP 27 SPLINE 3.54 & UP RATIO FITS: YJ, TJ, XJ, ZJ	ARB-RD102
1997-UP CHRYSLER 8.25" 29 SPLINE, ALL RATIOS FITS: ZJ, WJ, KJ	ARB-RD93
SUPER DANA 30, 3.73 AND UP RATIO	ARB-RD104
SUPER DANA 35, C-CLIP, 30 SPL, 3.54 AND UP RATIO	ARB-RD105



ARB AIR LOCKER ACCESSORIES:

ARB LOCKER ACCESSORIES:	Stock No.
12V AIR COMPRESSOR KIT	ARB-RDCKA
PORTABLE 12V AIR COMPRESSOR KIT	ARB-RDCPA
AIR LINE SERVICE KIT	ARB-ASK001
HEAVY DUTY AIR LINE KIT	ARB-HDAL
REPLACEMENT SOLENOID	ARB-180103
REPLACEMENT 40 AMP ELECTRIC RELAY	ARB-CO42
TIRE INFLATION KIT	ARB-PUKT



THE ORIGINAL DETROIT LOCKER. FULLY AUTOMATIC AND WELL KNOWN FOR ITS PREMIUM PERFORMANCE AND DEPENDABLE OPERATION. IT IS THE LOCKER OF CHOICE FOR MOST FOUR WHEELERS. REPLACES ENTIRE CARRIER

THE TRUETRAC IS THE IDEAL FRONT AXLE TRACTION DEVICE. A GEAR DRIVEN LIMITED SLIP DIFFERENTIAL PROVIDES PLENTY OF TRACTION WITHOUT ADVERSE ON ROAD HANDLING CHARACTERISTICS. PERFECT FOR THE OCCASIONAL 4-WHEELER.



HARD PARTS

DETROIT LOCKING DIFFERENTIALS:

Description	Stock No.
1972-86 CJ, DANA 30 FRONT AXLE 3.73-5.38 RATIO	TT-16260B
1972-86 CJ, AMC 20 REAR AXLE 3.08-4.56 RATIO	TT-18747A
1987-03 YJ & TJ WRANGLER, DANA 35 REAR AXLE 3.54-5.38 RATIO	TT-16256A
1970-75 & 1986 CJ, 1997-03 TJ WRANGLER, 30 SPLINE DANA 44 REAR AXLE 2.73-3.73 RATIO	TT-18716D
1970-75 & 1986 CJ, 1997-03 TJ WRANGLER, 30 SPLINE DANA 44 REAR AXLE 3.92-5.38 RATIO	TT-18716C

TRUETRAC LIMITED SLIP DIFFERENTIALS

Description	Stock No.
1972-03 CJ, YJ & TJ WRANGLER, DANA 30 FRONT AXLE 2.73-3.54 RATIO	TT-912374
1972-03 CJ, YJ & TJ WRANGLER, DANA 30 FRONT AXLE 3.73-5.38 RATIO	TT-912314
1987-03 YJ & TJ WRANGLER, DANA 35 REAR AXLE 3.54-5.38 RATIO	TT-912310
1970-75 & 1986 CJ, 1997-03 TJ WRANGLER, 30 SPLINE DANA 44 REAR AXLE 2.73-3.73 RATIO	TT-913312
1970-75 & 1986 CJ, 1997-03 TJ WRANGLER, 30 SPLINE DANA 44 REAR AXLE 3.92-5.38 RATIO	TT-913313

BRAKE DRUMS (FRONT OR REAR):

Description	Stock No.	Replaces
1941-47 MB, CJ2A, 9" BRAKE	16701.01	A-472
1948-65 CJ WITH 9" BRAKE, FRONT OR REAR	16701.02	808770
1965-71 CJ WITH 10" BRAKE, FRONT OR REAR	16701.03	994306
1972-74 CJ WITH 11" BRAKE, UNFINNED, FRONT OR REAR	16701.04	994305
1974-78 CJ WITH 11" BRAKE, FINNED, FRONT OR REAR	16701.05	5352476
1978-86 CJ WITH 10" BRAKE, REAR	16701.06	5359028
1987-89 WRANGLER WITH 10" BRAKE, REAR	16701.07	52001151
1990-04 WRANGLER (BOTH YJ,TJ) WITH 9 X 2.5", DANA 35 AXLE, REAR	16701.08	52005350
1987-93 WRANGLER WITH 10 X 2.5" BRAKE, WITH DANA-44 AXLE, REAR	16701.09	52001915
1948-63 226 WAGON OR TRUCK, 11", FRONT OR REAR	16701.10	941877
1946-54 4 CYL. 2WD WAGON (ALSO FITS 1948-51 2WD JEEPSTER)	16701.11	641745
1974-78 SJ WAGONEER, CHEROKEE, UNFINNED, FR OR REAR	16701.12	5352266
1978-91 SJ WAGONEER, CHEROKEE, FINNED, REAR	16701.13	5359281
1984-89 XJ CHEROKEE WITH 10" BRAKE AND DANA-35 REAR AXLE	16701.07	52001151
1986-89 XJ WITH 10X2.5" BRAKE, WITH DANA-44 AXLE, REAR	16701.09	52001915
1990-01 XJ CHEROKEE OR ZJ GRAND CHEROKEE, WITH 9" BRAKE, REAR	16701.08	52005350
POSTAL DJ'S FRONT	16701.14	5732482
POSTAL DJ'S REAR	16701.15	8124287
1990-01 XJ CHEROKEE OR ZJ GRAND CHEROKEE, WITH 10" BRAKE, REAR	16701.16	52007502
2002-UP KJ LIBERTY, REAR BRAKE DRUM	16701.17	52128270AA



16701.02

16701.04



16701.06

16701.07



16702.02

16702.03

BRAKE ROTORS (FRONT):

Description	Stock No.	Replaces
No.1977-78 CJ 1-1/8" THICK (ROTOR ONLY)	16702.01	5356183R
1978-86 CJ 7/8" THICK (ROTOR ONLY)	16702.02	5363421R
1987-89 WRANGLER (ROTOR ONLY)	16702.03	3251156
1990-02 WRANGLER (BOTH YJ & TJ) (ROTOR ONLY)	16702.04	52008264
2003 TJ, FRONT ROTOR	16702.05	5016434AA
1977-81 SJ CHEROKEE, WAGONEER (ROTOR ONLY)	16702.06	5357391R
1984-89 XJ CHEROKEE 4WD (ROTOR ONLY)	16702.03	3251156
1990-01 XJ CHEROKEE 4WD (ROTOR ONLY)	16702.04	52008264
2001 XJ CHEROKEE, FRONT ROTOR	16702.05	5016434AA
1986-93 XJ CHEROKEE 2 WD	16702.07	53002928
1993-98 ZJ GRAND CHEROKEE	16702.04	52008264
1999-UP WJ GRAND CHEROKEE	16702.08	52098672
2002-UP KJ LIBERTY	16702.09	52128247AA



16702.07

BRAKE ROTORS (REAR):

Description	Stock	Replaces
1993-98 ZJ GRAND CHEROKEE WITH REAR DISC BRAKE	16703.01	52008184
1999-UP WJ GRAND CHEROKEE WITH REAR DISC BRAKE	16703.02	52098666
2003-04 KJ LIBERTY, BRAKE ROTOR REAR	NEW 16703.03	52128411AA



16703.01

HUBS & ROTORS (FRONT):

Description	Stock No.	Replaces
1977-78 CJ WITH 1-1/8" THICK ROTOR (NOT ASSEMBLED)	16704.01	5356183
1978-81 CJ 7/8" THICK ROTOR, 6 BOLT HUB (NOT ASSEMBLED)	16704.02	5358568
1978-81 CJ 7/8" THICK ROTOR, 6 BOLT HUB (FACTORY ASSEMBLY)	16704.03	5358568A
1981-86 CJ 7/8" THICK ROTOR, 5 BOLT HUB (NOT ASSEMBLED)	16704.04	5363421
1981-86 CJ 7/8" THICK ROTOR, 5 BOLT HUB (FACTORY ASSEMBLY)	16704.05	5363421A

FRONT HUBS:

Description	Stock No.	Replaces
1941-63 ALL MODELS, FRONT HUB WITH LH THREAD STUDS, ALSO FITS REAR MB	16705.01	649937
1941-63 ALL MODELS, FRONT HUB WITH RH THREAD STUDS, ALSO FITS REAR MB	16705.02	649938
1941-63 ALL MODELS, FRONT HUB WITHOUT STUDS, ALSO FITS REAR MB	16705.03	909548
1965-81 CJ W/6 BOLT LOCKOUT HUBS (W/O CUPS OR STUDS)	16705.04	5358568H
1981-86 CJ W/5 BOLT LOCKOUT HUBS (W/O CUPS OR STUDS)	16705.05	5363421H
1987-89 WRANGLER, ASSEMBLY (WITH BEARINGS, SEALS & STUDS)	16705.06	53000228
1990-00 WRANGLER (BOTH YJ & TJ), ASSEMBLY (WITH BEARINGS, SEALS & STUDS)	16705.07	53007449
2000-UP TJ WRANGLER, XJ CHEROKEE, FRONT HUB ASSEMBLY	16705.08	5016458AA
1987-89 XJ CHEROKEE, ASSEMBLY (WITH BEARINGS, SEALS & STUDS)	16705.06	53000228
1990-01 XJ CHEROKEE & ZJ GRAND CHEROKEE, ASSEMBLY (WITH BEARINGS, SEALS & STUDS)	16705.07	53007449
1999-UP WJ GRAND CHEROKEE, FRONT HUB ASSEMBLY	16705.09	52098679AD
2002-UP KJ LIBERTY, FRONT HUB ASSEMBLY W / OUT ABS	16705.10	52128352AB
2002-UP KJ LIBERTY, FRONT HUB ASSEMBLY WITH ABS, RH	16705.12	52128692AA
2002-UP KJ LIBERTY, FRONT HUB ASSEMBLY WITH ABS, LH	16705.11	52128693AA



16705.07



HARD PARTS

FRONT HUB BEARINGS, CUPS & SEALS:

	Stock No.	Replaces
1945-64 CJ INNER BEARING	16706.01	52942
1945-64 CJ INNER CUP	16707.01	52943
1945-64 CJ OUTER BEARING	16706.01	52942
1945-64 CJ OUTER CUP	16707.01	52943
1945-64 CJ OIL SEAL	16708.01	805150
1965-76 CJ INNER BEARING	16706.02	3156052
1965-76 CJ INNER CUP	16707.02	925447
1965-76 CJ OUTER BEARING	16706.02	3156052
1965-76 CJ OUTER CUP	16707.02	925447
1965-76 CJ OIL SEAL	16708.02	938151
1977-86 CJ INNER BEARING	16706.03	5356661
1977-86 CJ INNER CUP	16707.03	8127630
1977-86 CJ OUTER BEARING	16706.02	3156052
1977-86 CJ OUTER CUP	16707.02	925447
1977-86 CJ OIL SEAL	16708.03	5356675
1987-89 WRANGLER & XJ CHEROKEE BEARING & CUP (INNER OR OUTER)	16709.01	53000238
1987-89 WRANGLER & XJ CHEROKEE INNER OIL SEAL	16708.04	53000239
1974-91 SJ, OIL SEAL	16708.05	5359703



SUPERWINCH & AVM FRONT LOCKING HUBS:

	SUPERWINCH	AVM
1945-71 CJ 10 SPLINE, PAIR	400501	15001.01
1972-80 CJ 27 SPLINE, 6 BOLT, PAIR	400502	15001.02
1981-86 CJ 27 SPLINE, 5 BOLT, PAIR	400526	15001.26
1974-91 SJ CHEROKEE, PAIR	400518	15001.18



WARN FRONT LOCKING HUBS:

1945-71 CJ 10 SPLINE, PREMIUM SERIES	W29062
1972-80 CJ 27 SPLINE, PREMIUM SERIES	W9062
1981-86 CJ 27 SPLINE, STANDARD SERIES	W28751
1974-91 SJ MODELS, PREMIUM SERIES	W20990

MISC. FRONT HUB ITEMS:

	Stock No.	Replaces
1945-86 CJ SPINDLE NUT & WASHER KIT (2 NUTS & 2 WASHERS)	16710.01	A-867K
1945-86 CJ SPINDLE NUT SOCKET	16711.01	A-692
1941-64 MB & CJ HUB CAP	16712.01	641920

WHEEL STUDS AND LUG NUTS:

	Stock No.	Replaces
MB, CJ2A, CJ3A, WHEEL STUD LH THREAD, FRONT OR REAR	16714.01	A-473
MB, CJ2A, CJ3A, WHEEL STUD RH THREAD, FRONT OR REAR	16714.02	A-474
1964-78 CJ WHEEL STUD RH THREAD, DRUM BRAKE, FRONT (EACH)	16714.03	5353025
1977-86 CJ WHEEL STUD, RH THREAD, DISC BRAKE, FRONT (EACH)	16714.04	5357196
19887-89 WRANGLER & 1984-89 XJ CHEROKEE, WHEEL STUD, FRONT (EACH)	16714.05	TBA
1970-86 CJ WITH DANA 44 OR AMC-20 AXLE, WHEEL STUD, REAR (EACH)	16714.06	5355719
1990-98 WRANGLER, XJ CHEROKEE AND ZJ GRAND-CHEROKEE, WHEEL STUD FRONT (EACH)	16714.07	53007463
1990-98 WRANGLER, XJ CHEROKEE AND ZJ GRAND-CHEROKEE, WHEEL STUD REAR DRUM (EACH)	16714.08	83503053
1994-00 WRANGLER, XJ CHEROKEE AND ZJ GRAND-CHEROKEE, WHEEL STUD REAR DISC (EACH)	16714.09	4762841
2001-02 TJ WRANGLER REAR, WHEEL STUD	NEW 16714.10	5011312AA
2003-04 TJ WRANGLER FRONT, WHEEL STUD	NEW 16714.11	6036482AA
1941-46 MB, EARLY CJ2A, WHEEL NUT, LEFT THREAD	16715.01	A-475
1941-46 MB, EARLY CJ2A, WHEEL NUT, RIGHT THREAD	16715.02	A-476
1945-86 CJ WHEEL NUT, RH THREAD, FRONT OR REAR (EACH)	16715.04	635516
1945-71 CJ WHEEL NUT, LH THREAD, FRONT OR REAR (EACH)	16715.03	636035
1945-86 CJ WHEEL NUT, RH THREAD, CHROME FRONT OR REAR, (EACH)	16715.05	4005694
1987-98 WRANGLER WHEEL NUT, RH THREAD, CHROME, FRONT OR REAR (EACH)	16715.06	4006956



BRAKE POWER BOOSTERS:

	Stock No.	Replaces
1982-86 CJ	16718.01	8133909
1987-89 YJ WRANGLER	16718.02	83502846
1991-95 YJ WRANGLER W/O ABS	16718.03	4637862
1984-86 XJ CHEROKEE	16718.04	83501196
1995-96 XJ CHEROKEE (WITH GAS ENGINE)	16718.05	4761788
1995-98 ZJ GRAND CHEROKEE	16718.06	4761786
1997-01 XJ CHEROKEE	NEW 16718.07	4856672AB



BRAKE MASTER CYLINDERS (NEW, NOT REBUILT):

	Stock No.	Replaces
1941-48 MB & CJ2A (THROUGH 1948 CJ2A)	16719.01	8123176
1941-48 MB & CJ2A (THROUGH 1948 CJ2A) (BRAND NAME)	16719.02	8123176-USB
1949-66 CJ2A, CJ3A, CJ3B, CJ5, CJ6, 1948-63 WAGON, M38, M38A1	16719.03	8126738
1949-66 CJ2A, CJ3A, CJ3B, CJ5, CJ6, 1948-63 WAGON, M38, M38A1 (Brand Name)	16719.04	8126738-USB
1967-71 CJ (10" BRAKE)	16719.05	9455556
1972-76 CJ W/O POWER BRAKE, W/FRONT DRUM BRAKE	16719.06	8126737
1977-78 CJ W/O POWER BRAKE, W/FRONT DRUM BRAKE	16719.07	8126736
1976-78 CJ W/O POWER BRAKE, W/FRONT DISC BRAKE	16719.08	8127820
1976-78 CJ W/POWER BRAKES, W/FRONT DISC BRAKE	16719.09	8127821
1978-86 CJ, W/O POWER, DISC BRAKE, W/2-BOLT CALIPER PLATE	16719.10	8134270
1978-86 CJ W/POWER, DISC BRAKE, W/2-BOLT CALIPER PLATE	16719.11	83500995
1982-UP POSTAL JEEP, 4CYL	16719.12	5554142
1987-89 WRANGLER	16719.13	3241807
1990-94 WRANGLER W/O ABS	16719.14	5252626
1994 YJ	16719.15	4762164
1995 YJ WRANGLER WITH OR W/O ABS	16719.16	4761940
1997-UP WRANGLER (ALL MODELS)	16719.17	4798157
1974-80 SJ WITH POWER	16719.18	8126953
1981-91 SJ	16719.19	8133316
1984-89 XJ CHEROKEE	16719.13	3241807
1990-94 XJ CHEROKEE W/O ABS	16719.20	5252622
1994 XJ W / ABS,	16719.15	4762164
1990-94 XJ CHEROKEE EXPORT MODELS ONLY (BOTH GAS OR DIESEL)	16719.21	5252624
1992-93 XJ CHEROKEE & ZJ GRAND CHEROKEE, WITH ABS	16719.22	4713076
1993-94 ZJ W / ABS	16719.15	4762164
1995-01 XJ CHEROKEE & ZJ GRAND CHEROKEE	16719.23	4761941

BRAKE MASTER CYLINDER REPAIR KITS:

1941-66 MB & CJ	16720.01	8126746
1967-71 CJ	16720.02	943069
1974-80 SJ	16720.03	8126731
1987-89 YJ WRANGLER	16720.04	8133913
1984-89 XJ CHEROKEE	16720.04	8133913
1972-78 CJ	16720.05	8127772



BRAKE MASTER CYLINDER MISC. ITEMS:

	Stock No.	Replaces
1941-66 ALL FLAT FENDERS & CJ'S, WASHER BETWEEN MASTER CYL & OUTLET FITTING	16721.06	637604
1941-66 ALL FLAT FENDERS & CJ'S, WASHER BETWEEN OUTLET FITTING & FITTING BOLT	16721.07	637606
1941-66 ALL FLAT FENDERS & CJ'S, MASTER CYL FITTING BOLT	16721.08	637605
1941-66 MASTER CYLINDER BOLT & WASHER KIT - 3 PCS	16721.09	637605K



FRONT BRAKE WHEEL CYLINDERS :

1941-53 MB, CJ LEFT OR RIGHT	16722.01	A-1484
1941-53 MB, CJ LEFT OR RIGHT (BRAND NAME)	16722.02	A-1484-USB
1954-65 CJ W/O ANGLE HOSE CONNECTION	16722.03	807356
1954-65 CJ W/O ANGLE HOSE CONNECTION (BRAND NAME)	16722.04	807356-USB
1963-66 CJ WITH 60 DEG ANGLE HOSE CONNECTION, LEFT	16722.05	803639
1963-66 CJ WITH 60 DEG ANGLE HOSE CONNECTION, RIGHT	16722.06	803640
1967-71 CJ BRAKE, 1" CYLINDER, LEFT OR RIGHT	16722.07	938115
1967-71 CJ 10" BRAKE, 1-1/8" CYLINDER, LEFT OR RIGHT	16722.08	991526
1972-77 CJ 11" BRAKE, LEFT	16722.09	8124795
1972-77 CJ 11" BRAKE, RIGHT	16722.10	8124794
1948-63 WAGON OR TRUCK 4-475, LEFT	16722.11	649947
1948-63 WAGON OR TRUCK 4-475, RIGHT	16722.12	649948



HARD PARTS

DESCRIPTION	REAR BRAKE WHEEL CYLINDERS:	Stock No.	Replaces
1941-49 MB, CJ, LEFT OR RIGHT		16723.01	A-6110
1941-49 MB, CJ, LEFT OR RIGHT (BRAND NAME)		16723.02	A-6110-USB
1950-66 CJ WITH 9" BRAKE, LEFT OR RIGHT		16723.03	8126798
1950-66 CJ WITH 9" BRAKE, LEFT OR RIGHT (BRAND NAME)		16723.04	8126798-USB
1967-71 CJ WITH 10" BRAKE, LEFT		16723.05	938116
1966-71 CJ WITH 10" BRAKE, RIGHT		16723.06	8136612
1972-75 CJ WITH 11" BRAKE, 15/16" CYL, LEFT		16723.07	8124798
1972-75 CJ WITH 11" BRAKE, 15/16" CYL, RIGHT		16723.08	8124799
1976-89 CJ,YJ WITH 10" OR 11" BRAKE, LEFT		16723.09	8126715
1976-89 CJ,YJ WITH 10" OR 11" BRAKE, RIGHT		16723.10	8126714
1990-00 WRANGLER (YJ & TJ) LEFT OR RIGHT		16723.11	4423601
1974-91 SJ LEFT OR RIGHT		16723.12	8129723
1948-63 WAGON OR TRUCK 4-475, LEFT		16723.13	802951
1948-63 WAGON OR TRUCK 4-475, RIGHT		16723.14	649941
1984-89 XJ CHEROKEE LEFT		16723.09	8126715
1984-89 XJ CHEROKEE RIGHT		16723.10	8126714
1991-98 XJ CHEROKEE & ZJ GRAND-CHEROKEE WITH 9" BRAKE W/O ABS, RH=LH		16723.11	4423601
1994-98 XJ CHEROKEE WITH 10", W/O ABS, LEFT		16723.09	8126715
1994-98 XJ CHEROKEE WITH 10", W/O ABS, RIGHT		16723.10	8126714
1990-98 XJ CHEROKEE AND ZJ GRAND CHEROKEE, WITH ABS & WITH 10" BRAKE, RH=LH		16723.18	4313056
2002 KJ LIBERTY		16723.19	5066158AA



WHEEL CYLINDER REPAIR KIT

MISC. WHEEL CYLINDERS:

1956-63 DJ-3A DISPATCH	16723.15	806041
1956-63 DJ-3A DISPATCH	16723.16	806042
POSTAL DJ FRONT	16723.20	8126712
POSTAL DJ REAR	16723.21	8126713

WHEEL CYLINDER REPAIR KITS:

ALL 3/4" CYLINDERS	16724.01	A-6133
ALL 13/16" CYLINDERS	16724.02	944363
ALL 7/8" CYLINDERS	16724.03	115963
ALL 1" CYLINDERS	16724.04	8126749
ALL 1-1/8" CYLINDERS	16724.05	807155
ALL 15/16" CYLINDERS	16724.06	8124793
REPAIR KIT FOR 16723.10 OR 16723.09	16724.07	TBA
REPAIR KIT FOR 16723.11 WHEEL CYLINDER	16724.08	TBA
REPAIR KIT FOR 16723.18 WHEEL CYLINDER	16724.09	TBA

BRAKE SHOE SETS, FRONT OR REAR
(PER SIDE) :

	Stock No.	Replaces
1941-53 MB, CJ 9" BRAKE, FRONT OR REAR	16726.01	642967
1953-66 CJ 9" BRAKE, FRONT OR REAR	16726.02	807376
1941-66 CJ 9" BRAKE, LINING SET WITH RIVETS (W/O STEEL)	16727.01	116600
1967-71 CJ 10" BRAKE, FRONT OR REAR	16726.03	991525
1972-78 CJ 11" BRAKE, FRONT OR REAR	16726.04	8130067
1978-86 CJ 10" BRAKE, REAR	16726.05	8130301
1987-89 YJ 10" BRAKE WITH DANA-35 REAR AXLE, REAR	16726.05	8130301
1990-00 WRANGLERS WITH DANA-35 AXLE & 9" BRAKE, REAR	16726.06	4423606
2001 & UP TJ WRANGLER WITH 9" BRAKE, REAR	16726.07	NR769
1987-92 WRANGLER WITH 10" BRAKE & WITH DANA-44 REAR AXLE, REAR	16726.08	83502385
POSTAL APPLICATIONS, FRONT	16726.09	5554952
POSTAL APPLICATION, REAR	16726.10	5554953
1948-63 11" STATION OR TRUCK 226	16726.11	918246
1977-91 SJ WAGONEER, REAR	16726.12	8127782
1974-90 J-20 TRUCK	16726.13	8130362
1984-89 XJ CHEROKEE WITH DANA-35 REAR AXLE, REAR	16726.05	8130301
1984-89 XJ CHEROKEE WITH DANA-44 REAR AXLE, REAR	16726.08	83502385
1990-00 XJ CHEROKEE & ZJ GRAND CHEROKEE, 9" BRAKE, REAR	16726.06	4423606
1994-01 XJ CHEROKEE & ZJ GRAND CHEROKEE, 10" BRAKE, REAR	16726.14	4713365
2001 XJ CHEROKEE WITH 9" BRAKE, REAR	16726.07	NR769
2002 KJ LIBERTY W / REAR DRUM BRAKE	16726.15	5066147AA



DESCRIPTION	FRONT DISC BRAKE PAD SETS:	Stock No.	Replaces
1976-78 CJ WITH 6 BOLT CALIPER PLATE, FRONT		16728.01	8126314
1978-81 CJ WITH 2 BOLT CALIPER PLATE, FRONT		16728.02	8131785
1982-86 CJ, SEMI-METALLIC, FRONT		16728.03	8133853
1987-89 WRANGLER, SEMI-METALLIC, FRONT		16728.03	8133853
1990-01 WRANGLER (BOTH YJ & TJ), SEMI-METALLIC, FRONT		16728.04	5252531
1984-89 XJ CHEROKEE, SEMI-METALLIC, FRONT		16728.03	8133853
1990-01 XJ CHEROKEE 4WD, SEMI-METALLIC, FRONT		16728.04	5252531
1990-96 XJ CHEROKEE 2WD, SEMI-METALLIC, FRONT		16728.03	8133853
1974-91 SJ, FRONT		16728.05	8124509
1993-98 ZJ GRAND CHEROKEE, FRONT SEMI-METALLIC		16728.04	5252531
1999-04 WJ GRAND CHEROKEE, FRONT TITANIUM		16728.06	5011969AA
1982-86 CJ, 1987-89 WRANGLER, 1984-89 XJ CHEROKEE + SHIM KIT, FRONT TITANIUM		16728.07	MXT203-SH
1990-04 WRANGLER (YJ & TJ), XJ CHEROKEE, SHIM SET, FRONT TITANIUM		16728.08	MXT477-SH
1993-98 ZJ GRAND CHEROKEE, INCLUDES SHIM SET, FRONT TITANIUM		16728.08	MXT477-SH
2002-UP KJ LIBERTY		16728.09	5066427AA



REAR DISC BRAKE PAD SETS:

1997-01 TJ WRANGLER & XJ CHEROKEE WITH REAR DISC BRAKE, SEMI-METALLIC		16729.01	MD666
2003-04 TJ WRANGLER REAR BRAKE PAD SET (MODELS W/ REAR DISC BRAKE)	NEW	16729.06	5093511AB
1994 ZJ GRAND CHEROKEE WITH REAR DISC BRAKE, SEMI-METALLIC		16729.02	MD625
1995-98 ZJ GRAND-CHEROKEE, REAR SEMI-METALLIC		16729.01	MD666
1999-04 WJ GRAND-CHEROKEE, REAR TITANIUM		16729.04	5011970AA
1997-01 TJ WRANGLER & XJ CHEROKEE WITH REAR DISC BRAKE, TITANIUM		16729.05	MXT666
1995-98 ZJ GRAND CHEROKEE, REAR TITANIUM		16729.05	MXT666
2003-UP KJ LIBERTY REAR BRAKE PAD SET (MODELS W/ REAR DISC BRAKE)	NEW	16729.07	5083882AC



FRONT REPLACEMENT BRAKE HOSES:

1941-71 FRONT "S" LINE		16732.50	A-1488
1941-66 MB & CJ, FRONT BRAKE TUBE TO FRONT WHEEL, 6"		16732.01	800953
1941-66 MB & CJ, CENTER, 11"		16732.02	800896
1966-71 CJ WITH 10" BRAKE, FRONT 11", LH OR RH		16732.03	937347
1972-73 CJ WITH 11" DRUM BRAKE, FRONT, LH OR RH		16732.04	5350663
1974-77 CJ WITH 11" DRUM BRAKE, FRONT, LH OR RH		16732.05	5356054
1976-78 CJ WITH DISC BRAKE, FRONT, LEFT OR RIGHT		16732.06	5356598
1978-81 CJ WITH DISC BRAKE, FRONT, LEFT OR RIGHT		16732.07	5359037
1982-83 CJ5 WITH DISC BRAKE, FRONT, LEFT OR RIGHT		16732.08	5363917
1982-86 CJ7, CJ8 WITH DISC BRAKE, FRONT, LEFT		16732.09	5363908
1982-86 CJ7, CJ8 WITH DISC BRAKE, FRONT, RIGHT		16732.10	5363756
1987-89 YJ WRANGLER, FRONT LEFT		16732.11	52002849
1987-89 YJ WRANGLER, FRONT RIGHT		16732.12	52002848
1990-95 YJ WRANGLER W/O ABS, LEFT		16732.13	52006473
1990-95 YJ WRANGLER W/O ABS, RIGHT		16732.14	52006472
1997-04 TJ WRANGLER, W/ OR W/O ABS, LEFT		16732.15	52008675
1997-04 TJ WRANGLER, W/ OR W/O ABS, RIGHT		16732.16	52008674
1984-89 XJ CHEROKEE, FRONT LEFT		16732.17	52001405
1984-89 XJ CHEROKEE, FRONT RIGHT		16732.18	52001404
1974-78 SJ, FRONT, LEFT OR RIGHT		16732.19	5352688



REAR REPLACEMENT BRAKE HOSES:

1941-71 MB & CJ, REAR BRAKE TUBE 15"		16733.01	800952
1972-75 CJ WITH 11" BRAKE, REAR		16733.02	5352824
1976-86 CJ, REAR		16733.03	5362842
1987-89 YJ WRANGLER, REAR		16733.05	52004152
1990-95 YJ WRANGLER, REAR		16733.05	52004152
1997-04 TJ WRANGLER, REAR		16733.06	52008391
1984-89 XJ CHEROKEE, BRAKE HOSE, REAR	NEW	16733.07	52000162
1990-91 XJ CHEROKEE, BRAKE HOSE, REAR	NEW	16733.08	52006861
1992-01 XJ CHEROKEE, BRAKE HOSE, REAR	NEW	16733.09	52007562AC
1993-98 ZJ GRAND-CHEROKEE, BRAKE HOSE, REAR	NEW	16733.10	52007401

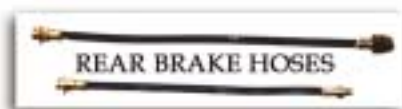

DESCRIPTION	EMERGENCY BRAKE CABLES & COMPONENTS:	Stock No.	Replaces
1945-49 CJ2A BEFORE SERIAL #183948, 42.25" CABLE		16730.01	640353
1949-53 CJ2A (FROM SERIAL #183948), CJ3A & ALL 44.5" CABLE		16730.02	646142
1955-71 CJ, ALL WITH 63-5/8" CABLE		16730.03	906750
1942-71 MB, M38 & ALL CJ'S E-BRAKE SHOE PAIR		16731.01	643055
1995-98 ZJ WITH 4 WHEEL DISC BRAKE, EMERGENCY BRAKE SHOE SET		16731.02	4796337
1999-2004 WJ GRAND CHEROKEE EMERGENCY BRAKE SHOE PAIR	NEW	16731.05	5011988AA
2002-KJ LIBERTY WITH 4 WHEEL DISC BRAKE, EMERGENCY BRAKE SHOE SET		16731.03	5093390AA
1942-71 MB, M38 & ALL CJ'S E-BRAKE SPRING (LEVEL END)		16755.01	A-10337
1942-71 MB, M38 & ALL CJ'S E-BRAKE SPRING (ADJUSTING END)		16755.02	A-10338
1972-75 CJ, FRONT CABLE		16730.04	999978
1972-75 CJ, REAR, LEFT OR RIGHT CABLE		16730.05	999980
1976-78 CJ WITH 11" BRAKE, REAR, RIGHT CABLE		16730.06	5355324
1976-78 CJ WITH 11" BRAKE, REAR, LEFT, CABLE		16730.07	5355325
1978-86 CJ WITH 10" BRAKE, REAR, RIGHT, CABLE		16730.08	3233904
1978-86 CJ WITH 10" BRAKE, REAR, LEFT, CABLE		16730.09	3233903
1987-90 YJ WRANGLER, FRONT PEDAL TO EQUALIZER, CABLE	NEW	16730.17	52003181
1987-89 YJ WRANGLER, REAR RH, CABLE	NEW	16730.18	52003182
1987-89 YJ WRANGLER, REAR LH, CABLE	NEW	16730.19	52003183
1990 YJ WRANGLER, REAR RH, CABLE	NEW	16730.20	52004706
1990 YJ WRANGLER, REAR LH, CABLE	NEW	16730.21	52004707
1991-95 YJ WRANGLER, FRONT PEDAL TO EQUALIZER, CABLE	NEW	16730.22	52007048
1991-95 YJ WRANGLER, REAR RH, CABLE	NEW	16730.24	52007522
1991-95 YJ WRANGLER, REAR LH, CABLE	NEW	16730.25	52007523
1997-04 (DRUM BRACKET) TJ REAR, LH=RH (MOUNTING BRACKET NOT INCLUDED)	NEW	16730.26	52008362
1987-89 XJ CHEROKEE, LH & RH, CABLE	NEW	16730.27	52003256
1990-91 XJ CHEROKEE, LH & RH, CABLE	NEW	16730.28	52004709
1992-96 XJ CHEROKEE, LH & RH, CABLE	NEW	16730.29	52008300
1997-01 XJ CHEROKEE, LH & RH, CABLE	NEW	16730.30	52128164AB
1993-98 ZJ GRAND-CHEROKEE, FRONT, CABLE	NEW	16730.31	52008232
1976-83 CJ5, FRONT PEDAL TO EQUALIZER, CABLE		16730.10	5355287
1976-86 CJ7, FRONT PEDAL TO EQUALIZER, CABLE		16730.11	5353238
1981-86 CJ8, FRONT PEDAL TO EQUALIZER, CABLE		16730.12	5355286
1976-86 CJ EMERGENCY BRAKE EQUALIZER, CABLE		16756.01	3222572
POSTAL JEEP, EMERGENCY BRAKE CABLE		16730.13	5567418
1984-86 XJ CHEROKEE, LEFT & RIGHT, EMERGENCY BRAKE CABLE	NEW	16730.32	52001153
1997-04 TJ WRANGLER FRONT EMERGENCY BRAKE CABLE	NEW	16730.33	52128206AD





MISC. BRAKE HOSE ITEMS:

DESCRIPTION	Stock No.	Replaces
BRAKE HOSE RETAINING CLIP	16736.01	637427
1977-81 BRAKE HOSE TO CALIPER BOLT	16736.02	3225703
1982-99 BRAKE HOSE TO CALIPER BOLT	16736.03	4006700



GOODRIDGE

FRONT & REAR BRAIDED STAINLESS STEEL BRAKE LINES:

(PROVIDES UP TO 4" EXTRA LENGTH. ESSENTIAL FOR LIFTED VEHICLES)

DESCRIPTION	Stock No.	Replaces
1955-71 CJ WITH DRUM BRAKES FRONT PAIR	16734.01	F45
1972-73 CJ WITH DRUM BRAKES FRONT PAIR	16734.02	F43
1974-75 CJ WITH DRUM BRAKES FRONT PAIR	16734.03	F42
1976-78 CJ WITH DRUM BRAKES FRONT PAIR	16734.04	F46
1976-81 CJ WITH DISC BRAKES FRONT PAIR	16734.05	F41
1982-86 CJ WITH DISC BRAKES FRONT PAIR	16734.06	F40
1987-95 YJ WRANGLER FRONT PAIR	16734.07	F47
1997-01 TJ WRANGLER FRONT PAIR	16734.08	F48
1955-66 CJ REAR SINGLE	16735.01	R45
1967-73 CJ SINGLE, REAR	16735.02	R43
1974-75 CJ SINGLE, REAR	16735.03	R42
1976-86 CJ SINGLE, REAR	16735.04	R40
1987-95 YJ WRANGLER REAR SINGLE	16735.05	R47
1997-01 TJ WRANGLER REAR SINGLE	16735.06	R48
1992-99 XJ CHEROKEE 4WD (3 LINE)	16735.09	FR50
1993-94 ZJ GRAND CHEROKEE W/ REAR DRUM (3 LINE)	16735.10	FR51
1993-94 ZJ GRAND CHEROKEE W/ REAR DISC (5 LINE)	16735.11	FR52

BRAKE LINE COILS & FITTING KITS (IN O.E. STEEL):

DESCRIPTION	Stock No.	Replaces
13/16 "X 0.028 TUBE, 25' COIL WITH 16 ASSORTED NUTS	16737.80	53K3
1/4 " X 0.028 TUBE, 25' COIL WITH 14 ASSORTED NUTS	16737.81	53K4
5/16 " X 0.028 TUBE, 25' COIL WITH 10 ASSORTED NUTS	16737.82	53K5
3/8 " X 0.028 TUBE, 25' COIL WITH 6 ASSORTED NUTS	16737.83	53K6



EARLY MODEL STEEL BRAKE LINE SETS:

DESCRIPTION	Stock No.	Replaces
1941-42 EARLY MB FULL LINE	16737.01	MS00101
1943-45 MB STD & GPW FULL LINE	16737.02	MS00100
1951-53 M38 FULL LINE	16737.03	MS00102
1953-68 M38A1 FULL LINE	16737.04	MS00103
1955-65 CJ5 FULL LINE	16737.05	MS00104
1946-55 CJ2A, CJ3A & VERY EARLY CJ3B WITH "S" LINE, FRONT AXLE BRAKE LINE	16737.06	MS01100
1946-47 CJ2A EARLY WITH REAR DANA-41 AXLE, REAR AXLE BRAKE LINE	16737.07	MS01101
1948-55 CJ2A, CJ3A & VERY EARLY CJ3B, WITH REAR DANA-44 AXLE, REAR AXLE LINE SET	16737.08	MS01102
1946-47 EARLY CJ2A, FRAME LINE SET	16737.09	MS01103
1948-55 CJ2A LATE, CJ3A, EARLY CJ3B, FRAME LINE SET	16737.10	MS01104
CJ3A (LATE MODEL), CJ3B (LATE MODEL) FRAME BRAKE LINE SET	16737.11	MS01105

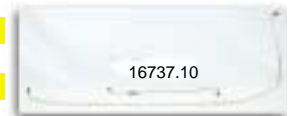

1967-86 CJ STAINLESS STEEL BRAKE LINE SETS:

(SEAMLESS 304 GRADE STAINLESS STEEL, DOUBLE ANNEALED TUBING)
(P=POWER, LP=LESS POWER, DR= FRONT DRUM BRAKE, DS=FRONT DISC BRAKE)

1967-68 CJ5, LP, DR	16737.30	531001E
1969-71 CJ5, LP, DR	16737.31	531001
1972-73 CJ5, LP, DR	16737.32	531004
1974-75 CJ5, LP, DR	16737.33	531015
1976-78 CJ5, LP, DR	16737.34	531002
1976-78 CJ5, P, DR	16737.35	531006
1977-80 CJ5, LP, DS	16737.36	531019
1977-80 CJ5, P, DS	16737.37	531021
1981-83 CJ5, LP, DS	16737.38	531023
1981-83 CJ5, P, DS	16737.39	531025
1976-78 CJ7 W/O QUADRATRAC, LP, DR	16737.40	531007
1976-78 CJ7 W/O QUADRATRAC, P, DR	16737.41	531008
1976-80 CJ7 W/O QUADRATRAC, LP, DS	16737.42	531005
1976-80 CJ7 W/O QUADRATRAC, P, DS	16737.43	531009
1981-86 CJ7 W/O QUADRATRAC, LP, DS	16737.44	531010
1981-86 CJ7 W/O QUADRATRAC, P, DS	16737.45	531011
1976-79 CJ7 WITH QUADRATRAC, LP, DR	16737.46	531029
1976-79 CJ7 WITH QUADRATRAC, P, DR	16737.47	531026
1976-79 CJ7 WITH QUADRATRAC, LP, DS	16737.48	531027
1976-79 CJ7 WITH QUADRATRAC, P, DS	16737.49	531028



HARD PARTS

DRUM BRAKE HOLD DOWN HARDWARE KITS:

Stock No. Replaces

1972-78 CJ WITH 11" BRAKE, FRONT OR REAR (PER AXLE)	16738.01	H7137
1978-86 CJ WITH 10" BRAKE, REAR (PER AXLE)	16738.02	H7064
1987-89 YJ WRANGLER WITH 10" BRAKE, REAR (PER AXLE)	16738.02	H7064
1990-00 WRANGLER (BOTH YJ & TJ), XJ & ZJ WITH 10" BRAKE, REAR (PER AXLE)	16738.03	H7170

DRUM BRAKE SELF-ADJUSTING HARDWARE KITS:

Stock No. Replaces

1972-78 CJ WITH 11" BRAKE, FRONT OR REAR, LEFT	16739.01	H2540
1972-78 CJ WITH 11" BRAKE, FRONT OR REAR, RIGHT	16739.02	H2541
1978-86 CJ WITH 10" BRAKE, REAR, LEFT	16739.03	H2514
1978-86 CJ WITH 10" BRAKE, REAR, RIGHT	16739.04	H2515
1987-89 YJ WRANGLER WITH 10" BRAKE & DANA-35, REAR, LEFT (ALSO 1984-89 XJ)	16739.03	H2514
1987-89 YJ WRANGLER WITH 10" BRAKE & DANA-35, REAR, RIGHT (ALSO 1984-89 XJ)	16739.04	H2515
1990-00 WRANGLER (YJ & TJ) XJ & ZJ WITH 9" BRAKE & DANA-35, REAR, LEFT	16739.05	H2526
1990-00 WRANGLER (YJ & TJ) XJ & ZJ WITH 9" BRAKE & DANA-35, REAR, RIGHT	16739.06	H2527



16745.02



16739.05



16739.04



16738.01



16738.02



16738.03

BRAKE CALIPERS:

1977-78 CJ WITH 6 BOLT CALIPER PLATE, RIGHT (REMAN.)	16744.02	3229983R
1977-78 CJ WITH 6 BOLT CALIPER PLATE, LEFT (REMAN.)	16744.01	3229982R
1978-81 CJ WITH 2 BOLT CALIPER PLATE, RIGHT (REMAN.)	16744.04	8131649R
1978-81 CJ WITH 2 BOLT CALIPER PLATE, LEFT (REMAN.)	16744.03	8131648R
1982-86 CJ, 1987-89 YJ WRANGLER & 1984-89 XJ CHEROKEE, RIGHT (REMAN.)	16744.06	8133846R
1982-86 CJ, 1987-89 YJ WRANGLER & 1984-89 XJ CHEROKEE, LEFT (REMAN.)	16744.07	8133847R
1990-00 WRANGLER (YJ & TJ), XJ CHEROKEE 4WD & ZJ GRAND CHEROKEE, RIGHT (NEW)	16745.02	5252984
1990-00 WRANGLER (YJ & TJ), XJ CHEROKEE 4WD & ZJ GRAND CHEROKEE, LEFT (NEW)	16745.01	5252985
2002-UP KJ LIBERTY RH CALIPER FRONT BRAKE	NEW 16745.04	5066422AA
2002-UP KJ LIBERTY LH CALIPER FRONT BRAKE	NEW 16745.05	5066423AA
1999-2004 WJ GRAND CHEROKEE, RH CALIPER FRONT BRAKE	NEW 16745.06	5093180AA
1999-2004 WJ GRAND CHEROKEE, LH CALIPER FRONT BRAKE	NEW 16745.07	5093181AA



16747.01



16748.01



16748.02



16748.03



16749.01



16749.02

BRAKE CALIPER PISTON & SEAL KITS (PER CALIPER):

1982-00 SEAL KIT (W/O PISTON), ALL CJ, WRANGLER, CHEROKEE, ZJ GRAND CHEROKEE	16746.01	8133852
2002-05 FRONT KJ LIBERTY (RH=LH) CALIPER SEAL	NEW 16746.02	5066426AA
1977-78 CJ WITH 6-BOLT CALIPER PLATE, PISTON+SEAL+BOOT	16747.01	8125534
1978-81 CJ WITH 2-BOLT CALIPER PLATE, PISTON+SEAL+BOOT	16747.02	8127582
1982-86 CJ, 1987-89 YJ WRANGLER, 1984-89 XJ CHEROKEE, PISTON+SEAL+BOOT	16747.03	8133845
1990-04 WRANGLER, XJ CHEROKEE, ZJ GRAND CHEROKEE, PISTON+SEAL+BOOT	16747.04	5252614
2002-UP KJ LIBERTY PISTON, FRONT CALIPER	NEW 16746.50	5066425AA
1999-2004 WJ GRAND CHEROKEE, CALIPER PISTON-SEAL-BOOT	NEW 16747.05	5093186AA

BRAKE CALIPER HARDWARE KITS (PART #'S ARE FOR EACH SIDE):

1976-78 CJ WITH 6 BOLT CALIPER PLATE, CALIPER H/W KIT	16748.01	H5510
1978-81 CJ WITH 2 BOLT CALIPER PLATE, CALIPER H/W KIT	16748.02	H5527
1982-86 CJ, CALIPER HARDWARE KIT	16748.03	H5541
1987-89 YJ WRANGLER & XJ CHEROKEE (1984-89), CALIPER HARDWARE KIT	16748.03	H5541
1990-00 WRANGLER (YJ & TJ), XJ CHEROKEE, ZJ GRAND CHEROKEE, CALIPER H/W KIT	16748.04	H5605
1999-04 WJ GRAND CHEROKEE CALIPER HARDWARE	NEW 16748.05	5093184AA

MISC. BRAKE CALIPER HARDWARE:

1976-81 CJ, CALIPER BOLT	16749.01	H5019
1982-86 CJ, CALIPER BOLT	16749.02	H5015
1987-89 YJ WRANGLER, CALIPER BOLT	16749.02	H5015
1982-00 CJ, WRANGLER (YJ & TJ), XJ CHEROKEE, ZJ GRAND CHEROKEE, BLEEDER SCREW	16749.03	3203313
1982-00 CJ, WRANGLER (YJ & TJ), XJ CHEROKEE, ZJ GRAND CHEROKEE, ANTI-RATTLE CLIP	16749.04	3239865
1982-89 CJ, YJ WRANGLER, XJ CHEROKEE, CALIPER BUSHING	16749.05	52001700
1990-00 WRANGLER (YJ & TJ), XJ CHEROKEE, ZJ GRAND CHEROKEE, CALIPER BUSHING	16749.06	4383471
1982-89 CJ, YJ WRANGLER, XJ CHEROKEE, CALIPER SLEEVE	16749.07	52001701
1990-00 WRANGLER (YJ & TJ), XJ CHEROKEE, ZJ GRAND CHEROKEE, CALIPER SLEEVE	16749.08	4423573
1990-00 WRANGLER (YJ & TJ), XJ CHEROKEE, ZJ GRAND CHEROKEE, CALIPER PIN	16749.09	5253000

DESCRIPTION BRAKE DUST SHIELD (PAIR):

DESCRIPTION	Stock No.	Replaces
1976-78 CJ WITH 6 BOLT CALIPER PLATES, BLACK POWDER	11212.01	5363379EK
1976-78 CJ WITH 6 BOLT CALIPER PLATES, STAINLESS STEEL	11212.01	5363379EK-ST
1978-86 CJ WITH 2 BOLT CALIPER PLATES, BLACK POWDER	11212.02	5363379K
1978-86 CJ WITH 2 BOLT CALIPER PLATES, STAINLESS STEEL	11212.02	5363379K-ST



MISC BRAKE PARTS 1941-71 CJ:

1941-53 MB, CJ2A, 3A & M38 ANCHOR CAM FOR BRAKE SHOES (EACH)	16750.01	637900
MB, CJ-2A, CJ-3A, M38, BRAKE SHOE ANCHOR PIN KIT	16750.02	637899K
1953-66 CJ WITH 9", HOLD DOWN KIT (PER WHEEL)	16750.03	120239
1941-71 CJ, BRAKE PEDAL	16750.04	800527
1941-71 CJ BRAKE PEDAL RUBBER PAD	16753.01	948758
1941-71 CJ, BRAKE PEDAL RETURN SPRING	16750.06	630593
1941-71 CJ BRAKE PEDAL IDLER SHAFT	16750.07	A-495
1941-71 FRONT AXLE SHAFT DRIVE FLANGE	16750.08	A-868
1941-71 ALL MODELS PEDAL DRAFT PAD KIT	16750.09	A-6359K
1948-63 WAGONS & TRUCKS, ECCENTRIC BRAKE BOLT	16750.10	648347
1948-63 WAGONS & TRUCKS, ECCENTRIC BRAKE NUT	16750.11	648348
MB, GPW BRAKE PEDAL	16750.12	A-1359
1941-66 MB, M38, M38A, ALL C.J.'s. UPPER SPRING FOR BRAKE SHOE RETURN	16750.13	637905
1955-65 CJ3B, CJ5, CJ6 AND M38A1. BRAKE SHOE AND ANCHOR END SPRING(SHORT)	NEW 16750.14	805602



MISC BRAKE PARTS FOR 1972-99:

1978-00 CJ & WRANGLER WITH 10" BRAKE, SHOE RETAINING PLATE	16751.01	3201032
1978-89 CJ & WRANGLER WITH 10" BRAKE, WHEEL CYLINDER LINK	16751.02	48331
1972-78 CJ WITH 11" BRAKE, EMERGENCY BRAKE LEVER, RIGHT SIDE	16751.04	937964
1972-78 CJ WITH 11" BRAKE, EMERGENCY BRAKE LEVER, DRIVER SIDE	16751.03	937965
1972-78 CJ WITH 11" BRAKE, EQUALIZER BAR LH=RH	16751.05	937966
1978-89 CJ & YJ WITH 10" BRAKE, E-BRAKE EQUALIZER BAR	16751.06	83502899
1972-95 CJ & YJ, EMERGENCY BRAKE PEDAL RUBBER PAD	16751.07	3220433
1972-86 CJ & YJ, BRAKE PEDAL RUBBER PAD	16753.01	948758
1987-UP WRANGLER & XJ CHEROKEE AUTOMATIC TRANSMISSION, PEDAL PAD	16753.02	52002749
1987-UP WRANGLER & XJ CHEROKEE MANUAL TRANSMISSION, PEDAL PAD	16753.03	52002750
1977-81 CJ BRAKE HOSE WASHER	NEW 16751.09	3227849
1982-01 CJ, YJ, TJ BRAKE HOSE WASHER	16751.10	3236434
1987-95 YJ EMERGENCY BRAKE CABLE CLIP	16751.11	3217581
1987-89 YJ, 1984-89 XJ EMERGENCY BRAKE LEVER, RH	16751.12	83504306
1987-89 YJ, 1984-89 XJ EMERGENCY BRAKE LEVER, LH	16751.13	83504307
1987-92 YJ, 1987-90 XJ. EMERGENCY BRAKE EQUALIZER	16751.14	52001154



MISC DRUM BRAKE HARDWARE FOR 1982-89 MODELS:

DESCRIPTION	Stock No.	Replaces
1982-89 CJ, WRANGLER & XJ CHEROKEE, SHOE HOLD DOWN CUP	16752.01	89259
1982-89 CJ, WRANGLER & XJ CHEROKEE, SHOE HOLD DOWN SPRING	16752.02	3205979
1982-89 CJ, WRANGLER & XJ CHEROKEE, EQUALIZER SPRING	16752.03	3112779
1982-89 CJ, WRANGLER & XJ CHEROKEE, RETURN SPRING	16752.04	3112780
1982-89 CJ, WRANGLER & XJ CHEROKEE, SELF ADJUSTING LEVER, LH	16752.05	3201029
1982-89 CJ, WRANGLER & XJ CHEROKEE, SELF ADJUSTING LEVER, RH	16752.06	3201030
1982-89 CJ, WRANGLER & XJ CHEROKEE, ADJUSTING CABLE	16752.07	3201027
1982-89 CJ, WRANGLER & XJ CHEROKEE, ADJUSTING CABLE GUIDE	16752.08	3201947
1982-89 CJ, WRANGLER & XJ CHEROKEE, ADJUSTING SCREW KIT, LH	16752.09	52001215
1982-89 CJ, WRANGLER & XJ CHEROKEE, ADJUSTING SCREW KIT, RH	16752.10	52001216
1982-89 CJ, WRANGLER & XJ CHEROKEE, SPRING BRAKE	16752.11	3201937

MISC DRUM BRAKE HARDWARE FOR 1990-00 MODELS:

1990-99 WRANGLER (YJ & TJ), XJ CHEROKEE, ZJ GRAND CHEROKEE 9", HOLD DOWN SPRING	16752.12	4313062
1990-99 WRANGLER (YJ & TJ), XJ CHEROKEE, ZJ GRAND CHEROKEE 9", CABLE GUIDE LH=RH	16752.13	2260793
1990-99 WRANGLER (YJ & TJ), XJ CHEROKEE, ZJ GRAND CHEROKEE 9", RETURN SPRING LH=RH	16752.14	2881676
1990-99 WRANGLER (YJ & TJ), XJ CHEROKEE, ZJ GRAND CHEROKEE 9", ADJUSTING SCREW KIT RH	16752.15	2881686K
1990-99 WRANGLER (YJ & TJ), XJ CHEROKEE, ZJ GRAND CHEROKEE 9", ADJUSTING SCREW KIT LH	16752.16	2881687K
1990-99 WRANGLER (YJ & TJ), XJ CHEROKEE, ZJ GRAND CHEROKEE 9", ADJUSTING CABLE RH=LH	16752.17	3461662
1990-99 WRANGLER (YJ & TJ), XJ CHEROKEE, ZJ GRAND CHEROKEE 9", SELF ADJUST LEVER LH=RH	16752.18	3461665
1990-99 WRANGLER (YJ & TJ), XJ CHEROKEE, ZJ GRAND CHEROKEE 9", BRAKE SPRING	16752.19	4423085
1990-99 WRANGLER (YJ & TJ), XJ CHEROKEE, ZJ GRAND CHEROKEE 9", EQUALIZER SPRING	16752.20	4713079
1993-98 XJ CHEROKEE & ZJ GRAND CHEROKEE, 10" BRAKE, ADJUSTING CABLE	16752.21	4713350
1993-98 XJ CHEROKEE & ZJ GRAND CHEROKEE, 10" BRAKE, ADJUSTING LEVER RH	16752.22	4728546
1993-98 XJ CHEROKEE & ZJ GRAND CHEROKEE, 10" BRAKE, ADJUSTING LEVER LH	16752.23	4728547
1993-98 XJ CHEROKEE & ZJ GRAND CHEROKEE, 10" BRAKE, RETURN SPRING	16752.04	3112780

16902.01
MASTER CLUTCH
KIT



16901.09 - REGULAR CLUTCH KIT



16903.03 - JUNIOR CLUTCH KIT



CLUTCH KITS:

MODEL	CLUTCH KIT REGULAR		CLUTCH KIT MASTER		CLUTCH KIT JUNIOR	
1946-67 CJ, 4-134, 8 1/2"	16901.01	930731K	16902.01	9307317KM	--	
1967-71 CJ, 4-134, 9 1/4 "	16901.02	921977K	16902.02	921977KM	--	
1980-83 CJ, 4 CYL GM 151	16901.03	8132577K	16902.03	8132577KM	--	
1983-86 CJ, 4 CYL AMC 150	16901.04	53002711K	16902.04	53002711KM	--	
1972-75 & 1980-83 CJ 11"	16901.05	3184867K	16902.05	3184867KM	--	
1972-75 CJ, 6 OR 8 CYL, 10.50"	16901.06	3184909K	16902.06	3184909KM	--	
1976-79 CJ, 6 OR 8 CYL, 10.50"	16901.07	5354689K	16902.07	5354689KM	--	
1980-81 CJ, 6 OR 8, CYL 10.50"	16901.08	5360174K	16902.08	5360174KM	--	
1982-86 CJ, 6 OR 8 CYL, 10.50"	16901.09	3240278K	16902.09	3240278KM	--	
1987-90 4 CYL WRANGLER, XJ CHEROKEE	16901.10	53004538K	16902.10	XY8790F	--	
1991-92 4 CYL WRANGLER, XJ CHEROKEE	16901.11	4626213KA	16902.11	XY1991F	16903.01	4626213
1993 4 CYL WRANGLER, XJ CHEROKEE	16901.12	4626213KB	16902.12	XY1993F	16903.01	4626213
1994-01 4 CYL WRANGLER, XJ CHEROKEE	16901.13	4626213K	16902.13	TXY9499F	16903.01	4626213
1991-96 4 CYL 2.1L XJ CHEROKEE DIESEL	16901.14	4637112K	--	--	16903.02	4637112
1987-89 6 CYL WRANGLER, XJ CHEROKEE PEUGEOT	16901.15	53004116K	16902.15	XY8789SP	16903.03	4713323
1989-91 6 CYL WRANGLER, XJ CHEROKEE AISIN	16901.16	4713323KA	16902.16	XY89905A	16903.03	4713323
1992 6-CYL. WRANGLER, XJ CHEROKEE	16901.16	4713323KA	16902.17	XY1992S	16903.03	4713223
1993 6 CYL WRANGLER, XJ CHEROKEE	16901.17	4713323KB	16902.18	XY1993S	16903.03	4713223
1994-99 6 CYL WRANGLER (YJ & TJ), XJ CHEROKEE	16901.18	4713323K	16902.19	TXYZ9449S	16903.03	4713323
2001-UP 4.0L TJ & XJ	16901.19	5015606AAK	--	--	16903.04	5015606AA
2002-UP 3.7 L 6 CYL LIBERTY	16901.20	5066375K	--	--	16903.05	5066375AB
2002-UP 2.4 L LIBERTY	16901.21	5072990K	--	--	16903.06	5072990AB
1993-98 6 CYL ZJ GRAND-CHEROKEE	16901.18	4713323K	16902.19	TXYZ9499S	16903.03	4713323
2003 4-CYL TJ , KJ					16903.07	5093973AA NEW

REGULAR CLUTCH KIT = COVER, DISC AND BEARING W/SLEEVE OR HYDRAULIC CONTROL UNIT
 MASTER CLUTCH KIT = REGULAR KIT (ABOVE) + FORK AND PILOT BEARING
 JUNIOR CLUTCH KIT = COVER AND DISK ONLY
 (FORK NOT AVAILABLE WHEN SLAVE CYLINDER USED)

CLUTCH PARTS:

HARD PARTS



MODEL	COVER		DISC		BEARING	
	STOCK NO.	REPLACES	STOCK NO.	REPLACES	STOCK NO.	REPLACES
1946-67 CJ, 4-134, 8 1/2"	16904.01	906467	16905.01	930731	16906.01	945255
1967-71 CJ, 4-134, 9 1/4"	16904.02	944741	16905.02	921977	16906.01	945255
1980-83 CJ, 4 CYL GM 151	16904.03	8132576	16905.03	8132577	16906.02	5361614
1983-86 CJ, 4 CYL AMC 150	16904.04	53002711	16905.04	53004538	16906.03	53000175
1972-75 & 1980-83 CJ, 11"	16904.05	5357436	16905.05	3184867	16906.04	3236561
1972-75 CJ, 6 OR 8 CYL, 10.50"	16904.06	3181383	16905.06	53004679	16906.05	5356918
1976-79 CJ, 6 OR 8 CYL, 10.50"	16904.06	3181383	16905.13	5354689	16906.04	3236561
1980-81 CJ, 6 OR 8 CYL, 10.50"	16904.06	3181383	16905.06	53004679	16906.04	3236561
1982-86 CJ, 6 OR 8 CYL, 10.50"	16904.07	3240277	16905.06	53004679	16906.04	3236561
1987-90 4 CYL WRANGLER, XJ CHEROKEE	16904.08	53003006	16905.04	53004538	16906.04	3236561
1991-92 4 CYL WRANGLER, XJ CHEROKEE	16904.09	4626213C	16905.07	53007584	16906.04	3236561
1993 4 CYL WRANGLER, XJ CHEROKEE	16904.09	4626213C	16905.07	53007584	16909.04	83503384
1994-01 4 CYL WRANGLER (YJ & TJ), XJ CHEROKEE	16904.09	4626213C	16905.07	53007584	16909.04	83503384
1991-96 4 CYL 2.1L XJ CHEROKEE DIESEL	16904.10	J0723977	16905.08	J0729376	16906.07	53001162
2002-UP 4 CYL 2.4 L LIBERTY	16904.11	52104582AB	16904.15	52104581AB	16909.04	83503384
1987-89 6 CYL WRANGLER, XJ CHEROKEE PEUGEOT	16904.12	53004678	16905.06	53004679	16909.03	83503383
1990-92 6 CYL WRANGLER, XJ CHEROKEE AISIN	16904.12	53004678	16905.06	53004679	16909.05	5252137
1993 6 CYL WRANGLER, XJ CHEROKEE	16904.12	53004678	16905.06	53004679	16909.06	4728735
1994-99 6 CYL WRANGLER (YJ & TJ), XJ CHEROKEE	16904.12	53004678	16905.06	53004679	16906.06	53008342
2001-UP 4.0L XJ & TJ	16904.13	52104045	16905.10	52104363AA	16906.06	53008342
2002-UP 3.7L 6 CYL LIBERTY	16904.14	52104584AB	16905.11	52104585AB	16906.06	53008342
2002-UP 2.4L LIBERTY	16904.15	52104581AB	16905.11	52104585AB	16906.06	53008342
1993-98 6 CYL ZJ GRAND-CHEROKEE	16904.12	53004678	16905.06	53004679	16906.06	53008342
2003 4-CYL TJ CLUTCH COVER ASSY. NEW	16904.18	5093973-C	16904.15	52104581AB		

CLUTCH MASTER & SLAVE CYLINDER KIT:

DESCRIPTION	Stock No.	Replaces
1994-95 4 OR 6 CYL YJ WRANGLER	16907.01	52104113
1997-04 4 OR 6 CYL WRANGLER (LEFT HAND DRIVE)	16907.02	52107652AC
1997-99 TJ WRANGLER (RIGHT HAND DRIVE)	16907.03	52107653AB
2000-01 TJ WRANGLER (RIGHT HAND DRIVE)	16907.04	52107653AC
1994-96 4 OR 6 CYL XJ CHEROKEE	16907.05	52107600
1994-96 4 OR 6 CYL XJ CHEROKEE (RIGHT HAND DRIVE XJ'S)	16907.06	52104111
1997 XJ CHEROKEE (4 or 6 CYL) (LEFT HAND DRIVE)	16907.07	52107654
1998-99 XJ CHEROKEE (4 or 6 CYL) (LEFT HAND DRIVE)	16907.08	52107654AB
2000-01 XJ CHEROKEE (4 or 6 CYL) (LEFT HAND DRIVE)	16907.09	52119686AA
1997-01 XJ CHEROKEE DIESEL (RIGHT HAND DRIVE)	16907.10	52107657AB
2000-01 XJ CHEROKEE (4 or 6 CYL) (RIGHT HAND DRIVE)	16907.11	52119687AA
1993-98 6 OR 8 CYL ZJ GRAND-CHEROKEE	16907.12	52107624



CLUTCH MASTER CYLINDERS:

DESCRIPTION	Stock No.	Replaces
1983-86 4 CYL CJ	16908.01	5359822
1980-86 6 OR 8 CYL CJ	16908.01	5359822
1987-90 4 OR 6 CYL YJ WRANGLER	16908.02	53004466
1991-95 4 OR 6 CYL YJ WRANGLER (MASTER ONLY)	16908.03	4636865
1994-96 4 OR 6 CYL YJ WRANGLER (MASTER ONLY)	16908.04	52107642
1984-85 4 OR 1984 V6 XJ CHEROKEE	16908.05	52000068
1986 4 CYL, 1985-86 V6, 1985-86 DIESEL XJ CHEROKEE	16908.06	53001163
1987-90 4 OR 6 CYL & 1987-90 DIESEL XJ CHEROKEE	16908.07	53004467
1991-93 ALL XJ CHEROKEE	16908.08	4636864
1994-96 ALL XJ CHEROKEE (MASTER ONLY)	16908.09	52107640
1993-96 ZJ GRAND CHEROKEE CLUTCH MASTER CYLINDER (W / O SLAVE CYL)	16908.10	52104624MC
1997-UP TJ WRANGLER & XJ CHEROKEE	16908.11	52107652MC



CLUTCH SLAVE CYLINDERS:

1976-83 4 CYL (GM ENGINE) OR DIESEL CJ	16909.01	3241867
1983-86 4 CYL CJ AMC 150	16909.02	52000070
1984-86 4 OR 6 (2.8L) XJ CHEROKEE	16909.02	52000070
1984-96 4 CYL DIESEL XJ CHEROKEE	16909.01	3241867
1980-86 6 OR 8 CYL CJ CHEROKEE	16909.04	83503384
1987-92 4 CYL YJ WRANGLER, XJ CHEROKEE	16909.04	83503384
1987-89 6 CYL YJ WRANGLER, XJ CHEROKEE (W/ PEUGEOT TRANS.)	16909.03	83503383
1989-92 6 CYL YJ WRANGLER, XJ CHEROKEE (W/ AISIN TRANS.)	16909.05	5252137
1993 4 OR 6 CYL YJ WRANGLER, XJ CHEROKEE	16909.06	4728735
1994-99 ALL WRANGLER (YJ & TJ), XJ CHEROKEE & ZJ GRAND-CHEROKEE	16909.07	52107640S
1997-01 TJ WRANGLER CLUTCH SLAVE CYL (RIGHT HAND DRIVE)	16909.08	52107653S

PILOT BUSHINGS & BEARINGS:

DESCRIPTION	Stock No.	Replaces
1941-71 4 CYL 134	16910.01	639578
1980-83 4 CYL. CJ W/ GM151	16910.02	8132261
1983-99 4 CYL CJ, WRANGLER (YJ & TJ), XJ CHEROKEE	16910.03	3250005
1972-76 6 OR 8 CYL	16910.04	3213751
1976-79 6 OR 8 CYL	16910.05	3222723
1982-86 6 OR 8 CYL	16910.06	3236726
1987-91 6 CYL	16910.07	33004041
1992-00 6 CYL WRANGLER (YJ & TJ), XJ CHEROKEE, ZJ GRAND-CHEROKEE	16910.08	53009181
1993-96 V8 ZJ W/ MANUAL TRANNY	NEW 16910.10	53009180
2003-04 2.4L TJ, 2002-04 2.4L KJ	NEW 16910.11	52104337AA
2001-04 4.0L TJ, 2000-01 2.5L TJ, 2002-04 3.7L KJ	NEW 16910.12	53009180AB



FLYWHEEL RINGS, MANUAL TRANS.:

DESCRIPTION	Stock No.	Replaces
1941-49 MB, CJ2A 4-134	16911.01	635394
1953-71 CJ 4-134	16911.02	802925
1983-96 4 CYL CJ, YJ WRANGLER & XJ CHEROKEE	16911.03	3241718
1967-71 CJ V6-225	NEW 16911.04	1359081
1965-71 SJ 6-CYL	16911.05	3172419
1972-90 6 CYL CJ & YJ WRANGLER	16911.06	3179741
1991-99 6 CYL WRANGLER (YJ & TJ)	16911.06	3179741
1987-99 6 CYL XJ CHEROKEE & ZJ GRAND CHEROKEE	16911.06	3179741
1972-92 8 CYL AMC CJ, SJ	16911.06	3179741

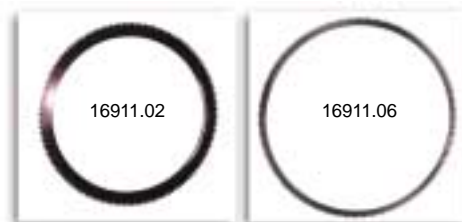

FLYWHEELS, MANUAL TRANS.:

DESCRIPTION	Stock No.	Replaces
1991-95 4 CYL 134	16912.01	805454
1991-95 2.5L ALL	16912.02	53005526
1972-79 6 CYL 232 OR 258	16912.04	3236257
1980-81 6 CYL 258	16912.04	3236257
1982-87 4.2L	16912.05	3240094
1988-90 4.2L YJ WRANGLER	16912.06	33002672
1991-95 4.0L ALL	16912.07	53005524
1972-91 AMC V8 360	16912.08	3196929
1972-79 AMC V8 401	16912.09	3212655
1972-86 CJ W/ GM V8 CONVERSION, 168 TEETH	16912.10	3991469



FLYWHEELS, AUTOMATIC TRANS.:

DESCRIPTION	Stock No.	Replaces
1976-79 CJ 6-CYL 258	16913.01	5351819
1976-79 CJ 8-CYL AMC 304	16913.02	5351820
1976-79 CJ 8-CYL AMC 360	16913.03	5351821
1976-79 CJ 8-CYL AMC 401	16913.04	5351822
1980-86 CJ 6-CYL 258	16913.05	3232138
1980-86 CJ & SJ 8 CYL 304, 360	16913.06	3232139
DJ POSTAL JEEP APPLICATIONS	16913.07	5900002
1970-85 WITH CHEVY V8 CONVERSION	16913.08	340296
1988-93 V8	NEW 16913.09	33004361
1987-90 4.0L XJ CHEROKEE	NEW 16913.11	33002675
1991-95 4.0L XJ FLEX PLATE	NEW 16913.10	52117761



CLUTCH FORKS:

1941-71 4 CYL 134 MB, M38, M38A1 AND ALL CJ'S	16914.01	630112
1947-55 4 CYL 475 4WD UTILITY WAGON	16914.02	641275
1980-83 4 CYL GM 151	16914.03	5361620
1967-71 6 CYL V6-225	16914.04	1378486
1972-75 6 OR 8 CYL CJ	16914.05	3217480
1976-86 6 OR 8 CYL CJ	16914.06	3224192
1994-99 4, 6 CYL WTANGLER (YJ & TJ), XJ CHEROKEE	16914.07	52107555
1994-98 6 OR 8 CYL ZJ GRAND-CHEROKEE	16914.07	52107555



CLUTCH PEDAL COVERS:

1946-86 CJ	16753.01	948758
1987-UP WRANGLER & CHEROKEE WITH MANUAL SHIFT	16753.03	52002750
1987-UP WRANGLER & CHEROKEE WITH AUTOMATIC	16753.02	52002749

BELLHOUSINGS AND COMPONENTS:

1976-86 6 OR 8 CYL CJ WITH T150 OR T176 TRANSMISSION	16916.01	8133951
1980-86 CJ WITH SR4, T4, T5	16916.02	3236287
1974-86 6 OR 8 CYL CJ, MANUAL OR AUTO, CLUTCH HOUSING COVER	16917.01	3213744
1974-86 6 OR 8 CYL CJ, MANUAL OR AUTO, CLUTCH-ENGINE SPACER	16917.02	3213743



CLUTCH FORK BOOTS:

1972-75 CJ 6 OR 8 CYL.	16918.01	3173646
1976-79 CJ 6 OR 8 CYL.	16918.02	3180370
1980-86 CJ 6 OR 8 CYL.	16918.03	3236453

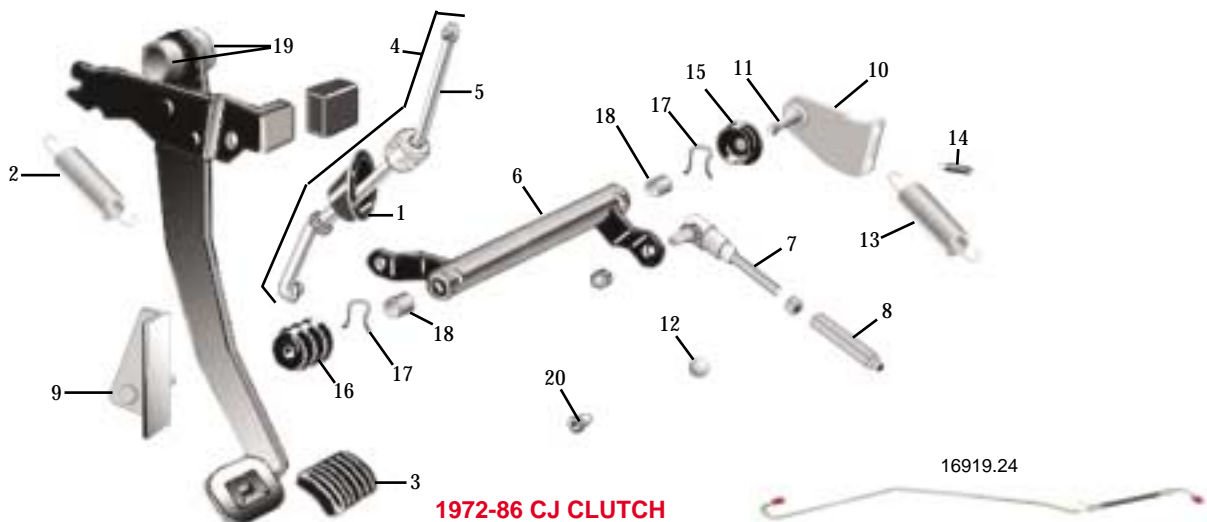

1972-86 CJ CLUTCH LINKAGE COMPONENTS:



ITEM #	DESCRIPTION	Stock No.	Replaces
	1976-86 BELLCRANK KIT CONTAINS #'S: 1, 5-16, & 2 OF BOTH #17 & #18	16919.01	5360104K
1	1976-86 ROD BOOT	16919.02	5355322
2	1972-86 CJ CLUTCH PEDAL RETURN SPRING	16919.03	5351118
3	1972-86 ALL CLUTCH PEDAL COVER	16753.01	948758
4	1972-75 6 OR 8 CYL CJ CLUTCH ROD ASM	16919.04	5351302K
5	1976-86 CJ PEDAL TO BELLCRANK ROD	16919.05	5364620
6	1972-75 CJ BELLCRANK	16919.06	5351292
6	1976-86 CJ BELLCRANK	16919.07	5360104
7	1972-86 CJ LOWER CLUTCH ROD	16919.08	8126668
8	1972-86 CJ CLUTCH ROD ADJUSTER	16919.09	5351209
9	1976-86 CJ BODY BRACKET W/PIVOT STUD	16919.10	5355339
10	1976-86 CJ BELLHOUSING BRACKET W/STUD	16919.11	5355332
11	1972-75 CJ BELLCRANK PIVOT STUD ONLY	16919.12	944666
12	1972-86 CJ CLUTCH FORK PIVOT BALL	16919.13	G169162
13	1972-86 CJ CLUTCH FORK RETURN OUTER SPRING	16919.14	5351252
14	1972-75 6 OR 8 CYL CJ FORK INNER SPRING	16919.15	3199503
14	1976-86 6 OR 8 CYL CJ FORK INNER SPRING	16919.16	3222799
15	1972-86 CJ BELLCRANK INNER BOOT	16919.17	3170937
16	1972-86 CJ BELLCRANK OUTER BOOT	16919.18	3167049
17	1972-86 CJ CLIP, BELLCRANK (NEED 2)	16919.19	3169769
18	1972-86 CJ BELLCRANK PLASTIC BUSHING (NEED 2)	16919.20	3167067
19	1972-81 CJ CLUTCH PEDAL BEARING (NEED 2) 6 OR 8 CYL.	16919.21	949169
19	1981-95 CJ & YJ WRANGLER CLUTCH PEDAL BUSHING (2 NEEDED)	16919.22	946177
20	1980-86 4 OR 6 CYL CJ CLUTCH SLAVE PLASTIC PIVOT	16919.23	3217479
21	1980-86 CLUTCH MASTER CYLINDER HOSE (EXCEPT 4 CYL W/150 AMC ENGINE)	16919.24	5361469
	1980-86 CJ SPRING, SLAVE CYLINDER RETURN	16919.25	3236804

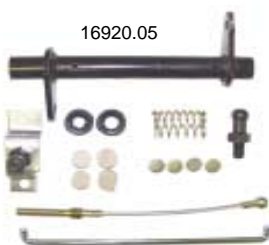

1941-71 4CYL. CLUTCH LINKAGE COMPONENTS:

DESCRIPTION	Stock No.	Replaces
1941-71 4 OR V6 ALL, CLUTCH PEDAL	16920.01	A-405
1941-71 4 OR V6 ALL, SPRING, PEDAL RETURN	16750.06	630593
1946-71 ALL CLUTCH PEDAL COVER	16953.01	948758
1941-71 4 CYL ALL, CLUTCH T/O SPRING	16920.03	630117
1941-71 ALL 4 CYL CROSS-SHAFT	16920.04	642624
1941-45 MB, BELLCRANK KIT	16920.05	642624K-1
1946-71 4 CYL CJ, BELLCRANK KIT	16920.06	642624K-2
1941-71 ALL 4 CYL, CROSS-SHAFT HOLD BRACKET	16920.07	645086
1941-71 ALL 4 CYL IDLER CROSS-SHAFT FELT	16920.08	A-176
1941-71 ALL 4 CYL IDLER CROSS-SHAFT PLATE	16920.09	A-177
1941-71 ALL 4 CYL IDLER CROSS-SHAFT SPRING	16920.10	A-178

DESCRIPTION	Stock No.	Replaces
1941-71 ALL 4 CYL IDLER CROSS-SHAFT BOOT	16920.11	A-887
1941-45 MB, CABLE, BELLCRANK TO T10	16920.12	A-5102
1946-71 ALL 4 CYL CABLE, BELLCRANK TO T/O	16920.13	640124
1941-45 MB, CLUTCH ROD	16920.14	A-499
1946-71 4 CYL CJ CLUTCH ROD	16920.15	640123
1946-71 CJ, CLUTCH LINKAGE YOKE	16920.16	632177
1946-71 CJ, PEDAL DRAFT PAD KIT	16750.09	A-6359K
MB, GPW CLUTCH FOOT PEDAL	16920.18	A-1360



16920.18

FLEX-A-LITE COOLING PRODUCTS:

DESCRIPTION

1973-86 CJ (6 or 8 CYL) WITH 2" THICK RADIATOR, ELECTRIC PULLER FAN KIT W/ADJUSTABLE THERMOSTAT	FAL-575
1987-01 WRANGLER (4 or 6 CYL) WITH 18"x16"x4.25" RADIATOR, ELECTRIC PULLER FAN KIT W/ADJUSTABLE THERMOSTAT	FAL-475
REPLACEMENT BRACKET FOR P/N # FAL-475 WHEN USED ON 4 CYL WRANGLER	FAL-30927
REPLACEMENT BRACKET FOR P/N # FAL-475 WHEN USED ON 6 CYL WRANGLER	FAL-30928
1994-98 ZJ GRAND CHEROKEE (V8) ELECTRIC PULLER FAN KIT (REQUIRES FAL-504 SPACER)	FAL-150
1987-99 XJ CHEROKEE, ELECTRIC FAN 10" W / O CONTROLS, (2) REQUIRED FOR VEHICLE (REQUIRES FAL-504 SPACER)	FAL-108
SPACER, 0.5" FOR USE WITH FAL-150 & FAL-108	FAL-504
14" UNIVERSAL ELECTRIC FAN, 3-3/4" WIDTH, 14.5" x 14" MOUNTING AREA, W / O CONTROL, W / S-BLADE	FAL-394
14" UNIVERSAL ELECTRIC FAN, 3-3/4" WIDTH, 14.5" x 14" MOUNTING AREA, W / O CONTROL, W / STRAIGHT BLADE	FAL-114
16" UNIVERSAL ELECTRIC FAN, 3-3/4" WIDTH, 16.5" x 16" MOUNTING AREA, W / O CONTROL, W / STRAIGHT BLADE	FAL-116
THERMOSTATIC ADJUSTABLE SWITCH KIT FOR ABOVE (3) ELECTRIC FANS (FAL-394, FAL-114, FAL-116)	FAL-31147
MANUAL ON/OFF SWITCH KIT FOR ABOVE (3) ELECTRIC FANS (FAL-394, FAL-114, FAL-116)	FAL-31148
TRIMLINE EXTENDER FAN BRACKET KIT FOR ABOVE (3) ELECTRIC FANS (FAL-394, FAL-114, FAL-116)	FAL-32124
1972-86 6 CYL CJ, 17" OE STYLE 6-BLADE FAN, MUST BE USED WITH FAN CLUTCH	FAL-5717
1972-83 AMC V8 CJ, 18" OE STYLE 6-BLADE FAN, MUST BE USED WITH FAN CLUTCH, BLACK	FAL-5718
1972-83 AMC V8 CJ, 18" HIGH PERFORMANCE 6-BLADE FAN, (REQUIRES SPACER KIT FAL-14548 OR 14556)	FAL-1318
1972-86 CJ, (NOT FOR CJ's W / SERPENTINE REVERSE ROTATION), 17" HIGH PERFORMANCE 6-BLADE FAN	FAL-1317
1980-89 6 CYL CJ & YJ, W / SERPENTINE REVERSE ROTATION BELT, 17" HIGH PERFORMANCE 6-BLADE FAN,	FAL-1517
1" FAN SPACER KIT, REQUIRED WHEN REPLACING FAN WITH KITS FAL-1318, 1317 OR 1517	FAL-14548
2" FAN SPACER KIT, REQUIRED WHEN REPLACING FAN CLUTCH FOR FAN KITS FAL-1318, 1317	FAL-14556



FAL-475



FAL-116



FAL-5718

RADIATORS:

1972-86 CJ & DJ RADIATORS:

1941-69 EARLY MODEL RADIATORS:

DESCRIPTION	Stock No.	Replaces
1941-49 MB, CJ2A WITH SHROUD, 2 CORE *	17101.01	640145
1941-49 MB, CJ2A WITHOUT SHROUD, 2 CORE *	17101.02	640146
1950-63 CJ3A, CJ3B, 2 CORE	17101.03	943592
1955-69 CJ5, CJ6, 4 CYL, 2 CORE	17101.04	908028

* REQUIRES RADIATOR CAP #17108.01, NOT 17108.02

DESCRIPTION	Stock No.	Replaces
1983-86 4 CYL, MANUAL OR AUTO, 2 CORE	17101.05	5364568
1983-86 4 CYL (AMC 2.5L) DJ POSTAL	17101.06	5900590
1972-86 6 OR 8 CYL, MANUAL OR AUTO, CENTER CAP, 3 CORE	17101.07	5361574HD
(5361574HD WON'T FIT 81-86 6-CYL CJ'S WITH OFF-SET RADIATOR CAP)		
1972-80 6 OR 8 CYL, MANUAL OR AUTO, CENTER CAP, 2 CORE	17101.08	5361574
1981-86 6 OR 8 CYL, MANUAL OR AUTO, CENTER CAP, 2 CORE	17101.09	5362165
1981-86 6 CYL, MANUAL OR AUTO, CAP OFF-SET TO DRIVER SIDE, 2 CORE	17101.10	5362492
1980-UP CJ, DRAIN COCK (ALSO FITS OTHER APPLICATIONS)	NEW 17120.01	3166547

1987-05 YJ & TJ WRANGLER RADIATORS:

	Stock No.	Replaces
1987-91 4 OR 6 CYL, W/ OR W/O A/C, AUTO OR MANUAL, 2 CORE	17101.11	52007227
1992-95 4 OR 6 CYL, W/ OR W/O A/C, AUTO OR MANUAL, 2 CORE	17101.12	52028112
1997-01 TJ WRANGLER (4 OR 6 CYL), W OR W / O AC, AUTO OR MANUAL	17101.13	52080183
1987-04 WRANGLER W/ MANUAL TRANSMISSION (2.4L, 2.5L, 4.0L)	NEW 17101.14	55037652AA

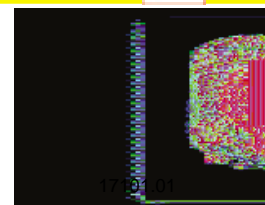

1972-95 CJ & YJ WRANGLER GM V8 CONVERSION RADIATORS:

1972-86 CJ'S, MANUAL OR AUTO, W/ V8 GM CONVERSION ENGINE, 3 CORE	17101.15	350R3
1987-95 YJ'S, MANUAL OR AUTO, W/ GM V8 CONVERSION ENGINE, 3 CORE	17101.16	350R3Y

1984-01 XJ CHEROKEE RADIATORS:

1984-94 4 CYL, 1990-87 4 CYL DIESEL, 1984-86 V6, W OR W/O A/C, 2 CORE	17101.17	53000521
1987-90 6 CYL, W OR W/O A/C, 2 CORE	17101.18	52003157
1991-97 6 CYL, W/ OR W/O A/C, 2 CORE	17101.19	52004921
1998-01 6 CYL XJ WITH 1 CORE RADIATOR	17101.20	52080104AC
1998-00 6 CYL XJ WITH 2 CORE RADIATOR	17101.21	52080164AB

1993-01 ZJ & WJ GRAND CHEROKEE RADIATORS:

1993-94 6-CYL ZJ, W/ OR W/O A/C, STANDARD DUTY	17101.22	52005166
1993-94 6-CYL ZJ, W/ OR W/O A/C, HEAVY DUTY COOLING	17101.23	52005172
1995-97 6-CYL ZJ	17101.24	52028379
1998 6-CYL ZJ	17101.25	52079597
1999-01 6-CYL WJ	17101.26	52079428
1993-94 V8 ZJ, W/ OR W/O A/C	17101.27	52006644
1995-97 V8 ZJ	17101.28	4734104
1998 V8 ZJ	17101.29	52079598
1999-00 V8 WJ 4.7L ENGINE	17101.30	52079425
2001-03 V8 WJ 4.7L ENGINE	17101.31	52079883AB

1974-91 SJ CHEROKEE RADIATORS:

1974-79 8 CYL, W/ OR W/O A/C, 2 CORE	17101.32	5357999
1984-91 8 CYL, W/ OR W/O A/C, 2 CORE	17101.33	5361577

HARD PARTS

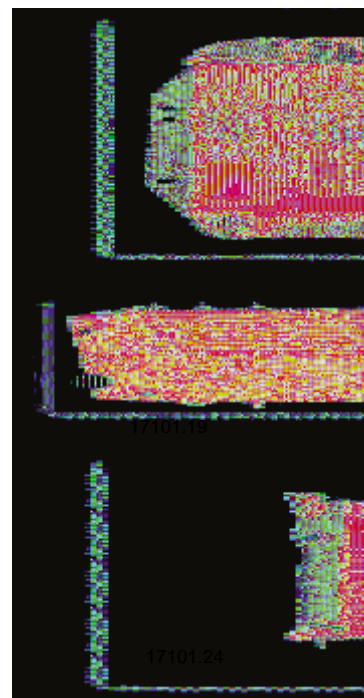

17101.24

RADIATOR FAN SHROUDS:
DESCRIPTION

DESCRIPTION	Stock No.	Replaces
1974-86 6 CYL CJ W/O FACTORY HD COOLING	17102.01	5359030
1981-86 6 CYL CJ WITH FACTORY HD COOLING	17102.02	5362539
1974-86 V8 CJ	17102.03	5355678
1991-95 6 CYL 4.0 L YJ WRANGLER (WILL NOT FIT RHD MODELS)	17102.04	52004214



RADIATOR OVERFLOW BOTTLE & CAP :

1981-95 CJ & WRANGLER, KIT: BOTTLE & CAP	17103.01	5362920K
1987-96 4.0L XJ CHEROKEE, (BOTTLE ONLY)	17103.02	4773849
1987-96 4.0L XJ CHEROKEE, (CAP ONLY)	17103.03	52006707



17103.02



WATER PUMPS:

1941-71 4-134 MB & ALL CIVILIANS	17104.01	8120999
1950-71 4-134 M38 OR M38A1 (DOUBLE GROOVE PULLEY)	17104.02	800002
1941-71 4-134 WATER PUMP REPAIR KIT	17104.80	A-6839
1980-83 4 CYL GM 151 ALL	17104.03	8132274
1983-86 4 CYL CJ, XJ CHEROKEE AMC 150	17104.04	8134320
1983-86 4 CYL CJ AMC 150 W/SERPENTINE	17104.05	8133034
1984-90 4 CYL XJ CHEROKEE W/SERPENTINE	17104.05	83502957
1987-90 4 CYL YJ WRANGLER & XJ CHEROKEE W/O SERPENTINE	17104.07	4626054
1991-01 4 CYL YJ & TJ WRANGLER	17104.07	4626054
1991-00 4 CYL XJ CHEROKEE	17104.07	4626054
2002-UP 2.4 L 4 CYL TJ WRANGLER & KJ LIBERTY	17104.08	4694307AC
1948-63 6 CYL, 226 ENGINE WAGON & TRUCK	17104.09	928008
1965-71 V6 225 CJ WITH GM ENGINE	17104.10	991996
1971-74 6 CYL CJ	17104.11	8120131
1975-79 6 CYL ALL	17104.12	8125501
1980-86 6 CYL ALL	17104.04	8134320
1980-86 6 CYL WITH SERPENTINE BELT	17104.05	8133034
1987-90 6 CYL YJ WRANGLER W/O SERPENTINE	17104.06	83502957
1987-90 6 CYL YJ WRANGLER W/ SERPENTINE	17104.13	83502938
1991-99 6 CYL WRANGLER (YJ & TJ) W/SERPENTINE, & 1998 4.0L ZJ	17104.07	4626054
1987-99 6 CYL XJ CHEROKEE & 1993-97 ZJ GRAND CHEROKEE	17104.14	83503407
2002-UP 3.7 L KJ LIBERTY	17104.18	53020873AC
1972 8 CYL. AMC	17104.15	8122307
1973-83 8 CYL ALL AMC-V8	17104.16	3234427
1993-98 V8 ZJ GRAND CHEROKEE	17104.17	530208280
1999-UP 4.7 L WJ GRAND CHEROKEE	17104.19	53020873AC
4.0L WJ WATER PUMP	17104.20	5012366AC

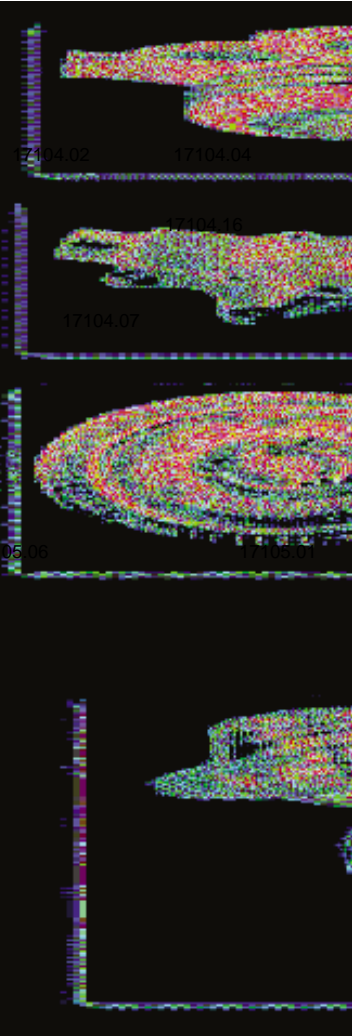

FAN CLUTCHES:

1980-86 2.5L 4-CYL CJ, W/O SERPENTINE	17105.01	3241857
1987-90 2.5L 4-CYL YJ WRANGLER, W/O SERPENTINE	17105.01	3241857
1991-96 2.5L 4-CYL YJ WRANGLER, W/ SERPENTINE	17105.02	3241858
1997-99 2.5L 4-CYL TJ WRANGLER (REVERSE ROTATION)	17105.03	52003205
1984-86 2.5L 4-CYL XJ CHEROKEE, W/O SERPENTINE	17105.01	3241857
1984-93 2.5L 4-CYL XJ CHEROKEE, W/ SERPENTINE	17105.02	3241858
1994-99 2.5L 4-CYL XJ CHEROKEE (GAS MODELS) REVERSE ROTATION	17105.04	4637575
CALL FOR APPLICATION	17105.05	4266665
1974-86 6 OR 8 CYL CJ, W/O SERPENTINE	17105.06	5362170
1981-86 4.2L 6-CYL CJ, W/ SERPENTINE	17105.02	3241858
1987-90 4.2L 6-CYL YJ WRANGLER, W/O SERPENTINE	17105.01	3241857
1987-90 4.2L 6-CYL YJ WRANGLER, W/ SERPENTINE	17105.02	3241858
1991-99 4.0L 6-CYL WRANGLER (YJ & TJ) REVERSE ROTATION	17105.04	4637575
1987-99 4.0L 6-CYL XJ CHEROKEE (REVERSE ROTATION)	17105.03	52003205
1997-98 4.0L 6 CYL ZJ, W/O MAX COOLING (REVERSE ROTATION)	17105.04	4637575
1993-98 4.0L 6-CYL ZJ, W/ MAX COOLING SYSTEM (REVERSE ROTATION)	17105.07	52027823
1974-91 4.2L 6-CYL SJ	17105.06	5362170
1981-89 4.2L 6-CYL SJ, W/ SURPENTINE	17105.08	5362520
1974-91 V8 SJ	17105.06	5362170
1994-98 V8 ZJ GRAND CHEROKEE SEVERE DUTY, REVERSE ROTATION	17105.09	52028214
2000-02 2.5L TJ, 2003 2.4L TJ FAN CLUTCH	NEW 17105.10	52027890AB
2001-01 4.0L XJ, FAN CLUTCH	NEW 17105.10	52027890AB
2000 2.5L XJ FAN CLUTCH (W OR W/O) AC	NEW 17105.11	52079684
2000-04 4.0L TJ, FAN CLUTCH	NEW 17105.12	52079787AA

THERMOSTATS:

160 DEGREE	17106.01	812050
180 DEGREE	17106.02	905594
195 DEGREE	17106.03	83501426

1993-98 V8 ZJ GRAND CHEROKEE, 195 DEGREES	17106.03	83501426
1999-04 4.7L WJ	NEW 17106.05	52079476AC
2002-04 3.7L KJ	NEW 17106.05	52079476AC
1987-96 4 CYL XJ CHEROKEE (EUROPEAN VERSIONS ONLY)	17106.04	TBA
1941-56 L-HEAD 134 ENGINES THERMOSTAT RETAINER	17107.01	

RADIATOR CAPS:

DESCRIPTION	Stock No.	Replaces
MB & CJ :		
1941-49 MB & CJ-2A *	17108.01*	810391
7 LBS PRESSURE (EARLY CJ5)	NEW 17108.08	648360
1972-86 CJ	17108.02	5358177
YJ WRANGLER:		
1987-93 4 OR 6 CYL (13 lbs pressure)	17108.03	3239375
1994-95 4 CYL (16 lbs pressure)	17108.04	5358177
TJ WRANGLER:		
1997-98 4 CYL (18 lbs pressure)	17108.05	52027793
1997-01 6 CYL (18 lbs pressure)	17108.05	52027793
XJ CHEROKEE:		
1984-90 4 CYL (13 lbs pressure)	17108.03	3239375
1991-UP 4 CYL (16 lbs pressure)	17108.04	5358177
1991-95 6 CYL (13 lbs pressure)	17108.03	3239375
1996-UP 6 CYL (16 lbs pressure)	17108.04	5358177
WJ & ZJ GRAND CHEROKEE:		
1993-98 V8 (18 lbs pressure)	17108.05	52027793
1993-96 6 CYL (16 lbs pressure)	17108.04	5358177
1997-98 6 CYL (18 lbs pressure)	17108.05	52027793
2000-UP V8 4.7 L (20 lbs pressure)	17108.06	52079778AB
1999-03 6 CYL 4.0L WJ	17108.05	52027793

* Not for use with Radiators # 17101.01 or 17101.02. Use Cap # 17108.02 for these applications



17108.02

RADIATOR CLAMPS:

WILL FIT ALL RADIATOR HOSES (4 PER VEHICLE) 17115.01 5228

HEATER BYPASS HOSE & WATERPUMP BYPASS HOSE:

1972-83 8 CYL CJ, HEATER BYPASS HOSE 17116.01 3182494

1972-83 V8 CJ HEATER HOSE CLAMP (2 PER VEHICLE) 17115.02 5212

WATERPUMP BYPASS HOSE ALL F HEAD 134 ENGINES (M38, A1, 3B,CJ5, 6) 17116.02 801047 **NEW**

IDLER PULLEYS:

1991-95 2.5L XJ 17112.01 53002905

1993-96 4.0L ZJ 17112.01 53002905

1991-93 4.0L XJ W / AC 17112.01 53002905

1994-95 4.0L XJ 17112.01 53002905

2000-04 4.0L TJ 17112.02 4854092 **NEW**

1993-98 5.2L & 5.9L ZJ GRAND CHEROKEE 17112..03 53009508 **NEW**

1993-98 5.2L & 5.9L ZJ GRAND CHEROKEE 17112.50 53010158 **NEW**

TENSIONER W/ PULLEY



UPPER RADIATOR HOSE

UPPER RADIATOR HOSES:

DESCRIPTION	Stock No.	Replaces
CJ2A	17113.01	645746
CJ3A	17113.02	649341
CJ3B	17113.03	800284
1955-71 CJ5 4 CYL	17113.04	5364659
1980-83 4 CYL GM ENGINE CJ	17113.05	5360950
1983-86 4 CYL CJ AMC	17113.04	5364659
1987-95 4 CYL YJ WRANGLER	17113.07	52003911
1987-98 4 CYL XJ CHEROKEE W/O AC	17113.08	52003789
1987-97 4 CYL XJ CHEROKEE W/ AC	17113.09	52003791
1948-64 6 CYL. 226	17113.10	906070
1974-86 6 CYL CJ	17113.11	8136659
1987-90 6 CYL YJ WRANGLER	17113.12	52003906
1991-95 6 CYL YJ WRANGLER	17113.13	52005794
1997-UP 6 CYL TJ WRANGLER	17113.14	52028264
1987-98 6-CYL XJ CHEROKEE W/O AC	17113.15	52003946
1987-93 6-CYL XJ CHEROKEE W/ AC	17113.15	52003946
1994-98 6-CYL XJ CHEROKEE W/ AC	17113.16	52028419
1993-98 6-CYL ZJ GRAND CHEROKEE	17113.17	52028263
1974-81 8 CYL CJ	17113.18	83505532
1993-98 8 CYL ZJ GRAND CHEROKEE (BOTH 5.2L & 5.9L)	17113.19	52029272
1999-04 4.0L WJ	NEW 17113.21	52079406AC



LOWER RADIATOR HOSE

LOWER RADIATOR HOSES:

DESCRIPTION	Stock No.	Replaces
1945-49 CJ2A	17114.01	645902
1951-63 CJ3A, CJ3B	17114.02	649207
1980-83 4 CYL CJ GM ENGINE	17114.03	5360951
1983-86 4 CYL CJ AMC	17114.04	5364660
1987-95 4 CYL YJ WRANGLER	17114.05	52040236
1997-02 4 CYL. TJ WRANGLER	17114.06	52028267
1987-97 4-CYL XJ CHEROKEE (W/ OR W/O A/C)	17114.07	52005918
1975-86 6 CYL CJ	17114.08	5362162
1987-90 6 CYL 4.2L YJ WRANGLER	17114.09	52040289
1991-95 6 CYL YJ WRANGLER	17114.07	52005918
1997-00 6-CYL TJ WRANGLER	17114.07	52005918
1987-98 6-CYL 4.0L XJ CHEROKEE	17114.11	52003945
1993-98 6-CYL 4.0L ZJ GRAND CHEROKEE	NEW 17114.12	52028262
1972-83 8 CYL CJ	17114.13	5354528
1993-98 8 CYL ZJ GRAND CHEROKEE	17114.14	52028226
1999-04 4.0L WJ	NEW 17114.15	52079401AB

SERPENTINE BELTS:

DESCRIPTION		Stock No.	Replaces
1993-95 ZJ 4.0L WITH AC	NEW	17111.01	4612277
1999-01 WJ 4.0L WITH AC	NEW	17111.02	4854033
1984-90 XJ 2.5L WITH AC	NEW	17111.03	53001120
1987-90 XJ 4.0L	NEW	17111.04	53002899
1987-90 XJ 2.5L W/O AC	NEW	17111.05	53002900
1991-94 YJ (BOTH 2.5L & 4.0L) WITH AC & PS; 1991-95 2.5L XJ WITH AC & PS	NEW	17111.06	53007539
1993-95 ZJ 5.2L	NEW	17111.07	53008744
1991-95 YJ (2.5L & 4.0L) W/O AC & W/O PS; 1991-93 2.5 XJ W/O AC & W/O PS	NEW	17111.08	53010283
1997-02 2.5L TJ WITH AC - 1996-98 4.0L ZJ	NEW	17111.09	53010150
1991-93 YJ (BOTH 2.5L & 4.0L) WITH AC & W/O PS; 1999-00 2.5L TJ RHD W/AC; 1996-01 2.5L 4.0L XJ RHD; 1996-98 4.0L ZG RHD (WITH 117 OR 136 AMP ALTERNATIVE)	NEW	17111.10	53010234
1997-99 TJ (2.5L & 4.0L) W/O AC & W/O PS	NEW	17111.11	53010254
1995 2.5L & 4.0L YJ LHD W/O AC & W/ PS; 1997-02 2.5L TJ W/O AC & W/ PS LHD 1997-99 4.0L TJ W/O AC & W/ PS LHD; 1996-00 2.5L XJ W/O AC	NEW	17111.12	53010257
1991-95 4.0L XJ, LHD	NEW	17111.13	53010269
1991-95 4.0L XJ, RHD		17111.14	53010279
1991-94 2.5L & 4.0L YJ W/O AC & W/ PS LHD; 1994-95 2.5L & 4.0L YJ W/O AC & W/ PS RHD; 1991-95 2.5L XJ W/O AC & W/ PS; 1993-95 4.0L ZJ W/O AC	NEW	17111.15	53010294
1996-00 2.5L RHD XJ W/O AC	NEW	17111.16	53010311
1996-01 4.0L XJ LHD, 1997-01 2.5L RHD XJ W/ AC	NEW	17111.17	53010314
1995 YJ 2.5L & 4.0L W/ AC & W/ PS; 1997-98 2.5L & 4.0L TJ W/ AC & W/ PS LHD; 1996-00 2.5L XJ W/ AC & W/ PS LHD	NEW	17111.18	53011035
1996-98 V8 (BOTH 5.2L & 5.9L) ZJ	NEW	17111.19	53011097
2000-02 4.0L TJ W/O AC	NEW	17111.21	53013209AC
1999-02 V8 4.7L WJ	NEW	17111.22	53032037AC
1999-04 4.0L WJ GRAND CHEROKEE	NEW	17111.23	48454033AB
1991-93 2.5L & 4.0L YJ W/ AC & PS; 1994-96 4.0L ZJ W/O AC	NEW	17111.24	53007595
1994-95 4.0L ZJ WITH AC	NEW	17111.25	53010275
1994 5.2L ZJ	NEW	17111.26	53011098
1987-90 4.2L YJ W/O PS	NEW	17111.27	4060785
1987-90 4.2L YJ W/ PS	NEW	17111.28	4060817
2000-01 WG W/ 3.1L V.M. DIESEL ENGINES (EXPORT MARKETS)	NEW	17111.30	5015962AB

FAN BELTS (V-BELTS):

DESCRIPTION	Stock No.	Replaces
4-134 MB, CJ2A, 3A, 3B, CJ5 & CJ6	17110.01	647629
4-134 M38, M38A1 PAIR	17110.02	118866
76-86 CJ W/O AC	17110.03	3239615



THERMOSTAT HOUSING W/OUT GASKET:

1953-71 4 CYL F-HEAD 134	17118.01	800293
1983-87 4 CYL 150 AMC, CJ, YJ, XJ	17118.02	33004856
1991-95 4 CYL 2.5L YJ WRANGLER & XJ CHEROKEE (NOT FOR EXPORT XJ)	17118.03	53006192
1975-80 6 CYL 232, 258 4.2L	17118.04	3224216
1981-90 6 CYL 258 4.2L, 242 4.0L, CJ, YJ WRANGLER, XJ CHEROKEE	17118.02	33004856
1991-95 6 CYL 4.0L YJ WRANGLER, XJ CHEROKEE, XJ GRAND-CHEROKEE	17118.03	53006192
1972-93 8 CYL CJ, SJ	17118.05	3238509



THERMOSTAT GASKETS



17118.02



17118.04

THERMOSTAT GASKETS:

DESCRIPTION	Stock No.	Replaces
1941-71 4 CYL L-HEAD 134	17117.01	639650
1953-71 4 CYL F- HEAD 134	17117.02	648852
1974-90 6 CYL ALL 258	17117.03	3189874
1974-91 8 CYL ALL	17117.04	3187543
1993-96 V8 5.2L ZJ GRAND CHEROKEE	17117.05	53020371



OPTIMA BATTERIES:

MODEL 34/78 - RED TOP	OPT-9004003
MODEL D34/78 - YELLOW TOP	OPT-9014045
MODEL D34M - BLUE TOP	DPT-9016103
OPT-9016103	
MODEL 75-25 - RED TOP	OPT-9022091



Red Top = 800 Cold Cranking Amps
 Yellow Top = 750 Cold Cranking Amps
 Blue Top = 650 Cold Cranking Amps
 (@ 0 degrees F)



MEAN GREEN PERFORMANCE STARTERS:

STARTER ASSY, 1972-87 ALL CJ'S AND SJ'S WITH 6-CYL & V8 AMC ENGINES	MG3209
STARTER ASSY, 1988-00 ALL 4.0L & 4.2L 6 CYL (YJ, TJ, XJ, ZJ, WJ), 1988-91 V8 SJ	MG3210
STARTER ASSY, 1987-00 ALL 4-CYL YJ, TJ, XJ WITH 2.5L ENGINE	MG3212
STARTER ASSY, FOR CJ'S WITH GM V8 ENGINE CONVERSION (BLOCK MOUNTED)	MG6510

(STARTERS HAVE 2 YEAR WARRANTY, ALL WARRANTY ISSUES MUST BE HANDLED DIRECTLY WITH MEAN-GREEN) UP TO 100% MORE TORQUE THAN FACTORY STARTERS AND WITH 4.4 TO 1 GEAR REDUCTION WILL ASSURE YOUR ENGINE WILL CRANK AT THE EXTERME CONDITIONS.

MEAN GREEN PERFORMANCE ALTERNATORS:

ALT. ASSY, 1991-98 2.5L & 4.0L YJ & TJ, 1991-98 ALL XJ, 1993-98 6 CYL ZJ	MG1334
ALT. ASSY, 1993-98 5.2L V8 ZJ GRAND-CHEROKEE	MG1335
ALT. ASSY, 1999-01 2.5L TJ & XJ, 1999 4.0L TJ, 1999-00 4.0L XJ	MG1382
HIGH PERFORMANCE ALTERNATOR 1976-77 CJ V8 304	MG7074
ALT. ASSY, W/O SERP. BELT MODELS, 1975-86 6 CYL CJ, 1984-90 2.5L CJ & YJ	MG7127
ALT. ASSY, W/O SERP. BELT MODELS, 1987-90 4.2L 6-CYL WRANGLER	MG7128
ALT. ASSY, 1978-83 CJ WITH V8 AMC ENGINE	MG7129
ALT. ASSY, W/O SERPT. BELT MEDELS, 1982-91 V8 SJ, 1984-86 XJ W/ 2.8L	MG7228
ALT. ASSY, MODELS WITH SERP BELT, 1975-90 4.2L CJ&YJ, 1984-90 4 CYL CJ&YJ	MG7272
ALT. ASSY, 1987-90 4.0L 6-CYL XJ CHEROKEE	MG7902



MG1334

EXACT FIT WIRING HARNESS FOR 1946-65 CJ:

1945-EARLY46 EARLY CJ2A (HORN ON FIREWALL) CLOTH WIRE	17201.01	641949
SAME AS ABOVE BUT INCLUDES TURN SIGNAL WIRES	17201.02	641949T
1946-LATE-1949 CJ2A, (HORN ON FENDER), CLOTH WIRING	17201.03	643261
SAME AS ABOVE BUT INCLUDES TURN SIGNAL WIRES	17201.04	643261T
1949-1953 CJ3A, CLOTH WIRING	17201.05	645743
SAME AS ABOVE BUT INCLUDES TURN SIGNAL WIRES	17201.06	645743T
1952-56 CJ3B WITH SMALL SPEEDOMETER (CLOTH WIRING)	17201.07*	809464
1957-64 CJ3B WITH LARGE SPEEDOMETER (PLASTIC WIRING)	17201.08*	925133
1954-56 CJ5 CLOTH WIRING	17201.09*	907232
1957-65 CJ5 PLASTIC WIRING	17201.10*	925159

(ALTERNATORS HAVE 12 MONTH WARRANTY, ALL WARRANTY ISSUES MUST BE HANDLED DIRECTLY WITH MEAN-GREEN). AN IDEAL COMPANION TO DUAL BATTERY SYSTEM JEEPS®, WHICH PRODUCES 100 AMP AT IDLE. THESE USA MADE UNITS USE THE STATE OF THE ART TECHNOLOGY FOR SUPERIOR PERFORMANCE:



17202.03



17202.02

* THESE KITS INCLUDE TURN SIGNAL WIRES

PAINLESS WIRING HARNESS KITS:



DESCRIPTION	Stock No.	Replaces
1945-74 CJ COMPLETE HARNESS KIT, UNIVERSAL	17202.01	10105
1975-86 CJ COMPLETE HARNESS KIT, UNIVERSAL	17202.02	10106
1976-86 CJ COMPLETE HARNESS KIT, FACTORY PRETERMINATED	17202.03	10110
ALL YEARS AUXILIARY FUSE BLOCK WITH 3 CIRCUITS	17204.01	70103
ALL YEARS AUXILIARY FUSE BLOCK WITH 7 CIRCUITS	17204.02	70107

CENTECH WIRING HARNESS KITS:

1955-86 UNIVERSAL KIT	17203.01	CW-GV10J
1976-86 HEAVY DUTY HARNESS KIT	17203.02	CW-JP7683S



17203.01

HARD PARTS

ELECTRIC-LIFE POWER WINDOW KITS:



1976-95 CJ-7, CJ-8 & YJ WRANGLER, POWER WINDOW CONVERSION, PAIR - LH & RH	111098
1997-UP TJ WRANGLER, POWER WINDOW CONVERSION, PAIR - LH & RH	121099
1984-96 XJ CHEROKEE & MJ COMMANCHE PU, PWR WINDOW REPLACEMENT KIT, LH-FRONT	JE01-L
1984-96 XJ CHEROKEE & MJ COMMANCHE PU, PWR WINDOW REPLACEMENT KIT, RH-FRONT	JE01-R
1984-96 XJ CHEROKEE, PWR WINDOW REPLACEMENT KIT, LH-REAR	JE02-L
1984-96 XJ CHEROKEE, PWR WINDOW REPLACEMENT KIT, RH-REAR	JE02-R
1984-96 XJ CHEROKEE, SWITCH KIT FOR 2 DOOR CONVERSION (3 SWITCHES)	4990-10
1984-96 XJ CHEROKEE, SWITCH KIT FOR 4 DOOR CONVERSION (7 SWITCHES)	4990-50



ELECTRIC-LIFE POWER WINDOW KIT

BATTERY TRAY KITS:

	Stock No.	Replaces
1976-86 ALL CJ'S, KIT, BLACK (INCLUDES CLAMP)	11214.01	5764665K
1976-86 CJ, STAINLESS STEEL BATTERY TRAY	17260.01	5764665ST
1976-86 ALL CJ'S, STAINLESS STEEL, KIT (INCLUDES CLAMP)	11132.01	5764665K-ST
1976-86 ALL CJ'S, BATTERY TRAY CLAMP ONLY, BLACK	17260.02	3226119



11214.01

SPEEDOMETER ASSEMBLIES (IN KILOMETERS):

1941-58 MB, CJ2A, CJ3A, EARLY CJ5 (KILO)	17205.01	TBA
1955-79 CJ5, CJ6 & LATE CJ3B (KILO)	17205.02	914846
1980-86 CJ5, CJ7, CJ8 (KILO)	17205.03	5761112



SPEEDOMETER HEADS WITH ODOMETER (W/O CASE OR OTHER PARTS):

DESCRIPTION

DESCRIPTION	Stock No.	Replaces
1955-79 CJ5, CJ6 & LATE-CJ3B (0-90 MILE DIAL)	17207.01	913373
1955-79 CJ5, CJ6 & LATE-CJ3B (KILOMETER DIAL FOR EXPORT MARKETS)	17207.02	913374
1980-86 CJ5, CJ7, CJ8 (5-85 MILE DIAL)	17207.03	8134184
1980-86 CJ5, CJ7, CJ8 (KILOMETER DIAL FOR EXPORT MARKETS)	17207.04	8134186

SPEEDOMETER CABLES: Stock No. Replaces

1941-75 MB, 2A, 3A, 3B, CJ5, CJ6 3 SPEED, 60"	17208.01	5351778
1963-76 CJ, 4 SPEED, 67"	17208.02	5351775
1977-86 CJ, ALL W/STANDARD TRANNY, 69"	17208.03	5351777
1976-79 CJ AUTOMATIC 80"	17208.04	5351776



FUEL & TEMP GAUGES INSIDE SPEEDOMETER ASSEMBLY:

DESCRIPTION	Stock No.	Replaces
1955-86 CJ FUEL & TEMP GAUGE PAIR	17209.01	8126919K
FUEL AND TEMP GAUGE MUST BE REPLACED AT THE SAME TIME		
1980-86 CJ REPLACEMENT BI-TORQUE DESIGN FUEL & TEMP GAUGE PAIR	17209.02	4740791
17209.02 GAUGE PAIR MUST BE USED TOGETHER		



1941-64 MB, CJ2A, CJ3A, & EARLY CJ3B MISC. GAUGES AND PARTS:

1948-56 3A, EARLY 3B, AMMETER	17210.01	640761
1941-47 MB & EARLY CJ2A, OIL GAUGE	17210.02	640764
1948-56 LATE 2A, 3A, EARLY 3B, OIL GAUGE	17210.03	647058
1941-47 MB & EARLY CJ2A, TEMP GAUGE	17210.04	640762
1948-56 LATE 2A, 3A, EARLY 3B, TEMP GAUGE	17210.05	647886
1946-56 2A, 3A, EARLY 3B, FUEL GAUGE (6V)	17210.06	640763
1946-56 2A, 3A, EARLY 3B, FUEL GAUGE (12V)	17210.07	640763-12V
1941-45 MB SPEEDOMETER ROUND GEAR (INSIDE TRANSFER CASE)	17211.01	A-1511
1941-45 MB SPEEDOMETER LONG GEAR 14 TEETH (INSIDE TRANSFER CASE)	17211.02	A-1512
1955-64 CJ SPEEDOMETER LONG GEAR 15 TEETH (INSIDE TRANSFER CASE)	17211.03	A-5707



1976-86 CJ MISC. GAUGES, TACHOMETER & CLOCK:

DESCRIPTION	Stock No.	Replaces
1976-95 CJ & WRANGLER ANTENNA MAST, CHROME	17212.01	8993415
1976-95 CJ & WRANGLER ANTENNA MAST, BLACK	17212.02	82200684
1976-95 CJ & WRANGLER ANTENNA BASE, CHROME	17213.01	8127842
1976-95 CJ & WRANGLER ANTENNA BASE, BLACK	17213.02	82200683
1976-95 CJ & WRANGLER CHROME ANTENNA KIT	17214.01	8127842K
1976-95 CJ & WRANGLER BLACK ANTENNA KIT	17214.02	82200683K
1976-86 CJ CLOCK	17215.01	5761330
1976-86 CJ TACOMETER (ALL 4, 6 OR 8 CYLINDERS)	17215.02	5459418
1976-86 CJ VOLTMETER	17215.03	5750278
1976-86 CJ OIL PRESSURE	17215.04	5750279

TEMPERATURE SENDING UNITS:

DESCRIPTION	Stock No.	Replaces
1953-71 4-134 CJ3B, CJ5, CJ6	17218.01	914847
1972-86 4, 6, OR 8 CYL AMC, CJ, SJ	17218.02	3177594
1987-90 YJ WRANGLER, XJ CHEROKEE, SJ (MODELS WITH GAUGE)	17218.03	53005056
1991-95 YJ WRANGLER WITH GAUGE	17218.04	56027012
1992-96 XJ CHEROKEE, 1994-95 YJ WRANGLER (WITH WARNING LAMP)	17218.05	56026710
1994-96 ZJ GRAND CHEROKEE (MODELS WITH WARNING LAMP)	17218.05	56026710
1997-UP ALL WRANGLER, CHEROKEE & GRAND CHEROKEE TEMP SWITCH	17218.06	56027873



TEMPERATURE SENSORS:

1991-96 4 CYL 2.5L YJ WRANGLER, XJ CHEROKEE	17217.01	33004281
1988-90 6 CYL 4.2L YJ WRANGLER	17217.01	33004281
1991-97 6 CYL 4.0L YJ WRANGLER & XJ CHEROKEE	17217.01	33004281
1993-98 V8 5.2L ZJ GRAND CHEROKEE	17217.02	56004815

HARD PARTS

OIL PRESSURE SENDING UNITS:

	Stock No.	Replaces
1953-71 4-134, CJ3B, CJ5, CJ6	17219.01	938092
1975-86 4 OR 6 CYL AMC, CJ, SJ	17219.02	3212004
1981-83 CJ 4 CYL 2.5L GM ENGINE	17219.03	3241716
1981 SJ AND SOME CJ'S WITH 3 TERMINAL	17219.04	3231347
1987-93 YJ WRANGLER (2 TERMINAL, W/O GAUGE)	17219.05	5758695
1987-91 YJ WRANGLER (MODELS WITH GAUGE)	17219.06	53005218
1991-95 YJ WRANGLER	17219.07	56026779
1984-91 XJ CHEROKEE (MODELS W/O GAUGES)	17219.08	3142826
1987-90 XJ CHEROKEE (EXPORT MODELS WITH 2 TERMINAL)	17219.05	5758695
1984-90 XJ CHEROKEE (MODELS WITH GAUGE)	17219.06	53005218
1984-90 XJ CHEROKEE DIESEL	17219.09	33002472
1991-96 XJ CHEROKEE (EUROPEAN MODELS ONLY)	17219.10	56026781
1992-96 XJ CHEROKEE	17219.11	56026719
1997-01 XJ CHEROKEE, 2000 WRANGLER, 2001 WG	17219.12	56028807AA
1981-91 SJ (WITH 2 TERMINAL)	17219.05	5758695
1993-95 ZJ GRAND CHEROKEE	17219.07	56026779
2003-04 4.0L TJ WRANGLER	NEW 17219.15	4868672AA

CRANKSHAFT POSITIONING SENSORS:

1994-96 5.2L V8 ZJ GRAND CHEROKEE	NEW 17220.01	56027272
1991-95 4.0L XJ	17220.02	56026882
1991-92 2.5L YJ WRANGLER	NEW 17220.03	4638128
2003-04 4.0L TJ WRANGLER	NEW 17220.04	4727451AA
1997-98 4.0L TJ & ZJ	NEW 17220.05	4897321AA
2004 KJ 2.4L	NEW 17220.06	5269873
1994-96 5.2L ZJ	NEW 17220.01	56027272
1993-95 4.0L YJ WRANGLER	NEW 17220.07	56027280
1999-04 4.7L WJ	NEW 17220.08	56028666AAA
2002-03 3.7L KJ	NEW 17220.09	56041479AC
2002-03 2.4L KJ	NEW 17220.10	56041552AC
2004 3.7L KJ	NEW 17220.11	56044180AB
1997-01 4.0L XJ CHEROKEE	NEW 17220.12	56027866AE
1997-02 2.5L & 1997-2005 4.0L	NEW 17220.13	56027865AB

INTAKE TEMPERATURE SENSORS:

1988-96 4 CYL & 6 CYL (ALL) YJ WRANGLER & XJ CHEROKEE	17221.01	33004280
---	----------	----------

OXYGEN SENSORS:

1981-82 4 CYL CJ	17222.01	3240083
1981-85 4 CYL 2.5L CJ & XJ CHEROKEE	17222.02	33002455
1986-90 4 CYL 2.5L XJ CHEROKEE	17222.03	53002106
1991-96 4 CYL 2.5L YJ WRANGLER & XJ CHEROKEE	17222.04	53007638
1996-00 4 CYL 2.5L XJ CHEROKEE (AFTER CAT)	17222.05	56041005
1997-98 4 CYL 2.5L WRANGLER (AFTER CAT)	17222.06	56041213
1997 4 CYL 2.5L WRANGLER & XJ CHEROKEE (BEFORE CAT)	17222.07	56027917
1983-86 6 CYL 4.2L CJ	17222.02	33002455
1987-90 6 CYL 4.2L YJ WRANGLER	17222.08	53000886
1984-86 XJ CHEROKEE V6 2.8L	17222.08	53000886
1987-90 6 CYL 4.0L XJ CHEROKEE	17222.16	53004245
1991-95 6 CYL 4.0L WRANGLER & XJ CHEROKEE	17222.09	56028301
1996-00 6 CYL 4.0L XJ CHEROKEE & ZJ GRAND CHEROKEE (AFTER CAT)	17222.05	56041005
1993-95 4.0L ZJ GRAND CHEROKEE	17222.10	56027902
1997-98 6 CYL 4.0L TJ WRANGLER (AFTER CAT)	17222.05	56041005
1996-97 6 CYL 4.0L XJ CHEROKEE (BEFORE CAT)	17222.11	56027916
1997-98 6 CYL 4.0L ZJ GRAND CHEROKEE (BEFORE CAT)	17222.12	56028603
1997-98 XJ CHEROKEE 6 CYL 4.0L XJ (AFTER CAT)	17222.05	56041005
1993-96 8 CYL 5.2L ZJ GRAND CHEROKEE (BEFORE CAT)	17222.09	56028301
1997-98 8 CYL 5.2L ZJ GRAND CHEROKEE (AFTER CAT)	17222.05	56041005
1997-98 8 CYL 5.2L OR 5.9L ZJ GRAND CHEROKEE (BEFORE CAT)	17222.07	56027917

MAP SENSORS:

1987-96 2.5L, 4.2L, 4.0L YJ WRANGLER & XJ CHEROKEE	17223.01	33000153
1997-04 4.0L TJ, 1997-02 2.5L TJ, 1997-01 ALL XJ, 1997-98 4.0L & 5.2L ZJ, 1999-02 4.0L WJ	17223.02	56029405

THROTTLE POSITIONING SENSORS:

1986-90 4 CYL 2.5L YJ WRANGLER & XJ CHEROKEE	17224.01	33000169
1991-96 4 CYL 2.5L WRANGLER & XJ CHEROKEE	17224.02	4761871AB
1991-96 6 CYL 4.0L WRANGLER, XJ CHEROKEE & ZJ GRAND CHEROKEE	17224.02	4761871AB
1993-96 8 CYL 5.2L ZJ GRAND CHEROKEE	17224.02	4761871AB
1997-98 8 CYL 5.2L ZJ GRAND CHEROKEE	17224.03	4882219
1997-01 2.5L & 4.0L TJ WRANGLER	NEW 17224.04	4874371AC
1999 4.7L WJ GRAND-CHEROKEE	NEW 17224.05	5017479AA
2003 4.0L WJ & 2004 2.5L & 4.0L TJ	NEW 17224.06	5019411AB



OIL PRESSURE SENDING UNITS



17222.08



17223.01

ALTERNATORS:

	Stock No.	Replaces
1975-79 CJ & SJ 63 AMP (USES STANDARD HARDWARE)	17225.01	8127023
1980-86 CJ & SJ 63 AMP (USES METRIC HARDWARE)	17225.02	8134663
1981-86 CJ & SJ 56-78 AMP (TAGGED 1105081 OR 1105082)	17225.03	8134664
1987-90 4 CYL WRANGLER & XJ CHEROKEE 61-74 AMP (TAGGED 1101171 OR 1101172)	17225.04	53004264
1987-90 4 CYL WRANGLER & XJ CHEROKEE 61-74 AMP (TAGGED 1101175 OR 1101176)	17225.05	53003802
1991-99 4 CYL 2.5L WRANGLER (YJ & TJ) OR XJ CHEROKEE, 90 AMP	17225.06	56005685
1991-99 6 CYL 4.0L WRANGLER (YJ & TJ), 90 AMP	17225.06	56005685
1987-90 6 CYL 4.0L XJ CHEROKEE 85-100 AMP (TAGGED 1101167 OR 1101170)	17225.07	53002898
1987-90 6 CYL 4.0L XJ CHEROKEE 60 AMP (TAGGED 1101168)	17225.08	JR775727
1991-98 6 CYL 4.0L XJ CHEROKEE & ZJ GRAND-CHEROKEE, 90 AMP	17225.06	56005685
1993-94 V8 ZJ GRAND CHEROKEE	17225.09	53008647
1999-2004 4.0L WJ GRAND CHEROKEE ALTERNATOR ASSY.	NEW 17225.10	56041322AB
2000 4.7L WJ GRAND CHEROKEE ALTERNATOR ASSY.	NEW 17225.11	56041324AC



ALTERNATOR COMPONENTS:

	STOCK NO.	REPLACES
1976-90 CJ, SJ REGULATOR, ELECTRONIC	17226.01	8125176
1976-86 CJ, SJ RECTIFIER	17226.02	8125178
1976-86 CJ, SJ TRIO DIODE	17226.03	8125177
1976-86 CJ, SJ NEEDLE BEARING	17226.04	8125181
1976-86 CJ, SJ FRONT BEARING	17226.05	8125182

NEW STARTERS:

	STOCK NO.	REPLACES
1941-49 MB & CJ2A, 6-VOLT MADE IN FRANCE(LIMITED ONLY), NEW	17227.01	A-1245
1941-49 MB & CJ2A, 12-VOLT (LIMITED ONLY), NEW	17227.02	OMIX-12V-ST1
1972-86 6 OR 8 CYL CJ OR SJ	17227.03	5752791
1987-93 4 CYL 2.5L WRANGLER, XJ CHEROKEE WITH FUEL INJECTION	17227.04	53002125
1994-00 4 CYL 2.5L WRANGLER (YJ & TJ), XJ CHEROKEE WITH FUEL INJECTION	17227.05	4796981
1988-00 6 CYL 4.2L OR 4.0L WRANGLER (YJ & TJ)	17227.06	33002709
1987-98 6 CYL 4.0L XJ CHEROKEE	17227.06	33002709
1993-98 6 CYL 4.0L ZJ GRAND CHEROKEE	17227.06	33002709
1993-98 V8 ZJ GRAND CHEROKEE	17227.07	56004934
1999-00 XJ CHEROKEE, WJ GRAND CHEROKEE, 1999-01 4.0L XJ, 1999-02 4.0L WJ	17227.08	56041012AB
1988-91 V8 SJ	17227.06	33002709



STARTER COMPONENTS:

	STOCK NO.	REPLACES
1972-86 6 OR 8 CYL CJ & SJ, ARMATURE	17228.01	8120028
1978-86 6 OR 8 CYL CJ & SJ, POINT SET	17228.02	8128446
1976-86 6 OR 8 CYL, CJ & SJ, COIL FIELD, STARTER	17228.03	8128438
1972-77 6 OR 8 CYL CJ & SJ END HOUSING, STARTER	17228.04	4489353
1978-86 6 OR 8 CYL CJ & SJ, END HOUSING	17228.05	8133036
1955-63 CJ 6-VOLT STARTER DRIVE	17229.01	119597
1964-71 CJ 12-VOLT STARTER DRIVE	17229.02	931463
1972-86 6 OR 8 CYL CJ & SJ CYLINDER, STARTER DRIVE	17229.03	8120193
1988-00 6 CYL 4.2L OR 4.0L WRANGLER (YJ & TJ), STARTER DRIVE	17229.04	83503662
1987-00 6 CYL 4.0L XJ CHEROKEE & ZJ GRAND CHEROKEE, STARTER DRIVE	17229.04	83503662
1988-00 6 CYL 4.2L OR 4.0L (ALL YJ, TJ, XJ, ZJ), BRUSH SET	17228.06	83503670
1988-00 6 CYL 4.2L OR 4.0L (ALL YJ, TJ, XJ, ZJ) BRUSH HOLDER	17228.07	83503671



SOLENOIDS:

	Stock No.	Replaces
1955-71 CJ 12V, 3 TERMINAL	17230.01	919294
1972-79 CJ 6 OR 8 AUTO OR STD	17230.02	3235898
1980-87 CJ, XJ CHEROKEE, YJ WRANGLER, 6 OR 8 CYL. W/ MANUAL TRANS.	17230.03	3230406
1984-87 CJ, XJ CHEROKEE, YJ WRANGLER 4 CYL W/ MANUAL TRANS.	17230.03	3230406
1980-86 CJ 6 OR 8 CYL W/ AUTOMATIC	17230.04	5752125
1983-87 CJ, XJ CHEROKEE, YJ WRANGLER 4 CYL W/ AUTOMATIC	17230.05	3235897
1987-90 YJ WRANGLER & XJ CHEROKEE	17230.06	3236793
1987-93 XJ CHEROKEE (DIESEL MODELS)	17230.06	3236793



17230.01



17230.03

REGULATORS:

	Stock No.	Replaces
1946-63 6 VOLT, 2A, 3A, 3B, CJ5, CJ6	17231.02	923131
1946-71 12 Volt, CJ2A, 3A, 3B, CJ5, CJ6	17231.03	923130
1976-90 CJ, SJ ELECTRONIC	17226.01	8125176

TURN SIGNAL SWITCHES & COMPONENTS:

	Stock No.	Replaces
1946-67 CJ'S (UNIVERSAL TYPE)	17232.01	947348
1977-93 ALL CJ, YJ, XJ	17232.02	3229970
1976-86 CJ TURN SIGNAL SWITCH LEVER	13318.07	5362173
1981-95 CJ & WRANGLER TURN SIGNAL CAM	17232.04	4487816
1994-95 YJ WRANGLER	17232.05	56007255
1994 XJ CHEROKEE	17232.05	56007255



17231.06

ASSORTED REGULATORS

DIMMER SWITCHES:

	Stock No.	Replaces
1946-1971 ALL CJ	17233.01	811681
1972-86 ALL CJ	17233.02	5461816
1987-89 YJ WRANGLER	17233.03	3239703
1990-95 YJ WRANGLER	17233.04	56003406
1984-88 XJ CHEROKEE	17233.03	3239703
1991-96 XJ CHEROKEE	17233.04	56003406

HEADLIGHT SWITCHES & MISC. ITEMS:

	Stock No.	Replaces
1946-71 CJ2A, CJ3A, CJ3B, CJ5, CJ6	17234.01	946613
1946-71 HEADLIGHT KNOB, BLACK, (MARKED "LIGHT")	17234.02	906798
1973-79 CJ, SJ	17234.03	5450558
1979-86 CJ	17234.04	5751098
1987-95 YJ WRANGLER	17234.05	56003119
1997-99 TJ WRANGLER LIGHT SWITCH	17234.06	5269478
1981-86 WRANGLER & 1987-91 GRAND CHEROKEE	17234.07	56001861
1984-91 XJ CHEROKEE	17234.08	56001197
1992-96 XJ CHEROKEE	17234.09	4565320
1997-UP XJ CHEROKEE	17234.06	5269478
1993-98 ZJ GRAND-CHEROKEE MULTI-FUNCTION SWITCH	17234.10	4728424
1968-86 CJ H/L, WIPER, HEATER SWITCH NUT	17234.11	4000056
1968-86 CJ H/L, WIPER, HEATER SWITCH SPACER	17234.12	987911
1973-86 CJ HEADLIGHT SWITCH KNOB	13318.06	5752810
1968-86 CJ KNOB FROM HEATER & WIPER SWITCH (2 NEEDED)	13318.05	5459189
2001-04 TJ MULIT FUNCTION SWITCH WITH FOG LAMP	17234.13	5016709AC
2002-04 KJ MULTI FUNCTION SWITCH W/O FOG LAMP	17234.14	56010125AF
2002-04 KJ MULTI FUNCTION SWITCH WITH FOG LAMP	17234.15	56010126AF
1997-00 TJ MULTI FUNCTION SWITCH	17234.16	56010315AA
2001-04 TJ MULTI FUNCTION SWITCH W/O FOG LAMP	17234.17	56016708AC
1999 WJ MULTI FUNCTION SWITCH W/O AUTO H/L	17234.18	56042299AC
2001-04 TJ MULTI FUNCTION SWITCH W/O FACTORY LOG LAMPS	17234.19	5016708AC
1999-UP WJ GRAND CHEROKEE MULTI FUNCTION SWITCH	17234.20	56042299AG



17232.02



17233.03



17233.01



13318.07

NEW
NEW
NEW
NEW
NEW
NEW
NEW
NEW

HARD PARTS

BRAKE LIGHT SWITCHES:

	Stock No.	Replaces
1941-59 MB, CJ'S	17238.01	647801
1960-72 CJ 'S	17238.02	931216
1981-90 CJ, YJ, XJ (MODELS W/O CRUISE)	NEW 17238.06	5352620
1984-90 YJ WRANGLER & XJ CHEROKEE (MODELS WITH CRUISE)	17238.03	3225787
1997-04 TJ WRANGLER	NEW 17238.04	4671336
2003-04 KJ LIBERTY	NEW 17238.05	5083344AA
1991-95 YJ WRANGLER	NEW 17238.07	56006247

WIPER SWITCHES:

1987-95 YJ WRANGLER (W/O INTERMITTENT & W/O TILT)	17236.01	56000031
1987-95 YJ WRANGLER (W/ INTERMITTENT)	17236.02	56000032
1987-95 YJ WRANGLER (W/ TILT COLUMN)	NEW 17236.04	56007299
1984-93 XJ WRANGLER (W/O INTERMITTENT & W/O TILT)	17236.01	56000031
1984-96 XJ WRANGLER (W/ INTERMITTENT)	17236.02	56000032
1984-93 XJ WRANGLER (W/O INTERMITTENT & W/ TILT)	17236.03	56000431

REMANUFACTURED DISTRIBUTORS (WITH CAP & ROTOR):

1972-74 6 CYL CJ, SJ	17240.01	3184859R
1975-77 6 CYL PRESTOLITE, CJ, SJ	17240.02	3229719R

MISC. SWITCHES & RELAYS:

1994-01 XJ CHEROKEE, DOOR AJAR SWITCH	17237.01	4373296
1987-92 WRANGLER & XJ CHEROKEE RELAY FOR FOGLAMP, H/L, REAR WIPER, POWER LOCK	17237.02	33001776

FLASHERS:

	Stock No.	Replaces
1974-95 CJ, YJ WRANGLER FLASHER 2 BLADE (#552)	12411.01	5452266
1976-95 CJ, YJ WRANGLER FLASHER (#224)	12411.02	3212068
1987-95 YJ WRANGLER & XJ CHEROKEE FLASHER WITH 3 BLADE (#550)	12411.03	56000903

NEW DISTRIBUTORS & SENSORS:

1941-71 4 CYL 134 ENGINE	17239.01	923068
1978-90 6 CYL 4.2L (W / O CAP OR ROTOR)	17239.02	83506286
1978-90 6 CYL 4.2L (WITH CAP OR ROTOR)	17239.03	83506286K
1991-93 6 CYL 4.0L YJ WRANGLER, XJ CHEROKEE	17239.04	53006150
1994-97 4.0L 6 CYL YJ, TJ, XJ, ZJ	17239.05	56027028
1978-91 V8 AMC ENGINE, DISTRIBUTOR SENSOR	17241.01	8128900
1987-90 2.5L XJ & YJ WITH CARB. DISTRIBUTOR SENSOR	17241.02	83500409
1978-91 V8 AMC DISTRIBUTOR ASSEMBLY	17239.06	33004657



ASSORTED HEADLIGHT SWITCHES



17237.01

17237.02



12411.01



17238.02



17236.02



17239.04



17240.01



WIRE PLUG WIRE SET



17242.01



ASSORTED ROTORS

DISTRIBUTOR CONDENSORS:

DESCRIPTION	Stock No.	Replaces
1941-71 ALL CJ	17242.01	3204585
1972-74 8 CYL	17242.02	1928111
1972-74 6 CYL	17242.03	3204584

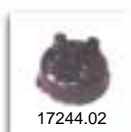

17244.02

DISTRIBUTOR POINT SETS:

	Stock No.	Replaces
1941-71 4-134 MB THRU CJ6 ALL	17243.01	923146
1948-1966 6CYL-226, 6CYL-230	17243.02	3209294
1965-1974 6 CYL 232, 258 ALL	17243.03	3204202
1972-74 8 CYL, ALL	17243.04	3200197

DISTRIBUTOR CAPS:

1941-62 4-134 MB, 2A, 3A, & 6-VOLT 3B, CJ5, CJ6	17244.01	A-9307
1960-71 4-134 12-VOLT CJ3B, CJ5, CJ6	17244.02	118343
1953-68 M38 & M38A1 4 CYL. 24 VOLT	17244.03	118717
1983-90 4 CYL AMC 150 CJ, YJ, XJ	17244.04	3234451
1991-96 4 CYL YJ WRANGLER, XJ CHEROKEE	17244.05	53006152
1948-65 226 OR 230 6 CYL ENGINES	17244.06	905554
1972-74 6 CYL CJ & SJ W/POINT IGN., ALL	17244.07	4488091
1975-77 6 CYL CJ & SJ W/PRESTOLITE IGN., ALL	17244.08	8126711
1978-90 6 CYL ALL 4.2 L CJ, YJ WRANGLER, SJ	17244.09	3230457
1987-93 6 CYL ALL 4.0 L YJ WRANGLER, XJ CHER.	17244.10	33004024
1994-00 6 CYL 4.0L YJ, TJ, XJ, ZJ	17244.11	56026876
1984-86 6 CYL V6 XJ CHEROKEE	17244.12	83501085
1972-74 8 CYL CJ & SJ WITH POINT IGNITION	17244.13	3200192
1975-77 8 CYL CJ & SJ W/PRESTOLITE, ALL	17244.14	8125448
1978-92 8 CYL CJ & SJ W/MOTORCRAFT, ALL	17244.15	3230757
1993-98 V8 GRAND CHEROKEE	17244.16	53008767



17244.10



17244.01



17244.15

IGNITION WIRE SETS:

1941-53 L-HEAD 4-134 MB, CJ2A, CJ3A	17245.01	930457
1954-71 F-HEAD 4-134 CJ3B, CJ5, CJ6	17245.02	930456
1950-53 M38 24-VOLT WATER PROOF (4 PCS)	17245.03	801111K
1952-68 M38A1 24 VOLT WATER PROOF (4 PCS)	17245.04	929630K
1983-90 4 CYL AMC 150, CJ, YJ WRANGLER, XJ CHEROKEE	17245.05	83500276
1991-00 YJ WRANGLER & XJ CHEROKEE 4 CYL	17245.06	83507180
1948-63 6 CYL 226	17245.07	908614
1972-77 6 CYL, ALL	17245.08	8129046
1978-90 6 CYL 4.2-L, ALL CJ, YJ WRANGLER, SJ	17245.09	83300088
1987-90 6 CYL 4.0L XJ CHEROKEE	17245.10	83300156
1991-00 6 CYL 4.0-L, YJ WRANGLER, XJ CHEROKEE	17245.11	83501178
1999-00 6 CYL 4.0L TJ, XJ	17245.12	5017059AA
1974-92 8 CYL CJ, SJ	17245.13	83300090
1993-98 V8 ZJ GRAND CHEROKEE	17245.14	4728190

HARD PARTS

DISTRIBUTOR ROTORS:

	Stock No.	Replaces
1941-62 4-134 MB, 2A, 3A, & 6-VOLT 3B, CJ5, CJ6	17246.01	A-1658
1960-71 4-134 12-VOLT CJ3B, CJ5, CJ6	17246.02	923392
M38, M38A1	17246.03	118879
1983-90 4 CYL AMC 150 CJ, YJ WRANGLER, XJ CHEROKEE W/ CARB & EFI	17246.04	33004795
1993-93 4 CYL XJ CHEROKEE W/MULTI-PORT FUEL INJ.	17246.05	33003389
1999-00 4 CYL. YJ WRANGLER & XJ CHEROKEE	17246.06	56027019
1972-74 6 CYL CJ & SJ, ALL POINT IGN	17246.07	4488087
1975-77 6 CYL CJ & SJ, ALL PRESTOLITE IGN	17246.08	8136633
1978-90 6 CYL ALL 4.2L CJ, YJ WRANGLER	17246.09	3230821
1987-93 6 CYL ALL 4.0 L YJ WRANGLER, XJ CHEROKEE	17246.05	33003389
1994-00 6CYL. YJ WRANGLER & XJ CHEROKEE	17246.06	56027019
1972-74 8 CYL CJ & SJ, POINT IGN	17246.12	8122343
1975-77 8 CYL CJ & SJ, PRESTOLITE IGN	17246.13	8126321
1978-92 8CYL CJ & SJ W/MOTORCRAFT, ALL	17246.14	3230765
1993-98 V8 ZJ GRAND CHEROKEE	17246.15	53008778

IGNITION COILS:

	Stock No.	Replaces
1941-1962 6 VOLT, MB, 2A, 3A,...	17247.01	649712
1963-1971 12 VOLT 4 CYL	17247.02	3208860
1983-90 4 CYL CJ, YJ WRANGLER, XJ CHEROKEE	17247.03	33004522
1991-97 2.5L YJ, TJ, XJ, ZJ	17247.04	5234210
1998-02 2.5L TJ, XJ, ZJ	17247.05	56028172AB
1972-74 6 OR 8 CYL, ALL	17247.06	3208861
1975-77 6 OR 8 CYL, PRESTOLITE IGN	17247.07	8125028
1978-90 6 CYL 4.2 L CJ, SJ, YJ WRANGLER	17247.03	33004522
1984-86 2.8L V6 XJ CHEROKEE	17247.08	83501817
1987-90 4 OR 6 CYL XJ CHEROKEE W FUEL INJ.	17247.09	T1031135
1991-97 WRANGLER (YJ & TJ), XJ CHEROKEE, ZJ GRAND CHEROKEE	17247.04	5234210
1998-02 ALL 2.5L, 1998-99 ALL 4.0L, 1998 ALL ZJ	17247.05	56028172AB
1998-99 6 CYL, 1998 V8 ZJ	17247.05	56028172AB

SPARK PLUGS:

DESCRIPTION	Stock No.	Replaces
1953-72 M38, M38A1 24V (MFG#2243)	17248.01	922727
1953-72 M38, M38A1 24V (MFG#2245)	17248.02	922727A
1941-71 MB, 2A, 3A, 3B, CJ5, CJ6, 6CYL-226	17248.03	804492
1984-93 4 CYL CJ, YJ	17248.04	3239652
1972-77 6 CYL 232, 258	17248.05	3189507
1978-79 6 CYL 232, 258	17248.06	3231345
1980-94 6 CYL 4.2-L OR 4.0-L, ALL	17248.04	3239652
1972-93 8 CYL, ALL	17248.05	3189507
1993-96 V8 ZJ, 1987-90 4.0L XJ	17248.07	56006240
1997-98 V8 ZJ, 1999 ALL	17248.08	56028189

REPLACEMENT HORNS:

1976-95 CJ & YJ WRANGLER, LOW TONE	17249.01	5758484
1976-95 CJ & YJ WRANGLER, HIGH TONE	17249.02	5758485



IGNITION SWITCHES:

1941-63 ALL EARLY MODEL FLOOR TYPES	17251.01	A-7225
1976-95 CJ, YJ WRANGLER W/O STEERING TILT	17251.02	8128889
1976-95 CJ, YJ WRANGLER WITH STEERING TILT	17251.03	3250575
2001-04 TJ WRANGLER	NEW 17251.04	4793576AB
1994-96 ZJ	NEW 17251.05	4797401
2001-04 WJ GRAND CHEROKEE	NEW 17251.06	56042476AC
1997-01 XJ & 1997-00 TJ W/O TILT	NEW 17251.07	4565326
1996-98 ZJ GRAND CHEROKEE	NEW 17251.08	56021346



IGNITION LOCK & CYLINDERS WITH KEYS:

1946-66 ALL, THREADED TERMINALS	17250.01	924918
1966-69 CJ WITH PUSH TERMINALS	17250.02	947399
1976-86 ALL CJ, SJ	17250.03	8120081K
1987-90 YJ WRANGLER, XJ	17250.04	83501971
1990-95 YJ & XJ CHEROKEE	17250.05	4720929K
1993-94 ZJ GRAND CHEROKEE	17250.06	4723289K
1996 XJ, 1995-96 ZJ	17250.07	4746310
1997-98 ZJ GRAND CHEROKEE	17250.08	4882804
1997-03 TJ & XJ, 1999-03 WJ, 2002-03 KJ	17250.09	4746667



HARD PARTS

IGNITION MODULES:

	Stock No.	Replaces
1975-77 6 OR 8 CYL, PRESTOLITE IGN	17252.01	3224964
1978-87 4, 6 OR 8 CYL CJ, YJ WRANGLER, SJ	17252.02	3230451
1984-86 4 CYL XJ CHEROKEE	17252.02	3230451
1988-90 YJ WRANGLER, XJ CHEROKEE, SJ	17252.03	53005079

ATO FUSES:

	Stock No.	Replaces
5 AMP	17253.01	6101133
7.5 AMP	17253.02	6101134
10 AMP	17253.03	6101135
15 AMP	17253.04	6101136
20 AMP	17253.05	6101137
25 AMP	17253.06	6101138
30 AMP	17253.07	6101139



MINI-FUSES:

	Stock No.	Replaces
3 AMP	17255.01	6101484
10 AMP	17255.02	6101486
15 AMP	17255.03	6101487
20 AMP	17255.04	6101488
30 AMP	17255.05	6101489



MAXI-FUSES:

	Stock No.	Replaces
20 AMP	17254.01	6101679
30 AMP	17254.02	6101640
40 AMP	17254.03	6101641
50 AMP	17254.04	6101642
60 AMP	17254.05	6101643



17253.01



17254.02



17255.02

MSD PERFORMANCE IGNITION PARTS:



DESCRIPTION	Stock No.
1966-90 6-CYL PRO-BILLET DISTRIBUTOR ASSY (MUST USE MSD6470 OR MSD6520)	MSD8516
1972-86 AMC V8 PRO-BILLET DISTRIBUTOR ASSY (MUST USE MSD6470 OR MSD6520)	MSD8519
1967-91 AMC V8 IGNITION WIRE SET (8.5 mm SUPER CONDUCTOR WIRES)	MSD31859
1945-98 ALL CJ, YJ, TJ (EXCEPT 1987-90 2.5L YJ), IGNITION CONTROL	MSD6470
1945-98 ALL CJ, YJ, TJ (EXCEPT 1987-90 2.5L YJ), REV LIMITER FOR MSD6470	MSD8769
TACH ADAPTER TO BE USED WITH STOCK AND S.W. AUTO-GAUGE,...	MSD8910
TACH ADAPTER TO BE USED WITH MAGNETIC TRIGGER	MSD8920
DIGITAL IGNITION CONTROL (DIGITAL-6 PLUS) (USE W/ MSD8252 FOR BEST RESULT)	MSD6520
1978-90 CJ & YJ BLAST HVC COIL (NOT FOR USE IN POLLUTION CONTROL VEHICLES)	MSD8252
1972-77 CJ WITH POINT IGNITION SYSTEM, BLASTER COIL	MSD8203
1978-90 CJ & YJ WITH MOTORCRAFT IGNITION, BLASTER COIL	MSD8205
1978-90 CJ & YJ WITH MOTORCRAFT IGNITION, BLASTER HIGH VIBRATION COIL	MSD8222
COIL BRACKET	MSD8213
RETAINER, COIL WIRE	MSD8217

FOR 30 YEARS MSD HAS BEEN PRODUCING QUALITY HIGH PERFORMANCE IGNITION COMPONENTS FOR ALL FORMS OF RACING AND STREET DRIVEN VEHICLES. EXTRA HORSEPOWER AND INCREASED RELIABILITY CAN BE ACHIEVED BY SIMPLY UPGRADING THE STOCK IGNITION SYSTEM. DON'T LET YOUR STOCK IGNITION BE THE WEAK LINK, GET THE IGNITION PARTS RACING TEAMS USE.

TUNE-UP KITS:

DESCRIPTION	Stock No.	Replaces
1987-90 6 CYL YJ 4.2L	17256.01	TUK-001
1991-93 6 CYL YJ 4.0L	17256.02	TUK-002
1994-95 6-CYL YJ 4.0L	17256.03	TUK-003
1997-98 6-CYL TJ 4.0L	17256.04	TUK-004
1987-90 6-CYL XJ 4.0L	17256.05	TUK-005
1991-93 6-CYL XJ 4.0L	17256.06	TUK-006
1994-96 6-CYL XJ 4.0L	17256.07	TUK-007
1997-98 6-CYL XJ 4.0L	17256.08	TUK-008
1999-00 6-CYL XJ 4.0L	17256.09	TUK-009
1993-96 6-CYL ZJ 4.0L	17256.10	TUK-010
1997-98 6-CYL ZJ 4.0L	17256.11	TUK-011
1987-90 4-CYL YJ 2.5L	17256.12	TUK-012
1991-93 4-CYL YJ 2.5LW/ EFI	17256.13	TUK-013
1991-93 4-CYL YJ 2.5LW/ CARB	17256.14	TUK-014
1994-95 4-CYL YJ 2.5L	17256.15	TUK-015
1997-98 4-CYL TJ 2.5L	17256.16	TUK-016
1987-90 4-CYL XJ 2.5L	17256.17	TUK-017
1991-93 4-CYL XJ 2.5L W/ CARB	17256.18	TUK-018
1991-93 4-CYL XJ 2.5L W/ EFI	17256.19	TUK-019
1994-96 4 CYL XJ 2.5L	17256.20	TUK-020
1997-98 4-CYL XJ 2.5L	17256.21	TUK-021
1999-00 4-CYL XJ 2.5L	17256.22	TUK-022
1993-96 8-CYL ZJ	17256.23	TUK-023
1997-98 8-CYL ZJ	17256.24	TUK-024
1999-00 6-CYL TJ 4.0L	17256.25	TUK-025
1999-00 4-CYL TJ 2.5L	17256.26	TUK-026
1978-79 6-CYL CJ 4.2L	17256.27	TUK-027
1980-82 6-CYL CJ 4.2L	17256.28	TUK-028
1983-86 6-CYL CJ 4.2L	17256.29	TUK-029
1978-81 8-CYL CJ 304	17256.30	TUK-030



17256.10



17257.76

1941-45 4-CYL MB	17257.71	TUK-101
1946-53 4-CYL CJ2A, CJ3A	17257.72	TUK-102
1953-63 CJ3B, CJ5, CJ6 (models with drop-in oil filter)	17257.73	TUK-103
1964-71 4-CYL CJ5, CJ6 (models with screwed disposable oil filter)	17257.74	TUK-104
1950-51 M38	17257.75	TUK-105
1951-68 M38A1	17257.76	TUK-106
1948-59 6-CYL 226, (models with drop-in oil filter)	17257.77	TUK-107
1960-63 6-CYL 226, (models with screwed disposable oil filter)	17257.78	TUK-108
1972-73 6-CYL CJ (with point set)	17257.79	TUK-109
1974 6-CYL CJ (with point set)	17257.80	TUK-110
1975-77 6-CYL CJ W/ PRESTOLITE DISTRIBUTOR	17257.81	TUK-111
1972-74 8-CYL CJ (models with point set)	17257.82	TUK-112
1975-77 8-CYL CJ PRESTOLITE DISTRIBUTOR	17257.83	TUK-113
1983-86 4-CYL CJ WITH 2.5L AMC engine (will not fit 1983 4-cyl CJ with GM engine)	17257.85	TUK-115



DMC-6920



17401.01



17401.04



DMC-6914



17401.08



17401.10



17401.07



17401.09

VALVE COVERS:

DESCRIPTION

DESCRIPTION	Stock No.	Replaces
1981-87 6 CYL ENGINE "JEEP" MARKED VALVE COVER:	DMC-6914	17401.02
1966-91 V8 AMC ENGINE "JEEP" MARKED VALVE COVER, PAIR:	DMC-6920	
1987-96 4 CYL 2.5L PLASTIC VALVE COVER W/O GASKET & HARDWARE	17401.01	33003857
1966-80 6 CYL 199, 232 OR 258 AMC ENGINE, BLACK STEEL W/O GASKET & HARDWARE	17401.02	3236706
1981-86 6 CYL 258 AMC ENGINE, PLASTIC VALVE COVER (INCLUDES HARDWARE)	17401.03	83501398
1981-86 6 CYL PLASTIC VALVE COVER W/ CORK GASKET	17401.04	83501398K
1981-86 6 CYL PLASTIC VALVE COVER W/ OE STYLE RUBBER GASKET	17401.05	83501398KA
1981-86 6 CYL PLASTIC VALVE COVER W/ GASKET & 2 STUDDED BRIDGES (ROCKER ARM)	17401.06	83501398KB
1981-86 6 CYL ALUMINUM VALVE COVER W/GASKET (OMIX LOGO)	17401.07	83501398K-AL
1981-86 6 CYL ALUMINUM VALVE COVER W/GASKET ("4.2 L" LOGO)	17401.08	83501398K-AL42
1981-86 6 CYL ALUMINUM VALVE COVER W/GASKET ("4.2 L" LOGO) POLISHED SHINEY	17401.09	83501398K-AL-S
1981-86 6 CYL ROCKER ARM BRIDGE W/O STUD (USE 2 WITH AL VALVE COVERS)	17408.11	MRM1718
1966-91 AMC V8 (304, 360, 390, 401,...) ALUMINUM VALVE COVER PAIR W/HARDWARE	17401.10	6910
1981-86 REPLACEMENT HARDWARE KIT W/ GASKET FOR 6 CYL ALUMINUM VALVE COVER	17402.01	258-HDW
1981-86 REPLACEMENT GASKET ONLY FOR 6 CYL ALUMINUM VALVE COVER	17447.05	8053050C-AL

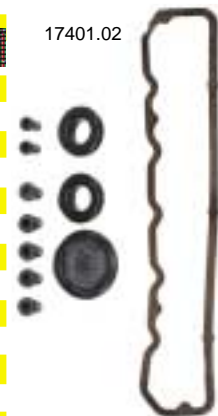

VALVE COVER GROMMETS, OIL CAPS & PCV VALVES:

DESCRIPTION

Stock No. Replaces

1982-86 4 CYL GM OR AMC 2.5L, VALVE COVER GROMMET	17402.02	3237765
1976-80 6 CYL 232 OR 258 VALVE COVER GROMMET	17402.03	3225627
1981-90 6 CYL 258 (4.2-L) VALVE COVER GROMMET	17402.02	3237765
1973-91 8 CYL 304, 360, 390, 401 VALVE COVER GROMMET	17402.05	4006019
1980-82 4 CYL GM 151 OIL CAP	17403.01	8132312
1983-93 4 CYL AMC 2.5L OIL CAP	17403.02	33001016
1974-80 6 CYL AMC 232 OR 258, OIL CAP	17403.01	8132312
1981-90 6 CYL 4.2L OR 4.0L, OIL CAP	17403.02	33001016
1996-02 ALL 4.0L, 1994-98 V8 ZJ, OIL CAP	17403.03	53020342
V8 AMC OIL CAP	17402.04	3220248
1980-89 4 CYL PCV VALVE	17404.01	8132309
1983-86 6 CYL PCV VALVE	17404.02	33000887
1971-83 8 CYL PCV VALVE	17404.03	3234216
1993 V8 ZJ GRAND CHEROKEE PCV VALVE	17404.04	4206923
1994-98 V8 ZJ GRAND CHEROKEE PCV VALVE	17404.05	53031135



17405.01



17405.03

ENGINE KITS INCLUDE: PISTONS, RINGS, MAIN & ROD BEARINGS, CAM BEARING, TIMING KIT, FULL GASKET/SEAL SET, 8 VALVES, 8 VALVE GUIDES, OIL PUMP & ENGINE MOUNTS.

PLEASE SPECIFY PISTON SIZE AND MAIN & ROD BEARING SIZE. WHEN ORDERING

ENGINE KITS:



17406.01

DESCRIPTION

DESCRIPTION	Stock No.	Replaces
1941-47 L-HEAD 134 W/ TIMING CHAIN MB & EARLY CJ2A	17405.01	134LHK-P-MB-RB
1948-71 L-HEAD 134 W/ TIMING GEAR	17405.02	134LHK2-P-MB-RB
1954-71 F-HEAD 4 CYL 134 ENGINE	17405.03	134FHK-P-MB-RB

CRANKSHAFT:

1947-71 4 CYL 134 ENGINE (Will Not Fit MB & Early CJ-2A)	Stock No. 17406.01 647078
--	---------------------------

CYLINDER HEAD:

1987-90 4.2L YJ WRANGLER	17407.01	83503322
--------------------------	----------	----------

HARD PARTS

**VALVE TRAIN COMPONENTS
(PUSH RODS, ROCKER ARMS & COMPONENTS):**



**EXHAUST VALVES & GUIDES
(SOLD SEPARATELY, NOT A SET):**

DESCRIPTION	Stock No.	Replaces
1941-71 4 CYL L-HEAD	17415.01	637183
1956-71 4 CYL F-HEAD	17415.02	802639
1941-71 4 CYL L-HEAD & F-HEAD EXH. VALVE GUIDE	17416.01	119137
1987-99 4 CYL 2.5L, STD	17415.03	4637537
1987-99 4 CYL 2.5L, .015 OVER	17415.04	4637539
1973-80 6 CYL 232, 258 OR 8 CYL 304 (STD.)	17415.05	3224597
1973-80 6 CYL 232, 258 OR 8 CYL 304, .003 OVER	17415.06	3224602
1973-80 6 CYL 232, 258 OR 8 CYL 304, .015 OVER	17415.07	3224603
1981-90 6 CYL 258 OR 8 CYL 304 (STD.)	17415.08	3237464
1981-90 6 CYL 258 OR 8 CYL 304, .003 OVER	17415.09	3240163
1981-90 6 CYL 258 OR 8 CYL 304, .015 OVER	17415.10	3240164
1987-99 6 CYL 4.0L, STD.	17415.03	4637537
1987-99 6 CYL 4.0L, .015 OVER	17415.04	4637539
1975-93 8 CYL 360, 401 STD.	17415.11	3224598
1993-98 V8 5.2L ZJ GRAND CHEROKEE, STD.	17415.12	53006724

DESCRIPTION

DESCRIPTION	Stock No.	Replaces
1953-71 UN-ASSEMBLED VALVE ROCKER KIT: (INCLUDES 2 LEFT ARMS, 2 RIGHT ARMS, 4 BRACKETS AND 1 SHAFT)	CJ3B, CJ5, CJ6, M38A1 17411.01	805402
1953-71 4 CYL F-HEAD ROCKER ARM BRACKET (EACH)	CJ3B, CJ5, CJ6, M38A1 17408.02	802295
1953-71 4 CYL F-HEAD ROCKER ARM LEFT (EACH)	CJ3B, CJ5, CJ6, M38A1 17408.03	805375
1953-71 4 CYL F-HEAD ROCKER ARM RIGHT (EACH)	CJ3B, CJ5, CJ6, M38A1 17408.04	805376
1953-71 4 CYL F-HEAD ROCKER ARM SHAFT (EACH)	CJ3B, CJ5, CJ6, M38A1 17408.05	805368
VALVE SPRING, INTAKE (L HEAD), EXHAUST (L-HEAD AND F-HEAD)	17409.01	638636
VALVE SPRING, INTAKE, F-HEAD 4 CYL 134 ENGINE	17409.02	800417
VALVE TAPPET, INTAKE F-HEAD 4 CYL 134 ENGINE	17418.01	800550
1987-02 4 CYL 2.5L PUSH ROD	17410.01	3241709
1972-77 6 CYL 232 OR 258, PUSH ROD (TEMP SEND UNIT IN FRONT OF CYL. HEAD)	17410.02	3214013
1977-80 6 CYL 258, PUSH ROD (1977 MODELS WITH TEMP SEND UNIT IN REAR OF HEAD)	17410.03	3227329
1981-90 6 CYL 258 (4.2L), PUSH ROD	17410.04	3242395
1987-04 6 CYL 4.0L, PUSH ROD	TBA 17410.05	
1972-91 V8 AMC, PUSH ROD	17410.06	3214014
1983-02 4 CYL 2.5L, ROCKER ARM	17408.06	3242393
1974-82 6 CYL 232 OR 258, ROCKER ARM	17408.07	3223888
1983-90 6 CYL 258 (4.2L), ROCKER ARM	17408.06	3242393
1987-04 6 CYL 4.0L, ROCKER ARM	17408.06	3242393
1972-91 V8 AMC, ROCKER ARM	17408.14	3223539
1968-74 6 CYL AMC 232 OR 258, ROCKER ARM SHAFT	17408.09	8125322
1983-02 4 CYL 2.5L, ROCKER ARM PIVOT	17408.10	3235090
1981-90 6 CYL 4.2L, ROCKER ARM PIVOT	17408.10	3235090
1987-04 6 CYL 4.0L, ROCKER ARM PIVOT	17408.10	3235090
1972-91 V8 AMC, ROCKER ARM PIVOT	17408.10	3235090
1983-96 4 CYL 2.5L, ROCKER ARM BRIDGE	17408.11	MRM1718
1983-90 6 CYL 4.2L, ROCKER ARM BRIDGE (W/O STUD)	17408.11	MRM1718
1983-90 6 CYL 4.2L, ROCKER ARM BRIDGE (WITH STUD) NEED 2 W/ PLASTIC VALVE COVER	17408.12	3237851
1987-96 6 CYL 4.0L, ROCKER ARM BRIDGE	17408.11	MRM1718
1972-79 6 CYL CJ ROCKER ARM PIVOT	17408.13	3210178
1972-91 V8 AMC, ROCKER ARM BRIDGE	17408.11	MRM1718
1974-82 6 CYL 232 OR 258 (4.2L), ROCKER ARM KIT (2 ARMS+2 PIVOTS+1 BRIDGE)	17411.02	MRK5412
1983-90 6 CYL 4.2L, ROCKER ARM KIT (2 ARMS+2 PIVOTS+1 BRIDGE W/O STUD)	17411.03	MRK5512
1983-90 6 CYL 4.2L, ROCKER ARM KIT (2 ARMS+2 PIVOTS+1 BRIDGE W/ STUD)	17411.04	MRK5522
1972-91 V8 AMC, ROCKER ARM KIT (2 ARMS+2 PIVOTS+1 BRIDGE)	17411.05	MRK5442

**INTAKE VALVES & GUIDES
(SOLD SEPARATELY, NOT A SET):**

DESCRIPTION	Stock No.	Replaces
1941-71 4 CYL L-HEAD	17417.01	637182
1956-71 4 CYL F-HEAD	17417.02	994946
1941-71 4 CYL L-HEAD VALVE GUIDE	17416.02	119136
1956-71 4 CYL F-HEAD	17416.03	119138
1987-99 4 CYL 2.5L, STD.	17417.03	33003515
1987-99 4 CYL 2.5L, .015 OVER	17417.04	33003575
1973-80 6 CYL 232, 258 OR 8 CYL 304 (STD.)	17417.05	3218732
1973-80 6 CYL 232, 258 OR 8 CYL 304, .003 OVE	17417.06	3218809
1973-80 6 CYL 232, 258 OR 8 CYL 304, .015 OVE	17417.07	3218810
1981-90 6 CYL 258 OR 8 CYL 304 (STD.)	17417.08	3237465
1981-90 6 CYL 258 OR 8 CYL 304, .003 OVER	17417.09	3240166
1981-90 6 CYL 258 OR 8 CYL 304, .015 OVER	17417.10	3240167
1987-99 6 CYL 4.0L, STD.	17417.03	33003515
1987-99 6 CYL 4.0L, .015 OVER	17417.04	33003575
1987-93 8 CYL 360, 401 STD.	17417.11	3229657
1993-98 V8 5.2L ZJ GRAND CHEROKEE, STD.	17417.12	53006723

VALVE LIFTERS & TAPPETS:

DESCRIPTION	Stock No.	Replaces
1941-71 4 CYL 134, VALVE LIFTER (L-HEAD INTAKE & EXHAUST), (F-HEAD EXHAUST)	17418.02	991630
1983-96 4 CYL 2.5L, HYDRAULIC LIFTERS (ORDER 8 FOR SET)	17418.03	3189883
1974-90 6 CYL 232 OR 258 HYDRAULIC LIFTERS (ORDER 12 FOR SET)	17418.03	3189883
1987-96 6 CYL 4.0L HYDRAULIC LIFTERS (ORDER 12 FOR SET)	17418.03	3189883
1971-93 8 CYL AMC, HYDRAULIC LIFTERS (ORDER 16 FOR SET)	17418.03	3189883
1993-98 V8 ZJ GRAND CHEROKEE HYDRAULIC LIFTERS (ORDER 16 FOR SET)	17418.04	4713439



VALVE LIFTERS



17420.01

CAMSHAFT & LIFTER KITS:

(camshaft kit includes: camshaft, lifters & 4 oz. assembly lube)

DESCRIPTION	Stock No.	Replaces
1968-78 6 CYL 232, 1971-76 258, 1977-78 258 W/ ONE BARREL CARB	17420.01	CLSRC6
1979-80 6 CYL 258 W/ 2 BARREL CARB AND MANUAL TRANSMISSION	17420.01	CLSRC6
1981-90 6 CYL AMC 258 (4.2L)	17420.02	CLSRC8
1971-91 V8 AMC 304, 360, 401	17420.03	CLSRC5

CAMSHAFTS:

DESCRIPTION	Stock No.	Replaces
1941-1948 MB & EARLY 2A WITH CHAIN TIMING (LIMITED QUANTITY)	17421.01	637065
1949-53 LATE CJ2A, 3A & M38 WITH TIMING GEAR (LIMITED QUANTITY)	17421.02	641284
1953-71 4 CYL F-HEAD 134 CAMSHAFT	17421.03	800517
1983-92 4 CYL 2.5L, CAMSHAFT	17421.04	83500249
1991-93 4 CYL 2.5L, CAMSHAFT	17421.05	TBA
1964-66 6 CYL 230 TORNADO CAMSHAFT	17421.06	932959
1965-78 6 CYL 232 OR 258 CAMSHAFT	17421.07	8132907
1979-90 6 CYL 258 CAMSHAFT	17421.08	8133009
1987-95 6 CYL 4.0L CAMSHAFT	17421.09	83503402
1971-93 8 CYL 304, 360 OR 401 CAMSHAFT (EACH)	17421.10	8121156



17421.08



17421.03

CAMSHAFT BEARINGS:

DESCRIPTION	Stock No.	Replaces
1941-71 4 CYL 134 CAMSHAFT BEARING STD.	17422.01	645595
1941-71 4 CYL 134 CAMSHAFT BEARING .010 OVER	17422.02	645595.010
1983-99 4 CYL 2.5L, CAM BEARING SET, STD.	17422.03	3205711
1983-96 4 CYL 2.5L, CAM BEARING SET, .010 OVER	17422.04	3208985
1948-64 6 CYL 226 CAMSHAFT BEARING KIT	17422.05	711873K
1968-90 6 CYL 199, 232 OR 258 (4.2L), CAM BEARING SET, STD.	17422.03	3205711
1968-90 6 CYL 199, 232 OR 258 (4.2L), CAM BEARING SET, .010 OVER	17422.04	3208985
1987-99 6 CYL 4.0L, CAM BEARING SET, STD.	17422.03	3205711
1987-98 6 CYL 4.0L, CAM BEARING SET, .010 OVER	17422.04	3208985
1971-92 V8 AMC, CAM BEARING SET, STD.	17422.06	4486286



17423.02 17423.01



17424.01

AMC V8 MISC. COMPONENTS:

DESCRIPTION	Stock No.	Replaces
1967-91 8 CYL ALL AMC, CAMSHAFT MOUNTED DISTRIBUTOR DRIVE GEAR	17423.01	4486635
1967-91 8 CYL ALL AMC, DISTRIBUTOR MOUNTED DISTRIBUTOR DRIVE GEAR	17423.02	3208615
1972-83 AMC V8 OIL DIPSTICK & TUBE	17424.01	3190848K
1972-83 CJ V8 & OTHER AMC V8's, DIP STICK TUBE, ENGINE OIL	17424.02	3190848
1972-83 CJ V8 & OTHER AMC V8's, DIP STICK, ENGINE OIL	17424.03	3224880

TBA= TO BE ANNOUNCED

PISTONS WITH PINS
(PISTONS ARE SOLD SEPARATELY, NOT A SET):



PISTONS (4 x # 17427.01)



RING SETS CONTINUED
ON NEXT PAGE...

DESCRIPTION	Stock No.	Replaces
1941-71 4 CYL 134, STD	17427.01	8121654
1941-71 4 CYL 134, .020 OVER	17427.02	801538
1941-71 4 CYL 134, .030 OVER	17427.03	801539
1941-71 4 CYL 134, .040 OVER	17427.04	8121658
1941-71 4 CYL 134, .060 OVER	17427.05	8121654.060
1941-71 4 CYL 134, .080 OVER	17427.06	8121654.080
1983-95 4 CYL 2.5L, STD.	17427.07	83500251
1983-93 2.5L 0.020 OVERSIZE	17427.08	83500251.020
1983-93 2.5L 0.030 OVERSIZE	17427.09	83500251.030
1983-93 2.5L 0.040 OVERSIZE	17427.10	83500251.040
1983-93 2.5L 0.010 OVERSIZE	17427.11	83500252
1996-02 4 CYL 2.5L, STD.	17427.12	4798329
1948-63 6 CYL 226, STD.	17427.13	732120
1948-63 6 CYL 226, .020 OVER	17427.14	732122
1948-63 6 CYL 226, .030 OVER	17427.15	732123
1948-63 6 CYL 226, .040 OVER	17427.16	732124
1948-63 6 CYL 226, .060 OVER	17427.17	732124.060
1948-64 6 CYL 226 PISTON PIN BUSHING SET (6 PCS)	17428.01	701331K6
1966-78 6 CYL 232 OR 258 STD.	17427.18	4488672
1966-78 6 CYL 232 OR 258, .020 OVER	17427.19	4488672.020
1966-78 6 CYL 232 OR 258, .030 OVER	17427.20	4488672.030
1979-90 6 CYL 4.2L (258), STD.	17427.21	8134441
1979-90 6 CYL 4.2L (258), .020 OVER	17427.22	8134441.020
1979-90 6 CYL 4.2L (258), .030 OVER	17427.29	8134441.030
1987-93 6 CYL 4.0L, STD.	17427.07	83500251
1983-93 4.0L 0.020 OVERSIZE	17427.08	83500251.020
1983-93 4.0L 0.030 OVERSIZE	17427.09	83500251.030
1983-93 4.0L 0.040 OVERSIZE	17427.10	83500251.040
1983-93 4.0L 0.010 OVERSIZE	17427.11	83500252
1996-00 6 CYL 4.0L, STD.	17427.12	4798329
1970-91 8 CYL AMC 304, STD.	17427.23	4487564
1971-91 8 CYL AMC 304, .030 OVER	17427.24	4487564.030
1970-91 8 CYL AMC 360, STD.	17427.25	8133807
1970-91 8 CYL AMC 360, .030 OVER	17427.26	8133807.030
1970-91 8 CYL AMC 401, STD.	17427.27	8120580
1970-91 8 CYL AMC 401, .030 OVER	17427.28	8120580.030

PISTON RING SETS
(RING SETS SOLD PER ENGINE, UNLESS OTHERWISE NOTED):

1941-71 4 CYL 134, STD	17430.01	941885
1941-71 4 CYL 134, .020 OVER	17430.02	941887
1941-71 4 CYL 134, .030 OVER	17430.03	841888
1941-71 4 CYL 134, .040 OVER	17430.04	841889
1941-71 4 CYL 134, .060 OVER	17430.05	841889.060
1941-71 4 CYL 134, .080 OVER	17430.06	841889.080
1983-93 4 CYL 2.5L AMC, STD. (FOR ONE PISTON ONLY)	17430.07	83501987
1983-93 4 CYL 2.5L AMC, .010 OVER (FOR ONE PISTON ONLY)	17430.08	83501988
1983-93 4 CYL 2.5L AMC, STD. (FOR 4 PISTONS)	17430.09	83501987K4
1983-93 4 CYL 2.5L AMC, .010 OVER (FOR 4 PISTONS)	17430.10	83501988K4
1983-93 4 CYL 2.5L AMC, .020 OVER (FOR 4 PISTONS)	17430.11	83501987K4.020
1983-93 4 CYL 2.5L AMC, .030 OVER (FOR 4 PISTONS)	17430.12	83501987K4.030
1947-63 6 CYL 226, STD.	17430.13	916688
1947-63 6 CYL 226, .010 OVER	17430.14	916689
1947-63 6 CYL 226, .020 OVER	17430.15	916690
1947-63 6 CYL 226, .030 OVER	17430.16	916691
1947-63 6 CYL 226, .040 OVER	17430.17	916692
1947-63 6 CYL 226, .060 OVER	17430.18	916693
1968-90 6 CYL 199, 232 OR 258 (4.2L), STD.	17430.19	4485572
1968-90 6 CYL 199, 232 OR 258 (4.2L), .020 OVER	17430.20	448572.020
1968-90 6 CYL 199, 232 OR 258 (4.2L), .030 OVER	17430.21	4485572.030
1968-90 6 CYL 199, 232 OR 258 (4.2L), .040 OVER	17430.22	4485572.040
1968-90 6 CYL 199, 232 OR 258 (4.2L), .060 OVER	17430.23	4485572.060
1987-93 6 CYL 4.0L (242), STD. (FOR ONE PISTON ONLY)	17430.07	83501987
1987-93 6 CYL 4.0L (242), .010 OVER (FOR ONE PISTON ONLY)	17430.08	83501988

HARD PARTS

CONTINUED FROM PREVIOUS PAGE:

PISTON RING SETS
(RING SETS SOLD PER ENGINE, UNLESS OTHERWISE NOTED):



1987-93 6 CYL 4.0L (242), STD (FOR 6 PISTONS)	17430.24	83501987K6
1987-93 6 CYL 4.0L (242), .010 OVER (FOR 6 PISTONS)	17430.25	83501988K6
1987-93 6 CYL 4.0L (242), .020 OVER (FOR 6 PISTONS)	17430.26	83501987K6.20
1987-93 6 CYL 4.0L (242), .030 OVER (FOR 6 PISTONS)	17430.27	83501987K6.030
1971-91 AMC V8 304, STD.	17430.28	3207514
1971-91 AMC V8 304, .020 OVER	17430.29	3207514.020
1971-91 AMC V8 304, .030 OVER	17430.30	3207514.030
1971-91 AMC V8 360, STD.	17430.31	3208066
1971-91 AMC V8 360, .010 OVER	17430.32	3208067
1971-91 AMC V8 360, .020 OVER	17430.33	3208066.020
1971-91 AMC V8 360, .030 OVER	17430.34	3208066.030
1971-91 AMC 401, STD.	17430.35	3208919
1971-91 AMC 401, .020 OVER	17430.36	3208919.020
1971-91 AMC 401, .030 OVER	17430.37	3208919.030
1993-98 V8 5.2L ZJ GRAND CHEROKEE, STD .	17430.38	4720727
1993-98 V8 5.2L ZJ GRAND CHEROKEE, .020 OVER	17430.39	4720727.020
1993-98 V8 5.2L ZJ GRAND CHEROKEE, .030 OVER	17430.40	4720727.030

OIL PUMPS:
DESCRIPTION

1941-47 MB & EARLY CJ2A 4 CYL	17433.01	804769
1947-71 LATE CJ2A THRU CJ 4CYL. 134	17433.02	804484
1983-96 2.5L 4.0 CYL	17433.03	324214
1948-63 6 CYL 226	17433.04	733653
1965-80 6 CYL 232 OR 258 W/O SCREEN	17433.05	3181340W/O
1965-80 SCREEN FOR ABOVE OIL PUMP	17433.06	3181340S
1965-80 OIL PUMP WITH SCREEN	17433.07	3181340
1981-90 6 CYL 258 ENG. W/O SCREEN, 1987-99 4.0L	17433.03	3242141W/O
1981-90 6 CYL, 258 ENG., SCREEN	17433.08	3242141S
1981-90 6 CYL, 258 ENG., OIL PUMP WITH SCREEN	17433.09	3242141
1968-90 6 CYL AMC 199, 232 OR 258 HI VOLUME OIL PUMP W/ SCREEN	17433.10	M81AHVS3
1971-93 8 CYL OIL PUMP REPAIR KIT	17433.11	3184086K
1971-91 8 CYL AMC, OIL PUMP SCREEN ONLY	17433.12	3216049

OIL FILTERS:

(SEE OUR COMPLETE LINE OF K & N FILTERS ON PAGE 42)

1941-68 4 CYL 134 L-HEAD ENGINE OIL FILTER BRACKET	17435.01	A-1247
1941-71 MB, M38, M38A1 (DROP IN)	17436.01	119952
1956-67 CIVILIAN 4-134 (DROP IN)	17436.02	909335
1956-67 CJ 4 CYL F-HEAD OIL FILTER CARTRIDGE ASSEMBLY	17436.03	808042
1964-71 4 CYL 134 ENGINE	17436.04	8990508
1964-71 4 CYL 134 ENGINE, OIL FILTER COVER	17436.05	929838
1980-86 4 CYL	17436.06	8132313
1987-90 4 CYL, 1987-96 4 CYL EXPORT	17436.07	33004195
1991-02 4 CYL	17436.08	5281090
2003 4 CYL TJ, 2002-UP KJ LIBERTY	17436.09	4105409
1972-73 6 CYL CJ	17436.10	8991072
1974-80 6 CYL	17436.11	8993146
1981-86 6 CYL	17436.12	3242397
1984-86 V6	17436.06	8132313
1987-90 6 CYL 4.0-L OR 4.2-L	17436.07	33004195
1991-04 6 CYL 4.0-L	17436.08	5281090
2002-UP 3.7L V6 KJ LIBERTY	17436.13	4781452AA
1972-83 8 CYL	17436.11	8993146
1993-03 V8 ZJ & WJ (5.2L, 5.9L, 4.7L)	17436.08	5281090
OIL FILTER, ALL 3.1L DIESEL ENGINES (EXPORT MARKETS) NEW	17436.15	5015171AA

OIL PAN GASKET SETS & PLUGS:

1941-71 4 CYL 134 ENGINE, DRAIN PLUG	17438.01	639979
1941-71 4 CYL 134 ENGINE, DRAIN PLUG GASKET	17438.02	806515
1968-90 6 CYL 4.2L, OIL PAN PLUG	17438.03	83501425
1992-UP 4.0L 6 CYL, OIL PAN DRAIN PLUG NEW (YJ,TJ,XJ,ZY,WY)	17438.04	6035417
1941-71 4 CYL 134	17439.01	639980
1983-90 4 CYL 2.5L	17439.02	83504661
1996-02 4 CYL 2.5L OIL PAN GASKET, MOLDED RUBBER	17439.04	6035417
1968-90 6 CYL 232 OR 258	17439.05	4488770
1968-90 6 CYL 232 OR 258 1-PIECE MOLDED RUBBER OIL PAN GASKET	17439.06	53007568
1987-04 6 CYL 4.0L	17439.06	53007568
1970-93 8 CYL 304, 360 OR 401	17437.07	3206690



OIL FILTERS



OIL PANS:

1968-90 6 CYL AMC 199, 232, 258 (4.2L)	17437.01
1987-03 6 CYL 4.0L	17437.02



HARD PARTS

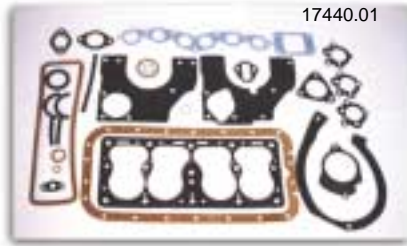

17440.01

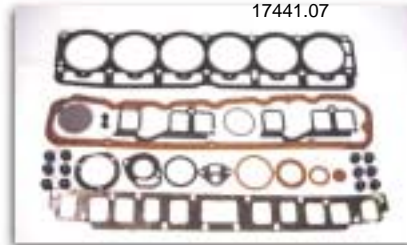

17441.07



17442.04



17443.05

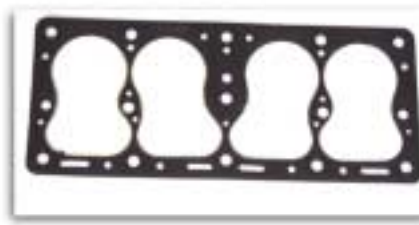

17446.01



17447.03

OVERHAUL GASKET & SEAL KITS:

DESCRIPTION	Stock No.	Replaces
1941-71 4 CYL L-HEAD	17440.01	810584
1953-71 4 CYL F-HEAD	17440.02	810585
1947-61 226 6 CYL (WILL NOT FIT 1962-64)	17440.03	907579
1968-80 6 CYL AMC 199, 232 OR 258	17440.04	4485657
1981-90 6 CYL 4.2L	17440.05	FS31151
1987-90 6 CYL 4.0L	17440.06	FS32950
1971-92 8 CYL AMC 304	17440.07	8124693
1971-92 8 CYL AMC 360 OR 401	17440.08	8122341

UPPER GASKET SETS:

1941-71 L-HEAD 4 CYL	17441.01	802030
1954-71 F-HEAD 4 CYL	17441.02	801344
1980-83 4 CYL CJ WITH 151 GM ENGINE	17441.03	8134134
1983-86 4 CYL AMC 2.5L	17441.04	83500255
1987-93 4 CYL 2.5L	17441.05	83504346
1965-80 6 CYL 232 OR 258	17441.06	8125721
1981-90 6 CYL 258	17441.07	8133352
1987-90 6 CYL 4.0L	17441.08	83505141
1991-00 6 CYL 4.0L	17441.09	4636982
1970-83 8 CYL 304	17441.10	8128191
1970-92 8 CYL, 360 OR 401	17441.11	8128192

LOWER GASKET SETS:

1980-83 4 CYL CJ WITH 151 GM ENGINE	17442.01	8134322
1983-92 4 CYL AMC 2.5L	17442.02	83505399
1993-00 4 CYL 2.5L	17442.03	4713023
1965-90 6 CYL 232, 258	17442.04	8125722
1987-91 6 CYL 4.0L	17442.04	8125722
1992-00 6 CYL 4.0L	17442.06	4740008
1971-92 8 CYL 304, 360, 401	17442.07	8125727

VALVE STEM SEALS:

1983-85 4 CYL 2.5L (BOTH EXHAUST & INTAKE)	17443.01	3242864
1987-93 4 CYL 2.5L EXHAUST	17443.02	33002522
1987-93 4 CYL 2.5L INTAKE	17443.03	33002729
1994-98 4 CYL 2.5L EXHAUST	17443.04	53009887
1968-90 6 CYL AMC 199, 232, 258 (BOTH EXHAUST & INTAKE)	17443.05	3218976
1971-91 V8 AMC 304, 360, 401 (BOTH EXHAUST & INTAKE)	17443.05	3218976
1987-93 6 CYL 4.0L EXHAUST	17443.02	33002522
1987-93 6 CYL 4.0L INTAKE	17443.03	33002729

HEAD GASKETS:

1941-71 4 CYL L-HEAD	17446.01	638540
1956-71 4 CYL F-HEAD	17446.02	807036
1948-63 6-CYL L-HEAD 226	NEW 17446.09	928731
1968-90 6 CYL AMC 199, 232 OR 258	17446.04	3237756
1987-96 6 CYL 4.0L	17446.05	53020219
1971-91 V8 AMC 304	17446.06	3197636
1971-91 V8 AMC, 360 OR 401	17446.07	3227352
1967-92 V8 AMC - Heavy Duty	NEW 17446.08	HG31190HT

VALVE COVER GASKETS:

1956-71 4 CYL F-HEAD	17447.01	648798
1965-80 6 CYL 232 OR 258	17447.02	3227854
1981-86 6 CYL 258 (CORK)	17447.03	8053050C
1981-86 6 CYL 258 (4.2L) OE STYLE RUBBER GASKET	17447.04	8053050
1981-86 6 CYL 258 (4.2L) WITH ALUMINUM VALVE COVER	17447.05	8053050C-AL
1970-91 8 CYL ALL	17447.06	3181291
2002-UP 2.4 KJ & 2003-UP 2.4L TJ	NEW 17447.07	4777478
1993-98 5.2L & 5.9L ZJ GRAND-CHEROKEE	NEW 17447.08	53006695
1996-05 4.0L (TJ, XJ, ZJ & WJ)	NEW 17447.09	53020758AC
1997-03 4.7L WJ, LH	NEW 17447.10	53020877
2002-05 3.7L, LH	NEW 17447.11	53020991

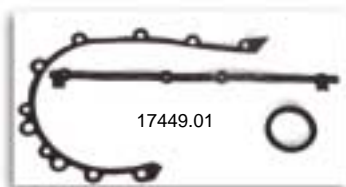

TIMING COVER GASKET SETS WITH OIL SEALS:

1965-90 6 CYL 232, 258	17449.01	8129097
1971-93 8 CYL ALL	17449.02	8129098

EXHAUST PIPE & MISC. EXHAUST GASKETS:

1946-71 4 CYL 134	17450.01	634814
1968-90 6 CYL AMC 199, 232, 258	17450.02	3216643
1971-91 V8 AMC 304, 360, 401	17450.03	3216644
1991-92 6 CYL 4.0L, EXH. PIPE	17450.04	52005431
1987-90 4 CYL OR 6 CYL EXHAUST RECIRCULATE	17450.05	33004185
1948-64 6 CYL. 226 EXHAUST FLANGE GASKET	17450.06	745608

EXHAUST & INTAKE MANIFOLD GASKET SETS:

1941-71 4 CYL L-HEAD	17451.01	A-7835
1956-71 4 CYL F-HEAD	17451.02	801345
2002-05 2.4L (KJ & TJ)	NEW 17451.12	53013534AA
1965-80 6 CYL 232 OR 258	17451.03	3242855K
1981-90 6 CYL 258	17451.04	3237775K
1987-90 6 CYL 4.0L	17451.05	53020122K
1991-96 6 CYL 4.0L	17451.06	53010238K
2000-05 4.0L (1999-04 4.0L WJ)	NEW 17451.11	4854038
2002-05 3.7L, RH SIDE	NEW 17451.13	53031090
1971-93 8 CYL INTAKE, ALL	17451.06	8125869
1971-93 8 CYL EXHAUST, ALL	17451.08	3237270

TIMING SETS:

(INCLUDES: CAM GEAR, CRANK GEAR & CHAIN (IF APPLICABLE))

1941-47 4 CYL MB, EARLY CJ2A W/CHAIN	17452.01	638457K
1947-71 4 CYL 134 CJ2A THRU CJ6 (W/O CHAIN)	17452.02	948137K
1983-95 4 CYL AMC 150 ENGINE	17452.03	3242300K
1948-58 6 CYL EARLY 226	17452.04	707289K
1959-63 6 CYL LATE 226	17452.05	920280K
1965-90 6 CYL 232 OR 258	17452.06	3240502K
1970-79 8 CYL 5/8" TEETH WIDTH	17452.07	3185270K
1980-93 8 CYL 1/2" TEETH WIDTH	17452.08	3234433K
1993-98 V8 5.2L ZJ GRAND CHEROKEE	17452.09	83507095



TIMING CHAINS:

	Stock No.	Replaces
1941-47 4 CYL 134 MB & EARLY CJ2A	17453.01	638457
1983-01 4 CYL 2.5L	17453.02	3242300
1983-01 4 CYL 2.5L TENSIONER	17453.03	33003421
1948-58 6 CYL 226	17453.04	707289
1959-63 6 CYL 226	17453.05	920280
1966-71 V6 225	17453.06	1359707
1963-67 6 CYL 230	17453.07	926002
1968-90 6 CYL 199, 232, 258 (4.2L)	17453.08	3240502
1987-93 6 CYL 4.0L	17453.09	33002977
1994-04 6 CYL 4.0L	17453.10	53020444
1987-01 6 CYL 4.0L TENSIONER	17453.11	33003421
1971-92 V8 AMC, 1/2" WIDE	17453.12	3234433
1971-92 V8 AMC, 5/8" WIDE	17453.13	3185270
1993-98 V8 5.2L & 5.9L ZJ GRAND CHEROKEE	17453.14	53005773
3.7L & 4.7L WJ GRAND CHEROKEE	NEW 17453.15	5013867AA-PR
1999-04 4.7L WJ (2 REQUIRED PER ENGINE)	NEW 17453.16	5013867AA-SE
2002-UP 3.7L (2 REQUIRED PER ENGINE)	NEW 17453.17	5019423ACSE

TIMING COVERS:

	Stock No.	Replaces
1983-90 4 CYL 2.5L	17457.01	53005769
1993-UP 2.5L ENGINE, WITH MOLDED RUBBER OIL PAN GASKET	17457.02	4796591
1965-90 6 CYL 232 or 258	17457.01	53005769
1993-UP 4.0L ENGINE, WITH MOLDED RUBBER OIL PAN GASKET	17457.03	4796592
1993-UP 6 CYL 4.0L & 1993-UP 4 CYL 2.5L	17457.04	53020222
1973-91 V8 AMC 304, 360, 401	17457.05	8129373
1983-92 2.5L WITH MOLDED RUBBER OIL PAN GASKET	NEW 17457.06	4720221
1975-92 6 CYL 4.2 & 4.0L WITH MOLDED OIL PAN GASKET	NEW 17457.07	4720223

CAMSHAFT GEARS OR SPROCKETS:

DESCRIPTION	Stock No.	Replaces
1941-47 4 CYL 134 MB & EARLY CJ2A (MODELS WITH CHAIN)	17454.01	638458
1948-71 4 CYL 134 (MODELS W/O CHAIN)	17454.02	948137
1983-01 4 CYL 2.5L	17454.03	3242280
1948-58 6 CYL 226 (BEFORE SERIAL # TW-6-L-90919)	17454.04	707288
1959-63 6 CYL 226 (AFTER SERIAL # TW-6-L-90919)	17454.05	920282
1966-71 V6 225	17454.06	1195077
1968-90 6 CYL AMC 199, 232, 258, STEEL (FOR U.S. MODELS)	17454.07	3206693
1968-90 6 CYL AMC 199, 232, 258, NYLON (FOR EXPORT MODELS)	17454.08	3206693N
1987-93 6 CYL 4.0L	17454.09	33002978
1994-01 6 CYL 4.0L	17454.10	53020445
1971-91 V8 AMC 304, 360, 401, 5/8" WIDE	17454.11	3197138
1971-91 V8 AMC 304, 360, 401, 1/2" WIDE	17454.12	3234234
1993-98 V8 5.2L & 5.9L ZJ GRAND CHEROKEE	17454.13	4448675
1999-04 4.0L	NEW 17454.14	53010557AA
LH SIDE OF 4.7L	NEW 17454.15	53020938
RH SIDE OF 4.7L	NEW 17454.16	53021169AA
3.7L IDLER SPROCKET	NEW 17455.14	53021170AA
LH SIDE OF 3.7L	NEW 17454.17	53021290AC
RH SIDE OF 3.7L	NEW 17454.18	53021291AC



TBA= TO BE ANNOUNCED

HARD PARTS

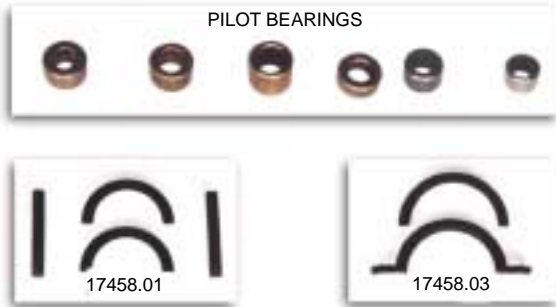

CRANKSHAFT PILOT BEARINGS:

	Stock No.	Replaces
1941-71 4 CYL 134	16910.01	639578
1980-83 4 CYL GM 151	16910.02	8132261
1983-95 4 CYL	16910.03	3250005
1972-76 6 CYL	16910.04	3213751
1976-79 6 CYL	16910.05	3222723
1980-86 6 CYL	16910.06	3236726
1987-91 6 CYL	16910.07	33004041
1992-00 6 CYL. 4.0L	16910.08	53009181
1972-76 8 CYL	16910.04	3213751
1976-79 8 CYL	16910.05	3222723
1980-86 8 CYL	16910.06	3236726

FRONT & REAR CRANKSHAFT OIL SEALS:

1941-71 4 CYL 134 REAR (4 PCS KIT)	17458.01	800093K
1983-98 4 CYL 2.5L, REAR	17458.02	33004143
1968-90 6 CYL 232 OR 258 (2 PCS KIT)	17458.03	3205331
1970-91 V8 AMC, REAR	17458.04	3206691
1965-90 6 CYL 232 OR 258 FRONT	17459.01	3224704

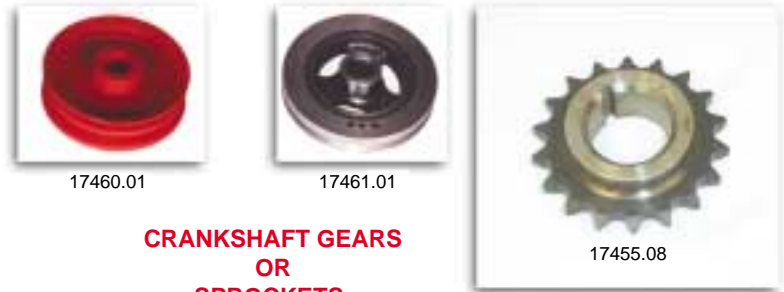

CRANKSHAFT GEARS OR SPROCKETS:

DESCRIPTION	Stock No.	Rep.
1941-47 4 CYL 134 MB & EARLY CJ2A (MODELS W/ CHAIN)	17455.01	638459
1948-71 4 CYL 134 (MODELS W/O CHAIN)	17455.02	641282
1983-02 4 CYL 2.5L	17455.03	33004020
1948-58 6 CYL 226 (BEFORE SERIAL # TW-6-6-90919)	17455.04	733569
1959-63 6 CYL 226 (AFTER SERIAL # TW-6-6-90919)	17455.05	920281
1966-71 V6 225	17455.06	1192916
1968-90 6 CYL AMC 199, 232, 258	17455.07	3173205
1987-93 6 CYL 4.0L	17455.08	33002979
1994-04 6 CYL 4.0L	17455.09	53020443
1971-91 V8 AMC 304, 360, 401, 5/8" WIDE	17455.10	3223199
1971-91 V8 AMC 304, 360, 401, 1/2" WIDE	17455.11	3234235
1993-98 V8 5.2L & 5.9L ZJ GRAND CHEROKEE	17455.12	4448674
CRANKSHAFT SPROCKET, 3.7L & 4.7L	NEW 17455.13	53020679

CRANKSHAFT PULLEYS & DAMPERS:

1941-45 MB CRANKSHAFT PULLEY SINGLE GROOVE	NEW 645623	645623
1946-71 4 CYL 134, PULLEY	17460.01	646698
1972-86 6 CYL 258 (SEE OE APPLICATIONS), DAMPER	17461.01	3225201
1975-86 6 CYL CJ (W/O AC), PULLEY	17460.02	3224690
1991-00 6 CYL 4.0L, DAMPER	17461.02	33002920
1974-91 V8 AMC 360, DAMPER	17461.03	3230131



EXHAUST MANIFOLD KITS WITH GASKETS:

DESCRIPTION	Stock No.	Replaces
1941-68 4 CYL 134 L-HEAD (WILL NOT FIT F-HEAD)	17622.01	801826K
1955-71 4 CYL 134 F-HEAD WITH GASKET	17622.02	648766K
1984-90 4 CYL 2.5L, W/ GASKET	17622.03	33002509K
1991-00 4 CYL 2.5L W/ GASKET	17622.04	53008860K
1968-80 6 CYL 199, 232 OR 258, W/ GASKET	17622.05	8124999K
1981-90 6 CYL 258 W/GASKET	17622.06	3237426K
1987-90 6 CYL 4.0L W/GASKET	17622.07	53006244K
1991-98 6 CYL 4.0L (YJ, TJ, XJ, ZJ), W/ GASKET	17622.08	33007072K
1971-91 V8 EXHAUST MANIFOLD KIT, LH	17622.09	8122442K
1971-91 V8 EXHAUST MANIFOLD KIT, RH	17622.10	8121274K

INTAKE MANIFOLD:

1941-68 4 CYL. 134 L-HEAD	17738.01	A-1166
---------------------------	----------	--------

EXHAUST MANIFOLDS:

DESCRIPTION	Stock No.	Replaces
1941-68 4 CYL 134 L-HEAD (WILL NOT FIT F-HEAD)	17624.01	801826
1941-68 4CYL 134 L-HEAD SPARE HARDWARE KIT	17625.01	646089
1955-71 4 CYL 134 F-HEAD	17624.02	648766
1984-90 4 CYL 2.5L AMC	17624.03	33002509
1983-90 4 CYL 2.5L AMC, CAST-IRON	17624.04	4713055-CAST
1991-00 4 CYL 2.5L	17624.05	53008860
1968-80 6 CYL 199, 232 OR 258	17624.06	8124999
1981-90 6 CYL 258	17624.07	3237426
1987-90 6 CYL 4.0L	17624.08	53006244
1991-98 6 CYL 4.0L (YJ, TJ, XJ, ZJ)	17624.09	33007072
2000-UP XJ & TJ, 1999-UP WJ, 4.0L 6 CYL, FRONT	17624.10	53010196
2000-UP XJ & TJ, 1999-UP WJ, 4.0L 6 CYL, REAR	17624.11	53010199
1970-91 V8 AMC, LH (DRIVER SIDE)	17624.13	8122442
1971-91 V8 AMC, RH (PASSENGER SIDE)	17624.12	8121274
1999-UP V8 4.7L, 1999-UP WJ GRAND CHEROKEE, LH	17624.15	53030933
1999-UP V8 4.7L, 1999-UP WJ GRAND CHEROKEE, RH	17624.14	53030934

MAIN BEARING SETS (COMPLETE SET PER ENGINE):

	Stock No.	Replaces
1941-71 4 CYL 134, STD.	17465.01	A-6746
1941-71 4 CYL 134, .010 OVER	17465.02	A-6747
1941-71 4 CYL 134, .020 OVER	17465.03	A-6748
1941-71 4 CYL 134, .030 OVER	17465.04	A-6798
1941-71 4 CYL 134, .040 OVER	17465.05	A-6746.040
1941-71 4 CYL 134, .050 OVER	17465.06	A-6746.050
1941-71 4 CYL 134, .060 OVER	17465.07	A-6746.060
1941-71 4 CYL 134, .070 OVER	17465.08	A-6746.070
1941-71 4 CYL 134, .080 OVER	17465.09	A-6746.080
1983-90 4 CYL 2.5L, STD.	17465.12	6676M
1983-90 4 CYL 2.5L, .010 OVER	17465.13	6676M.010
1983-90 4 CYL 2.5L, .020 OVER	17465.14	6676M.020
1983-90 4 CYL 2.5L, .030 OVER	17465.15	6676M.030
1991-99 4 CYL 2.5L, STD.	17465.18	7217M
1991-99 4 CYL 2.5L, .010 OVER	17465.19	7217M.010
1948-64 6 CYL 226, STD.	17465.27	912794K
1948-64 6 CYL 226, .010 OVER	17465.28	914308K
1948-64 6 CYL 226, .020 OVER	17465.29	912794.030K
1948-64 6 CYL 226, .030 OVER	17465.30	912794.030K
1948-64 6 CYL 226, .040 OVER	17465.31	912794.040K
1948-64 6 CYL 226, .060 OVER	17465.32	912794.060K
1968-90 6 CYL 199, 232, 258 (4.2L) & 242 (4.0L), STD.	17465.35	4289M
1968-90 6 CYL 199, 232, 258 (4.2L) & 242 (4.0L), .010 OVER	17465.36	4289M.010
1968-90 6 CYL 199, 232, 258 (4.2L) & 242 (4.0L), .020 OVER	17465.37	4289M.020
1968-90 6 CYL 199, 232, 258 (4.2L) & 242 (4.0L), .030 OVER	17465.38	4289M.030
1991-99 6 CYL 4.0L, STD.	17465.42	7211M
1991-99 6 CYL 4.0L, .010 OVER	17465.43	7211M.010
1991-UP 4.0L 6 CYL, .020 OVERSIZE	17465.44	7211M.020
1991-UP 4.0L 6 CYL, .030 OVERSIZE	17465.45	7211M.030
1971-92 V8 AMC 304 OR 360, STD.	17465.49	5037M
1971-92 V8 AMC 304 OR 360, .010 OVER	17465.50	5037M.010
1971-92 V8 AMC 304 OR 360, .020 OVERSIZE	17465.51	5037M.020
1971-92 V8 AMC 304 OR 360, .030 OVERSIZE	17465.52	5037M.030
1971-92 V8 AMC 401, STD.	17465.56	4950M
1971-92 V8 AMC 401, .010 OVER	17465.57	4950M.010
1971-92 V8 AMC 401, .020 OVER	17465.58	4950M.020
1971-92 V8 AMC 401, .030 OVER	17465.59	4950M.030

**ROD BEARING PAIRS****(PART #'S ARE FOR EACH CONN. ROD, NOT A COMPLETE SET):**

1941-71 4 CYL 134, STD.	17467.01	A-7233
1941-71 4 CYL 134, .010 OVER	17467.02	A-7234
1941-71 4 CYL 134, .020 OVER	17467.03	A-7235
1941-71 4 CYL 134, .030 OVER	17467.04	A-7236
1941-71 4 CYL 134, .040 OVER	17467.05	A-7237
1941-71 4 CYL 134, .050 OVER	17467.06	A-7233.050
1941-71 4 CYL 134, .060 OVER	17467.07	A-7233.060
1941-71 4 CYL 134, .070 OVER	17467.08	A-7233.070
1941-71 4 CYL 134, .080 OVER	17467.09	A-7233.080
1948-64 6 CYL 226 ODD NUMBER CYLINDERS (1,3,5), STD.	17467.12	912797
1948-64 6 CYL 226 ODD NUMBER CYLINDERS (1,3,5), .010 OVER	17467.13	914326
1948-64 6 CYL 226 ODD NUMBER CYLINDERS (1,3,5), .020 OVER	17467.14	914329
1948-64 6 CYL 226 ODD NUMBER CYLINDERS (1,3,5), .030 OVER	17467.15	912797.030
1948-64 6 CYL 226 ODD NUMBER CYLINDERS (1,3,5), .040 OVER	17467.16	912797.040
1948-64 6 CYL 226 EVEN NUMBER CYLINDERS (2,4,6), STD.	17467.18	912798
1948-64 6 CYL 226 EVEN NUMBER CYLINDERS (2,4,6), .010 OVER	17467.19	914332
1948-64 6 CYL 226 EVEN NUMBER CYLINDERS (2,4,6), .020 OVER	17467.20	914335
1948-64 6 CYL 226 EVEN NUMBER CYLINDERS (2,4,6), .030 OVER	17467.21	912798.030
1948-64 6 CYL 226 EVEN NUMBER CYLINDERS (2,4,6), .040 OVER	17467.22	912798.040

ROD BEARING PAIR



ROD BEARINGS CONTINUED ON NEXT PAGE

ROD BEARINGS CONT'D (PART #'S FOR EACH CONN. ROD, NOT A COMPLETE SET):



DESCRIPTION	Stock No.	Replaces
1983-99 4 CYL 2.5L, 1968-90 6 CYL AMC, 1987-99 4.0L, 1972-92 V8 304-360, STD.	17467.24	8126204
1983-99 4 CYL 2.5L, 1968-90 6 CYL AMC, 1987-99 4.0L, 1972-92 V8 304-360, .001 OVER	17467.25	8126205
1983-99 4 CYL 2.5L, 1968-90 6 CYL AMC, 1987-99 4.0L, 1972-92 V8 304-360, .010 OVER	17467.26	8126607
1983-99 4 CYL 2.5L, 1968-90 6 CYL AMC, 1987-99 4.0L, 1972-92 V8 304-360, .020 OVER	17467.27	8126204.020
1983-99 4 CYL 2.5L, 1968-90 6 CYL AMC, 1987-99 4.0L, 1972-92 V8 304-360, .030 OVER	17467.28	8126204.030
1970-92 V8 AMC 401, STD.	17467.32	3385CP
1970-92 V8 AMC 401, .010 OVER	17467.33	3385CP.010
1970-92 V8 AMC 401, .020 OVER	17467.34	3385CP.020
1970-92 V8 AMC 401, .030 OVER	17467.35	3385CP.030
1993-98 V8 5.2L ZJ GRAND CHEROKEE, STD.	17467.39	2130CP
1993-98 V8 5.2L ZJ GRAND CHEROKEE, .001 OVER	17467.40	2130CP.001
1993-98 V8 5.2L ZJ GRAND CHEROKEE, .002 OVER	17467.41	2130CP.002
1993-98 V8 5.2L ZJ GRAND CHEROKEE, .010 OVER	17467.42	2130CP.010

CONNECTING RODS:

1941-71 ALL 4 CYL (BOTH L-HEAD & F HEAD), CYL # 1 & # 3	17469.01	641774
1941-71 ALL 4 CYL (BOTH L-HEAD & F HEAD), CYL # 2 & # 4	17469.02	641775
1968-76 6 CYL AMC 199, 232	17469.03	3237816
1977-82 6 CYL AMC 232, 258	17469.04	3180444
1983-90 6 CYL AMC 258 (4.2L)	17469.05	3237812

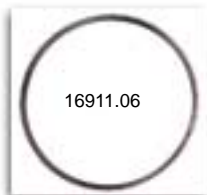

FLYWHEEL RING GEARS:

DESCRIPTION	Stock No.	Replaces
1941-79 4 CYL MB, CJ2A	16911.01	635394
1953-71 4 CYL 134	16911.02	802925
1983-96 4 CYL 2.5L	16911.03	3241718
1967-71 V6-225	NEW 16911.04	1359081
1965-71 6 CYL 232	16911.05	3172419
1972-98 6 CYL 232, 258 (4.2L), 242 (4.0L)	16911.06	3179741
1972-92 8 CYL AMC V8	16911.06	3179741

FLYWHEELS, MANUAL TRANS.:

DESCRIPTION	Stock No.	Replaces
1991-95 4 CYL 134	16912.01	805454
1991-95 2.5L ALL	16912.02	53005526
1972-79 6 CYL 232 OR 258	16912.03	3212623
1980-81 6 CYL 258	16912.04	3236257
1982-87 4.2L	16912.05	3240094
1988-90 4.2L YJ WRANGLER	16912.06	33002672
1991-95 4.0L ALL	16912.07	53005524
1972-91 AMC V8 360	16912.08	3196929
1972-79 AMC V8 401	16912.09	3212655
1972-86 CJ W/ GM V8 CONVERSION, 168 TEETH	16912.10	3991469



FLYWHEELS, AUTOMATIC TRANS.:

1976-79 6 CYL 258	16913.01	5351819
1976-79 8 CYL 304	16913.02	5351820
1976-79 8 CYL 360	16913.03	5351821
1976-79 8 CYL 401	16913.04	5351822
1980-86 8 CYL 258	16913.05	3232138
1980-86 8 CYL 304, 360	16913.06	3232139
DJ POSTAL JEEP APPLICATIONS	16913.07	5900002
1972-86 CJW/ GM V8 CONVERSION, 168 TEETH	16913.08	340296
1988-93 V8	NEW 16913.09	33004361
1991-00 4.0 XJ FLEX PLATE	NEW 6913.10	52117761
1987-90 4.0L XJ CHEROKEE	NEW 6913.11	33002675

MISC. ENGINE ITEMS:

	Stock No.	Replaces
1941-1948 MB & EARLY CJ2A WITH TIMING CHAIN ENGINE MOUNT PLATE	17470.01	641143
1945-71 4 CYL 134, REAR ENGINE PLATE	17470.02	804381
1941-71 4 CYL 134, CAMSHAFT THRUST PLATE	17470.03	802576
1941-71 4 CYL 134 ENGINE, GENERATOR BUSHING	17470.04	A-1395
1941-71 4 CYL 134 ENGINE, GENERATOR BOLT	17470.05	A-1397
1941-71 4 CYL 134 L-HEAD MB & CJ LONG OIL LINE (INLET)	17470.06	A-1197
1941-71 4 CYL 134 L-HEAD MB & CJ SHORT OIL LINE (OUTLET)	17470.07	A-1198
1955-71 4 CYL 134 F-HEAD CJ 23" LONG OIL LINE INLET	17470.08	647584
1955-71 4 CYL 134 F-HEAD CJ 30.5" LONG OIL LINE INLET	17470.09	647585
1955-71 4 CYL 134 F-HEAD CJ OIL LINE OUTLET	17470.10	910290
1941-71 4 CYL 134 ENGINE DRAIN COCK	17470.11	A-1126
1941-71 4 CYL 134 CONNECTING ROD BOLT & NUT	17470.12	641768K

1974-86 V8 CJ ENGINE MOUNT BRACKETS:

BRACKET, LOWER LEFT	NEW	17472.01	8128343
BRACKET, LOWER RIGHT	NEW	17472.02	5355948
BRACKET, UPPER LEFT		17472.03	999147
BRACKET, UPPER RIGHT		17472.04	999148
BRACKET KIT - 4 BRACKETS + 2 MOUNTS	NEW	12472.05	8128343K

ENGINE MOUNTS:

	Stock No.	Replaces	
1941-71 4 CYL ALL	17473.01	638629	
1984-93 4 CYL YJ WRANGLER LEFT OR RIGHT (1991-96 YJ LEFT)	17473.03	52000074	
1984-93 4 CYL XJ CHEROKEE LEFT	17473.03	52000074	
1984-90 4 CYL XJ CHEROKEE RIGHT	17473.02	3242711	
1991-00 2.5L XJ	NEW	17473.27	52007394
1997-02 4CYL 2.5L TJ WRANGLER		17473.04	52019276
2002-05 2.4L KJ, RH	TBA	17473.24	52059252AC
2002-05 2.4L KJ, LH	TBA	17473.25	52059253AC
1948-63 6 CYL 226		17473.05	8136614
1964-76 6 CYL 232 OR 258		17473.06	3173681
1978-86 6 CYL 232 OR 258		17473.07	8128488
1978-86 6 CYL 232 OR 258 RED POLYURETHANE, PAIR		17473.08	1-501
1978-86 6 CYL 232 OR 258 BLACK POLYURETHANE, PAIR		17473.09	1-501BL
1987-96 6 CYL YJ WRANGLER & XJ CHEROKEE 4.2L OR 4.0L		17473.10	52040267
1997-03 6 CYL 4.0L TJ WRANGLER		17473.11	52019278
1993-98 6 CYL 4.0L ZJ GRAND-CHEROKEE, RH		17473.12	52018280
1993-98 6 CYL 4.0L ZJ GRAND-CHEROKEE, LH		17473.13	52018281
1987-01 6 CYL 4.0L WRANGLER (YJ & TJ) & XJ CHEROKEE, PAIR, RED		17473.14	1-502
1987-01 6 CYL 4.0L WRANGLER (YJ & TJ) & XJ CHEROKEE, PAIR, BLACK		17473.15	1-502BL
2002-04 3.7L KJ, RH=LH	TBA	17473.23	52059226AB
1974-91 8 CYL 304, 360, 401		17473.16	3226821
1967-92 V8 AMC, PAIR, POLYURETHANE, RED		17473.17	1-503
1967-92 V8 AMC, PAIR, POLYURETHANE, BLACK		17473.18	1-503BL
1993-98 V8 ZJ GRAND CHEROKEE, RH		17473.20	52058504
1993-98 V8 ZJ GRAND CHEROKEE, LH		17473.19	52058505
1999-04 4.7L WJ RH	TBA	17473.22	52058936AC
1999-04 4.7L WJ LH	TBA	17473.21	52058937AC
1999-04 4.7L WJ, RH		17473.22	52058936AC

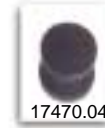

17474.03

HARD PARTS

DRIVETRAIN MOUNT KITS (ENGINE, TRANSMISSION & TRANSFER CASE):

1941-71 4 CYL 134	17474.01	638629K
1987-90 4 CYL YJ WRANGLER	17474.02	52000074K
1974-86 6 CYL 258	17474.03	8128488K
1987-96 6 CYL YJ WRANGLER	17474.04	52019201K
1974-83 8 CYL CJ	17474.05	3186107K



17474.04

RUGGED RIDGE HEADERS:

The new **Tube Style Exhaust Header** for 1991-1999 4.0L motors is sure to increase performance and horsepower. This header is a great upgrade to any stock 4.0L engine. The complete bolt on kit includes manifold, gasket, hardware and down pipe flange gasket. Available in Standard Steel, 409 or 304 grade stainless steel for long lasting durability, rust resistance and performance life.

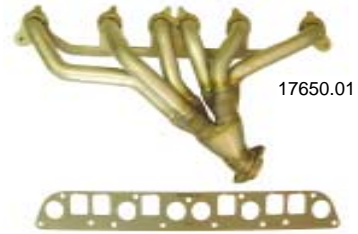

RUGGED RIDGE TORQUE TUBE HEADERS

YEAR	APPLICATION	REGULAR	409 STAINLESS	304 STAINLESS
		STEEL BLACK	STEEL	STEEL POLISHED
1991-99	4.0L YJ, TJ, XJ, ZJ	17660.01	17650.01	17650.51
2000-03	4.0L TJ, WJ	17660.02	17650.02	17650.52
		NEW	NEW	NEW

PACESETTER HEADERS:

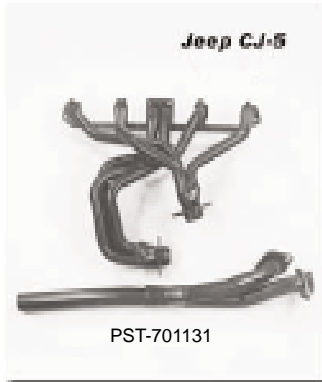

DESCRIPTION	Stock No.
1987-90 4.2L YJ WRANGLER, BLACK DUAL OUTLET HEADER, (Y-PIPE & EXT PIPE INCL)	PST-701128
1991-99 4.0L YJ & TJ WRANGLER, BLACK DUAL OUTLET HEADER, (Y-PIPE & EXT PIPE INCL)	PST-701129
1965-71 V6 225 CJ-5, CJ-6, BLACK DUAL OUTLET HEADER	PST-701130
1972-80 6 CYL CJ (232 or 258), BLACK DUAL OUTLET HEADER, (Y-PIPE INCL)	PST-701131
1981-86 6 CYL 258 CJ, BLACK DUAL OUTLET HEADER, (Y-PIPE INCL)	PST-701135
1991-95 2.5L YJ WRANGLER, BLACK SINGLE OUTLET HEADER, (EXT PIPE INCL)	PST-701137
1997-99 2.5L TJ WRANGLER, BLACK SINGLE OUTLET HEADER, (EXT PIPE INCL)	PST-701138
1987-92 4.0L XJ CHEROKEE, BLACK DUAL OUTLET HEADER	PST-701191
1972-83 AMC V8 CJ5, CJ7, BLACK DUAL OUTLET HEADER	PST-701334
1976-83 AMC V8 CJ5, INFRAME HEADERS, FRONT AND TAIL PIPE, GLASS PACK TYPE MUFFLER	PST-882106
1987-90 4.2L YJ WRANGLER, ARMOR COATED HEADER (Y-PIPE & EXT PIPE INCL)	PST-72C1128
1991-99 4.0L YJ & TJ WRANGLER, ARMOR COATED HEADER (Y-PIPE & EXT PIPE INCL)	PST-72C1129
1972-80 6 CYL (232 OR 258), ARMOR COATED HEADER (Y-PIPE INCL)	PST-72C1131
1981-86 6 CYL 258 CJ, ARMOR COATED HEADER (Y-PIPE INCL)	PST-72C1135
1991-95 2.5L YJ WRANGLER, ARMOR COATED HEADER (EXT PIPE INCL)	PST-72C1137
1997-99 2.5L TJ WRANGLER, ARMOR COATED HEADER (EXT PIPE INCL)	PST-72C1138
1987-92 4.0L XJ CHEROKEE, ARMOR COATED HEADER	PST-72C1191
1993-98 ZJ GRAND CHEROKEE 6 or 8 CYL, TFX KAT-BACK EXHAUST SYSTEM	PST-862840
1993-98 XJ CHEROKEE 4 or 6 CYL, TFX KAT-BACK EXHAUST SYSTEM	PST-862846
1987-95 YJ WRANGLER 4 or 6 CYL, TFX KAT-BACK EXHAUST SYSTEM	PST-862872
1997-99 TJ WRANGLER 4 or 6 CYL, TFX KAT-BACK EXHAUST SYSTEM	PST-862874
2000-01 TJ WRANGLER 4 or 6 CYL, TFX KAT-BACK EXHAUST SYSTEM	PST-863875

DYNAMIX PERFORMANCE MUFFLERS & EXHAUST SYSTEMS:

DESCRIPTION	Stock No.
1991-95 6 CYL 4.0L YJ WRANGLER, SUPER-TURBO CAT-BACK EXHAUST SYSTEM	DMX17309
1997-99 6 CYL 4.0L TJ WRANGLER, SUPER-TURBO CAT BACK EXHAUST SYSTEM	DMX17345
1997-99 6 CYL 4.0L TJ WRANGLER, ULTRA-FLOW STAINLESS MUFFLER	DMX17282
1997-99 6 CYL 4.0L TJ WRANGLER, SUPER TURBO MUFFLER	DMX17731
1986-92 4 CYL 2.5L OR 6 CYL 4.0L XJ CHEROKEE, SUPER-TURBO MUFFLER *	DMX17748
1993-00 6 CYL 4.0L XJ CHEROKEE, SUPER-TURBO MUFFLER	DMX17747
1993-98 6 OR 8 CYL ZJ GRAND-CHEROKEE, SUPER-TURBO MUFFLER	DMX17747
1999-00 6 OR 8 CYL WJ GRAND-CHEROKEE, SUPER-TURBO MUFFLER *	DMX17748

* ADAPTER, 2.5" TO 2.25" NEEDED WHEN USING DMX17748

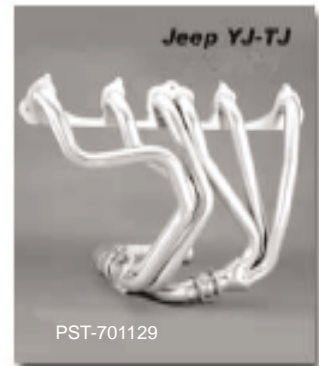

PERFORMANCE HEADERS (INCLUDES HARDWARE, BLACK PAINTED):

1972-79 8 CYL. CJ 209-401ci., INCLUDES HDW, BLACK	DMX85067
1972-80 6 CYL. CJ 232-258ci., INCLUDES HDW, BLACK	DMX85072
1972-82 8 CYL. CJ 209-401ci., FENDERWELL, INCLUDES HDW, BLACK	DMX85073



HARD PARTS



CATALYTIC CONVERTER KITS (INCLUDES HARDWARE):

	Stock No.	Replaces
1984-86 4 CYL 2.5L CJ *	17601.01	15666K
1987-92 4 CYL 2.5L WRANGLER	17601.02	15634K
1993-95 4 CYL 2.5L WRANGLER	17601.03	15773K
1975-78 6 & 8 CYL CJ	17601.04	15658K
1981-86 6 CYL 4.2L CJ *	17601.01	15666K
1987-90 6 CYL 4.2L WRANGLER *	17601.05	15637K
1991-92 6 CYL 4.0L WRANGLER	17601.02	15634K
1993-95 6 CYL 4.0L WRANGLER	17601.03	15773K
* AIR TUBE CONVERSION KIT TO BE USED WITH 17601.01 & 17601.05	17603.01	35574



CATALYTIC CONVERTERS:

	Stock No.	Replaces
1984-86 4 CYL 2.5L CJ	17604.01	5370049
1984-85 4 CYL 2.5L XJ CHEROKEE	17604.02	53001627
1987-92 4 CYL 2.5L WRANGLER	17604.03	52018104
1993-96 4 CYL 2.5L WRANGLER & XJ CHEROKEE	17604.04	52020110
1997-00 2.5L & 4.0L TJ WRANGLER	NEW 17604.10	52018933AC
1975-78 6 & 8 CYL CJ	17604.05	5358641
1981-86 6 CYL 4.2L CJ WITH AIR TAP *	17604.01	5370049
1987-90 6 CYL 4.2L WRANGLER WITH AIR TAP *	17604.02	53001627
1991-92 6 CYL 4.0L WRANGLER & XJ CHEROKEE	17604.03	52018104
1993-95 6 CYL 4.0L WRANGLER, XJ CHEROKEE & ZJ GRAND-CHEROKEE	17604.04	52020110
1997-98 6 CYL 4.0L XJ CHEROKEE, 1996-98 ZJ GRAND CHEROKEE	17604.08	52019480AD
1981-86 6 CYL 4.2L SJ WITH AIR TAP *	17604.01	5370049
1974-91 V8 SJ	17604.06	5370145
1994-95 V8 ZJ GRAND-CHEROKEE	17604.07	52019600
1996-98 V8 ZJ GRAND CHEROKEE	17604.08	52019480AD

* AIR TUBE CONVERSION KIT MUST BE USED WITH 17604.01 17603.01 35574

**WALKER REPLACEMENT EXHAUST KITS:
(INCLUDES: MUFFLER, TAILPIPE, CLAMPS & HARDWARE)**

	Stock No.	Replaces
1987-92 4 CYL 2.5L WRANGLER	17606.01	22501K
1993-95 4 CYL 2.5L WRANGLER	17606.02	21200K
1972-75 CJ5, 6 CYL OR 8 CYL	17606.03	44564K
1976-78 CJ5, CJ7, 6 CYL	17606.04	43701K
1979-81 CJ5, CJ7, 6 CYL MODELS WITH CONVERTER,	17606.05	43704K
1981 CJ8, 6 CYL	17606.06	43704K8
1983-86 CJ7, 6 CYL	17606.07	44784K
1983-85 CJ8, 6 CYL	17606.06	43704K8
1987-90 6 CYL 4.2L WRANGLER	17606.09	22435K
1991-92 6 CYL 4.0L WRANGLER	17606.01	22501K
1993-95 6 CYL 4.0L WRANGLER	17606.02	21200K
1976-81 CJ5, CJ7, V8 304	17606.10	57704K

MIDDLE LONG PIPE ONLY:

	Stock No.	Replaces
1946-66 4 CYL 134 CJ	17608.01	916319
1981 CJ8 INTERMEDIATE PIPE	17608.02	41947



REPLACEMENT MUFFLERS:

DESCRIPTION	Stock No.	
1941-45 MB & GPW, OVAL	17609.01	809480
1946-71 4 CYL 134, ROUND	17609.02	641878
1980-83 4 CYL 151 GM ENGINE CJ	17609.03	5362723
1983-86 4 CYL 2.5L AMC ENGINE CJ	17609.04	5363566
1987-92 4 CYL 2.5L WRANGLER	17609.05	83502978
1993-95 4 CYL 2.5L WRANGLER	17609.06	21200
1997-02 2.5L TJ WRANGLER	NEW 17609.17	52019242AC
1986-89 4 CYL 2.5L XJ CHEROKEE	17609.07	83502646
1993-95 4 CYL 2.5L XJ CHEROKEE	17609.08	22799
1966-71 V6 225 CJ	17609.09	941570
1972-78 6 CYL CJ (MODELS WITHOUT CONVERTER)	17609.10	5351986
1976-82 6 CYL CJ (MODELS WITH CONVERTER)	17609.03	5362723
1983-86 6 CYL CJ	17609.04	5363566
1987-90 6 CYL 4.2L WRANGLER	17609.16	83502979
1991-92 6 CYL 4.0L WRANGLER	17609.05	83502978
1987-92 6 CYL 4.0L XJ CHEROKEE	17609.11	52003985
1993-95 6 CYL 4.0L XJ CHEROKEE	17609.08	22799
1986 V6 2.8L XJ CHEROKEE & ZJ GRAND-CHEROKEE	17609.12	83502648
1972-75 V8 CJ	17609.10	5351986
1976-81 V8 304 CJ	17609.03	5362723
1979-87 V8 J10 & J20 TRUCKS	17609.13	5361842
1981-91 V8 SJ CHEROKEE (EXCEPT J10, J20)	17609.14	83300066
1993-95 V8 ZJ GRAND-CHEROKEE	17609.15	21045

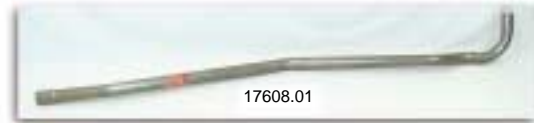
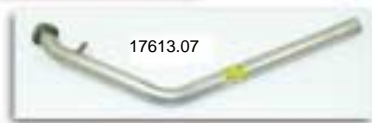

MUFFLER WITH TAILPIPE:

DESCRIPTION	Stock No.	
1993-95 4 CYL 2.5L WRANGLER	17611.01	52019135
1993-95 4 CYL 2.5L XJ CHEROKEE	17611.02	52019138
1991-92 6 CYL 4.0L WRANGLER	17611.03	52004422
1993-95 6 CYL 4.0L WRANGLER	17611.01	52019135
1987-92 6 CYL 4.0L XJ CHEROKEE	17611.05	52018335
1993-95 6 CYL 4.0L XJ CHEROKEE	17611.02	52019138
1993-95 6 CYL 4.0L ZJ GRAND-CHEROKEE	17611.06	4864279
1993-95 V8 ZJ GRAND-CHEROKEE	17611.07	52021030

FRONT PIPES:

	Stock No.	Replaces
1946-71 4 CYL 134 CJ	17613.01	641856
1987-92 4 CYL 2.5L WRANGLER	17613.02	52007397
1984-86 4 CYL 2.5L XJ CHEROKEE	17613.03	53001388
1987-92 4 CYL 2.5L XJ CHEROKEE	17613.04	52005187
1972-78 6 CYL CJ5	17613.05	5355981
1976-78 6 CYL CJ7	17613.06	5355983
1983-86 6 CYL CJ7 & CJ8	17613.07	5364312
1987-90 6 CYL 4.2L WRANGLER	17613.08	52040278
1991-92 6 CYL 4.0L WRANGLER	17613.09	52006626
1987-90 6 CYL 4.0L XJ CHEROKEE	17613.10	52002989
1991-92 6 CYL 4.0L XJ CHEROKEE	17613.11	52004996
1976-78 V8 304 CJ7 WITH 3 SPEED TRANNY	17613.12	5355039
1993-95 V8 ZJ GRAND-CHEROKEE	17613.13	52007051

TAILPIPES:

DESCRIPTION	Stock No.	1946-71 4
CYL 134	17615.01	641872
1980-81 4 CYL 151 GM ENGINE CJ	17615.02	43704
1983-86 4 CYL 2.5L CJ (AMC ENGINE)	17615.03	44784
1987-95 4 CYL 2.5L WRANGLER	17615.04	83502980
1986-92 4 CYL 2.5L XJ CHEROKEE	17615.05	45944
1993-96 4 CYL 2.5L XJ CHEROKEE	17615.06	45379
1966-71 V6 225 CJ	17615.07	941913
1972-75 6 CYL CJ	17615.08	44564
1976-78 6 CYL CJ (MODELS W/O CONVERTER)	17615.09	43701
1976-81 6 CYL CJ (MODELS W/ CONVERTER)	17615.02	43704
1983-86 6 CYL CJ	17615.03	44784
1987-90 6 CYL 4.2L WRANGLER	17615.04	83502980
1991-95 6 CYL 4.0L WRANGLER	17615.04	83502980
1987-92 6 CYL 4.0L XJ CHEROKEE	17615.05	45944
1993-96 6 CYL 4.0L XJ CHEROKEE	17615.06	45379
1993-95 6 CYL 4.0L ZJ GRAND-CHEROKEE	17615.10	45378
1972-75 V8 CJ	17615.08	44564
1976-81 V8 304 CJ	17615.02	43704
1993-95 V8 ZJ GRAND-CHEROKEE	17615.11	45404



17451.04



17619.02



17617.03



17617.05

EXHAUST & INTAKE MANIFOLD GASKET SETS:

DESCRIPTION	Stock No.	Replaces
1941-71 4 CYL L-HEAD	17451.01	A-7835
1956-71 4 CYL F-HEAD	17451.02	801345
1965-80 6 CYL 232 OR 258	17451.03	3242855K
1981-90 6 CYL 258	17451.04	3237775K
1987-90 6 CYL 4.0L	17451.05	53020122K
1991-99 6 CYL 4.0L	17451.06	53010238K
1971-93 8 CYL INTAKE, ALL	17451.07	8125869
1971-93 8 CYL EXHAUST, ALL	17451.08	3237270

EXHAUST PIPE GASKETS:

DESCRIPTION	Stock No.	Rep.
1946-71 4 CYL 134	17450.01	634814
1968-90 6 CYL AMC 199, 232, 258	17450.02	3216643
1971-91 V8 AMC 304, 360, 401	17450.03	3216644
1991-00 6 CYL 4.0L WRANGLER, EXHAUST PIPE TO MANIFOLD	17450.04	52005431
1987-95 4 CYL OR 6 CYL (2.5L, 4.2L, 4.0L) WRANGLER FR PIPE TO CONVERTER	17617.05	31519

MISC. EXHAUST GASKETS:

1987-90 4 CYL OR 6 CYL EXHAUST RECIRCULATE	17450.05	33004185
6 CYL. 226 MANIFOLD TO EXH. FLANGE GASKET	17450.06	745608



17622.08



17620.10

17620.01

17620.02

17620.03

17620.05

17620.04

MISC. EXHAUST COMPONENTS:

DESCRIPTION	Stock No.	Replaces
HANGER SWIVEL TYPE	17620.01	35103
HANGER	17620.02	35209
BRACKET	17620.03	35148
INSULATOR	17620.04	35183
INSULATOR	17620.05	35460
CLAMP, 2" REGULAR DUTY	17620.06	35408
CLAMP, 2-1/8" REGULAR DUTY	17620.07	35334
CLAMP, 2-1/4" REGULAR DUTY	17620.08	35413
CLAMP, 2" HEAVY DUTY	17620.09	35335
CLAMP, 2-1/4" HEAVY DUTY	17620.10	35336
CLAMP, 2-1/2" HEAVY DUTY	17620.11	35337

EXHAUST MANIFOLD KITS WITH GASKETS:

DESCRIPTION	Stock No.	Replaces
1941-68 4 CYL 134 L-HEAD (WILL NOT FIT F-HEAD)	17622.01	801826K
1984-90 4 CYL 150 AMC 2.5L, W/ GASKET	17622.03	33002509K
1991-00 4 CYL 2.5L W/ GASKET	17622.04	53008860K
1968-80 6 CYL 199, 232 OR 258, W/ GASKET	17622.05	8124909K
1981-90 6 CYL 258 W/GASKET	17622.06	3237426K
1987-90 6 CYL 4.0L W/GASKET	17622.07	53006244K
1991-98 6 CYL 4.0L (YJ, TJ, XJ, ZJ), W/ GASKET	17622.08	33007072K
1971-91 AMC V8 RH, W / GASKET	17622.10	8121274K
1971-91 AMC V8 LH, W / GASKET	17622.09	8122442K

EXHAUST MANIFOLDS:

DESCRIPTION	Stock No.	Replaces
1941-68 4 CYL 134 L-HEAD (WILL NOT FIT F-HEAD)	17624.01	801826
1955-71 4 CYL 134 F-HEAD	17624.02	648766
1984-90 4 CYL 150 AMC 2.5L	17624.03	33002509
1984-90 4 CYL 150 AMC 2.5L CAST-IRON	17624.04	4713055-CAS7
1991-00 4 CYL 2.5L	17624.05	53008860
1968-80 6 CYL 199, 232 OR 258	17624.06	8124999
1981-90 6 CYL 258	17624.07	3237426
1987-90 6 CYL 4.0L	17624.08	53006244
1991-99 6 CYL 4.0L (YJ, TJ, XJ, ZJ)	17624.09	33007072
2000-UP 6 CYL 4.0L XJ & TJ, 1999-UP WJ, FRONT	17624.10	53010196
2000-UP 6 CYL 4.0L XJ & TJ, 1999-UP WJ, REAR	17624.11	53010199
1970-91 V8 AMC, LH (DRIVER SIDE)	17624.13	8122442
1971-91 V8 AMC, RH (PASSENGER SIDE)	17624.12	8121274
1999-UP V8 4.7L 1999-UP WJ GRAND CHEROKEE, LH	17624.15	53030933
1999-UP V8 4.7L 1999-UP WJ GRAND CHEROKEE, RH	17624.14	53030934



17624.01

CARBURETORS:

DESCRIPTION	Stock No.	Rep.
1946-71 CIVILIAN L-HEAD,CJ2A,3A, SOLEX DESIGN	17701.01	923806
1958-71 CIVILIAN F-HEAD,CJ3B,CJ5,CJ6, SOLEX DESIGN	17701.02	923808

17701.01



17701.02



BRUTE FORCE INTAKE SYSTEMS:

DESCRIPTION	Stock No.
1997-02 6 CYL 4.0L TJ WRANGLER	AEM-218300C
1997-02 4 CYL 2.5L TJ WRANGLER	AEM-218301C
2002-UP 6 CYL 3.7L KJ LIBERTY	AEM-218303C
1993-98 V8 (BOTH 5.2L & 5.9L) ZJ GRAND CHEROKEE	AEM-218302C

Kits Include:

Extra Large, High Life Air Filter
Stainless Steel Heat Shield & Hardware



WEBER PERFORMANCE CARBURETOR CONVERSION KITS*:

DESCRIPTION	Stock No.	Replaces
1945-71 CIVILIAN 4 CYL, 32/36 DGV	17702.01	K553
1980-83 4 CYL GM 151, 38 DGES, REPLACES E-2SE ROCHESTER	17702.02	K490
1980-83 4 CYL GM 151, 32/36 DGES, REPLACES E-2SE ROCHESTER	17702.03	K491
1983-88 4 CYL CJ OR YJ AMC 150, 300 CFM 32/36 DGEV	17702.04	K55234
1972-78 6 CYL 232 OR 258 W/CARTER 1 BARREL, 32/36 DGEV	17702.05	K55034
1972-90 6 CYL 258 (4.2L) W/CARTER 2 BARREL 300 CFM, 34/34 DGEV	17702.06	K55134
1972-90 6 CYL 258 (4.2L) W/CARTER 2 BARREL 400 CFM, 38 DGES *	17702.07	K55138
1984-86 V6 XJ CHEROKEE, REPLACES E-2SE ROCHERSTER, 38 DGES	17702.02	K490
1984-86 V6 XJ CHEROKEE, REPLACES E-2SE ROCHERSTER, 32/36 DGES	17702.03	K491
REPAIR KIT FOR WEBER 17702.05, 17702.06, 17702.04	17703.01	923237
REPAIR KIT FOR WEBER 17702.07	17703.02	923235
SPARE ADAPTER FOR AIR FILTER	17704.01	99010
ADAPTER FOR WEBER CORB	17704.02	99010-600
ADAPTER FOR WEBER KSSI	17704.03	99004-551
WEBER AIR CLEANER ASM	17704.04	992173
SPARE WEBER AIR FILTER	17704.05	99400

*SOME KITS MAY NOT BE LEGAL IN ALL 50 STATES, CHECK LOCAL LAWS

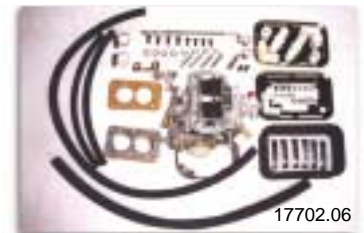

EMPI CARBURETOR ASSEMBLY:

DESCRIPTION	Stock No.	Replaces
1972-90 6 CYL 258 (4.2L) W/CARTER 2 BARREL 300 CFM, 32/36 DGEV	NEW 17702.08	K47-1551

CARBURETOR REPAIR KITS:

DESCRIPTION	Stock No.	Replaces.
REPAIR KIT FOR SOLEX DESIGN L-HEAD 17701.01	17705.01	SK13
REPAIR KIT FOR SOLEX DESIGN F-HEAD 17701.02	17705.02	SK5
1946-71 REPAIR KIT FOR CARTER L-HEAD CIVILIAN	17705.03	647745
MB, CJ2A, CJ3A MASTER CARB REPAIR KIT W / SPECIALTY MOUNTING GASKET	17705.04	647745-MK
MB, CJ2A, CJ3A GASKET WITH V-BRACKET	17706.01	A-6357
1958-71 REPAIR KIT FOR CARTER F-HEAD CIVILIAN	17705.05	924160
1955-71 F-HEAD WITH CARTER CARB, MASTER CARB REPAIR KIT	17705.06	924160-MK
M38, CARB RAPAIR KIT	17705.07	648065
M38A1, CARB REPAIR KIT	17705.08	807885
1975-80 6 CYL 1 BARREL CARTER 232, 258	17705.09	8121138
1976-86 6 CYL 2 BARREL CARTER 232, 258	17705.10	8134232

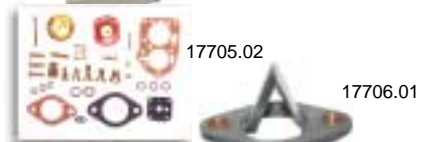

FUEL PUMPS: (Continued on next page)

DESCRIPTION	Stock No.	Replaces
1941-71 4 CYL-134 W/O VACUUM WIPERS, GLASS BOWL	17709.01	119238
1941-71 4 CYL-134 W/O VACUUM WIPERS, METAL CAP	17709.02	119238M
1941-71 4 CYL-134 CJ WITH VACUUM WIPERS	17709.03	120206
1946-63 4 CYL-134 STATION WAGON WITH VACUUM WIPERS	17709.04	119729
1980-83 CJ 4 CYL (GM 151)	17709.05	8132364
1983-86 CJ 4 CYL (AMC 150)	17709.06	3228191
1987-90 YJ WRANGLER 4 CYL (CARBURETED)	17709.07	33002652
1987-90 YJ WRANGLER 4 CYL, 1986-90 XJ 2.5L, w/ FUEL INJECTION,ELECTRIC	17709.08	83502994
1991-93 YJ WRANGLER 4 CYL, 1991-93 XJ 2.5L, w/ FUEL INJECTION, ELECTRIC	17709.09	4637193
1991-93 YJ WRANGLER 4 CYL, 1987-93 XJ 4.0L, w/ FUEL INJECTION, ELECTRIC	17709.09	4637193
1948-63 6-226 ENGINE	17709.10	735994
1964-66 6-230 TORNADO ENGINE	17709.11	930144
1972-73 CJ 6 CYL	17709.12	3216577
1974-90 CJ 6 CYL	17709.06	3228191
1987-90 YJ WRANGLER 6 CYL (REAR INLET FITTING)	17709.06	3228191
1987-90 YJ WRANGLER 6 CYL (FRONT INLET FITTING)	17709.13	3240172



HARD PARTS

FUEL PUMPS: (Continued from previous page)

DESCRIPTION	Stock No.	Replaces
1991-93 YJ WRANGLER 6 CYL, ELECTRIC	17709.09	4637193
1972-75 CJ 8 CYL	17709.14	8124460
1976-83 CJ 8 CYL	17709.15	3227884
1965-66 CJ V6-225	17709.16	6414989
1967-71 CJ V6-225	17709.17	6416783

FUEL PRESSURE REGULATORS:

DESCRIPTION	Stock No.	Replaces
1991-96 4 CYL. 2.5L WRANGLER & XJ CHEROKEE	17711.01	53005801
1987-90 6 CYL. 4.0L XJ CHEROKEE	17711.02	83503635
1991-96 6 CYL. 4.0L WRANGLER & XJ CHEROKEE	17711.01	53005801
1993-96 8 CYL. 5.2L ZJ GRAND CHEROKEE	17711.01	53005801

FUEL MODULES

DESCRIPTION	NEW	Stock No.	Replaces
FUEL PUMP AND FILTER, 94-96 2.5L & 4.0L YJ, 94-96 2.5L & 4.0 XJ	NEW	17709.18	4762964P
FUEL PUMP AND FILTER, 97-02 ALL TJ'S, 97-00 ALL XJ'S, 97-98 ALL ZJ'S	NEW	17709.19	4874173P
FUEL MODULE (PUMP & SEND UNIT ASSY), 1996 ALL ZJ'S (6 & 8 CYL)	NEW	17709.20	5003867AA
FUEL MODULE (PUMP & SEND UNIT ASSY), 1995 ALL ZJ'S (6 & 8 CYL)	NEW	17709.21	52018796
FUEL MODULE (PUMP & SEND UNIT ASSY), 1993-94 ALL ZJ'S (6 & 8 CYL)	NEW	17709.22	52005099
FUEL MODULE , 2003-2004 WJ (BOTH 4.0L & 4.7L)	NEW	17709.23	5018056AC
FUEL MODULE , 1999-2000 WJ (BOTH 4.0L & 4.7L)	NEW	17709.24	5012380AA

IDLE AIR CONTROL MOTORS:

DESCRIPTION	Stock No.	Replaces
1991-97 4 CYL 2.5L WRANGLER & XJ CHEROKEE	17715.01	4637073
1998-99 4 CYL 2.5L WRANGLER & XJ CHEROKEE	17715.02	4874372
1991-97 6 CYL 4.0L WRANGLER, XJ CHEROKEE & ZJ GRAND-CHEROKEE	17715.03	4637071
1998-99 6 CYL 4.0L WRANGLER, XJ CHEROKEE & ZJ GRAND-CHEROKEE	17715.02	4874372
1993-98 8 CYL 5.2L ZJ GRAND-CHEROKEE (ALSO 1998 5.9L GRAND-CHEROKEE)	17715.04	53030657AB
1999-04 4.0 WJ, 2000-01 XJ, 2000-04 4.0L TJ, 2000-02 2.5L TJ	NEW 17715.05	4874373AB

ACCELERATOR CABLES:

DESCRIPTION	Stock No.	Replaces
1981-83 CJ, 4 CYL. WITH GM 2.5L ENGINE	17716.01	5361067
1987-90 YJ, 4 CYL. WITH CARB	17716.02	52040430
1987-90 YJ WRANGLER, 4 CYL. WITH FUEL INJECTION	17716.03	53005206
1972-75 CJ, 6 CYL 27.75"	17716.04	999923
1976-78 CJ, 6 CYL 30.5"	17716.05	5356484
1979-80 CJ, 6 CYL & 1981-86 LHD EXPOERT CJ'S	17716.06	5357847
1981-86 CJ, 6 CYL 24.25"	17716.07	5362801
1984-86 XJ CHEROKEE V6	17716.08	53000038
1987-90 XJ CHEROKEE, 6 CYL. 4.0L	17716.09	53005201
1991-95 2.5L & 4.0L XJ	NEW 17716.15	53006556
1977-80 SJ, 6 CYL.	17716.10	5357703
1972-75 CJ, 8 CYL. 35-3/8"	17716.11	999893
1976 CJ, 8 CYL. 21.25"	17716.12	5356483
1977-83 CJ, 8 CYL. 18.75"	17716.13	5357931
1987-91 SJ, 8 CYL.	17716.14	53005205

AIR FILTERS:

DESCRIPTION	Stock No.	Replaces
1981-86 CJ, 4 CYL W/CARB	17719.01	8991386
1987-95 YJ WRANGLER, 4 CYL. WITH FUEL INJECTION	17719.02	53006317
1974-86 CJ, 6 CYL.	17719.01	8991386
1991-96 YJ WRANGLER, 6 CYL.	17719.02	53006317
1974-83 CJ, 8 CYL.	17719.03	8992661
1997-02 2.5L 4 CYL, 1997-04 4.0L 6 CYL TJ WRANGLER	17719.04	4797777
1987-01 XJ CHEROKEE WITH FUEL INJECTION	17719.05	53004383
1993-98 ZJ GRAND CHEROKEE	17719.06	53007386
1999-04 WJ GRAND CHEROKEE	17719.06	53007386
2002-UP 3.7L KJ LIBERTY, GENUINE FRAM BRAND	NEW 17719.07	5018777AA
2002-UP 2.4L KJ LIBERTY, GENUINE FRAM BRAND	NEW 17719.08	5019443AA

EGR VALVES:

DESCRIPTION	Stock No	Rep.
1981-86 6 CYL 4.2L CJ & SJ	17712.01	33000889

BREATHER:

1993-98 V8 GRAND CHEROKEE	17713.01	53030254
---------------------------	----------	----------



17713.01

HARD PARTS

See Page 42 for K & N Filters

17719.01



17719.02



FUEL INJECTORS:

	Stock No.	Replaces
1991-95 4 CYL 2.5L WRANGLER & XJ CHEROKEE	17714.01	53007232
1996-02 4 CYL 2.5L WRANGLER & XJ CHEROKEE	17714.02	53030778
1987-90 6 CYL 4.0L XJ CHEROKEE	17714.03	53003956
1991-93 6 CYL 4.0L YJ WRANGLER & XJ CHEROKEE	17714.04	33007127
1994-95 6 CYL 4.0L WRANGLER, XJ CHEROKEE, 1993-95 ZJ GRAND-CHEROKEE	17714.05	53030343
1996-98 6 CYL 4.0L WRANGLER, XJ CHEROKEE & ZJ GRAND-CHEROKEE	17714.02	53030778
1993-95 8 CYL 5.2L ZJ GRAND-CHEROKEE	17714.06	53007809
1996-98 8 CYL 5.2L ZJ GRAND-CHEROKEE	17714.02	53030778
1999-2004 4.0L WJ GRAND CHEROKEE, 1999-01 4.0L XJ	NEW 17714.07	4854181
1999-00 4.7L WJ GRAND CHEROKEE	NEW 17714.08	53030842
2001-04 4.7L WJ GRAND CHEROKEE	NEW 17714.09	53032145AA
2002-03 3.7L KJ LIBERTY	NEW 17714.10	53031099
1999-04 2.5L & 2.4L TJ, 2002-03 2.4L KJ	NEW 17714.11	53013490AA

FUEL GAUGES:

	Stock No.	Replaces
1946-56 CJ2A, CJ3A, EARLY CJ3B (6 VOLT)	17210.06	640763
1946-56 CJ2A, CJ3A, EARLY CJ3B (12 VOLT)	17210.07	640763-12V
1955-86 CJ3B-LATE, CJ5, CJ6, CJ7, CJ8 (PAIRED WITH TEMP GAUGE)	17209.01	8126919K
FUEL AND TEMP GAUGE MUST BE REPLACED AT THE SAME TIME		
1980-86 CJ5, CJ7, CJ8 (NEW BI-TORQUE DESIGN), PAIRED WITH TEMP	17209.02	4740791
17209.02 GAUGE PAIR MUST BE USED TOGETHER		



17209.01



17209.02

PCV VALVES:

	Stock No.	Replaces
1980-92 CJ, YJ, 4 CYL.	17404.01	8132309
1983-90 CJ, 6 CYL.	17404.02	33000887
1971-91 CJ, 8 CYL.	17404.03	3234216
1993 V8 ZJ GRAND CHEROKEE	17404.04	4206923
1994-98 V8 ZJ GRAND CHEROKEE	17404.05	53031135



17404.01

IN-LINE FUEL FILTER KITS:

	Stock No.	Replaces
CJ KIT WITH HOSES & CLAMPS, SINGLE OUTLET	17718.01	8126312
CJ KIT WITH HOSES & CLAMPS, DUAL OUTLET	17718.02	8129383
1984-95 XJ CHEROKEE, 4 OR 6 CYL	17718.03	33000076
1993-96 6 or 8 CYL GRAND CHEROKEE	17718.04	52005131
1997-04 ALL TJ'S, 1997-01 ALL XJ'S, 1997-98 ALL ZJ'S	NEW 17718.05	4798301



17718.02



STEEL GAS TANKS & SKID PLATES:

	Stock No.	Replaces
1941-42 EARLY MB, SMALL SPOUT, UNDER SEAT	17720.01	A-1221
1942-45 LATE MB, LARGE SPOUT, UNDER SEAT	17720.02	A-6618
1950-51 M38, UNDER SEAT	17720.03	649759
1946-53 CJ2A, CJ3A AND EARLY CJ3B	17720.04	640685
1956-64 "LATE" CJ3B	17720.05	911895
1953-67 CJ5, CJ6 UNDER DRIVER SEAT	17720.06	912008
1951-68 M38A1, UNDER SEAT	17720.07	805605
1970-75 CJ, 2.25" INLET DIAMETER, 6.5" FILLER NECK LENGTH	17720.08	5355314
1976-77 CJ, 2.25" INLET DIAMETER, 1.25" FILLER NECK LENGTH	17720.09	8127698
1976-86 CJ, 1" INLET DIAMETER	17720.10	8128585
1976-86 CJ, 23.9 GALLON STEEL GAS TANK, SUPER DUTY	17720.11	8128585_XL
1987-90 YJ WRANGLER, 4 CYL 2.5L ENGINE	17720.12	83502961
1987-90 YJ WRANGLER, 6 CYL 4.2L ENGINE	17720.13	83502960
1984-93 XJ CHEROKEE, WITH CARB OR DIESEL	17720.14	83500267
1984-93 XJ CHEROKEE, WITH FUEL INJECTION	17720.15	83502633
1976-90 CJ & YJ WRANGLER GAS TANK SKID PLATE FOR 15 GAL TANKS	17721.01	5357023
1987-95 YJ FOR FACTORY 20 GAL FUEL TANK (SKID PLATE)	17721.02	52006870



PLASTIC GAS TANKS:

	Stock No.	Replaces
1945-60 CJ2A,CJ3A, EARLY CJ3B UNDER SEAR	17722.01	640685PL
1945-60 CJ2A, CJ3A, EARLY CJ3B UNDER PASSENGER SIDE SEAT	17722.02	640685PL-R
1960-63 LATE CJ3B UNDER SEAT	17722.03	911895PL
1963-63 LATE CJ3B UNDER PASSENGER SIDE SEAT	17722.04	911895PL-R
1955-69 CJ5 & CJ6 UNDER SEAT	17722.05	912008PL
1955-69 CJ5 & CJ6 UNDER PASSENGER SIDE SEAT	17722.06	947067PL-R
1967-71 V6 CJ5 & CJ6 UNDER SEAT	17722.07	947067PL
1967-71 V6 CJ5 & CJ6 UNDER PASSENGER SIDE SEAT	17722.08	947067PL-R
1970-76 CJ 15 GALLON REAR MOUNTED	17722.09	8127698PL
1970-76 CJ 21 GALLON X-LRG REAR MOUNT (REPLACES 15 GAL STOCK)	17722.10	8127698PL-XL
1978-86 CJ 15 GALLON	17722.11	8128585PL
1978-86 CJ 21 GALLON X-LRG (REPLACES 15 GAL STOCK)	17722.12	8128585PL-XL
1987-90 YJ WRANGLER 15 GALLON	17722.13	83502960PL
1947-63 WILLYS® PICK-UP (INCLUDES MOUNTING KIT)	17722.14	MTS-0010
1962-77 JEEP® TRUCK J10 / J20 (NEEDS 17723.01)	17722.15	MTS-0011
1978-79 JEEP® TRUCK J10 / J20 MODELS WITH SIDE FILLER PIPE (NEEDS 17723.01)	17722.16	MTS-0012
1978-79 JEEP® TRUCK J10 / J20 MODELS WITH FRNT FILLER PIPE (NEEDS 17723.01)	17722.20	MTS-0013
1970-77 WAGONEER & CHEROKEE (INCLUDES MOUNTING KIT)	17722.18	MTS-0020
1978-79 WAGONEER & CHEROKEE (INCLUDES MOUNTING KIT)	17722.19	MTS-0022
1946-62 WAGON, (INCLUDES STRAP KIT)	17722.21	MTS-0018
STRAP KIT, NEEDED WHEN USING 17722.15, 17722.16 or 17722.14	17723.01	MTS-STRAP1



HARD PARTS

FUEL TANK FLOATS, SENDING UNITS & COMPONENTS:

	Stock No.	Replaces
1946-58 CJ2A, CJ3A & EARLY CJ3B, SENDING UNIT	17724.01	640694
1946-58 CJ2A, CJ3A & EARLY CJ3B, SENDING UNIT GASKET	17725.01	648927
1955-66 4 CYL CJ5,(AND LATE MODEL 3B),GAS TANK SENDING UNIT	17724.02	914850
1955-66 4 CYL SENDING UNIT GASKET (BETWEEN TANK & SENDING UNIT)	17725.02	635641
1967-71 4 CYL CJ, SENDING UNIT	17724.03	948697
1967-71 V6 CJ, SENDING UNIT	17724.04	948696
1946-63 226 WAGON, GAS SENDING UNIT	17724.05	914848
1946-63 226 TRUCK, GAS SENDING UNIT	17724.06	914849
1970-86 CJ, GAS TANK SENDING UNIT FOR: 15 GALLON TANK	17724.07	5357373
SAME AS 17724.07 - STEWART WARNER BRAND	17724.08	5357373S
1970-86 CJ, GAS TANK SENDING UNIT KIT	17724.09	5357373K
KIT=SENDING UNIT, FILTER, O-RING & LOCK-RING		
SAME AS 17724.09 - STEWART WARNER BRAND SENDING UNIT	17724.10	5357373SK
1970-86 CJ SENDING UNIT WHEN USING 17722.12 OR 17722.10 GAS TANKS	17724.11	5357373-L
1982-86 CJ, SENDING UNIT FOR: FACTORY 20 GALLON TANK	17724.12	5362090
1982-86 CJ, SENDING UNIT FOR: FACTORY 20 GAL PLASTIC TANK KIT	17724.13	5362090K
SAME AS 17724.12 - STEWART WARNER BRAND	17724.14	5362090S
1982-86 CJ, STEWART WARNER SENDING UNIT KIT: FOR: FACTORY 20 GAL TANK	17724.15	5362090SK
1991-96 YJ SENDING UNIT, FOR: FACTORY 20 GAL TANK	17724.16	5003861AA
POSTAL DJ'S, SENDING UNIT	17724.17	5995820



... (continued on next page)

TBA= TO BE ANNOUNCED

FUEL TANK FLOATS, SENDING UNITS & COMPONENTS: ... (continued from previous page)

	Stock No.	Replaces
1970-79 SJ WAGONEER, FUEL TANK SENDING UNIT	17724.18	5361468
1981-UP SJ WAGONEER, FUEL TANK SENDING UNIT	17724.20	5363490
1970-79 SJ TRUCK, FUEL TANK SENDING UNIT	17724.21	5357677
1970-79 SJ BIG WAGONEER FUEL TANK SENDING UNIT	17724.22	5357843
1987-90 2.5L 4 CYL WRANGLER FUEL SENDING UNIT	17724.23	TBA
1987-90 4.2L 6 CYL WRANGLER FUEL SENDING UNIT	17724.24	TBA
1970-86 CJ O-RING FUEL TANK (BOTH 15 GAL & FACTORY 20 GAL TANKS)	17730.01	941521
1987-93 WRANGLER O-RING	17730.02	53000575
1970-86 CJ LOCK RING, 15 GAL FUEL TANK	17727.01	929669
1982-86 CJ WITH FACTORY 20 GAL TANK LOCK NUT	17727.02	5370014
1987-90 WRANGLER LOCK RING	17727.03	52127918
1970-86 CJ FUEL FILTER, FOR FACTORY 15 GAL TANK	17728.01	3230376
1982-86 CJ IN TANK FUEL FILTER FOR FACTORY 20 GAL TANK	17728.02	5361389
1987-93 2.5L 4 CYL, 1991-93 4.0L 6 CYL WRANGLER TANK FILTER	17728.03	33003592
1987-90 4.0L 6 CYL WRANGLER FUEL FILTER	17728.04	53001248
PLASTIC FLOAT, WILL FIT ALL OUR CJ SENDING UNITS	17729.01	5357373-F



17729.01



17726.06



Locking Gas Cap
17726.08



Non-Locking Gas Cap
17726.09

GAS CAPS

	Stock No.	Replaces
1942-44 LATE MB, GPW, NON-LOCKING	17726.01	A-6333
1946-71 ALL CJ'S WITHOUT LOCK (SHINY), NON-LOCKING	17726.02	908593
1946-71 ALL CJ'S, WITH CHECK VALVE, OE STYLE, BLACK, NON-LOCKING	17726.03	640594
1971-76 CJ, NON-LOCKING	17726.04	994739
1971-76 CJ LOCKING GAS CAP	17726.05	994739L
1977-90 CJ & YJ LOCKING GAS CAP	17726.06	5350828
1977-90 CJ & YJ NON-LOCKING, NON-VENTED GAS CAP	17726.07	5358207
1991-00 YJ, TJ, LOCKING GAS CAP	17726.08	4637081L
1947-63 WAGON & TRUCK NON LOCKING GAS CAP	NEW 17726.11	992879
2001 TJ 4 CYL, LOCKING GAS CAP	17726.08	4637081L
1984-99 XJ LOCKING GAS CAP	17726.08	4637081L
1993-98 ZJ LOCKING GAS CAP	17726.08	4637081L
1999-00 WJ, LOCKING GAS CAP	17726.08	4637081L
1991-00 YJ, TJ, NON-LOCKING, NON-VENTED GAS CAP	17726.09	4637081
2001 TJ 4 CYL, NON-LOCKING, NON-VENTED GAS CAP	17726.09	4637081
1984-99 XJ, NON-LOCKING, NON-VENTED GAS CAP	17726.09	4637081
1993-98 ZJ, NON-LOCKING, NON-VENTED GAS CAP	17726.09	4637081
1999-00 WJ, NON-LOCKING, NON-VENTED GAS CAP	17726.09	4637081
2002 ALL TJ, KJ, WJ, LOCKING GAS CAP	17726.10	52100414AA
2001 6 CYL TJ, 2001 WJ, LOCKING GAS CAP	17726.10	52100414AA
2000-01 XJ, LOCKING GAS CAP	17726.10	52100414AA
2002-04 TJ, 2001-02 WJ, NON-LOCKING GAS CAP	NEW 17726.12	52100552AE

UNIVERSAL STEEL FUEL LINE

	Stock No.	Replaces
13/16" X .028" STEEL FUEL LINE COIL WITH 16 FITTINGS, 25'	16737.80	53K3
1/4" X .028" STEEL FUEL LINE COIL WITH 14 FITTINGS, 25'	16737.81	53K4
5/16" X .028" STEEL FUEL LINE COIL WITH 10 FITTINGS, 25'	16737.82	53K5
3/8" X .028" STEEL FUEL LINE COIL WITH 6 FITTINGS, 25'	16737.83	53K6



16737.82

FUEL LINE SETS

	Stock No.	Replaces
1941-44 MB & GPW FUEL LINE SET	17732.01	MS00200
1945 MB & GPW FUEL LINE SET	17732.02	MS00201
1950-52 M38 FUEL LINE SET	17732.03	MS00202
1951-68 M38A1 FUEL LINE SET	17732.04	MS00203
1953-66 4-CYL CJ5 FUEL LINE SET	17732.05	MS00204
CJ2A, FUEL LINE SET (ALL METAL LINES EXCEPT FOR THE HOSE)	17732.06	MS01200

17732.06



1941-71 MISC. FUEL & INTAKE COMPONENTS



17733.01

17735.01



12025.24



17743.01

17742.01



12021.62

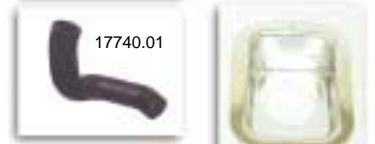

17740.01



17739.01

11135.01

HARD PARTS

TBA= TO BE ANNOUNCED

	Stock No.	Replaces
1941-53 MB, CJ2A, CJ3A ACCELERATOR PEDAL	17733.01	640720
1953-71 CJ3B, CJ5, CJ6 (4 CYL) ACCELERATOR PEDAL	17733.02	805546
1955-71 CJ5, CJ6 DUST BOOT FOR ACCELERATOR PEDAL	17734.01	646073
1946-71 CJ2A, 3A, 3B, CJ5, CJ6 GAS TANK STRAP KIT	12025.24	A-1472K
1946-71 CJ2A, 3A, 3B, CJ5, CJ6 FUEL NECK PLATE	12025.25	663505
1945-71 CJ'S FUEL TANK NECK GROMMET	12025.23	663502
1953-71 M38 & M38A1 FUEL TANK NECK GROMMET	12023.11	673415
1946-71 CJ2A, 3A, 3B, CJ5, CJ6 THROTTLE CONTROL CABLE, BLACK KNOB	17735.01	946225
1941-71 MB, M38, M38A1, THROTTLE CABLE, OLIVE GREEN KNOB	17735.02	A-5106
1946-71 CJ2A, 3A, 3B, CJ5, CJ6 CHOKE CONTROL CABLE, BLACK KNOB	17736.01	946229
1941-71 MB, M38, M38A1, CHOKE CONTROL CABLE, OLIVE GREEN KNOB	17736.02	A-1301
(1) 1941-68 134 LH ENGINES, RUBBER TUBE (AIR-CLEANER TO AIR HORN)	17737.01	A-17317
(2) 1941-68 134 LH ENGINES, RUBBER TUBE (AIR-HORN TO CARB)	17737.02	A-17318
(3) 1941-45 MB 4-134 L-HEAD ENGINE, AIR CLEANER LONG TUBE	12021.59	A-6911
(3) 1946-68 CJ 4-134 L-HEAD ENGINES, AIR-CLEANER TUBE	12025.30	641930
(4) 1941-53 MB, CJ2A, 3A AIR CLEANER HOSE	TBA	17737.05 646753
(4) 1953-1971 134 F-HEAD ENGINES, AIR CLEANER HOSE	17737.06	926945
(5) 1941-55 MB, 2A, 3A L-HEAD AIR CLEANER HORN	12021.58	641918
(5) 1955-71 3B, CJ5, CJ6 F-HEAD AIR CLEANER HORN	12025.29	809785
(6) 1941-55 MB, 2A, 3A L-HEAD AIR CLEANER ASSEMBLY	17737.09	645368K
1941-55 MB, CJ2A, 3A AIR CLEANER NUT WING	17737.10	115905
1941-55 MB, CJ2A, 3A AIR CLEANER TO FIREWALL BRACKET, RH	17737.11	640947
1941-55 MB, CJ2A, 3A AIR CLEANER TO FIREWALL BRACKET, LH	17737.12	640948
1941-68 MB, M38, M38A1, CJ'S JERRY CAN CARRIER (W/O JERRY CAN)	12021.62	A-4123
1941-68 CJ 4 CYL L-HEAD INTAKE MANIFOLD	17738.01	A-1166

1972-95 MISC. FUEL & INTAKE COMPONENTS

	Stock No	Replaces.
1976-86 CJ GAS TANK CENTER STRAP	17739.01	5356651
1987-90 WRANGLER CENTER STRAP	TBA	17739.02
1997-05 TJ WRANGLER, FUEL TANK CENTER STRAP	NEW 17739.06	52100235AC
1976-86 CJ GAS TANK STRAP (20-GALLON AFTERMARKET PLASTIC TANK)	17739.03	5356651-XL
1976-90 CJ & YJ WRANGLER, DRIVER SIDE GAS TANK STRAP	17739.04	5357879
1976-90 CJ & YJ WRANGLER, PASSENGER SIDE GAS TANK STRAP	17739.05	5357880
1970-75 CJ GAS FILLER HOSE	17740.01	992965
1976 CJ GAS FILLER HOSE	17740.02	5354760
1978-86 CJ5, CJ7 GAS FILLER HOSE (FACTORY 15 GAL TANK)	17740.03	5357970
1982-86 CJ5, CJ7 WITH FACTORY 20 GAL TANK FILLER HOSE 1-1/4" DIA	17740.04	5362158
1982-86 CJ8 GAS FILLER HOSE 1" DIAMETER	17740.05	5364196
1987-90 WRANGLER FILLER HOSE 1" DIAMETER	17740.06	52040078
1991-95 YJ WRANGLER, WITH 20 GALLON TANK, FILLER HOSE	17740.07	52040079
1998-UP TJ WRANGLER, FUEL TANK FILLER HOSE	17740.08	52100032AD
1978-86 CJ5, CJ7 VENT HOSE (FACTORY 15 GAL)	17741.01	5357971
1982-86 CJ5 & CJ7 WITH FACTORY 20 GAL TANK VENT HOSE 1"	17741.02	5362159
1982-86 CJ8 GAS VENT HOSE	17741.03	5364195
1987-90 WRANGLER VENT HOSE 11/16" DIA	17741.04	52040080
1991-95 WRANGLER WITH 20 GALLON TANK, VENT HOSE	17741.05	52040081
1998-UP TJ WRANGLER FUEL TANK VENT HOSE	17741.06	52100033AD
1977-95 CJ & YJ, PLASTIC FILLER PROTECTOR	17742.01	5463803
1977-95 CJ & YJ WRANGLER GAS FILLER PROTECTOR, STAINLESS STEEL	11135.01	5463803M
1997-UP TJ WRANGLER, FILLER NECK (PLASTIC)	NEW 17742.02	52127675AC
1997-UP TJ WRANGLER, GAS TANK FILLER NECK, STAINLESS STEEL	11135.02	MS-30480
1977-86 CJ5, CJ7 & 1981 CJ8 GAS FILLER NECK	17743.01	5364760
1987-90 WRANGLER GAS FILLER NECK	TBA	17743.02 52002437
1991-95 UNLEADED YJ WRANGLER FUEL NECK FITS 15 & 20 GAL MODELS	NEW 17743.03	52007386
HOSE CLAMP 1-1/4", TO FIT MANY FUEL HOSES	17744.01	5229
HOSE CLAMP 1-1/2", TO FIT MANY FUEL HOSES	17744.02	5230
HOSE CLAMP 3", TO FIT MANY FUEL HOSES	17744.03	5231

HEATER CORES:

DESCRIPTION	Stock No.	Replaces
1972-77 CJ WITH 2 SPEED HEATER MOTOR	17901.01	8125123
1978-86 CJ WITH 3 SPEED HEATER MOTOR	17901.02	5469877
1987-95 YJ WRANGLER (4 OR 6 CYL)	17901.03	56001459
1997-01 TJ WRANGLER	TBA	17901.04
2002-06 TJ WRANGLER (WILL NOT FIT 1997-01 TJ's)	17901.05	5073180AA
1972-77 SJ	17901.06	8122120
1978-83 SJ	17901.07	8128784
1984-96 XJ CHEROKEE	17901.08	56000049
1993-98 ZJ GRAND CHEROKEE	17901.09	4720008



HEATER SWITCHES:

DESCRIPTION	Stock No.	Replaces
1976-77 CJ, 2 SPEED	17903.01	5459136
1978-86 CJ 3 SPEED	17903.02	5462784

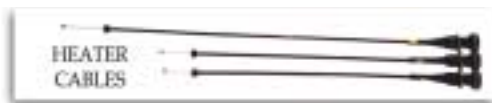

BLOWER MOTORS:

DESCRIPTION	Stock No.	Replaces
1972-77 CJ	17904.01	8127021
1978-90 CJ, YJ WRANGLER HOLE IN FIREWALL MAY NEED TO BE ENLARGED	17904.02	4761520
1991-95 YJ WRANGLER	17904.03	55036898
1988-93 XJ CHEROKEE	17904.04	56002858
1993-98 ZJ GRAND CHEROKEE	17904.05	4720006



BLOWER MOTOR

HEATER CABLES:

DESCRIPTION	Stock No.	Replaces
1978-86 CJ, HEATER DEFROST CABLE 21"	17905.01	5463655
1978-86 CJ, HEATER TEMP CABLE 21.5"	17905.02	5463656
1978-86 CJ, HEATER AIR CABLE 28"	17905.03	5463657
1978-86 CJ, VENT CABLE KIT, 3 PCS	17905.04	5463657K

FRESH AIRBOX SYSTEM:

1972-77 CJ5, 1966-73 COMMANDO, FRESH AIR BOX ASSEMBLY W / BRACKETS	17906.01	5460038
--	----------	---------



17906.01



17907.01

DEFROST DUCTS:

DESCRIPTION	Stock No.	Replaces
1955-77 CJ, DEFROST DUCT (PLASTIC)	17907.01	M1111
1978-86 CJ, DEFROST DUCT HOSE, OVAL SHAPE	17907.02	5462328
1978-86 CJ, DEFROST DUCT, OVAL SHAPE PLASTIC	17907.03	5461591
1976-86 CJ, DEFROSTER DEFLECTOR PAIR	17907.04	5750340K
1978-86 CJ, FLOOR HEATER DUCT CONVERSION (YJ VERSION)	17907.05	55035618
1987-95 YJ WRANGLER FLOOR HEATER DUCT	17907.05	55035618



17907.02



17907.03



17907.05



17907.04

HEATER TUBE, MOTOR SEALS & MISC. ITEMS:

DESCRIPTION	Stock No.	Replaces
1978-95 CJ & YJ WRANGLER, HEATER CORE TUBE SEAL	17908.01	56004535
1978-90 CJ & YJ WRANGLER, FIREWALL HEATER MOTOR SEAL	17908.02	5462710
1991-95 YJ WRANGLER, FIREWALL HEATER MOTOR TO SEAL	17908.03	55035566
1968-86 CJ HEATER SWITCH KNOB	13318.05	5459189



17908.01



17908.03



17950.05

HVAC DOOR LEVERS:

DESCRIPTION	Stock No.	Replaces
1997-UP TJ WRANGLER, FOR LOWER AC PANEL DOOR	17910.01	4886086AB
1997-UP TJ WRANGLER, FOR UPPER DEFROSTER DOOR	17910.02	5014108AA



17951.03



17952.05

A/C CONDENSORS:

DESCRIPTION	Stock No.	Replaces
1987-90 XJ CHEROKEE, W / FACTORY AC, EXPANSION VALVE	17950.01	56003173
1987-95 YJ WRANGLER, 4 or 6 CYL,	17950.02	55036213
1997-UP TJ WRANGLER, 4 or 6 CYL	17950.03	55036366
1987-97 4-CYL XJ CHEROKEE	17950.04	56002190
1984-86 2.8L V6 XJ CHEROKEE	17950.04	56002190
1987-91 6-CYL XJ CHEROKEE	17950.05	56002957
1992-97 6-CYL XJ CHEROKEE W/ SERPENTINE	17950.06	56002730
1997-98 6-CYL XJ CHEROKEE W/ PARALLEL FLOW	17950.07	55036595AB
1993-98 6 OR 8 CYL ZJ GRAND CHEROKEE	17950.08	55036473
1999-01 6 OR 8 CYL WJ GRAND CHEROKEE	17950.09	55115918AB



17910.01



17953.01

A/C DRIERS:

DESCRIPTION	Stock No.	Replaces
1984-86 2.5L, 2.8L V6, 2.1L DIESEL XJ CHEROKEE	17951.01	56000687
1987-96 4-CYL XJ CHEROKEE	17951.02	56001938
1987-90 6-CYL XJ CHEROKEE	17951.03	4773765
1991-96 6-CYL XJ CHEROKEE WITH R12 SYSTEM	17951.04	4773767
1994-96 6-CYL XJ CHEROKEE WITH T134A SYSTEM	17951.05	4797002
1993-94 6-CYL ZJ GRAND CHEROKEE	17951.06	55036152
1993 V8 ZJ GRAND CHEROKEE	17951.07	4740767

A/C EVAPORATORS:

DESCRIPTION	Stock No.	Replaces
1987-90 4-CYL OR 6-CYL XJ CHEROKEE	17952.01	56002568
1991-93 4-CYL OR 6-CYL XJ CHEROKEE	17952.02	56002618
1994-96 4-CYL OR 6-CYL XJ CHEROKEE	17952.03	4773117
1993 ZJ GRAND CHEROKEE (6 OR 8 CYL)	17952.04	4723069
1994-98 6-CYL OR 8-CYL ZJ GRAND CHEROKEE	17952.05	4798705

A/C COMPRESSORS:

DESCRIPTION	Stock No.	Replaces
1984-90 4-CYL XJ CHEROKEE (ALSO FITS 1984-86 2.8L V6 XJ CHEROKEE)	17953.01	56002568

AGR POWER STEERING COMPONENTS:

SUPER PUMPS:	Stock No.
1972-79 CJ, 1971-79 SJ:	AGR-805256
1980-86 ALL CJ's, 1987-90 ALL WRANGLERS, 1980-92 SJ:	AGR-807256
1991-95 ALL YJ WRANGLERS, 1991-96 2.5L XJ CHEROKEE:	AGR-813256
1997-01 2.5L 4 CYL TJ WRANGLER, XJ CHEROKEE:	AGR-811256
1997-01 4.0L 4 CYL TJ WRANGLER, XJ CHEROKEE:	AGR-812256
1993-98 ALL ZJ GRAND CHEROKEE, 1987-96 4.0L 6 CYL XJ CHEROKEE:	AGR-816256

SUPER-BOX-2:	Stock No.
1972-79 CJ, 1971-76 SJ	AGR-262317
1980-86 CJ	AGR-262357
1987-01 ALL YJ & TJ WRANGLERS, ALL XJ CHEROKEES ALL ZJ GRAND CHEROKEE AND 1980-92 SJ	AGR-262352

SUPER-BOX-1:	Stock No.
1972-79 CJ, 1971-76 SJ	AGR-262216
1980-86 CJ	AGR-262256
1987-01 ALL YJ & TJ WRANGLERS, ALL XJ CHEROKEES, ALL ZJ GRAND CHEROKEE AND 1980-92 SJ	AGR-262251

BORGESON HEAVY DUTY STEERING SHAFT:	Stock No.
1972-75 CJ W / FACTORY POWER STEERING	BGS-904
1972-75 CJ W/ MANUAL STEERING	BGS-903
1976-86 CJ W / MANUAL STEERING	BGS-905
1976-86 CJ W / MANUAL STEERING, WITH VIBRATION REDUCER	BGS-915
1976-86 CJ W / FACTORY POWER STEERING	BGS-910
1976-86 CJ W / FACTORY POWER STEERING, WITH VIBRATION REDUCER	BGS-920
1987-95 CJ WRANGLERS (W OR W/O POWER STEERING)	BGS-926
1987-95 CJ WRANGLERS (W OR W/O POWER STEERING), WITH VIBRATION REDUCER	BGS-925



HEAVY DUTY STEERING SHAFT

MANUAL STEERING GEAR BOX ASSEMBLIES & PARTS: (NEW)

DESCRIPTION	Stock No.	Replaces
1972-86 CJ GEAR BOX ASSEMBLY	18001.01	994509
1972-86 RIGHT HAND DRIVE & POSTAL	18001.02	5994000
1974-86 SJ GEAR BOX ASSEMBLY	18001.01	994509
1987-99 WRANGLER (YJ & TJ)	18001.03	52000089
1984-96 XJ CHEROKEE	18001.03	52000089
1972-86 CJ, 1974-86 SJ, SECTOR SHAFT	18002.01	8120221
1972-86 CJ, 1974-86 SJ, SECTOR SHAFT BUSHING	18002.02	3200496
1972-86 CJ, 1974-86 SJ, SECTOR SHAFT OIL SEAL	18002.03	4486140
1972-86 CJ, 1974-86 SJ, WORM SHAFT OIL SEAL	18002.04	4486141
1976-86 CJ, STEERING BOX MOUNTING TIE PLATE	18003.01	5355962
1976-86 CJ, STEERING BOX UPPER MOUNTING BRACKET	18003.02	5355446
1976-86 CJ, STEERING BOX LOWER MOUNTING BRACKET	18003.03	8127536

NEW POWER STEERING GEAR BOX ASSEMBLIES & PARTS:

1981-86 CJ	18004.01	TBA
1987-95 YJ WRANGLER	18004.02	52038003
1984-90 XJ CHEROKEE	18004.03	52002737
1991-96 XJ CHEROKEE	18004.04	52038002
1993-98 V8 ZJ GRAND-CHEROKEE W/O TRAILER TOW	18004.05	52088488
1993-95 V8 ZJ GRAND-CHEROKEE WITH TRAILER TOW	18004.05	52088488
1999-03 WJ GRAND CHEROKEE, 6 or 8 CYL, LHD	18004.06	52088272AF
2003-04 WJ GRAND CHEROKEE, (EXPORT MODELS ONLY), LHD	18004.07	52088273AF
1997-01 XJ CHEROKEE, LHD	18004.08	52088386AE
1999-04 WJ GRAND CHEROKEE, 6 or 8 CYL, RHD	18004.09	52088471AF
1974-99 ALL MODELS, VALVE RING & SEAL REPAIR KIT	18005.01	3204833
1974-99 ALL MODELS, PITMAN ARM SEAL REPAIR KIT	18005.02	8134568
ALL POWER STEERING BOXES, PITMAN ARM SEAL REPAIR KIT	18005.03	8125038
1976-86 CJ, STEERING BOX UPPER MOUNTING BRACKET	18003.02	5355446
1976-86 CJ, STEERING BOX LOWER MOUNTING BRACKET	18003.03	8127536
1976-86 CJ HEAVY DUTY STEERING BOX BRACE (W/ PS)	18003.10	TBA

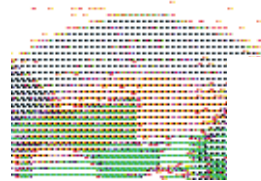

SUPER PUMPS:



SUPER-BOX-1:

Borgeson Steering Shaft Assemblies Are Backed By A 3 Year, 36,000 Mile Warranty!

The telescoping shaft reduces vibration and adds a measure of safety to the original CJ Steering System.



18001.01



18002.01



SEALS & BUSHING



18004.01



18004.02



18005.01



18005.02



18005.03



18003.03

18003.03

REBUILT POWER STEERING GEAR BOX ASSEMBLIES

1972-79 CJ	NEW	18004.71	994508R
1980-86 CJ	NEW	18004.72	5363231R
1987-95 YJ	NEW	18004.73	52038003R
1997-02 TJ	NEW	18004.74	52089046R

NEW POWER STEERING PUMPS (PULLEY NOT INCLUDED):

DESCRIPTION	Stock No.	Replaces
1980-86 CJ 6 OR 8 CYL	18008.01	3237194
1983-86 CJ 4 CYL 2.5L	18008.02	33001907
1987-90 YJ WRANGLER	18008.02	33001907
1991-95 YJ WRANGLER	18008.04	53007140
1986 XJ CHEROKEE (4 OR 6 CYLINDER)	18008.05	53003903
1987-90 4.0L XJ, (GENUINE SAGINAW)	NEW 18008.20	53005437
1992-95 XJ CHEROKEE 4 CYL 2.5L	18008.06	52037566
1992-95 XJ CHEROKEE 6 CYL 4.0L	18008.07	52088131
1996-98 XJ CHEROKEE 6 CYL 4.0L	18008.08	52087871
XJ CHEROKEE EXPORT	18008.09	52088327
1993-98 ZJ GRAND-CHEROKEE 6 CYL 4.0L	18008.07	52088131
1993-95 ZJ GRAND-CHEROKEE V8	18008.10	52088139
1996-98 ZJ GRAND-CHEROKEE V8 (W/O SPEED PROPORTIONAL STEERING)	18008.10	52088139
1997-02 2.5L TJ	NEW 18008.11	52088018
2002-04 3.7L KJ (GENUINE SAGINAW)	NEW 18008.12	52088710AC
2001-04 4.7L WJ GRAND CHEROKEE (GENUINE SAGINAW)	NEW 18008.13	52089300AB
1990 4.0L XJ CHEROKEE (GENIUNE SAGINAW)	NEW 18008.14	53008448
2001-04 4.L WJ GRAND CHEROKEE	NEW 18008.15	5080551AB
1991-96 2.5L XJ WITH GAS ENGINE (SAGINAW)	NEW 18008.16	52088123
1997-05 4.0L TJ WRANGLER (SAGINAW)	NEW 18008.17	52087871AE
1999-01 4.0L WJ & 1999-00 4.07L WJ (SAGINAW)	NEW 18008.18	52088278AB
2003-05 2.4L TJ WRANGLER (SAGINAW)	NEW 18008.19	52089018AC
SEAL KIT	18010.01	83500369
SEAL KIT, ADJUSTING PLUNGE	18010.02	8130157
1997-UP W / POWER STEERING, PITMAN ARM SEAL KIT	18010.03	4470365
SEAL KIT	18010.04	8125037
POWER STEERING O-RING KIT	18010.05	83501039

POWER STEERING PRESSURE HOSES (PUMP TO GEAR BOX):

1976-79 6 OR 8 CYL CJ	18012.01	5357191
1980-86 6 CYL CJ	18012.02	5363661
1980-83 8 CYL CJ	18012.03	5370016
1987-90 6 CYL YJ WRANGLER	18012.04	52003687
1987-90 4 CYL YJ WRANGLER	18012.05	52040123
1991-95 6 CYL YJ WRANGLER	18012.06	52037644
1991-95 4 CYL YJ WRANGLER	18012.07	52038014
1984-85 4 CYL XJ CHEROKEE & 1984-86 V6 (2.8L) XJ CHEROKEE	18012.08	83504380
1986 4 CYL XJ CHEROKEE	18012.09	52002719
1987-90 6 CYL CHEROKEE	18012.10	52003627
1991-96 6 CYL XJ CHEROKEE & ZJ GRAND-CHEROKEE	18012.11	4637915
1997-01 4.0L XJ CHEROKEE	NEW 18012.12	52088489
1999-02 2.5L TJ	NEW 18012.13	520888548AB
1993-98 ALL ZJ W/O PROPORTIONING STEERING, GATE	NEW 18012.14	52088538
1993-98 ALL ZJ WITH PROPORTIONING STEERING	NEW 18012.15	52038501
1999-00 4.7L WJ	NEW 18012.16	52088453AB

POWER STEERING RETURN HOSES (GEAR BOX TO PUMP):

1983-86 2.5L AMC CJ	NEW 18014.13	5364673
1976-79 6 OR 8 CYL CJ	18014.01	5357190
1980-86 6 CYL CJ	18014.02	5363662
1980-83 8 CYL CJ	18014.03	5370019
1987-90 6 CYL YJ WRANGLER	18014.04	52002460
1991-95 4 OR 6 CYL YJ WRANGLER	18014.05	52038016
1991-95 6 CYL YJ WRANGLER (PUMP TO RESERVOIR CONNECTION)	18014.06	52004989
1987-90 6 CYL XJ CHEROKEE	18014.07	52003782
1997-02 4.0L TJ WRANGLER	NEW 18014.08	52038423AB
1993-98 ZJ GRAND CHEROKEE, ALL MODELS (GATE BRAND)	NEW 18014.09	52087748
1998-00 XJ CHEROKEE	NEW 18014.10	52003135AB
1992-01 4.0L XJ & 1991-96 4.0L YJ	NEW 18014.11	52037645
1999-00 4.7L WJ (MODELS W/O PS COOLER TUBE)	NEW 18014.12	52088777AA



18008.01



18008.05



18010.02

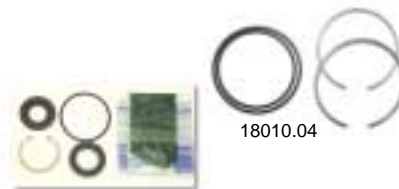

18010.04

18010.01

18010.03



18010.05



18012.02 - PRESSURE HOSE



18014.02 - RETURN HOSE

HARD PARTS

TBA= TO BE ANNOUNCED

LOWER STEERING SHAFT ASSEMBLIES & COMPONENTS:



	Stock No.	Replaces
1976-86 CJ WITH MANUAL STEERING SYSTEM	18016.01	5353135
1976-86 CJ WITH POWER STEERING SYSTEM	18016.02	5354934
1987-95 YJ WRANGLER STEERING SHAFT (MODELS WITH POWER STEERING)	18016.03	52007017
1972-75 CJ STEERING SHAFT YOKE ASSEMBLY WITH U-JOINT	18017.01	990192
1972-75 CJ SPARE U-JOINT KIT FOR STEERING YOKE	18017.02	8123301
1976-86 CJ, SPARE BOOT FOR COUPLING	18018.01	8132676
1976-86 CJ, SPARE BOOT KIT WITH 2 NUT BEARINGS & SPRING	18018.02	8132676K
1976-86 CJ, SPARE COUPLING, MANUAL STEERING	18018.03	8121299
1976-86 CJ SPARE COUPLING KIT WITH H/W, MANUAL STEERING	18018.04	8121299K
1976-86 CJ SPARE COUPLING, POWER STEERING	18018.05	998710
1976-86 CJ SPARE COUPLING KIT WITH H/W, P/S	18018.06	998710K
1976-86 CJ STEERING COUPLING CLAMP	18018.07	994605
1976-86 CJ COUPLING NUT BEARING (NEED 2)	18018.08	3204875
1976-86 CJ COUPLING NUT SPRING	18018.09	3204878
1976-95 CJ & YJ WRANGLER LOWER SHAFT COLUMN BEARING	18019.01	4486713
1976-95 CJ & YJ WRANGLER PLASTIC RETAINER, LOWER COLUMN	18019.02	4487696
1976-95 CJ & YJ WRANGLER LOWER COLUMN RETAINER, BEARING & H/W KIT	18019.03	4487696K
1976-95 CJ & YJ WRANGLER STEERING COLUMN TO FIREWALL SEAL	18020.01	3196896
CJ AND OTHER MODELS, STEERING COLUMN SECTOR KIT	18020.02	8120097
1976-86 CJ PLASTIC COLUMN COVER	18020.03	5354777
1976-86 CJ PLASTIC COLUMN COVER, CHROME PLATED	18090.01	5354777-CH
1976-86 CJ STAINLESS STEEL COLUMN COVER (FLAT STYLE)	11128.01	7446
1972-75 CJ STEERING BOX BRACE	18021.01	WAR895
1976-86 CJ STEERING BOX BRACE, HEAVY DUTY	18021.02	MS-9037
1987-95 YJ STEERING BOX BRACE	18021.03	WAR898
1997-99 TJ STEERING BOX BRACE	18021.04	WAR896



HEAVY DUTY STEERING SHAFTS FOR CJ:

1976-86 CJ WITH MANUAL STEERING SYSTEM	18024.01	5353135HD
1976-86 CJ WITH POWER STEERING SYSTEM	18024.02	5354934HD

STEERING KNUCKLE COMPONENTS:



	Stock No.	Replaces
1945-71 CJ STEERING KNUCKLE, LEFT	18026.01	805783
1945-71 CJ STEERING KNUCKLE, RIGHT	18026.02	805784
1945-71 ALL, STEERING KNUCKLE FELT & SEAL KIT, ONE SIDE	18026.03	915664
1941-71 ALL, STEERING KNUCKLE KING PIN BEARING CAP, EACH	18026.04	910901
1941-71 ALL, STEERING KNUCKLE KING PIN BEARING, EACH	18026.05	52940
1941-71 ALL, STEERING KNUCKLE KING PIN CUP, EACH	18026.06	52941
1941-71 ALL, STEERING KNUCKLE KING PIN SHIM SET, EACH	18026.07	A-6882



1941-75 STEERING GEAR BOX COMPONENTS & STEERING WHEELS:



1941-71 MB & 4 CYL CJ, SECTOR SHAFT	18027.01	805123
1941-49 MB & CJ2A, WORM SHAFT, 40.5"	18028.01	A-8838
1949-71 4 CYL CJ, WORM SHAFT, 41.5"	18028.02	647693
1953-56 M38 WORM SHAFT	18028.03	804388
1941-71 MB & 4 CYL CJ, WORM SHAFT BEARING KIT	18029.01	646084
1941-71 4 CYL (ALL), STEERING SHIM KIT	18029.02	A-6760
1941-71 MB & 4 CYL CJ, SPARE OIL SEAL, STEERING BOX	18029.03	927645
1950-71 M38, M38A1, V6 CJ. SECTOR SHAFT OIL SEAL	18029.04	801816
1941-71 MB & 4 CYL CJ, SPARE OUTER SECTOR SHAFT BUSHING	18029.05	639091
1941-71 MB & 4 CYL CJ, SPARE INNER SECTOR SHAFT BUSHING	18029.06	639090
1951-68 M38 & M38A1 SECTOR SHAFT BUSHING LONG	18029.07	647098
1951-68 M38 & M38A1 SECTOR SHAFT BUSHING SHORT	18029.08	647099
1949-71 4 CYL CJ, STEERING COLUMN TUBE WITH BEARING	18030.01	914054
1941-71 4 CYL STEERING COLUMN BEARING	18030.02	801422
1945-64 CJ, STEERING WHEEL (SIZE OF HORN BUTTON 1.25"), BLACK	18031.01	914047
1953-64 M38 & M38A1, STEERING WHEEL (SIZE OF HORN BUTTON 1.25"), GREEN	18031.02	A-6858
1941-45 MB STEERING WHEEL, GREEN, METAL SPOKES	18031.03	A-535
1964-75 CJ, STEERING WHEEL (SIZE OF HORN BUTTON 2-3/8"), BLACK	18031.04	927417
1941-49 MB & CJ2A HORN BUTTON KIT WITH NUT & WIRING	18032.01	A-6742K
1951-64 CJ3A, 3B, CJ5 HORN BOTTON & NUT	18032.02	802359
1951-64 CJ3A, 3B, CJ5 HORN BUTTON, NUT & WIRING	18032.03	802359K
1964-75 CJ, HORN BUTTON KIT	18032.04	927416K
1964-75 CJ HORN BUTTON ONLY, RUBBER	18032.05	927416
1941-49 MB & CJ2A, HORN CONTACT BUSHING	18032.06	A-302B



HARD PARTS

1976-95 ORIGINAL STYLE STEERING WHEEL:

	Stock No.	Replaces
1976-95 CJ & WRANGLER BLACK STEERING WHEEL, SPORT, 3 METAL SPOKE DESIGN	18031.05	8133016
SAME AS ABOVE, WITH LEATHER TRIM, BLACK	18031.06	8133026
1976-95 CJ & YJ STEERING WHEEL KIT & HORN BUTTON CAP	18031.07	8133016K
1976-95 CJ & YJ, LEATHER TRIM STEERING WHEEL KIT	18031.08	8133026K
1976-95 CJ & WRANGLER, STEERING WHEEL HORN BUTTON CAP, BLACK	18033.01	3238073



18031.08



BALL JOINT KIT PAIRS: (KIT = 1 UPPER + 1 LOWER + HARDWARE)

	Stock No.	Replaces
1972-86 CJ, LEFT OR RIGHT	18036.01	8124333
1974-91 SJ, LEFT OR RIGHT	18036.01	8124333
1987-04 WRANGLER (YJ & TJ), LEFT OR RIGHT	18036.02	83500202
1984-01 XJ CHEROKEE, LEFT OR RIGHT	18036.02	83500202
1993-98 ZJ GRAND-CHEROKEE, LEFT OR RIGHT	18036.02	83500202
SAME AS 18036.02 -SPICER BRAND	18036.03	83500202S
1999-UP WJ GRAND CHEROKEE	18036.04	5012432AA

UPPER BALL JOINT KITS (INCLUDES HARDWARE):

	Stock No.	Replaces
1972-86 CJ, LEFT OR RIGHT	18037.01	8122495
1974-86 SJ, LEFT OR RIGHT	18037.01	8122495
1987-04 WRANGLER (YJ & TJ), LEFT OR RIGHT	18037.02	83500202U
1987-01 XJ CHEROKEE, LEFT OR RIGHT	18037.02	83500202U
1993-98 ZJ GRAND-CHEROKEE, LEFT OR RIGHT	18037.02	83500202U

LOWER BALL JOINT KITS (INCLUDES HARDWARE):

	Stock No.	Replaces
1972-86 CJ, LEFT OR RIGHT	18038.01	8122496
1974-86 SJ, LEFT OR RIGHT	18038.01	8122496
1987-04 WRANGLER (YJ & TJ), LEFT OR RIGHT	18038.02	83500202L
1987-01 XJ CHEROKEE, LEFT OR RIGHT	18038.02	83500202L
1993-98 ZJ GRAND-CHEROKEE, LEFT OR RIGHT	18038.02	83500202L
2002-05 KJ LIBERTY, LOWER BALL JOINT	18038.03	5069161AB

BALL JOINT SPANNER WRENCH:

	Stock No.	Replaces
1974-86 CJ & SJ, FOR INSTALLING UPPER BALL JOINT	18039.01	T40207

STEERING DAMPER, O.E. STYLE:

	Stock No.	Replaces
1955-86 CJ	18040.01	940105
1974-91 SJ (WAGONEER, GRAND WAGONEER, J10, J20, ...)	18040.02	8129434
1987-00 WRANGLER (YJ & TJ)	18040.03	3236097HD
1984-00 XJ CHEROKEE	18040.03	3236097HD
1993-98 ZJ GRAND-CHEROKEE	18040.03	3236097HD
1999-01 WJ GRAND-CHEROKEE	18040.04	52088251

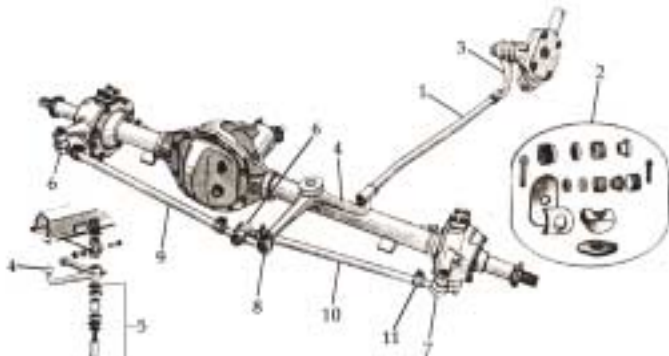

1941-71 MB, M38 & CJ TIE ROD ASSEMBLIES & COMPONENTS:

	Stock No.	Replaces
? STEERING DRAG LINKAGE (W/O HARDWARE), MB	NEW 18041.03	A-8250
1 1945-71 ALL CJ AFTER SERIAL #19907 DRAG LINKAGE WITH H/W	18041.01	646619
2 1945-71 4 CYL CJ, HARDWARE KIT FOR DRAG LINKAGE	18041.02	923418
3 1941-71 MB & 4 CYL CJ, PITMAN ARM	18006.30	A-1116
4 1950-66 ALL CJ'S AFTER SERIAL #199079, 7/8" SHAFT BELLCRANK	18042.01	647008
5 1941-49 MB & CJ BEFORE SERIAL 199079, BELLCRANK REPAIR KIT	18042.02	915762
5 1949-66 4 CYL CJ, BELLCRANK REPAIR KIT 7/8"	18042.03	920556
6 1941-71 MB & 4 CYL CJ, RIGHT THREAD TIE ROD END 11/16"	18043.04	8136600
6 1950-68 M38 & M38A1, RIGHT TIE ROD END 3/4"	18043.02	809191
7 1941-71 MB & 4 CYL CJ, LEFT THREAD TIE ROD END 11/16"	18043.03	8136674
7 1950-71 M38 & M38A1, LEFT THREAD TIE ROD END 3/4"	18043.01	809190
8 1945-71 4 CYL CJ, LEFT THREAD TIE ROD END WITH HOLE	18045.02	640178
8 1950-71 M38 & M38A1, LEFT THREAD TIE ROD END WITH HOLE	18045.01	809189
9 1949-71 4 CYL CJ TIE ROD ASM WITH TUBE, RIGHT SIDE, 24.5"	18046.01	642057
10 1949-71 4 CYL CJ TIE ROD ASM WITH TUBE, LEFT SIDE, 19.75"	18046.02	642056
11 1945-71 4 CYL CJ, TIE ROD ADJUSTING TUBE CLAMP (4 NEEDED)	18047.01	A-837
12 TIE ROD END SPARE BOOT	18048.01	645134

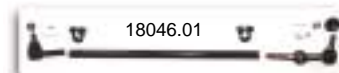

HARD PARTS

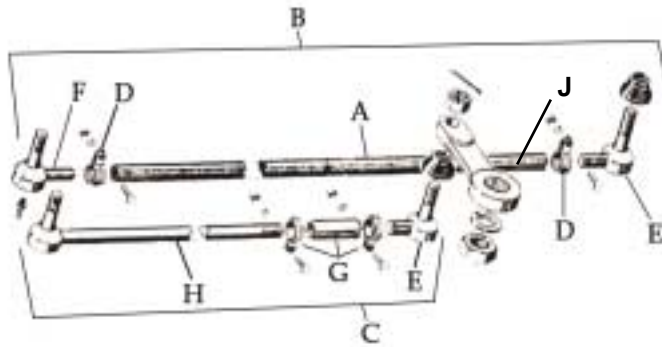

1972-86 CJ TIE ROD ASSEMBLIES & COMPONENTS:

ITEM #	DESCRIPTION	Stock No.	Replaces
A	1972-83 CJ5 & 1976-81 CJ7, 1981 CJ8, KNUCKLE TO KNUCKLE, 40.50" TUBE TIE ROD	18050.01	5350589
A	1982-86 CJ7 & CJ8, KNUCKLE TO KNUCKLE, 43.75" TUBE TIE ROD	18050.02	8134290
B	1972-81 CJ7 & CJ8 TIE ROD ASSY W/ KNUCKLE TO KNUCKLE, 40.05" TUBE	18052.01	5350586
B	1982-86 CJ7 & CJ8 TIE ROD ASSY W/ KNUCKLE TO KNUCKLE, 43.75" TUBE	18052.02	8134295
C	1972-83 CJ5 TIE ROD ASSY, PITMAN ARM TO STEERING ARM, 28 1/8"	18054.01	5356105
C	1976-81 CJ7 & CJ8 TIE ROD ASSY, PITMAN ARM TO STEERING ARM, 28 1/8"	18054.01	5356105
C	1982-86 CJ7&CJ8 TIE ROD ASSY, PITMAN ARM TO STEERING ARM, 30.5"	18054.02	8134350K
D	1972-86 CJ, TIE ROD TUBE CLAMP (EACH)	18047.01	A-837
E	1972-86 CJ, RIGHT THREAD TIE ROD END (2 NEEDED)	18043.04	8136600
F	1972-86 CJ, LEFT THREAD TIE ROD END (1 NEEDED)	18043.03	8136674
G	1972-86 CJ TIE ROD SLEEVE WITH CLAMPS	18056.01	3200671
H	1972-83 CJ5, 1976-81 CJ7 LONG DRAG LINK	18058.01	991744
H	1982-86 CJ7 & CJ8, LONG TIE ROD	18058.02	8134350
J	1976-86 CJ W / MANUAL STEERING, PITMAN ARM	18006.02	5356106
J	1976-86 CJ W / POWER STEERING, PITMAN ARM	18006.01	5356104

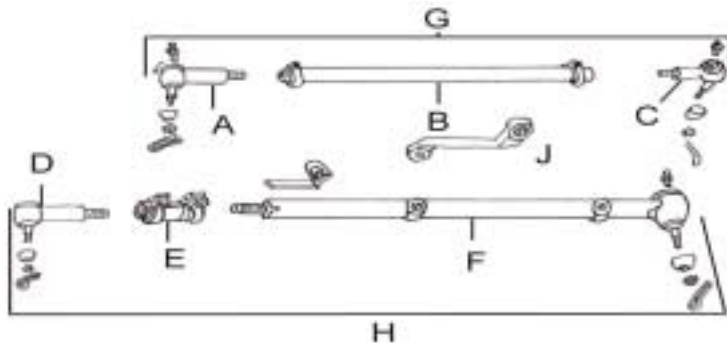
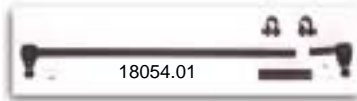
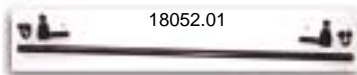

1987-06 WRANGLER TIE ROD ASSEMBLIES & COMPONENTS:

ITEM #	DESCRIPTION	1987-90 YJ		1991-95 YJ		1997-06 TJ	
A	TIE ROD END	18043.05	52000598	18043.06	52005741	18043.06	52005741
B	LONG TUBE DRAG LINK	18050.03	52002700	18050.04	52006608	18050.05	52087674
C	TIE ROD END	18043.07	52000599	18043.08	52005740	18043.08	52005740
D	TIE ROD END	18043.09	52002541	18043.10	52005739	18043.10	52005739
E	SHORT SLEEVE	18056.02	52002544	18056.02	52002544	18056.03	52005742
F	LONG TIE ROD	18058.03	52002540	18058.04	52006602	18058.05	52087887
G	TIE ROD KIT (A + B + C) DRAG LINK	18052.03	52002700K	18052.04	52006608K	18052.05	52087674K
H	TIE ROD KIT (D+ E + F)	18054.03	52002541K	18054.04	52005739K	18054.05	52087887K
I	STEERING DAMPNER (not shown)	18040.03	3236097HD	18040.03	3236097HD	18040.03*	3236097HD
J	PITMAN ARM, LHD (PWR Steering)	18006.03	52040112	18006.03	52040112	18006.05	52038337
J	PITMAN ARM, LHD (Manual Steering)	18006.04	52040110	18006.04	52040110	18006.06	52087883

*1997-2001 Only

HARD PARTS

TBA= TO BE ANNOUNCED

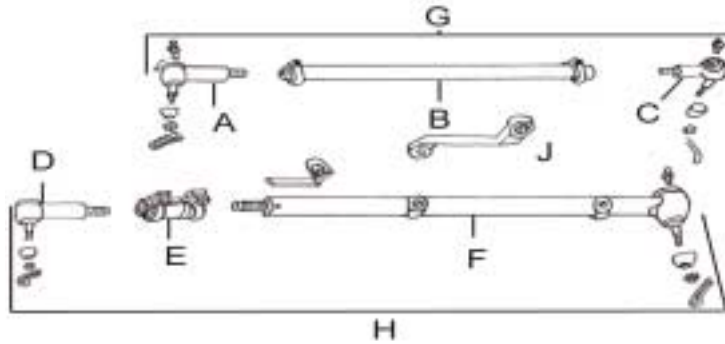

1984-01 XJ CHEROKEE, 1993-98 6 CYL ZJ GRAND CHEROKEE

TIE ROD ASSEMBLIES & COMPONENTS:

ITEM #	DESCRIPTION	1984-90 XJ	1991-01 XJ	1993-98 ZJ (6 cyl. 4.0L Only)
	TRACK BAR WITH BUSHING (not shown)	18205.03 52003918	18205.04 52007118	18205.04 52007118
A	TIE ROD END	18043.05 52000598	18043.06 52005741	18043.06 52005741
B	LONG TUBE DRAG LINK	18050.06 52000596	18050.07 52005743	18050.05 52087674
C	TIE ROD END	18043.07 52000599	18043.08 52005740	18043.08 52005740
D	TIE ROD END	18043.11 52000608	18043.10 52005739	18043.10 52005739
E	SHORT SLEEVE	18054.04 52001736	18056.03 52005742	18056.03 52005742
F	LONG TIE ROD	18058.06 52000601	18058.07 52006592	18058.08 52005738
G	TIE ROD KIT (A + B + C) DRAG LINK	18052.06 52000596K	18052.07 52005743K	18052.05 52087674K
H	TIE ROD KIT (D + E + F)	18054.06 52000601K	18054.07 52006592K	18054.08 52005738K
I	STEERING DAMPNER (not shown)	18040.03 3236097HD	18040.03 3236097HD	18040.03 3236097HD
J	PITMAN ARM, Power Steering Model, LHD	18006.08 52000615	18006.08 52000615	18006.09 52005285
J	PITMAN ARM, Manual Steering, LHD	18006.07 52000616	18006.07 52000616	N/A

1993-98 V8 (5.2L or 5.9L) ZJ GRAND CHEROKEE

TIE ROD ASSEMBLIES & COMPONENTS:

ITEM #	DESCRIPTION	1993-98 V8 (5.2L or 5.9L ZJ)
A	OUTER TO KNUCKLE TIE ROD	18058.09 52037994
B	SHORT SLEEVE	18056.03 52005742
C	TIE ROD END	18043.10 52005739
D	LONG END DRAG LINK	18058.10 52037996
E	SHORT SLEEVE	18056.03 52005742
F	TIE ROD	18043.10 52005739
G	TIE ROD KIT (A + B + C)	18052.08 52037994K
H	DRAG LINK KIT (D + E + F)	18054.09 52037996K
I	STEERING DAMPNER	18040.03 3236097HD
J	PITMAN ARM	18006.09 52005285

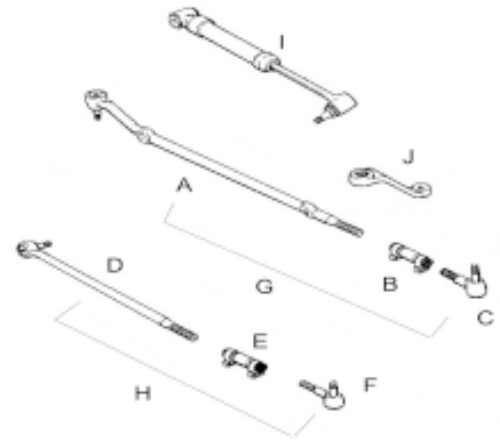

1999-04 WJ GRAND CHEROKEE

TIE ROD ASSEMBLIES & COMPONENTS:

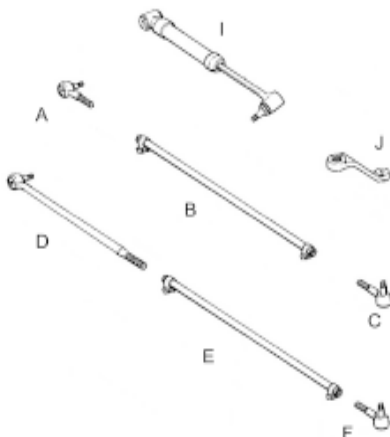

ITEM #	DESCRIPTION	Stock No.	Replaces
A	TIE ROD	18043.12	52088461
B	LONG TUBE DRAG LINK	18050.08	52088463AB
C	TIE ROD	18043.13	52088511
D	TIE ROD	18043.14	5208870AA
E	LONG TUBE TIE ROD	18050.09	5208871AB
F	TIE ROD	18043.15	5208869AA
G	TIE ROD KIT (A + B + C)	18052.09	52088463K
H	TIE ROD KIT (D + E + F)	18052.10	5208871K
I	STEERING DAMPNER	18040.04	52088251
J	PITMAN ARM	18006.10	52088242
	TRACK BAR	18205.06	52088305AB

PITMAN ARMS: (FOR LHD ONLY - WILL NOT FIT RHD)

1941-71 4 CYL MB & CJ (WILL NOT FIT M38 OR M38A1, OR 6 CYL CJ'S)	18006.30	A-1116
1976-86 CJ WITH POWER STEERING	18006.01	5356104
1976-86 CJ WITH MANUAL STEERING	18006.02	5356106
1987-95 YJ WRANGLER WITH POWER STEERING	18006.03	52040112
1987-95 YJ WRANGLER WITH MANUAL STEERING	18006.04	52040110
1997-04 TJ WRANGLER WITH POWER STEERING	NEW 18006.05	52038337
1997-98 TJ WRANGLER WITH MANUAL STEERING	18006.06	52087883
1984-01 XJ CHEROKEE, WITH POWER STEERING	18006.08	52000615
1984-01 XJ CHEROKEE, WITH MANUAL STEERING	18006.07	52000616
1993-98 ZJ GRAND CHEROKEE	18006.09	52005285
1999-04 WJ GRAND CHEROKEE	NEW 18006.10	52088242
1987-06 WRANGLER W/ 4 INCH OR MORE LIFT, POWER STEERING	NEW 18006.50	
1976-86 CJ W/ 4 INCH LIFT, POWER STEERING	18006.51	



18006.30



18006.03



18006.51

Stock No.



18043.16

18043.17

KJ LIBERTY TIE ROD COMPONENTS:

2002-UP LIBERTY, TIE ROD END, RH	18043.16	5072444AA
2002-UP LIBERTY, TIE ROD END, LH	18043.17	5072445AA



INSTALLATION KIT
GRT4405



GRANT

STEERING WHEELS
AND ACCESSORIES

GRANT STEERING WHEELS:

CHALLENGER WHEEL 13.5", BLACK FOAM GRIP, 4 BLACK SPOKE	GRT414
CHALLENGER WHEEL 13.5", BLACK FOAM GRIP, 4 SILVER SPOKE	GRT415
CHALLENGER WHEEL 13.5", BLACK FOAM GRIP, 4 CHROME SPOKE	GRT440
CLASSIC SERIES WHEEL 14.5", BLACK GRIP, 3 STAINLESS STEEL SPOKE	GRT990
FORMULA GT WHEEL 14", BLACK VINYL GRIP, 3 SILVER SPOKE	GRT764
FORMULA GT WHEEL 14", BLACK VINYL GRIP, 3 BLACK SPOKE	GRT774
TOURING GT WHEEL 14", BLACK VINYL GRIP, 4 SILVER SPOKE	GRT769
TOURING GT WHEEL 14", BLACK VINYL GRIP, 4 BLACK SPOKE	GRT770
INSTALLATION KIT, 1976-95 CJ & YJ WRANGLER	GRT3196
INSTALLATION KIT, 1976-95 CJ & YJ WRANGLER (FORMULA & TOURING GT) BLACK	GRT5196
INSTALLATION KIT, 1976-95 CJ & YJ (FORMULA & TOURING GT) POLISHE	GRT5196-1
INSTALLATION KIT, 1955-63 CJ & 1967-75 CJ	GRT4405
SPECIAL INSTALLATION KIT, 1946-66 CJ	GRT4401
SPECIAL INSTALLATION KIT, 1963-73 SJ	GRT4403
STEERING WHEEL PULLER	GRT5891

Stock No.



HARD PARTS

Grant Products is the largest manufacturer of custom steering wheels in the USA. For over forty years, their focus has been to manufacture custom steering wheels that add personal style to any car or truck. Grant has always offered innovative products, fine quality, distinctive style, solid value and a wide selection of designs to express your individual personality

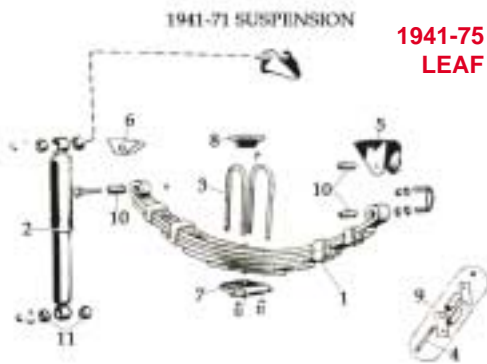

**1941-75 STOCK REPLACEMENT
LEAF SPRINGS, SHOCKS &
COMPONENTS:**

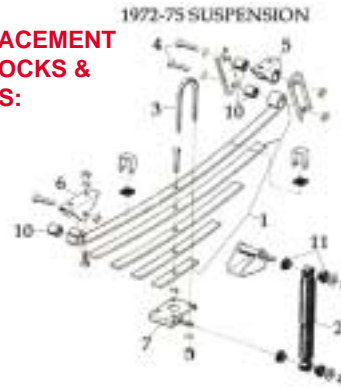

18270.12



18270.15



18270.16



SPRING BUSHING



18265.01



18270.10



18270.09



18270.05



18270.03



18270.01



18265.04

1	1941-53 MB, CJ2A, CJ3A CJ3B & 1948-63 226-WAGON 8 LAYER FRONT	18201.01	A-612
	1941-53 MB, CJ2A, CJ3A CJ3B & 1948-63 226-WAGON 10 LAYER FRONT	18201.02	926709
	1955-75 7-LAYER CJ5, CJ6 FRONT	18201.03	999529
	1955-75 10-LAYER CJ5, CJ6 FRONT	18201.04	999528
	1952-75 CJ5 FRONT, 5-LAYER LEAF SPRING ASSEMBLY	18201.05	97264 NEW
	1941-53 9-LAYER MB, CJ2A CJ3A, CJ3B REAR	18202.01	A-614
	1955-75 9-LAYER CJ5, CJ6 REAR	18202.02	916047
	1948-63 11-LAYER 226-TRUCK (475) REAR	18202.03	919692
	1948-63 9-LAYER 226-WAGON (475) REAR	18202.04	647609
	1955-75 CJ, LEAF SPRING ASSBLY. REAR 5 LEAF	18202.05	97369 NEW
2	1941-65 MB, CJ2A, CJ3A, CJ3B M38 MONROE-MATIC-PLUS GAS SHOCK FRONT OR REAR	18203.01	8133290
	1941-65 MB, CJ2A, CJ3A, CJ3B M38 GAS SHOCK, FRONT OR REAR	18203.02	20722
	1953-75 CJ5, CJ6, 4WD WAGON-TRUCK (1947-63) MONRO-MATIC-PLUS GAS SHOCK, FR	18203.01	8133290
	1953-75 CJ5, CJ6, 4WD WAGON TRUCK (1947-63) GAS SHOCK, FRONT	18203.02	20722
	1953-75 CJ5, CJ6 MONROE-MATIC-PLUS GAS SHOCK REAR	18203.04	8133295
	1953-75 CJ5, CJ6 GAS SHOCK, REAR	18203.05	20851
	1947-62 4WD 226 WAGON & TRUCK MONROE-MATIC-PLUS GAS SHOCK, REAR	18203.06	909680
	1947-54 2WD WAGON & (1948-51 2WD JEEPSTER)	18203.07	804407-PR
	MONROE-MATIC-PLUS SHOCK, PAIR		
	1947-71 REAR, ALL MODELS (EXCEPT M38 & M38A1) 4 REQUIRED, U-BOLT	18204.01	640933
3	1950-71 REAR, M38 & M38A1 4 REQUIRED, U-BOLT	18204.02	808462
	1941-71 FRONT, LARGE, ALL MODELS 1 REQUIRED U-BOLT	18204.03	808461
	1941-71 FRONT, SMALL, ALL MODELS 3 REQUIRED U-BOLT	18204.04	909222
	1947-63 TRUCK, REAR, 4 REQUIRED, U-BOLT	18204.05	910474
	1941-71 MODELS, LONG NUT FOR LEAF SRPING U-BOLTS	18204.10	339372 NEW
	1948-63 TRUCK, FRONT LARGE U-BOLT (NEED 1)	18204.11	644418 NEW
	1948-63 TRUCK, FRONT SMALL U-BOLT (NEED 3)	18204.12	644419 NEW
	1972-75 SPRING U-BOLT (2-9/16" ID)	18204.06	8130369
1972-75 SPRING U-BOLT (3-1/4" ID)	18204.07	8130370	
1972-86 SPRING U-BOLT (2-3/4" ID)	18204.08	999210	
4	1941-63 MB, CJ2A, 3A, 3B SPRING BOLT	18270.01	384228
	1960-75 CJ SPRING BOLT (UNTHREADED SHACKLES)	18270.02	809236

5	1941-68 MB, CJ, M38, M38A1 THREADED SHACKLE BRACKET, FRONT OR REAR	18270.03	A-544
	1955-75 CJ UNTHREADED SHACKLE BRACKET	18270.04	645966
6	1941-68 MB, CJ2A, 3A, 3B, M38, M38A1 PIVOT BRACKET	18270.05	A-500
	1955-72 CJ5 PIVOT BRACKET	18270.06	806910
7	1941-71 FRONT PASSENGER SIDE SPRING PLATE	18270.07	800823
	1941-71 FRONT DRIVER SIDE SPRING PLATE	18270.08	800821
	1941-71 REAR PASSENGER SIDE SPRING PLATE	18270.09	801736
	1941-71 REAR DRIVER SIDE SPRING PLATE	18270.10	801735
8	1941-75 RUBBER AXLE SNUBBER FRONT OR REAR	18270.11	945577
9	1941-65 MB, CJ2A, CJ3A, M38, CJ3B (LEFT HAND SHACKLE THREAD) SHACKLE KIT	18270.12	802061
	1941-65 MB, CJ2A, CJ3A, M38, CJ3B (RIGHT HAND SHACKLE THREAD) SHACKLE KIT	18270.13	802062
	1953-68 M381, RIGHT THREAD SHACKLE KIT	18270.14	928764
	1955-75 CJ3B, CJ5, CJ6 (UNTHREADED) SHACKLE KIT	18270.15	916646
	1955-75 CJ, HEAVY DUTY GREASABLE SHACKLE KIT	18270.16	916646HD
10	1941-53 MB, CJ2A, CJ3A, CJ3B FRONT LEAF SPRING FRONT EYE (BRONZE)	18270.17	359039
	1955-75 CJ5, CJ6, CJ3B, FRONT LEAF SPRING FRONT OR REAR EYE (RUBBER-STEEL)	18270.18	921055
	1950-68 M38, M38A1, FRONT LEAF SPRING FRONT OR REAR EYE (2 PER EYE)	18270.19	801624
	1945-63 MB, CJ2A, CJ3A, CJ3B REAR LEAF SPRING FRONT OR REAR EYE (BRONZE)	18270.17	359039
	1955-75 CJ5, CJ6, CJ3B REAR LEAF SPRING FRONT OR REAR EYE (RUBBER-STEEL)	18270.18	921055
1955-68 M38, M38A1, REAR SPRING FRONT EYE	18270.18	921055	
11	SHROCK GROMMET	18270.20	637936
	MB SUSPENSION PIVOT BOLT W/ NUT (TORQUE REACTION SPRING TO SHACKLE)	18270.24	A-6074 NEW
	MB SUSPENSION PIVOT BOLT W/ NUT (FRONT SPRING TO SHACKLE)	18270.25	A-6075 NEW

OMIX'S HEAVY DUTY SHACKLES:

1955-75 CJ HD FRONT OR REAR, PAIR, W/O BUSHINGS	18265.01	4007
1955-75 HD GREASABLE FRONT OR REAR, PAIR, W/O BUSHING	18265.02	4018
1955-75 HD GREASABLE FRONT OR REAR, PAIR, W/ BLACK POLYURETHANE BUSHING	18265.03	4018-25
1955-75 HD GREASABLE FRONT OR REAR, PAIR, W/ RED POLYURETHANE BUSHING	18265.04	4018-73

HARD PARTS

**1976-86 CJ
STOCK REPLACEMENT
LEAF SPRINGS,
SHOCKS &**

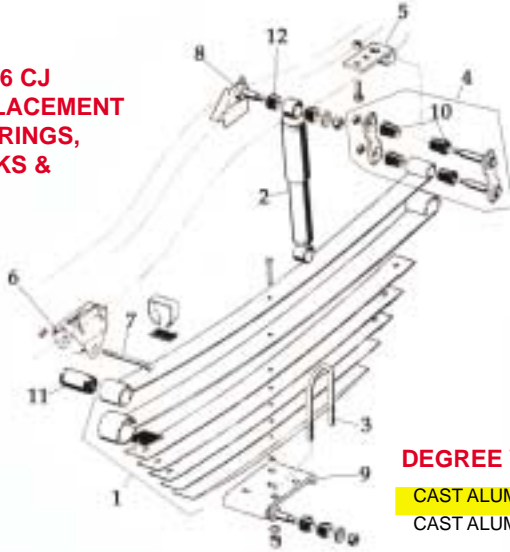

SHACKLE KIT



SHACKLE END
SPRING HANGER



18271.15
SPRING PLATE



SPRING BUSHINGS

DEGREE WEDGES:

CAST ALUMINUM, 6 DEGREE (FOR PINION ANGLE)	18206.01	MS-WSC60
CAST ALUMINUM, 8 DEGREE (FOR PINION ANGLE)	18206.02	MS-WSC80

ITEM# DESCRIPTION

Stock No. Replaces

1	1976-86 4 LAYER CJ5, CJ7, CJ8 FRONT	18201.10	5363229
1	1976-86 6 LAYER CJ5, CJ7, CJ8 FRONT	18201.11	5358939
1	1976-86 8 LAYER CJ5, CJ7, CJ8 FRONT	NEW 18201.12	5354892
1	1976-86 4 LAYER CJ5, CJ7, CJ8 REAR	18202.10	5356424
1	1976-86 6 LAYER CJ5, CJ7, CJ8 REAR	18202.11	5363331
1	1976-86 9 LAYER CJ5, CJ7, CJ8 REAR	18202.12	5356423
2	1976-81 MONRO-MATIC-PLUS GAS SHOCK, FRONT	18203.01	8133290
2	1976-81 GAS SHOCK, FRONT	18203.02	20722
2	1982-86 MONRO-MATIC PLUS GAS SHOCK, FRONT	18203.08	8134101
2	1982-86 GAS SHOCK, FRONT	18203.09	20708
2	1976-86 MONRO-MATIC-PLUS GAS SHOCK, REAR	18203.04	8133295
2	1976-86 GAS SHOCK, REAR	18203.05	20851
3	1976-86 SPRING U-BOLT (2-9/16" ID), REAR AMC-20, FRONT DANA-30 AXLES	18204.06	8130369
3	1976-86 SPRING U-BOLT (3-1/4" ID), FRONT DANA-30 AXLE (LARGE U-BOLT)	18204.07	8130370
3	1976-86 SPRING U-BOLT (2-3/4" ID), REAR DANA-44 AXLE	18204.08	999210
4	1976-86 CJ5, CJ7, CJ8 SHACKLE KIT WITH BUSHINGS, FRONT SPRING	18271.01	5357620K
4	1976-86 CJ5, CJ7, CJ8 SHACKLE KIT WITH BUSHINGS, REAR SPRING	18271.02	5357499K
5	1976-86 REAR SHACKLE END SPRING HANGER	18271.03	5355281
5	1976-86 FRONT SHACKLE END SPRING HANGER	18271.04	5355689
6	1976-86 FRONT OR REAR MAIN EYE SPRING HANGER	18271.05	8127712
7	1976-86 LEAFSPRING EYE BOLT (FRONT OR REAR)	NEW 18271.06	G4919209K
7A	1976-86 RUBBER AXLE SNUBBER (FRONT OR REAR)	18271.07	5355483
7B	1976-86 FRONT SWAY-BAR LINK W/BUSHING, LEFT OR RIGHT	18271.08	5364122
7C	1976-86 FRONT SWAY BAR BUSHING, 7/8"	18271.09	5361674
8	1976-81 FRONT SHOCK MOUNT BRACKET (WITH NARROW TRAC AXLES)	18271.10	8126587
9	1976-86 REAR LEAF SPRING MOUNT KIT (8 U-Bolts for both AMC-20 & DANA-44 incl)	18271.11	5359007K
9	1976-86 REAR DRIVER SIDE SPRING PLATE	18271.12	5359007
9	1976-86 FRONT LEAF SPRING MOUNT KIT	18271.13	5359011K
9	1976-86 REAR PASSENGER SIDE SPRING PLATE	18271.14	5359008
9	1976-86 FRONT DRIVER SIDE SPRING PLATE	18271.15	5359011
9	1976-86 FRONT PASSENGER SIDE SPRING PLATE	18271.16	5359012
10	1976-86 CJ5, CJ7, CJ8 FRONT LEAF SPRING FRONT EYE (2 PER EYE)	18271.17	5355966
11	1976-86 CJ5, CJ7, CJ8 FRONT LEAF SPRING REAR EYE (MAIN EYE)	18271.18	5353851
10	1976-86 CJ5, CJ7, CJ8 REAR LEAF SPRING FRONT EYE (MAIN EYE)	18271.19	52002551
11	1976-86 CJ5, CJ7, CJ8 REAR LEAF SPRING REAR EYE (2 PER EYE)	18271.20	5355841
12	SHOCK GROMMET (NEED 4 PER SHOCK)	18270.20	637936



18271.07



18271.08



18271.11



18271.13

OMIX'S HEAVY DUTY SHACKLES FOR 1976-86 CJ: (SOLD IN PAIRS)

	HD W/O BUSHINGS	HD GREASABLE W/O BUSHINGS	HD GREASABLE W/BLACK BUSHINGS	HD GREASABLE W/RED BUSHINGS
FRONT	18265.05 4008	18265.06 4019	18265.07 4019-25	18265.08 4019-73
REAR	18265.09 4009	18265.10 4021	18265.11 4021-25	18265.12 4021-73

HARD PARTS

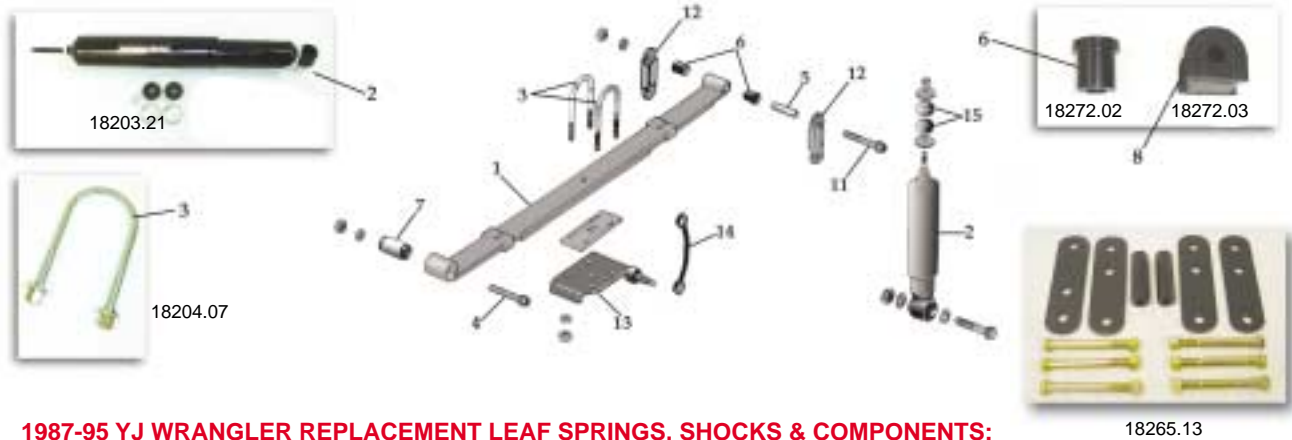

1987-95 YJ WRANGLER REPLACEMENT LEAF SPRINGS, SHOCKS & COMPONENTS:

ITEM #	DESCRIPTION	Stock No.	Replaces
	TRACK BAR, FRONT	18205.01	52040403
	TRACK BAR, REAR	18205.02	52040404
1	4 LAYER WRANGLER FRONT	18201.20	52003448
1	6 LAYER WRANGLER REAR	18202.22	52003449
1	5 LAYER WRANGLER REAR	18201.23	97565
2	MONRO-MATIC-PLUS GAS SHOCK, FRONT	18203.20	83502866
2	SENSA-TRAC HEAVY DUTY GAS SHOCK, FRONT	18203.21	83502836
2	MONRO-MATIC-PLUS GAS SHOCK, REAR	18203.22	83502867
2	SENSA-TRAC HEAVY DUTY GAS SHOCK, REAR	18203.23	83502837
3	SPRING U-BOLT W/ HARDWARE (2-9/16" ID) DANA-35 REAR, DANA-30 FRONT	18204.06	8130369
3	SPRING U-BOLT W/ HARDWARE (3-1/4" ID) DANA-30 FRONT	18204.07	8130370
3	SPRING U-BOLT W/ HARDWARE (2-3/4" ID) DANA-44 REAR	18204.08	999210
4	LEAFSPRING MAIN EYE BOLT (FRONT OR REAR)	NEW 18271.06	G9419209K
5	FRONT OR REAR BUSHING SPACER	18272.01	52002553
6	FRONT LEAF SPRING FRONT EYE (2 PER EYE)	18272.02	52002552
6	FRONT LEAF SPRING REAR EYE (MAIN EYE)	18271.19	52002551
7	REAR LEAF SPRING FRONT EYE (MAIN EYE)	18271.19	52002551
7	REAR LEAF SPRING REAR EYE (2 PER EYE)	18272.02	52002552
8	SWAYBAR CUSHION, FRONT SPRING	18272.03	52003143
9	AXLE SNUBBER, FRONT	18272.04	52040426
9	AXLE SNUBBER, REAR	18272.05	52040007
10	SPRING HANGER (MAIN EYE), FRONT OR REAR	18272.06	TBA
11	BOLT & NUT KIT FOR SPRING SHACKLE END, FRONT OR REAR	18272.07	TBA
12	SHACKLE SIDE PLATE, FRONT OR REAR (NEED TOTAL 8)	18272.08	52040415
13	SPRING PLATE, FRONT PASSENGER SIDE	18272.09	52040348
13	SPRING PLATE, FRONT DRIVER SIDE	18272.10	52040407
13	SPRING PLATE, REAR PASSENGER SIDE OR DRIVER SIDE	18272.11	52006421
14	SWAY BAR LINK, FRONT (INCLUDES BUSHINGS) RH=LH	18272.12	52002609
15	SHOCK GROMMET	18272.13	3216638



OMIX'S HEAVY DUTY SHACKLES FOR 1978-95 YJ WRANGLER.
 SHACKLES COME IN LEFT & RIGHT PAIR.
 (THESE SHACKLES WILL PROVIDE 1" LIFT TO YJ)

	HD W/O BUSHINGS	HD GREASABLE W/O BUSHINGS	HD GREASABLE W/BLACK BUSHINGS	HD GREASABLE W/RED BUSHINGS
FRONT	18265.13 4013	18265.14 4320	18265.15 4320-25	18265.16 4320-73
REAR	18265.17 4014	18265.18 4420	18265.19 4420-25	18265.20 4420-73



1997-06 TJ WRANGLER REPLACEMENT SHOCKS:

MONRO-MATIC-PLUS GAS SHOCK, FRONT	18203.30	4897567AA
SENSA-TRAC HEAVY DUTY GAS SHOCK, FRONT	18203.31	4886533AB
MONRO-MATIC-PLUS GAS SHOCK, REAR	18203.32	52087835AB
SENSA-TRAC HEAVY DUTY GAS SHOCK, REAR	18203.33	52088651AD
1997-UP TJ WRANGLER FRONT COIL SPRING EACH	NEW 18274.01	52060130AA
1997-UP TJ WRANGLER REAR COIL SPRING EACH	NEW 18274.02	52089103
1997-05 TJ REAR SUSPENSION UPPER CONTROL ARM	NEW 18282.04	52088520



DEGREE WEDGES:

	Stock No.
CAST ALUMINUM, 6 DEGREE (FOR PINION ANGLE)	18206.01
CAST ALUMINUM, 8 DEGREE (FOR PINION ANGLE)	18206.02
1997-06 TJ HEAVY DUTY FRONT LOWER CONTROL ARM AXLE MOUNT PAIR	18723.01 NEW



1984-01 XJ CHEROKEE

REPLACEMENT SUSPENSION COMPONENTS:

1984-90 MONRO-MATIC-PLUS GAS SHOCK, FRONT	18203.50	83500314
1991-01 MONRO-MATIC-PLUS GAS SHOCK, FRONT	18203.51	4637525
1984-01 MONRO-MATIC PLUS GAS SHOCK, REAR	18203.52	4637523
1984-01 SHOCK GROMMET	18272.13	3216638
1994-90 FRONT UPPER ARM (INCLUDES BUSHING)	18280.01	52087710
1991-01 FRONT UPPER ARM (INCLUDES BUSHING)	18280.02	52087710
1984-90 FRONT OR REAR BUSHING FOR FRONT UPPER ARM	18280.03	52000211
1991-01 FRONT OR REAR BUSHING FOR FRONT UPPER ARM	18280.04	52038025
1984-01 FRONT LOWER ARM (INCLUDES BUSHING)	18280.05	52001162
1984-01 FRONT OR REAR BUSHING FOR FRONT LOWER ARM	18280.06	52001161
1984-01 REAR LEAF SPRING FRONT EYE BUSHING	18280.07	52000503
1984-01 REAR LEAF SPRING REAR EYE BUSHING	18280.08	52000504
1984-01 REAR AXLE BUMPER	18280.09	52002393
1984-01 REAR SPRING SWAY BAR CUSHION	18280.10	52001145
1991-01 SWAY BAR LINK	18280.11	52037849
1984-01 SWAY BAR LINK BUSHING	18280.12	52001132
1984-90 FRONT TRACK BAR (WITH BUSHING)	18205.03	52003918
1991-01 FRONT TRACK BAR (WITH BUSHING)	18205.04	52007118
1984-01 FRONT COIL SPRING (EACH) LIGHT DUTY	18280.13	52001122
1984-89 BUSHING STABILIZER, ORANGE	18280.14	52001144
1984-89 BUSHING STABILIZER, BROWN	18280.15	52003232
1984-01 ISOLATOR, FRONT	18280.16	52000229
1984-01 REAR LEAF SPRING, HEAVY DUTY	18280.17	52000545
1994-01 FRONT CUSHION	18280.18	52004295
1984-01 BUSHING SWAY BAR	18280.10	52001145

SUSPENSION BUSHINGS: (CLEVITE BRAND)

1984-90 XJ FRONT OR REAR BUSHING FOR FRONT UPPER ARM	18207.01	52000211-CL
1984-01 XJ FRONT OR REAR BUSHING FOR FRONT LOWER ARM	18207.02	52001161-CL
1991-01 XJ FRONT OR REAR BUSHING FOR FRONT UPPER ARM	18207.03	52038025-CL
1993-98 ZJ FRONT BUSHING FOR FRONT LOWER ARM	18207.04	52037830-CL
1993-98 ZJ FRONT OR REAR BUSHING FOR REAR UPPER ARM	18207.05	52038020-CL
1993-98 ZJ FRONT OR REAR BUSHING FOR REAR LOWER ARM	18207.06	52038026-CL
1993-98 ZJ REAR BUSHING FOR FRONT LOWER ARM	18207.07	52087720-CL

MISC. SUSPENSION PARTS:

1973-74 DJ5C POSTAL, KING BOLT SET (HALF SET FOR ONE SIDE)	18284.01	5550237
1978-91 DJ POSTAL SPRING BUSHING	18284.02	944870
1978-91 SJ WAGONEER SPRING BUSHING	18284.03	5352079
1978-91 SJ WAGONEER SPRING BUSHING	18284.04	5358985

1993-98 ZJ GRAND CHEROKEE REPLACEMENT SUSPENSION COMPONENTS:

MONRO-MATIC-PLUS GAS SHOCK (MODLES W/O UP COUNTRY OPTION) FRONT SPECIAL SHOCK PAIR (MODLES WITH UP COUNTRY OPTION) FRONT	18203.60	52089057
MONRO-MATIC-PLUS GAS SHOCK (MODLES WITH UP COUNTRY OPTION) REAR SPECIAL SHOCK PAIR (MODLES WITH UP COUNTRY OPTION) REAR	18203.61	4741675-PR
MONRO-MATIC-PLUS GAS SHOCK (MODLES WITH UP COUNTRY OPTION) REAR SPECIAL SHOCK PAIR (MODLES WITH UP COUNTRY OPTION) REAR	18203.62	4723036
MONRO-MATIC-PLUS GAS SHOCK (MODLES WITH UP COUNTRY OPTION) REAR SPECIAL SHOCK PAIR (MODLES WITH UP COUNTRY OPTION) REAR	18203.63	4741676-PR
1993-98 FRONT UPPER ARM (INCLUDES BUSHING)	18280.02	52087710
1993-98 FRONT OR REAR BUSHING FOR FRONT UPPER ARM	18282.01	52087709
1993-98 FRONT LOWER ARM (INCLUDES BUSHING)	18280.05	52001162
1993-98 FRONT BUSHING FOR FRONT LOWER ARM	18282.02	52037830
1993-98 REAR BUSHING FOR FRONT LOWER ARM	18282.03	52087720
1993-98 REAR UPPER ARM (INCLUDES BUSHING)	18282.04	52088520 NEW
1993-98 FRONT OR REAR BUSHING FOR REAR UPPER ARM	18282.05	52038020
1993-98 REAR LOWER ARM (INCLUDES BUSHING)	18282.06	52088521 NEW
1993-98 FRONT OR REAR BUSHING FOR REAR LOWER ARM	18282.07	52038026
1993-96 FRONT SWAY BAR LINK	18280.11	52037849
1997-98 FRONT SWAY BAR LINK	18282.08	52088437
1993-98 FRONT SWAY BAR LINK GROMMET	18280.12	52001132
1993-98 FRONT TRACK BAR	18205.04	52007118
1994-98 FRONT COIL SPRING, HEAVY DUTY	18282.10	52088104
1993-98 REAR COIL SPRING	18282.11	52089143 NEW

1999-04 WJ GRAND CHEROKEE REPLACEMENT SHOCK ABSORBERS:

MONRO-MATIC-PLUS SHOCK (MODELS W. OUT UP COUNTRY OPTION), FRONT	18203.67	5014730AA
MONRO-MATIC-PLUS SHOCK (MODELS W/OUT UP COUNTRY OPTION), REAR	18203.68	52088221
TRACK BAR	18205.06	52088305AB NEW
FRONT COIL SPRING	18283.01	52088262 NEW
REAR COIL SPRING	18283.02	52088343 NEW
FRONT STABILIZER LINK	18283.03	52088283 NEW
REAR STABILIZER LINK	18233.04	52088319AB NEW
BUSHING REAR UPPER CONTROL ARM	18283.05	52088425 NEW
BUSHING FRONT OR REAR LOWER BUSHING, FRONT UPPER ARM	18283.06	52088220 NEW
BUSHING, FRONT UPPER ARM	18283.07	52088214 NEW

2002-05 KJ LIBERTY

2002-05 KJ LIBERTY, FRONT CONTROL ARM (WITH BUSHING & BALL JOINT)	52088632AB
2002-06 KJ LIBERTY, BUSHING REAR UPPER CONTROL ARM	52088425

HARD PARTS

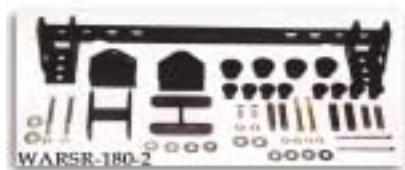

WARRIOR SHACKLE REVERSAL SYSTEMS:

DESCRIPTION	Stock No.
1955-75 CJ	WARSR-180-1
1976-86 CJ5, CJ7	WARSR-180-2
1987-95 WRANGLER	WARSR-180-3

WARRIOR SWAYBAR DISCONNECTS:

1976-86 CJ7, STOCK HEIGHT, PAIR	WAR83011
1976-86 CJ7, 2" LIFT, PAIR	WAR83021
1976-86 CJ7, 4" LIFT, PAIR	WAR83031
1987-95 YJ WRANGLER, STOCK HEIGHT, PAIR	WAR83021
1987-95 YJ WRANGLER, 2" LIFT, PAIR	WAR83031
1987-95 YJ WRANGLER, 4" LIFT, PAIR	WAR83041
1997-03 TJ WRANGLER, STOCK HEIGHT, PAIR	WAR83061
1997-03 TJ WRANGLER, 2" LIFT, PAIR	WAR83071
1997-03 TJ WRANGLER, 4" LIFT, PAIR	WAR83081

WARRIOR SHACKLE KITS (PAIR, W/O BUSHINGS):

1976-86 CJ FRONT, 2" LIFT, HAMMER TONE GREY	WAR113
1976-86 CJ FRONT, 2" LIFT, GOLD ZINC	WAR313
1976-86 CJ REAR, 2" REAR, HAMMER TONE GREY	WAR114
1976-86 CJ REAR, 2" REAR, GOLD ZINC	WAR314
1987-95 WRANGLER FRONT, 1-1/4" LIFT, GOLD ZINC	WAR314
1987-95 WRANGLER REAR, 1-1/4" LIFT, HAMMER TONE GREY	WAR123
1987-95 WRANGLER REAR, 1-1/4" LIFT, GOLD ZINC	WAR323
1987-95 YJ WRANGLER REAR, 1/2" LIFT, GOLD ZINC	WAR350



WAR114

WAR314

WARRIOR GREASABLE SHACKLE KITS (PAIR, W/ BUSHINGS):

1976-86 CJ FRONT, 1-1/2" LIFT, GOLD ZINC FINISH	WAR13122
1976-86 CJ REAR, 1-1/2" LIFT, GOLD ZINC FINISH	WAR17152
1987-95 WRANGLER, FRONT, 1-1/4" LIFT, GOLD ZINC FINISH	WAR13142
1987-95 WRANGLER, REAR, 1-1/4" LIFT, GOLD ZINC FINISH	WAR13232



WARRIOR U-BOLT SKID PLATES:

1976-81 CJ FRONT, W/O FACTORY FRONT SWAY	WAR1715
1976-81 CJ FRONT, W/ FACTORY FRONT SWAY	WAR1730
1982-86 CJ FRONT W/ FACTORY FRONT SWAY	WAR1740
1987-95 WRANGLER FRONT	WAR1745
1976-86 CJ REAR (EXCEPT CJ WITH REAR DANA-44)	WAR1725
1987-95 WRANGLER REAR	WAR1750



WARRIOR TORQUE BAR SYSTEMS:

1976-86 CJ	WAR601
1976-86 CJ, SPRING OVER	WAR602
1987-95 WRANGLER	WAR603
1987-95 WRANGLER W/ LIFT KIT	WAR603A
1987-95 WRANGLER, SPRING OVER	WAR607



WARRIOR MISC. SUSPENSION PARTS:

UNIVERSAL SHOCK MOUNT, PAIR	WAR101
UNIVERSAL SPRING PERCH PAIR, 1-1/2" LEAF SPRING	WAR175
UNIVERSAL SPRING PERCH PAIR, 2" LEAF SPRING	WAR200
UNIVERSAL SPRING PERCH PAIR, 2 1/2" LEAF SPRING	WAR250
UNIVERSAL SPRING PERCH PAIR, 3" LEAF SPRING	WAR300



HARD PARTS



1-2003



1-1001



1-1002



1-1005



1-1003

COMPLETE POLYURETHANE KIT

(includes all

major suspension points for steel bodied models.
not for fiberglass bodies):

DESCRIPTION	RED	BLACK
1955-75 CJ	1-2001	1-2001BL
1976-79 CJ5, CJ7	1-2002	1-2002BL
1980-86 CJ5, CJ7	1-2003	1-2003BL
1987-95 YJ WRANGLER	1-2005	1-2005BL
1997-03 TJ WRANGLER	1-2006	1-2006BL
1984-01 XJ CHEROKEE	1-2004	1-2004BL

FRONT SPRING & SHACKLE BUSHING KITS:

DESCRIPTION	RED	BLACK
1955-75 CJ	1-1001	1-1001BL
1976-86 CJ	1-1002	1-1002BL
1987-95 WRANGLER	1-1005	1-1005BL

REAR SPRING & SHACKLE BUSHING KITS:

DESCRIPTION	RED	BLACK
1955-75 CJ	1-1001	1-1001BL
1976-86 CJ	1-1003	1-1003BL
1987-95 YJ WRANGLER	1-1005	1-1005BL
1984-01 XJ CHEROKEE	1-1007	1-1007BL



1-801

SHACKLE BUSHING KITS:

DESCRIPTION	RED	BLACK
1955-75 CJ, FRONT OR REAR (NEED 2)	1-805	1-805BL
1976-86 CJ FRONT	1-801	1-801BL
1976-86 CJ REAR	1-802	1-802BL
1987-95 WRANGLER, FRONT OR REAR (NEED 2)	1-803	1-803BL
1984-01 XJ CHEROKEE	1-804	1-804BL

SWAYBAR BUSHING KITS:

DESCRIPTION	RED	BLACK
1976-86 CJ WITH 15/16" DIAMETER BAR, FRONT	1-1101	1-1101BL
1976-86 CJ WITH 7/8" DIAMETER BAR, FRONT	1-1110	1-1110BL
1987-95 YJ WRANGLER WITH 1 1/8" DIAMETER BAR, FRONT	1-1107	1-1107BL
1987-95 YJ WRANGLER WITH 15/16" DIAMETER BAR, FRONT	1-1102	1-1102BL
1997-03 TJ WRANGLER WITH 30.5 mm DIAMETER BAR, FRONT	1-1111	1-1111BL
1997-03 WRANGLER WITH 13mm DIAMETER BAR, REAR	1-1112	1-1112BL
1984-01 XJ CHEROKEE, 1993-98 ZJ GRAND-CHEROKEE 24mm, FRONT	1-1103	1-1103BL
1984-01 XJ CHEROKEE, 1993-98 ZJ GRAND-CHEROKEE 25mm, FRONT	1-1104	1-1104BL
1984-01 XJ CHEROKEE, 1993-98 ZJ GRAND-CHEROKEE 28mm, FRONT	1-1105	1-1105BL
1984-01 XJ CHEROKEE, 1993-98 ZJ GRAND-CHEROKEE 23mm, FRONT	1-1106	1-1106BL
1984-01 XJ CHEROKEE, 1993-98 ZJ GRAND-CHEROKEE 1", FRONT	1-1108	1-1108BL
1984-01 XJ CHEROKEE, 1993-98 ZJ GRAND-CHEROKEE 7/8", FRONT	1-1115	1-1115BL
1984-01 XJ CHEROKEE, 1993-98 ZJ GRAND-CHEROKEE 15/16", FRONT	1-1116	1-1116BL
1984-01 XJ CHEROKEE, 1993-98 ZJ GRAND-CHEROKEE 1-1/8", FRONT	1-1117	1-1117BL
1984-01 XJ CHEROKEE, 5/8" BAR, REAR	1-1118	1-1118BL
1993-98 ZJ GRAND-CHEROKEE, REAR	1-1109	1-1109BL



1-1107



TRACK ARM BUSHING KITS:

DESCRIPTION	RED	BLACK
1987-95 WRANGLER, FRONT OR REAR (NEED 2)	1-1202	1-1202BL
1997-99 WRANGLER, FRONT	1-1205	1-1205BL
1997-03 WRANGLER, REAR	1-1206	1-1206BL
1984-01 XJ CHEROKEE, FRONT	1-1203	1-1203BL
1993-98 ZJ GRAND-CHEROKEE, FRONT	1-1203	1-1203BL
1993-98 ZJ GRAND-CHEROKEE, REAR	1-1204	1-1204BL



CONTROL ARM BUSHING KITS:

1997-03 TJ WRANGLER, UPPER & LOWER, FRONT	1-204	1-204BL
1984-01 XJ CHEROKEE, FRONT	1-202	1-202BL
1993-98 ZJ GRAND-CHEROKEE, FRONT	1-203	1-203BL
1993-98 ZJ GRAND-CHEROKEE, REAR	1-301	1-301BL



TJ WRANGLER COIL SPRING PADS:

1997-03 TJ WRANGLER, PAIR	1-1701	1-1701BL
---------------------------	--------	----------

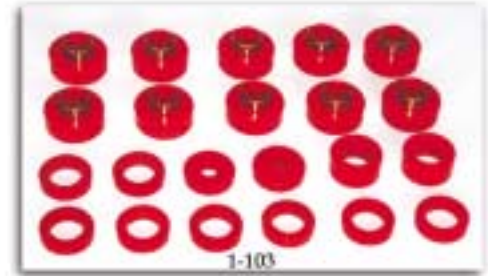

BODY MOUNT BUSHING SETS:

1955-73 CJ (14 PCS)	1-101	1-101BL
1974-75 CJ (18 PCS)	1-109	1-109BL
1976-79 CJ5, CJ7 (22 PCS)	1-102	1-102BL
1980-86 CJ5, CJ7 (22 PCS)	1-103	1-103BL
1981-86 CJ8 (26 PCS)	1-104	1-104BL
1987-95 YJ WRANGLER (22 PCS)	1-105	1-105BL
1997-03 TJ WRANGLER (22 PCS)	1-107	1-107BL



MISC. POLYURETHANE ITEMS:

DESCRIPTION	RED	BLACK
1976-95 CJ & WRANGLER AXLE SNUBBER PAIR	1-1301	1-1301BL
1976-86 CJ 6 CYL COMPLETE DRIVE TRAIN KIT	1-1901	1-1901BL
1945-95 CJ & WRANGLER, TIE ROD BOOTS	19-1712	19-1712BL
1972-86 CJ 6 CYL ENGINE MOUNT PAIR	1-501	1-501BL
1987-03 WRANGLER & XJ CHEROKEE 6-CYL ENGINE MOUNT PAIR	1-502	1-502BL
1967-92 V8 AMC ENGINE MOUNT PAIR	1-503	1-503BL
1973-95 CJ & YJ WRANGLER TRANS. MOUNT	7-1604	7-1604BL
1997-03 TJ WRANGLER TRANS. MOUNT	1-1601	1-1601BL
1973-95 CJ & YJ WRANGLER TRANS. TORQUE ARM BUSHING PAIR	1-1201	1-1201BL



BODY LIFT KIT
18303.10

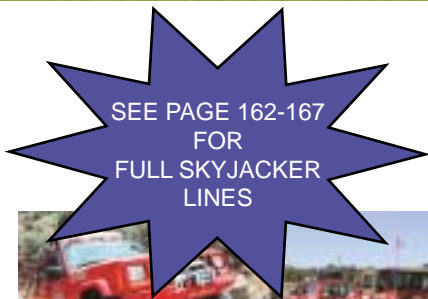

SKYJACKER®
THE BEAR OF SUSPENSIONS



ROCK READY Lift Kits for 97-02 TJ Wrangler



Wanna be a rock star? Skyjacker's RockReady lift kits for Wranglers are designed to provide maximum articulation and unparalleled traction on rocky terrain. These extreme kits come with everything you need to turn your daily driver into a serious rock crawler.



8" ROCK READY System breakdown

- New front & rear coils
- Unique front axle differential cradle
- Integrated 2-piece sub-frame assembly
- Lower D.O.M flex links are 80% longer than stock which dramatically reduce link angle during articulation therefore allowing no more than 1.5 degrees of caster change through suspension cycle.
- Upper D.O.M flex links are longer with 3-piece teflon lined spherical rod ends
- Adjustable flex front track bar
- Adjustable flex rear track bar (optional in 6" and 4")
- Double disconnect front sway bar end links
- Dropped pitman arm
- D.O.T. approved extended front and rear stainless steel braided, polyurethane coated brake lines
- Heavy duty steering stabilizer
- Four SoftRide Hydro or Nitro shocks
- Available for aftermarket Dana 44 or Ford 9" front dif-



SYSTEM BREAKDOWN:

- Four Monolinear springs
- Front extended, greaseable tow bar shackles
- Rear extended, greaseable boomerang shackles
- New extended front track bar
- Double disconnect extended sway bar end links
- Drop pitman arm
- D.O.T. approved stainless steel braided brake lines
- Four SoftRide Nitro shocks



6" Rock Ready Monolinear Spring Lift for YJ

- with Power Steeing & Nitro shocks
- with Manual Steeing & Nitro shocks

SJ-YJ60MKN
SJ-YJ65MKN



10" RockReady Lift Kits for TJ Wrangler

Stock No.

- with Hydro shocks for TJ with Fr Dana-30 SJ-TJ1001K-DX
- with Nitro shocks for TJ with Fr Dana-30 SJ-TJ1001KN-DX
- with Hydro shocks for TJ with Fr Dana-44 or Ford 9" SJ-TJ1041K-DX
- with Nitro shocks for TJ with Fr Dana-44 or Ford 9" SJ-TJ1041KN-DX

8" RockReady Lift Kits for TJ Wrangler

- with Hydro shocks for TJ with Fr Dana-30 SJ-TJ801K-DX
- with Nitro shocks for TJ with Fr Dana-30 SJ-TJ801KN-DX
- with Hydro shocks for TJ with Fr Dana-44 or Ford 9" SJ-TJ841K-DX
- with Nitro shocks for TJ with Fr Dana-44 or Ford 9" SJ-TJ841KN-DX

6" RockReady Lift Kits for TJ Wrangler

- with Hydro shocks for TJ with Fr Dana-30 SJ-TJ601K-DX
- with Nitro shocks for TJ with Fr Dana-30 SJ-TJ601KN-DX
- with Hydro shocks for TJ with Fr Dana-44 or Ford 9" SJ-TJ641K-DX
- with Nitro shocks for TJ with Fr Dana-44 or Ford 9" SJ-TJ641KN-DX

4" RockReady Long-Arm Lift Kits for TJ Wrangler

- with Hydro shocks SJ-TJ40RRK-DX
- with Nitro shocks SJ-TJ40RRKN-DX

Give your YJ Wrangler a little altitude w the 6" Monolinear lift from Skyjacker. TI bolt-on kit allows the use of 35" tires an is designed with maximum articulation in mind for off-road traction. May not be suitable for V8's or high HP engines.



6" Monolinear Lift Kit 87-95 YJ Wrangler

HARD PARTS

LIFT KITS W / OUT SHOCKS: Replaces Part No.

2003-UP TJ WRANGLER & RUBICON 2.5" STANDARD KIT	SJ-TJ253K
2003-UP TJ WRANGLER & RUBICON 2.5" VALUE FLEX KIT	SJ-TJ253K-SVX
2003-UP WRANGLER & RUBICON 4" STANDARD KIT	SJ-TJ403K

**2.5 AND 4" LIFT KITS:
FOR 1997-02 TJ WRANGLER**

Skyjacker offers flexibility in more ways than one. The Standard 2.5" and 4" lifts come with everything you need to lift you Wrangler properly. The FLEX series comes in 2 different versions: single flex and double flex. That allows you to decide the median point between ride quality and off-road ability. If that wasn't a hard enough decision, check out the VALUE FLEX series that includes a steering box skid plate!



STANDARD

STANDARD LIFT FOR TJ WRANGLER

2.5" with Hydro shocks for TJ	SJ-TJ251K
2.5" with Nitro shocks for TJ	SJ-TJ251KN
4" with Hydro shocks for TJ	SJ-TJ401K
4" with Nitro shocks for TJ	SJ-TJ401KN

VALUEFLEX LIFT FOR TJ WRANGLER

2.5" with Hydro Shocks	SJ-TJ251K-VX
2.5" with Nitro Shocks	SJ-TJ251KN-VX
4" with Hydro Shocks	SJ-TJ401K-VX
4" with Nitro Shocks	SJ-TJ401KN-VX

SINGLE FLEX LIFT FOR TJ WRANGLER

2.5" with Hydro shocks for TJ	SJ-TJ251K-SX
2.5" with Nitro shocks for TJ	SJ-TJ251KN-SX
4" with Hydro shocks for TJ	SJ-TJ401K-SX
4" with Nitro shocks for TJ	SJ-TJ401KN-SX

DOUBLE FLEX LIFT FOR TJ WRANGLER

2.5" with Hydro shocks for TJ	SJ-TJ251K-DX
2.5" with Nitro shocks for TJ	SJ-TJ251KN-DX
4" with Hydro shocks for TJ	SJ-TJ401K-DX
4" with Nitro shocks for TJ	SJ-TJ401KN-DX



- Kit Includes:
- Front and rear coil springs
 - Four standard lower links
 - Rear track bar relocating bracket
 - Tubular transfer case lowering kit
 - Bump stop extensions
 - Four SOFTRIDE Nitro or Hydro shocks



- Kit Includes:
- Front and rear coil springs
 - Four standard lower links
 - Double disconnect front sway bar end links
 - Rear extended sway bar end links
 - Tubular transfer case lowering kit
 - Dropped pitman arm
 - Four SOFTRIDE Nitro or Hydro shocks



- Kit Includes:
- Front and rear coil springs
 - Four single Flex lower links
 - Double disconnect front sway bar end links
 - Rear extended sway bar end links
 - Tubular transfer case lowering kit
 - Steering box skid plate
 - Bump stop extensions
 - Polyurethane tie rod boots (4 per kit)
 - Four SOFTRIDE Nitro or Hydro shocks



- Kit Includes:
- Front and rear coil springs
 - Four single Flex lower links
 - Double disconnect front sway bar end links
 - Rear extended sway bar end links
 - Tubular transfer case lowering kit
 - Steering box skid plate
 - Dropped pitman arm
 - Rear Track bar relocation bracket
 - Poly bump stops
 - Polyurethane tie rod boots (4 per kit)
 - Four SOFTRIDE Nitro or Hydro shocks

TüV Approved

DOUBLE FLEX



- Kit Includes:
- Front and rear coil springs
 - Upper and lower double flex links
 - Double disconnect front sway bar end links
 - Rear extended sway bar end links
 - Tubular transfer case lowering kit
 - Bump stop extensions
 - Rear track bar relocating bracket
 - Four SOFTRIDE Nitro or Hydro shocks



- Kit Includes:
- Front and rear coil springs
 - Upper and lower single flex links
 - Adjustable front Flex track bar
 - Double disconnect front sway bar end links
 - Rear extended sway bar end links
 - Rear track bar relocating bracket
 - Tubular transfer case lowering kit
 - Dropped pitman arm
 - Four SOFTRIDE Nitro or Hydro shocks

TüV Approved



SINGLE FLEX



- Kit Includes:
- Front and rear coil springs
 - Upper and lower single flex links
 - Double disconnect front sway bar end links
 - Rear extended sway bar end links
 - Rear track bar relocating bracket
 - Tubular transfer case lowering kit
 - Bump stop extensions
 - Four SOFTRIDE Nitro or Hydro shocks



- Kit Includes:
- Front and rear coil springs
 - Upper and lower single flex links
 - Adjustable front Flex track bar
 - Double disconnect front sway bar end links
 - Rear extended sway bar end links
 - Tubular transfer case lowering kit
 - Dropped pitman arm
 - Four SOFTRIDE Nitro or Hydro shocks

TüV Approved



HARD PARTS

LIFT KITS FOR 1955-86 CJ'S

Skyjacker revolutionized the lift kit industry with their SOFTRIDE® technology. The SOFTRIDE® springs provide excellent off-road performance while offering better than stock ride quality. CJ lift kits come with new springs and U-bolts. Some options may be required for proper fitment of kit. Shocks sold separately. NOTE: Actual lift height may vary according to vehicle modifications and weight.

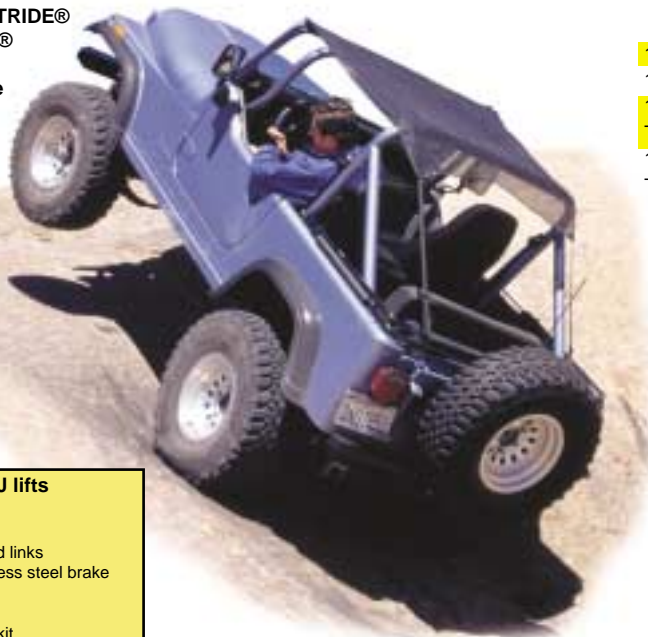

LIFT KITS FOR CJ'S	Stock No.
1955-75 CJ5, CJ6 2" LIFT	SJ-J32K
1955-75 CJ5, CJ6 4" LIFT	SJ-J34K
1976-86 CJ5, CJ7, CJ8 2" LIFT	SJ-J20K
TüV Approved	
1976-86 CJ5, CJ7, CJ8 4" LIFT	SJ-J40K
TüV Approved	



Shocks sold separately

Optional equipment for CJ lifts

- Four Hydro or Nitro shocks
- Dropped pitman arm (4" only)
- Double disconnect swaybar end links
- Extended DOT approved stainless steel brake lines
- Steering stabilizer
- Tubular transfer case lowering kit

J20K 2" & J40K 4" SYSTEM FEATURES

- Front and rear multileaf springs
- Front and rear E-coated U-bolts

LIFT KITS FOR 1987-95 YJ WRANGLERS

Skyjacker's revolutionary SOFTRIDE® spring technology provide excellent off-road performance while offering better than stock ride quality. YJ lift kits come with new springs, U-bolts and track bar relocation brackets. U-bolts are for Model 30 and Model 35 axles only. U-bolts for other axles are available separately. Some options may be required for proper fitment of lift kit. Shocks sold separately. NOTE: Actual lift height may vary according to vehicle modifications and weight.

YJ20K 2" & YJ40K 4" SYSTEM FEATURES:

- Front and rear multileaf springs
- Front and rear E-coated U-bolts
- Front and rear track bar brackets

TüV Approved

LIFT KITS FOR YJ WRANGLERS

2" LIFT KIT	YJ20K
4" LIFT KIT	YJ40K

Optional equipment for YJ lifts

- Four Hydro or Nitro shocks
- Dropped pitman arm (4" only)
- Double disconnect swaybar end links
- Extended DOT approved stainless steel brake lines
- Steering stabilizer
- Tubular transfer case lowering kit
- Heavy Duty 1.250" D.O.M. swedged drag link tube



own with optional equipment

HARD PARTS

2" SPACER LIFT KITS

97-02 TJ WRANGLER	Stock No.
without Shocks	SJ-TJ20
with Hydro Shocks	SJ-TJ20K
with Nitro Shocks	SJ-TJ20KN

93-98 ZJ GRAND CHEROKEE	Stock No.
without Shocks	SJ-ZJ20
with Hydro Shocks	SJ-ZJ20K
with Nitro Shocks	SJ-ZJ20KN

84-01 XJ CHEROKEE	Stock No.
without Shocks	SJ-XJ20
with Hydro Shocks	SJ-XJ20K
with Nitro Shocks	SJ-XJ20KN

99-04 WJ GRAND CHEROKEE	Stock No.
without Shocks	SJ-WJ20
with Hydro Shocks	SJ-WJ20K
with Nitro Shocks	SJ-WJ20KN

3" LIFT KITS FOR 1984-01 XJ CHEROKEE



The 1984-01 XJ Cherokee is fast becoming a popular choice for off-roaders everywhere. Multi-link front coil suspension and solid axles allow it to tackle

even the most severe obstacles. Skyjacker has addressed this demand with 3 suspension lifts. These 3" lifts give the little Cherokee a whole new look and provide enough room for 31" tires. NOTE: Kits include full length add-a-leafs; Systems include full height, 2-stage SOFTRIDE® rear springs.

TüV Approved

3" STANDARD LIFT FOR XJ CHEROKEE



KIT PART NO.

SYSTEM PART NO.

with Hydro shocks	SJ-JC301K	SJ-JC301KS
with Nitro shocks	SJ-JC301KN	SJ-JC301KSN

3" SINGLE FLEX LIFT FOR XJ CHEROKEE



with Hydro shocks	SJ-JC301K-SX	SJ-JC301KS-SX
with Nitro shocks	SJ-JC301KN-SX	SJ-JC301KSN-SX

3" DOUBLE FLEX LIFT FOR XJ CHEROKEE



with Hydro shocks	SJ-JC301K-DX	SJ-JC301KS-DX
with Nitro shocks	SJ-JC301KN-DX	SJ-JC301KSN-DX

SJ-JC301KS

- Standard kit includes:
- 3" Full length coil springs
 - 2-stage SOFTRIDE rear springs or rear add-a-leafs
 - Front track bar relocation bracket
 - Standard lower links
 - Four Nitro or Hydro shocks



SJ-JC301KS-SX

- Single Flex kit includes:
- 3" full length front coil springs
 - SOFTRIDE rear springs or add-a-leafs
 - Adjustable Flex front track bar
 - Upper FLEX links
 - Lower Single FLEX links
 - Double disconnect swaybar end links
 - Heavy duty steering stabilizer
 - Four Nitro or Hydro shocks



SJ-JC301KS-DX

- Double Flex kit includes:
- 3" full length front coil springs
 - SOFTRIDE rear springs or add-a-leafs
 - Adjustable Flex front track bar
 - Upper FLEX links
 - Lower double FLEX links
 - Double disconnect swaybar end links
 - Heavy duty steering stabilizer
 - Four Nitro or Hydro shocks



3" LIFT KITS FOR 1993-98 ZJ GRAND CHEROKEE

SJ-GC301KN

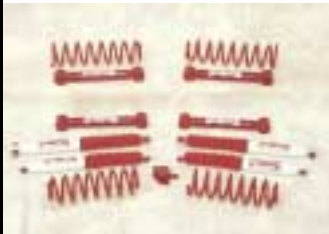

- Standard kit includes:
- Front and rear coil springs
 - Four standard lower links
 - Front track bar relocation bracket
 - Four Nitro or Hydro Shocks

SJ-GC301KN-SX

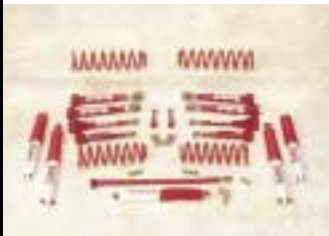

- Single Flex kit includes:
- Front and rear coil springs
 - Upper and lower single flex links
 - Double disconnect front swaybar end links
 - Adjustable front Flex track bar
 - Four Nitro or Hydro shocks

SJ-GC301KN-DX

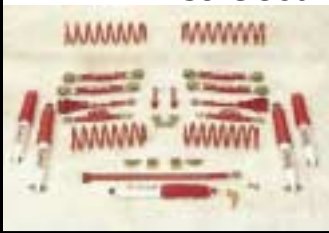

- Double Flex kit includes:
- Front and rear coil springs
 - Upper and lower double flex links
 - Double disconnect front swaybar end links
 - Adjustable front Flex track bar
 - Four Nitro or Hydro shocks

Just because they bought a grocery getter doesn't mean Grand Cherokee owners can't join in on all the off-road fun. What most don't know is the ZJ's coil suspension offers great potential as a serious off-road machine. Skyjacker's well engineered 3" lift kits allow the use of 31" tires and offer excellent off-road capabilities. They come with everything you need to get your ZJ up and you out on the trail.



TüV Approved

STANDARD LIFT FOR 93-98 GRAND CHEROKEE (ZJ)

		Stock No.
with Hydro shocks		SJ-GC301K
with Nitro shocks		SJ-GC301KN

SINGLE FLEX LIFT FOR 93-98 GRAND CHEROKEE (ZJ)

with Hydro shocks		SJ-GC301K-SX
with Nitro shocks		SJ-GC301KN-SX

DOUBLE FLEX LIFT FOR 93-98 GRAND CHEROKEE (ZJ)

with Hydro shocks		SJ-GC301K-DX
with Nitro shocks		SJ-GC301KN-DX

HARD PARTS

SHOCK APPLICATION CHART



Year	Model	LIFT AMOUNT		NITRO SHOCK #		HYDRO SHOCK #		PLATINUM SHOCK #		<ul style="list-style-type: none"> Hydraulic Action Multi-stage velocity sensitive valving Twin tube construction Oversized piston head Internal rebound bumper 5/8" diameter hardened & double chromed rod Red polyurethane bushings Compression control prevents formation of air bubbles to reduce fade Includes red boot Limited lifetime warranty 150 psi Nitrogen gas pressurized Multi-stage velocity sensitive valving Twin tube construction Oversized piston head Internal rebound bumper 5/8" diameter hardened & double chromed rod Red polyurethane bushings Compression control prevents formation of air bubbles to reduce fade Includes red boot Limited lifetime warranty
		Front	Rear	Front	Rear	Front	Rear	Front	Rear	
97-02	TJ Wrangler	0"	0"	SJ-N8015	SJ-N8008	SJ-H7015	SJ-H7008	SJ-M9015	SJ-M9008	
97-02	TJ Wrangler	1-3"	1-3"	SJ-N8016	SJ-N8018	SJ-H7016	SJ-H7018	SJ-M9016	SJ-M9018	
97-02	TJ Wrangler	3.5-4"	3.5-4"	SJ-N8025	SJ-N8028	SJ-H7025	SJ-H7028	SJ-M9025	SJ-M9028	
97-02	TJ Wrangler	6-8"	6-8"	SJ-N8049	SJ-N8063	SJ-H7049	SJ-H7063	SJ-M9049	SJ-M9063	
87-96	YJ Wrangler	0-1"	0"	SJ-N8055	SJ-N8012	SJ-H7055	SJ-H7012	SJ-M9055	SJ-M9012	
87-96	YJ Wrangler	2-2.5"	1-2.5"	SJ-N8056	SJ-N8023	SJ-H7056	SJ-H7023	SJ-M9056	SJ-M9023	
87-96	YJ Wrangler	3.5-4"	3-6"	SJ-N8059	SJ-N8088	SJ-H7059	SJ-H7088	SJ-M9059	SJ-M9088	
87-96	YJ Wrangler	5-6"	3-6"	SJ-N8061	SJ-N8088	SJ-H7061	SJ-H7088	SJ-M9061	SJ-M9088	
82-86	CJ-5/7/8	0-2.5"	0-2.5"	SJ-N8012	SJ-N8023	SJ-H7012	SJ-H7023	SJ-M9012	SJ-M9023	
82-86	CJ-5/7/8	3-5"	3-5"	SJ-N8023	SJ-N8058	SJ-H7023	SJ-H7058	SJ-M9023	SJ-M9058	
76-81	CJ-5/7/8	0-2.5"	0"	SJ-N8012	SJ-N8012	SJ-H7012	SJ-H7012	SJ-M9012	SJ-M9012	
76-81	CJ-5/7/8	0-2.5"	1-3"	SJ-N8012	SJ-N8023	SJ-H7012	SJ-H7023	SJ-M9012	SJ-M9023	
76-81	CJ-5/7/8	3-5"	1-3"	SJ-N8023	SJ-N8023	SJ-H7023	SJ-H7023	SJ-M9023	SJ-M9023	
76-81	CJ-5/7/8	3-5"	3.5-5.5"	SJ-N8023	SJ-N8058	SJ-H7023	SJ-H7058	SJ-M9023	SJ-M9058	
55-75	CJ-5/6/3B,M38A1	0-1"	0"	SJ-N8012	SJ-N8012	SJ-H7012	SJ-H7012	SJ-M9012	SJ-M9012	
55-75	CJ-5/6/3B,M38A1	1.5-2.5"	1-3"	SJ-N8023	SJ-N8023	SJ-H7023	SJ-H7023	SJ-M9023	SJ-M9023	
55-75	CJ-5/6/3B,M38A1	3-5"	3.5"-5.5"	SJ-N8058	SJ-N8058	SJ-H7058	SJ-H7058	SJ-M9058	SJ-M9058	
41-63	MB, M38, CJ-2A/3A/3B	0-1"	0-1"	SJ-N8012	SJ-N8012	SJ-H7012	SJ-H7012	SJ-M9012	SJ-M9012	
84-01	XJ Cherokee	0-3"	0"	SJ-N8016	SJ-N8008	SJ-H7016	SJ-H7008	SJ-M9016	SJ-M9008	
84-01	XJ Cherokee	0-3"	1-3"	SJ-N8016	SJ-N8018	SJ-H7016	SJ-H7018	SJ-M9016	SJ-M9018	
84-01	XJ Cherokee	4-5"	4-5"	SJ-N8025	SJ-N8028	SJ-H7025	SJ-H7028	SJ-M9025	SJ-M9028	
84-01	XJ Cherokee	6"	5-6"	SJ-N8049	SJ-N8063	SJ-H7049	SJ-H7063	SJ-M9049	SJ-M9063	
93-98	ZJ Grand Cherokee	0-3"	0-3"	SJ-N8016	SJ-N8023	SJ-H7016	SJ-H7023	SJ-M9016	SJ-M9023	
93-98	ZJ Grand Cherokee	4-5"	4-5"	SJ-N8025	SJ-N8058	SJ-H7025	SJ-H7058	SJ-M9025	SJ-M9058	

STEERING STABILIZER KITS

Application	HD OEM Replacement	Single Kit	Dual Kit
97-02 TJ Wrangler	SJ-7009	SJ-7119	SJ-7219
87-96 YJ Wrangler	SJ-7009	SJ-7109	SJ-7200*
76-86 All CJ	SJ-7001	SJ-7100	SJ-7200*
41-75 All CJ (except w/ Slave Cyl. Power Steering)			
66-73 Jeepster/Commando	SJ-7001		
42-86 Jeepster/Commander			
84-00 XJ Cherokee	SJ-7009		
93-98 ZJ Grand Cherokee			
84-91 Grand Wagoneer; 74-83 Cherokee; 74-83 Wagoneer; 74-88 J10/20 PU 4WD	SJ-7005		

* = Parallel mounting



HARD PARTS

BODY LIFT KITS

Application	Stock No.
TJ 1" Body Lift (polyurethane)	SJ-SS941P
TJ 1" Body Lift	SJ-SS941
TJ 2" Body Lift	SJ-SS942
TJ 3" Body Lift	SJ-SS943
YJ 1" Body Lift (polyurethane)	SJ-SS931P
YJ 1" Body Lift	SJ-SS931
YJ 2" Body Lift (Manual Only)	SJ-SS932
YJ 3" Body Lift (Manual Only)	SJ-SS933
YJ 2" Body Lift (Auto Only)	SJ-SS932A
YJ 3" Body Lift (Auto Only)	SJ-SS933A
CJ-5/7 1980-86 1" Body Lift (polyurethane)	SJ-SS951P
CJ-5/7 1976-79 1" Body Lift (polyurethane)	SJ-SS961P
CJ-5/7/8 1972-86 1" Body Lift	SJ-SS911
CJ-5/7/8 1972-86 2" Body Lift	SJ-SS912
CJ-5/7/8 1972-86 3" Body Lift	SJ-SS913

A body lift may be what you need to get that extra clearance for oversized tires. They are available in 1", 2" and 3" sizes. Skyjacker also has a 1" polyurethane body lift available for CJ, YJ and TJ models.



FRONT TRACK BAR KITS

Application	Lift Amt	Stock No.
97-02 TJ Wrangler	4"	SJ-TBA10
84-01 XJ Cherokee		
93-98 ZJ Grand Cherokee		
97-02 TJ Wrangler	6"	SJ-TBA60 TBA
84-01 XJ Cherokee		
97-02 TJ Wrangler	8"	SJ-TBA80 TBA
84-01 XJ Cherokee		

ADJUSTABLE FLEX TRACK BAR KIT

The adjustable flex track bar kit uses a 3-piece, teflon lined, spherical rod end and is the best track bar configuration available for the TJ Wrangler, XJ Cherokee, and ZJ Grand Cherokee. It allows for 24" of total travel, relocates the bar to the top of the axle and includes a heavy duty steering stabilizer. Will work with most other manufacturers lift kits also.



REAR TRACK BAR KITS

Application	Lift Amt	Stock No.
97-02 TJ Wrangler	2-2.5"	SJ-RTBA25 TBA
97-02 TJ Wrangler	4"	SJ-RTBA15 TBA
97-02 TJ Wrangler	6"	SJ-RTBA65 TBA



PITMAN ARMS

When lifting a Jeep more than a couple inches, it is necessary to use a dropped pitman arm to compensate for the increased steering angles. These high quality pitman arms prevent the annoying bump steer caused by tall lift kits.

Application	Stock No.
TJ Wrangler 4-8" Lift; YJ Wrangler 3.5-4" lift w/Power Steering	SJ-JA750
YJ Wrangler 3.5-4" lift w/Manual Steering	SJ-JA850
76-86 CJ & Scrambler w/Power Steering 3.5-4" Lift	SJ-JA250
76-86 CJ & Scrambler w/Manual Steering 3.5-4" Lift	SJ-JA150
72-75 CJ & Scrambler w/Power Steering 2" Lift	SJ-JA552
72-75 CJ & Scrambler w/Power Steering 3-4" Lift	SJ-JA550
72-75 CJ w/Manual Steering 2" Lift	SJ-JA652
72-75 CJ w/Manual Steering 3-4" Lift	SJ-JA650
XJ Cherokee & ZJ Grand Cherokee 4-8" lift	SJ-JA500

TRANSFER CASE LOWERING KITS

Tubular transfer case lowering kits allow enthusiasts to gain height without sacrificing the driveshaft. They help eliminate drivetrain angle problems and annoying driveline vibration.



Application	Stock No.
TJ Wrangler 2-2.5"	SJ-TCL101
TJ Wrangler 3.5-4"	SJ-TCL151
YJ Wrangler 2-4"	SJ-TCL25
84-93 XJ Cherokee 3"	SJ-TCL30
94-01 XJ Cherokee 3"	SJ-TCL31
76-86 CJ 2-4"	SJ-TCL35
55-75 CJ-5/6 2-4"	SJ-TCL45

HEAVY DUTY TIE-ROD & DRAG LINK TUBES

These heavy duty replacement steering tubes are made from 1.250" D.O.M. swedged tubing. They fit the factory ends and allow for maximum articulation. No more bending; the strongest tubes available anywhere!



Description	Stock No.
Tie Rod Replacement for 1976-83 CJ-5 & 1976-81CJ-7, TUBE ONLY	SJ-TR100
Tie Rod Replacement for 82-86 CJ-7, TUBE ONLY	SJ-TR150
Tie Rod Replacement for all TJ Wrangler, XJ Cherokee, ZJ Grand Cherokee, TUBE ONLY	SJ-TR300
Drag Link Replacement for 87-95 YJ Wrangler, TUBE ONLY	SJ-DL200



DOUBLE CARDAN C.V. DRIVESHAFTS FROM SKYJACKER



CV Driveshafts are designed to be used in conjunction with slip-yoke eliminator kits. These shafts are much more rugged than the factory shaft and take the worry out of getting stuck out on a trail.

Application	Stock No.
TJ Wrangler, 6 Cyl., Auto	SJ-TJRS
87-93 YJ Wrangler w/ 6" lift, 6 Cyl., 5 Spd.	SJ-YJRSE
94-96 YJ Wrangler w/ 6" lift, 6 Cyl., 5 Spd.	SJ-YJRSL

SKIDPLATES, OILPANS AND MISC ITEMS



DEGREE WEDGES:

	Stock No.
CAST ALUMINUM, 6 DEGREE (FOR PINION ANGLE)	MS-WSC60
CAST ALUMINUM, 8 DEGREE (FOR PINION ANGLE)	MS-WSC80



Description	Stock No.
TJ Steering box Skid Plate	SJ-SSP10
TJ High Capacity Trans. Oil Pan	SJ-OPA999
TJ High Clearance T/C Skid plate Auto (SJ-JSRB231A included)	SJ-SP28A
TJ High Clearance T/C Skid plate Manual Only (SJ-JSRB231M included)	SJ-SP28M
Shifter Relocation Bracket-Auto	SJ-JSRB231A
Shifter Relocation Bracket-Manual	SJ-JSRB231M

**DANA 18 TRANSFER CASE
(1946-71 CJ)**

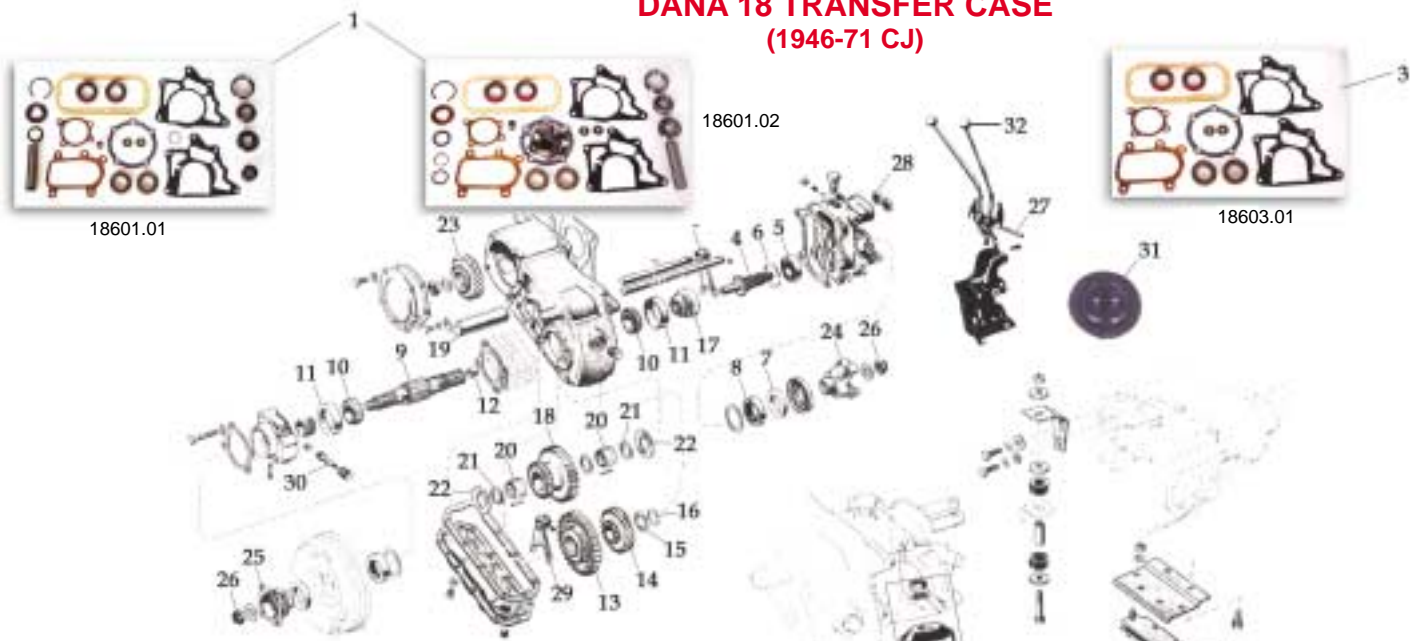

ITEM #	DESCRIPTION	Stock No.	Replaces
1	OVERHAUL REPAIR KIT KIT (INCLUDES: FRONT & REAR BEARINGS & CUPS, FRONT BALL BEARING, GASKETS & OIL SEALS KIT, NEEDLE BEARINGS & SMALL PARTS KITS) WITH 1-1/8" INTERMEDIATE GEAR SHAFT	18601.01	D18A-BSG
	WITH 1-1/4" INTERMEDIATE GEAR SHAFT	18601.02	D18B-BSG
2	COMPLETE ASSEMBLED DANA-18 TRANSFER CASE INCLUDES DUAL SHIFTER KIT ALL 4 CYLINDERS WITH 3 SPEED TRANSMISSION	18602.01	937477
3	GASKETS, OIL SEALS & FELTS KIT	18603.01	923300
4	FRONT OUTPUT SHAFT	18670.38	TBA
5	BALL BEARING, FRONT OUTPUT SHAFT	18670.01	A-1007
6	SNAP RING, FRONT OUTPUT SHAFT BEARING	18670.02	A-976
7	FELT FRONT OR REAR YOKE (2 NEEDED)	18670.03	932295
8	OIL SEAL, FRONT OR REAR YOKE (2 NEEDED)	18670.04	8123077
9	REAR OUTPUT SHAFT	18670.05	807767
10	BEARING CONE, FRONT OR REAR OUTPUT SHAFT (NEED 2)	18670.06	51575
11	BEARING CUP, FRONT & REAR OUTPUT SHAFT (NEED 2)	18670.07	51577
12	BUSHING, FRONT OUTPUT SHAFT	18670.08	A-987
13	FRONT OUTPUT SHAFT SLIDING GEAR:		
	39 TEETH COUNT (MARK 18-8-17)	18670.09	A-15045
	33 TEETH COUNT (MARK 18-8-22)	18670.10	809290
14	FRONT OUTPUT SHAFT GEAR:		
	26 TEETH COUNT (MARK 18-8-18)	18670.11	A-15044
	29 TEETH COUNT (MARK 18-8-24)	18670.12	809291
15	THRUST WASHER, FRONT OUTPUT SHAFT GEAR	18670.13	A-990
16	SNAP RING, FRONT OUTPUT SHAFT GEAR	18670.14	A-991
17	OUTPUT SHAFT HUB	18670.15	A-992
18	INTERMEDIATE GEAR:		
	34X21 TEETH COUNT (MARK 18-5-7)	18670.16	642189
	39X18 TEETH COUNT (MARK 18-5-9)	18670.17	809293
19	SHAFT, INTERMEDIATE GEAR 3/4"	18604.01	A-998
19	SHAFT, INTERMEDIATE GEAR 1-1/8"	18604.02	642188
19	SHAFT, INTERMEDIATE GEAR 1-1/4"	18604.03	942115
19A	SHAFT, NEEDLES & WASHER KIT	18605.01	942115K
20	ROLLER BEARING, INTERMEDIATE GEAR SHAFT:		
	WITH 3/4" SHAFT (CAGE BEARING, 2 NEEDED)	18670.18	A-924
	WITH 1-1/8" SHAFT (CAGE BEARING, 2 NEEDED)	18670.19	642190
	WITH 1-1/4" SHAFT (NEEDLE BEARING, 48 NEEDED)	18670.20	809294
21	SPACER, INTERMEDIATE GEAR SHAFT	18670.21	809295
22	THRUST WASHER, INTERMEDIATE SHAFT:		
	FOR 3/4" SHAFT (NEED 2)	18670.22	A-1000
	FOR 1-1/8" SHAFT (NEED 2)	18670.23	642191
	FOR 1-1/4" SHAFT (NEED 2)	18670.24	8121813
23	MAINSHAFT GEAR, 29 TEETH, 6 SPLINE	18670.25	809297
24	FRONT YOKE	16580.01	A-1106
25	YOKE, REAR (MB, 2A, 3A, 3B, M38, M38A1 MODELS)	18670.27	116714
26	NUT FOR FRONT OR REAR YOKE (2 NEEDED)	16584.01	801367
27	SHIFT LEVER PIVOT PIN	18670.29	A-972
28	SHIFT ROD OIL SEAL (2 NEEDED)	18670.30	A-974
29	SHIFT FORK	18670.31	A-959

ITEM #	DESCRIPTION	Stock No.	Replaces
30	SPEEDOMETER GEAR, 14 TEETH COUNT	17211.02	A-1512
30	SPEEDOMETER GEAR, 15 TEETH COUNT	17211.03	A-5707
31	SHIFTER BOOT, DUAL LEVER	18606.01	801058
32	SHIFT KNOB (EACH)	18607.01	914946
33	TRANSFER CASE MOUNT	18608.01	A-6156
34	REAR MOUNTING SUPPORT KIT BOLT & INSULATORS	18608.15	926671K
	WASHER FOR TRANSFER CASE SNUBBER, CJ	18670.32	4006365

TBA= TO BE ANNOUNCED

HARD PARTS

DANA 20 TRANSFER CASE (1972-79 CJ)

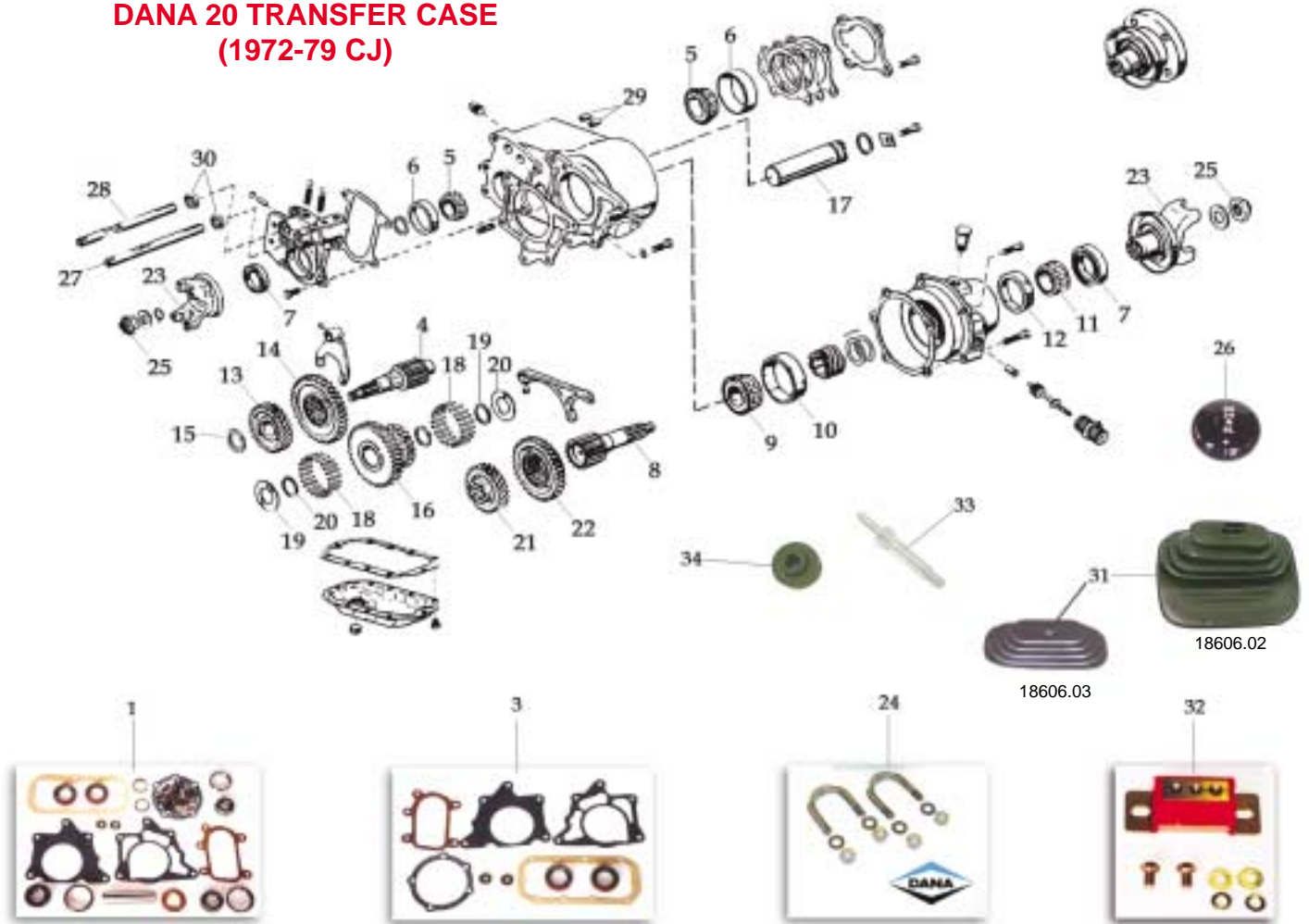

ITEM #	DESCRIPTION	Stock No.	Replaces
1	OVERHAUL KIT (INCLUDES 3 FRONT & REAR BEARINGS & CUPS, GASKETS & OIL SEALS KIT & SMALL PARTS KITS)	18601.03	D20-BSG
3	GASKETS & OIL SEALS KIT	18603.02	8130995
4	FRONT OUTPUT SHAFT (26 SPLINE)	18672.01	8130292
5	BEARING CONE, FRONT OUTPUT SHAFT (2 NEEDED)	18672.02	942113
6	BEARING CUP, FRONT OUT PUT SHAFT (2 NEEDED)	18670.07	51577
7	OIL SEAL, FRONT OR REAR YOKE (2 NEEDED)	18670.04	8123077
8	REAR OUTPUT SHAFT (26 SPLINE)	18672.03	8130293
9	BEARING CONE, INNER REAR OUTPUT SHAFT	16536.01	52799
10	BEARING CUP, INNER REAR OUTPUT SHAFT	16536.02	52800
11	BEARING CONE, OUTER REAR OUTPUT SHAFT	18672.06	933737
12	BEARING CUP, OUTER REAR OUTPUT SHAFT	18672.07	3124570
13	FRONT OUTPUT SHAFT GEAR:		
	29 TEETH COUNT (MARK 18-8-24 OR 18-8-64)	18670.12	809291
	26 TEETH COUNT (MARK 18-8-44)	18672.08	946784
14	OUTPUT SHAFT SLIDING GEAR:		
	31 TEETH COUNT (MARK 18-8-28)	18672.09	933735
	33 TEETH COUNT (MARK 18-8-22)	18670.10	809290
15	THRUST WASHER, FRONT OUTPUT SHAFT GEAR	18672.10	942111
16	INTERMEDIATE GEAR:		
	39X18 TEETH COUNT (MARK 18-5-9)	18670.17	809293
	34X20 TEETH COUNT (MARK 18-5-10) LTD. AVAILABILITY	18672.11	933736
	34X20 TEETH COUNT (MARK 18-5-16)	18672.12	946786
17	SHAFT, INTERMEDIATE GEAR	18604.03	942115
17A	SHAFT, NEEDLES & WASHER KIT	18605.01	942115K
18	NEEDLE ROLLER BEARING, (48 NEEDED)	18670.20	809294

ITEM #	DESCRIPTION	Stock No.	Replaces
19	SPACER, INTERMEDIATE GEAR SHAFT	18670.21	809295
20	THRUST WASHER, INTERMEDIATE SHAFT	18670.24	8121813
21	MAINSHAFT GEAR:		
	WITH T14 TRANNY 10 SPLINE, 26 TEETH, (MARK 18-8-49)	18672.13	947339
	WITH T15 TRANNY 26 TEETH, (MARK 18-8-46)	18672.14	946574
	WITH T150 TRANNY 26 TEETH, (MARK 18-8-55)	18672.15	5354506
22	SLIDING GEAR, 31 TEETH, (MARK 18-8-26)	18670.16	642189
23	FRONT OR REAR YOKE (2 NEEDED):		
	10 SPLINE	16580.01	A-1106
	26 SPLINE (U-BOLT DESIGN)	16580.02	935685
24	U-BOLT FOR ABOVE YOKES (PAIR)	16582.01	A-490K
	U-BOLT FOR ABOVE YOKES (PAIR) SPICER BRAND	16582.02	A-490KS
25	NUT FOR FRONT OR REAR YOKE (2 NEEDED)	16584.01	801367
26	SHIFT KNOB WITH SHIFT PATTERN	18607.02	5355941
27	SHIFT RAIL, OUTER (LEFT)	18672.20	934399
28	SHIFT RAIL, INNER (RIGHT)	18672.21	934393
29	SHIFT ROD CAP COVER	18672.17	934281
30	SHIFT ROD OIL SEAL (2 NEEDED)	18670.30	A-974
31	SHIFTER BOOT, 1972-75	18606.02	986495
	SHIFTER BOOT, 1976-79	18606.03	5353263
32	TRANSFER CASE MOUNT	18608.02	1370910
	POLYURETHANE MOUNT, RED	18608.03	7-1604
	POLYURETHANE MOUNT, BLACK	18608.04	7-1604BL
33	STABILIZER STUD, TRANSMISSION MOUNT	18608.05	5358979
34	STABILIZER BUSHING (2 NEEDED)	18608.06	945266
	POLYURETHANE STABILIZER BUSHING PAIR, RED	18608.07	1-1201
	POLYURETHANE STABILIZER BUSHING PAIR, BLACK	18608.08	1-1201BL

**DANA 300 TRANSFER CASE
(1980-86 CJ)**

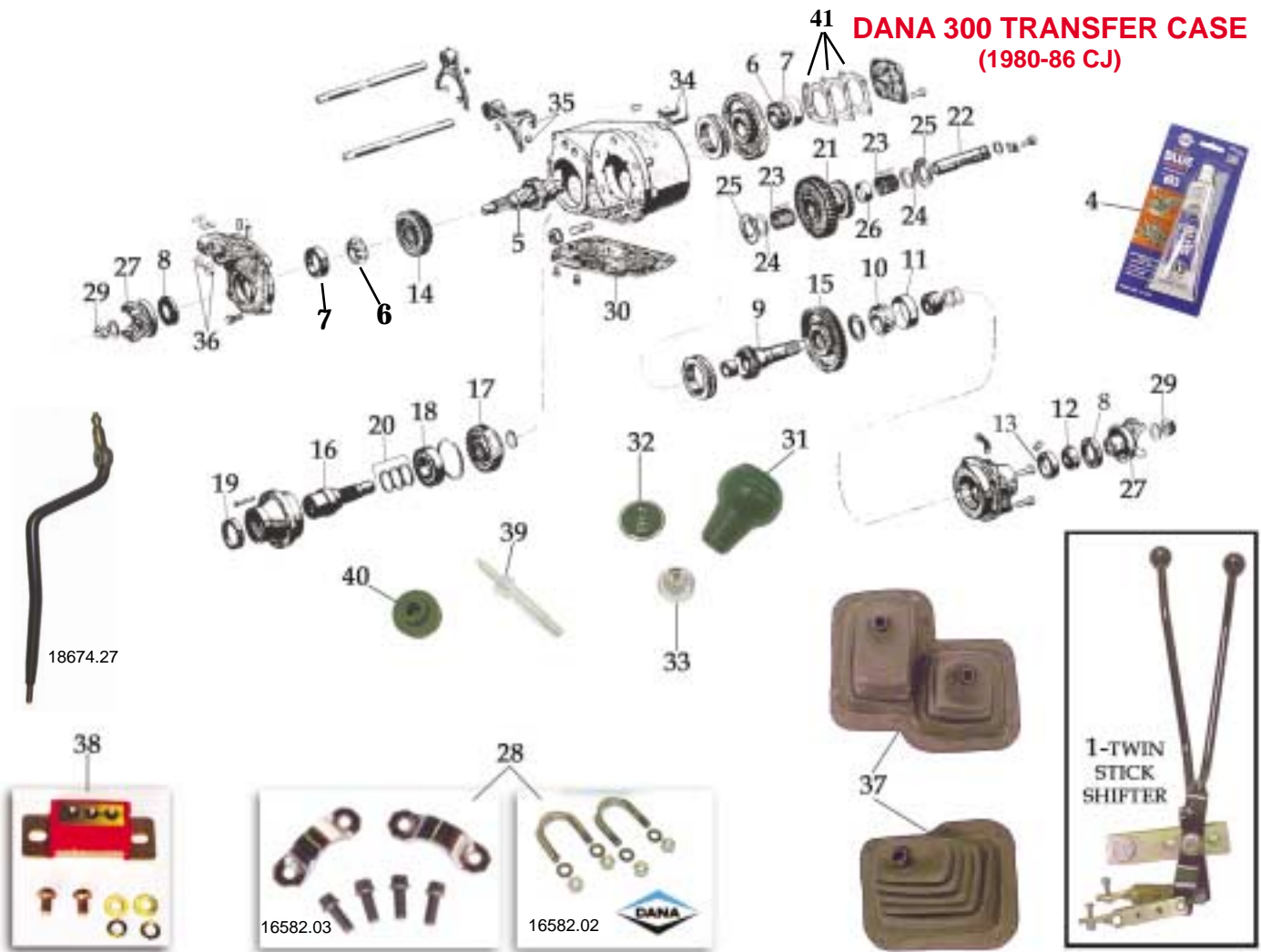

HARD PARTS

ITEM #	DESCRIPTION	Stock No.	Replaces	ITEM #	DESCRIPTION	Stock No.	Replaces
1	TWIN STICK SHIFTER ASSEMBLY	18674.01	OMIX-6450	26	SPACER, INTERMEDIATE SHAFT BEARING	18674.22	8131661
2	BOOT FOR TWIN STICK SHIFT	18606.06	OMIX-6451	27	FRONT OR REAR YOKE (2 NEEDED): STOCK STRAP & BOLT DESIGN	16580.03	8131656
3	GASKETS & OIL SEALS KIT	18603.03	D300GS		MODIFIED U-BOLT DESIGN	16580.02	935685
4	RTV SILICONE TUBE (TO BE USED AS GASKET)	19201.01	8993317	28	U-BOLT: STRAP & BOLT DESIGN (FOR 16580.03)	16582.03	3240533K
5	FRONT OUTPUT SHAFT (26 SPLINE)	18674.08	TBA		U-BOLT DESIGN (PAIR, PER YOKE) FOR 16580.02	16582.01	A-490K
6	BEARING CONE, FRONT OUTPUT SHAFT (2 NEEDED)	18674.09	3156063		U-BOLT DESIGN (PAIR, PER YOKE) FOR 16580.02 - SPICER	16582.02	A-490KS
7	BEARING CUP, FRONT OUTPUT SHAFT (2 NEEDED)	18674.10	3156062	29	NUT FOR FRONT OR REAR YOKE (2 NEEDED)	16584.01	801367
8	OIL SEAL, FRONT OR REAR YOKE (2 NEEDED)	18674.11	8131669	31	SHIFT KNOB (WITHOUT SHIFT PATTERN PLATE)	18607.03	3241062
9	REAR OUTPUT SHAFT	18674.12	8133793	32	SHIFT PATTERN PLATE (FOR ABOBE SHIFT KNOB)	18607.04	3241430
10	BEARING CONE, INNER REAR OUTPUT SHAFT	18674.13	8134239	33	SHIFT KNOB LOCK KNOB	18607.05	4006495
11	BEARING CUP, INNER REAR OUTPUT SHAFT	16536.02	52800	34	SHIFT ROD CAP COVER	18672.17	934281
12	BEARING CONE, OUTER REAR OUTPUT SHAFT	18672.06	933737	35	SHIFT FORK PLASTIC INSERT (2 NEEDED)	18674.24	8131670
13	BEARING CUP, OUTER REAR OUTPUT SHAFT	18672.07	3124570	36	SHIFT ROD OIL SEAL (2 NEEDED)	18674.25	8131674
14	FRONT OUTPUT SHAFT GEAR	18674.14	8131680	37	SHIFTER BOOT WITH SR4, T4, T5 TRANNY (SINGLE NIPPLE)	18606.04	5752009
15	SLIDING DRIVE GEAR (2 NEEDED)	18674.15	8131679	37	SHIFTER BOOT WITH T176, T177 TRANNY (DOUBLE NIPPLE)	18606.05	5752141
16	INPUT SHAFT	18674.16	8131687	38	TRANSFER CASE MOUNT	18608.02	1370910
17	INPUT SHAFT GEAR	18674.17	8131685	38	POLYURETHANE MOUNT, RED	18608.03	7-1604
18	INPUT SHAFT BEARING	18674.18	8131682	38	POLYURETHANE MOUNT, BLACK	18608.04	7-1604BL
19	INPUT SHAFT OIL SEAL	18674.19	8131684	39	STABILIZER STUD, TRANSMISSION MOUNT	18608.05	5358879
20	INPUT SHAFT SHIM KIT	18674.20	8131689	40	STABILIZER BUSHING (2 NEEDED)	18608.06	945266
21	INTERMEDIATE GEAR	18674.21	8131678	40	POLYURETHANE STABILIZER BUSHING PAIR, RED	18608.07	1-1201
22	SHAFT, INTERMEDIATE GEAR	18604.03	942115	40	POLYURETHANE STABILIZER BUSHING PAIR, BLACK	18608.08	1-1201BL
22A	SHAFT, NEEDLES & WASHER KIT	18605.01	942115K	41	SHIM SET (8PCS)	18674.26	8131668
23	NEEDLE ROLLER BEARING (48 NEEDED)	18670.20	809294				
24	SPACER, INTERMEDIATE GEAR SHAFT (2 NEEDED)	18670.21	809295				
25	THRUST WASHER, INTERMEDIATE SHAFT (2 NEEDED)	18670.24	8121813				

SHIFTER COMPONENTS

SHIFTER LEVER	18674.27	5363190
SHIFTER SHAFT	18674.28	5362034

NP231 TRANSFER CASE: 1987-06 WRANGLER (YJ & TJ), XJ CHEROKEE & ZJ GRAND CHEROKEE

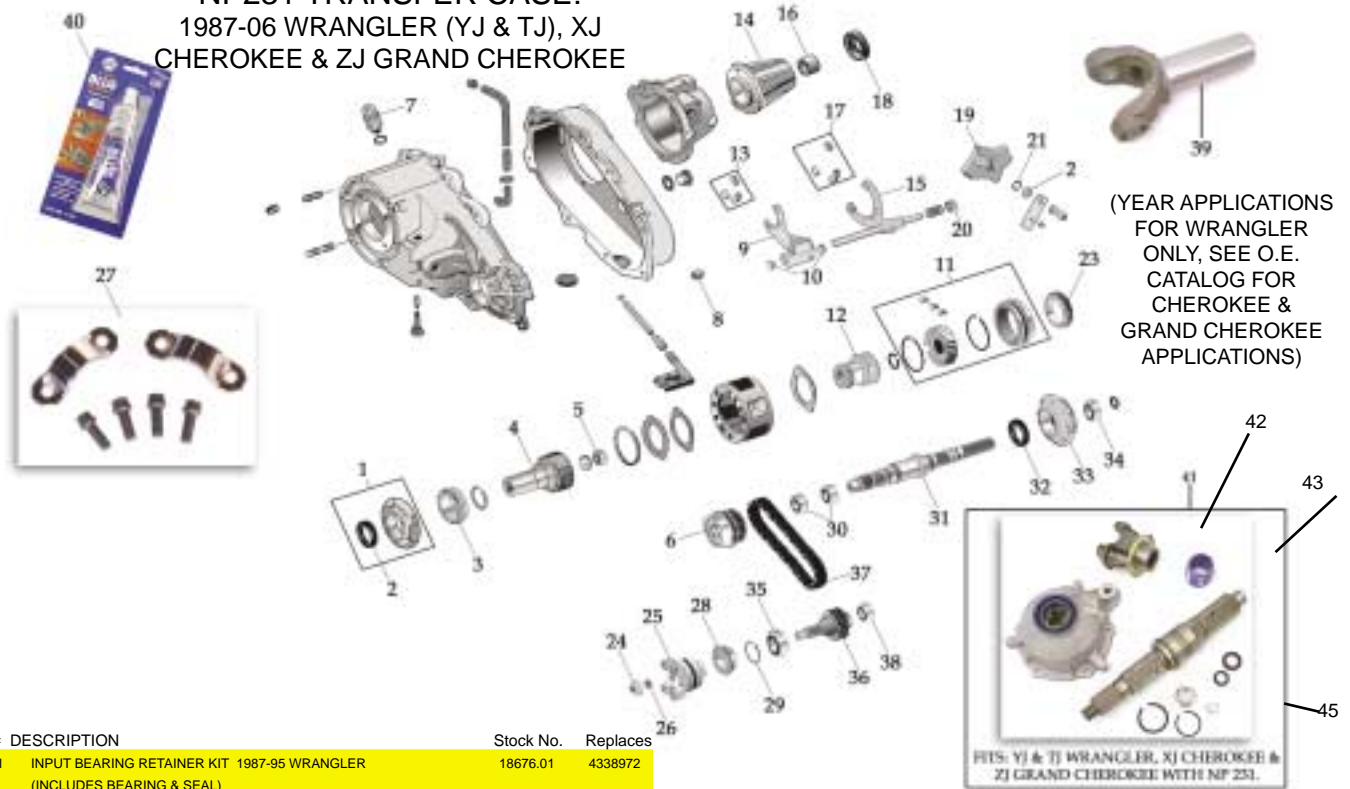

(YEAR APPLICATIONS FOR WRANGLER ONLY, SEE O.E. CATALOG FOR CHEROKEE & GRAND CHEROKEE APPLICATIONS)

#	DESCRIPTION	Stock No.	Replaces
1	INPUT BEARING RETAINER KIT 1987-95 WRANGLER (INCLUDES BEARING & SEAL)	18676.01	4338972
2	INPUT BEARING RETAINER SEAL, 1987-90 WRANGLER	18676.02	5359457
2	INPUT BEARING RETAINER SEAL, 1990-99 WRANGLER	18676.03	4167929
3	INPUT GEAR OUTER BEARING 1987-95 WRANGLER	18676.04	4338891
3	INPUT GEAR OUTER BEARING 1997-99 WRANGLER	18676.05	4746155
4	INPUT GEAR 23 SPLINE 1987-89 AUTOMATIC WRANGLER (INCLUDES BEARING)	18676.06	4505526
4	INPUT GEAR 23 SPLINE YJ & XJ WITH CASE #S 53008210, 52097893 OR 52098048 UNITS	18676.07	53006085
4	INPUT GEAR 21 SPLINE YJ & XJ	18676.08	53006083
4	INPUT GEAR 23 SPLINE YJ, XJ & ZJ (SEE OE CATALOG FOR APPLICATION)	18676.09	53006085
4	INPUT GEAR 23 SPLINE ZJ WITH 52097526 CASE	18676.10	4761068
5	INPUT GEAR INNER BEARING 1987-99 WRANGLER	18676.11	83503507
6	DRIVE SPROCKET 1987-93 WRANGLER	18676.12	4636963
6	DRIVE SPROCKET 1997-99 WRANGLER	18676.13	4796908
7	VACCUUM SWITCH 1987-93 WRANGLER YJ	18676.14	53001101
7	ELECTRICAL 4WD SWITCH 1997-99 WRANGLER	18676.15	8134473
8	CASE DOWEL (NEED 2) 1987-99 WRANGLER	18676.16	TBA
9	RANGE SHIFT FORK 1987-99 WRANGLER EXCEPT 53008210, 11, 12 UNITS	18676.17	4798136
10	RANGE SHIFT FORK BUSHING (NEED 2) 1987-93 WRANGLER	18676.18	83503137
11	SHIFT MODE SYNCHRONIZER ASSEMBLY, 1987-93 YJ (W/O BLOCKING RING)	18676.19	4796967
12	RANGE SHIFT HUB 1987-89 WRANGLER	18676.20	83503132
12	RANGE SHIFT HUB 1988-95 WRANGLER	18676.21	4796906
12	RANGE SHIFT HUB 1997-99 WRANGLER	18676.22	4797013
13	RANGE SHIFT FORK PAD SET 1987-90 WRANGLER	18676.23	83500994
13	RANGE SHIFT FORK PAD SET 1991-99 WRANGLER	18676.24	15866
14	HOUSING CASE REAR EXTENTION 1987-95 WRANGLER	18676.25	83503156
15	MODE SHIFT FORK 1987-93 WRANGLER	18676.26	4338920
15	MODE SHIFT FORK 1997-99 WRANGLER	18676.27	4761227

CV REAR DRIVESHAFT FOR 1987-06 WRANGLERS THIS DRIVESHAFTS ARE A MUST WHEN USING SLIP YOKE ELIMINATOR KITS ON NEW PROCESS 231

1987-93 WRANGLER WITH UP TO 3" LIFT	16592.01	CV-8793YJ23
1987-93 WRANGLER WITH OVER TO 3" LIFT	16592.02	CV-8793YJ45
1994-95 WRANGLER WITH UP TO 3" LIFT	16592.03*	CV-9495YJ23
1994-95 WRANGLER WITH OVER TO 3" LIFT	16592.04*	CV-9495YJ45
1987-06 TJ WRANGLER WITH 2" TO 6" LIFT	16592.05	CV-9701TJ26
1987-06 SLIP YOKE ELIMINATOR KIT FOR MP231	18676.60	52231

* THESE DRIVESHAFTS USE 3-5/8" WIDE U-JOINT, PLEASE VERIFY THE U-JOINT SIZE AT THE PINION END



16592.05

ITEM #	DESCRIPTION	Stock No.	Replaces
16	MAINDRIVE REAR BUSHING 1987-95 WRANGLER	18676.28	8134490
17	MODE SHIFT FORK PAD KIT	18676.24	15866
18	OUTPUT SHAFT REAR OIL SEAL 1987-95 WRANGLER	18676.29	4638904
19	SHIFT MODE SELECTOR 1987-89 WRANGLER	18676.30	4338895
19	SHIFT MODE SELECTOR 1991-93 WRANGLER	18676.31	4638844
19	SHIFT MODE SELECTOR 1997-99 WRANGLER	18676.32	4638845
20	MODE SHIFT FORK BUSHING 1987-95 WRANGLER	18676.49	4338945
21	SELECTOR SHAFT O-RING	18676.33	4167963
22	SELECTOR SHAFT SEAL	18676.34	4167964
23	SHIFT MODE SYNCHRONIZER BLOCKING RING 1987-95 WRANGLER	18676.35	4329526
24	REAR OUTPUT YOKE NUT 1987-99 WRANGLER	18676.36	4446488
25	FRONT OUTPUT YOKE 1987-95 WRANGLER	18676.37	83502829
25	FRONT OUTPUT YOKE 1997-99 WRANGLER	18676.38	4798120
24	FRONT OUTPUT YOKE XJ & ZJ	18676.39	4446494
26	FRONT OUTPUT YOKE WASHER 1987-95 WRANGLER	18676.40	4446487
27	YOKE STRAP & BOLT KIT 1987-95 WRANGLER	16582.03	3240553k
28	FRONT OUTPUT SEAL	18676.41	4338893
29	FRONT OUTPUT SHAFT BEARING RETAINER	18676.42	4338894
30	MAINDRIVE SPROCKET BEARING (NEED 2) 1987-89 WRANGLER	18676.43	4167953
30	MAINDRIVE SPROCKET BEARING (NEED 2) 1991-95 WRANGLER	18676.44	4269185
31	MAINDRIVE 1987-95 WRANGLER	18676.45	83503141
32	OIL PUMP HOUSING OIL SEAL 1987-99 WRANGLER	18676.46	4210603
33	OIL PUMP HOUSING & OIL SEAL 1987-99 WRANGLER	18676.47	4338936
34	REAR OUTPUT SHAFT OUTER BEARING 1987-99 WRANGLER	18676.48	A-1007
35	OUTPUT SHAFT FRONT BEARING 1987-99 WRANGLER	18676.48	A-1007
36	FRONT OUTPUT SHAFT 1987-99 WRANGLER	18676.50	4338934
37	DRIVE CHAIN 1987-99 WRANGLER AND ALL OTHER 231 MODELS	18612.01	83503146
38	OUTPUT SHAFT REAR BEARING 1987-99 WRANGLER	18676.51	4269189
39	REAR OUTPUT SHAFT SLIP YOKE 1987-93 YJ WRANGLER	16580.53	83502855
40	RTV SILICONE TUBE (USE AS GASKET)	19201.01	8993317
41	WRANGLER (1987-99 YJ & TJ) SLIP YOKE ELIMINATOR KIT (THIS KIT ELIMINATES DRIVELINE VIBRATION PROBLEMS ASSOCIATED WITH LIFTED VEHICLES)	18676.60	52231
42	YOKE, FOR SLIP YOKE ELIMINATOR KIT	18676.61	245341
43	SPEEDO GEAR, NEW PROCESS 241, DODGE PICK-UP	18677.01	4338996
44	OIL SEAL, USED IN SLIP ELIMINATOR KIT IN NP231	18676.62	
45	SPARE HARDWARE KIT FOR 52231 SLIP YOKE ELIMINATOR	18676.64	

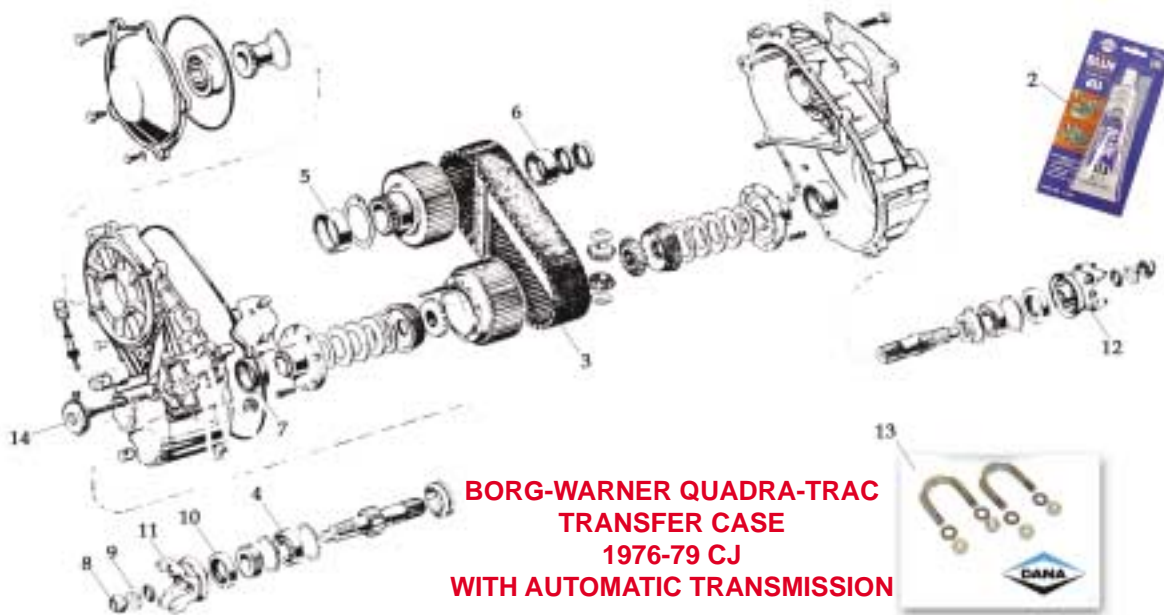

**BORG-WARNER QUADRA-TRAC
TRANSFER CASE
1976-79 CJ
WITH AUTOMATIC TRANSMISSION**



18612.04



18612.07



18612.05

ITEM #	DESCRIPTION	Stock No.	REPLACES
1	GASKETS & OIL SEALS KIT	18603.04	8125030
2	RTV SILICON TO BE USED AS GASKET	19201.01	8993317
3	DRIVE CHAIN		
	REPLACEMENT FOR FACTORY CHAIN	18612.08	8122392
	REPLACEMENT FOR OVERDRIVE PART-TIME CONVERSION KIT	18612.09	8122392DN
4	OUTPUT SHAFT BEARING, FRONT OR REAR (2 NEEDED)	18678.01	8122391
5	BEARING, REAR UPPER SPROCKET	18678.02	8122395
6	BEARING, FRONT UPPER SPROCKET	18678.03	8122390
7	BEARING, FRONT & REAR LOWER SPROCKET (2 NEEDED)	18678.03	8122390
8	NUT FOR FRONT OR REAR YOKE (2 NEEDED)	16584.01	801367
9	WASHER FOR FRONT OR REAR YOKE (2 NEEDED)	16584.02	636570
10	OIL SEAL, FRONT OR REAR YOKE (2 NEEDED)	18670.04	8123077
11	YOKE, REAR OUTPUT, 10 SPLINE	16580.01	A-1106
12	YOKE, FRONT OUTPUT		
	10 SPLINE	18678.04	5351145
	26 SPLINE	18678.05	8129363
13	U-BOLT U-BOLT DESIGN (PAIR, PER YOKE)	16582.01	A-490K
13	U-BOLT U-BOLT DESIGN (PAIR, PER YOKE) SPICER BRAND	16582.02	A-490KS
14	VALVE, EMERGENCY DRIVE SHIFT	18678.06	8122991



19001.01

AUTOMATIC TRANSMISSION REBUILD KITS:

THESE SUPER KITS INCLUDE: Overhaul gasket & seal kit, all friction plates, all steel clutch plates, Flex Band (if required), filter & bushings and all friction and steel clutch plates

DESCRIPTION	Stock No.	Replaces
1993-98 6 CYL, ZJ GRAND CHEROKEE, 1999- UP 6 CYL WJ GRAND CHEROKEE, FOR A-500 TYPE	19001.01	AT-A500-SK
1993-98 V8, ZJ GRAND CHEROKEE, FOR A-518 TYPE	19001.02	AT-A518-SK
1987-01 4 OR 6 CYL, XJ CHEROKEE, 1987-93 MJ COMMANCHE, FOR AW4 TYPE	19001.03	AT-AW4SK
1987-03 4 OR 6 CYL, YJ & TJ WRANGLERS, FOR TF6	19001.04	AT-TF6-SK

**NOTE: # 19001.05 - IS NOT A SUPER KIT- IT CONTAINS:
overhaul gasket & seal kit, all friction & steel clutch plates**

1999-UP 4.7L V8 WJ GRAND CHEROKEE,	19001.05	AT-45RFE-MK
2002-UP 4 OR 6 CYL KJ LIBERTY, FOR 45RFE TYPE		

MISC. TRANSFER CASE DRIVE CHAINS:

DESCRIPTION	Stock No.	Replaces
NEW PROCESS 207, WAGONEER, CHEROKEE	18612.02	8134471
NEW PROCESS 208, CHEROKEE, WAGONEER:	18612.03	8130977
NEW PROCESS 219, CHEROKEE, WAGONEER:	18612.04	8130831
NEW PROCESS 228 OR 229, GRAND WAGONEER	18612.04	8130831
NEW PROCESS 242, CHEROKEE:	18612.05	83504575
NEW PROCESS 249, ZJ GRAND-CHEROKEE:	18612.06	4728159
NEW PROCESS 247, ZJ GRAND-CHEROKEE:	18612.07	5012322AB
NEW PROCESS 231, YJ & TJ WRANGLER, XJ CHEROKEE & ZJ GRAND CHEROKEE:	18612.01	83503146

AUTOMATIC TRANSMISSION FILTERS:

DESCRIPTION	Stock No.	Replaces
2000-04 6 CYL WJ GRAND CHEROKEE FOR 42RE	19003.01	52118789
1999-03 2WD V8 WJ, 2002-03 2WD V6 KJ LIBERTY, 3 PCS KIT	19003.02	4800029AA
1999-04 4WD V8 WJ, 2002-03 4WD V6 KJ LIBERTY, 3 PCS KIT, FOR 45RFE	19003.03	5013470AC
1987-02 ALL YJ, TJ, 1993-98 V8 ZJ, 1994-01 4 CYL XJ	19003.04	3515996
1987-02 ALL YJ, TJ, 1993-98 V8 ZJ, 1994-01 4 CYL XJ, W / GASKET	19003.05	3515996K
1987-01 4.0L XJ CHEROKEE, 1987-93 2.5L XJ, 1993 4.0L ZJ	19003.06	83504032
1987-01 4.0L XJ CHEROKEE, 1987-93 2.5L XJ, 1993 4.0L ZJ, W / GASKET	19003.07	83504032K

AUTOMATIC TRANSMISSION MOUNTS:

1984-90 4 CYL. XJ	19005.01	52002334
1991-96 2.5L XJ, 2WD	19005.02	52007393
1985-86 2.1L DIESEL XJ, MANUAL TRANS	19005.03	52001180
1984-2000 2.5L XJ, MANUAL TRANS, 2WD OR 4WD	19005.03	52001180
1987-99 4.0L XJ	19005.01	52002334
2000-01 4.0L XJ	19005.04	52059347AB
1994-95 4.0L ZJ	19005.05	52058608
1996 4.0L ZJ	19005.06	52058486
1997-98 4.0L ZJ	19005.07	52058485
1994-98 5.2L & 5.9L ZJ	19005.08	52058488
1999 4.0L WJ, 4WD	19005.09	52059084
1999 4.0L WJ, 2 WD	19005.10	52059086
2000-04 WJ, 2WD	19005.11	52058995
2000 4.0L WJ, 4WD	19005.12	52059397AA
2001-04 4.0L WJ, 4WD	19005.13	52058994
1999-04 4.7L V8 WJ GRAND CHEROKEE, 4 WD	19005.14	52058996

HARD PARTS

WARNER T90 3 SPEED

CJ (2A, 3A, 3B, 5 & 6), M38, M38A1, 475 WAGON & TRUCK....

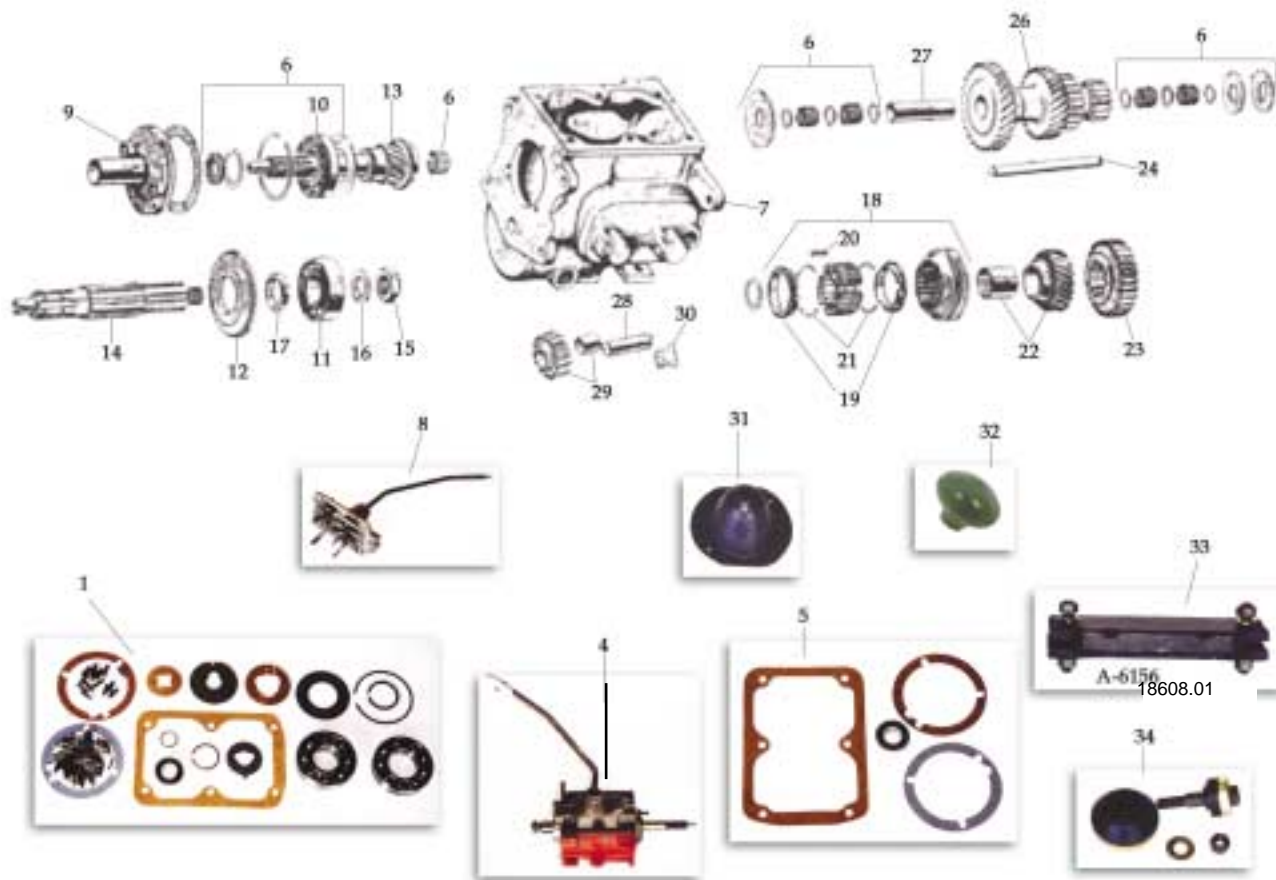

ITEM #	DESCRIPTION	Stock No.	Replaces
1	OVERHAUL REPAIR KIT KIT INCLUDES FRONT & REAR BEARINGS, GASKET KIT & SMALL PARTS KITS (ITEMS 5,6,9,10)	18801.01	T-90BSG
2	T90 INTERNAL PARTS KIT: KIT INCLUDES: MAINSHAFT, INPUT SHAFT, 1ST GEAR, 2ND GEAR, 2-3 SYNCHRONIZER ASM, CLUSTER GEAR & SHAFT, REVERSE IDLER GEAR W/ SHAFT, FRONT & REAR BEARINGS, GASKET KIT & SMALL PARTS KIT		
	ALL 4 CYLINDERS & 475 (226)WAGON (9 1/16" INPUT SHAFT)	18802.01	T-90K
	ALL 475 (226) TRUCK & GM V8 CONVERSION CJ (11.5" INPUT SHAFT)	18802.02	T-90K-L
3	UNASSEMBLED T90 KIT (ALL ITEMS IN #2 PLUS CASE):		
	ALL 4 CYLINDERS & 475 (226)WAGON	18802.03	T-90KS
	GM V8 CONVERSION ENGINE CJ (11.5" INPUT)	18802.04	T-90KS-L
4	COMPLETE ASSEMBLED TRANSMISSION, W/ TOP SHIFTER KIT		
	ALL 4 CYLINDERS & 475 (226) WAGON (W/ 9 1/16" INPUT SHAFT)	18803.01	946109
	CJ W/ V8 GM CONVERSION ENGINE (FRONT RETAINER IS NOT INCLUDED)	18803.02	934319
5	GASKET KIT	18804.01	923301
6	SMALL PARTS KIT	18805.01	922607
7	CASE (EMPTY)	18880.01	642754
8	TRANSMISSION TOP COVER ASSEMBLY WITH RAILS & FORKS	18880.02	946111
9	RETAINER, TRANSMISSION FRONT BEARING (ALL 4 CYLINDERS)	18880.03	640422
10	BEARING, TRANSMISSION FRONT (FOR INPUT SHAFT)	18880.04	8136643
11	BEARING, TRANSMISSION REAR (FOR MAINSHAFT)	18880.05	8136619
12	ADAPTER, TRANSMISSION REAR BEARING	18880.06	644552
13	INPUT SHAFT		
	ALL 4 CYLINDERS WITH 9 1/16" LENGTH & 18 TEETH	18880.07	640428
	ALL 4 CYLINDERS WITH 9 1/8" LENGTH & 16 TEETH	18880.08	643246
	ALL 6 CYLINDER 475 (226)TRUCKS & V8 GM CONVERSION CJ (11.5")	18880.09	906203

ITEM #	DESCRIPTION	Stock No.	Replaces
14	MAINSHIFT	18880.10	640390
15	NUT, MAIN SHAFT	18880.11	940970
16	WASHER, MAINSHAFT	18880.12	A-1410
17	SPACER, MAINSHAFT BEARING	18880.13	643621
18	SYNCHRONIZER ASM, 2ND & 3RD (INCLUDES BLOCKING RINGS)	18880.14	640391
19	BLOCKING RING (EACH)	18880.15	640397
20	KEY, SYNCHRONIZER (3 NEEDED)	18880.16	640395
21	SPRING, SYNCHRONIZER (2 NEEDED)	18880.17	640394
22	2ND SPEED GEAR WITH BUSHING	18880.18	906197
23	LOW SPEED GEAR	18880.19	906199
24	COUNTER SHAFT	18880.20	640412
25	OIL COLLECTOR, COUNTER SHAFT GEAR	18880.21	640413
26	CLUSTER GEAR, COUNTERSHAFT 33 TEETH (TEETH COUNTS 33-26-19-14) 4 CYL & 6 CYL	18880.22	906200
	35 TEETH (TEETH COUNTS 35-26-19-14)	18880.23	643702
	MOST OF 1966-71 4 CY L		
27	SPACER, CLUSTER GEAR	18880.24	802414
28	SHAFT, REVERSE IDLER	18880.25	640420
29	GEAR, REVERSE IDLER WITH BUSHING	18880.26	640417
30	PLATE, REVERSE IDLER SHAFT	18880.27	937459
31	SHIFTER BOOT	18806.01	907107
31A	RETAINER RING FOR TRANSMISSION SHIFTER BOOT COVER	18880.28	649890
32	SHIFT KNOB	18807.01	929393
33	TRANSMISSION MOUNT (CJ SERIES)	18608.01	A-6156
33	TRANSMISSION MOUNT (WAGONS AND TRUCKS)	18880.29	8126799
34	REAR MOUNTING SUPPORT KIT BOLT & INSULATORS	18608.15	926671K

HARD PARTS

WARNER T14 & T15 3 SPEED
1967-71 225 V6 CJ , 1972-75 INLINE 6 CYL. 232 CJ

T14 3 SPEED:

ITEM #	DESCRIPTION	Stock No.	Replaces
1	OVERHAUL REPAIR KIT: INCLUDES FRONT & REAR BEARINGS, GASKETS & SEAL KIT AND SMALL PARTS KIT (ITEMS 2, 3, 4, 5)	18801.02	T-14BSG
2	GASKET & SEAL KIT	18804.02	991198
3	SMALL PARTS KIT	18805.02	T-14
4	BEARING, TRANSMISSION FRONT (FOR INPUT SHAFT)	18881.01	3184013
5	BEARING, TRANSMISSION REAR (FOR MAINSHAFT)	18881.02	492289
6	OIL SEAL, MAIN DRIVE RETAINER	18881.03	8133528
7	INPUT SHAFT: WITH 11.5" LENGTH, 20 TEETH COUNT, FOR V6 225 ENGINES	18881.04	991058
	WITH 10.5" LENGTH, 20 TEETH COUNT, FOR INLINE 6CYL. (232, 258) ENGINES	18881.05	991059
8	MAINSHAFT	18881.06	991012
9	NUT, MAIN SHAFT	18880.11	940970
10	WASHER, MAINSHAFT	18880.12	A-1410
11	SYNCHRONIZER ASM, 2ND & 3RD (INCLUDES BLOCKING RINGS)	18881.07	948991
12	BLOCKING RING, 2-3 SYNCHRONIZER (2 NEEDED)	18881.08	991020
13	REVERSE IDLER GEAR WITH BUSHING	18881.09	991037
14	2ND SPEED GEAR, 26 TEETH	18881.10	991018
15	LOW SPEED GEAR	18881.11	991026
16	SYNCHRONIZER ASSEMBLY 1ST & REVERSE (WITH BLOCKING RING)	18881.12	948992
17	BLOCKING RING, 1ST & REVERSE	18881.08	991020
18	COUNTER SHAFT	18881.14	3192435
19	CLUSTER GEAR, COUNTERSHAFT: 31-25-15-14 TEETH, FOR V6 225 ENGINES	18881.15	991043
	31-24-15-14 TEETH, FOR INLINE 6CYL. (232 OR 258 ENGINE)	18881.16	3218914
20	SHAFT, REVERSE IDLER	18881.17	3192366
21	GEAR, REVERSE IDLER	18881.18	3192429
22	SHIFTER BOOT	18806.02	948185
23	RETAINER RING FOR BOOT	18881.19	948146
24	SHIFT KNOB	18807.01	929393

T15 3 SPEED:

ITEM #	DESCRIPTION	Stock No.	Replaces
25	TRANSMISSION MOUNT, 1967-71	18881.20	939995
25	TRANSMISSION MOUNT, 1972-75	18608.02	1370910
25	POLYURETHANE TRANSMISSION MOUNT, 1972-75, RED	18608.03	7-1604
25	POLYURETHANE TRANSMISSION MOUNT, 1972-75, BLACK	18608.04	7-1604BL
26	STABILIZER STUD, TRANSMISSION MOUNT	18608.05	5358879
27	STABILIZER BUSHING (2 NEEDED)	18608.06	945266
28	POLYURETHANE STABILIZER BUSHING PAIR, RED	18608.07	1-1201
28	POLYURETHANE STABILIZER BUSHING PAIR, BLACK	18608.08	1-1201BL

ITEM #	DESCRIPTION	Stock No.	Replaces
1	T15 OVERHAUL KIT INCLUDES: 2 BEARINGS, GASKETS & SMALL PARTS KIT	18801.03	T-15BSG
2	GASKET & SEAL KIT	18804.03	991199
3	SMALL PARTS KIT	18805.03	T-15
4	FRONT BEARING, FOR INPUT SHAFT	18882.01	4488141
5	REAR TRANSMISSION BEARING	18882.02	991076
6	OIL SEAL, FRONT RETAINER	18881.03	8133528
17	SYNCHRONIZER RING, 1ST, 2ND & 3RD (3 NEEDED)	18882.03	991021
18	COUNTER SHAFT	18882.04	3192422
22	SHIFTER BOOT	18806.02	948185
23	BOOT RETAINER RING	18881.19	948146
24	SHIFT KNOB	18807.01	929393
25	TRANSMISSION MOUNT	18608.02	1370910
25	POLYURETHANE TRANSMISSION MOUNT, RED	18608.03	7-1604
25	POLYURETHANE TRANSMISSION MOUNT, BLACK	18608.04	7-1604BL
26	STABILIZER STUD, TRANSMISSION MOUNT	18608.05	5358879
27	STABILIZER BUSHING (2 NEEDED)	18608.06	945266
28	POLYURETHANE STABILIZER BUSHING PAIR, RED	18608.07	1-1201
28	POLYURETHANE STABILIZER BUSHING PAIR, BLACK	18608.08	1-1201BL

HARD PARTS

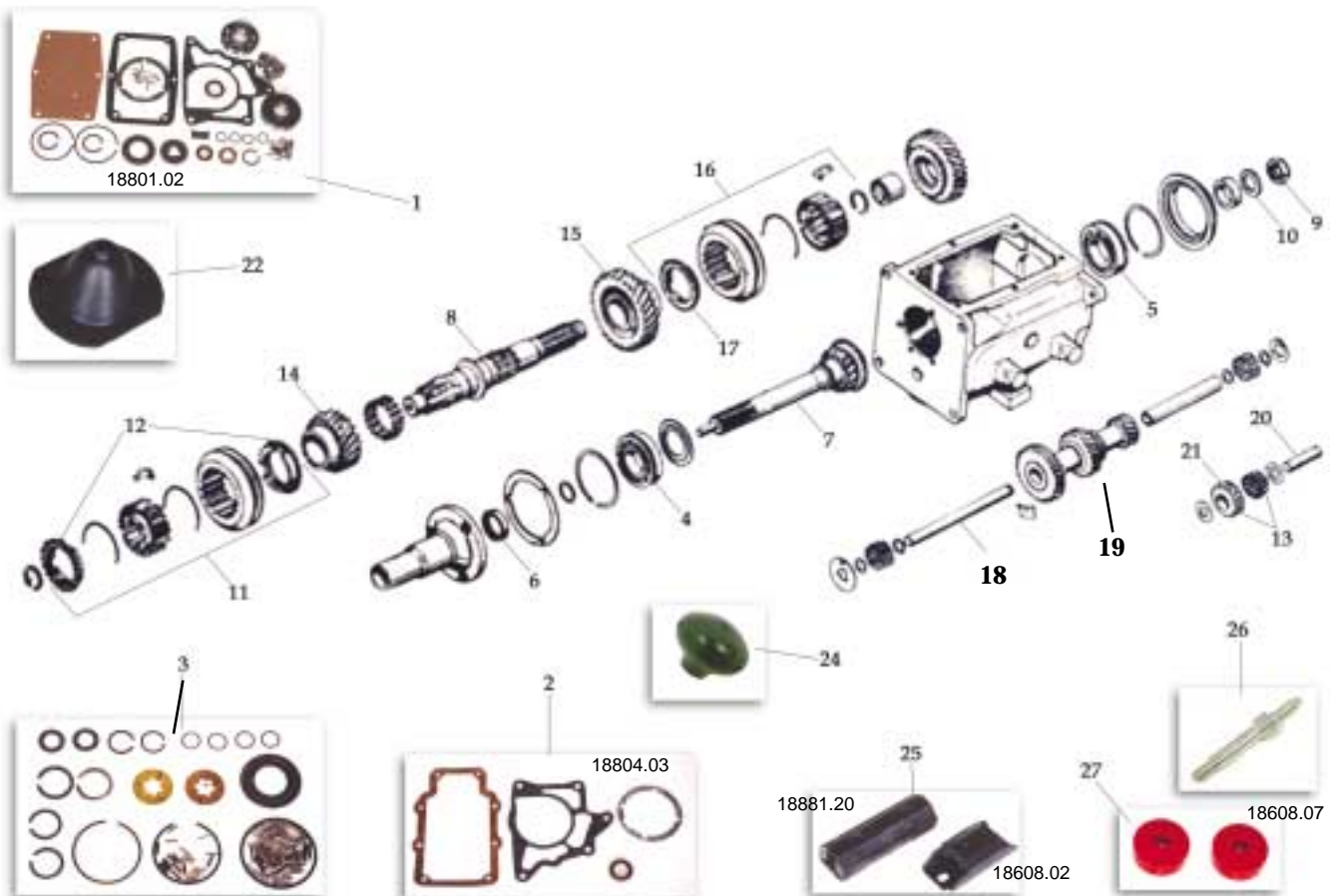

TREMEC T150 3 SPEED 1976-79 6 OR 8 CYL. CJ 5 & CJ 7

ITEM #	DESCRIPTION	Stock No.	ITEM #	DESCRIPTION	Stock No.	Replaces
1	OVERHAUL REPAIR KIT INCLUDES FRONT & REAR BEARINGS, GASKETS & SEALS KIT & SMALL PARTS KITS (ITEMS 3,4,5,6,8,12,)	18801.04 T-150BSG	16	2ND SPEED GEAR	18883.07	8124899
2	T150 INTERNAL PARTS KIT INCLUDES: MAINSHAFT, INPUT SHAFT, 1ST SPEED GEAR, 2ND SPEED GEAR, LOW & REVERSE SYNCHRONIZER ASM, 2-3 SYNCHRONIZER ASM, CLUSTER GEAR & SHAFT, REVERSE IDLER GEAR W/ SHAFT, FRONT & REAR BEARINGS, FRONT & REAR OIL SEALS, GASKET KIT, SMALL PARTS KIT	18802.05 T-150K	17	LOW SPEED GEAR	18883.08	8124902
3	GASKET KIT	18804.04 8127215	18	SYNCHRONIZER ASSEMBLY 1ST & REVERSE W/ BLOCKING RING	18883.09	8126234
4	SMALL PARTS KITS	18805.04 T-150	19	BLOCKING RING, 1ST & REVERSE	18883.10	8132381
5	BEARING, TRANSMISSION FRONT (FOR INPUT SHAFT)	18880.04 8136643	20	COUNTER SHAFT	18883.11	8136675
6	BEARING, TRANSMISSION REAR (FOR MAINSHAFT)	18880.05 8136619	21	CLUSTER GEAR, COUNTERSHAFT	18883.12	8124907
7	RETAINER, INPUT SHAFT	18883.01 8124880	22	SHAFT, REVERSE IDLER	18883.13	8124912
8	OIL SEAL, MAIN DRIVE RETAINER	18881.03 8133528	23	GEAR, REVERSE IDLER WITH BUSHING	18883.14	8124913
9	INPUT SHAFT	18883.02 8126106	24	BELLOUSING (1976-79 CJ) 6 OR 8 CYL.	16916.01	8133951
10	MAINSHAFT	18883.03 8126804	25	SHIFTER BOOT	18806.02	948185
11	NUT, MAIN SHAFT	18880.11 940970	26	RETAINER RING FOR SHIFTER BOOT	18881.19	948146
12	OIL SEAL, REAR MAINSHAFT	18883.04 5358980	27	SHIFT KNOB	18807.01	929393
13	WASHER, MAINSHAFT	18880.12 A-1410	28	TRANSMISSION MOUNT	18608.02	1370910
14	SYNCHRONIZER ASM, 2ND & 3RD (INCLUDES BLOCKING RINGS)	18883.05 8136631	28	POLYURETHANE TRANSMISSION MOUNT, RED	18608.03	7-1604
15	BLOCKING RING, 2-3 SYNCHRONIZER (2 NEEDED)	18883.06 8136653	29	POLYURETHANE TRANSMISSION MOUNT, BLACK	18608.04	7-1604BL
			29	STABILIZER STUD, TRANSMISSION MOUNT	18608.05	5358879
			30	STABILIZER BUSHING (2 NEEDED)	18608.06	945266
			30	POLYURETHANE STABILIZER BUSHING PAIR, RED	18608.07	1-1201
			30	POLYURETHANE STABILIZER BUSHING PAIR, BLACK	18608.08	1-1201BL
			31	SHIFT FORK, 1 & REVERSE	18883.15	8126825
			32	SHIFT FORK, 2 & 3	18883.16	8126826

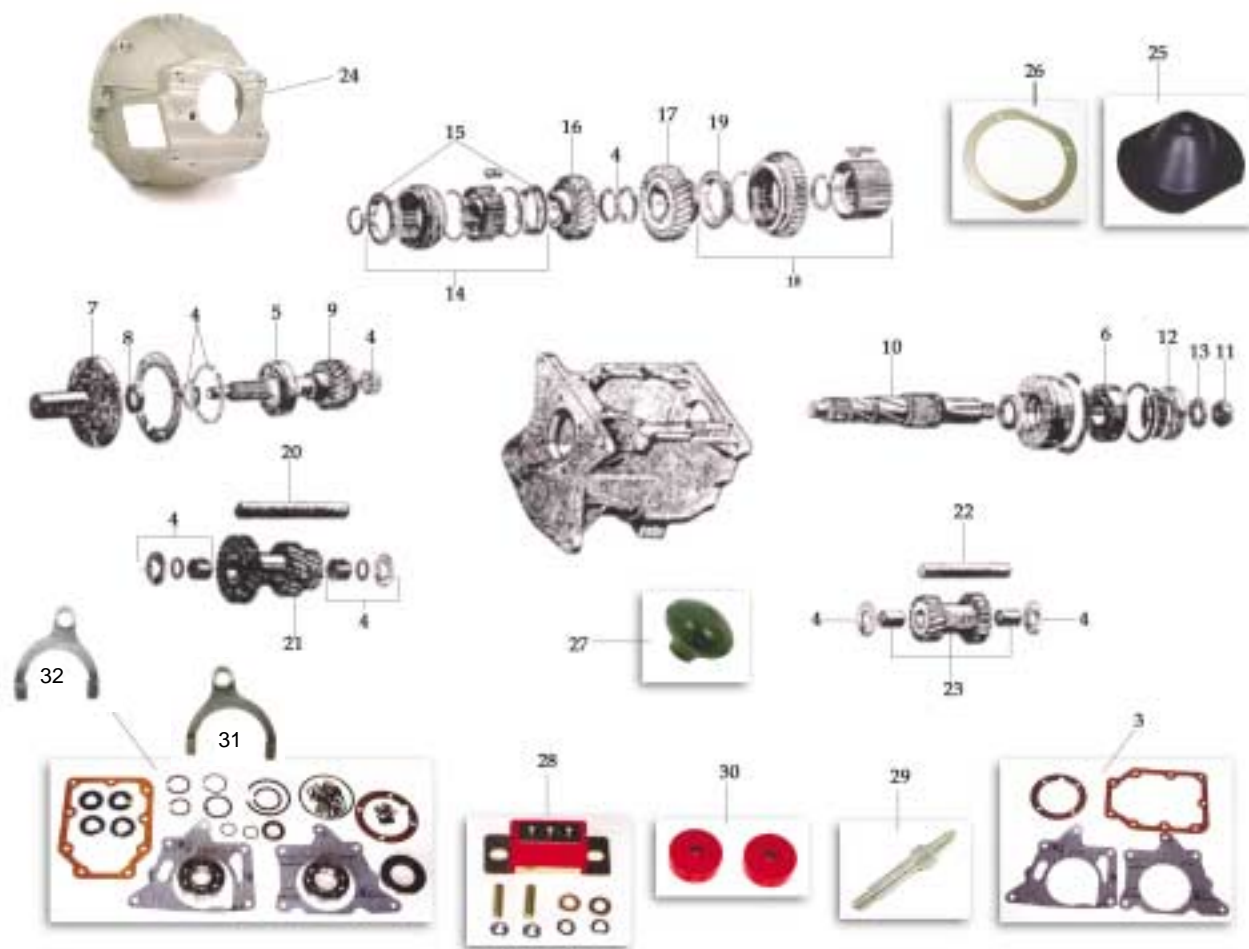

HARD PARTS

**TREMEC T176 & 177 4 SPEED
1980-86 CJ & SJ**

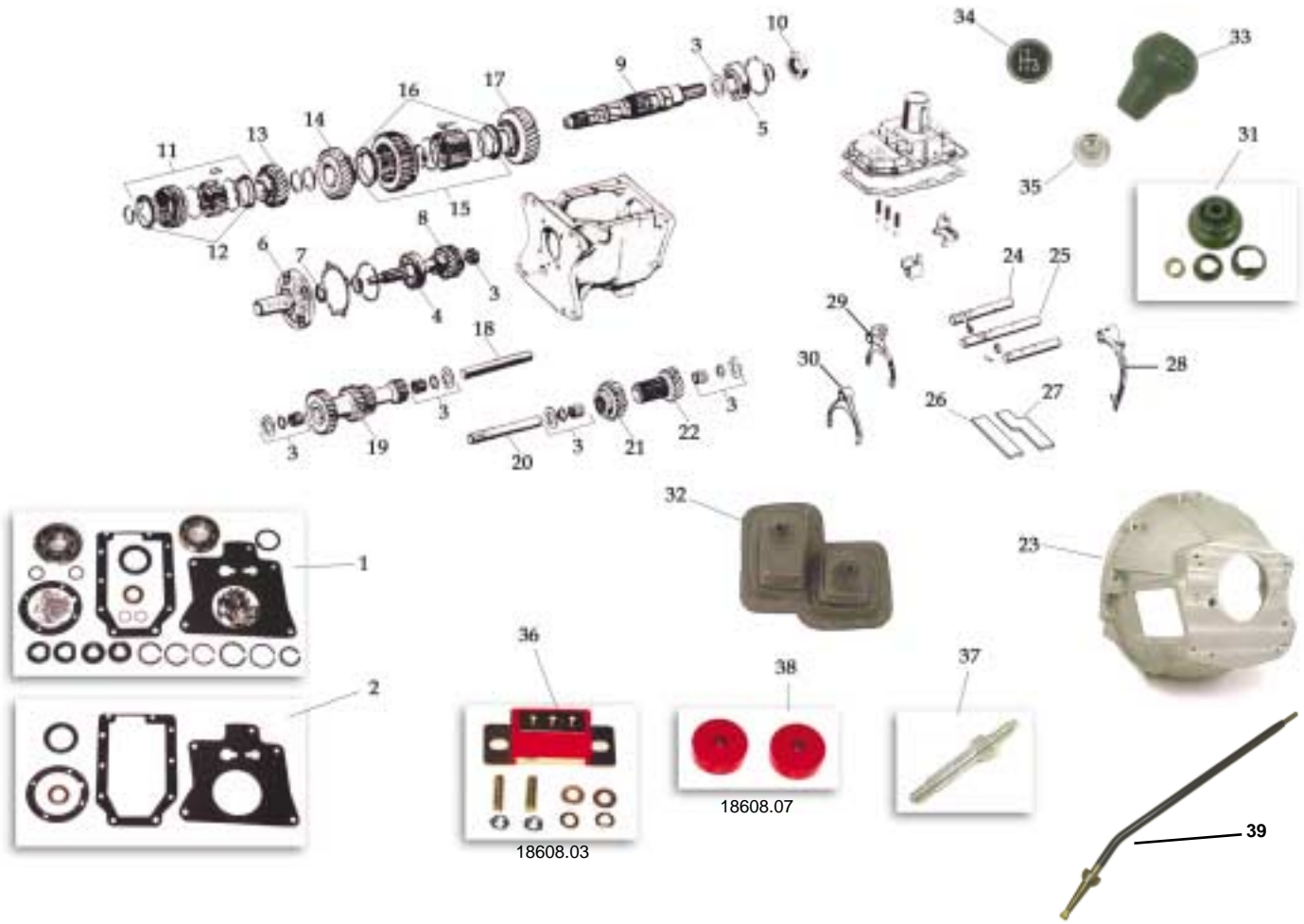

HARD PARTS

ITEM #	DESCRIPTION	Stock No.	Replaces	ITEM #	DESCRIPTION	Stock No.	Replaces
1	OVERHAUL REPAIR KIT INCLUDES FRONT & REAR BEARINGS, GASKETS AND SEALS KIT, SMALL PARTS KIT (ITEMS 2,3,4,5)	18801.05	T-176BSG	18	COUNTER SHAFT	18884.17	8132397
2	GASKETS & SEALS KIT	18804.05	T-170GS	19	CLUSTER GEAR, COUNTERSHAFT: 34X27X25X15 TEETH COUNT	18884.18	8132393
3	SMALL PARTS KIT	18805.05	T-170		31X24X23X15 TEETH COUNT	18884.19	8132392
4	BEARING, TRANSMISSION FRONT (FOR INPUT SHAFT)	18884.01	8132426	20	SHAFT, REVERSE IDLER	18884.20	8132391
5	BEARING, TRANSMISSION REAR (FOR MAINSHAFT)	18884.02	8132431	21	GEAR, REVERSE SLIDING	18884.21	8132398
6	RETAINER, INPUT SHAFT	18884.03	8132372	22	GEAR, REVERSE IDLER	18884.22	8132402
7	OIL SEAL, MAIN DRIVE RETAINER	18881.03	8133528	23	BELLHOUSING 6 & 8 CYL.	18884.23	8132399
8	INPUT SHAFT: T176 WITH 20 TEETH COUNT	18884.04	8132369	24	SHIFTER RAIL, 1ST & 2ND GEAR	16916.01	8133951
	T177 WITH 19 TEETH COUNT	18884.05	8132401	25	SHIFTER RAIL, 3RD & 4TH GEAR	18884.24	8132408
9	MAINSHAFT	18884.06	8132374	26	SHIFTER RAIL PLATE, FRONT	18884.25	8132409
10	OIL SEAL, REAR MAINSHAFT	18676.02	5359457	27	SHIFTER RAIL PLATE, REAR	18884.26	8132415
11	SYNCHRONIZER ASM, 3RD & 4TH (INCLUDES BLOCKING RINGS)	18884.08	8132376	28	SHIFTER RAIL PLATE, REAR	18884.27	8132416
12	BLOCKING RING, 3-4 SYNCHRONIZER (2 NEEDED)	18883.10	8132381	29	SHIFT FORK, REVERSE GEAR	18884.28	8132413
13	3RD SPEED GEAR: T176 WITH 23 TEETH COUNT	18884.10	8132379	30	SHIFT FORK, 1-2 GEAR	18884.29	8134429
	T177 WITH 22 TEETH COUNT	18884.11	8132429	31	SHIFT FORK, 3-4 GEAR	18884.30	8132412
14	2ND SPEED GEAR: T176 WITH 33 TEETH COUNT	18884.12	8132382	32	SHIFTER REPAIR KIT	18884.31	8132412
	T177 WITH 32 TEETH COUNT	18884.13	8132384	33	SHIFTER REPAIR KIT	18884.32	SLR-176K
15	SYNCHRONIZER ASSEMBLY 1ST & 2ND (WITH BLOCKING RING)	18884.14	8132386	34	SHIFTER BOOT (DOUBLE NIPPLE)	18606.05	5752141
16	BLOCKING RING, 1ST & 2ND (2 NEEDED)	18883.10	8132381	35	SHIFT KNOB (W/O SHIFT PATTERN PLATE)	18607.05	4006495
16A	BLOCKING RING KIT 4 PCS. (2 X 1-2 & 2 X 3-4)	18884.15	8132378	36	SHIFT KNOB LOWER KNOB	18608.02	1370910
17	1ST SPEED GEAR	18884.16	8132389	37	TRANSMISSION MOUNT	18608.03	7-1604
				38	POLYURETHANE TRANSMISSION MOUNT, RED	18608.04	7-1604BL
				39	POLYURETHANE TRANSMISSION MOUNT, BLACK	18608.05	5358879
					STABILIZER STUD, TRANSMISSION MOUNT	18608.06	945266
					STABILIZER BUSHING (2 NEEDED)	18608.07	1-1201
					POLYURETHANE STABILIZER BUSHING PAIR, RED	18608.08	1-1201BL
					POLYURETHANE STABILIZER BUSHING PAIR, BLACK	18884.37	5359835
					SHIFTER LEVER		

WARNER T4 4 SPEED

1982-86 CJ

ITEM #	DESCRIPTION	Stock No.	Replaces
2	OVERHAUL REPAIR KIT INCLUDES FRONT & REAR BEARINGS, GASKET (SILICONE) & SEALS KIT, SMALL PARTS KIT	18801.06	T4BSG
3	SILICON TUBE (TO BE USED AS GASKET)	19201.01	8993317
4	SMALL PARTS KITS	18805.07	T5-50-MK
5	BEARING & CUP, TRANSMISSION FRONT (FOR INPUT SHAFT)	16536.15	8134015
6	BEARING & CUP, TRANSMISSION REAR (FOR MAINSHAFT)	18885.01	8134030
7	RETAINER, FRONT INPUT SHAFT	18885.02	8134013
8	OIL SEAL, MAIN DRIVE RETAINER	18885.03	8132779
9	INPUT SHAFT (4TH GEAR): 21 TEETH WITH 10 SPLINE CLUTCH DISC 21 TEETH WITH 14 SPLINE CLUTCH DISC	18885.04 18885.05	83500975 83500968
10	MAINSHAFT (INCLUDES 1ST & 2ND GEAR SYNCHRONIZER) FOR USE WITH MODEL W/O 1ST GEAR NEEDLE BEARING FOR USE WITH MODEL W/ 1ST GEAR NEEDLE BEARING	18885.06 18885.07	83501166
11	OIL SEAL, REAR OUTPUT SHAFT	18885.08	8132672
12	SYNCHRONIZER ASM, 3RD & 4TH	18885.09	83500966
13	BLOCKING RING, 3-4 SYNCHRONIZER (2 NEEDED)	18885.10	8134170
14	3RD SPEED GEAR: 27 TEETH COUNT 29 TEETH COUNT	18885.11 18885.12	83500380 83500285

ITEM #	DESCRIPTION	Stock No.	Replaces
15	2ND SPEED GEAR (31 TEETH COUNT)	18885.13	8134024
16	BLOCKING RING, 1ST & 2ND SYNCHRONIZER (2 NEEDED)	18885.14	8127402
17	1ST GEAR 32 TEETH COUNT, FOR USE W/NEEDLE BEARING STYLE	18885.15	TBA
18	CLUSTER GEAR KIT (INCLUDES 27 TEETH THIRD GEAR)	18885.16	83500970K
19	FRONT CLUSTER GEAR BEARING	18885.18	8134033
20	REAR CLUSTER GEAR BEARING	16536.22	8134036
21	REVERSE SLIDING GEAR	18885.24	1352-070-044
22	SHAFT, REVERSE IDLER	18885.25	8134039
23	GEAR, REVERSE IDLER WITH BUSHING	18885.26	8134038
24	BELLHOUSING (1980-86 CJ) 6 OR 8 CYL.	16916.02	3236287
25	SHIFTER BOOT	18806.03	5752010
26	SHIFT KNOB (W/O SHIFT PATTERN PLATE)	18607.03	3241062
27	SHIFT PATTERN PLATE (FOR ABOVE SHIFT KNOB)	18884.33	3241067
28	SHIFT KNOB LOWER KNOB	18607.05	4006495
29	TRANSMISSION MOUNT	18608.02	1370910
29	POLYURETHANE TRANSMISSION MOUNT, RED	18608.03	7-1604
29	POLYURETHANE TRANSMISSION MOUNT, BLACK	18608.04	7-1604BL
30	STABILIZER STUD, TRANSMISSION MOUNTING	18608.05	5358879
31	STABILIZER BUSHING (2 NEEDED)	18608.06	945266
31	POLYURETHANE STABILIZER BUSHING PAIR, RED	18608.07	1-1201
31	POLYURETHANE STABILIZER BUSHING PAIR, BLACK	18608.08	1-1201BL
32	TRANSMISSION MOUNT SHIFTER BOOT	18885.30	8134064
36	SHIFTER LEVER KIT W / CLIP & INSULATOR, FOR 1980-86 CJ W / T4 OR T5 TRANSMISSION	18885.31	5363538K
	SHIFTER HANDLE CLIP, FOR 1980-86 CJ W / T4 OR T5 TRANS.	18885.32	3241239
	SHIFTER HANDLE INSULATOR, FOR T4 OR T5 TRANSMISSION	18885.33	3241481
	SHIFTER LEVER, FOR 1980-86 CJ W / T4 OR T5 TRANSMISSION	18885.34	5363538

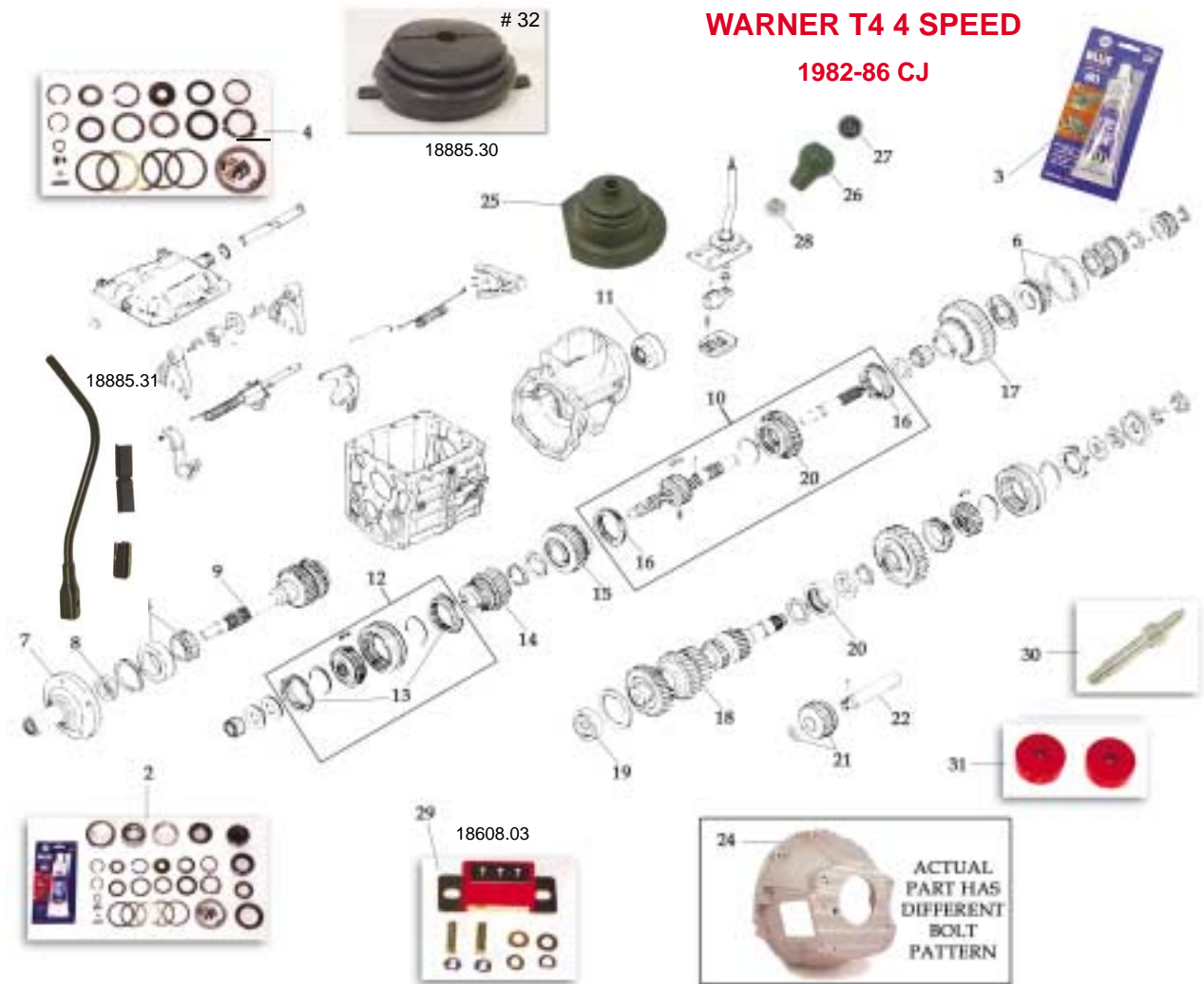

WARNER T4 4 SPEED

1982-86 CJ

HARD PARTS

WARNER T5 5 SPEED

1982-86 CJ

ITEM #	Stock No.	Replaces	DESCRIPTION
2	18806.07	T5BSG	OVERHAUL REPAIR KIT INCLUDES FRONT & REAR BEARINGS, GASKETS AND SEALS KIT, SMALL PARTS KITS (ITEMS 3, 4, 5, 6, 8, 11, 19, 20)
3	19201.01	8993317	SILICONE TUBE (TO BE USED AS GASKET)
4	18805.07	TS-50-MK	SMALL PARTS KIT
5	16536.15	8134015	BEARING & CUP, TRANSMISSION FRONT (FOR INPUT SHAFT)
6	18885.01	8134030	BEARING & CUP, TRANSMISSION REAR (FOR MAINSHAFT)
7	18885.02	8134013	RETAINER, FRONT INPUT SHAFT
8	18885.03	8132779	OIL SEAL, MAIN DRIVE RETAINER
9			INPUT SHAFT (4TH GEAR)
10	18885.06	83501166	MAINSHAFT (INCLUDES 1ST & 2ND GEAR SYNCHRONIZER) FOR USE ON MODEL WITHOUT 1ST GEAR NEEDLE BEARING
11	18885.08	83500963	FOR USE ON MODEL WITH 1ST GEAR NEEDLE BEARING
12	18885.09	83500966	SYNCHRONIZER ASM, 3RD & 4TH
13	18885.10	8134170	BLOCKING RING, 3-4 SYNCHRONIZER (2 NEEDED)
14			3RD SPEED GEAR
15	18885.11	83500380	27 TEETH COUNT
16	18885.12	83500285	29 TEETH COUNT
17	18885.13	8134024	2ND SPEED GEAR 31 TEETH COUNT
18	18885.14	8127402	BLOCKING RING, 1ST & 2ND (2 NEEDED)

ITEM #	DESCRIPTION	Stock No.	Replaces
17	1ST GEAR 32 TEETH COUNT FOR USE WITH NEEDLE BEARING STYLE TRANS.	18885.15	TBA
18	CLUSTER GEAR KIT (INCLUDES 27 TEETH THIRD GEAR)	18885.17	83500967K
19	FRONT CLUSTER GEAR BEARING	18885.19	8134071
20	REAR CLUSTER GEAR BEARING	16536.22	8134036
21	5TH GEAR COUNTERSHAFT		
22	53 TEETH COUNT	18885.20	8134083
23	51 TEETH COUNT	18885.21	8134084
24	5TH GEAR SYNCHRONIZER ASM.	18885.22	8134086
25	BLOCKING RING FOR 5TH SYNCHRONIZER	18885.23	8127414
26	REVERSE SLIDING GEAR	18885.24	1352-070-044
27	SHAFT, REVERSE IDLER	18885.25	8134039
28	GEAR, REVERSE IDLER WITH BUSHING	18885.26	8134038
29	BELLHOUSING (1980-86 CJ), 6-CYL OR 8-CYL	16916.02	3236287
30	SHIFTER BOOT	18806.03	5752010
31	SHIFT KNOB (W/O SHIFT PATTERN PLATE)	18607.03	3241062
32	SHIFT PATTERN (FOR ABOVE SHIFT KNOB)	18885.28	3241073
33	SHIFT KNOB LOWER KNOB	18607.05	4006495
34	TRANSMISSION MOUNT	18608.02	1370910
35	POLYURETHANE TRANSMISSION MOUNT, RED	18608.03	7-1604
36	POLYURETHANE TRANSMISSION MOUNT, BLACK	18608.04	7-1604BL
37	STABILIZER STUD, TRANSMISSION MOUNT	18608.05	5358879
38	STABILIZER BUSHING (2 NEEDED)	18608.06	945266
39	POLYURETHANE STABILIZER BUSHING PAIR, RED	18608.07	1-1201
40	POLYURETHANE STABILIZER BUSHING PAIR, BLACK	18608.08	1-1201BL
41	TRANSMISSION MOUNTED SHIFTER BOOT	18885.30	8134064
42	SHIFTER LEVER KIT W / CLIP & INSULATOR, FOR 1980-86 CJ W / T4 OR T5 TRANSMISSION	18885.31	5363538K
43	SHIFTER HANDLE CLIP, FOR 1980-86 CJ W / T4 OR T5 TRANSMISSION	18885.32	3241239
44	SHIFTER HANDLE INSULATOR, FOR T4 OR T5 TRANSMISSION	18885.33	3241481
45	SHIFTER LEVER, FOR 1980-86 CJ W / T4 OR T5 TRANSMISSION	18885.34	5363538

HARD PARTS

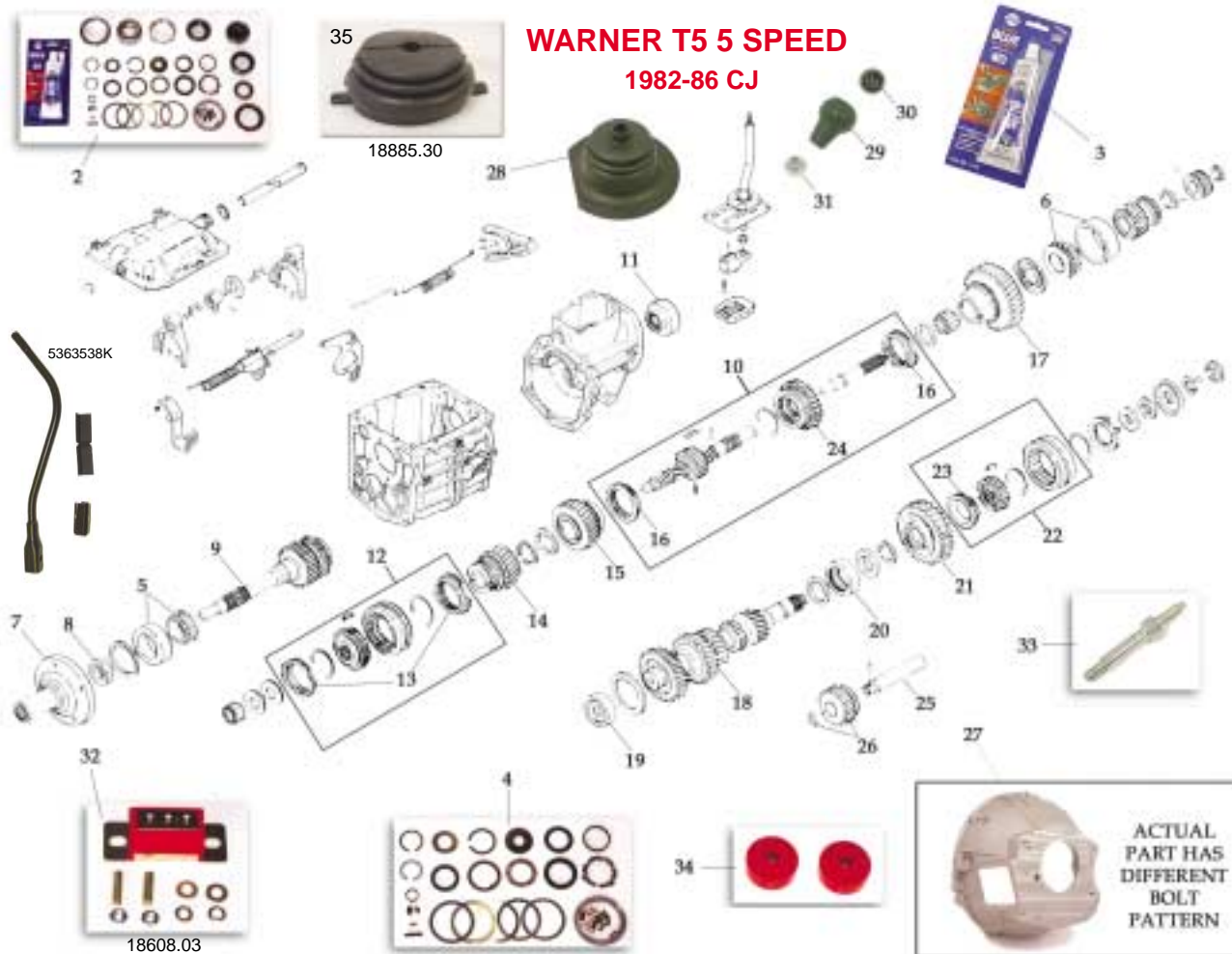

WARNER T5 5 SPEED
1982-86 CJ



AISIN AX4 & AX5 1987-02 4 CYL. WRANGLER (YJ & TJ) & 1984-02 XJ CHEROKEE

ITEM #	DESCRIPTION	Stock No.	Replaces
1	OVERHAUL KIT BEARINGS & SEALS KIT 1984-87 AX5 ONLY	18806.08	BK-AX5E
1	OVERHAUL KIT BEARINGS & SEALS KIT 1987-99 AX5 ONLY	18806.09	BK-AX5L
2	BACKUP LAMP SWITCH 1987-99	18886.01	83500629
3	FRONT BEARING RETAINER 1984-96 (EXCEPT DIESEL MODELS)	18886.02	83503112
3	FRONT BEARING RETAINER 1997-02 4WD	18886.03	4746025
4	FRONT BEARING RETAINER SEAL 1984-02	18886.04	83506045
5	REAR ADAPTER OUTPUT SEAL 1984-02	18886.05	83503108
6	FRONT INPUT SHAFT BEARING 1984-85 XJ CHEROKEE	18886.06	83500643
6	FRONT INPUT SHAFT BEARING 1986-02	18886.07	83502681
7	INPUT SHAFT 1984-85 XJ CHEROKEE	18886.08	83500554
7	INPUT SHAFT 1986 TO NOV-5-1988 2.5L (EXCEPT DIESEL)	18886.09	83502682
7	INPUT SHAFT NOV-5-1988 TO 2002	18886.10	83506020
8	3RD & 4TH SYNCHRONIZER RING (NEED 2) 1984-02	18886.11	83500566
9	INPUT SHAFT NEEDLE BEARING (NEED 14) 1984-02	18886.12	83502680
10	3RD & 4TH SYNCHRONIZER SPRING (NEED 2) 1984-99	18886.13	83500568
11	3RD & 4TH SYNCHRONIZER HUB 1984 TO NOV-5-1988	18886.14	83500562
11	3RD & 4TH SYNCHRONIZER HUB NOV-5-1988 TO 2002	18886.15	83506027
12	3RD & 4TH SYNCHRONIZER KEY PLATE 1984 TO NOV-5-1988	18886.16	83500565
12	3RD & 4TH SYNCHRONIZER KEY PLATE NOV-5-1988 TO 1999	18886.17	83506029
13	3RD & 4TH SYNCHRONIZER SLEEVE 1984 TO NOV-5-1988	18886.18	83500563
13	3RD & 4TH SYNCHRONIZER SLEEVE NOV-5-1988 TO 1996	18886.19	83506028
13	3RD & 4TH SYNCHRONIZER SLEEVE 1997-02	18886.20	4740235
14	3RD SPEED GEAR 1984 TO NOV-5-88	18886.21	83500552
14	3RD SPEED GEAR NOV-5-1988 TO 2002	18886.22	83506019
15	3RD SPEED GEAR NEEDLE BEARING 1984-02	18886.23	83500576
16	MAINSHAFT 4WD 1984-02	18886.24	83503105
17	MAINSHAFT 1ST GEAR PIN	18886.25	83506008
18	2ND SPEED GEAR NEEDLE BEARING 1987-02 YJ & TJ, 1984-96 XJ	18886.26	83500577
19	2ND SPEED GEAR 1984 TO NOV-5-1988	18886.27	83500551
19	2ND SPEED GEAR NOV-5-1988 TO 2002	18886.28	83506018
20	1ST & 2ND SYNCHRONIZER RING (NEED 2) 1984-02	18886.29	83500567
20	1ST & 2ND SYNCHRONIZER SPRING (NEED 2) 1984-99	18886.30	83500569
21	1ST & 2ND SYNCHRONIZER HUB 1984-02	18886.31	83500561
22	1ST & 2ND SYNCHRONIZER KEY PLATE 1984-02	18886.32	83500564
23	REVERSE GEAR 1987-98 WRANGLER & 1984-97 XJ	18886.33	83500555
23	REVERSE GEAR 1999 WRANGLER, 1998-02 XJ CHEROKEE	18886.34	4897101AA
24	1ST SPEED GEAR 1984 TO NOV-5-1988	18886.35	83500550
24	1ST SPEED GEAR NOV-5-1988 TO 2002	18886.36	83506017
25	1ST GEAR NEEDLE BEARING 1984 TO NOV-5-1988	18886.37	83500578
25	1ST GEAR NEEDLE BEARING NOV-5-1988 TO 2002	18886.38	83506031
26	1ST GEAR RACE 1984 TO NOV-5-1988	18886.39	83500560
26	1ST GEAR RACE NOV-5-1988 TO 2002	18886.40	83506026
27	MAINSHAFT REAR BEARING 1984 TO NOV-5-1988	18886.41	83500575
27	MAINSHAFT REAR BEARING NOV-5-1988 TO 2002	18886.42	83506030
28	FIFTH GEAR (MAIN SHAFT SIDE) NOV-5-1988 TO 2002	18886.43	83500971
29	REVERSE IDLER GEAR 1987-98 WRANGLER, 1984-97 XJ CHEROKEE	18886.44	83503555
29	REVERSE IDLER GEAR 1998-02	18886.45	4897102AA
30	REVERSE IDLER SHAFT 1984-99	18886.46	83500570
31	CLUSTER GEAR FRONT BEARING 1984-02	18886.47	83506032

ITEM #	DESCRIPTION	Stock No.	Replaces
32	CLUSTER GEAR (NUT TYPE) 1984 TO NOV-5-1988	18886.48	83500557
32	CLUSTER GEAR 1989-99 WRANGLER, 1989-97 XJ	18886.49	83506023
32	CLUSTER GEAR 1998-02 XJ CHEROKEE	18886.50	4897103AA
	CLUSTER GEAR NUT 1984 TO NOV-5-1988	18886.51	83500572
33	CLUSTER GEAR BEARING SNAP RING	18886.52	83500612
34	CLUSTER GEAR REAR BEARING 1984 TO NOV-5-1988	18886.53	83500580
34	CLUSTER GEAR REAR BEARING NOV-5-1988 TO 2002	18886.54	83506033
35	CLUSTER GEAR THRUST WASHER	18886.55	83506225
36	FIFTH GEAR NEEDLE BEARING 1987-02	18886.56	83500644
37	FIFTH GEAR (CLUSTER GEAR SIDE) 1987-99	18886.57	83506022
38	FIFTH GEAR SYNCHRONIZER KEY PLATE (NEED 3) 1987-99	18886.58	83500641
39	FIFTH GEAR SYNCHRONIZER SPRING (NEED 2) 1987-99	18886.13	83500568
40	FIFTH GEAR SYNCHRONIZER SLEEVE 1988-93	18886.60	83500642
40	FIFTH GEAR SYNCHRONIZER SLEEVE 1994-99	18886.61	4746657
41	FIFTH GEAR SYNCHRONIZER RING 1988-93	18886.11	83500566
42	FIFTH GEAR SPACER GEAR 1988-02	18886.63	83506024
43	REVERSE SHIFT FORK 1984-99	18886.64	83500526
44	REVERSE SHIFT ARM 1984-99	18886.65	TBA
45	1ST & 2ND SHIFT FORK 1986-89	18886.66	83502662
45	1ST & 2ND SHIFT FORK 1990-99	18886.67	83502665
46	3RD & 4TH GEAR SHIFT FORK 1984-02	18886.68	4740236
47	5TH GEAR SHIFT FORK 1987 TO APRIL-1-1993	18886.69	83500637
47	5TH GEAR SHIFT FORK 1993-02	18886.70	4746656
48	REAR REVERSE GEAR SHIFT SHAFT 1984-02	18886.71	83500536
49	1ST & 2ND GEAR SHIFT SHAFT 1984-99	18886.72	83506055
50	3RD & 4TH GEAR SHIFT SHAFT 1987-99 AX5	18886.73	83506047
51	FRONT REVERSE GEAR SHIFT SHAFT 1984-88 AX4	18886.74	83506053
51	FRONT REVERSE GEAR SHIFT SHAFT 1988-99 AX5	18886.75	83506052
52	5TH GEAR SHIFT SHAFT 1987-02 AX5	18886.76	83500538
53	REVERSE SHIFT HEAD 1984-96	18886.77	83503553
53	REVERSE SHIFT HEAD 1997-99	18886.78	4746658
54	SHIFT LEVER SHAFT	18886.79	83500514
55	REVERSE RIGHT HAND SHIFT PIN	18886.80	83500515
56	REVERSE LEFT HAND SHIFT PIN	18886.81	83500516
57	REVERSE BALL	18886.82	83500573
58	OIL FILLER PIPE	18886.83	83500646
59	SHIFT ARM SHOE	18886.84	83503552
60	GEAR SHIFT BOOT, TRANSMISSION MOUNTED 1987-99	18886.85	83500520
61	SHIFT CUP BUSHING 1987-99	18886.86	83500519
62	SHIFT COVER GASKET 1987-99	18886.87	83500521
64	TRANSMISSION MOUNT 1987-95 YJ WRANGLER	18608.09	52002625
64	TRANSMISSION MOUNT 1997-99 TJ WRANGLER	18608.10	52058551
64	TRANS. MOUNT 1997-02 TJ WRANGLER POLYURETHANE, RED	18608.11	1-1601
64	TRANS. MOUNT 1997-02 TJ WRANGLER POLYURETHANE, BLACK	18608.12	1-1601BL
64	TRANSMISSION MOUNT 1987-96 XJ CHEROKEE	19005.03	52001180
	GASKET KIT, AX5 & AX15	18804.06	AX-GS

AISIN AX4 & AX5 1987-02 4 CYL. WRANGLER (YJ & TJ) & 1984-02 XJ CHEROKEE

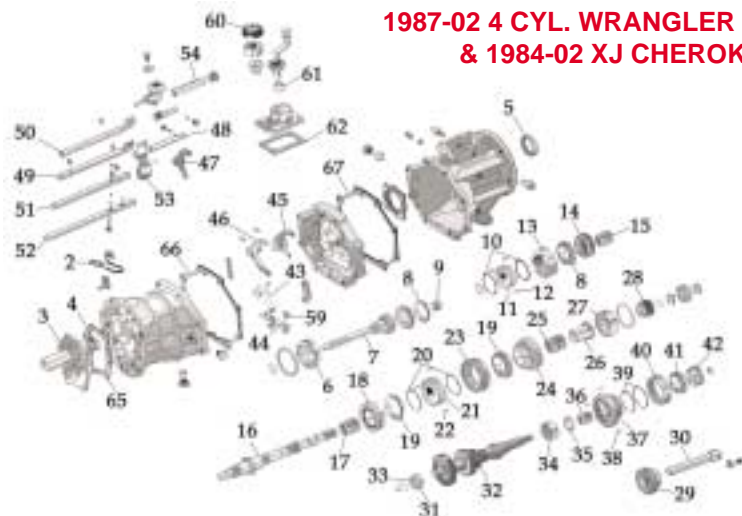

18806.09



**AISIN AX 15
1987-99 6 CYL. WRANGLER (YJ & TJ)**

ITEM #DESCRIPTION	Stock No.	Replaces
1 OVERHAUL BEARING & SEAL KIT 1987-99	18806.10	BK-AX15
2 BACKUP LAMP SWITCH	18886.01	83500629
3 FRONT BEARING RETAINER, 1987-91	18887.01	5252052
3 FRONT BEARING RETAINER, 1992-93	18887.02	4636367
3 FRONT BEARING RETAINER, 1997-98	18887.03	4636382
4 FRONT BEARING RETAINER OIL SEAL 1987-99	18887.04	5252053
5 REAR ADAPTER OIL SEAL (4WD MODELS ONLY) 1987-99	18886.05	83503108
6 INPUT SHAFT (FRONT) BEARING 1987-99	18887.06	83506074
7 INPUT SHAFT 1987-91	18887.07	5252081
7 INPUT SHAFT 1992-97	18887.08	4636370
7 INPUT SHAFT 1998-99	18887.09	4897048AA
8 INPUT SHAFT ROLLER BEARING	18887.10	83506078
9 3RD-4TH GEAR SYNCHRONIZER RING (NEED 2) 1987-99 WRANGLER, 1987-97 XJ	18887.11	83506253
9 3RD-4TH GEAR SYNCHRONIZER RING (NEED 2) 1998-99 XJ	18887.12	4897052AA
10 3RD-4TH GEAR SYNCHRONIZER SPRING (NEED 2) 1987-99	18887.13	83506255
11 3RD-4TH GEAR SYNCHRONIZER HUB 1987-99	18887.14	83506248
12 3RD-4TH GEAR SYNCHRONIZER KEY PLATE (NEED 3) 1987-99	18887.15	83506251
13 3RD-4TH GEAR SYNCHRONIZER SLEEVE 1987-97	18887.16	83506249
13 3RD-4TH GEAR SYNCHRONIZER SLEEVE 1998-99	18887.17	4897050AA
14 3RD SPEED GEAR 1987-97	18887.18	5252079
14 3RD SPEED GEAR 1998-99	18887.19	4897047AA
15 3RD SPEED GEAR NEEDLE BEARING 1987-99	18887.20	83506077
16 MAINSHAFT, 4WD MODELS ONLY (16-1/8" LONG) 1987-99	18887.21	83506243
17 MAINSHAFT FIRST GEAR SPACER 1987-99	18887.22	83506280
18 2ND SPEED GEAR NEEDLE BEARING 1987-99	18886.23	83500576
19 2ND SPEED GEAR 1987-91	18887.24	5252078
19 2ND SPEED GEAR 1992-99	18887.25	4636369
20 1ST-2ND SPEED GEAR SYNCHRONIZER RING (NEED 2) 1987-99	18887.26	83506252
21 1ST-2ND SPEED GEAR SYNCHRONIZER SPRING (NEED 2) 1987-99	18887.27	83506254
22 1ST-2ND SPEED GRAR SYNCHRONIZER HUB 1987-99	18887.28	83506247
23 1ST-2ND SPEED GREAR SYNCHRONIZER PLATE (NEED 3) 1987-99	18887.29	83506250
24 REVERSE GEAR 1987-99	18887.30	5252082
25 FIRST SPEED GEAR, 1987-91	18887.31	5252077
25 FIRST SPEED GEAR, 1992-99	18887.32	4636368
26 FIRST GEAR NEEDLE BEARING 1987-99	18887.33	83506075
27 FIRST GEAR THRUST WASHER 1987-99	18887.34	83506246
28 MAINSHAFT REAR BEARING 1987-95	18887.35	83506073
29 5TH GEAR (MAINSHAFT SIDE) 1987-99	18887.36	5252083
30 REVERSE IDLER GEAR 1987-99	18887.37	5252084
31 REVERSE IDLER SHAFT 1987-99	18887.38	83506258
32 CLUSTER GEAR 1987-91	18887.39	5252085
32 CLUSTER GEAR 1992-99	18887.40	4636371
33 CLUSTER GEAR FRONT BEARING 1987-99	18887.41	83506259
34 CLUSTER GEAR FRONT BEARING SNAP RING	18887.42	83506220
35 CLUSTER GEAR REAR BEARING 1987-99	18887.43	83506080
36 CLUSTER GEAR REAR THRUST WASHER	18887.44	83506245
37 5TH GEAR NEEDLE BEARING 1987-99	18887.45	83506079

ITEM #	DESCRIPTION	Stock No.	Replaces
38	5TH GEAR (CLUSTER GEAR SIDE) 1987-92 =5252080 (BEFORE SERIAL#00705124)	18887.48	4637535
38	5TH GEAR (CLUSTER GEAR SIDE) 1992-99 (FROM SERIAL#00705124)	18887.49	4637527
39A	5TH GEAR (CLUSTER SIDE) SPACER	18887.50	83506242
39	FIFTH GEAR SYNCHRONIZER KEY PLATE (NEED 3) 1987-92 (BEFORE SERIAL#00705124)	18887.51	83506256
39	FIFTH GEAR SYNCHRONIZER KEY PLATE (NEED 3) 1992-99 (FROM SERIAL#00705124)	18887.52	4637532
40	FIFTH GEAR SYNCHRONIZER SLEEVE 1987-99	18887.53	83506257
41	FIFTH GEAR SYNCHRONIZER SPRING (NEED 2) 1987-92 (BEFORE SERIAL#00705124)	18887.27	83506254
41	FIFTH GEAR SYNCHRONIZER SPRING (NEED 2) 1992-99 (FROM SERIAL #00705124)	18887.55	4637534
42	FIFTH GEAR SYNCHRONIZER RING 1987-92 (BEFORE SERIAL#00705124)	18887.11	83506253
42	FIFTH GEAR SYNCHRONIZER RING 1992-99 (FROM SERIAL #00705124)	18887.57	4637533
43	REVERSE SHIFT FORK	18887.58	5252056
44	REVERSE SHIFT ARM	18887.59	5252060
45	FRONT REVERSE GEAR SHIFT SHAFT	18887.60	5252070
46	5TH GEAR SHIFT SHAFT	18887.61	5252071
47	REVERSE SHIFT HEAD	18887.62	5252064
48	5TH GEAR SHIFT FORK	18887.63	5252059
49	REAR REVERSE GEAR SHIFT SHAFT	18887.64	3252065
50	3RD & 4TH GEAR SHIFT SHAFT	18887.65	5252068
51	1ST & 2ND SHIFTING FORK	18887.66	5252057
52	3RD & 4TH SHIFTING FORK	18887.67	5252058
53	SHIFT ARM SHOE	18887.68	5252062
54	BRACKET SHIFTING	18887.69	5252063
55	GEAR SHIFTING SHAFT	18887.70	5252066
56	SHAFT SHIFT LEVER	18887.71	5252037
57	PIN, REVERSE RIGHT HAND	18887.72	5252039
58	RETAINER CLIP 1.5mm	18887.73	5252076
59	DRAIN PLUG	18887.74	83500512
60	ROLLER	18887.75	83500541
61	BALL	18887.76	83500542
62	ROLLER	18887.77	83500543
63	RING RETAINER	18887.78	83500548
64	BALL, REVERSE	18886.82	83500573
65	HOUSING PLUG	18887.80	83500619
65	HOUSING PLUG	18887.81	83503109
66	GEAR SHIFT BOOT (MOUNTS ON TRANSMISSION)	18886.89	83500505
67	SHIFT COVER GASKET	18886.87	83500521
68	SHIFT CUP BUSHING	18886.86	83500519
70	SHIFTER KNOB WITH SHIFTING PATTERN	18887.82	TBA
71	TRANSMISSION MOUNT 1987-95 YJ WRANGLER	18608.09	52002625
71	TRANSMISSION MOUNT 1997-99 TJ WRANGLER	18608.10	52058551
71	TRANS MOUNT, 19971-01 TJ WRANGLER POLYURETHANE, RED	18608.11	1-1601
71	TRANS MOUNT, 19971-01 TJ WRANGLER POLYURETHANE, BLACK	18608.12	1-1601BL
	GASKET KIT, AX5 & AX15	18804.06	AX-GS

HARD PARTS

**AISIN AX 15
1987-99 6 CYL. WRANGLER (YJ & TJ)**

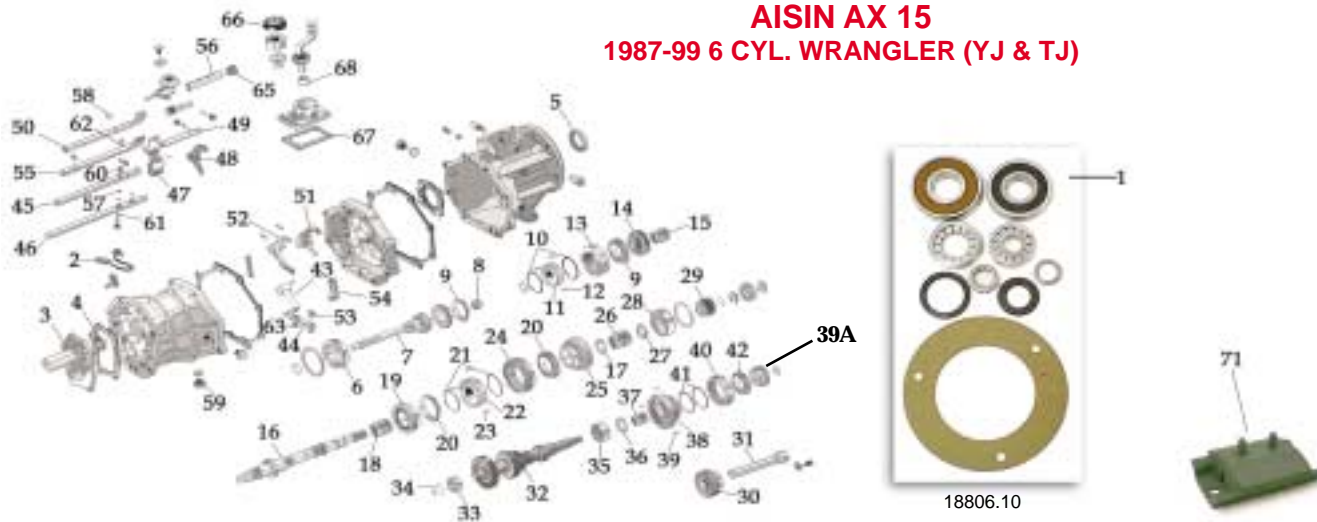

PEUGEOT BA 10/5 5 SPEED 1987-90 YJ WRANGLER & XJ CHEROKEE

ITEM #	DESCRIPTION	Stock No.
1	BEARING & OIL SEAL KIT (INCLUDES ALL 7 BEARINGS & 3 OIL SEALS)	18801.11 BK-BA10
2	SILICONE TUBE (TO BE USED AS GASKET)	19201.01 8993317
3	INPUT SHAFT	18888.01 83505205
3	INPUT SHAFT	18888.02 83503229
4	MAINSHAFT	18888.03 83503219
5	SYNCHRONIZER ASM, 1ST & 2ND	18888.04 83504089
6	SYNCHRONIZER ASM, 3RD & 4TH	18888.05 83504103
7	3RD SPEED GEAR	18888.06 83503221
8	2ND SPEED GEAR	18888.07 83503218
9	1ST GEAR 12-32 TEETH COUNT	18888.08 83505444
9	1ST GEAR	18888.09 83503214
10	CLUSTER GEAR	18888.10 83505445
10	CLUSTER GEAR	18888.11 83503239
11	5TH GEAR, INTERMEDIATE	18888.12 83503242
12	5TH GEAR COUNTERSHAFT 53X27 TEETH COUNT (TBA)	18888.13 TBA
13	5TH GEAR SYNCHRONIZER	18888.14 83503246
14	REVERSE GEAR KIT (AS SHOWN IN BLOCK)	18888.15 4762679
15	TRANSMISSION MOUNT (WRANGLER ONLY)	18608.09 52002625
16	STABILIZER STUD, TRANSMISSION MOUNT	18608.05 5358879
17	STABILIZER BUSHING (2 NEEDED)	18608.06 945266
17	POLYURETHANE STABILIZER BUSHING PAIR, RED	18608.07 1-1201
17	POLYURETHANE STABILIZER BUSHING PAIR, BLACK	18608.08 1-1201BL



MISC. TRANSMISSION PARTS FOR T84, T18, T98 & SR4

18806.12



TRANSMISSION MOUNT:

DESCRIPTION	Stock No.
1946-63 WAGON, TRUCK, CJ5 V6	18880.29 8126799



18880.29



18806.13

WARNER T84 3 SPEED:

DESCRIPTION	Stock No.	Replaces
SMALL PARTS KIT	18806.12	T-84
BLOCKING RING,	18889.01	637834
2ND & 3RD SYNCHRONIZER (2 NEEDED)		
FRONT BEARING	18891.02	8127407
REAR BEARING	18880.05	8136619
FRONT BEARING RETAINER	18889.03	640017
MB TRANSMISSION SHIFTER BOOT	18889.04	A-3783
MB TRANSFER CASE SHIFTER BOOT	18889.05	A-3784



18889.05

WARNER T98 4 SPEED:

DESCRIPTION	Stock No.	Replaces
SMALL PARTS KIT	18806.13	T-98
FRONT BEARING, FOR INPUT SHAFT	18882.01	4488141
REAR BEARING, FOR MAINSHAFT	18884.02	8132431
2ND SPEED GEAR	18890.01	912329
COUNTER SHAFT CLUSTER GEAR	18890.02	912344
COUNTER SHAFT	18890.03	940494
3RD & 4TH SYNCHRONIZER ASM.	18890.04	912319
BLOCKING RING, 3RD & 4TH SYNCHRONIZER (2 NEEDED)	18890.05	912324
BLOCKING RING, 1ST & 2ND SYNCHRONIZER	18890.06	912340



18885.23



18891.02



Omix-Ada, Inc.



18806.14

SR4, 1980-81 CJ 4 SPEED:

DESCRIPTION	Stock No.	Replaces
FRONT BEARING	18891.02	8127407
REAR BEARING	18891.02	8127407
BLOCKING RING, 1ST & 2ND SYNCHRONIZER (2 NEEDED)	18885.14	8127402
BLOCKING RING, 3RD & 4TH SYNCHRONIZER (2 NEEDED)	18885.23	8127414
MAINDRIVE	18891.03	8132596
CLUSTER GEAR	18891.04	8132662
SHIFTER BOOT	18806.03	5752010
OIL SEAL, FRONT RETAINER	18881.03	8133528
OIL SEAL, REAR OUTPUT SHAFT	18885.08	8132672
TRANSMISSION MOUNT	18608.02	1370910
POLYURETHANE TRANSMISSION MOUNT, RED	18608.03	7-1604
POLYURETHANE TRANSMISSION MOUNT, BLACK	18608.04	7-1604BL
STABILIZER STUD, TRANSMISSION MOUNT	18608.05	5358879
STABILIZER BUSHING (2 NEEDED)	18608.06	945266
POLYURETHANE STABILIZER BUSHING PAIR, RED	18608.07	1-1201
POLYURETHANE STABILIZER BUSHING PAIR, BLACK	18608.08	1-1201BL

WARNER T18 4 SPEED:

DESCRIPTION	Stock No.	Replaces
SMALL PARTS KIT	18806.14	T-18
FRONT BEARING, FOR INPUT SHAFT	18882.01	4488141
REAR BEARING, FOR MAINSHAFT	18884.02	8132431
OIL SEAL, FRONT INPUT SHAFT	18885.03	8132779
FIRST GEAR, (SYNCHRONIZER OUTER SLEEVE)	18890.20	940500
FRONT RETAINER	18890.21	8126874
3RD GEAR	18890.22	8130254
3RD & 4TH SYNCHRONIZER ASM.:		
ALL EXCEPT TAG #13-01-192, 13-01-193, 13-01-209, 1 301-210	18890.04	912319
FOR TAG #13-01-192, 13-01-193, 13-01-209, 1301-210	18890.23	8130253
BLOCKING RING, 3RD & 4TH SYNCHRONIZER (2 NEEDED) FOR 18890.04	18890.05	912324
FOR 18890.23	18890.25	8130255
REVERSE IDLER GEAR	18890.26	940503
COUNTER SHAFT	18890.03	940494
BLOCKING RING, 1ST & 2ND SYNCHRONIZER	18890.06	912340

CJ WIPER ASSEMBLY



ILLUSTRATION FOR
1976-86
CJ WIPER ASSEMBLY

1968-86 CJ WIPER ASSEMBLY PARTS:

ITEM #	DESCRIPTION	Stock No.	Replaces
1	1968-86 CJ, WIPER PIVOT NUT	19105.01	4005672
2	1968-86 CJ, WIPER PIVOT SPACER	19105.02	5459081
3	1968-86 CJ, WIPER PIVOT GASKET	19105.03	973658
4	1976-86 CJ, LONG WIPER PIVOT	19105.04	5453958
5	1976-86 CJ, WIPER LINKAGE KIT (Kit = #4,5,6, + 2X # 1,2,3,7,18,19)	19105.05	5453958K
6	1976-86 CJ, SHORT WIPER PIVOT	19105.06	5453957
7	1976-86 CJ, WIPER MOTOR LINK	19105.07	5453960
8	1968-86 CJ, WIPER ROD CLIP	19105.08	957868
9	1968-86 CJ, WIPER SWITCH NUT	17234.11	4000056
10	1968-86 CJ, WIPER SWITCH WASHER	17234.12	987911
11	1968-86 CJ, WIPER MOTOR SWITCH KNOB	13318.05	5459189
11	1968-82 CJ, WIPER SWITCH W/ 3 WIRE PLUG MOTOR	19106.01	5460089
11	1983-86 CJ, WIPER SWITCH W/ NON-INTERMITTENT WIPER	19106.02	5758687
11	1983-86 CJ WIPER SWITCH W/ INTERMITTENT WIPER	19106.03	TBA
12	1972-86 WIPER WASHER BOTTLE (CAP NOT INCLUDED)	19107.01	8121741
13	1972-86 CJ, WIPER WASHER BOTTLE CAP	19107.02	4489483
14	1972-86 CJ & SJ, WASHER PUMP	19108.01	8121404
15	1972-86 CJ, WASHER PUMP FILTER	19108.02	8121405
16	1972-86 CJ, WASHER PUMP & FILTER KIT	19108.03	8121404K
17	1972-86 CJ, WASHER BOTTLE ASSY W/ PUMP & FILTER KIT. INCLUDES: BOTTLE, BOTTLE CAP, PUMP & FILTER KIT	19107.03	3211338
18	1968-86 CJ, FRONT WIPER ARM, SHINY	19710.01	5758005
18	1968-86 FRONT WIPER ARM, BLACK	19710.02	5762337
19	1968-86 CJ, FRONT WIPER BLADE, 11"	19712.07	83505426
20	1968-75 CJ, BOTTOM MOUNT WIPER MOTOR	NEW 19715.01	989935
20	1976-83 CJ, WIPER MOTOR W/ 3 WIRE PLUG	NEW 19715.02	5453956
20	1983-86 CJ, WIPER MOTOR W/ 4 WIRE PLUG	NEW 19715.03	5763696
21	1968-75 CJ, WIPER MOTOR COVER, STAINLESS STEEL	11122.01	5756806E
21	1976-86 CJ, WIPER MOTOR COVER, STAINLESS STEEL	11122.02	5756806
21	1976-86 CJ, WIPER MOTOR COVER, BLACK	19135.01	5756806-BL
22	1976-86 CJ, WINDSHIELD WIPER PIVOT PLASTIC COVER (EACH)	13318.02	5459153



HARD PARTS

1941-67 UNIVERSAL WIPER MOTOR KITS:
(KIT INCLUDES: 1 MOTOR, 1 ARM & 1 BLADE)

DESCRIPTION	Stock No.	Replaces
UNIVERSAL WIPER MOTOT KIT, 6 VOLT	19101.01	6V
UNIVERSAL WIPER MOTOT KIT, 12 VOLT	19101.02	12V
UNIVERSAL WIPER MOTOT KIT, 12 VOLT STAINLESS	19101.03	12V-ST
UNIVERSAL WIPER MOTOT KIT, 24 VOLT	19101.04	24V
SPARE WIPER BLADE & ARM KIT	19102.01	WSHA-1K



19101.03



19101.02

WRANGLER, XJ CHEROKEE AND ZJ GRAND CHEROKEE



O.E REPLACEMENT FRONT WIPER MOTORS:

	Stock No.	Replaces
1987-95 YJ WRANGLER	19715.04	TBA
1987-95 YJ WRANGLER WIPER MOTOR	19716.01	56030015
WIPER MOTOR TO WINDSHIELD SEAL		
1991-96 XJ FRONT	19715.05	4723460
1993-96 ZJ FRONT	19715.06	56005181

O.E. REPLACEMENT REAR WIPER MOTORS:

DESCRIPTION	Stock No.	Replaces
1991-95 YJ WRANGLER	19717.01	55154539
1984-90 XJ CHEROKEE REAR WIPER MOTOR	19717.02	56000701
1991-96 XJ CHEROKEE REAR WIPER MOTOR	19717.03	55155317
1993-94 ZJ GRAND CHEROKEE REAR WIPER MOTOR	19717.04	56005194



WIPER ARMS:

DESCRIPTION	Stock No.	Replaces
1987-95 WRANGLER, FRONT WIPER ARM	19710.03	56030012
1987-95 WRANGLER, REAR WIPER ARM	19710.03	56030012
1997-UP TJ WRANGLER, FRONT (EACH)	19710.05	55155658
1997-UP TJ WRANGLER, REAR	19710.06	55155660
1984-96 XJ CHEROKEE, FRONT	19710.07	56001132
1984-96 XJ CHEROKEE, REAR	19710.08	56000598
1993-98 ZJ GRAND CHEROKEE, FRONT	19710.09	55154983AB
1993 ZJ GRAND CHEROKEE, REAR	19710.10	56005195
1994-95 ZJ GRAND CHEROKEE W / O FLIPPER WINDOW	19710.11	55154786
1995 ZJ GRAND CHEROKEE, ALL 1996, W / O FLIPPER WINDOW	19710.12	55154966AB
1997-98 ZJ GRAND CHEROKEE	19710.12	55154966AB
1997-01 XJ CHEROKEE FRONT	19710.13	55155649
1997-01 XJ CHEROKEE REAR	19710.14	55154919

WIPER BLADES:

DESCRIPTION	Stock No.	Replaces
1987-02 WRANGLER, FRONT WIPER BLADE, , 13"	19712.01	83505425
1984-01 XJ CHEROKEE, FRONT BLADE	19712.02	56001133
1993-UP ZJ & WJ GRAND CHEROKEE, FRONT BLADE	19712.03	1119
1987-95 WRANGLER, REAR WIPER BLADE, 16"	19712.04	4389063
1997-02 WRANGLER, REAR	19712.02	56001133
1984-01 XJ CHEROKEE, REAR	19712.05	55000299
1993-01 ZJ, WJ GRAND CHEROKEE, REAR BLADE	19712.05	55000299

WINDSHIELD WASHER PUMPS:

DESCRIPTION	Stock No.	Replaces
1987-89 WRANGLER WASHER PUMP	19108.04	56002053
1990-96 WRANGLER WASHER PUMP	19108.05	5252217
1987-90 XJ CHEROKEE FRONT WASHER PUMP	19108.01	8121404
1991-96 XJ CHEROKEE FRONT WASHER PUMP	19108.06	55154613
1987-96 XJ CHEROKEE REAR WASHER PUMP	19108.01	8121404
1993-98 ZJ GRAND-CHEROKEE WASHER PUMP	19108.05	5252217
1997-01 XJ CHEROKEE REAR WIPER WASHER PUMP	NEW 19108.07	4778348
1997-02 TJ FRONT,REAR WIPER WASHER PUMP	NEW 19108.08	4797695
1997-01 XJ FRONT WIPER WASHER PUMP	NEW 19108.08	4797695



WIPER SWITCHES:

DESCRIPTION	Stock No.	Replaces
1987-95 WRANGLER, MODELS W/O INTERMITTENT AND W/O TILT	17236.01	56000031
1987-95 WRANGLER, MODELS W/ INTERMITTENT	17236.02	56000032
1987-95 YJ WRANGLER WITH TILT COLUMN	NEW 17236.04	56007299
1984-93 XJ CHEROKEE W/O INTERMITTENT & W/O STEERING TILT	17263.01	56000031
1984-96 XJ CHEROKEE, WITH INTERMITTENT & W/O STEERING TILT	17236.02	56000032
1984-93 XJ CHEROKEE MODELS W/O INTERMITTENT & W/ STEERING TILT	17236.03	56000431

Now You Can Order These Great Looking, High Quality, Fully Licensed Jeep® Logo Brand Apparel!

T-SHIRTS:

DESCRIPTION	Stock No.
"AMERICAN LEGEND"	
COLOR: BLUE, SIZE: MEDIUM	14201.05
COLOR: BLUE, SIZE: LARGE	14301.05
COLOR: BLUE, SIZE: X-LARGE	14401.05
COLOR: BLUE, SIZE: XX-LARGE	14501.05
COLOR: OLIVE, SIZE: MEDIUM	14201.70
COLOR: OLIVE, SIZE: LARGE	14301.70
COLOR: OLIVE, SIZE: X-LARGE	14401.70
COLOR: OLIVE, SIZE: XX-LARGE	14501.70
COLOR: GOLD, SIZE: MEDIUM	14201.67
COLOR: GOLD, SIZE: LARGE	14301.67
COLOR: GOLD, SIZE: X-LARGE	14401.67
COLOR: GOLD, SIZE: XX-LARGE	14501.67
COLOR: ORANGE, SIZE: MEDIUM	14201.66
COLOR: ORANGE, SIZE: LARGE	14301.66
COLOR: ORANGE, SIZE: X-LARGE	14401.66
COLOR: ORANGE, SIZE: XX-LARGE	14501.66
COLOR: GREY, SIZE: MEDIUM	14201.09
COLOR: GREY, SIZE: LARGE	14301.09
COLOR: GREY, SIZE: X-LARGE	14401.09
COLOR: GREY, SIZE: XX-LARGE	14501.09
COLOR: WHITE, SIZE: MEDIUM	14201.02
COLOR: WHITE, SIZE: LARGE	14301.02
COLOR: WHITE, SIZE: X-LARGE	14401.02
COLOR: WHITE, SIZE: XX-LARGE	14501.02
COLOR: NATURAL, SIZE: MEDIUM	14201.71
COLOR: NATURAL, SIZE: LARGE	14301.71
COLOR: NATURAL, SIZE: X-LARGE	14401.71
COLOR: NATURAL, SIZE: XX-LARGE	14501.71



"AMERICAN LEGEND", OLIVE SHOWN



"AUTHENTIC JEEP®", GREY SHOWN

T-SHIRTS:

DESCRIPTION	Stock No.
"AUTHENTIC JEEP®"	
COLOR: VINTAGE RED, SIZE: MEDIUM	14203.65
COLOR: VINTAGE RED, SIZE: LARGE	14303.65
COLOR: VINTAGE RED, SIZE: X-LARGE	14403.65
COLOR: VINTAGE RED, SIZE: XX-LARGE	14503.65
COLOR: GREY, SIZE: MEDIUM	14203.09
COLOR: GREY, SIZE: LARGE	14303.09
COLOR: GREY, SIZE: X-LARGE	14403.09
COLOR: GREY, SIZE: XX-LARGE	14503.09



"FLAG JEEP®", WHITE SHOWN



"MUD PUDDLES", BLUE SHOWN

T-SHIRTS:

DESCRIPTION	Stock No.
"MUD PUDDLES"	
COLOR: NATURAL, SIZE: MEDIUM	14205.71
COLOR: NATURAL, SIZE: LARGE	14305.71
COLOR: NATURAL, SIZE: X-LARGE	14405.71
COLOR: NATURAL, SIZE: XX-LARGE	14505.71
COLOR: SAGE, SIZE: MEDIUM	14205.61
COLOR: SAGE, SIZE: LARGE	14305.61
COLOR: SAGE, SIZE: X-LARGE	14405.61
COLOR: SAGE, SIZE: XX-LARGE	14505.61

DESCRIPTION	Stock No.
"FLAG JEEP®"	
COLOR: WHITE, SIZE: MEDIUM	14202.02
COLOR: WHITE, SIZE: LARGE	14302.02
COLOR: WHITE, SIZE: X-LARGE	14402.02
COLOR: WHITE, SIZE: XX-LARGE	14502.02

DESCRIPTION	Stock No.
"TOUGH TRADEMARK"	
COLOR: WHITE, SIZE: MEDIUM	14208.02
COLOR: WHITE, SIZE: LARGE	14308.02
COLOR: WHITE, SIZE: X-LARGE	14408.02
COLOR: WHITE, SIZE: XX-LARGE	14508.02
COLOR: SAGE, SIZE: MEDIUM	14208.61
COLOR: SAGE, SIZE: LARGE	14308.61
COLOR: SAGE, SIZE: X-LARGE	14408.61
COLOR: SAGE, SIZE: XX-LARGE	14508.61



"TOUGH TRADEMARK", GREY SHOWN



"THUMPER", GREY SHOWN

DESCRIPTION	Stock No.
"THUMPER"	
COLOR: GREY, SIZE: MEDIUM	14206.09
COLOR: GREY, SIZE: LARGE	14306.09
COLOR: GREY, SIZE: X-LARGE	14406.09
COLOR: GREY, SIZE: XX-LARGE	14506.09



"WORKWEAR TRUCK", GREY SHOWN



"NOSTALGIA", NAVY INDIGO SHOWN

T-SHIRTS:

DESCRIPTION	Stock No.
"WORKWEAR TRUCK"	
COLOR: NAVY, SIZE: MEDIUM	14212.63
COLOR: NAVY, SIZE: LARGE	14312.63
COLOR: NAVY, SIZE: X-LARGE	14412.63
COLOR: NAVY, SIZE: XX-LARGE	14512.63
COLOR: ORANGE, SIZE: MEDIUM	14212.66
COLOR: ORANGE, SIZE: LARGE	14312.66
COLOR: ORANGE, SIZE: X-LARGE	14412.66
COLOR: ORANGE, SIZE: XX-LARGE	14512.66
COLOR: GREY, SIZE: MEDIUM	14212.09
COLOR: GREY, SIZE: LARGE	14312.09
COLOR: GREY, SIZE: X-LARGE	14412.09
COLOR: GREY, SIZE: XX-LARGE	14512.09



"SURF TEE", GOLD SHOWN



"UNSTOPPABLE", WHITE SHOWN

DESCRIPTION	Stock No.
"SURF TEE"	
COLOR: GOLD, SIZE: MEDIUM	14207.67
COLOR: GOLD, SIZE: LARGE	14307.67
COLOR: GOLD, SIZE: X-LARGE	14407.67
COLOR: GOLD, SIZE: XX-LARGE	14507.67

DESCRIPTION	Stock No.
"TOLEDO SHIELD"	
COLOR: GREY, SIZE: MEDIUM	14209.09
COLOR: GREY, SIZE: LARGE	14309.09
COLOR: GREY, SIZE: X-LARGE	14409.09
COLOR: GREY, SIZE: XX-LARGE	14509.09

DESCRIPTION	Stock No.
"DEPENDABLE POWER"	
COLOR: NAVY, SIZE: MEDIUM	14210.63
COLOR: NAVY, SIZE: LARGE	14310.63
COLOR: NAVY, SIZE: X-LARGE	14410.63
COLOR: NAVY, SIZE: XX-LARGE	14510.63



"TOLEDO SHIELD", GREY SHOWN



"RINGER", GREY SHOWN



"DEPENDABLE POWER", NAVY SHOWN

T-SHIRTS:

DESCRIPTION	Stock No.
"NOSTALGIA"	
COLOR: NAVY INDIGO, SIZE: MEDIUM	14204.63
COLOR: NAVY INDIGO, SIZE: LARGE	14304.63
COLOR: NAVY INDIGO, SIZE: X-LARGE	14404.63
COLOR: NAVY INDIGO, SIZE: XX-LARGE	14504.63
COLOR: OLIVE, SIZE: MEDIUM	14204.70
COLOR: OLIVE, SIZE: LARGE	14304.70
COLOR: OLIVE, SIZE: X-LARGE	14404.70
COLOR: OLIVE, SIZE: XX-LARGE	14504.70
COLOR: NATURAL, SIZE: MEDIUM	14204.71
COLOR: NATURAL, SIZE: LARGE	14304.71
COLOR: NATURAL, SIZE: X-LARGE	14404.71
COLOR: NATURAL, SIZE: XX-LARGE	14504.71
COLOR: ORANGE, SIZE: MEDIUM	14204.66
COLOR: ORANGE, SIZE: LARGE	14304.66
COLOR: ORANGE, SIZE: X-LARGE	14404.66
COLOR: ORANGE, SIZE: XX-LARGE	14504.66
COLOR: GREY, SIZE: MEDIUM	14204.09
COLOR: GREY, SIZE: LARGE	14304.09
COLOR: GREY, SIZE: X-LARGE	14404.09
COLOR: GREY, SIZE: XX-LARGE	14504.09

DESCRIPTION	Stock No.
"UNSTOPPABLE"	
COLOR: WHITE, SIZE: MEDIUM	14213.02
COLOR: WHITE, SIZE: LARGE	14313.02
COLOR: WHITE, SIZE: X-LARGE	14413.02
COLOR: WHITE, SIZE: XX-LARGE	14513.02
COLOR: SAGE, SIZE: MEDIUM	14213.61
COLOR: SAGE, SIZE: LARGE	14313.61
COLOR: SAGE, SIZE: X-LARGE	14413.61
COLOR: SAGE, SIZE: XX-LARGE	14513.61

DESCRIPTION	Stock No.
"RINGER"	
COLOR: GREY, SIZE: MEDIUM	14214.09
COLOR: GREY, SIZE: LARGE	14314.09
COLOR: GREY, SIZE: X-LARGE	14414.09
COLOR: GREY, SIZE: XX-LARGE	14514.09
COLOR: WHITE, SIZE: MEDIUM	14214.02
COLOR: WHITE, SIZE: LARGE	14314.02
COLOR: WHITE, SIZE: X-LARGE	14414.02
COLOR: WHITE, SIZE: XX-LARGE	14514.02

T-SHIRTS:



"BEACHCOMER", WHITE SHOWN



"CJ2A", WHITE SHOWN



DESCRIPTION	Stock No.
"BEACHCOMER"	
COLOR: WHITE, SIZE: MEDIUM	14211.02
COLOR: WHITE, SIZE: LARGE	14311.02
COLOR: WHITE, SIZE: X-LARGE	14411.02
COLOR: WHITE, SIZE: XX-LARGE	14511.02

DESCRIPTION	Stock No.
"CJ2A"	
COLOR: WHITE, SIZE: MEDIUM	14215.02
COLOR: WHITE, SIZE: LARGE	14315.02
COLOR: WHITE, SIZE: X-LARGE	14415.02
COLOR: WHITE, SIZE: XX-LARGE	14515.02

HATS:

DESCRIPTION	Stock No.
"RIP-STOP BUCKET"	
COLOR: SAGE,	14002.61
"COLLEGIATE"	
COLOR: GREEN,	14003.60
COLOR: NAVY,	14003.63
"J41"	
COLOR: SAGE,	14004.61
COLOR: VINTAGE RED,	14004.65
"CONTRAST STITCH"	
COLOR: RED,	14005.64
COLOR: BLACK,	14005.01
"RUGGED FREEDOM"	
COLOR: STONE,	14006.62
"NOSTALGIA"	
COLOR: SAGE,	14007.61
"ORIGINAL PATCH"	
COLOR: STONE,	14008.62
COLOR: NAVY,	14008.63
COLOR: ORANGE,	14008.66
COLOR: GOLD,	14008.67
"VARSITY J"	
COLOR: STONE,	14009.62
"RENEGADE"	
COLOR: GREY,	14010.09
"LEGEND PATCH"	
COLOR: NAVY,	14011.63
COLOR: STONE,	14011.62



DESCRIPTION	Stock No.
"DW 41"	
COLOR: ELECTRIC BLUE,	14012.68
COLOR: CARGO,	14012.69
"FREEDOM CIRCLE"	
COLOR: NAVY,	14013.63
"JEEP"	
COLOR: STONE, IMAGE NOT AVAILABLE	14015.62
COLOR: NAVY,	14015.63
"SMILEY FACE"	
COLOR: SAGE,	14014.61
"OMIX-ADA HAT"	
COLOR:TAN	HAT-OMIX



KEY CHAINS:



>>> NEW <<<

WHEEL SPACER KITS/WHEEL ADAPTER KIT

Spaces your wheels out an extra 1.25" to help fit larger wheels and tires or give your jeep a wider stance and stability.

Constructed of double anodized black extra thick 6061T6 Aluminum for long life and extra corrosion resistance. All bolt hardware is top of the line grade 8 hardware.

Each Wheel spacer kit comes with two wheel spacers, 10 preinstalled grade 8 wheel studs, 10 lug nuts and thread locker.

Wheel spacer adapter kit converts your bolt circle on the hub from a 5" on 4.5" pattern to a 5" on 5.5" pattern.

>>> NEW <<<

DESCRIPTION	Stock No.
1987-06 WRANGLER WHEEL SPACER PAIR (5 x 4.5)	15201.02
1945-86 CJ WHEEL SPACER PAIR KIT (5 x 5.5)	15201.03
1987-06 WRANGLER WHEEL SPACER ADAPTER PAIR KIT (CONVERTING WRANGLER 4.5" PATTERN TO 5.5")	15201.04

All spacers are 1.25 inches wide

>>> NEW <<<



Wheel Spacer Kit
15201.02



Wheel Spacer Kit
15201.03



Wheel Spacer Adapter Kit
15201.04

HEAVY DUTY DIFFERENTIAL COVERS

INDESTRUCTIBLE! Literally, you won't break this cover, we guarantee. If you do, we'll replace it (see warranty terms). Made of 3/8 inch cast steel and painted black inside and out, this heavy duty cover is designed to protect your differential and all its working parts for as long as you own your vehicle. It even has reinforced protection for the fill plug. Includes mounting hardware and instructions.



16595.30
DANA 30

16595.35
DANA 35

16595.44
DANA 44

16595.60
DANA 60

DESCRIPTION	Stock No.
HEAVY DUTY DIFFERENTIAL COVER DANA 30	16595.30
HEAVY DUTY DIFFERENTIAL COVER DANA 35	16595.35
HEAVY DUTY DIFFERENTIAL COVER DANA 44	16595.44
HEAVY DUTY DIFFERENTIAL COVER DANA 60	16595.60

DESCRIPTION	Stock No.
1976-86 CJ UPPER & LOWER COMBO BRACKET, STEERING GEAR BOX	18003.10
1987-06 WRANGLER PITMAN ARM W/ 4 INCH OR MORE LIFT, PS	18006.50
1976-86 CJ PITMAN ARM W/ 4 INCH OR MORE LIFT, PS	18006.51



HITCH BALL MOUNT CLIP & PIN
Stock No. 11237.02 NEW



11237.02

1984-01 XJ CHEROKEE HEAVY DUTY STEERING GEAR BOX BRACE P/S Only
Stock No. 18021.05



18021.05

HEAVY DUTY DIFFERENTIAL SKID PLATE

Protect your factory differential cover with these heavy duty skid plates. Designed to fit the contours of your stock differential cover and made of durable 3/16" black powder coated steel, these skid plates will help you slide over obstacles and not get hung up. Includes replacement mounting hardware and instructions.

DESCRIPTION	Stock No.
DIFFERENTIAL SKID PLATE, BLACK DANA 30	16597.30
DIFFERENTIAL SKID PLATE, BLACK DANA 35	16597.35
DIFFERENTIAL SKID PLATE, BLACK DANA 44	16597.44



18006.51



16597.35
DANA 35



16597.44
DANA 44

TJ HD LOWER CONTROL ARM AXLE MOUNT BRACKET PAIR

Stock No. 18273.01 NEW



HEAVY DUTY STEERING LINKAGE

DESCRIPTION	Stock No.
TJ,XJ,ZJ, LONG STEERING TUBE KIT W/ TIE ROD ENDS	18050.51
1987-95 YJ, SHORT STEERING TUBE KIT W/ TIE ROD ENDS, HEAVY DUTY DRAG LINK	18050.52
1982-86 CJ7 & CJ8 LONG STEERING TUBE KIT W/ TIE ROD ENDS	18050.53
1972-83 CJ5, 1976-81 CJ 7 LONG STEERING TUBE KIT W/ TIE ROD ENDS	18050.54
HEAVY DUTY TIE ROD CONVERSION KIT, YJ, TJ, XJ, ZJ	18080.01
1991-01 XJ, ADJUSTABLE TRACK BAR, HEAVY DUTY	18205.05
1993-98 ZJ ADJUSTABLE TRACK BAR, HEAVY DUTY	18205.05
1984-01 XJ, HEAVY DUTY FRAME STIFFENER	18205.07

HEAVY DUTY TOW HOOK KIT PAIR NEW

Don't get your Cherokee or Grand Cherokee stuck on the trails without an Rugged Ridge Heavy Duty XJ or ZJ Tow Hook Kit on the front. The 1/4 inch steel plate is form bent for maximum strength and then powder coated black to protect it from the elements.



11236.05

11236.06

Stock No.

1984-01 XJ FRONT HEAVY DUTY TOW HOOK PAIR KIT	11236.05
1983-98 ZJ FRONT HEAVY DUTY TOW HOOK PAIR KIT	11236.06

HEAVY DUTY TRANSFER CASE CROSS MEMBER NEW

The Rugged Ridge Heavy Duty Transfer Case Crossmember is made of 3/16 inch steel, welded, reinforced and powder coated black to protect it and the soft underbelly of your XJ from the elements.



12035.60

Stock No.

1984-01 XJ HEAVY DUTY TRANSFER CASE CROSSMEMBER	12035.60
---	----------

HEAVY DUTY OFF ROAD BUMPER NEW

Our low profile bumpers are ideal for tight approach angles and will fight off the rocks with sturdy 3/16 inch laser cut steel. Bumpers are powder coated black for superior appearance and durability.

DESCRIPTION	Stock No.
1997-06 TJ FRONT HEAVY DUTY OFF ROAD BUMPER	11545.01
1997-06 TJ REAR HEAVY DUTY OFF ROAD BUMPER W/ RECEIVER	11546.01



11545.01



Front Tube Bumper

When only the very BEST will do!

Rugged Ridge Bumpers and Side Tube Steps have been engineered to the industries most exacting specifications. Constructed of only the finest materials available and finished like no other tubular product, Rugged Ridge products are designed to last. Only Rugged Ridge offers all these features:

- All painted Rugged Ridge products are “E-coated” to ensure a no rust finish. This special process provides an electrostatic applied under coating that seals the raw steel. By having this exclusive undercoating, Rugged Ridge bumpers and side steps can take small rock chips and still maintain its rust protection. No other Front or rear Tube Bumper offers this kind of ultimate rust protection!
- The finish on a Rugged Ridge Bumper or Side Step is either dual staged powder coat painted or mirror finish polished stainless steel. These finishes are the very finest available and along with the “E-coat” under coating, carry a five year limited warranty on painted product and a limited life time warranty on polished stainless.
- All Rugged Ridge Front and Rear Bumpers feature smooth ground welds for an unbelievable look and further rust protection. No other tubular bumper manufacturer goes to the expense of smooth grinding their welds. This exclusive smooth grind process virtually eliminates small weld “pockets” that never seem to get full paint coverage and tend to rust over time.
- All Rugged Ridge Bumpers feature welded end caps rather than plastic end caps. Gone are the days of constantly replacing those lost tube bumper end caps after a long day on the trail. Welded end caps not only look great they also eliminate yet another rust point on the bumper by sealing the tube from the elements.
- Rugged Ridge Rear Tube Bumpers feature an optional frame mounted Hitch that allows for lightweight towing (2,000lb towing weight, 200lb tongue weight capacity). Most other rear tube bumpers with integrated hitch boxes do not recommend towing, therefore making the hitch box virtually useless.
- Rugged Ridge Tubular products are available in Gloss Black, Textured Black, Polished Stainless and Titanium finishes.

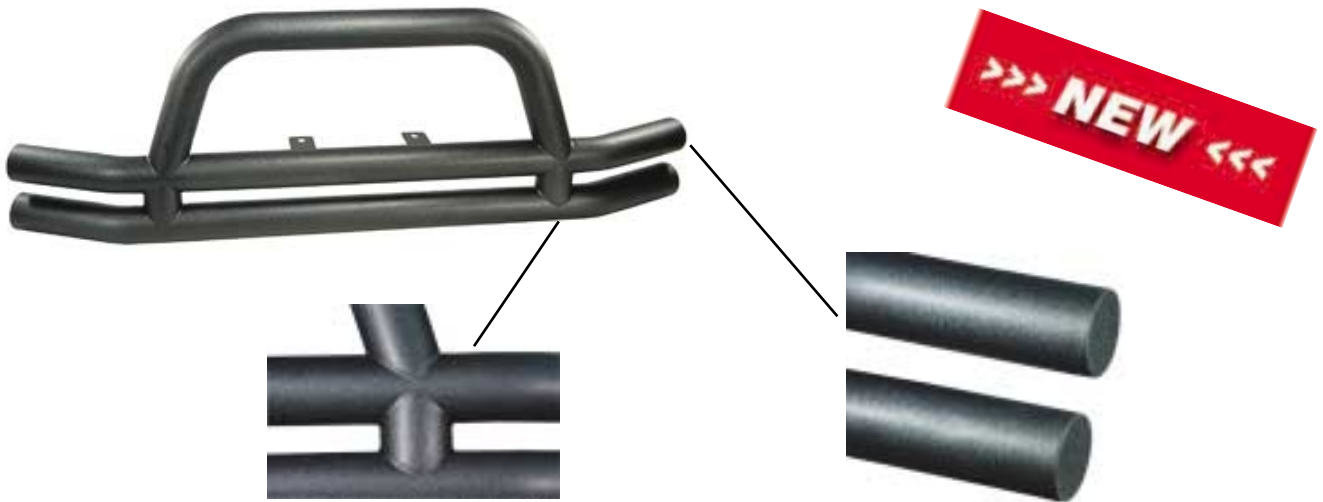

Front Tube Bumpers

Years	Model	Black	Black Textured	Titanium	Stainless
1976-06	CJ, WRANGLER, UNLIMITED	11560.01	11561.01	11562.01	11563.01
1984-95	CHEROKEE/COMANCHEE	11560.80	-	-	-



Front Tube Bumpers with Winch Cut Out (Black, Textured, Titanium)



Years	Model	Black	Black Textured	Titanium
1976-06	CJ, WRANGLER, UNLIMITED	11560.03	11561.03	11562.03

Rear Tube Bumper

When only the very BEST will do!

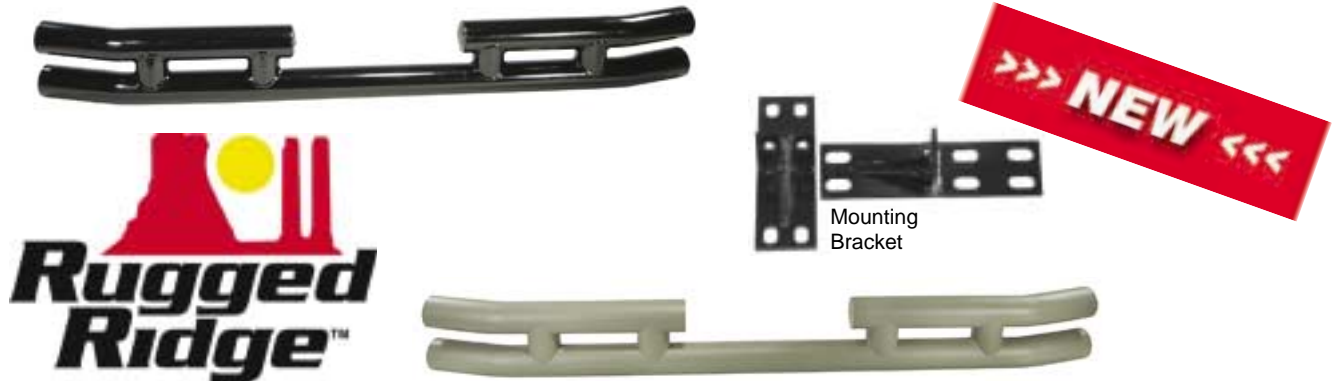

Rear Tube Bumpers

Years	Model	Black	Black Textured	Titanium	Stainless
1955-86	CJ5, CJ7	11570.01	11571.01	-	-
1984-95	CHEROKEE/COMANCHEE	11570.80	-	-	-
1987-06	WRANGLER/UNLIMITED	11570.03	11571.03	11572.03	11573.03

Rear Tube Bumpers with Hitch

Years	Model	Black	Black Textured	Titanium	Stainless
1955-86	CJ5, CJ7	11570.02	11571.02	-	-
1987-06	WRANGLER/UNLIMITED	11570.04	11571.04	11572.04	11573.04

Rear Hitch

Part# Description

- 11580.01 Rear Hitch for 1955-86 CJ (2,000lb towing weight, 200lb tongue weight capacity).
- 11580.02 Rear Hitch for 1987-06 WRANGLER (2,000lb towing weight, 200lb tongue weight capacity).

Side Tube Steps



Side Tube Step

Years	Model	Black	Textured	Titanium	Stainless
1976-83	CJ5	11590.01	-	-	-
1976-86	CJ7	11590.02	11591.02	11592.02	-
1984-01	JEEP CHEROKEE 2 DR	11590.80	-	-	-
1984-01	JEEP CHEROKEE 4 DR	11590.81	-	-	-
1987-95	JEEP WRANGLER	11590.03	11591.03	11592.03	11593.03
1997-06	JEEP WRANGLER	11590.04	11591.04	11592.04	11593.04

License Plate Mounting Bracket

Stock # Description

- 11503.80 License plate Mounting Bracket for Tube Bumpers



JEEP® SURPLUS STOCK

XJ - CJ - YJ - TJ

The legend of the "Jeep" in a crate has been around for years. Nobody has been able to prove this legend until now. Hundreds of surplus crates containing CJ -XJ -YJ- and even TJ parts from all over the globe, have been sourced and brought to our warehouse. Each crate contains just one piece to a puzzle of a thousand parts that make up any number of Jeep® systems or even complete vehicles.

JEEP CHEROKEE (RHD)

We have thousands of OE high quality factory fresh replacement parts for your 1984-1996 Jeep® Cherokee. These crates were packed at the Toledo factory in 1996 for the export of 288 Cherokees to be assemble in an overseas market. Crates range from full body sides to complete 2.5L (4cyl) motors. All items were packed in bulk and have been sealed in their crates for the past nine years. All parts look like the day they came off the assembly line here in the U.S. and Canada. All of the surplus parts were either manufactured here in the States or in Canada and are of true OE quality. Looking for that factory fresh motor? We have it. Looking for that replacement axle assembly? We have it. Looking for that small bolt or fastener that's just not stocked anymore? We have it. The truth is that if it was made for the first generation XJ's then odds are we have what you are looking for.

CJ - YJ AND TJ SURPLUS

As with the XJ stock we have acquired a large number of crates containing many CJ, YJ, and TJ components. The crates are being opened and new stock is being readied for sale daily. Items range from transmissions to mirrors and many more items you will find listed in the following pages of this catalog.

For complete listing, please visit our website.



Please keep in mind that even though there is a large supply of these surplus parts, quantities are limited. When the part you need sells out, it is gone for good. For this reason we are selling on a first come first serve basis.

CHRYSLER-JEEP® 2.5L 4CYL ENGINES (SURPLUS - LIMITED SUPPLY)

The 2.5L surplus engines were originally supplied for 1996 XJ (Cherokee) vehicles, but can be used for many Jeep® applications where the 2.5L fuel injected (non-TBI) engines were installed by the factory. The Cherokee 2.5L came from the the factory with a slightly higher output in horsepower and torque than the standard YJ -TJ (4cyl).



S-53021471

Jeep® models that used the 2.5L EFI engine.
1991-96 YJ
TJ Wranglers 1991 - 2002
1991 to 2000 Cherokees
1996-2001 Dodge Dakota Pick-up.



S-53021471

This OE original motor assembly will reduce time and money typically spent with a standard engine replacement. The following components are included with the engine and make for an easy swap, or engine replacement.

2.5L long bock (includes head assembly)
Fuel injection system, Intake throttle body, Injectors,
Fuel Rail, Exhaust manifold, Water pump, Thermostat
Timing cover and gears, Harmonic balancer, Clutch
and Flywheel assembly



S-53021471



ALL SURPLUS EQUIPMENT IS OF A LIMITED SUPPLY AND WILL BE SOLD ON A FIRST COME FIRST SERVE BASIS ONLY.

CHRYSLER-JEEP® TRANSMISSIONS (SURPLUS LIMITED SUPPLY)

The following transmissions were originally supplied for 1996 export XJ (Cherokee) vehicles, but can be used for any Jeep® application where they were installed by the factory.

SURPLUS

S-4810179



AW4 Automatic Transmission used with 4.0L High Output engines, and has a 23 spline output shaft. Gear ratios were 2.80, 1.53, 1.00, and .75

- Jeep® models that used the AW4 automatic transmission
- 1991-2001 Cherokee (XJ), Comanche pick-ups (MJ) 6cyl
- 1993 Grand Cherokee (ZJ) 6cyl

AX5 Manual Transmission used with 2.5L 4cyl engines.

- Jeep® models that used the AX5 manual transmission
- 1984-2001 Cherokees with 2.5L 4cyl engines
- 1987-2002 YJ, TJ Wranglers with 2.5L 4cyl engines

S-52108046



32RH Automatic Transmission

with (23) spline output used with 4.0L 6cyl engines.

This automatic transmission was originally supplied for 1994 - 1996 export YJ Wranglers with 4.0L 6cyl engines, but can be used for any Jeep® application where part number 52118024 was installed by the factory.

- Jeep® models that used the 32RH automatic transmission
- Jeep® part number S-52118024
- 1992-1995 YJ wranglers with 4.0L 6cyl engines
- 1996 Export YJ with 4.0L 6cyl engine

S-52119156

**RELATED SURPLUS TRANSMISSION AND TRANSFER CASE PARTS**

DESCRIPTION	Stock No.
BELL HOUSING 2.5L MANUAL	S-52104000
BELL HOUSING 1987-1993 4.0L MANUAL	S-53007105
1994-2002 2.5L & 4.0L MANUAL	S-52107555
1996 XJ TRANSMISSION CUSHION	S-52001180
XJ 2.5L 231 TRANSFER CASE LEVER ASSY	S-52104101AB
XJ 4.0L 242 TRANSFER CASE LEVER ASSY	S-52104103
XJ 4.0L AUTOMATIC SHIFT LEVER 1996 AW4	S-52104107



ALL SURPLUS EQUIPMENT IS OF A LIMITED SUPPLY AND WILL BE SOLD ON A FIRST COME FIRST SERVE BASIS ONLY.

CHRYSLER-JEEP® TRANSFER CASES (SURPLUS LIMITED SUPPLY)

The following transfer cases were originally supplied for 1996 export XJ (Cherokee) vehicles, but can be used for any Jeep® application where they were installed by the factory



S-52099310

NP231 (S-52099310) Chain drive transfer case

for 2.5L 4cyl with manual transmissions.
Has a (21) spline input, and a 1.2" short shaft.

- Jeep® models that used the NP231 21 spline transfer case.
- Any 4cyl Jeep with an AX4, or AX5 manual transmission
- Any 4cyl Jeep with an AW4 up to 1990 with (21) spline output.

NP242 (S-52098384) Chain drive full time transfer case

for 4.0L 6cyl engines, (23) spline input.

- Jeep® models that used the NP242 (23) spline full time transfer case.
- 1991 to 2001 Jeep Cherokee with 4.0L 6cyl engine and automatic transmission.



S-52098384

The following transfer cases were originally supplied for 1994 - 1996 export YJ Wranglers with 4.0L 6cyl engines, but can be used for any jeep® application where the listed part numbers were installed by the factory.

NP231 (S-52098358) Chain drive transfer case

for 4.0L 6cyl with manual transmissions, (23) spline input, (1.2" short shaft)

- Jeep® models that used the NP231 23 spline transfer case with manual transmission and some automatics.
- Any 6cyl Jeep® equipped with a 1989 - 1994 AX15
- Any 6cyl Jeep® equipped with an AW4 after 1990 (23) spline output.

S-52098360



NP231 (S-52098360) Chain drive transfer case

for 4.0L 6cyl with automatic transmissions, (23) spline input, (2.1" long shaft)

- Jeep® models that used the NP231 23 spline transfer case with automatic transmissions, and some manuals.
- Any 6cyl Jeep® equipped with a 1996 - 2001 AX15
- Any 6cyl Jeep® equipped with a 31RH or 32RH Automatic

ALL SURPLUS EQUIPMENT IS OF A LIMITED SUPPLY AND WILL BE SOLD ON A FIRST COME FIRST SERVE BASIS ONLY.

CHRYSLER-JEEP® FRONT AND REAR AXLE ASSEMBLIES (SURPLUS LIMITED SUPPLY)

SURPLUS

The following axle assemblies were originally supplied for 1996 export right hand drive XJ (Cherokee) vehicles, but can be used for any Jeep® application where they were installed by the factory.

S-52069795 Dana 35 rear axle assembly
with 3.54 gears

- Jeep® models that can use the Dana 35 axle.
- 1884-2001 Jeep Cherokee (XJ)
 - Comanche pick-up
 - Any YJ or ZJ with rear leaf spring design.

Axles come with leaf spring mounting perches



ANY TRUCK APPLICATIONS?

S-52069381 Chrysler 8.25 rear axle assembly
with 4.10 gears with Track-Lok

- Jeep® models that can use the 8.25 rear axle.
- 1884-2001 Jeep Cherokee (XJ)
 - Comanche pick-up
 - Any YJ or ZJ with rear leaf spring design.



Axles come with leaf spring mounting perches

The front axle assembly was exported as a RHD unit but can be used domestically with modifications.
RHD = right hand drive vehicle.

S-52069201 High Pinion Dana 30 front assembly with 4.10 gears.
RIGHT HAND DRIVE (RHD)

S-52069200 High Pinion Dana 30 front assembly with 3.54 gears.
RIGHT HAND DRIVE (RHD)



Jeep® models that had a coil spring Dana 30 front axle assemble.
1994-2001 (RHD) Jeep Cherokee (XJ)

Note: these front axle assemblies can be modified to work with other front applications (LHD) but will require some cutting and rewelding.



RELATED SURPLUS AXLE AND DRIVELINE PARTS

DESCRIPTION	Stock No.
1996 XJ DRIVESHAFT REAR 4.0L AUTO	S-52098731
1996 XJ DRIVESHAFT REAR 2.5L MAN	S-52098744
1996 XJ DRIVESHAFT FRONT 4.0L AUTO	S-53005542
1996 XJ DRIVESHAFT FRONT 2.5L MAN	S-53005541
1996 XJ FRONT SPRING COIL	S-52001124
1996 XJ FRONT SHOCK	S-52087831
1996 XJ FRONT SWAY BAR	S-52087859
1996 XJ REAR SWAY BAR	S-52001135
1996 XJ JOUNCE BUMP STOP	S-52004297
1996 XJ FRONT COIL SPRING INSULATOR	S-52000229
1996 XJ FRONT SWAY BAR ARM	S-52037849



JEEP® CHEROKEE XJ BODY PARTS (SURPLUS LIMITED SUPPLY)

SURPLUS



Body parts

	Stock No.
1984-96 Left side body panel (4 door models)	S-55235539
1984-96 Right side body panel (4 door models)	S-55235538
1984-96 Front left (drivers side) door (4 door models)	S-55235251
1984-96 Front right (passenger side) door (4 door models)	S-55235250
1984-96 Rear left (driver side) door (4 doors models)	S-55176003
1984-96 Rear Right (passenger side) door (4 door models)	S-55176002
1984 - 01 Hood - 2 door and 4 door model Cherokee	S-55235439
1984-96 Hood hinge - right side	S-55075180
1984-96 Hood hinge - left side	S-55075181
1984-96 Rear liftgate (composite) 2dr and 4d	S-55235531
1984-96 Rear liftgate hinge left side	S-55075295
1984-96 Rear liftgate hinge right side	S-55075294
1984-96 Front grill support 2dr and 4dr	S-55294926
1984-96 Front grill insert (black) 2dr and 4dr	S-55054945
1984-96 Front right headlamp bezel (black) 2dr and 4dr	S-55054931
1984-96 Front left headlamp bezel (black) 2dr and 4dr	S-55054930
1984-96 Roof panel w/roof rack mounting holes 2&4dr	S-55254639
1996 Front floor pan 2dr and 4dr Cherokee	S-55174807
1996 Rear floor pan 2dr and 4dr Cherokee	S-55235380
1984-96 Front bumper (black) 2dr and 4dr	S-55234551
1984-96 Rear bumper (black) 2dr and 4dr	S-55234618
1984-96 Front bumper (NO PAINT) 2dr and 4dr	S-55234549
1984-96 Rear bumper (NO PAINT) 2dr and 4dr	S-55234617
1984-96 Cross member assembly 2dr and 4dr	S-52002328
1984-96 Cowl filter screen (RHD only)	S-55027697
1984-96 Cowl Grill (RHD only)	S-55027696
1984-1996 Front skid plate	S-52018009



Exterior Trim (XJ)

	Stock No.
1984-96 Front left bumper end cap (black grain texture)	S-55234545
1984-96 Front right bumper end cap (black grain texture)	S-55234544
1984-96 Rear left bumper end cap (black grain texture)	S-55029245
1984-96 Rear right bumper end cap (black grain texture)	S-55029244
1984-96 Front left bumper end cap (gray, smooth)	S-55234781
1984-96 Front right bumper end cap (gray, smooth)	S-55234780
1984-96 Rear left bumper end cap (gray, smooth)	S-55234691
1984-96 Rear right bumper end cap (gray smooth)	S-55234690
1984-96 Roof rack assemble 2dr and 4dr	S-55235277
1984-96 Right side mirror (RHD only)	S-55154683
1984-96 Left side mirror (RHD only)	S-55154734
1984-1996 Front fender flare right side smooth (paintable)	S-55175482
1984-1996 Front fender flare left side smooth (paintable)	S-55175483
1984-1996 Rear fender flare right side smooth (paintable)	S-55005879
1984-1996 Rear fender flare left side smooth (paintable)	S-55005878
1984-1996 Front fender flare right side black textured	S-5EU60SX9
1984-1996 Front fender flare left side black textured	S-5EU61SX9
1984-1996 Rear fender flare right side black textured	S-5EU62SX9
1984-1996 Rear fender flare left side black textured	S-5EU63SX9

ALL SURPLUS EQUIPMENT IS OF A LIMITED SUPPLY AND WILL BE SOLD ON A FIRST COME FIRST SERVE BASIS ONLY.

JEEP® CHEROKEE XJ BODY PARTS (SURPLUS LIMITED SUPPLY)

Lamps and Lenses

	Stock No.
1984-96 Front signal lamp - right side (amber)	S-55155072
1984-96 Front signal lamp - left side (amber)	S-55155073
1984-96 Rear lamp assy -right side (export)	S-55155464
1984-96 Rear lamp assy -left side (export)	S-55155465
1984-96 Front fender turn signal (Export only)	S-55055014
1984-96 Front parking lamp - left side (amber)	S-56000853
1984-96 Front parking lamp - right side (amber)	S-56000852
1996 Rear stop light - center mount	S-5ED63PS1
1984-96 Right head lamp (Hella H4 55W-60W) w/o level devise	S-55054828
1984-96 Left head lamp (Hella H4 55W-60W) w/o level devise	S-55054829



	Stock No.
1984-96 Door latch assembly - right side (front)	S-55000766
1984-96 Door latch assembly - left side (front)	S-55000767
1984-96 Door latch assembly - right side (rear)	S-55075878
1984-96 Door latch assembly - left side (rear)	S-55-75879
1984-96 Door handle - right side (front & rear)	S-55024926
1984-96 Door handle - left side (front & rear)	S-55024927
1984-96 Window seal - rear quarter (4dr)	S-55007129
1984-96 Front windshield molding	S-55235391
1984-96 Hood (bonnett) release cable assembly	S-55075570

JEEP® CHEROKEE XJ INTERIOR PARTS (SURPLUS LIMITED SUPPLY)

Interior Trim (XJ)

	Stock No.
1984-96 Center console Insert (Black) 2dr and 4dr	S-55114998
1984-96 Center console (gray) 2dr and 4dr	S-5FG26SA8
1984-96 Rear cargo cover assemble (gray)	S-5FC34RS1
1984-96 Front right arm rest with pull handle (light gray)	S-5AB98JS1
1984-96 Front left arm rest with pull handle (light gray)	S-5AB99JS1
1984-96 Rear arm rest for left & right 4dr (light gray)	S-5AC34JS1
1984-96 Front left arm rest with pull handle (dark gray)	S-5AB98JA8
1984-96 Front right arm rest with pull handle (dark gray)	S-5AB99JA8
1984-96 Rear arm rest for left & right 4dr (dark gray)	S-5AC34JA8
1984-96 Dash pad assembly (RHD only)	S-5EY13SA8
1984-96 Rear view mirror	S-04299325
1984-96 Front visor with Light (right side)	S-5FG76SS1
1984-96 Front visor with Light (left side)	S-5FK76SS1
1984-96 Front door panel right side (Gray)	S-5FN38SSA
1984-96 Front door panel left side (Gray)	S-5FN39SSA
1984-96 Spare tire cover (Gray)	S-5FM76SA8
1984-96 B-pillar cover Side (Gray)	S-5BG07KS1
1984-96 B-pillar cover Side (Gray)	S-5BG06KS1
1984-96 B-pillar cover Side (Gray)	S-5EU70RS1
1984-96 B-pillar cover Side (Gray)	S-5EU71RS1
1984-96 Rear scuff cover (Gray)	S-5AC55JS1
1984-96 Wood grain door trim - right rear (gray)	S-5DD70MS1
1984-96 Wood grain door trim - left rear (gray)	S-5DD71MS1
1984-96 Wood grain door trim - right front (gray)	S-5DD66MS1
1984-96 Wood grain door trim - left front (gray)	S-5DD67MS1
1984-96 Wood grain instrument bezel (RHD)	S-55115072
1984-96 Black instrument bezel (RHD)	S-55115070
1996 Leather wrapped steering wheel w/o air bag	S-5FJ14SX9



JEEP® CHEROKEE XJ HARD PARTS (SURPLUS LIMITED SUPPLY)



Part Description	Stock No.
1996 Power brake booster with master cylinder	S-52008647
1996 Hydraulic ABS control unit	S-52008727
1996 Proportioning valve assembly	S-52129025
1996 E-brake lever assembly (2.5L - manual)	S-52127958



Part Description	Stock No.
1996 Fan Shroud 4.0L 6cyl (RHD)	S-52028324
1996 Fan (7 blades)	S-52028603
1996 Electric fan assembly (RHD)	S-52030035AB
1996 Coolant bottle assembly RHD - export	S-52079340

Part Description	Stock No.
1996 ABS control module for 1996 XJ and ZJ	S-56027271
1996 Sensor (HI-OIL)	S-56026779
1996 Sensor (HI-TEMP)	S-56027012
1996 Oxygen sensor - 18	S-56027916
1996 Oxygen sensor - 12	S-56027917
1996 Oxygen sensor - 12	S-56041005
1996 Vehicle speed sensor (2.5L 4cyl)	S-5602813
1996 Ignition wires 4.0L 6cyl (6pcs)	S-33007155
1996 ignition wires 2.5L 4cyl (4pcs)	S-56027219
1996 Speed control assembly	S-52079347
1996 Speed control switch assembly	S-56007712



Part Description	Stock No.
1984-96 Switch & bezel (window) right rear	S-56007218
1984-96 Switch & bezel (window) left rear	S-56007221
1984-96 Switch assembly (window -door) left front (RHD)	S-56007223
1984-96 Switch assembly (window -door) right front (RHD)	S-56010051
1984-96 Instrument cluster (RHD - Kolometers)	S-56009018
1984-96 Power window regulator - front left side	S-55235647
1984-96 Power window regulator - front right side	S-55235646
1984-96 Power window regulator - rear left side	S-55154899
1984-96 Power window regulator - rear right side	S-55154898
1984-96 Power antenna assembly	S-56003151
1984-96 Washer reservoir with two pumps	S-55155318
1984-96 Wiper motor assembly RHD with linkage	S-55155300
1984-96 Power door solenoid right side	S-J3721500
1984-96 Power door solenoid left side	S-J3721501

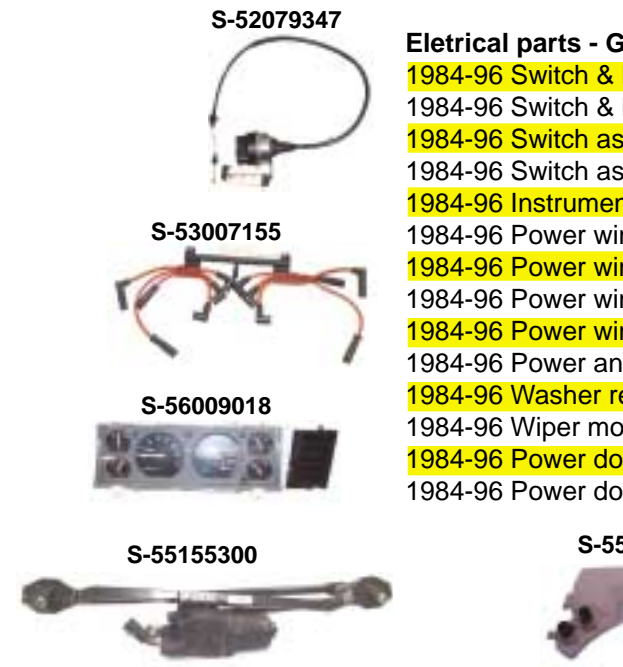

ALL SURPLUS EQUIPMENT IS OF A LIMITED SUPPLY AND WILL BE SOLD ON A FIRST COME FIRST SERVE BASIS ONLY.

SURPLUS

JEEP® CHEROKEE XJ HARD PARTS (SURPLUS LIMITED SUPPLY)

SURPLUS

Exhaust parts

	Stock No.
1996 Muffler assembly with tail pipe - 4.0L 6cyl	S-52022039
1984-1996 OE exhaust pipe clamp	S-52018424
1984-1996 OE exhaust insulator	S-52001759
1996 Front exhaust pipe	S-52020069

Heating & A/C parts

	Stock No.
1996 A/C Condensor	S-55036779
1996 Vacuum reservoir	S-52004366
1984-96 Dash mount A/C vent control assembly (RHD)	S-56022016
1996 A/C reciever - drier	S-55036112
1994-1996 A/C compressor R-134 (4.0L 6cyl)	S-55037359
1996 A/C compressor R-134 (2.5L 4cly)	S-55037360

Fuel and intake system parts

	Stock No.
1996 Fuel tank w/o sending unit	S-56022095
1996 Fuel pump with regulator and sending unit (intank)	S-04798941
1984-1996 Fuel tank skid plate	S-52001512
1996 Filter box air hose assembly	S-53006274
1996 Vapor return canister	S-53031904

Steering parts

	Stock No.
1996 Steering assembly (intermediat)	S-52078556
1996 Pitman arm (power steering)	S-52006505
1996 Steering stabilizer shock	S-52037506
1996 Steering column assembly - Tilt	S-52080229
1996 Power steering pump (2.5L 4cly)	S-52088018
1996 Remote resivior for power steering pump (2.5L 4cly)	S-52006395
1996 Power steering box - RHD only	S-56022278AA
1996 AirBag (steering wheel - black)	S-5FL22SX8

1984-1996 Steering linkage assembly - RHD	S-52006507
1996 Steering wheel without air bag	S-5FJ14SX9

S-52022039

S-52018424

S-52001759

S-53006274

S-55037359

S-52004366

S-52006395

S-55036779

S-52001512

S-56022095

S-56022016

S-5FL22SX8

S-52080229

S-52078556

S-52006505

S-56022278AA

S-52037506

S-53031904



JEEP® CJ - YJ - TJ SURPLUS STOCK (LIMITED SUPPLY)

Spotlight Surplus item

OE Steel wheel for 1987 to 2006 Jeep vehicles with 5 x 4.5 wheel bolt pattern. These are factory supplied steel wheels that can be used as your second set of street wheels, or for your set of winter tires. Need to save space and weight? Then this is your ideal rim. The 15" x 6" design allows for both weight and space savings. Order today for an unbelievable deal while supplies last. Help dress the wheels up with a Jeep® hub cap (P/N: S-52089008)

STOCK NO.
S-52089008



STOCK NO.
S-5200022



SURPLUS

Why suffer with old dull rear tail lights on your 1991-97 YJ Wrangler? We have a limited supply of OE rear taillight assemblies that will help bring your Jeep one step closer to new.

S-56018649
S-56018648



Is the front of your CJ sagging with all you extra gear, or just slumping due to age. Try replacing them with these H/D 7 layer military wrapped front springs for 1976-1986 CJ's.
P/N : S-J5364230



Time, heat, cold, and water can damage your hard top side vent windows. We have both left and right side vent windows in stock. Hurry because these will not last long.

S-55176281 (LH)
S-55176280 (RH)



Is your front drive shaft worn out? Do you have a bad vibration any time you shift into 4wd? Than your drive shafts could be the problem. We have a large supply of front and rear surplus drive shafts for many applications.

S-52088028 (front YJ drive shift with automatic transmission)



S-52098221 (rear drive shaft for 4.0L manual transmission)



JEEP® CJ - YJ - TJ SURPLUS STOCK (LIMITED SUPPLY)

SURPLUS

S-55037200



S-TT-912374



Steering parts

	Stock No.
LUG WRENCH TJ	S-52003583
1994-96 TURBO DIESEL INTER-COOLER (2.5L) DIESEL XJ & ZJ	S-52028089
1987-95 FRONT PROP SHAFT (6 CYL) W/ AUTOMATIC	S-52088028
1987-06 HUB CAPS WITH JEEP LOGO FOR STEEL WHEEL	S-52089008
1994-96 NP231 TRANSFER CASE 23 SPLINE INPUT (4.0L) MANUAL	S-52098358
1994-96 NP231 TRANSFER CASE 23 SPLINE INPUT (4.0L) AUTO	S-52098360
1994-96 AUTOMATIC TRANS. ASSY. (4.0L)	S-52119156
IDLER PULLEY (FITS MANY APPLICATIONS)	S-53002903
IDLER PULLEY (FITS MANY APPLICATIONS)	S-53002905
1991-99 4.0L YJ-TJ , 1991-95 2.5L YJ fan clutch	S-52027626
HEATER ASSY. W/ BLOWER MOTOR YJ	S-55036899
1991-97 TAIL LIGHT ASSY RH	S-56018648
1991-97 TAIL LIGHT ASSY LH	S-56018649
CARPET FRONT FLOOR, AUTOMATIC CINDER (GRAY) COLOR	S-5EE05PXA
1987-95 YJ floor pan transmission tunnel cover (Automatic)	S-53004650
HD FRONT LEAF SPRING W/ MILITARY WRAP 7 LAYER FOR CJ	S-J5364230
1983-86 CJ WIPER MOTOR W/ 4 WIRE PLUG	S-J5763696
1972-05 DETROIT TRUTRAC LIMITED SLIP FOR DANA 30 (2.73-3.54 RATIOS)	S-TT-912374
1976-86 Full door inner panel (gray) left side	S-5AE13KXA
1976-86 Full door inner panel (gray) right side	S-5AE12KXA
1987-95 YJ vent control assembly	S-55036371
1987-95 YJ frame cross member	S-52002727
1987-2006 5" x 4.5" x 6" steel OE wheel	S-52000022
1987-95 YJ upper vent control assembly	S-55037200
1987-95 YJ transfer case shifter lever	S-53003044
1987-95 YJ rear tire carrier - H/D	S-55015857
1987-95 YJ Heavy duty rear shock	S-83502837
1987-95 YJ Heavy duty front shock	S-83502836

S-52098360



S-52089008



S-55036899



S-52003583



S-5EE05PXA



S-53003044



S-52027626



S-52000022



S-56018649



S-52040404



s-52040110



s-5503494



S-3239562



JEEP® YJ SURPLUS STOCK (LIMITED SUPPLY)

CYLINDER HEAD (INCLUDES VALVES & SPRINGS) 4.2L TOP	S-3239562
1987-95 PITTMAN ARM, LHD YJ WITH MANUAL STEERING	S-52040110
1987-95 REAR TRACK BAR WITH BUSHINGS YJ	S-52040404
1987-95 SCHACKLE PLATE 87-95 YJ	S-52040415
1994-95 REAR DRIVE SHAFT (4.0L) YJ WITH MAN TRAN AND 3 INCH SLIP YOKE	S-52098221
FLYWHEEL HOUSING 6CLY YJ WITH AX15 MAN TRAN	S-53007105
1987-95 WEATHERSTRIP, LIFTGLASS AND TAILGATE YJ	S-55009398
1987-95 LIFTGLASS WEATHERSTRIP YH, HARD TOP	S-55010064
WORLD CAB DOOR RIGHT SIDE 1981-96 CJ, YJ	S-55034394
WORLD CAB DOOR LEFT SIDE 1981-96 CJ,YJ	S-55034395
1987-95 FRONT FRAME YJ JEEP LOGO COVER	S-55050158
YJ 4.0L LEADED FUEL 1994 COMPUTER MAN TRAN W/ CATALYTIC EUROPE	S-56027781
BRAKE METERING VALVE - PROPORTIONING	S-13179776
1987-95 YJ COWL GRILL WITH SCREEN	S-55175729
1987-95 YJ COWL GRILL	S-55175749
1987-95 YJ CENTER CONSOLE - GRAY	S-5ER64RXA
1981-95 HARDTOP SIDE VENT WINDOW - LH	S-55176281
1981-95 HARDTOP SIDE VENT WINDOW - RH	S-55176280
1987-95 YJ GRILL AIR DEFLECTOR TOP-SIDES	S-55027504
1987-95 YJ WINDSHIELD COWL SEAL	S-55175778
1987-95 TEMP CONTROL CABLE ASSEMBLE	S-55036907
1981-95 FULL DOOR MIRROR - LEFT SIDE	S-55027207
1981-95 FULL DOOR MIRROR - RIGHT SIDE	S-55027208

S-53007105



S-55050158



S-52040415



S-52018176



S-52098221



S-55015857

S-55176280

S-5ER64RXA



S-53004650



S-5462424 - S-5462425



S-55027207 (L) - S-55027208 (R)



S-55010064



S-55027504



JEEP® RHD & EXPORT SURPLUS STOCK (LIMITED SUPPLY)

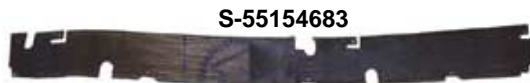

S-55154683



S-55027696



S-5504828



S-55055014



S-55155465



S-52028324



S-52030035AB



S-52079340



S-5EY13SA8



S-56009018



S-55154734



S-5FL22SX8



S-56007223



S-56022278AA



S-52028089



S-56027781

1984-1996 Front Track Bar Bracket (RHD) XJ S-52006508
 1984-96 Cowl filter screen (RHD only) S-55027697
 1984-96 Cowl Grill (RHD only) S-55027696
 1984-96 Right side mirror (RHD only) S-55154683
 1984-96 Left side mirror (RHD only) S-55154734

1984-96 Rear lamp assy -right side (export) S-55155464
 1984-96 Rear lamp assy -left side (export) S-55155465
 1984-96 Front fender turn signal (Export only) S-55055014
 1984-96 Right head lamp (Hella H4 55W-60W) S-55054828
 w/o level devise
 1984-96 Left head lamp (Hella H4 55W-60W) S-55054829
 w/o level devise

1984-96 Dash pad assembly (RHD only) S-5EY13SA8
 1984-96 Wood grain instrument bezel (RHD) S-55115072
 1984-96 Black instrument bezel (RHD) S-55115070
 1996 Fan Shroud 4.0L 6cyl (RHD) S-52028324
 1996 Electric fan assembly (RHD) S-52030035AB
 1996 Coolant bottle assembly RHD - export S-52079340
 1984-96 Switch assembly (window -door) S-56007223
 left front (RHD)
 1984-96 Switch assembly (window -door) S-56010051
 righth front (RHD)
 1984-96 Instrument cluster (RHD - Kolometers) S-56009018
 1984-96 Wiper motor assembly RHD S-55155300
 1996 Power steering box - RHD only S-56022278AA
 1996 AirBag (steering wheel - black) S-5FL22SX8
 EXPORT ONLY CAN NOT BE SOLD DOMESTICALLY

1994-96 TURBO DIESEL INTER-COOLER S-52028089
 (2.5L) DIESEL XJ & ZJ
 YJ 4.0L LEADED FUEL 1994 COMPUTER S-56027781
 MAN TRAN W/ CATALYTIC EUROPE

SURPLUS



PRODUCTS

Air Compressor Kits.....	37	Hardtops.....	21
Air Conditioning.....	147	Hawse Fairlead.....	34, 36, 38
Air Filters.....	46, 141, 142	Headlight Bezels.....	33, 35, 51, 67
Apparel.....	184 - 186	Heating.....	147
AutoVent Shade Products.....	46	Heavy Duty Parts.....	187
Auxiliary Lighting.....	48	Hinge Sets.....	28, 32
AVM Locking Hubs.....	96	Hood Catches.....	29, 32
Axle Assemblies, Front.....	76-83, 99	Hood Kits.....	28
Axle Assemblies, Rear.....	84-93, 98	Hood Locks.....	34
Bikini Tops.....	15, 16	Hood Vent Covers.....	29
Black Chrome Stainless Steel Accessories.....	31	Hoods.....	3, 61, 62, 64, 66, 68, 70, 72, 75
Black Powdercoat Exterior Accessories.....	32, 33	Hubs and Conversion Kits.....	39, 76, 77, 93, 94, 95, 96, 98, 101, 102
Body Armor.....	43, 44, 60	Interior Accessories & Replacement Parts.....	33, 37, 54, 55
Body Panels.....	62, 64, 67, 69, 71, 72, 195	Jacks.....	58
Body Parts		Jeep Licensed Items.....	3, 61
MB Body Parts.....	62, 63	Key Chains.....	186
GPW Body Parts.....	62, 63	Lamps, Lights and Lenses.....	49-51
M38 Body Parts.....	64, 65	License Plate Brackets.....	33
CJ2A, CJ3A and CJ3B Models.....	66, 67	Lift Gate Supports.....	74, 75
CJ5, CJ6 and M38A1 Models.....	68, 69	Light Guards.....	28, 31, 33
CJ5, CJ7 & CJ8 Models.....	70, 71	Light Mounting Brackets.....	32, 33
YJ & TJ Models.....	72, 73	Lockers for Differential.....	45, 77, 82, 84, 85, 99, 100
XJ & ZJ Models.....	74, 75	Locks and Cylinders.....	50, 74, 75
Chrome and Titanium Exterior Accessories.....	33	Mirror Relocation Brackets.....	27, 30, 32
Clinometer.....	34	Mirrors.....	22, 26, 27, 31, 55, 74
Clutch and Flywheel Parts.....	110 - 113, 135	Nerf Bars.....	58
Coat Hangers.....	34	Non-Jeep Axle Parts.....	93-96
Consoles.....	19, 36, 40	Owner and Service Manuals.....	35
Cooling Parts.....	114 - 117	Polyurethane Products.....	160, 161
Cup Holders.....	34	Power Steering Pumps.....	148, 149
Dash Boards and.....	3, 61, 65, 67, 71, 193	Receiver Accessories.....	33
Instrument Panels		Receiver Hitches.....	33, 42, 43
Dashpads and Covers.....	3, 54, 61, 70	Rocker Guards.....	39, 43
Differential Covers.....	29	Seat & Tire Covers.....	17
Door Handles.....	35, 36, 52, 53, 55, 74	Seat Belts.....	54
Door Kits, Bestop.....	12	Seat Risers and Sliders.....	5, 7
Door Parts.....	52, 53, 71, 73, 74, 75, 197	Seats.....	5, 7, 8, 63, 64, 66
Driveshafts.....	97, 194, 196, 197	Shock Absorbers.....	157, 158, 166
Duster Covers.....	16	Soft tops.....	8 - 10, 13, 14, 24, 25
Electrical Parts & Guages.....	64, 67, 69, 118 - 125	Sound Bars.....	19, 36
Engine Mounts.....	136	Spart Bar Utility Hook.....	34
Engine Parts.....	126 - 136	Sport Bar Dome Light.....	34
Entry Guards.....	20, 29, 44	Spreader Bars for YJ.....	34
Exhaust.....	133, 137 - 140	Stainless Steel Dash Accessories.....	30
Fender Flares.....	3, 20, 56, 57, 62, 68, 70, 72 - 75	Stainless Steel Exterior Accessories.....	28, 30
Fenders.....	59, 62, 64, 66, 68, 70, 72, 74, 196	Steering Parts.....	148 - 154, 187
Floor Coverings.....	47	Storage and Rack Components.....	18, 21, 41, 42
Floor Panels.....	62, 64, 65, 67, 69, 71, 195	Sun Visors.....	36
Frame Covers.....	29, 44, 201	Surplus.....	190 - 200
Fuel and Intake System.....	141 - 146	Suspension Parts & Accessories.....	155 - 167
Grab Bar Handles.....	37, 55	Tailgate Stopper, Billet Aluminum.....	34
Grill Covers.....	3, 61, 72	Tailgates.....	3, 61, 62, 64, 66, 68, 70, 72, 195
Grill Inserts.....	3, 35, 74	Tire Carriers.....	20, 39, 59, 62, 65, 69
		Top Bow Assemblies.....	63, 65
		Tow Bar.....	42
		Tow Hooks.....	30, 33, 35, 59, 74, 75, 187
		Transfer Case.....	168 - 172, 194
		Transfer Case Cross Member.....	59, 63, 65, 74, 75, 187, 195
		Transmission.....	173 - 181, 192
		Upper Door Sliders.....	11
		Valve Covers.....	3, 61, 126
		Weatherstrip Seals.....	52, 53, 62, 66, 71, 73, 74, 196
		Wheel Spacers.....	187
		Winch Accessories.....	38
		Winch Fairleads.....	34, 36, 38
		Winch Mounts.....	38, 45
		Winches.....	38
		Windjammers.....	17
		Window Kits, Bestop.....	11
		Windshield Channels.....	15, 35
		Windshield Frames.....	3, 61, 62, 66, 69, 71, 72
		Windshield Tie Down Kits.....	28, 32
		Wiper Motor Covers.....	29
		Wiper Motors & Parts.....	65, 67, 69, 182, 183

Supertop Soft Top
Page 9



VENDORS

AEM Intake Systems.....	141
AGR Power Steering Components.....	148
ARB.....	45, 100
AutoVent Shade	46
AVM Locking Hubs.....	94 - 96
Bestop.....	7-23
Borgeson.....	148
Bushwacker.....	56
Centech Wiring.....	118
Dana.....	76 - 92, 97
DynoMax Exhaust.....	137
Electric Life.....	118
EMPI.....	141
Flex-A-Lite.....	114
Goodridge Braided Steel Brake Lines.....	107
Grant Steering Wheels.....	154
Hi-Lift.....	58
K & N.....	46
KC Hi-Lights.....	48
Lock-Right.....	99
Mean Green.....	118
Monroe.....	151, 157, 158
MSD Ignition.....	125
Nifty.....	47
Optima Batteries.....	118
PaceSetter.....	137
Painless Wiring.....	118
Pavement Ends.....	24, 25
Posi-Lok.....	80, 95, 99
ProLine / Nifty Floor Coverings.....	47
Prothane.....	160, 161
Rugged Ridge	5, 26 - 37, 57, 59, 60, 171, 187 - 189
SkyJacker.....	162 - 167
Superwinch.....	94, 95, 98
Timken Bearings.....	76 - 92
Tuffy.....	40, 41
Warn.....	38, 39, 98
Warrior	42 - 44, 159
Weber.....	141
Xenon.....	56

