

Kōwhiri Choice

2022

Akoranga Whiringa Kaupapa
Course Selection Guide

Kōwhiri Choice

2022

Akoranga Whiringa Kaupapa Course Selection Guide

Welcome to Te Aho o Te Kura Pounamu

At the time of going to print the courses described in this guide are available for enrolment in 2022.

Refer to our website for the latest information on available courses, eligibility, standards and enrolment.

We may be required to withdraw or restrict enrolment to courses at any time. If you enrol in a course that is subsequently withdrawn or restricted in terms of enrolment, we will contact you to discuss other study options.

Information on NZQF standards are accurate at time of publication.

For more information, please contact us:

Website: www.tekura.school.nz

Email: info@tekura.school.nz

Freephone: 0800 65 99 88

We look forward to hearing from you.

Contents

Terms commonly used at Te Kura			
Ngā kupu e whakamahia ana i Te Kura	3		
Introduction			
Te Kupu Whakataki	4		
Early Childhood			
Te Ara Kōhungahunga	13		
Years 1 to 6			
Te Ara Tipu	14		
Years 7 to 10			
Te Ara Hou	15		
Learning Support/Special Education			
Te Akoranga Motuhake	16		
Discipline thinking – subjects at a glance			
Summary of subjects and levels of study	19		
Accounting			
Te Mātauranga Mahi Kaute	21		
Art			
Te Mātauranga Toi	23		
Art History			
Te Toi Hitori	27		
Biology			
Te Mātauranga Koiora	28		
Business Studies			
Ngā Akoranga Umanga	30		
Chemistry			
Te Mātauranga Matū	32		
Chinese			
Te Reo Hainamana	34		
Classics and Religious Studies			
Te Akoranga Puāwaitanga me ngā Hāhi	36		
Design and Visual Communication			
Ngā mahi hoahoa me te Whakawhitiwhiti ataata	38		
Digital Technology			
Te Hangarau Mamatai	40		
Economics			
Te Mātauranga Ōhanga	43		
English			
Te Reo Ingarihi	45		
Enterprise Studies			
Ngā Akoranga Hinonga	49		
French			
Te Reo Wīwī	50		
Gateway/STAR			
Ngā Pokenga Mahi/STAR	52		
Geography			
Te Mātauranga Mātai Matawhenua	53		
German			
Te Reo Tiamana	55		
Health Education			
Mātauranga Hauora	57		
History			
Kōrero Nehe	59		
Home Economics			
Te Mātauranga Ohaoha Kāinga	61		
Japanese			
Te Reo Hapanihi	63		
Kaupapa Māori			
Kaupapa Māori	65		
Legal Studies			
Te Akoranga Taha Ture	74		
Life skills			
Pūkenga Noho Ora	76		
Mathematics and Statistics			
Te Mātauranga Pāngarau	77		
Media Studies			
Te Akoranga Pāpāho	81		
Music			
Te Mātauranga Pūoru	83		
Pathways Education			
Te Mātauranga Rapuara	86		
Performing Arts			
Ngāmahi āte Rēhia	89		
Physical Education			
Mātauranga Hākinakina	90		
Physics			
Te Mātauranga Ahupūngao	92		
Primary Production (Agriculture/Horticulture)			
Te Ahumahi Matua	94		
Samoan			
Te Reo Hāmoa	97		
Science			
Te Mātauranga Pūtaiao	99		
Social Studies			
Te Akoranga Tikanga ā-iwi	102		
Spanish			
Te Reo Pāniora	103		
Technology			
Te Mātauranga Hangarau	105		
Te Reo Māori			
Te Reo Māori	108		
Tertiary Link/Huarahi			
Te Wānanga Hononga/Huarahi	110		

Terms commonly used at Te Kura

Ngā kupu e whakamahia ana i Te Kura

Ākonga

Student

Ara Ako

Contexts for learning

Hapori Ako

Community

Huinga Ako

Learning Advisory

Kaiako

Teacher

Kaiako Matua

Senior Teacher

Kaiarahi

Team Leader

Kaimahi

Staff

Kaimanaaki

Learning Advisor

Kaiwhakahaere

Regional Manager

My Korowai

Our online personalised learning plan space

My Te Kura

Our online learning platform

Ngā Āheinga

Dispositions for learning and wellbeing

Ngā Mātāpono

Guiding Principles

Te Ara Hou

Years 7–10

Te Ara Pounamu

Te Kura's local curriculum

Te Ara Tipu

Years 1–6

Te Marautanga o Aotearoa

Māori medium curriculum

Te Wātaka Tuihono

Timetable of online classes

Te Whariki: He whāriki mātauranga mō ngā mokopuna o Aotearoa

Early Childhood curriculum

Whānau

Family, Aiga, Supervisor

Introduction

Te Kupu Whakataki

Te Aho o Te Kura Pounamu (Te Kura) is a distance education provider. We offer a wide range of personalised learning programmes and courses from early childhood to NCEA Level 3. This guide is designed to help ākonga plan a programme of learning at Te Kura.

Te Ara Pounamu is Te Kura's local Big Picture curriculum incorporating Te Whāriki (The Early Childhood Curriculum), the New Zealand Curriculum, and Te Marautanga o Aotearoa. Te Ara Pounamu positions the ākonga at the centre of learning that is engaging, that responds to their interests and passions, and that is authentic and relevant. This learning opens up connections to learning in the world around us and illuminates future pathways.

Te Ara Kōhungahunga, our Early Childhood course, is based on Te Whāriki (The Early Childhood Curriculum). Courses from Year 1 and above are based on the New Zealand Curriculum and Te Marautanga o Aotearoa. We offer a curriculum that values the identity, language and culture of all ākonga.

My Te Kura

Our learning programmes are delivered online through a secure, online learning environment called My Te Kura. Online courses typically include a mix of interactive activities such as quizzes, digital resources including audio and video files, virtual classroom sessions, and activities ākonga can work on away from the computer. Kaimanaaki and kaiako maintain an active presence online communicating with ākonga and whānau and providing continuous feedback on learning, and ākonga development of skills, attitudes and dispositions.

We accept enrolments throughout the year, from ākonga of all ages. To find out about our enrolment criteria please visit our website www.tekura.school.nz, email enrolment@tekura.school.nz or call us on 0800 65 99 88 option 1.

Te Ara Pounamu – Te Kura's local Big Picture curriculum

Te Ara Pounamu comprises three interdependent elements: Ngā Mātāpono – the guiding philosophy and principles on which we base all learning conversations and decision making; Ngā Āheinga – skills, attitudes, dispositions and values for living, wellbeing and lifelong learning; and Ara Ako – diverse, personalised contexts for active learning. Te Ara Pounamu puts ākonga at the centre of all we do and provides support and opportunities for ākonga to achieve their educational and personal goals, enabling them to participate effectively as members of their communities. The philosophy and pedagogy of Te Ara Pounamu is visible in all curriculum design at Te Kura.

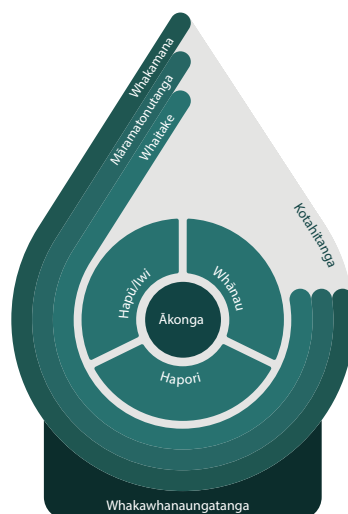

Ngā Mātāpono are the principles that guide our practice. We base our learning conversations with ākonga and whānau on these principles and support ākonga to apply them to their learning. Our five mātāpono are:

- Kotahitanga – Wellbeing: uniting all aspects of wellbeing through balanced holistic development.
- Whaitake – Relevance: connecting ākonga with relevant pathways according to their goals and interests.
- Māramatonutanga – Rigour: the ongoing pursuit of knowledge and understanding.
- Whakamana – Agency: empowering and enabling the mana of ākonga by respecting their voice and giving them choice.
- Whakawhānaungatanga – Relationships: honouring mutually respectful relationships that strengthen everyone.

Ngā Āheinga are essential learning to learn skills and capabilities. We focus on helping ākonga to recognise and build strengths and dispositions through their learning. We have highlighted ten aspirational dispositions for development over time in a range of contexts. These dispositions are: Agency and Optimism; Care and Resilience; Curiosity and Contribution; Collaboration and Connection; and Sense Making and Innovation.

Ara Ako describes our five contexts for learning. Full-time and young adult ākonga personalise their learning plans by weaving in the five contexts of Ara Ako, depending on learning goals agreed with their kaimanaaki, kaiako and whānau. All five contexts bring a different and valuable flavour to learning.

- Discipline thinking: a range of subject offerings to support existing and emerging interests and future pathways (available to all ākonga).
- ConnectED: a range of integrated learning choices to support existing and emerging interests and future pathways (available to full-time and young adult ākonga).
- EXPlore: a range of project-based learning choices including interest projects, social action projects, design projects and Big Picture projects (available to full-time and young adult ākonga).
- Huinga Ako: regular face-to-face and virtual opportunities for connection and collaboration with kaimanaaki and other ākonga to share, develop and reflect on their learning (available to full-time ākonga).
- Leaving to Learn: engagement and connection with learning opportunities in your own community, including opportunities such as work exploration, shadowing, internships, STAR courses, camps, trips and events, and future pathways discussions (available to full-time ākonga).

Selecting and planning your programme of learning

Te Ara Kōhungahunga – Early Childhood

Our Early Childhood programme supports learning at home in the early years. Qualified Te Kura kaimanaaki work with ākonga and whānau to share information and develop a programme of learning aligned to Te Ara Pounamu, that is within the guidelines of Te Whāriki – The New Zealand Early Childhood Curriculum. Resources include a mix of online learning activities and posted materials. This free service is for tamariki (children) aged from 2 to 6 years. Read more on page 13.

Te Ara Tipu – Years 1 to 6

Te Ara Tipu is Te Kura's learning programme for ākonga in Years 1–6. Learning in Te Ara Tipu is guided by Te Ara Pounamu and incorporates the key competencies and eight learning areas of The New Zealand Curriculum. Ākonga are allocated a kaimanaaki who works closely with the ākonga and their whānau to develop a personalised learning plan that values their identity, language and culture, and is based on their interests, abilities and learning needs. The process of developing a personalised learning plan is supported by My Korowai, the online learning plan platform in My Te Kura. My Korowai guides ākonga to share, develop and reflect on their learning, interests and goals.

Ākonga may wish to learn through theme-based cross-curricular exploration in an area of interest or based

around their daily life. The ākonga and their whānau work with their kaimanaaki to decide on the theme and scope of an exploration, and appropriate teaching and assessment. This programme of learning is delivered through My Te Kura, Te Kura's online learning environment. Read more on page 14.

Years 7 to 10 – Te Ara Hou

Te Ara Hou is Te Kura's learning programme for full-time ākonga in Years 7–10. Learning in Te Ara Hou is guided by Te Ara Pounamu and incorporates the key competencies and eight learning areas of The New Zealand Curriculum. Ākonga are allocated a kaimanaaki who works closely with them and their whānau to develop a personalised learning plan that values their identity, language and culture, is based on their interests and goals, and keeps options open for future learning pathways, including study at NCEA level 1. The process of developing a personalised learning plan is supported by My Korowai, the online learning plan platform in My Te Kura. My Korowai guides ākonga to share, develop and reflect on their learning, interests and goals.

Ākonga may wish to learn through theme-based cross-curricular exploration in an area of interest or based around their daily life. The ākonga and their whānau work with their kaimanaaki to decide on the theme and scope of an exploration, and appropriate teaching and assessment. Modules of learning are delivered online through My Te Kura, Te Kura's online learning environment. Read more on page 15.

Years 11 to 13

The learning programme for full-time ākonga in Years 11 to 13 is based on their personalised learning plan. The process of developing a personalised learning plan is supported by My Korowai, the online learning plan platform in My Te Kura. My Korowai guides ākonga to share, develop and reflect on their learning, interests, and goals. Ākonga will have a kaimanaaki who will help them set goals and explore their interests, determine their subjects, and maintain options for future study that link to career opportunities.

Programmes of learning are guided by Te Ara Pounamu. Our approach to learning focuses on the ākonga's passions and goals for life beyond school. It uses these as a basis for a learning plan that is unique to each ākonga. Ākonga may be working across NCEA levels through subjects and integrated modules of learning that support their interests and preferred pathways, and through project explorations. Ākonga take part in regular online or face-to-face huinga ako with their kaimanaaki to support their programme of learning. They will also have the chance to explore leaving to learn opportunities in their community, which may include internships and tertiary exploration, as well as working towards a relevant qualification. Learning is delivered through My Te Kura, Te Kura's online learning environment.

Young adults (16–19 years)

Ākonga who have left school and are aged between 16 and 19 (and not turning 20) in the study year for which they are enrolling can enrol with Te Kura free of charge in one or more subjects. We have a range of subjects available for enrolment. Most enable ākonga to earn credits towards national qualifications. Young adults enrolled in three or more courses will have a kaimanaaki who will help them plan a full programme of study through a personalised learning plan. The process of developing a personalised learning plan is supported by My Korowai, the online learning plan platform in My Te Kura. My Korowai guides ākonga to share, develop and reflect on their learning, interests, and goals.

Programmes of learning are guided by Te Ara Pounamu. Our approach to learning focuses on ākonga's passions and goals for life beyond school. It uses these as a basis for a personalised learning plan that is unique to each ākonga. Ākonga may be working across NCEA levels through subjects and integrated modules of learning that support their interests and preferred pathways, and through project explorations. Ākonga take part in regular online or face-to-face huinga ako with their kaimanaaki to support their programme of learning. They will also have the chance to explore opportunities in their community, which may include internships and tertiary exploration, as well as working towards a relevant qualification. Learning is delivered through My Te Kura, Te Kura's online learning environment.

Adult ākonga

Adult ākonga can enroll in one or more courses. Most courses are designed as one-year courses, but individual ākonga may work faster or slower than this. Many courses offer a range of options. Ākonga support advisors and kaiako will assist ākonga with their choices. Learning is delivered through My Te Kura, Te Kura's online learning environment.

Special Education/Learning Support – Te Akoranga Motuhake

Learning support refers to the additional support some ākonga need to engage and achieve in education. We design a programme to match the needs, interests and context of the individual. A dedicated kaimanaaki works closely with whānau and specialist support services (if required) to develop a personalised programme that takes individual needs and strengths into account. Learning Support courses are open to all ākonga in the compulsory education years and to adults. Early childhood tamariki with learning support needs are taught by our Early Childhood kaimanaaki. Read more about Learning Support on page 16.

Dual ākonga

Ākonga enrolled in New Zealand schools and with other education providers (e.g. Teen Parent Units, Alternative Education) may also be eligible for registration for courses with Te Kura. Dual tuition arrangements are between that provider and Te Kura.

The Dual Provider Partnership Agreement, which sets out the responsibilities of both providers, can be found on Te Kura's website www.tekura.school.nz/dual-providers/dual-provider-partnership-agreement-dppa/

Dual registrations for ākonga are made online by the primary provider for that ākonga through the Te Kura Enrolment System. Registrations are accepted throughout the year and open on 22 November for the 2022 school year.

Schools are expected to ensure ākonga are enrolled in the course at the most appropriate curriculum level. Some courses require prior study. Most Te Kura courses are delivered online. Schools must ensure that ākonga have access to the required hardware, software and internet.

Further information is available on our website www.tekura.school.nz/dualproviders

Fees

If an ākonga meets the Ministry of Education's criteria for enrolling with us, there are no school fees. Adult ākonga pay an administration fee.

In some circumstances ākonga who do not meet Ministry of Education eligibility criteria for a funded place may be able to enrol with Te Kura as a fee-paying ākonga. Fees are on a per-course basis. Ākonga already enrolled at another school must be registered and the fee paid by their home school.

To find out more, visit our website at www.tekura.school.nz or contact Te Kura's Ākonga and Whānau Support team on 0800 65 99 88 option 1 or email enrolment@tekura.school.nz

Equipment required for online learning

Every ākonga enrolled in an online course needs a suitable device and access to the internet. For advice about getting set up for learning online, visit our website www.tekura.school.nz/learn-with-us/get-started or contact Te Kura's Ākonga and Whānau Support team, phone 0800 65 99 88 option 2 or email hub@tekura.school.nz.

Device and connectivity assistance

Te Kura offers a device and an internet subsidy of \$30 per month to eligible ākonga – either a current full-time ākonga or a young adult ākonga enrolled in three or more online courses.

Ākonga themselves or those financially responsible for an ākonga, who receive a benefit from Work and Income or have a Community Services Card, can apply for the subsidy.

Additional connectivity assistance of \$30 per month is available for an eligible ākonga who is enrolled through a gateway of geographic inaccessibility, geographic isolation, or itinerancy.

Ākonga who withdraw from Te Kura must return the device.

The internet subsidy is \$30 per month during the school year and is paid directly into the applicant's bank account. The subsidy will cease as soon as the ākonga is no longer enrolled with Te Kura.

Applications for assistance open on 10 January 2021. You can apply online or download an application form on our website at www.tekura.school.nz. Or an application can be made over the phone by calling our Ākonga and Whānau Support team on 0800 65 99 88 option 2.

Qualifications

Under the New Zealand Qualifications Framework (NZQF), it is possible to build a programme of learning so that credits attained can contribute to more than one qualification. At Te Kura, we offer the NCEA certificates at Levels 1–3, as well as other New Zealand certificates, so it is possible for ākonga to work towards more than one qualification at the same time. Detailed information about these qualifications can be found on our website or the New Zealand Qualifications Authority (NZQA) website at www.nzqa.govt.nz.

National Certificate of Educational Achievement

Ākonga enrolling in a one-year National Certificate of Educational Achievement (NCEA) course should aim to achieve 18–20 credits. This requires about 200 hours of ākonga study time.

It is important ākonga take advice from their kaiako, kaimanaaki and/or ākonga support staff so they choose a balanced programme of learning that matches their aspirations and abilities. A suitable learning programme may include courses across multiple curriculum or NCEA levels.

To gain **NCEA Level 1**, ākonga must have 80 credits. These credits can be made up of unit standards and achievement standards at any level, including a literacy and numeracy requirement.

To gain **NCEA Level 2**, ākonga must have 80 credits.

- 60 of these must be from standards at Level 2 or above.
- 20 credits at Level 1 or above may have already been counted for Level 1 and still count towards a Level 2 certificate.

They must also meet the NCEA Level 1 literacy and numeracy requirements.

To gain **NCEA Level 3**, ākonga must have 80 credits.

- 60 of these must be from standards at Level 3 or above.
- 20 credits at Level 2 or above may have already been counted for Level 2 and still count towards a Level 3 certificate.

They must also meet the NCEA Level 1 literacy and numeracy requirements.

Literacy and numeracy requirements

Standards offered at Te Kura that count towards NCEA Level 1 literacy and numeracy requirements are identified in the course descriptions in this book.

- **Literacy** – either a minimum 10 credits through a package of three literacy unit standards or a minimum of 10 credits through specified achievement standards.
- **Numeracy** – either a minimum 10 credits through a package of three numeracy unit standards or a minimum of 10 credits through specified achievement standards.

For a full list of literacy and numeracy standards see www.nzqa.govt.nz/ncea/subjects/literacy-and-numeracy/level-1-requirements/

Course endorsement

Ākonga will gain course endorsement with achieved if, in a calendar year, they gain 14 or more credits at achieved or higher in the course.

Ākonga will gain course endorsement with merit if, in a calendar year, they gain 14 or more credits at merit and/or excellence in a course.

They will gain course endorsement with excellence if, in a calendar year, they gain 14 or more credits at excellence in a course.

These must include at least three credits from externally assessed standards and at least three credits from internally assessed standards in that course.

Some courses offer only externally assessed or internally assessed standards and are therefore not eligible for endorsement.

Certificate endorsement

Ākonga can gain NCEA certificates endorsed with merit or excellence. An NCEA certificate endorsed with merit is awarded if they gain 50 credits at merit level (or a mix of merit and excellence) across courses. An NCEA certificate endorsed with excellence is awarded if they gain 50 credits at excellence level across courses.

University Entrance

To be awarded University Entrance (UE) ākonga must have:

- NCEA Level 3
- three subjects at Level 3 or above made up of:
 - 14 Achievement Standard credits each, in three approved subjects. (For a full list of approved subjects see www.nzqa.govt.nz/qualifications-standards/awards/university-entrance/approved-subjects/)
 - Literacy – 10 credits at Level 2 or above made up of:
 - five credits in reading
 - five credits in writing
 - Numeracy – 10 credits at Level 1 or above made up of:
 - Achievement Standards (specified achievement standards available through a range of subjects) or Unit Standards (package of three numeracy unit standards).

Standards available at Te Kura that count towards UE literacy and numeracy requirements are identified in the course descriptions in this book. (For a full list of UE literacy and numeracy standards see www.nzqa.govt.nz/qualifications-standards/awards/university-entrance/)

Vocational Pathways

Vocational Pathways provide ways to achieve NCEA Levels 1–3 and develop pathways that progress to further study, training and employment. Achieving NCEA Level 2 is the foundation for success in further education and the world of work. Level 3 builds upon this through shared opportunities across school, tertiary, and industry training.

The Vocational Pathways provide a framework for ākonga to show how their learning and achievement is valued in the workplace by aligning learning to the skills needed for industry.

The six Vocational Pathways are:

- Primary Industries
- Construction and Infrastructure
- Manufacturing and Technology
- Social and Community Services
- Services Industries
- Creative Industries.

To obtain a Vocational Pathways Award, an ākonga needs to gain NCEA Level 2, including:

- 60 Level 2 credits from recommended standards from a Vocational Pathways sector, including 20 credits from sector-related standards for that sector. To achieve these, they will need to be part of our Gateway or Huarahi (Te Kura's Trades Academy) and participate in relevant STAR programmes.

Vocational Pathways Award(s) will show on an ākonga's NZQA Record of Achievement.



Vocational Pathways wheel diagram © New Zealand Ministry of Education. Used by permission.

Level 3 Achievement Standards and current Levels 3–7 local, national, and New Zealand qualifications have been mapped to Vocational Pathways to provide ākonga with an ongoing pathway. The maps help ākonga intending to study towards NCEA Level 3 and other Level 3 qualifications to make informed choices about their study options in relation to the type of degree-level study they wish to pursue.

For more information, talk to your learning advisor or visit www.youthguarantee.net.nz

New Zealand Certificates

Credits gained towards NCEA are automatically counted towards New Zealand Certificates by NZQA. Te Kura offers a wide range of New Zealand Certificates, some of which are completed through partnerships – such as Gateway, Trades Academies and work placements.

STAR

Secondary Tertiary Alignment Resources (STAR), are short taster courses offered through Polytechnics and Private Training Organisations. Each Te Kura region has a secondary–tertiary advisor who, alongside the learning advisor, organises these programmes for ākonga.

Gateway

Gateway is a structured, work-based learning programme for ākonga aged 16–19 years in an industry of the ākonga’s choice. Te Kura’s Gateway coordinator will work out a programme with the ākonga that includes work-based learning that can be assessed. Ākonga can gain credits while also working towards NCEA, for one term or longer. Gateway is not necessarily linked to a Polytech or other tertiary provider.

Huarahi Trades Academy

Trades Academy is a one or two-year programme, for ākonga aged 16–19 years. Huarahi is our Trades Academy which is supported by partnerships with tertiary providers across New Zealand. Ākonga work with them and Te Kura to gain industry standards towards a National Certificate and NCEA Level 2.

Programme planning

This Choice Guide is organised by subject and level of study. These may be curriculum Levels 1–8 or qualification levels NCEA 1–3. The diagram below shows how curriculum levels typically relate to years at school. Note that many ākonga do not necessarily fit this pattern, for example, those with learning support needs, those who are gifted in a particular aspect of the curriculum, or those who are beginner learners of languages.

Years and Curriculum Levels

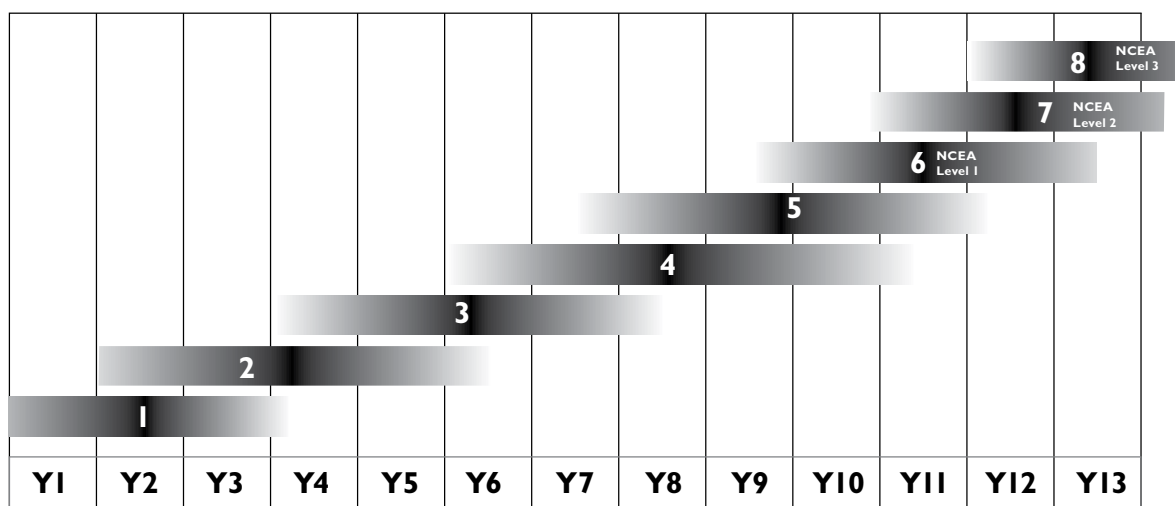
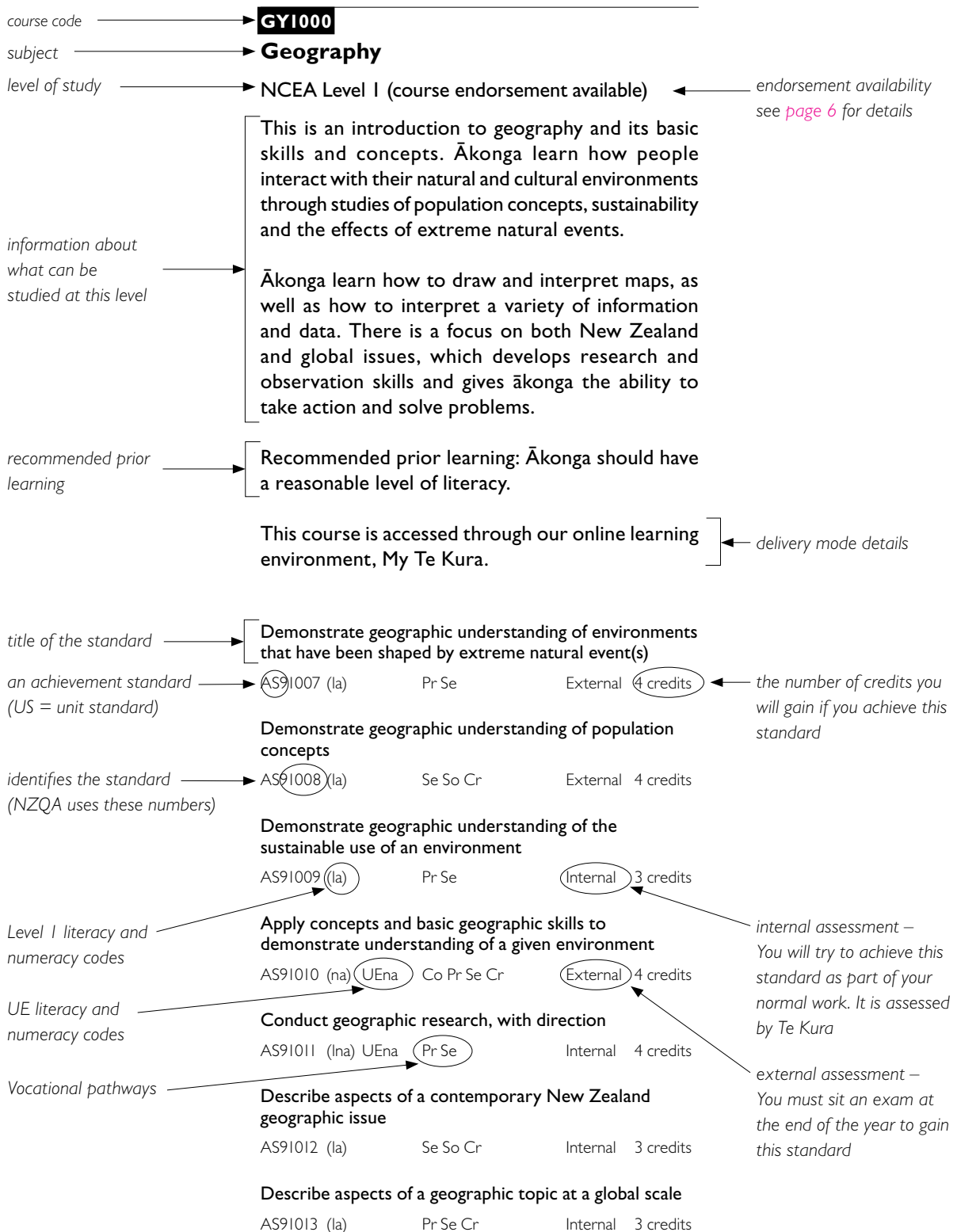

Diagram (adapted): Levels of Achievement by Years of Schooling, in the New Zealand Curriculum, first published by Learning Media Ltd on behalf of the Ministry of Education, Wellington, NZ. Copyright © Crown, Curriculum Doc, 2007. Used by permission.

How to use this guide

The information in this guide is also available online. Refer to www.tekura.school.nz for the most up-to-date information.



NCEA Level I Literacy and Numeracy requirements

For details of these requirements, please refer to the NZQA website –

www.nzqa.govt.nz/ncea/subjects/literacy-and-numeracy/level-I-requirements/

Standards that count towards these requirements are identified as below

- (la) Literacy achievement standard
- (na) Numeracy achievement standard
- (lna) Literacy and numeracy achievement standard
- (nu) Numeracy unit standard
- (lu) Literacy unit standard

University Entrance literacy and numeracy requirements

For details of these requirements, please refer to the NZQA website –

www.nzqa.govt.nz/qualifications-standards/awards/university-entrance/

Standards that count towards these requirements are identified as below

- (UEna) UE numeracy achievement standard
- (UEnu) UE numeracy unit standard
- (UElwa) UE literacy writing achievement standard
- (UElra) UE literacy reading achievement standard
- (UElwra) UE literacy writing and reading achievement standard
- (UEnlra) UE numeracy and literacy reading achievement standard
- (UEnlwa) UE numeracy and literacy writing achievement standard
- (UEnlwra) UE numeracy, literacy writing and literacy reading achievement standard

Vocational Pathways requirements

For details of these requirements, please refer to

<http://youthguarantee.net.nz/vocational-pathways/>

You can access this website directly or from your NZQA learner login.

Standards that count towards these requirements are identified as below

- Co Construction and Infrastructure recommended standard
- SCo Construction and Infrastructure sector-related standard
- Ma Manufacturing and technology recommended standard
- SMA Manufacturing and technology sector-related standard
- Pr Primary Industries recommended standard
- SPr Primary Industries sector-related standard
- Se Service Industries recommended standard
- SSe Service Industries sector-related standard
- So Social and Community Services recommended standard
- SSo Social and Community Services sector-related standard
- Cr Creative Industries recommended standard
- SCr Creative Industries sector-related standard

Early Childhood

Te Ara Kōhungahunga

The Te Kura Early Childhood service offers a high-quality, personalised early education programme to children aged from 2–6 years. The programme works within the framework of *Te Whāriki – he whāriki mātauranga mō ngā mokopuna o Aotearoa*, the New Zealand Early Childhood Curriculum.

PRINCIPLES

EMPOWERMENT | WHAKAMANA

HOLISTIC DEVELOPMENT | KOTAHITANGA

FAMILY AND COMMUNITY | WHĀNAU TANGATA

RELATIONSHIPS | NGĀHONONGA

STRANDS

WELLBEING | MANA ATUA

BELONGING | MANA WHENUA

CONTRIBUTION | MANA TANGATA

COMMUNICATION | MANA REO

EXPLORATION | MANA AOTŪROA

Through the programme, whānau, parents (or caregivers) and kaiako work in partnership to share information about children’s learning and development. This shared knowledge informs the development of the child’s programme of learning. The programme is accessed through our online learning environment – My Te Kura. Kaiako communicate with whānau through this platform as well as by phone, email and video calls and regional visits annually.

A blend of online learning resources and some learning materials such as books, art materials and manipulative resources are provided to support the learning taking place at home.

The programme is free of charge. Children can attend a licensed early childhood centre for up to twelve hours per week and still qualify for the Te Kura early childhood programme once enrolled.

Years 1 to 6

Te Ara Tipu

Te Ara Tipu is Te Kura's learning programme for ākonga in Years 1–6. Learning in Te Ara Tipu is guided by Te Ara Pounamu, our Te Kura local curriculum, and incorporates the key competencies and the eight learning areas of The New Zealand Curriculum. Ākonga are allocated a kaimanaaki who works closely with the ākonga and their whānau to develop a personalised programme that values their identity, language and culture, and is based on their interests, abilities and learning needs.

The programme of learning is accessed through our online learning environment – My Te Kura. A careful mix of online learning activities in My Te Kura, virtual classroom activities, books, and some hard copy resources combine to extend learning opportunities based on learner interests and needs.

A personalised learning plan is developed in My Korowai, the online learning plan platform in My Te Kura, with input from ākonga, whānau, supervisors and kaimanaaki. There are regular reviews of the ākonga's learning plan, discussion of progress against goals, and opportunities to set new goals. Ākonga may wish to learn through theme-based cross-curricular projects in an area of interest or based around their daily life. The ākonga and their whānau work with their kaimanaaki to decide on the theme and scope of a project, and appropriate teaching and assessment.

Ākonga can contact their kaimanaaki via email, from within My Te Kura, or by phone. Ākonga also have the opportunity to meet their kaimanaaki or other Te Kura kaiako at huinga ako and other organised activities throughout the year.

Enrolment criteria

Te Kura provides distance education for ākonga living in New Zealand and overseas, from early childhood level through to Year 13.

You may be able to enrol with us if you meet certain eligibility criteria set by the Ministry of Education. Check your eligibility on our website at www.tekura.school.nz/enrol/, or call 0800 65 99 88

The New Zealand Curriculum		
Vision Young people who will be confident, connected, actively involved, lifelong learners.		
Values Excellence; Innovation, inquiry and curiosity; Diversity; Equity; Community and participation; Ecological sustainability; Integrity; Respect.	Key competencies Thinking; Using language, symbols and texts; Managing self; Relating to others; Participating and contributing.	Learning areas English; the Arts; Health and Physical education; Learning languages; Mathematics and statistics; Science; Social Sciences; Technology.
Principles High expectations Treaty of Waitangi Cultural diversity Inclusion Learning to learn Community engagement Coherence Future focus		

Years 7 to 10

Te Ara Hou

Te Ara Hou is Te Kura's learning programme for full-time ākonga in Years 7–10. Learning in Te Ara Hou is guided by Te Ara Pounamu, our Te Kura local curriculum, and incorporates the key competencies and eight learning areas of The New Zealand Curriculum. Ākonga are allocated a kaimanaaki who works closely with the ākonga and their whānau to develop a personalised programme that values their identity, language and culture, is based on their interests and goals, and keeps options open for future learning, including study at NCEA level 1.

The programme of learning is accessed through our online learning environment – My Te Kura. A careful mix of online learning activities in My Te Kura, virtual classroom activities, books, and some hard copy resources combine to extend learning opportunities based on learner interests and needs.

A personalised learning plan is developed in My Korowai, the online learning plan platform in My Te Kura, with input from ākonga, whānau, aiga and kaimanaaki. There are regular reviews of the ākonga's learning plan, discussion of progress against goals, and opportunities to set new goals. Ākonga may wish to learn through theme-based cross-curricular projects in an area of interest or based around their daily life. The ākonga and their whānau work with their kaimanaaki to decide on the theme and scope of a project, and appropriate teaching and assessment.

Ākonga can contact their kaimanaaki via email, from within My Te Kura, or by phone. Ākonga also have the opportunity to meet their kaimanaaki or other Te Kura kaiako at huinga ako and other organised activities throughout the year.

Enrolment criteria

Te Kura provides distance education for ākonga living in New Zealand and overseas, from early childhood level through to Year 13.

You may be able to enrol with us if you meet certain eligibility criteria set by the Ministry of Education. Check your eligibility on our website at www.tekura.school.nz/enrol/, or call 0800 65 99 88.

The New Zealand Curriculum		
Vision Young people who will be confident, connected, actively involved, lifelong learners.		
Values Excellence; Innovation, inquiry and curiosity; Diversity; Equity; Community and participation; Ecological sustainability; Integrity; Respect.	Key competencies Thinking; Using language, symbols and texts; Managing self; Relating to others; Participating and contributing.	Learning areas English; the Arts; Health and Physical education; Learning languages; Mathematics and statistics; Science; Social Sciences; Technology.
Principles High expectations Treaty of Waitangi Cultural diversity Inclusion Learning to learn Community engagement Coherence Future focus		

Learning Support/Special Education

Te Akoranga Motuhake

Learning Support

Learning Support refers to the additional support some ākonga need to engage and achieve in education. As with all full-time ākonga, a dedicated kaimanaaki will work closely with whānau and specialist support services (if required) to develop a personalised programme that takes individual needs and strengths into account.

Some ākonga with learning support needs will be able to access My Te Kura, our online learning environment, once specific supports are in place. Ākonga with higher and more complex learning needs, for example, those receiving ORS funding, may use a mix of online, print and other resources.

A personalised learning plan is developed in My Korowai, the online learning plan platform in My Te Kura, with input from ākonga, whānau, kaimanaaki, and the support team. There are regular reviews of the ākonga's learning plan, discussion of progress against goals, and opportunities to set new goals.

Dual-enrolled ākonga in Years 1–8 are eligible to enrol in SEENG, SEMAS and SETOP, under the Learning Support Needs gateway.

Special Education

The courses offered under Special Education vary in curriculum levels. They ensure coverage of seven learning areas, as well as two life skill courses and are open to all ākonga in the compulsory education years and to adults.

SEENG

Special Education English

Curriculum Level 1

This includes developing reading, writing, listening and speaking, and teaching ākonga how to view and present work. There are a range of learning activities, and each programme is designed to meet the specific learning needs and interests of the individual.

This course uses paper-based resources.

SEHPE

Special Education Health and PE

Curriculum Level 1

This course supports ākonga to develop skills and abilities across the four strands of the curriculum: relationships with other people, movement concepts and motor skills, healthy communities and environments, and personal health and physical development.

This course uses paper-based resources.

SEMAS

Special Education Mathematics

Curriculum Level 1

This course covers level one strands in maths and statistics. Emerging level one covers basic concepts of colour, shape, size and position. Topics explore numeracy stages 0–4, algebra, geometry and measurement.

This course uses paper-based resources.

SEART

Special Education Art

Curriculum Level 1

This course covers the four curriculum strands of visual art, music, dance and drama, exploring art and design in their environment and daily lives. Ākonga use a variety of techniques and materials to explore collage, mosaics, decorations and wearable art. They listen to and respond to a broad range of sounds, music and visual images, sharing ideas about sounds and music in everyday life and exploring ways to create and represent sound.

This course uses paper-based resources.

SESCI**Special Education Science**

Curriculum Level I

This course is designed to support early scientific understandings and skills. Learning is based on practical activities, with ākongā encouraged to ask questions, predict, investigate and communicate their ideas about the natural, physical and material worlds and wider universe. Ākongā will explore a range of scientific concepts and how they relate to the everyday world, from outer space and dinosaurs through to shadows, insects and chemistry in the kitchen.

This course uses paper-based resources.

SESST**Special Education Social Studies**

Curriculum Level I

This course explores a range of social contexts, past and present, from New Zealand and the world, and is designed to develop questioning skills, gathering and presenting information. The four strands cover identity, culture and organisation, place and environment; continuity and change; and the economic world.

This course uses paper-based resources.

SETEC**Special Education Technology**

Curriculum Level I

This course is designed to build confidence in using everyday technology in practical tasks and to support ākongā to participate in a constantly changing world. Throughout this course, ākongā take part in a range of practical work from preparing food to sending messages.

This course uses paper-based resources.

SETOP**Special Education Topic**

Curriculum Level I

This course explores a number of integrated topics of interest across several learning areas. It includes all the SE learning area courses listed above.

This course uses paper-based resources.

SELS**Special Education Life Skills**

Curriculum Level I

(This course is not available for dual-enrolled ākongā.)

This course is designed for ākongā working at the very earliest stages of curriculum level I. Learning materials are selected to help ākongā develop some basic living skills. Programmes are designed in collaboration with the whānau or learning support kaiako and reflect the age, interests, abilities and contexts of the ākongā.

This course uses paper-based resources.

LS100**Life Skills**

Curriculum Levels 2–5

This course provides opportunities to develop skills for everyday living and can lead into further study in Pathways education. The focus is on developing knowledge and skills to assist with everyday living and includes preparation for employment; job interviews; goal setting; budgeting; shopping; time management; form filling; interpersonal and social skills, accessing information in maps and timetables. The learning materials and experiences are ideal for ākongā in Years 9–10.

Recommended prior learning: No prior learning needed.

This course can be accessed through My Te Kura, our online learning environment. A paper equivalent is also available.

SL1000**Supported Learning Standards**

Curriculum Level 1

Supported Learning Standards are intended for ākonga at Year 10 and above capable of working on NCEA Level 1 standards who require some form of support with their learning either through additional resources, specialised equipment or adapted teaching programmes. These ākonga with learning disabilities also include those with an intellectual disability.

Ākonga work towards achieving the New Zealand Certificate in Skills for Living for Supported Learners (Level 1) 55 credits. The optional strand in Skills for Working is not available.

The programme is designed to support ākonga to self-manage and participate in social, cultural, whānau and community contexts to improve their educational or employment pathways, and to assist them to become productive citizens of Aotearoa New Zealand.

The Kaiako Matua Learning Support will approve enrolment on a case-by-case basis.

Ākonga completing this course must have the support of a kaiāwhina to act as the supervisor for the assessments.

Recommended prior learning: No prior learning needed.

This course can be accessed through My Te Kura, our online learning environment. A paper equivalent is also available.

Describe the terms associated with whakapapa and use them within a family structure

US27106 Internal 2 credits

Describe the protocols and roles associated with pōwhiri in accordance with tikanga and/or kawa

US27108 Internal 2 credits

Maintain routines and commitments

US29298 Internal 8 credits

Access and use facilities and services in the community

US29299 Internal 4 credits

Maintain hauora – personal health and well-being

US29300 Internal 4 credits

Demonstrate strategies to ensure personal safety

US29301 Internal 4 credits

Demonstrate interpersonal skills in familiar contexts

US29302 Internal 4 credits

Demonstrate behaviours appropriate to different types of relationships and contexts

US29303 Internal 4 credits

Describe elements of own culture, basic rights and responsibilities of being a citizen of Aotearoa

US29304 Internal 4 credits

Carry out a plan to achieve personal goals

US29305 Internal 4 credits

Apply problem solving strategies to resolve day to day issues

US29306 Internal 5 credits

Apply literacy skills in a range of day to day contexts

US29307 Internal 5 credits

Apply numeracy skills in a range of day to day contexts

US29308 Internal 5 credits

Discipline thinking – subjects at a glance

Summary of subjects and levels of study

Detailed information follows in this guide. Refer to www.tekura.school.nz for the most up-to-date information.

Subject	Up to Curriculum Level 5	NCEA Level 1	NCEA Level 2	NCEA Level 3
Accounting		Accounting	Accounting	Accounting
Art (visual)	Visual Arts	Visual Arts	Visual Arts	Painting
				Design
				Sculpture
				Printmaking
				Photography
Art History			Art History	Art History
Biology		Biology	Biology	Biology
Business Studies		Business Studies	Business Studies	
Chemistry		Chemistry	Chemistry	Chemistry
Chinese (Mandarin)	Chinese (beginners)	Chinese	Chinese	Chinese
Classical Studies			Classical Studies	Classical Studies
				Religious Studies
Design and Visual Communication	Design and Visual Communication	Design and Visual Communication	Design and Visual Communication	Design and Visual Communication
Digital Technology	Digital Technology	Digital Technology	Digital Technology	Digital Technology
Economics		Economics	Economics	Economics
English	English	English	English	English
Enterprise Studies	Enterprise Studies			
French	French (beginners)	French	French	French
Gateway		Gateway	Gateway	Gateway
Geography		Geography	Geography	Geography
German	German (beginners)	German	German	German
Health Education	Health Education	Health Education	Health Education	Health Education
History		History	History	History (England)
				History (New Zealand)
Home Economics	Home Economics	Home Economics	Home Economics	Home Economics
Japanese	Japanese (beginners)	Japanese	Japanese	Japanese
Kaupapa Māori	Kaupapa Māori	Kaupapa Māori	Kaupapa Māori	Kaupapa Māori
Learner Support	Learner Support			
Legal Studies		Legal Studies	Legal Studies	Legal Studies
Life Skills	Life Skills			

Subject	Up to Curriculum Level 5	NCEA Level 1	NCEA Level 2	NCEA Level 3
Mathematics	Mathematics and Statistics	Mathematics and Statistics	Mathematics and Statistics	Calculus
				Statistics
				Mathematics
Media Studies		Media Studies	Media Studies	Media Studies
Music	Music	Music	Music	Music
Pathways Education		Pathways Education	Pathways Education	
		Pregnancy and Wellbeing of Children	Pregnancy and Wellbeing of Children	
Performing Arts		Dance	Dance	Dance
Physics		Physics	Physics	Physics
Physical Education	Physical Education	Physical Education	Physical Education	Physical Education
Primary Production	Primary Production	Primary Production	Primary Production	Primary Production
Samoan		Samoan	Samoan	
Science	Science	Science	Science (selection)	
Social Studies	Social Studies			
Spanish	Primary Spanish	Spanish	Spanish	Spanish
	Spanish (beginners)			
Special Education	Special Education			
Te Ara Kōhungahunga (Early Childhood)	Early Childhood			
Te Ara Tipu (Years 0–6)	Primary			
Te Ara Hou (Years 7–10)	Te Ara Hou			
Technology	Technology	Technology	Technology	Technology
Te Reo Māori	Primary Te Reo Māori	Te Reo Māori	Te Reo Māori	Te Reo Māori
	Te Reo Māori (beginners)			

Accounting

Te Mātauranga Mahi Kaute

Accounting is fundamental for business and for everyday life. Ākonga gain financial literacy and the tools to make real-life financial decisions in a changing and uncertain world. One of the vital skills ākonga learn is how to prepare and communicate financial information to a wide range of people. Further study can lead to a career in accounting in many diverse businesses worldwide. With a business or commerce degree, you can keep your options wide open.

AC1000

Accounting

NCEA Level 1 (course endorsement available)

Financial literacy is an essential lifelong skill. This course gives ākonga the tools to make real-life financial decisions in a range of situations. Ākonga develop the knowledge and skills to manage the financial affairs of individuals, community organisations and sole traders. There is an emphasis on preparing financial information and effectively communicating that information.

Recommended prior learning: Ākonga should have a reasonable level of literacy.

This course is accessed through our online learning environment, My Te Kura.

Demonstrate understanding of accounting concepts for small entities

AS90976 (la) Pr Se Cr External 3 credits

Process financial transactions for a small entity

AS90977 Se Cr Internal 5 credits

Prepare financial statements for sole proprietors

AS90978 External 5 credits

Prepare financial information for a community organisation's annual general meeting

AS90979 (la) Internal 4 credits

Interpret accounting information for sole proprietors

AS90980 (la) Pr Cr External 4 credits

Make a financial decision for an individual or group

AS90981 (la) Internal 3 credits

Demonstrate understanding of cash management for a small entity

AS90982 (la) Se Cr Internal 4 credits

AC2000

Accounting

NCEA Level 2 (course endorsement available)

This course builds on the knowledge already gained in Level 1. It has a strong focus on accounting for sole traders and is useful for people interested in running their own business. Ākonga gain further knowledge, skills and experience needed to manage a small business, including the basics of managing inventory and accounts receivable processes. Ākonga process and interpret financial transactions and then, more importantly, report on this financial information. A practical segment using the accounting software MYOB is also included.

Recommended prior learning: Ākonga should have a reasonable level of literacy.

This course is accessed through our online learning environment, My Te Kura.

Demonstrate understanding of accounting concepts for an entity that operates accounting subsystems

AS91174 (la) Se External 4 credits

Demonstrate understanding of accounting processing using accounting software

AS91175 (na) UEna Se Cr Internal 4 credits

Prepare financial information for an entity that operates accounting subsystems

AS91176 (na) UEna External 5 credits

Interpret accounting information for entities that operate accounting subsystems

AS91177 (lna) UEna External 4 credits

Demonstrate understanding of an accounts receivable subsystem for an entity

AS91179 (lna) UEna Internal 3 credits

Demonstrate understanding of an inventory subsystem for an entity

AS91386 (lna) UEna SSe Internal 3 credits

Demonstrate understanding of a contemporary accounting issue for decision-making

AS91481 (la) Internal 4 credits

AC3000**Accounting**

NCEA Level 3 (course endorsement available)

Ākonga develop knowledge from previous levels within the context of companies and partnerships. Ākonga gain knowledge, skills and experience in using management for effective decision making. Ākonga report, analyse and interpret information for partnerships, manufacturing businesses and companies. Accounting NCEA Level 3 and Scholarship prepares ākonga for tertiary education.

New Zealand Scholarship exams are designed to extend very high-achieving Level 3 ākonga. Those who wish to enter the New Zealand Scholarship exam in this subject must discuss this option with their Te Kura subject kaiako.

Recommended prior learning: Ākonga should have a reasonable level of accounting knowledge.

This course is accessed through our online learning environment, My Te Kura.

Demonstrate understanding of accounting concepts for a New Zealand reporting entity

AS91404 (la) UElwra Se Cr External 4 credits

Demonstrate understanding of accounting for partnerships

AS91405 (na) UEna Se Cr Internal 4 credits

Demonstrate understanding of company financial statement preparation

AS91406 (na) UEna Se External 5 credits

Prepare a report for an external user that interprets the annual report of a New Zealand reporting entity

AS91407 (lna) UEnlwra Internal 5 credits

Demonstrate understanding of management accounting to inform decision-making

AS91408 (lna) UEna Pr Se External 4 credits

Demonstrate understanding of a job cost subsystem for an entity

AS91409 (lna) UEna Internal 4 credits

Art

Te Mātauranga Toi

Visual arts is a subject that allows ākonga to express and develop their creativity, while developing their knowledge and skills. Ākonga create their own artworks while learning about the work of other artists and the cultural and social contexts that these artworks reflect. Ākonga can study visual arts to gain qualifications or to explore their interest in art.

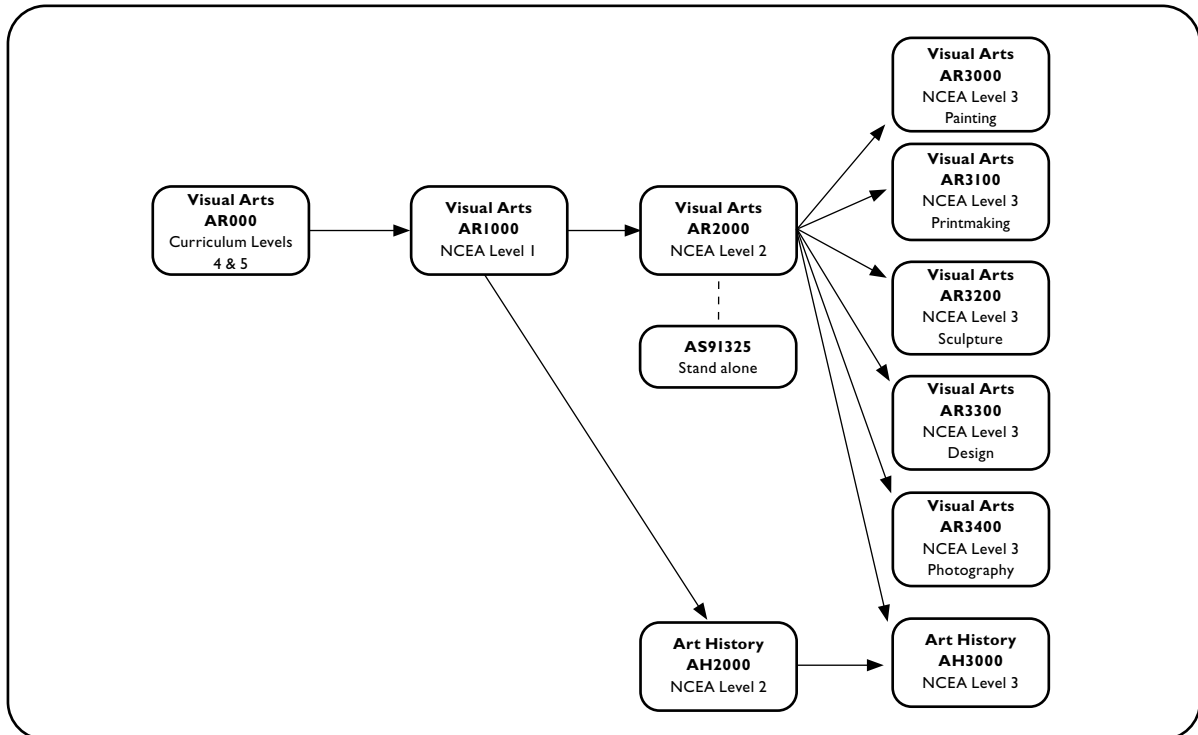

AR000

Visual Arts

Curriculum Levels 4–5

Ākonga are given an introduction to drawing, painting, sculpture and design using a variety of techniques and media. An awareness of the process of developing artistic ideas from start to finish is introduced, and ākonga can plan an appropriate programme to meet their needs and interests in art. Year 10 ākonga can further develop skills and knowledge appropriate for moving forward to NCEA qualifications at Year 11.

Recommended prior learning: No prior learning needed.

This course is accessed through our online learning environment, My Te Kura.

AR1000

Visual Arts

NCEA Level 1 (course endorsement available)

This is the first of the NCEA art courses. It enables ākonga to develop ideas and creative approaches to making artworks in a range of fields. Ākonga work is informed by their research of New Zealand artists from Māori, Polynesian and European traditions. Ākonga can work towards an individual standard or multiple standards including developing a body of work for the external folio standard.

Recommended prior learning: Curriculum Levels 4–5 Art or equivalent.

This course is accessed through our online learning environment, My Te Kura.

Demonstrate understanding of art works from a Māori and another cultural context using art terminology

AS90913 (1a)

Se Cr

Internal 4 credits

Use drawing methods and skills for recording information using wet and dry media
AS90914 Cr Internal 4 credits

Use drawing conventions to develop work in more than one field of practice
AS90915 Cr Internal 6 credits

Produce a body of work informed by established practice, which develops ideas, using a range of media
AS90916 Cr External 12 credits

Produce a finished work that demonstrates skills appropriate to cultural conventions
AS90917 Cr Internal 4 credits

AR2000

Visual Arts

NCEA Level 2 (course endorsement available)

From a foundation of NCEA Level 1 Visual Arts, ākongā continue to critically develop ideas and creative approaches to making artworks. Ākongā can produce a body of work in Painting by completing multiple internal standards culminating in the portfolio external standard. Alternatively, ākongā can undertake two internal standards in Photography and/or Design.

For ākongā not wanting to complete a full art programme, it is possible, with the consultation of the senior kaiako, to undertake AS91325: Produce a resolved work that demonstrates control of skills appropriate to cultural conventions, (Visual Arts 2.5). This is a single, standalone standard in any art discipline. This opportunity particularly suits ākongā with existing interest and skills, a passion project or artist mentor relationship. Projects should strongly identify with a specific art tradition or art field convention.

Recommended prior learning: NCEA Level 1 Visual Art course or equivalent.

This course is accessed through our online learning environment, My Te Kura.

Demonstrate an understanding of methods and ideas from established practice appropriate to painting
AS91306 (la) SCr Internal 4 credits

Use drawing methods to apply knowledge of conventions appropriate to design
AS91310 SCr Internal 4 credits

Use drawing methods to apply knowledge of conventions appropriate to painting
AS91311 SCr Internal 4 credits

Use drawing methods to apply knowledge of conventions appropriate to photography
AS91312 SCr Internal 4 credits

Develop ideas in a related series of drawings appropriate to established design practice
AS91315 SCr Internal 4 credits

Develop ideas in a related series of drawings appropriate to established painting practice
AS91316 SCr Internal 4 credits

Develop ideas in a related series of drawings appropriate to established photography practice
AS91317 SCr Internal 4 credits

Produce a systematic body of work that shows understanding of art making conventions and ideas within painting
AS91321 Cr External 12 credits

Produce a resolved work that demonstrates control of skills appropriate to cultural conventions
AS91325 Cr Internal 4 credits

AR3000

Painting

NCEA Level 3 (course endorsement available)

In Level 3 Painting, ākongā study, develop and produce a body of work. They learn to critically engage, evaluate and investigate artistic procedures and practices. Researching the work of contemporary artists informs the development of their own ideas. Ākongā can produce a body of work in Painting by completing the two internals culminating in the portfolio external standard. Although the emphasis is on painting, ākongā work can demonstrate influences from design, printmaking, sculpture and photography.

New Zealand Scholarship exams are designed to extend very high-achieving Level 3 ākongā. Those who wish to enter the New Zealand Scholarship exam in this subject must discuss this option with their Te Kura subject kaiako.

Recommended prior learning: NCEA Level 2 Visual Art course or equivalent.

This course is accessed through our online learning environment, My Te Kura.

Use drawing to demonstrate understanding of conventions appropriate to painting

AS91446 Cr Internal 4 credits

Systematically clarify ideas using drawing informed by established painting practice

AS91451 Cr Internal 4 credits

Produce a systematic body of work that integrates conventions and regenerates ideas within painting practice

AS91456 Cr External 14 credits

AR3100

Printmaking

NCEA Level 3 (course endorsement available)

In Level 3 Printmaking, ākonga study, develop and produce a body of work. They learn to critically engage, evaluate and investigate artistic procedures and practices. Researching the work of contemporary artists informs the development of their own ideas. Ākonga can produce a body of work in Printmaking by completing the two internals culminating in the portfolio external standard. Although the emphasis is on printmaking, ākonga work can demonstrate influences from design, painting, sculpture and photography.

New Zealand Scholarship exams are designed to extend very high-achieving Level 3 ākonga. Those who wish to enter the New Zealand Scholarship exam in this subject must discuss this option with their Te Kura subject kaiako.

Recommended prior learning: NCEA Level 2 Visual Art course or equivalent.

This course is accessed through our online learning environment, My Te Kura.

Use drawing to demonstrate understanding of conventions appropriate to printmaking

AS91448 Cr Internal 4 credits

Systematically clarify ideas using drawing informed by established printmaking practice

AS91453 Cr Internal 4 credits

Produce a systematic body of work that integrates conventions and regenerates ideas within printmaking practice

AS91458 Cr External 14 credits

AR3200

Sculpture

NCEA Level 3 (course endorsement available)

In Level 3 Sculpture, ākonga study, develop and produce a body of work. They learn to critically engage, evaluate and investigate artistic procedures and practices. Researching the work of contemporary artists informs the development of their own ideas. Ākonga can produce a body of work in Sculpture by completing the two internals culminating in the portfolio external standard. Although the emphasis is on sculpture, ākonga work can demonstrate influences from design, printmaking, photography and painting.

New Zealand Scholarship exams are designed to extend very high-achieving Level 3 ākonga. Those who wish to enter the New Zealand Scholarship exam in this subject must discuss this option with their Te Kura subject kaiako.

Recommended prior learning: NCEA Level 2 Visual Art course or equivalent.

This course is accessed through our online learning environment, My Te Kura.

Use drawing to demonstrate understanding of conventions appropriate to sculpture

AS91449 Cr Internal 4 credits

Systematically clarify ideas using drawing informed by established sculpture practice

AS91454 Cr Internal 4 credits

Produce a systematic body of work that integrates conventions and regenerates ideas within sculpture practice

AS91459 Cr External 14 credits

AR3300**Design**

NCEA Level 3 (course endorsement available)

In Level 3 Design, ākonga study, develop and produce a body of work. They learn to critically engage, evaluate and investigate artistic procedures and practices. Researching the work of contemporary artists and designers informs the development of their own ideas. Ākonga can produce a body of work in Design by completing the two internals culminating in the portfolio external standard. Although the emphasis is on design, ākonga work can demonstrate influences from printmaking, photography, painting and sculpture.

New Zealand Scholarship exams are designed to extend very high-achieving Level 3 ākonga. Those who wish to enter the New Zealand Scholarship exam in this subject must discuss this option with their Te Kura subject kaiako.

Recommended prior learning: NCEA Level 2 Design or equivalent study and experience of digital media applications (Photoshop, InDesign). All enquiries regarding equivalency should be directed to the senior kaiako of the subject prior to enrolment and registration.

This course is accessed through our online learning environment, My Te Kura.

Use drawing to demonstrate understanding of conventions appropriate to design

AS91445 Cr Internal 4 credits

Systematically clarify ideas using drawing informed by established design practice

AS91450 Cr Internal 4 credits

Produce a systematic body of work that integrates conventions and regenerates ideas within design practice

AS91455 Cr External 14 credits

AR3400**Photography**

NCEA Level 3 (course endorsement available)

In Level 3 Photography, ākonga study, develop and produce a body of work. They learn to critically engage, evaluate and investigate artistic procedures and practices. Researching the work of contemporary artists and designers informs the development of their own ideas. Ākonga can produce a body of work in Photography by completing the two internals culminating in the portfolio external standard. Although the emphasis is on photography, ākonga work can demonstrate influences from printmaking, design, painting and sculpture.

New Zealand Scholarship exams are designed to extend very high-achieving Level 3 ākonga. Those who wish to enter the New Zealand Scholarship exam in this subject must discuss this option with their Te Kura subject kaiako.

Recommended prior learning: NCEA Level 2 Photography or equivalent study and experience of digital media applications (Photoshop, InDesign). All enquiries regarding equivalency should be directed to the senior kaiako of the subject prior to enrolment and registration.

This course is accessed through our online learning environment, My Te Kura.

Use drawing to demonstrate understanding of conventions appropriate to photography

AS91447 Cr Internal 4 credits

Systematically clarify ideas using drawing informed by established photography practice

AS91452 Cr Internal 4 credits

Produce a systematic body of work that integrates conventions and regenerates ideas within photography practice

AS91457 Cr External 14 credits

Art History

Te Toi Hitori

Ākonga who have an interest in art can learn how and why it has been produced. This involves the observation, analysis and interpretation of works of art within their cultural and historical contexts. Ākonga develop the analytical, critical and research skills needed to gain a greater understanding of artistic ideas and concepts. This subject does not require any practical skills in art.

AH2000

Art History

NCEA Level 2 (course endorsement available)

Towards modernism (nineteenth century French art) and art in Aotearoa are used as starting points for ākonga to develop the art historical skills of observation, analysis and understanding of content and context.

Recommended prior learning: A reasonable level of literacy is required.

This course is accessed through our online learning environment, My Te Kura.

Examine the effects of formal elements of art works

AS91180 (la) UElwa SCr External 4 credits

Examine the meanings conveyed by art works

AS91181 (la) Se Cr External 4 credits

Examine the influence of context(s) on art works

AS91182 (la) UElwa Cr External 4 credits

Examine how media are used to create effects in art works

AS91183 (la) Cr Internal 4 credits

Communicate understanding of an art history topic

AS91184 (la) UElra SCr Internal 4 credits

Communicate a considered personal response to art works

AS91185 (la) Cr Internal 4 credits

Demonstrate understanding of art works in relation to their physical environments

AS91186 (la) Se Cr Internal 4 credits

AH3000

Art History

NCEA Level 3 (course endorsement available)

The focus of this course is Renaissance art, a period that helped shape the history of art. Ākonga learn to analyse and interpret art within a cultural and historical context. The option offered is Late Renaissance.

This course is recommended to ākonga with an interest in the arts, English, history or classical studies. It is also useful for ākonga considering further tertiary study in any of these areas. It is not necessary to have studied Art History at Level 2.

New Zealand Scholarship exams are designed to extend very high-achieving Level 3 ākonga. Those who wish to enter the New Zealand Scholarship exam in this subject must discuss this option with their Te Kura subject kaiako.

Recommended prior learning: A good level of literacy is required.

This course is accessed through our online learning environment, My Te Kura.

Demonstrate understanding of style in art works

AS91482 (la) UElwra Cr External 4 credits

Examine how meanings are communicated through art works

AS91483 (la) UElra Se Cr External 4 credits

Examine the relationship(s) between art and context

AS91484 (la) UElwra Cr External 4 credits

Examine the impact of media and processes on art works

AS91485 (la) UElra Se Cr Internal 4 credits

Construct an argument based on interpretation of research in art history

AS91486 (la) UElra Cr Internal 4 credits

Examine the different values placed on art works

AS91487 (la) UElra Cr Internal 4 credits

Examine the relationship(s) between a theory and art works

AS91488 (la) UElra Se Cr Internal 4 credits

Analyse texts about art

AS91489 (la) UElra Internal 4 credits

Biology

Te Mātauranga Koiora

Biology is at the centre of all life and ākonga explore the living world, its ecology, plant and animal life processes, evolution, and relationships between biology and technology. Through this study, ākonga gain an understanding of themselves, the world, and how organisms survive and live together. They also develop essential scientific knowledge, methods and techniques. From here, ākonga are able to analyse scientific information effectively and discuss the wide range of implications science has on our world, including medical and environmental issues. Biology is a broad interest subject and is important for careers and in a variety of areas, from health through to forestry and zoology.

BY1000

Biology

NCEA Level 1 (course endorsement available)

This course provides an introduction to the living world, its ecology, and human organ systems. It offers a range of science and biology standards.

Ākonga wishing to continue with their biological studies at NCEA Level 2 and beyond are advised to prepare for at least one Science external (AS90948) and to complete the internally assessed standard AS90949. For ākonga wishing to complete the practical investigation at NCEA Level 2 or NCEA Level 3, it is recommended that they also complete AS90925.

Recommended prior learning: Ākonga should have a reasonable level of literacy.

This course is accessed through our online learning environment, My Te Kura.

Carry out a practical investigation in a biological context, with direction

AS90925 (na) UEna Ma Pr SSe So Internal 4 credits

Report on a biological issue

AS90926 (la) Pr Internal 3 credits

Demonstrate understanding of biological ideas relating to the life cycle of flowering plants

AS90928 (la) Pr External 4 credits

Demonstrate understanding of biological ideas relating to a mammal(s) as a consumer(s)

AS90929 (la) Pr SSe So External 3 credits

Demonstrate understanding of biological ideas relating to genetic variation

AS90948 (la) SMa Pr So External 4 credits

Investigate life processes and environmental factors that affect them

AS90949 Pr Se So Cr Internal 4 credits

Investigate biological ideas relating to interactions between humans and micro-organisms

AS90950 Co Ma Pr Se So Cr Internal 4 credits

Investigate the biological impact of an event on a New Zealand ecosystem

AS90951 Pr Se Cr Internal 4 credits

BY2000

Biology

NCEA Level 2 (course endorsement available)

This NCEA Level 2 course offers ākonga the opportunity to explore topics such as ecology, genetics and gene expression. Alongside these topics, ākonga study cell structure and processes and gain skills to analyse the increasing complexity of biological information that is presented to the public. They will also be able to carry out a practical investigation.

Not only is this course highly relevant, it is essential preparation for both the Level 3 Biology course and for ākonga intending to enter tertiary studies in nursing, medicine, veterinary or similar fields.

To be able to successfully start Level 3 Biology, ākonga should have studied AS91156, AS91159 and, if they want to carry out the Level 3 Biology practical investigation, they will need to complete AS91153.

Recommended prior learning: Ākonga should have a reasonable level of literacy and have successfully studied at least AS90948 and AS90949 from Level 1 Science/Biology.

This course is accessed through our online learning environment, My Te Kura.

Carry out a practical investigation in a biology context, with supervision

AS91153 (na) UEna Ma Pr SSe So Internal 4 credits

Analyse the biological validity of information presented to the public

AS91154 (la) Pr So Internal 3 credits

Demonstrate understanding of adaptation of plants or animals to their way of life

AS91155 (la) Pr SSe SSo Internal 3 credits

Demonstrate understanding of life processes at the cellular level

AS91156 (la) UElwa Pr So External 4 credits

Demonstrate understanding of genetic variation and change

AS91157 (la) UElwa Pr So External 4 credits

Investigate a pattern in an ecological community, with supervision

AS91158 (la) Pr Internal 4 credits

Demonstrate understanding of gene expression

AS91159 (la) Pr So External 4 credits

Investigate biological material at the microscopic level

AS91160 Pr SSe So Internal 3 credits

BY3000

Biology

NCEA Level 3 (course endorsement available)

This course follows on from Level 2 Biology. In this course, ākongā study plant responses and animal behaviour, biotechnology, evolution, and speciation. Ākongā also have the opportunity to further develop their investigative and research skills.

As well as being highly relevant, this course is useful, and often essential, for ākongā intending to enter tertiary studies in nursing, medicine, veterinary science or similar fields.

University Entrance requires 14 credits in three approved Level 3 subjects, which includes Biology. This means Biology ākongā should sit at least one, preferably two, externally assessed standards. If ākongā intend to complete AS91601, they should do this in term one or two of the school year.

Recommended prior learning: Ākongā should have a good level of literacy. They also need to have done AS91156 and AS91159 from Level 2 Biology before heading into this course. Ākongā intending to complete the practical investigation, AS91601, should know how to apply the scientific method when planning and carrying out this investigation.

This course is accessed through our online learning environment, My Te Kura.

Carry out a practical investigation in a biological context, with guidance

AS91601 (lna) UEna Ma Pr So Internal 4 credits

Integrate biological knowledge to develop an informed response to a socio-scientific issue

AS91602 (la) UElra Ma Pr So Internal 3 credits

Demonstrate understanding of the responses of plants and animals to their external environment

AS91603 (la) UElwra Pr External 5 credits

Demonstrate understanding of how an animal maintains a stable internal environment

AS91604 (la) UElra Pr So Internal 3 credits

Demonstrate understanding of evolutionary processes leading to speciation

AS91605 (la) UElwra Ma Pr So External 4 credits

Demonstrate understanding of trends in human evolution

AS91606 (la) UElwra Pr External 4 credits

Demonstrate understanding of human manipulations of genetic transfer and its biological implications

AS91607 (la) UElra Ma Pr So Internal 3 credits

Business Studies

Ngā Akoranga Umanga

In a rapidly changing world, it is important that people are able to make informed and rational decisions about business matters. Business Studies considers how individuals and groups organise, plan and act to produce goods and services to satisfy customers. The knowledge and skills gained in Business Studies and exposure to enterprise culture can help shape creative, energetic and enterprising people who will contribute to New Zealand's economic future. In Business Studies, ākongā develop their understanding of business theory and practices in a range of relevant contexts.

BS1000

Business Studies

NCEA Level 1 (course endorsement available)

In this course, ākongā explore the five key themes (business formation, functions of business, people in business, business management and the business environment) within the context of a small-to-medium business, of local, national or international significance. The business should also be connected to their life, for example: a local farm, tourist operator, retail outlet, franchise, or early childcare centre.

Ākongā will look at the internal and external features of businesses that influence their success. They investigate operational business problems and provide causes, impacts, possible solutions and recommendations to address them.

Also studied in this course is the marketing mix model and human resources processes. Ākongā gain knowledge of enterprising behaviour, innovation and entrepreneurship in business contexts.

Recommended prior learning: Ākongā should have a reasonable level of literacy.

This course is accessed through our online learning environment, My Te Kura.

Demonstrate knowledge of innovation and entrepreneurship in business contexts

US22847 Cr Internal 2 credits

Demonstrate an understanding of internal features of a small business

AS90837 (la) Pr Se Cr External 4 credits

Demonstrate an understanding of external factors influencing a small business

AS90838 (la) Pr Se Cr External 4 credits

Apply business knowledge to an operational problem(s) in a given small business context

AS90839 (la) Pr External 4 credits

Apply the marketing mix to a new or existing product

AS90840 (la) Pr Se Cr Internal 3 credits

Investigate aspects of human resource processes in a business

AS90841 (la) Pr Internal 3 credits

BS2000

Business Studies

NCEA Level 2 (course endorsement available)

In this course, ākongā explore the five key themes (business formation, functions of business, people in business, business management and the business environment) within the context of a medium-to-large business of local, national or international significance. The business should also be connected to their life, for example: a listed company, a retail company with multiple outlets, a school, local government, a large corporation, or a bank.

Ākongā look at internal and external features, critical business problems, and apply business knowledge to provide possible solutions and recommendations to address them. They also have the opportunity to conduct market research and identify motivation practices and apply their knowledge of motivation theory in a business.

Recommended prior learning: Ākongā should have a reasonable level of literacy.

This course is accessed through our online learning environment, My Te Kura.

Demonstrate and apply knowledge of office equipment and administration processes

US121 SSe Internal 4 credits

Demonstrate understanding of the internal operations of a large business

AS90843 (la) Pr Se External 4 credits

Demonstrate understanding of how a large business responds to external factors

AS90844 (la) Pr Se External 4 credits

Apply business knowledge to a critical problem(s) in a given large business context

AS90845 (1a) Pr External 4 credits

Conduct market research for a new or existing product

AS90846 (1a) UEna Pr Cr Internal 3 credits

Investigate the application of motivation theory in a business

AS90847 (1a) Cr Internal 3 credits

Chemistry

Te Māturanga Matū

People have always been fascinated by the world around them and chemistry is the study of the substances that make up the universe. From the time people worked out how to create fire, chemistry has been at the forefront of exciting discoveries such as the structure of DNA and the use of semiconductors in electronics. Chemistry looks at the behaviour of substances, the changes they undergo to create new ones and the reactions between them. Yet it is more than what happens at a micro level, it is about what it is that makes us, our materials and everything around us. Ākonga learn the essential skills and knowledge needed to analyse scientific information, conduct experiments and research. Chemistry is essential for careers in a wide range of areas including medicine, pharmacy, engineering, environmental science, wine making and food technology.

CH1000

Chemistry

NCEA Level 1 (course endorsement available)

This course provides an introduction to the basics of chemistry. Ākonga should enrol for this course if they wish to focus on studying the material world and intend to sit at least one externally assessed examination paper.

Ākonga wishing to continue with Level 2 Chemistry should complete at least AS90944: Demonstrate understanding of aspects of acids and bases. Ākonga are expected to complete five of the standards listed below.

Recommended prior learning: Ākonga should have a reasonable level of literacy.

This course is accessed through our online learning environment, My Te Kura.

Carry out a practical chemistry investigation, with direction

AS90930 (na) UEna Co Ma Pr SSe Internal 4 credits

Demonstrate understanding of the chemistry in a technological application

AS90931 (la) Co Ma Pr SSe Cr Internal 2 credits

Demonstrate understanding of aspects of chemical reactions

AS90934 Co Pr SSe External 4 credits

Demonstrate understanding of aspects of acids and bases

AS90944 Co Ma Pr Cr External 4 credits

Investigate implications of the use of carbon compounds as fuels

AS90945 Co Ma Pr SSe So Internal 4 credits

Investigate the implications of the properties of metals for their use in society

AS90946 Co Ma Pr Cr Internal 4 credits

Investigate selected chemical reactions

AS90947 Co Ma Pr So Cr Internal 4 credits

CH2000

Chemistry

NCEA Level 2 (course endorsement available)

This course further develops some of the chemistry topics introduced in Level 1 Science, and investigates general scientific nature and problems, oxidation and reduction, and the various reactions that chemical substances undergo. The use of formulae and equations and the application of mathematics to these are a very important part of the course. Practical work is part of this course, much of which can be done at home.

Note: AS91163 requires a good understanding of Level 2 Chemistry and so is normally attempted last.

AS9190 and AS91911 requires practical work to be carried out in a laboratory and may not be offered in all centres. Please contact your kaiako for more information.

Recommended prior learning: AS90944 or equivalent.

This course is accessed through our online learning environment, My Te Kura.

Analyse oxidation – reduction reactions

US6345 Internal 4 credits

Demonstrate understanding of the chemistry used in the development of a current technology

AS91163 (la) Co Ma Pr SSe So Cr Internal 3 credits

Demonstrate understanding of bonding, structure, properties and energy changes

AS91164 (la) Co Ma Pr So External 5 credits

Demonstrate understanding of the properties of selected organic compounds

AS91165 (la) Co Ma Pr Se So External 4 credits

Demonstrate understanding of chemical reactivity

AS91166 (la) Co Ma Pr SSe So External 4 credits

Demonstrate understanding of oxidation-reduction

AS91167 Co Ma Pr So Internal 3 credits

Carry out a practical investigation into a substance present in a consumer product using quantitative analysis

AS91910 Internal 4 credits

Carry out an investigation into chemical species present in a sample using quantitative analysis

AS91911 Internal 3 credits

CH3000

Chemistry

NCEA Level 3 (course endorsement available)

This course takes a deeper look at what helps create our world, and takes the concepts discussed in Level 2 to a more advanced level. There is a focus on the role of energy and using particles at the microscopic level to explain the properties observed at the macroscopic level.

Topics introduced include electronic structures and spontaneity of reactions including electrochemical processes. Spectroscopic analysis of organic compounds is also investigated. Since quantitative analysis is involved with chemistry, confidence in general mathematics, simple algebra and graphs is useful and the course is aimed at ākongā going on to tertiary studies in chemistry.

Note: AS91389: Demonstrate understanding of chemical processes in the world around us requires a good understanding of Level 3 Chemistry and so should be completed near the end of the course.

Recommended prior learning: Five standards completed at NCEA Level 2 Chemistry or equivalent.

This course is accessed through our online learning environment, My Te Kura.

Analyse oxidation-reduction reactions

US6345 Internal 4 credits

Characterise the composition of acid and base solutions

US8949 Internal 4 credits

Demonstrate understanding of spectroscopic data in chemistry

AS91388 Co Ma Pr So Internal 3 credits

Demonstrate understanding of chemical processes in the world around us

AS91389 (1a) UElwra Co Ma Pr So Internal 3 credits

Demonstrate understanding of thermochemical principles and the properties of particles and substances

AS91390 (1a) Co Ma Pr So External 5 credits

Demonstrate understanding of the properties of organic compounds

AS91391 (1a) Co Ma Pr Se So External 5 credits

Demonstrate understanding of equilibrium principles in aqueous systems

AS91392 (1na) UEna Co Ma Pr So External 5 credits

Demonstrate understanding of oxidation-reduction processes

AS91393 (1a) Co Ma Pr So Internal 3 credits

Chinese

Te Reo Hainamana

Chinese is not only one of the oldest living languages, but it is also a major world language spoken across the globe by over one billion people. As the New Zealand population diversifies, Chinese is becoming a major language in this country while remaining highly important for trade and tourism. For some ākongā, the history and very look of its written characters are fascinating, while for others it is a chance to stay in touch with their own family background. This subject focuses on both spoken and written modern standard Chinese (Mandarin), which is used throughout China, Singapore and Taiwan. It also explores the culture of Chinese-speaking countries.

ZH000

Beginners' Chinese

Curriculum Levels 1–5

This is a beginners' course in modern standard Chinese (Mandarin). Ākongā practise everyday listening and speaking skills, reading and writing the Pinyin alphabetical system and some simple characters.

They learn simple greetings, how to introduce themselves and family members, how to say numbers, time and age, their likes and dislikes, school, daily routine, shopping and food. They also learn about life and customs in China.

The course can be taken over one or two years. We recommend ākongā who want to do NCEA Level 1 should complete this course first.

Recommended prior learning: No prior learning needed.

This course is accessed through our online learning environment, My Te Kura. Ākongā will be required to make and submit audio and/or video recordings, so a microphone and camera or mobile device are essential.

ZH1000

Chinese

NCEA Level 1 (course endorsement available)

This course builds on language already covered in Beginners' Chinese (ZH000). Ākongā are required to translate, listen and engage with the language as much as possible. Ākongā develop their listening and speaking skills in modern standard Chinese (Mandarin) and their reading and writing of simplified characters. They also learn using Pinyin as a means of expanding their range of language. By the end of this course, ākongā are able to read and recognise around 370 characters and write 220 characters.

Ākongā will also be able to communicate the time, direction, seasons and their daily routine. The Chinese language and its relationship with life and customs in China is highlighted, with topics including folk stories and legends, sport, food and festivals.

Recommended prior learning: Ākongā must have completed Year 10 Chinese or equivalent or have a Chinese language background. Ability to read and write about 100 Chinese characters is essential.

This course is accessed through our online learning environment, My Te Kura. Ākongā will be required to make and submit audio and/or video recordings, so a microphone and camera or mobile device are essential.

Demonstrate understanding of a variety of spoken Chinese texts on areas of most immediate relevance

AS90868 Pr Se So SCr External 5 credits

Give a spoken presentation in Chinese that communicates a personal response

AS90869 Pr Internal 4 credits

Demonstrate understanding of a variety of Chinese texts on areas of most immediate relevance

AS90871 Se External 5 credits

Write a variety of text types in Chinese on areas of most immediate relevance

AS90872 Se SCr Internal 5 credits

ZH2000**Chinese**

NCEA Level 2 (course endorsement available)

This course builds on language already mastered in Level 1. Ākonga continue to develop general listening and speaking skills and expand their ability to read and write simplified characters. Over the year, ākonga learn how to communicate information about themselves and their friends, their home country and future plans, as well as how to write a CV. As with previous courses, a focus on Chinese culture is emphasised, and issues surrounding living in a foreign country and their customs and behaviour are covered.

Recommended prior learning: NCEA Level 1 Chinese or equivalent.

This course is accessed through our online learning environment, My Te Kura. Ākonga will be required to make and submit audio and/or video recordings, so a microphone and camera or mobile device are essential.

Demonstrate understanding of a variety of spoken Chinese texts on familiar matters

AS91108 Se External 5 credits

Interact using spoken Chinese to share information and justify ideas and opinions in different situations

AS91109 SSe So Cr Internal 5 credits

Give a spoken presentation in Chinese that communicates information, ideas and opinions

AS91110 Internal 4 credits

Demonstrate understanding of a variety of written and/or visual Chinese text(s) on familiar matters

AS91111 SSe External 5 credits

Write a variety of text types in Chinese to convey information, ideas, and opinions in genuine contexts

AS91112 Internal 5 credits

ZH3000**Chinese**

NCEA Level 3 (course endorsement available)

This course develops ākonga's ability to communicate in Chinese in a variety of situations. Throughout the course, opportunities are provided to listen to and speak Chinese, as well as to read and write using simplified characters to an advanced level. Ākonga learn not only how to express a point of view, but also how to support an argument or provide suggestions. Chinese culture is also considered, in particular the matter of cultural differences, and the skills and advice required to plan a trip to China are covered.

New Zealand Scholarship exams are designed to extend very high-achieving Level 3 ākonga. Those who wish to enter the New Zealand Scholarship exam in this subject must discuss this option with their Te Kura subject kaiako.

Recommended prior learning: NCEA Level 2 Chinese or equivalent.

This course is accessed through our online learning environment, My Te Kura. Ākonga will be required to make and submit audio and/or video recordings, so a microphone and camera or mobile device are essential.

Demonstrate understanding of a variety of extended spoken Chinese texts

AS91533 Se External 5 credits

Give a clear spoken presentation in Chinese that communicates a critical response to stimulus material

AS91534 Internal 3 credits

Interact clearly using spoken Chinese to explore and justify varied ideas and perspectives in different situations

AS91535 Se So Cr Internal 6 credits

Demonstrate understanding of a variety of extended written and/or visual Chinese texts

AS91536 External 5 credits

Write a variety of text types in clear Chinese to explore and justify varied ideas and perspectives

AS91537 Se Internal 5 credits

Classics and Religious Studies

Te Akoranga Puāwaitanga me ngā Hāhi

Many of Western culture's roots can be traced back to Ancient Greece and Rome. Classical Studies looks into the lives, beliefs and creations of the people of these civilisations. Not only has much of our literature, language, art and architecture been developed from the classical world, but its influence can be seen in science, mathematics, laws and systems of government as well. By comparing our modern ways of living with these origins, we can gain a greater understanding of the current world and its influences. Classical Studies is a multi-disciplinary subject, which covers topics including politics, religion and philosophy. Ākonga gain a wide range of historical knowledge and cultural insight while developing their analytical, critical and research skills.

GL2000

Classical Studies

NCEA Level 2 (course endorsement available)

This course is an introduction to the classical world, where ākonga learn about Ancient Greek and Roman art, beliefs and literature. This includes a study of classical mythology, Homer's epic poem 'The Odyssey' and Greek tragedy. The golden age of Greece is foreshadowed in a study of the Persian Wars. The change from the Republic to the Empire in Rome is studied in 'The Death of Caesar'.

There are also 18 credits of Religious Studies assessments available. Religious Studies is an approved University Entrance subject. It is research-based and all material is available on the internet. Contact your kaiako for further information.

Recommended prior learning: Ākonga should have a good level of literacy.

This course is accessed through our online learning environment, My Te Kura.

Examine ideas and values of the classical world

AS91200 (la) UElwra Cr External 4 credits

Examine the significance of features of work(s) of art in the classical world

AS91201 (la) UElwra SCr External 4 credits

Demonstrate understanding of a significant event in the classical world

AS91202 (la) UElra Cr Internal 4 credits

Examine socio-political life in the classical world

AS91203 (la) UElwra Cr External 6 credits

Demonstrate understanding of the relationship between aspects of the classical world and aspects of other cultures

AS91204 (la) UElra Cr Internal 6 credits

GL3000

Classics and Religious Studies

NCEA Level 3 (course endorsement available)

Theatre and literature and their relation to life in Ancient Greece and Rome form a large part of this course. Importantly, these still influence us today, with much Western drama and fiction originating from this time. Ākonga will encounter the Greek Attic comedy of Aristophanes, as well as Virgil's epic poem 'The Aeneid'.

In turn, an introduction to the concepts behind Greek vase painting and a historical study of Alexander the Great is also offered.

Throughout the course, ākonga gain further insight into not just ancient culture but the way we act, think and live today. There are also 18 credits of Religious Studies assessments available.

Recommended prior learning: Ākonga should have a very good level of literacy.

This course is accessed through our online learning environment, My Te Kura.

Analyse ideas and values of the classical world

AS91394 (la) UElwra Cr External 4 credits

Analyse the significance of a work(s) of art in the classical world

AS91395 (la) UElwra Cr External 4 credits

Analyse the impact of a significant historical figure on the classical world

AS91396 (la) UElwra Cr External 6 credits

Demonstrate understanding of significant ideology(ies) in the classical world

AS91397 (la) UElra Cr Internal 6 credits

Demonstrate understanding of the lasting influences of the classical world on other cultures across time

AS91398 (la) UElra Cr Internal 6 credits

Religious Studies

Religious Studies is an approved University Entrance subject. It is research-based and all material is available on the internet. Contact your kaiako for further information.

Note: Religious Studies and Classical Studies are from separate domains (subject areas) for UE approved subjects – i.e. the credits for Classics and Religious Studies cannot be combined. However, all credits gained do count towards NCEA Level 3.

Analyse the response of a religious tradition to a contemporary ethical issue

AS90826 (la) UEIra Internal 6 credits

Analyse the key beliefs of a religious tradition and a secular world view in relation to ultimate questions

AS90827 (la) UEIra Internal 6 credits

Analyse the meanings in a sacred text within a religious tradition

AS91725 (la) UEIra Internal 6 credits

Design and Visual Communication

Ngā mahi hoahoa me te Whakawhitiwhiti ataata

Design and Visual Communication, also known as Graphics, is for ākonga interested in design and drawing. Ākonga develop visual communication skills and design thinking to explore and solve design problems. Ākonga develop skills in sketching, rendering, drawing and modelling to explore, communicate and present their ideas. In some topics, ākonga are able to have models of their design work 3D printed by Te Kura. Ākonga are encouraged to generate creative and innovative solutions to solve design problems that are set in authentic contexts, and can be customised to suit their interests.

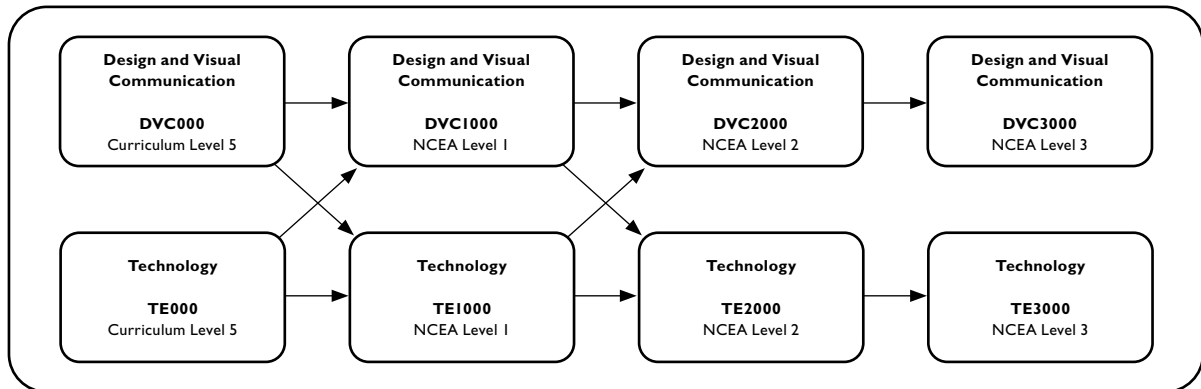

DVC000

Design and Visual Communication

Curriculum Level 5

This introductory course will appeal to any ākonga who enjoys sketching and is interested in the challenge of solving design problems. Ākonga learn design and drawing techniques, which enables them to design everyday objects and present them visually, including having a model 3D printed. Ākonga will include influences from their cultural and physical contexts in their design projects. Topics include product and spatial design, sketching, rendering, modelling and instrumental drawing.

Recommended prior learning: No prior learning needed.

This course is accessed through our online learning environment, My Te Kura.

An optional topic develops presentation techniques. The work done in these projects contributes to internally assessed standards and a portfolio for external assessment.

Recommended prior learning: No prior learning needed.

This course is accessed through our online learning environment, My Te Kura.

Produce freehand sketches that communicate design ideas

AS91063 Co Ma Cr External 3 credits

Produce instrumental, multi-view orthographic drawings that communicate technical features of design ideas

AS91064 (na) UEna Co Ma Cr External 3 credits

Produce instrumental paraline drawings to communicate design ideas

AS91065 (na) UEna Co Ma Cr External 3 credits

Use rendering techniques to communicate the form of design ideas

AS91066 Co Ma Cr Internal 3 credits

Use the work of an influential designer to inform design ideas

AS91067 Ma Cr Internal 3 credits

Undertake development of design ideas through graphics practice

AS91068 Co Ma Cr Internal 6 credits

DVC1000

Design and Visual Communication

NCEA Level 1 (course endorsement available)

This course develops ākonga's visual communication and design skills. Ākonga start the course exploring the influence of a significant designer and then move on to two major design projects, within the contexts of product design and spatial design. The design briefs are customisable to reflect individual ākonga's interests and passions. Interspersed in the projects are exercises to develop ākonga's technical skills.

Promote an organised body of design work to an audience using visual communication techniques

AS91069 (la) Co Ma Cr Internal 4 credits

DVC2000

Design and Visual Communication

NCEA Level 2 (course endorsement available)

This course develops ākongā's design capabilities. Initially ākongā explore a design movement of their choice and then embed its influence into their own conceptual design. They then explore practices specific to product and spatial designers through two major design projects, which are customised to reflect their personal interests.

Ākongā are challenged to examine solutions to design problems in greater depth. Interspersed in the projects are exercises to advance ākongā's technical skills. The work done in these projects contributes to internally assessed standards and a portfolio for external assessment.

Design-focused ākongā can complete an optional topic creating a presentation of one of their projects. Technically oriented ākongā can complete a set of working drawings for one of their projects.

Recommended prior learning: NCEA Level 1 Design and Visual Communication or equivalent.

This course is accessed through our online learning environment, My Te Kura.

Use visual communication techniques to generate design ideas

AS91337 SCo Ma Pr SCr External 3 credits

Produce working drawings to communicate technical details of a design

AS91338 SCo SMa Pr Cr External 4 credits

Use the characteristics of a design movement or era to inform own design ideas

AS91340 SCr Internal 3 credits

Develop a spatial design through graphics practice

AS91341 (la) SCo Ma Cr Internal 6 credits

Develop a product design through graphics practice

AS91342 SCo SMa Cr Internal 6 credits

Use visual communication techniques to compose a presentation of a design

AS91343 SCo Ma SCr Internal 4 credits

DVC3000

Design and Visual Communication

NCEA Level 3 (course endorsement available)

This online course covers NCEA Level 3 and Scholarship. Ākongā develop their own design briefs, which are based on authentic situations in the contexts of spatial and product design. They are challenged to generate innovative and creative design ideas and carry them through to highly resolved design solutions.

During this process they participate in online discussions and critiques, submitting their work digitally. Ākongā work in a range of different media, both paper based and digital, and can have some models 3D printed by Te Kura. Final assessments are paper based and submitted by post. Access to a digital camera or scanner is essential.

Recommended prior learning: NCEA Level 2 Design and Visual Communication or equivalent.

This course is accessed through our online learning environment, My Te Kura.

Initiate design ideas through exploration

AS91627 Co Ma Pr Se Cr External 4 credits

Develop a visual presentation that exhibits a design outcome to an audience

AS91628 Co Ma Pr Cr Internal 6 credits

Resolve a spatial design through graphics practice

AS91629 Co Ma Cr Internal 6 credits

Resolve a product design through graphics practice

AS91630 Co Ma Cr Internal 6 credits

Digital Technology

Te Hangarau Mamatai

Digital Technology ākonga learn to effectively find, create, communicate and use information in a digital context. Ākonga are also provided with an excellent introduction to the world of information communication technology.

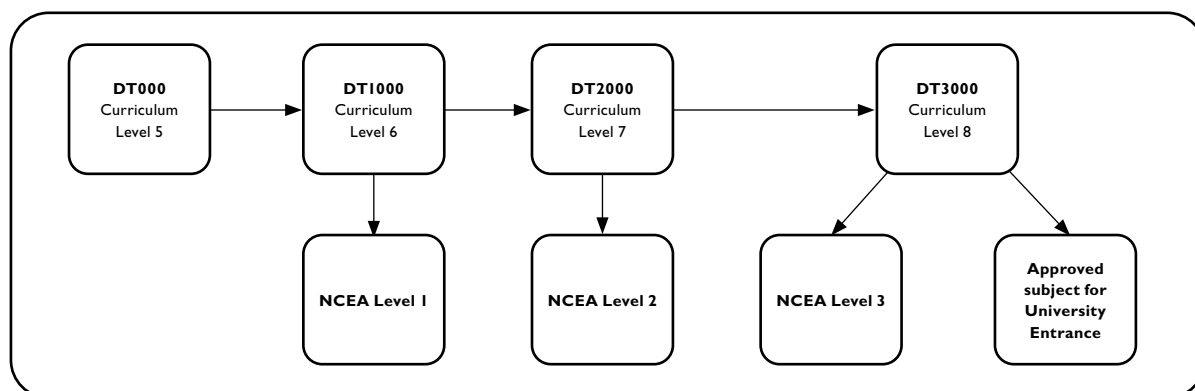

DT000

Digital Technology

Curriculum Level 5

This course offers a wide range of different digital learning experiences which will appeal to all ākonga. Activities are exciting and are based on ākonga's interest. There is a creative focus and ākonga are guided to participate in a digital environment that they are responsible for creating. Ākonga are introduced to web design, coding and programming, design, digital imaging, computer science, cyber safety and how to become better digital citizens.

Recommended prior learning: No prior learning needed.

This course is accessed through our online learning environment, My Te Kura.

DT1000

Digital Technology

NCEA Level 1 (course endorsement available)

This Level 1 online course offers ākonga the opportunity to explore topics such as programming, web design and photo editing, desktop publishing, word processing and spreadsheets. The course offers topics that can be studied in any order.

Recommended prior learning: DT000 modules recommended.

This course is accessed through our online learning environment, My Te Kura.

Develop and use keyboarding skills to enter text

US101 Internal 3 credits

Consolidate keyboarding skills and produce accurate text based documents

US102 Internal 3 credits

Produce simple desktop published documents using templates

US2792 Co Ma Pr Cr Internal 2 credits

Use computer technology to create and deliver a presentation from given content

US5946 Ma Cr Internal 3 credits

Enter and manage text for generic text and information management

US12883 Internal 4 credits

Produce a spreadsheet from instructions using supplied data

US18743 Co Ma Pr Se So Cr Internal 2 credits

Develop a design for a digital outcome

AS91878 (la) Co Ma Pr Se So Cr Internal 3 credits

Develop a digital outcome to manage data

AS91879 (la) Ma Pr Cr Internal 4 credits

Develop a digital media outcome

AS91880 (la) Ma Pr So Cr Internal 4 credits

Develop a computer program

AS91883 Ma Cr Internal 4 credits

Demonstrate understanding of human computer interaction

AS91886 (la) Ma Cr External 3 credits

Demonstrate understanding of compression coding for a chosen media type

AS91887 (la) Ma Cr External 3 credits

DT2000

Digital Technology

NCEA Level 2 (course endorsement available)

This online Level 2 course offers ākonga the opportunity to further explore programming, web design and other topics studied in Digital Technology NCEA Level 1 (DT1000). The topics can be studied in any order.

Recommended prior learning: DT1000 modules recommended.

This course is accessed through our online learning environment, My Te Kura.

Use a word processor to produce documents for a business or organisation

US111 Internal 5 credits

Use the main features and functions of a presentation application for a purpose

US29771 Co Ma Pr Se So Cr Internal 2 credits

Manage files and folders using digital devices

US29772 Co Ma Pr Se So Cr Internal 2 credits

Produce digital images for a range of digital media

US29773 Ma Se So Cr Internal 3 credits

Use the main features and functions of a desktop publishing application to create documents

US29774 Sr Cr Internal 3 credits

Use the main features of an HTML editor to create a website

US29776 Cr Internal 4 credits

Implement basic security when using digital devices and software

US29783 Co Ma Pr Se So Cr Internal 3 credits

Apply conventions to develop a design for a digital technologies outcome

AS91891 Co Ma Pr Se So Cr Internal 3 credits

Use advanced techniques to develop a digital media outcome

AS91893 Co Ma Pr So Cr Internal 4 credits

Use advanced programming techniques to develop a computer program

AS91896 Co Ma Cr Internal 6 credits

Use advanced processes to develop a digital technologies outcome

AS91897 Co Ma Pr Se So Cr Internal 6 credits

Demonstrate understanding of a computer science concept

AS91898 Co Ma Cr External 3 credits

Present a summary of developing a digital outcome

AS91899 Co Ma Pr Se So Cr External 3 credits

DT3000

Digital Technology

NCEA Level 3 (course endorsement available)

This is an online Level 3 course and an approved University Entrance (UE) subject. Ākonga can explore topics such as databases, desktop publishing, web design and spreadsheets. It is recommended that ākonga aiming for UE complete the topics where achievement standards are being offered.

Recommended prior learning: DT2000 modules recommended.

This course is accessed through our online learning environment, My Te Kura.

Demonstrate knowledge of the principles of computer networks

US2797 Internal 4 credits

Use a word processing application to integrate images, spreadsheet and database data into documents

US29785 Internal 4 credits

Produce a spreadsheet for organisational use

US29786 Internal 3 credits

Apply user experience methodologies to develop a design for a digital technologies outcome

AS91901 (la) Internal 3 credits

Use complex techniques to develop a digital media outcome

AS91903 Internal 4 credits

Use complex programming techniques to develop a computer program

AS91906 Internal 6 credits

Use complex processes to develop a digital technologies outcome

AS91907 Internal 6 credits

Analyse an area of computer science

AS91908 (la) UElwa External 3 credits

Present a reflective analysis of developing a digital outcome

AS91909 (la) External 3 credits

Economics

Te Mātauranga Ōhanga

Economics is a social science about people and how they use resources. By studying economics, ākongā become aware of the roles that individuals play in an economy, increase their understanding of economic events and improve their own decision making. Ākongā explore the interactions between producers, consumers and governments and the impact economic decisions can have on society. Economics encourages ākongā to think critically and independently about business, economic and social issues. This subject leads to careers in a range of fields including social policy and planning, business and financial management.

EC1000

Economics

NCEA Level 1 (course endorsement available)

In this course, ākongā learn about producer and consumer choices, interactions between households and firms, how economic decisions are made, and the effects these choices have on individuals and the economy.

Ākongā are introduced to the way producers work and the concept of a market that determines prices and allocates scarce resources. We are all involved in economics as producers or consumers and this course provides an understanding of our different roles in this process.

Recommended prior learning: Ākongā should have a reasonable level of literacy.

This course is accessed through our online learning environment, My Te Kura.

Demonstrate understanding of consumer choices, using scarcity and/or demand

AS90983 (la) Pr Se Cr External 4 credits

Demonstrate understanding of decisions a producer makes about production

AS90984 (la) SMa Pr Internal 5 credits

Demonstrate understanding of producer choices using supply

AS90985 (la) Pr Se External 3 credits

Demonstrate understanding of how consumer, producer and/or government choices affect society, using market equilibrium

AS90986 (la) Pr Se Cr External 5 credits

Demonstrate understanding of a government choice where affected groups have different viewpoints

AS90987 (la) Pr Internal 4 credits

Demonstrate understanding of the interdependence of sectors of the New Zealand economy

AS90988 (la) Pr So Cr Internal 3 credits

EC2000

Economics

NCEA Level 2 (course endorsement available)

This course gives ākongā the opportunity to explore major economic issues such as economic growth, unemployment, trade and inflation. Ākongā develop the skills to define and measure these and analyse their causes and effects in the context of the New Zealand economy.

Ākongā learn to use and evaluate economic models. The role of the government in the economy and the consequences of government policies are also explored. Ākongā examine the interdependent nature of economies and compare and contrast the varying impacts of economic forces on different groups in society. This gives ākongā a greater understanding of economic events and trends.

Recommended prior learning: Ākongā should have a reasonable level of literacy.

This course is accessed through our online learning environment, My Te Kura.

Analyse inflation using economic concepts and models

AS91222 (la) Se External 4 credits

Analyse international trade using economic concepts and models

AS91223 (la) Pr Se External 4 credits

Analyse economic growth using economic concepts and models

AS91224 (la) Se External 4 credits

Analyse unemployment using economic concepts and models

AS91225 (la) UEIra Internal 4 credits

Analyse statistical data relating to two contemporary economic issues

AS91226 (Ina) UEna Internal 4 credits

Analyse how government policies and contemporary economic issues interact

AS91227 (la) UEIra Internal 6 credits

EC3000**Economics**

NCEA Level 3 (course endorsement available)

Ākonga develop and improve economic understanding of a range of social and economic issues. There are three main areas of study. The first is based around resource allocation and the market and will look closely at the concepts of scarcity and opportunity cost, demand and supply, market analysis, and monopolies and other market structures.

The second area explores situations of market failure and looks at the role of government in the economy in correcting market failure. The third area looks at influences on the New Zealand economy as a whole, both internal and external, including the aims of government and the effects of government policies.

New Zealand Scholarship exams are designed to extend very high-achieving Level 3 ākonga. Those who wish to enter the New Zealand Scholarship exam in this subject must discuss this option with their Te Kura subject kaiako.

Recommended prior learning: Ākonga should have a reasonable level of literacy.

This course is accessed through our online learning environment, My Te Kura. It includes a mix of interactive online modules and downloadable resources in PDF format.

Demonstrate understanding of the efficiency of market equilibrium

AS91399 (la) UElwra Se External 4 credits

Demonstrate understanding of the efficiency of different market structures using marginal analysis

AS91400 (la) UElwra Pr Se External 4 credits

Demonstrate understanding of micro-economic concepts

AS91401 (la) UElra Se Internal 5 credits

Demonstrate understanding of government interventions to correct market failures

AS91402 (la) UElra Pr Internal 5 credits

Demonstrate understanding of macro-economic influences on the New Zealand economy

AS91403 (la) UElwra Pr Se External 6 credits

English

Te Reo Ingarihi

English is one of the three official languages of Aotearoa New Zealand. English is an essential tool for full participation in our personal, local, national and global communities. At Te Kura, the study of English supports ākonga to extend their competency in the use of language in a variety of contexts including tertiary study and the workplace. Ākonga develop a sense of their identity as New Zealanders and explore their heritage through the study of novels, films, short stories and shorter texts. They also develop critical thinking skills, which enables them to evaluate and challenge the thinking of others as well as contribute to important global debates. The subject is structured to allow maximum flexibility in course design. Ākonga follow a course that is linked to their learning needs and goals. They progress through the levels at their own pace. For NCEA, ākonga select a pathway to follow but can change pathways at any time.

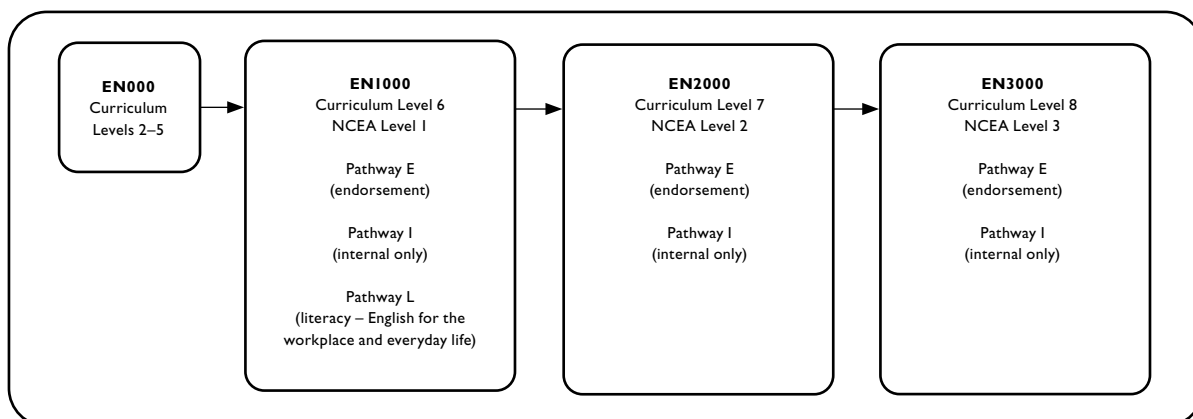

EN000

English

Curriculum Levels 2–5

This course is suited to ākonga who are working at Curriculum Levels 2–5 in English and is personalised to meet individual learning needs. All aspects of English are covered, from reading, writing and speaking, through to listening, viewing and image-making exercises. This course helps ākonga develop the skills they require to progress to NCEA English.

No prior learning needed.

This course is accessed through our online learning environment, My Te Kura.

EN1000

English

NCEA Level 1 (course endorsement available)

The focus of Level 1 English is on ākonga continuing to develop their understanding of purpose, audience, ideas, language and structure. Ākonga study existing written, visual and oral texts as well as create their own.

Within the course, ākonga can take one of several

pathways depending on their goals, interests and skills. English is structured to allow maximum flexibility in course design, so ākonga can work at their own pace and alter their path at any time. All standards are available to all ākonga in any pathways, including the Literacy unit standards.

The initial pathways are:

- E (Endorsement) a full NCEA achievement standard programme with the opportunity to gain endorsement at the Merit or Excellence levels. To gain endorsement the qualification has to be completed in one academic year. Internal and external standards.
- I (Internal) an internal achievement standard programme, with the ability to meet the NCEA literacy requirement through achievement standards. Internal standards only.
- L (Literacy) English for work and everyday life. A combination of unit standards that develop communication skills in practical contexts. Ākonga in this pathway will work towards gaining unit standard Literacy. Achievement standards will also be accessible through this pathway.

The choice of pathway will determine the first

modules ākongā will complete. Ākongā will then plan a programme in consultation with their kaiako.

Recommended prior learning: Working at Curriculum Levels 5–6 in English.

This course is accessed through our online learning environment, My Te Kura.

Fill in a form

US3483 Internal 2 credits

Complete an incident report

US3490 Internal 2 credits

Demonstrate knowledge of and apply listening techniques

US3501 Internal 3 credits

Write formal personal correspondence

US10792 Internal 3 credits

Write to communicate ideas for a purpose and audience

US26622 (lu) Internal 4 credits

Read texts with understanding

US26624 (lu) Internal 3 credits

Actively participate in spoken interactions

US26625 (lu) Internal 3 credits

Produce creative writing

AS90052 (la) Co Ma Pr Se So Cr Internal 3 credits

Produce formal writing

AS90053 (la) Co Ma Pr Se So Cr Internal 3 credits

Show understanding of specified aspect(s) of studied written text(s), using supporting evidence

AS90849 (la) Co Ma Pr Se So Cr External 4 credits

Show understanding of specified aspect(s) of studied visual or oral text(s), using supporting evidence

AS90850 (la) Co Ma Pr Se So Cr External 4 credits

Show understanding of significant aspects of unfamiliar written text(s) through close reading, using supporting evidence

AS90851 (la) Co Ma Pr Se So Cr External 4 credits

Explain significant connection(s) across texts, using supporting evidence

AS90852 (la) Co Ma Pr Se So Cr Internal 4 credits

Use information literacy skills to form conclusion(s)

AS90853 (la) Ma Pr Se Cr Internal 4 credits

Form personal responses to independently read texts, supported by evidence

AS90854 (la) Co Ma Pr Se So Cr Internal 4 credits

Create a visual text

AS90855 (la) Co Ma Pr Se So Cr Internal 3 credits

Show understanding of visual and/or oral text(s) through close viewing and/or listening, using supporting evidence

AS90856 (la) Co Ma Pr Se Cr Internal 3 credits

Construct and deliver an oral text

AS90857 (la) Co Ma Pr Se So Cr Internal 3 credits

EN2000

English

NCEA Level 2 (course endorsement available)

The focus of Level 2 English is on ākongā developing an increasingly sophisticated understanding of purpose, audience, ideas, language and structure. Ākongā analyse existing written, visual and oral texts as well as create their own.

Within the course, ākongā can take one of several pathways depending on their goals, interests and skills. English is structured to allow maximum flexibility in course design, so ākongā can work at their own pace and alter their path at any time. All standards are available to all ākongā. Ākongā can gain UE literacy (5 reading and 5 writing credits) within this course from the following standards. AS91098, AS91099, AS91100, AS91101, AS91105, AS91106.

The initial pathways are:

- E (Endorsement)** a full NCEA achievement standard programme with the opportunity to gain endorsement at the Merit or Excellence levels. Internal and external standards.
- I (Internal)** an internal achievement standard programme, with a focus on meeting the University Entrance literacy requirement (five reading and five writing credits at Level 2 or above). Internal standards only.

Recommended prior learning: NCEA Level 1 or equivalent in English.

This course is accessed through our online learning environment, My Te Kura.

Be interviewed in a formal interview

US1294 Internal 2 credits

Be assertive in a range of specified situations

US1299 So Internal 4 credits

Select, read, and assess texts on a topic

US2989 Internal 3 credits

Write business correspondence for a workplace

US3488 Internal 3 credits

Write a short report

US3492 Internal 3 credits

Analyse specified aspect(s) of studied written text(s), supported by evidence

AS91098 (la) UElwra Co Ma Pr Se So External 4 credits

Analyse specified aspect(s) of studied visual or oral text(s), supported by evidence

AS91099 (la) UElwa Co Ma Pr Se So External 4 credits

Analyse significant aspects of unfamiliar written text(s) through close reading, supported by evidence

AS91100 (la) UElwra Co Ma Pr Se So External 4 credits

Produce a selection of crafted and controlled writing

AS91101 (la) UElwa Co Ma Pr Se So SCr Internal 6 credits

Construct and deliver a crafted and controlled oral text

AS91102 (la) Pr Se Cr Internal 3 credits

Create a crafted and controlled visual and verbal text

AS91103 (la) Pr Se So SCr Internal 3 credits

Analyse significant connections across texts, supported by evidence

AS91104 (la) Pr Se So Cr Internal 4 credits

Use information literacy skills to form developed conclusion(s)

AS91105 (la) UElra Co Ma Pr Se So Internal 4 credits

Form developed personal responses to independently read texts, supported by evidence

AS91106 (la) UElra Co Ma Pr Se So Internal 4 credits

Analyse aspects of visual and/or oral text(s) through close viewing and/or listening, supported by evidence

AS91107 (la) Cr Internal 3 credits

EN3000**English****NCEA Level 3 (course endorsement available)**

EN3000 is the course for all ākonga taking English for Level 3. The focus is on skills in 'making and creating meaning', through a range of texts in written, visual and oral forms. At Level 3 our skills reflect the sophistication of the text and our audience through critical response.

Within the course, ākonga can take one of several pathways depending on their goals, interests and skills. Ākonga can alter their path at any time. All standards are available to all ākonga.

Here are the initial options:

E (Endorsement) A full NCEA programme with the opportunity to gain endorsement at the Merit or Excellence levels – internal and external standards.

I (Internal) A focus on gaining University Entrance with internal standards.

Recommended prior learning: NCEA Level 2 or equivalent in English.

This course is accessed through our online learning environment, My Te Kura.

Write in plain English

US1279 Internal 3 credits

Write a report

US3491 Internal 4 credits

Respond critically to specified aspect(s) of studied written text(s), supported by evidence

AS91472 (la) UElwra Co Ma Pr Se So External 4 credits

Respond critically to specified aspect(s) of studied visual or oral text(s), supported by evidence

AS91473 (la) UElwa Co Ma Pr Se So External 4 credits

Respond critically to significant aspects of unfamiliar written texts through close reading, supported by evidence

AS91474 (la) UElwra Co Ma Pr Se So External 4 credits

Produce a selection of fluent and coherent writing which develops, sustains, and structures ideas

AS91475 (la) UElwa Co Pr Se So Cr Internal 6 credits

Create and deliver a fluent and coherent oral text which develops, sustains, and structures ideas

AS91476 (la) Co Ma Pr Se So Cr Internal 3 credits

Create a fluent and coherent visual text which develops, sustains, and structures ideas using verbal and visual language

AS91477 (la) Co Pr Se So Cr Internal 3 credits

Respond critically to significant connections across texts, supported by evidence

AS91478 (la) Co Ma Pr Se So Cr Internal 4 credits

Develop an informed understanding of literature and/or language using critical texts

AS91479 (la) UElra Co Pr Se So Cr Internal 4 credits

Respond critically to significant aspects of visual and/or oral text(s) through close reading, supported by evidence

AS91480 (la) Cr Internal 3 credits

Enterprise Studies

Ngā Akoranga Hinonga

In today's world it's important to be financially capable. Enterprise Studies develops ākongā's ability to make informed and effective decisions about the personal use and management of money matters. To achieve this, ākongā need an understanding of their own and others' values. Ākongā build knowledge and skills in managing money and income, setting goals and planning ahead. Being financially literate will enable them to keep more of the money they earn, do more with the money they spend, and empower them as consumers to make the right choices for themselves. It gives ākongā an understanding of how to manage their finances in the real world in order to avoid unnecessary risks and debt.

ES000

Enterprise Studies

Curriculum Levels 4–5

This course aims to help ākongā to become informed about financial matters. It teaches them to manage their earnings, savings, spending, debt and budget. It helps ākongā to set and prioritise their financial goals. They will understand that they have limited resources and, to fulfil their unlimited needs and wants, they need to make wise choices about how to manage their money.

This course also focuses on being enterprising by looking at successful entrepreneurs, being innovative, developing business plans, and taking and managing business risks. Throughout this course they will consider financial impacts on their personal life, their whānau and the wider community.

Recommended prior learning: No prior learning needed.

This course is accessed through our online learning environment, My Te Kura.

French

Te Reo Wīwī

Learning French introduces you not only to a new language but to a culture and society as well. Languages can bring people together and French is widely used for communicating in many parts of the world, including our Pacific neighbours New Caledonia and French Polynesia. People who know French can share in the rich traditions and history of France, a country that continues to fascinate the rest of the world, be it on the rugby field, in the arts or in its culinary reputation. The ability to speak French can help with travel, business and political interactions around the world.

FR000

Beginners' French

Curriculum Levels 1–5

This introductory course is designed to enable learners to communicate using basic French in everyday situations. Topics covered include: greetings, talking about yourself and family, your likes and opinions, daily life in the French-speaking world, where you live, shopping, eating and your typical day and holidays. Ākonga build a repertoire of vocabulary, grammar and formulaic expressions to give them mastery of reading, speaking, writing and listening to elementary French.

As well as language development, the course introduces learners to intercultural aspects of learning French, requiring them to reflect on their own culture and attitudes in relation to what they learn about other cultural values and practices. An appreciation of cultural differences and similarities enables learners to competently negotiate their way through situations such as how to address people and how to behave appropriately in a variety of contexts.

The course consists of 16 online interactive modules, each of which may take 8–10 hours to complete (a total of 130–160 hours). Ākonga typically cover the course in two years, but may complete it more rapidly.

Recommended prior learning: No prior learning needed.

This course is accessed through our online learning environment, My Te Kura. Ākonga will be required to make and submit audio and/or video recordings, so a microphone and camera or mobile device are essential.

FRI000

French

NCEA Level 1 (course endorsement available)

In this NCEA Level 1 course there is a focus on both written and spoken French. It builds on the basic reading, speaking, writing and listening skills acquired in the Beginners' French (FR000) course. Topics are set to reflect situations ākonga may encounter, including visiting France, holidays and travel, leisure activities, talking about their country, meals and health and staying in touch.

This one-year course consists of 10 online interactive modules, each of which may take approximately ten hours to complete (a total of 100 hours). Ākonga can sit NCEA internal and/or external achievement standards towards NCEA Level 1. The course currently offers a total of 19 credits.

Recommended prior learning: Year 10 French or equivalent or have a French language background.

This course is accessed through our online learning environment, My Te Kura. Ākonga will be required to make and submit audio and/or video recordings, so a microphone and camera or mobile device are essential.

Demonstrate understanding of a variety of spoken French texts on areas of most immediate relevance

AS90878 Pr Se So SCr External 5 credits

Give a spoken presentation in French that communicates a personal response

AS90879 Pr Internal 4 credits

Demonstrate understanding of a variety of French texts on areas of most immediate relevance

AS90881 Se External 5 credits

Write a variety of text types in French on areas of most immediate relevance

AS90882 Se SCr Internal 5 credits

FR2000**French**

NCEA Level 2 (course endorsement available)

This course offers further development in the skills of reading, speaking, writing and listening as well as building on ākongā's intercultural awareness, enabling them to become increasingly competent in French-speaking situations. Themes include France and Europe, fashion, health, technology and the future, French–New Zealand links and travelling in France and French-speaking countries.

Taking advantage of technology to communicate in real time, ākongā are encouraged to interact regularly with their kaiako to hone their conversational skills, build their confidence and develop a range of language that will enable them to manage in a variety of situations.

Recommended prior learning: NCEA Level 1 French or equivalent.

This course is accessed through our online learning environment, My Te Kura. Ākongā will be required to make and submit audio and/or video recordings, so a microphone and camera or mobile device are essential.

Demonstrate understanding of a variety of spoken French texts on familiar matters

AS91118 Se External 5 credits

Interact using spoken French to share information and justify ideas and opinions in different situations

AS91119 SSe So Cr Internal 5 credits

Give a spoken presentation in French that communicates information, ideas and opinions

AS91120 Internal 4 credits

Demonstrate understanding of a variety of written and/or visual French text(s) on familiar matters

AS91121 SSe External 5 credits

Write a variety of text types in French to convey information, ideas, and opinions in genuine contexts

AS91122 Internal 5 credits

FR3000**French**

NCEA Level 3 (course endorsement available)

This course offers further development in the skills of reading, speaking, writing and listening as well as building on ākongā's intercultural awareness, which enables them to become increasingly competent in French-speaking situations. Themes include France and Europe, fashion, health, technology and the future, French–New Zealand links and travelling in France and French-speaking countries.

Taking advantage of technology to communicate in real time, ākongā are encouraged to interact regularly with their kaiako to hone their conversational skills, build their confidence and develop a range of language that will enable them to manage a variety of situations.

Recommended prior learning: NCEA Level 2 French or equivalent.

This course is accessed through our online learning environment, My Te Kura. Ākongā will be required to make and submit audio and/or video recordings, so a microphone and camera or mobile device are essential.

Demonstrate understanding of a variety of extended spoken French texts

AS91543 Se External 5 credits

Give a clear spoken presentation in French that communicates a critical response to stimulus material

AS91544 Internal 3 credits

Interact clearly using spoken French to explore and justify varied ideas and perspectives in different situations

AS91545 Se So Cr Internal 6 credits

Demonstrate understanding of a variety of extended written and/or visual French texts

AS91546 External 5 credits

Write a variety of text types in clear French to explore and justify varied ideas and perspectives

AS91547 Se Internal 5 credits

Gateway/STAR

Ngā Pokenga Mahi/STAR

Gateway is a tailored programme for ākonga who have a chosen career path and want to gain the skills and experience needed to further their goals. Structured around work-based learning, Gateway allows ākonga to learn and work while still at school. Full-time ākonga and young adults in a full-time course in Years 11 to 13 can apply for Gateway and complete a work placement and learning plan, which will give them confidence to go out and achieve their goals.

STAR offers ākonga access to short tertiary courses, either to explore an area of interest, e.g. Barista, or find out more about a particular tertiary course, e.g. Hospitality.

GATEWAY

Gateway

NCEA Levels 1–3

The Gateway programme is a structured, work-based learning programme in a vocational pathway of an ākonga's choice. The Gateway co-ordinator works with each ākonga to develop an individual Gateway learning plan related to the ākonga's particular workplace and industry.

Ākonga must arrange and complete a regular and ongoing work placement. Over the duration of the work placement, ākonga will receive on-the-job training from their workplace supervisor.

Gateway applications are welcome from our full-time and young adult ākonga in a full time programme and Years 11 to 13 ākonga who are work ready. Places are limited.

Read more about Gateway www.tekura.school.nz/learn-with-us/learn-with-us/secondary-tertiary-pathways/

Recommended prior learning: No prior learning needed.

STAR

STAR

NCEA Levels 1–3

STAR courses are short courses at polytechnics or private training providers specifically designed for secondary school ākonga. Courses give ākonga an introduction to training for a particular trade or skill. They range in length from a single day, several days in a row or one day a week for up to two terms.

STAR courses are not a subject, rather they complement the ākonga's studies at Te Kura. However, it is possible to gain unit standards and these credits can be used towards NCEA.

A secondary–tertiary advisor for each region advertises available programmes through the Te Kura website or through the ākonga's learning advisor. Ākonga can link to the programmes, and our Secondary Tertiary Pathways page through My Korowai, Leaving to Learn.

Ākonga accepted onto STAR courses are typically in Years 11 to 13 and enrolled as a full time ākonga, or a young adult studying three or more subjects. Year 10 ākonga may apply for taster courses and in some exceptional circumstances may be referred by their kaiako for a unit standard course.

Dual ākonga are not eligible for STAR courses at Te Kura.

Te Kura also arranges some courses just for our ākonga. These include outdoor education camps, Learner Licence, first aid courses and tertiary distance courses.

Recommended prior learning: No prior learning needed.

Geography

Te Mātauranga Mātai Matawhenua

Geography explores the relationships and connections between people and their natural and cultural environments. Geography investigates the ways in which features are arranged on the Earth's surface and describes and explains the patterns and processes that create them. Ākonga learn to think spatially and use maps, visual images and new technologies to obtain, present and analyse information. Geography can be studied at tertiary level as a science or humanities subject. It leads to a wide variety of careers in environmental and urban planning and the public sector.

GY1000

Geography

NCEA Level 1 (course endorsement available)

This is an introduction to geography and its basic skills and concepts. Ākonga learn how people interact with their natural and cultural environments through studies of population concepts, sustainability and the effects of extreme natural events.

Ākonga learn how to draw and interpret maps, as well as how to interpret a variety of information and data. There is a focus on both New Zealand and global issues, which develops research and observation skills and gives ākonga the ability to take action and solve problems.

Recommended prior learning: Ākonga should have a reasonable level of literacy.

This course is accessed through our online learning environment, My Te Kura.

Demonstrate geographic understanding of environments that have been shaped by extreme natural event(s)

AS91007 (la) Pr Se External 4 credits

Demonstrate geographic understanding of population concepts

AS91008 (la) Se So Cr External 4 credits

Demonstrate geographic understanding of the sustainable use of an environment

AS91009 (la) Pr Se Internal 3 credits

Apply concepts and basic geographic skills to demonstrate understanding of a given environment

AS91010 (na) UEna Co Pr Se Cr External 4 credits

Conduct geographic research, with direction

AS91011 (lna) UEna Pr Se Internal 4 credits

Describe aspects of a contemporary New Zealand geographic issue

AS91012 (la) Se So Cr Internal 3 credits

Describe aspects of a geographic topic at a global scale

AS91013 (la) Pr Se Cr Internal 3 credits

Apply spatial analysis, with direction, to solve a geographic problem

AS91014 (la) Pr Se Internal 3 credits

GY2000

Geography

NCEA Level 2 (course endorsement available)

At this level, ākonga study how a large natural environment has evolved over time and created specific landscape features. Ākonga are also asked to consider the differences between developed and less developed countries and how these differences affect their people and society. Issues such as access to safe water and the generation of wind power are considered on both a national and an international level.

Basic geographic skills and techniques are expanded and the ability to analyse and interpret an array of data is developed. There is the opportunity to conduct a survey, process the results, reach conclusions and critically evaluate the research findings.

Recommended prior learning: Ākonga should have a reasonable level of literacy.

This course is accessed through our online learning environment, My Te Kura.

Demonstrate geographic understanding of a large natural environment

AS91240 (la) UElra Pr SSe External 4 credits

Demonstrate geographic understanding of differences in development

AS91242 (la) UElra Se So External 4 credits

Apply geography concepts and skills to demonstrate understanding of a given environment

AS91243 (la) Co Pr Se External 4 credits

Conduct geographic research with guidance

AS91244 (lna) UEna Se Cr Internal 5 credits

Explain aspects of a contemporary New Zealand geographic issue

AS91245 (la) Se So Cr Internal 3 credits

Explain aspects of a geographic topic at a global scale

AS91246 (la) Pr Se Internal 3 credits

GY3000

Geography

NCEA Level 3 (course endorsement available)

This geography course involves detailed study of natural processes, such as volcanism, and cultural processes, such as tourism development. The decision-making processes for obtaining resource planning consent are examined. Advanced research skills are developed through topics of the ākonga's choice that relate to environmental issues.

New Zealand Scholarship exams are designed to extend very high-achieving Level 3 ākonga. Those who wish to enter the New Zealand Scholarship exam in this subject must discuss this option with their Te Kura subject kaiako.

Recommended prior learning: Ākonga should have a reasonable level of literacy.

This course is accessed through our online learning environment, My Te Kura.

Demonstrate understanding of how interacting natural processes shape a New Zealand geographic environment

AS91426 (la) UElwra Pr Se External 4 credits

Demonstrate understanding of how a cultural process shapes geographic environment(s)

AS91427 (la) UElwra Se External 4 credits

Analyse a significant contemporary event from a geographic perspective

AS91428 (la) UElra Se Internal 3 credits

Demonstrate understanding of a given environment(s) through selection and application of geographic concepts and skills

AS91429 (la) UElwra Co Pr Se External 4 credits

Conduct geographic research with consultation

AS91430 (lna) UEna Se Internal 5 credits

Analyse aspects of a contemporary geographic issue

AS91431 (la) UElra Se So Cr Internal 3 credits

Analyse aspects of a geographic topic at a global scale

AS91432 (la) UElra Pr Se Cr Internal 3 credits

German

Te Reo Tiamana

Germany is a country with a long and rich heritage and is the geographic and cultural centre of Europe. The German language is closely related to English and is more similar to it than to any other language. There are 100 million German speakers throughout Europe, from Austria to Switzerland, and it is also a popular language in New Zealand. There are numerous close links between New Zealand and Germany through trade, tourism and exchanges, which makes knowledge of the German language and people an incredibly useful skill across many areas.

GR000

Beginners' German

Curriculum Levels 1–5

This is a two-part course for beginners (Curriculum Levels 1–3) and advanced beginners (Curriculum Levels 4–5). If ākonga have had prior regular learning for German for about one school year or have some native speaker background, they may wish to consider starting with part two. For all other ākonga, we advise starting with part one.

When enrolling in this course, ākonga should indicate which part they want to enrol for. In the first part, ākonga are introduced to basic listening, speaking, reading and writing skills using everyday German. They learn how to greet people and communicate basic information about themselves and others, including looks, hobbies, birthdays, family and home. They also learn to communicate about food, directions and what time it is.

German culture is also investigated to give ākonga a broad understanding of the country and customs, behaviour and life in Germany.

In the second part, grammar and all language skills are covered in greater depth to increase ākonga's confidence and language skills. Common and everyday aspects of German language and culture are at the centre of this part of the course. Ākonga learn how to communicate further about their world, personality, whānau and interests.

Practical topics are also explored such as purchasing goods and communicating about holidays, festivals and the weather. Communication activities are emphasised throughout.

Recommended prior learning: Prior learning required for second part.

This course is accessed through our online learning environment, My Te Kura. Ākonga will be required to make and submit audio and/or video recordings, so a microphone and camera or mobile device are essential.

GR1000

German

NCEA Level 1 (course endorsement available)

Ākonga will consolidate their listening, speaking and reading skills and gain an understanding of basic German grammar and writing. There is a focus on communicating and aspects relating to home and family life, as well as a range of leisure activities. This course offers a broad insight into life in both Germany and New Zealand, and includes studies of some major German cities and areas.

Recommended prior learning: Ākonga should have completed Year 10 German or equivalent or have a German language background.

This course is accessed through our online learning environment, My Te Kura. Ākonga will be required to make and submit audio and/or video recordings, so a microphone and camera or mobile device are essential.

Demonstrate understanding of a variety of spoken German texts on areas of most immediate relevance

AS90883 Pr Se So SCr External 5 credits

Give a spoken presentation in German that communicates a personal response

AS90884 Pr SCr Internal 4 credits

Demonstrate understanding of a variety of German texts on areas of most immediate relevance

AS90886 Se External 5 credits

Write a variety of text types in German on areas of most immediate relevance

AS90887 Se SCr Internal 5 credits

GR2000**German**

NCEA Level 2 (course endorsement available)

Ākongā consolidate and extend their German language skills and further develop their understanding of life in Germany. There is an emphasis on advancing ākongā's ability to communicate verbally and through writing, and ākongā extensively build on their vocabulary and grammar.

Topics explored are theme based and focus on everyday situations, including aspects relating to social and school life and looking at the environment, youth and future careers. Social and economic relationships between New Zealand and Germany are discussed alongside a broader investigation into cultural issues where ākongā learn about Berlin, Germany's multi-cultural population and other German-speaking nations.

Recommended prior learning: NCEA Level 1 German or equivalent.

This course is accessed through our online learning environment, My Te Kura. Ākongā will be required to make and submit audio and/or video recordings, so a microphone and camera or mobile device are essential.

Demonstrate understanding of a variety of spoken German texts on familiar matters

AS91123 Se External 5 credits

Interact using spoken German to share information and justify ideas and opinions in different situations

AS91124 SSe So Cr Internal 5 credits

Give a spoken presentation in German that communicates information, ideas and opinions

AS91125 Internal 4 credits

Demonstrate understanding of a variety of written and/or visual German text(s) on familiar matters

AS91126 SSe External 5 credits

Write a variety of text types in German to convey information, ideas, and opinions in genuine contexts

AS91127 Internal 5 credits

GR3000**German**

NCEA Level 3 (course endorsement available)

This course advances ākongā's linguistic development and German language skills. It challenges them to read, write and speak German in unfamiliar contexts and using more complex language, which broadens their vocabulary, grammatical and written abilities.

The focus is built around various themes that explore different aspects of German culture, its people and events. Ākongā are challenged to express their thoughts and opinions on topics, including traditional stories, media and the creative arts, in German as much as possible.

New Zealand Scholarship exams are designed to extend very high-achieving Level 3 ākongā. Those who wish to enter the New Zealand Scholarship exam in this subject must discuss this option with their Te Kura subject kaiako.

Recommended prior learning: NCEA Level 2 German or equivalent.

This course is accessed through our online learning environment, My Te Kura. Ākongā will be required to make and submit audio and/or video recordings, so a microphone and camera or mobile device are essential.

Demonstrate understanding of a variety of extended spoken German texts

AS91548 Se External 5 credits

Give a clear spoken presentation in German that communicates a critical response to stimulus material

AS91549 Internal 3 credits

Interact clearly using spoken German to explore and justify varied ideas and perspectives in different situations

AS91550 Se So Internal 6 credits

Demonstrate understanding of a variety of extended written and/or visual German texts

AS91551 External 5 credits

Write a variety of text types in clear German to explore and justify varied ideas and perspectives

AS91552 Se Internal 5 credits

Health Education

Mātauranga Hauora

In Health Education ākonga consider the influences on their wellbeing, attitudes and values, and work towards promoting the health of their community. Ākonga can participate in a range of tasks, including considering ways to keep themselves safe in different situations and learning effective methods to communicate to help develop healthy relationships. Issues related to ethics and health philosophies are explored, which develops critical thinking skills in ākonga. Health Education can be studied at tertiary levels as a science or humanities subject. It leads to a wide variety of careers in social, community and health sectors.

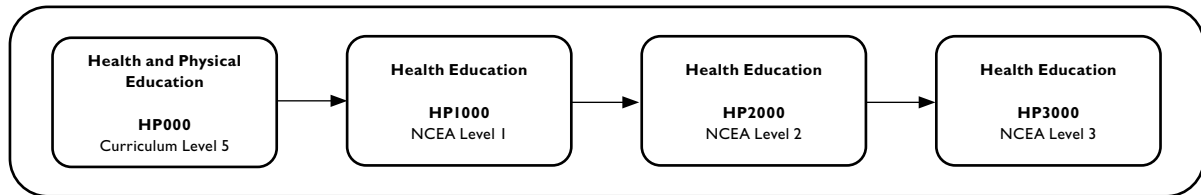

HP000

Health and Physical Education

Curriculum Level 5

In this course ākonga explore health issues (such as wellbeing, nutrition, communication, decision making and problem solving) and safety issues (such as drug use and understanding gender and sexuality). Ākonga also study physical education topics such as understanding the body, fitness testing, participating in a variety of activities and being involved in training programmes.

Recommended prior learning: No prior learning needed.

This course is accessed through our online learning environment, My Te Kura.

HP1000

Health Education

NCEA Level 1 (course endorsement available)

This course follows on from Health and Physical Education (HP000). In Health Education ākonga explore health issues: the changing states of health, problem solving, interpersonal skills, understanding sexuality and gender and safety issues around drug use.

The health topics offer 20 credits towards NCEA Level 1. There are four internal standards worth 16 credits and one external standard worth four credits. Health topics offer 20 literacy credits. To gain course endorsement ākonga need to complete 14 credits in Health Education (this must include the exam).

Recommended prior learning: No prior learning needed.

This course is accessed through our online learning environment, My Te Kura.

Take action to enhance an aspect of personal well-being

AS90971 (1a) Pr Se So Cr Internal 3 credits

Demonstrate understanding of interpersonal skills used to enhance relationships

AS90973 (1a) Pr Se So Internal 5 credits

Demonstrate understanding of strategies for promoting positive sexuality

AS90974 (1a) So Internal 4 credits

Demonstrate understanding of issues to make health-enhancing decisions in drug-related situations

AS90975 (1a) Pr Se So Cr External 4 credits

Demonstrate understanding of ways in which well-being can change and strategies to support well-being

AS91097 (1a) Pr Se So Cr Internal 4 credits

HP2000**Health Education**

NCEA Level 2 (course endorsement available)

This course follows on from Health Education – NCEA Level 1 (HPI000) and is useful, often essential for ākongā intending to continue with Level 3 Health Education courses.

Health Education offers ākongā the opportunity to explore health issues, such as resiliency, improve wellbeing, understand sexuality and gender, body image and drug use.

The Health Education topics offer 20 credits towards NCEA Level 2. There are 3 internal standards worth 15 credits and 1 external standard worth 5 credits. These Health Education topics also offer 20 literacy credits.

To gain course endorsement ākongā need to complete 14 credits in Health Education (which includes the exam).

Recommended prior learning: NCEA Level 1 Health Education or equivalent.

This course is accessed through our online learning environment, My Te Kura.

Analyse an adolescent health issue

AS91235 (la) Pr Se So External 5 credits

Evaluate factors that influence people's ability to manage change

AS91236 (la) Pr Se SSo Internal 5 credits

Take action to enhance an aspect of people's well-being within the school or wider community

AS91237 (la) Se Sso Internal 5 credits

Analyse issues related to sexuality and gender to develop strategies for addressing the issues

AS91239 (la) Pr SSo Internal 5 credits

HP3000**Health Education**

NCEA Level 3 (course endorsement available)

This course follows on from Health Education – NCEA Level 2 (HP2000) and is often essential for ākongā intending to continue with Health Education courses at tertiary institutions.

In Health Education ākongā explore a New Zealand and an international health issue, evaluate health practices and analyse an ethical issue.

The Health Education topics offer 19 credits towards NCEA Level 3. There are 3 internal standards worth 14 credits and 1 external standard worth 5 credits. These Health Education topics also offer 19 literacy credits.

To gain course endorsement or entry to a tertiary institution you will need to complete 14 credits in Health Education (which includes an exam).

Recommended prior learning: NCEA Level 2 Health Education or equivalent.

This course is accessed through our online learning environment, My Te Kura.

Analyse a New Zealand health issue

AS91461 (la) UElra Pr Se So Internal 5 credits

Analyse an international health issue

AS91462 (la) UElwra Pr Se So External 5 credits

Evaluate health practices currently used in New Zealand

AS91463 (la) Se So Internal 5 credits

Analyse a contemporary ethical issue in relation to well-being

AS91464 (la) UElra Pr Se So Internal 4 credits

History

Kōrero Nehe

To understand the past is to understand the present. History gives ākonga an insight into current world problems and New Zealand's identity and place in world events. It explores people and events and how they have influenced the world. History is not just about presenting the facts, but observing and questioning values and attitudes. Ākonga improve their communication and writing skills, which enables them to express clear, convincing and well-thought-out arguments. From ancient civilisations to contemporary pop culture, from wars to peace treaties, history is both a fascinating and intellectually stimulating subject.

HS1000

History

NCEA Level 1 (course endorsement available)

Over the last 100 years, the world has undergone rapid and significant change. This course focuses on significant, and at times horrific, historical events throughout the 20th century. The effects of events that are studied can still be seen and can help to provide an understanding of today's international problems.

Ākonga look at why peace did not last in the 1930s and the origins of World War II. Other conflicts investigated include Palestine and Israel, with a focus on the period 1935–2010, and race relations in apartheid-era South Africa.

New Zealand's past is also explored through topics about bicultural relations between Māori and Pakeha and the nation's search for security post-World War II.

Ākonga also have the opportunity to undertake their own historical research project on either 'An Enemy of the State' or the 1981 Springbok rugby tour.

Recommended prior learning: Ākonga should have a reasonable level of literacy.

This course is accessed through our online learning environment, My Te Kura.

Carry out an investigation of an historical event, or place, of significance to New Zealanders

AS91001 (la) Se So Cr Internal 4 credits

Demonstrate understanding of an historical event, or place, of significance to New Zealanders

AS91002 (la) Se Cr Internal 4 credits

Interpret sources of an historical event of significance to New Zealanders

AS91003 (la) Se So Cr External 4 credits

Demonstrate understanding of different perspectives of people in an historical event of significance to New Zealanders

AS91004 (la) Se So Cr Internal 4 credits

Describe the causes and consequences of an historical event

AS91005 (la) Cr External 4 credits

Describe how a significant historical event affected New Zealand society

AS91006 (la) Cr External 4 credits

HS2000

History

NCEA Level 2 (course endorsement available)

This course gives ākonga an insight into the people and events that have shaped the modern world during the past 150 years. It was a period of significant change with the rise of nationalism, feminism, fascism and communism being just a few of the influential forces that emerged.

Ākonga look into the origins of World War I, the conflict in Vietnam (1945–1975) and how these events affected New Zealand and the changing roles and opportunities for women in New Zealand from 1880–1960.

This course helps develop historical skills such as recognising and examining evidence and presenting information. Ākonga undertake in-depth research work on either the end of World War I and the extent of New Zealand's contribution to the victory or an aspect of the home front in New Zealand during World War II.

Recommended prior learning: Ākonga should have a good level of literacy.

This course is accessed through our online learning environment, My Te Kura.

Carry out an inquiry of an historical event or place that is of significance to New Zealanders

AS91229 (la) UEIra Se Internal 4 credits

Examine an historical event or place that is of significance to New Zealanders

AS91230 (la) UEIra Se Internal 5 credits

Examine sources of an historical event that is of significance to New Zealanders

AS91231 (la) UElwra External 4 credits

Interpret different perspectives of people in an historical event that is of significance to New Zealanders

AS91232 (la) UElra Cr Internal 5 credits

Examine causes and consequences of a significant historical event

AS91233 (la) UElwra External 5 credits

Examine how a significant historical event affected New Zealand society

AS91234 (la) UElwra External 5 credits

HS3000

History

NCEA Level 3 (course endorsement available)

This course consists of two main parts which may be studied in any order. Either one or both parts may be studied.

Part one – ākongā complete an in-depth study of one of the following two options.

either: Tudor and Stuart England from 1558 to 1660. This was a time of great upheaval and intrigue. Ākongā look at how England was governed, issues facing monarchs such as Elizabeth I and the early Stuart kings and developments during the Civil War and Interregnum. By exploring this time period, ākongā learn about early modern English society and its economy, the religious changes that occurred, and how these remain relevant even today (leading to two external standards). A third (external) source interpretation standard is also available.

or: an in-depth study of New Zealand in the 19th century. Ākongā explore how Māori and Pakeha interacted, the economic and political changes that occurred and the social issues and attitudes that existed. Ākongā will look in detail at some major events in our history from the Treaty of Waitangi to the New Zealand Wars. New Zealand's development from isolated to settled is also covered (leading to one internal and two external standards). A third (external) source interpretation standard is also available.

Note: Ākongā choosing Tudor and Stuart England have the option to complete additional internal standards based on an analysis of sources related to the Treaty of Waitangi.

Part two – ākongā research a 'contested historical event' that they choose but which must be confirmed in consultation with their kaiako. Examples of possible events that ākongā may choose to research include: the decision to drop the atomic bomb on Hiroshima; New Zealand's involvement in the loss of Crete to German forces in 1941; the impact of New Zealand woman getting the vote; was the trial of Mary Stuart, or Charles I justified?; the effects on Māori of large-scale Pakeha migration in the 19th century (leading to two internal standards).

New Zealand Scholarship exams are designed to extend very high achieving Level 3 ākongā. Those who wish to enter the New Zealand Scholarship exam in this subject must discuss this option with their Te Kura subject kaiako.

Recommended prior learning: Ākongā should have a very good level of literacy.

This course is accessed through our online learning environment, My Te Kura.

Research an historical event or place of significance to New Zealanders, using primary and secondary sources

AS91434 (la) UElra Pr Se Internal 5 credits

Analyse an historical event, or place, of significance to New Zealanders

AS91435 (la) UElra Pr Se Cr Internal 5 credits

Analyse evidence relating to an historical event of significance to New Zealanders

AS91436 (la) UElwra Pr External 4 credits

Analyse different perspectives of a contested event of significance to New Zealanders

AS91437 (la) UElra Cr Internal 5 credits

Analyse the causes and consequences of a significant historical event

AS91438 (la) UElwra External 6 credits

Analyse a significant historical trend and the force(s) that influenced it

AS91439 (la) UElwra External 6 credits

Home Economics

Te Mātauranga Ohaoha Kāinga

In Home Economics ākonga develop their understanding of the factors that influence wellbeing. There is a strong focus on food and nutrition. Ākonga evaluate current issues and theories of nutrition and use this knowledge to make informed decisions about food. Through the processes of selecting, preparing, cooking and serving food, ākonga develop creativity and personal skills crucial to everyday living. Issues relating to family and society are also explored, which aims to give ākonga the ability and independence to plan for their future.

HE000

Home Economics

Curriculum Level 5

In this course ākonga think critically about food and nutrition. Nutrition is fundamental to developing a sense of wellbeing to meet the growth and development needs of healthy, confident young people. The course offers opportunities for ākonga to: examine and evaluate their food choices and food-related behaviour; challenge opinions and positions, take action to address food and nutrition-related issues and examine the influence of culture, tradition and media on food choices.

Recommended prior learning: No prior learning needed.

This course is accessed through our online learning environment, My Te Kura.

HE1000

Home Economics

NCEA Level I (course endorsement available)

Ākonga learn how to use basic nutritional knowledge to make food choices that contribute to health and wellbeing. This course gives ākonga a broader understanding of their own and others' nutritional demands. Safe food practices and preparation skills are taught and assessed. Societal and cultural influences are considered when looking at eating patterns.

Recommended prior learning: No prior learning needed.

This course is accessed through our online learning environment, My Te Kura.

Demonstrate knowledge of an individual's nutritional needs

AS90956 Pr Se So Internal 5 credits

Demonstrate understanding of societal influences on an individual's food choices and well-being

AS90957 (1a) Se So Internal 5 credits

Demonstrate understanding of how cultural practices influence eating patterns in New Zealand

AS90958 (1a) Se So Internal 5 credits

Demonstrate knowledge of practices and strategies to address food handling issues

AS90959 (1a) Pr Se So Internal 5 credits

Demonstrate understanding of how packaging information influences an individual's food choices and well-being

AS90961 (1a) Pr Se So External 4 credits

HE2000**Home Economics**

NCEA Level 2 (course endorsement available)

This course has a strong emphasis on taking action to enhance wellbeing. Ākongā learn about sustainable health-enhancing change for individuals, communities and society. There is an opportunity for ākongā to develop skills to formulate their own solutions.

Recommended prior learning: NCEA Level 1 Home Economics or equivalent.

This course is accessed through our online learning environment, My Te Kura.

Exercise informed choice in deciding on a major goods or service purchase

US7127 Internal 2 credits

Describe legal implications of living in rented accommodation and means to prevent and resolve related problems

US12354 Internal 4 credits

Describe household conservation strategies

US12359 Internal 3 credits

Analyse issues related to the provision of food for people with specific food needs

AS91299 (la) Se So Internal 5 credits

Analyse the relationship between well-being, food choices and determinants of health

AS91300 (la) Se SSo External 4 credits

Analyse beliefs, attitudes and practices related to a nutritional issue for families in New Zealand

AS91301 (la) Se So Internal 5 credits

Evaluate sustainable food related practices

AS91302 (la) Pr Se So Internal 5 credits

Analyse practices to enhance well-being used in care provision in the community

AS91303 (la) SSo Internal 5 credits

HE3000**Home Economics**

NCEA Level 3 (course endorsement available)

Ākongā critically analyse current nutritional issues and there is scope to develop research skills and challenge their own attitudes and values.

Knowledge gained from previous studies in Home Economics and Health Education will be beneficial for ākongā studying at this level. Home Economics NCEA Level 3 prepares ākongā for tertiary education.

New Zealand Scholarship exams are designed to extend very high achieving Level 3 ākongā. Those who wish to enter for the NZ Scholarship exam in this subject must discuss the option with their Te Kura subject kaiako.

Recommended prior learning: A good level of literacy is required.

This course is accessed through our online learning environment, My Te Kura.

Investigate a nutritional issue affecting the well-being of New Zealand society

AS91466 (la) UElra Se So Internal 5 credits

Implement an action plan to address a nutritional issue affecting the well-being of New Zealand society

AS91467 (la) Internal 5 credits

Analyse a food related ethical dilemma for New Zealand society

AS91468 (la) UElra Se So Internal 5 credits

Investigate the influence of multinational food corporations on eating patterns in New Zealand

AS91469 (la) UElra Pr Se So Internal 5 credits

Analyse the influences of food advertising on well-being

AS91471 (la) UElwa Se So External 4 credits

Japanese

Te Reo Hapanihi

Learning Japanese gives ākonga the chance to communicate in a different language, and to gain an appreciation of a fascinating culture. Ākonga develop their speaking and listening skills, as well as reading and using the unique kanji writing system, which can be a rewarding and enjoyable experience. Ākonga will find knowledge of Japanese very helpful if they are planning on travelling to Japan or hosting Japanese visitors.

JP000

Beginners' Japanese

Curriculum Levels 1–5

This introductory course has two parts. Part one covers Curriculum Levels 1–3, and part two covers Curriculum Levels 4–5.

Throughout the course, ākonga develop speaking, listening, reading and writing skills. This includes learning to read and write Japanese script. An integral part of the course is learning about Japanese culture and gaining an intercultural understanding.

In part one, ākonga learn how to introduce themselves, greet others, count, communicate while shopping and eating out and describe their family, daily routine, hobbies and interests. Hiragana script is covered as well as some katakana script. Ākonga need to have completed part one (or equivalent previous study) before beginning part two.

In part two of the course, ākonga learn colours and how to describe appearances, events, travel plans and holidays and their home and surroundings. Katakana script is completed and some kanji are introduced. Ākonga also develop Japanese typing skills.

Recommended prior learning: For Part Two, ākonga will need the equivalent of one year of learning and will need to be able to read and write hiragana.

This course is accessed through our online learning environment, My Te Kura. Ākonga will be required to make and submit audio and/or video recordings, so a microphone and camera or mobile device are essential.

JP1000

Japanese

NCEA Level 1 (course endorsement available)

Ākonga extend their reading, writing, listening and speaking skills through the experiences of a New Zealand ākonga on a home stay in Japan. Within this theme, ākonga cover aspects of daily life such as family relationships, travel preparations, hobbies and sports. Other topics include houses and furnishings, senior high school life and travelling by bullet train. Overall, there are approximately 60 kanji characters to learn.

Recommended prior learning: Ākonga must have completed Year 10 Japanese or equivalent or have a Japanese language background. Ability to read and write hiragana is essential and knowledge of katakana is an advantage.

This course is accessed through our online learning environment, My Te Kura. Ākonga will be required to make and submit audio and/or video recordings, so a microphone and camera or mobile device are essential.

Demonstrate understanding of a variety of spoken Japanese texts on areas of most immediate relevance

AS90893 Pr Se So SCr External 5 credits

Give a spoken presentation in Japanese that communicates a personal response

AS90894 Pr Internal 4 credits

Demonstrate understanding of a variety of Japanese texts on areas of most immediate relevance

AS90896 Se External 5 credits

Write a variety of text types in Japanese on areas of most immediate relevance

AS90897 Se SCr Internal 5 credits

JP2000**Japanese**

NCEA Level 2 (course endorsement available)

This course introduces about 75 new kanji characters and further extends the ability to read, write, speak and listen in Japanese. Topics covered include: the Japanese school system, land and people, leisure, work, family life, travel and tourism, eating and drinking.

Recommended prior learning: NCEA Level 1 Japanese course or equivalent.

This course is accessed through our online learning environment, My Te Kura. Ākonga will be required to make and submit audio and/or video recordings, so a microphone and camera or mobile device are essential.

Demonstrate understanding of a variety of spoken Japanese texts on familiar matters

AS91133 Se External 5 credits

Interact using spoken Japanese to share information and justify ideas and opinions in different situations

AS91134 SSe So Cr Internal 5 credits

Give a spoken presentation in Japanese that communicates information, ideas and opinions

AS91135 Internal 4 credits

Demonstrate understanding of a variety of written and/or visual Japanese text(s) on familiar matters

AS91136 SSe External 5 credits

Write a variety of text types in Japanese to convey information, ideas, and opinions in genuine contexts

AS91137 Internal 5 credits

JP3000**Japanese**

NCEA Level 3 (course endorsement available)

This course introduces about 70 new kanji characters and further extends the ability to read, write, speak and listen in Japanese. Topics covered include: work, leisure, family, travel and tourism, land and people, communication and the media. New Zealand Scholarship exams are designed to extend very high achieving Level 3 ākonga. Those who wish to enter the New Zealand Scholarship exam in this subject must discuss this option with their Te Kura subject kaiako.

Recommended prior learning: NCEA Level 2 Japanese course or equivalent.

This course is accessed through our online learning environment, My Te Kura. Ākonga will be required to make and submit audio and/or video recordings, so a microphone and camera or mobile device are essential.

Demonstrate understanding of a variety of extended spoken Japanese texts

AS91553 Se External 5 credits

Give a clear spoken presentation in Japanese that communicates a critical response to stimulus material

AS91554 Internal 3 credits

Interact clearly using spoken Japanese to explore and justify varied ideas and perspectives in different situations

AS91555 Se So Cr Internal 6 credits

Demonstrate understanding of a variety of extended written and/or visual Japanese texts

AS91556 External 5 credits

Write a variety of text types in clear Japanese to explore and justify varied ideas and perspectives

AS91557 Se Internal 5 credits

Kaupapa Māori

Kaupapa Māori

Kaupapa Māori is a learning area rich in Te Ao Māori skills, knowledge and topics. There is a wide variety of kaupapa to explore and engage in, and ample opportunity to connect learning from a Māori context to other subjects offered at Te Kura.

Kaupapa Māori offers eleven main subjects as listed below, and the opportunity to explore more than 80 kaupapa within those subjects.

Learning can be tailored to suit ākonga at all levels of the curriculum, from primary and intermediate to NCEA Levels 1–3.

Ākonga are supported by kaiako, kaimanaaki, whānau and hāpori to select pathways of learning relevant to their aspirations, career pathway or interests and passions. Ākonga are encouraged to link with their local area experts, online communities and whānau who have skills and experience to guide them through these learning kaupapa.

While there may be flexibility for a blended approach, this course will primarily be accessed through our online learning environment My Te Kura. For this course ākonga will be required to make and submit audio and/or video recordings, so a microphone and camera or mobile device are recommended. Submissions can also be written, video, audio, art and performance based. Please discuss with your kaiako upon enrolment.

We welcome submissions in te reo Māori and English for all kaupapa Māori subjects.

EM9000

Environmental Māori

NCEA Levels 1–3

Environment Māori provides the chance to explore the world around you and to investigate the importance of the delicate relationship between humans and the Earth. In this subfield you have the chance to learn more about native birds, insects, waterways and forests. You can explore what it means to be a kaitiaki and how you can play an active role in helping your local community.

Recommended prior learning: No prior learning needed but, interest, passion and determination are desirable.

Describe tapu, noa, and mana in relation to the way Māori interact with te taiao

US6137 Internal 3 credits

Explain the role of whakataukī in relation to how Māori manage te taiao

US6138 Internal 2 credits

Describe aroha in relation to the way Māori interact with te taiao

US6139 Internal 2 credits

Demonstrate knowledge of kai preservation

US15983 Internal 2 credits

Demonstrate knowledge of the use of rākau Māori

US15985 Internal 3 credits

Demonstrate knowledge of tikanga for the preparation of mahinga kai

US15988 Internal 2 credits

Demonstrate knowledge of a native bird and its significance to Māori

US15990 Internal 4 credits

Demonstrate knowledge of a native insect and its significance to Māori

US15991 Pr Internal 2 credits

Describe the role of, and interactions between atua Māori in te taiao

US19670 Internal 2 credits

Identify and describe a Māori view of te taiao

US19671 Internal 4 credits

Describe whanaungatanga in relation to how Māori interact and take care of te taiao

US6141 Internal 3 credits

Explain tikanga Māori for the use of rākau Māori in clothing, whare, waka and implements

US15987 Internal 3 credits

Explain kaitiakitanga in relation to the way Māori interact with the natural environment

US6142 Internal 4 credits

Carry out a local kaitiakitanga activity with direction

US6143 Internal 6 credits

Explain wahi tapu in relation to how Māori manage the environment

US6144 Internal 5 credits

Analyse the different views Māori and Pākehā have in relation to the natural world

US6147 Internal 4 credits

HA9000**Hauora NCEA****NCEA Levels 1–3**

Hauora explores two major concepts; personal wellbeing and whānau (or collective) wellbeing. This subfield encourages ākongā to explore principles of hauora, how these relate to whānau wellbeing and practical skills needed to help lead a healthier life. In Hauora you will connect with local hāpori, hapu and iwi to support your development of skills and knowledge. Hauora is a holistic approach to health and wellbeing. It explores concepts of physical, mental, spiritual and whānau wellbeing within te ao Māori.

Recommended prior learning: No prior learning needed but, interest, passion and determination are desirable.

From a Māori world view describe the key elements of hinengaro, tinana, wairua and whānau

US29583 Internal 3 credits

Explain tikanga in relation to the treatment of an injury

US29588 Internal 2 credits

Explain tikanga in relation to the human anatomy

US29589 Internal 2 credits

Manage personal safety of kaimahi when working with whānau

US15315 So Internal 3 credits

Demonstrate knowledge of tikanga in relation to rongoā rākau

US15986 Internal 2 credits

Explain anger management in a hauora context

US29585 Internal 4 credits

Explain the principles and concepts of hauora based on a Māori world view

US15299 Internal 4 credits

Demonstrate knowledge of the human life course in a hauora context

US15310 Internal 4 credits

Explain four key dimensions of hauora

US18352 Internal 3 credits

Explain the values of whānau and peers in relation to sex and sexuality

US18353 Internal 3 credits

Explain the impact of teenage pregnancy on whānau

US18354 Internal 3 credits

Develop a substance abuse cessation programme in a hauora context

US18356 Internal 3 credits

Develop, implement, and evaluate a substance abuse awareness programme for rangatahi

US18357 Internal 3 credits

Prepare a nutritionally balanced diet using kai tōtika Māori

US18360 Internal 4 credits

Explain Māori childcare practices pre and post-Pākehā contact

US18361 Internal 5 credits

Explain and apply tikanga associated with hauora in the home

US18363 Internal 4 credits

Demonstrate knowledge of rongoā Māori in relation to the prevention and treatment of illness

US29584 Internal 3 credits

Explain the impact of grief from a Māori perspective

US29586 Internal 4 credits

Demonstrate knowledge of whanaungatanga and whānau ora

US30617 Internal 6 credits

Identify and explain traditional and contemporary methods of effective communication used by whānau

US30618 Internal 8 credits

Explain the significance of kaitiakitanga within a whānau ora context

US30619 Internal 6 credits

Demonstrate manaakitanga in relation to whānau ora

US30620 Internal 4 credits

Identify and apply tikanga and kawa within the home or workplace environment

US30621 Internal 8 credits

Describe rangatiratanga and mana whenua, as it relates to whānau ora

US30624 Internal 4 credits

KH9000**Māori Performing Arts**

NCEA Levels 1–3

Māori Performing Arts is where identity and culture is shared through the creation and performance of waiata, dance and movement. In this sub field you will explore how to perform mōteatea, waiata-a-ringā, haka and poi. You will have the chance to create and perform waiata and movement sequences. Māori Performing Arts investigates haka wahine and tane, as well as exploring how and why certain performances are done.

Recommended prior learning: No prior learning needed but, interest, passion and determination are desirable.

Demonstrate knowledge and skills of performance components

US22752 Internal 3 credits

Demonstrate knowledge of people associated with kapa haka

US22753 Internal 4 credits

Demonstrate knowledge of the origins of Māori performing arts disciplines and events

US22754 Internal 4 credits

Demonstrate knowledge of Māori performing arts kākahu

US22755 Internal 3 credits

Demonstrate knowledge of new Māori dance

US30428 Internal 4 credits

Demonstrate knowledge of new Māori music

US31191 Internal 4 credits

Demonstrate knowledge and skills of mōteatea

US13359 Internal 6 credits

Demonstrate knowledge and skills of waiata ā-ringā

US13363 Internal 6 credits

Demonstrate knowledge and skills of poi

US13367 Internal 10 credits

Demonstrate knowledge and skills of haka

US13371 Internal 6 credits

Demonstrate knowledge and skills of whakaraka

US15019 Internal 6 credits

Demonstrate new Māori dance

US22759 Internal 6 credits

Demonstrate knowledge and skills of haka wahine

US27698 Internal 6 credits

Create a Māori Performing Arts sequence for a given brief

US29564 Internal 6 credits

Demonstrate the essential skills of new Māori music

US31192 Internal 6 credits

Perform whakaraka

US15020 Internal 6 credits

Demonstrate knowledge of the development of new Māori music

US18715 Internal 6 credits

Perform a Māori performing arts bracket

US22756 Internal 10 credits

Demonstrate knowledge of influencing factors in the historical development of Māori performing arts

US22757 Internal 6 credits

Choreograph and present new Māori dance

US22761 Internal 15 credits

Perform new Māori music compositions

US31193 Internal 8 credits

MM9000**Manaaki Marae**

NCEA Levels 2 and 3

Manaaki Marae explores the events which happen at marae. It involves food preparation and cooking, preparation of the wharekai and understanding what good hosting involves. This subject can be marae based or there are possibilities to explore the kaupapa in this subject by talking with your kaiako.

Recommended prior learning: No prior learning needed but, interest, passion and determination are desirable.

Describe the roles and responsibilities of ringawera in a marae wharekai

US21232 SSe Internal 2 credits

Prepare, maintain and clear a buffet in a marae wharekai

US21248 SSe Internal 2 credits

Prepare and serve beverages in a marae wharekai

US21253 SSe Internal 2 credits

Describe manaaki in terms of the reciprocal interactions between the tangata whenua and manuhiri in a marae wharekai

US27509 SSe SSo Internal 4 credits

Identify traditional kai and describe the gathering process
US27510 SSe Internal 2 credits

Prepare fruit and vegetables to present for manuhiri
US29566 Se Internal 3 credits

Prepare equipment and cook kai in an oven to present for manuhiri
US29567 Se Internal 4 credits

Prepare equipment and fry kai to present for manuhiri
US29568 Se Internal 4 credits

Prepare equipment and cook kai with liquid to present for manuhiri
US29569 Se Internal 6 credits

Prepare and provide kai service, as part of a team and under supervision, for manuhiri
US31287 Internal 8 credits

Plan, prepare, and produce a hāngi as part of a team, in accordance with tikanga and kawa
US30540 Internal 5 credits

Prepare, cook, and present a range of dishes for manuhiri
US30541 Internal 15 credits

MW9000

Mātauranga Māori

NCEA Levels 2 and 3

Mātauranga Māori explores the concepts of understanding and working alongside mokopuna (early childhood education). It also involves discovering the foundational concepts of Aotearoa, the Declaration of Independence and the Treaty of Waitangi. This subject provides an avenue to explore alongside whānau, hāpori, hapū and iwi.

Recommended prior learning: No prior learning needed but, interest, passion and determination are desirable.

Describe Māori approaches to historical research
US16030 Internal 6 credits

Describe the history of He Whakaputanga o te Rangatiratanga/Declaration of the Independence of New Zealand
US16047 Internal 6 credits

Describe the development and introduction of te Tiriti o Waitangi/the Treaty of Waitangi
US16048 Internal 5 credits

Demonstrate knowledge of curriculum activities that assert whakamana in an early learning environment
US30339 Internal 6 credits

Demonstrate knowledge of kotahitanga in the holistic development of mokopuna in an early learning environment
US30340 Internal 6 credits

Demonstrate knowledge of rangatiratanga in an early learning environment
US30341 Internal 5 credits

Compare the English and Māori versions of te Tiriti o Waitangi/the Treaty of Waitangi
US16049 Internal 4 credits

Explain the historical impact of te Tiriti o Waitangi/the Treaty of Waitangi
US16050 Internal 8 credits

Demonstrate knowledge of Māori models of teaching and learning strategies in an early learning environment
US30342 Internal 8 credits

Develop, implement and evaluate curriculum activities to assert whakamana in an early learning environment
US30343 Internal 8 credits

Demonstrate knowledge of Māori learning in an early learning environment
US30344 Internal 8 credits

Demonstrate knowledge of self-management as an expression of rangatiratanga in an early learning environment
US30345 Internal 8 credits

Explore and compare Māori models of teaching and learning strategies relevant to an early learning environment
US30346 Internal 8 credits

RM9000

Reo Māori

NCEA Levels 1–3

Te Reo Māori through Kaupapa Māori is a pathway for learners who are looking to express themselves using everyday language constructs. This pathway enables ākonga to prepare for further learning at higher levels of the National Certificate of Educational Achievement. Māori is one of the official languages of New Zealand and is an integral part of the country's culture. There are numerous reasons to learn Māori including personal enjoyment or career requirements. Whatever the reason may be, learning Māori provides great satisfaction, a greater connection with New Zealand and an enhanced understanding of our culture and society.

Recommended prior learning: No prior learning needed but, interest, passion and determination are desirable.

Kōrero kia taumata tūāpapa te reo Māori

US30735 Internal 4 credits

Kōrero kia taumata tūāpapa te reo Māori mō te ao tūroa o te ākongā

US30736 Internal 4 credits

Kōrero kia taumata tūāpapa te reo Māori mō te tangata

US30737 Internal 4 credits

Kōrero kia taumata tūāpapa te reo Māori mō te mana whenua

US30738 Internal 4 credits

Pānui kia taumata tūāpapa te mōhiotanga ki ngā tuhinga reo Māori

US30739 Internal 4 credits

Pānui kia taumata tūāpapa te mōhiotanga ki ngā tuhinga reo Māori mō te ao tūroa

US30740 Internal 4 credits

Pānui kia taumata tūāpapa te mōhiotanga ki ngā tuhinga reo Māori mō te tangata

US30741 Internal 4 credits

Pānui kia taumata tūāpapa te mōhiotanga ki ngā tuhinga reo Māori mō te mana whenua

US30742 Internal 4 credits

Tuhituhi kia taumata tūāpapa ngā tuhinga reo Māori

US30743 Internal 4 credits

Tuhituhi kia taumata tūāpapa ngā tuhinga reo Māori mō te ao tūroa o te ākongā

US30744 Internal 4 credits

Tuhituhi kia taumata tūāpapa ngā tuhinga reo Māori mō te tangata

US30745 Internal 4 credits

Tuhituhi kia taumata tūāpapa ngā tuhinga reo Māori mō te mana whenua

US30746 Internal 4 credits

Whakarongo kia taumata tūāpapa te mōhiotanga ki te reo Māori

US30747 Internal 3 credits

Whakarongo kia taumata tūāpapa te mōhiotanga ki ngā kōrero mō te ao tūroa o te ākongā

US30748 Internal 3 credits

Whakarongo kia taumata tūāpapa te mōhiotanga ki ngā kōrero mō te tangata

US30749 Internal 3 credits

Whakarongo kia taumata tūāpapa te mōhiotanga ki ngā kōrero mō te mana whenua

US30750 Internal 3 credits

Kōrero kia taumata ā-tumu te reo Māori

US30751 Internal 4 credits

Kōrero kia taumata ā-tumu te reo Māori mō te ao tūroa o te ākongā

US30752 Internal 4 credits

Kōrero kia taumata ā-tumu te reo Māori mō te tangata

US30753 Internal 4 credits

Kōrero kia taumata ā-tumu te reo Māori mō te mana whenua

US30754 Internal 4 credits

Pānui kia taumata ā-tumu te mōhiotanga ki ngā tuhinga reo Māori

US30755 Internal 4 credits

Pānui kia taumata ā-tumu te mōhiotanga ki ngā tuhinga reo Māori mō te ao tūroa

US30756 Internal 4 credits

Pānui kia taumata ā-tumu te mōhiotanga ki ngā tuhinga reo Māori mō te tangata

US30757 Internal 4 credits

Pānui kia taumata ā-tumu te mōhiotanga ki ngā tuhinga reo Māori mō te mana whenua

US30758 Internal 4 credits

Tuhituhi kia taumata ā-tumu ngā tuhinga reo Māori

US30759 Internal 4 credits

Tuhituhi kia taumata ā-tumu ngā tuhinga reo Māori mō te ao tūroa o te ākongā

US30760 Internal 4 credits

Tuhituhi kia taumata ā-tumu ngā tuhinga reo Māori mō te tangata

US30761 Internal 4 credits

Tuhituhi kia taumata ā-tumu ngā tuhinga reo Māori mō te mana whenua

US30762 Internal 4 credits

Whakarongo kia taumata ā-tumu te mōhiotanga ki te reo Māori

US30763 Internal 3 credits

Whakarongo kia taumata ā-tumu te mōhiotanga ki ngā kōrero mō te ao tūroa o te ākongā

US30764 Internal 3 credits

Whakarongo kia taumata ā-tumu te mōhiotanga ki ngā kōrero mō te tangata

US30765 Internal 3 credits

Whakarongo kia taumata ā-tumu te mōhiotanga ki ngā kōrero mō te mana whenua

US30766 Internal 3 credits

Kōrero kia taumata o waenga te reo Māori

US31614 Internal 4 credits

Kōrero kia taumata o waenga te reo Māori mō te ao tūroa o te ākongā

US31615 Internal 4 credits

Kōrero kia taumata o waenga te reo Māori mō te tangata

US31616 Internal 4 credits

Kōrero kia taumata o waenga te reo Māori mō te mana whenua

US31617 Internal 4 credits

Pānui kia taumata o waenga te mōhiotanga ki ngā tuhinga reo Māori

US31622 Internal 4 credits

Pānui kia taumata o waenga te mōhiotanga ki ngā tuhinga reo Māori mō te ao tūroa

US31623 Internal 4 credits

Pānui kia taumata o waenga te mōhiotanga ki ngā tuhinga reo Māori mō te tangata

US31624 Internal 4 credits

Pānui kia taumata o waenga te mōhiotanga ki ngā tuhinga reo Māori mō te mana whenua

US31625 Internal 4 credits

Tuhituhi kia taumata o waenga ngā tuhinga reo Māori

US31630 Internal 4 credits

Tuhituhi kia taumata o waenga ngā tuhinga reo Māori mō te ao tūroa o te ākongā

US31631 Internal 4 credits

Tuhituhi kia taumata o waenga ngā tuhinga reo Māori mō te tangata

US31632 Internal 4 credits

Tuhituhi kia taumata o waenga ngā tuhinga reo Māori mō te mana whenua

US31633 Internal 4 credits

Whakarongo kia taumata o waenga te mōhiotanga ki te reo Māori

US31638 Internal 3 credits

Whakarongo kia taumata o waenga te mōhiotanga ki ngā kōrero mō te ao tūroa o te ākongā

US31639 Internal 3 credits

Whakarongo kia taumata o waenga te mōhiotanga ki ngā kōrero mō te tangata

US31640 Internal 3 credits

Whakarongo kia taumata o waenga te mōhiotanga ki ngā kōrero mō te mana whenua

US31641 Internal 3 credits

RR1000

Raranga

NCEA Levels 1 and 2

This course is offered in partnership with the Hetet School of Māori Art. You will learn skills, knowledge and understanding associated with traditional weaving and the art of tāniko as taught by Veranoa Hetet and her whānau. This course is taught in the same way that Veranoa would teach you if you were learning with her in person in her studio.

Recommended prior learning: No prior learning needed but interest, passion and determination are desirable. This course is not available to Adult enrolments.

Whakamahi whiri

US7879 Internal 2 credits

Create tīpare

US7881 Internal 3 credits

Harvest and prepare harakeke and raranga kono

US7906 Internal 4 credits

Harvest and prepare harakeke and raranga konae

US29531 Internal 4 credits

Demonstrate skills to identify and draft traditional and contemporary tāniko patterns

US31649 Internal 2 credits

Demonstrate knowledge of tāniko techniques

US31650 Internal 2 credits

Whatu taura tāniko

US7886 Internal 3 credits

Demonstrate skills to prepare decorative elements for a purpose

US7888 Internal 3 credits

Demonstrate skills to research and produce a project plan for a weaving stand

US31651 Internal 2 credits

TI9000**Te Iti a Taranga**

NCEA Level 3

Taranga was the mother of the famous ancestor Māui and his four brothers. They each possessed the intrinsic characteristics that prominently feature in the five standards offered in this course. The standards, and the learning that goes with them, are designed to link to activities and work ākongā may be involved in outside of school either at whānau, hapū, hāpori or iwi hui/kaupapa or events. This course recognises the inherent skills and knowledge that ākongā may already possess or have developed over time.

Recommended prior learning: No prior learning needed but, interest, passion and determination are desirable.

This course is accessed through our online learning environment My Te Kura.

Demonstrate knowledge and expressions of whanaungatanga

US32181 Internal 5 credits

Demonstrate knowledge and expressions of pūkengatanga

US32182 Internal 5 credits

Demonstrate knowledge and expressions of wairuatanga

US32183 Internal 5 credits

Demonstrate knowledge and expressions of rangatiratanga

US32184 Internal 5 credits

Demonstrate knowledge and expressions of manaakitanga

US32185 Internal 5 credits

TK9000**Tikanga**

NCEA Levels 1–3

Tikanga is all around us every day and influences how we behave in certain situations and how we interact with others. It is our connection to the past and the present. Tikanga is the thread/wairua that runs through all of Kaupapa Māori.

Recommended prior learning: No prior learning needed but, interest, passion and determination are desirable.

Describe the characteristics and actions of a selected atua in accordance with ngā kōrero tuku iho

US16160 Internal 3 credits

Describe a hui and the roles associated with hui in accordance with tikanga and/or kawa

US16165 Internal 2 credits

Describe and explain the separation of Ranginui and Papatūānuku in accordance with ngā kōrero tuku iho

US27105 Internal 2 credits

Describe the migration from Hawaiki in accordance with ngā kōrero tuku iho

US29316 Se Internal 2 credits

Utilise Māori modes to explain an event in Māori history

US16033 Internal 4 credits

Present an oral account of an event in Māori history

US16038 Internal 3 credits

Examine different accounts of Māori migration prior to Pākehā contact

US16043 Internal 6 credits

Describe historical events of one hapū or iwi

US16044 Internal 4 credits

Describe the relationship between Māori and Pākehā prior to 1840

US16046 Internal 5 credits

Describe the wars between Māori and Pākehā during the 1800s in accordance with ngā kōrero tuku iho

US16051 Internal 5 credits

Describe the life, achievements and impact of a Māori leader

US16054 Internal 3 credits

Describe the establishment and history of a hāhi Māori

US16058 Internal 4 credits

Describe the practices associated with a pōwhiri, in accordance with tikanga and/or kawa

US16142 Internal 2 credits

Describe the terms associated with whakapapa and use them within a family structure

US27106 Internal 2 credits

Describe the terms associated with whakapapa and use them within a family structure

US27108 Internal 2 credits

Describe and explain beliefs held by whānau, hapū, or iwi pertaining to kaitiaki

US27120 Internal 4 credits

Describe and explain the purpose of pūrākau in accordance with ngā kōrero tuku iho
US27126 Cr Internal 3 credits

Describe and explain the purpose of pakiwaitara in accordance with ngā kōrero tuku iho
US27127 Cr Internal 3 credits

Explain the impact of Christianity on te ao Māori in accordance with ngā kōrero tuku iho
US27128 So Internal 3 credits

Explain the use of karakia in accordance with tikanga
US27129 Internal 2 credits

Describe an initial landing and settlement of waka Māori in Aotearoa from Hawaii in accordance with ngā kōrero tuku iho
US29318 Se Internal 3 credits

Describe the deeds and roles of selected atua Māori in accordance with ngā kōrero tuku iho
US29319 Se Internal 3 credits

Explain the use of karakia relevant to a kaupapa
US31505 Internal 3 credits

Explain the use of waiata relevant to a kaupapa
US31506 Internal 3 credits

Participate in the recitation of a karakia at a hui
US31507 Internal 3 credits

Participate in the performance of a waiata tautoko in a hui
US31509 Internal 3 credits

Examine the use of Māori modes in transmitting Māori history
US16032 Internal 6 credits

Explain Māori and Pākehā perspectives of history
US16034 Internal 6 credits

Explain the place of pūrākau or pakiwaitara in Māori history
US16041 Internal 6 credits

Explain whakapapa in relation to Māori history
US16042 Internal 4 credits

Describe the dispossession of Māori land and its effects
US16052 Internal 6 credits

Describe key historical events for one hapū or iwi post-Pākehā contact
US16053 Internal 6 credits

Describe the history of spiritual beliefs and practices of Māori
US16057 Internal 6 credits

Demonstrate knowledge of the history of Māori in politics
US16059 Internal 8 credits

Explain kawa and tikanga in relation to hui mārena
US16136 Internal 6 credits

Describe a kīngitanga hui
US16139 Internal 6 credits

Describe the establishment and main characteristics of hāhi Māori
US16167 Internal 4 credits

Explain the creation of the world in accordance with ngā kōrero tuku iho and analyse its influence on tikanga
US27110 Internal 3 credits

Explain the deeds and roles of Māui and how these have influenced iwi
US27118 Internal 4 credits

Identify whakapapa and explain intermarriage in accordance with ngā kōrero tuku iho
US27123 Internal 4 credits

Identify and explain the concepts of whānau, hapū and iwi in accordance with tikanga
US27124 Internal 3 credits

Describe the impact of post-colonisation and its effects on te ao Māori, in accordance with ngā kōrero tuku iho
US27125 Internal 4 credits

Describe the impact of early colonisation and its effects on te ao Māori, in accordance with Māori history
US29317 Internal 4 credits

Explain how the deeds and roles of selected atua Māori have influenced iwi
US29320 Internal 4 credits

Participate in the pōwhiri process
US31508 Internal 2 credits

TM9000**Tourism Māori**

NCEA Level 3

Tourism Māori offers the possibility of discovering more about the natural and man-made attractions around you. It explores the concepts of whānau, tikanga, language, whakapapa and much more. In this subfield you have the opportunity to understand place names and the significance they hold for Māori. You can investigate how Māori identity is important for Tourism. As you learn about the rich experiences tourism creates, you will develop your understanding of tikanga and the world around you.

Recommended prior learning: No prior learning needed but, interest, passion and determination are desirable.

Discuss and compare cultural practices in tourism and the impact of tourism on Māori

US17385 Internal 5 credits

Demonstrate knowledge of key forms of Māori communication, and the significance of Māori identity in tourism Māori

US17391 Internal 5 credits

Explain the value and benefits of whānau in tourism Māori

US17578 Internal 4 credits

Explain kaitiaki practices in a tourism Māori context

US17791 Internal 5 credits

Explain the importance of Māori place names, and use reo Māori greetings and farewells in tourism

US31070 Internal 4 credits

Identify and explain the cultural significance of natural and man-made attractions in tourism Māori

US31071 Internal 6 credits

WH9000**Whenua**

NCEA Levels 1–3

Whenua examines the interconnectedness Māori have with Papatūānuku through the investigation of various species, rakau and the marama. In this subfield you can explore how the whenua is used to sustain life and consider how we could better sustain the whenua.

Recommended prior learning: No prior learning needed but, interest, passion and determination are desirable.

Demonstrate knowledge of a native marine fish and a native marine shellfish species and its significance to Māori

US19531 Pr Internal 2 credits

Demonstrate knowledge of a native freshwater fish and a shellfish species and its significance to Māori

US19535 Pr Internal 2 credits

Demonstrate knowledge of traditional insecticides and fungicides used by Māori

US15975 SPr Internal 2 credits

Demonstrate knowledge of te whānau marama

US15980 Cr Internal 2 credits

Demonstrate knowledge of tikanga Māori for rākau Māori used for kai

US15982 SSe Internal 2 credits

Explain harvesting and processing of a native freshwater and a native marine fish or shellfish species for kai

US15992 SPr SSe Internal 3 credits

Demonstrate knowledge of a native freshwater and a native marine plant species used for kai

US15994 SPr SSe Internal 3 credits

Describe crop propagation in accordance with local tikanga

US25469 SPr Internal 4 credits

Describe the cultivation of crops in accordance with local tikanga

US25471 SPr Internal 4 credits

Describe the harvesting of crops in accordance with local tikanga

US25474 SPr Internal 4 credits

Describe crop storage practices in accordance with local tikanga

US25476 Pr Internal 3 credits

Describe and compare the origins of the kūmara in accordance with ngā kōrero tuku iho

US25478 Pr Internal 5 credits

Legal Studies

Te Akoranga Taha Ture

Legal Studies covers a broad range of topics and aims to provide an understanding of the role of law in society and the basic processes and principles of the New Zealand legal system. Legal Studies explores and evaluates the ability of the legal system to provide just outcomes for all individuals and groups, giving ākongā a better understanding of their legal rights and responsibilities. Ākongā will develop an appreciation of how the legal system impacts on their lives and how they can influence and change it. This subject can lead to a range of possible careers including the legal profession, business, government service or agencies.

LG1000

Legal Studies

NCEA Level 1 (course endorsement not available however grades do contribute to certificate endorsement)

In this Legal Studies course, ākongā explore law as an integral aspect of society and find out how laws are made and applied in everyday life. Ākongā consider why laws are developed and the characteristics of an effective law.

Ākongā are able to demonstrate an understanding of the New Zealand court system, the law making process, and how New Zealanders vote for an MMP government. Other major areas of law covered include concepts of democracy and government such as rule of law, separation of powers and civil liberties, and different concepts of justice, such as coercive power and impartiality.

Recommended prior learning: Ākongā should have a reasonable level of literacy.

This course is accessed through our online learning environment, My Te Kura.

Describe basic employment rights and responsibilities, and sources of information and/or assistance

US1978 Internal 3 credits

Demonstrate knowledge of assessing legal assistance

US8548 So Internal 3 credits

Demonstrate understanding of concepts of democracy and government

US27835 Internal 4 credits

Demonstrate understanding of foundational concepts of justice

US27838 Internal 4 credits

Demonstrate understanding of concepts of law

US27841 Internal 4 credits

Demonstrate understanding of litigation and dispute resolution processes in New Zealand

US27844 Internal 4 credits

Demonstrate understanding of law making processes

US27847 Internal 4 credits

Demonstrate understanding of New Zealand's system of government and its formation and operation

US27850 Internal 4 credits

LG2000

Legal Studies

NCEA Level 2 (course endorsement not available however grades do contribute to certificate endorsement)

This Legal Studies course enables ākongā to develop an understanding of the role of law and its relationship to everyday life in New Zealand. Ākongā will explore concepts of law such as crime, negligence and contract. They study litigation and dispute resolution processes used in New Zealand, how laws are reformed and different voting systems such as MMP and FPP.

Other major areas of law covered include concepts of democracy and government such as rule of law, separation of powers and liberal democracy, and different concepts of justice, such as restorative justice and marae justice.

Recommended prior learning: Ākongā should have a good level of literacy.

This course is accessed through our online learning environment, My Te Kura.

Describe employment agreements

US1979 Internal 3 credits

Describe factors contributing to, and consequences of, crime

US8545 SSo Internal 3 credits

Describe the application of New Zealand law to personal relationships

US8551 So Internal 3 credits

Describe legal and non-legal consequences and protections relating to family violence and child abuse

US8552 SSo Internal 3 credits

Describe the objectives and evaluate the application of consumer law

US8555 Internal 3 credits

Describe the legal rights and personal responsibilities of secondary school students

US10337 Internal 3 credits

Explain concepts of democracy and government in a New Zealand context

US27836 Internal 4 credits

Explain concepts of justice

US27839 So Internal 4 credits

Explain concepts of law

US27842 Internal 4 credits

Explain litigation and dispute resolution processes

US27845 So Internal 4 credits

Explain a law making process

US27848 Internal 4 credits

Explain systems of government and their formation and operation in a New Zealand context

US27851 Internal 4 credits

LG3000

Legal Studies

NCEA Level 3 (course endorsement not available however grades do contribute to certificate endorsement)

Ākonga at this level will be able to evaluate concepts and principles, and systems and processes of the New Zealand and other legal systems. They will explore the application of a concept of law such as crime or natural justice to real situations. Ākonga study formal means of challenging state power, such as the Ombudsman used in New Zealand, and evaluate a law making process associated with a major issue such as film production in New Zealand.

Other major areas of law covered include concepts of democracy and government and different concepts of justice, evaluated in relation to specific situations such as significant events or particular legislation.

NCEA Level 3 Legal Studies is not on the NZQA approved subject list for University Entrance. However, the unit standards gained in LG3000 can count towards the other 18 credits required for NCEA Level 3, which is a requirement for University Entrance.

Recommended prior learning: Ākonga should have a very good level of literacy.

This course is accessed through our online learning environment, My Te Kura.

Evaluate a concept of democracy and government in relation to restraint on state power

US27837 Internal 4 credits

Evaluate a concept of justice in relation to a specific situation

US27840 Internal 4 credits

Evaluate a concept of law in relation to a specific situation

US27843 Internal 4 credits

Evaluate litigation and dispute resolution processes in relation to challenging state power

US27846 Internal 4 credits

Evaluate a law making process in relation to a significant legal issue

US27849 Internal 4 credits

Evaluate systems of government and their formation

US27852 Internal 4 credits

Evaluate key concepts of New Zealand's legal system from pre-European practices to current practices

US32360 Internal 4 credits

Life skills

Pūkenga Noho Ora

This Life Skills course provides opportunities to develop skills for everyday living and can lead into further study in Pathways education. The learning materials and experiences are ideal for ākonga in Years 9 and 10.

LS100**Life Skills**

Curriculum Levels 2–5

This course provides opportunities to develop skills for everyday living and can lead into further study in Pathways education. The focus is on developing knowledge and skills to assist with everyday living and includes preparation for employment; job interviews; goal setting; budgeting; shopping; time management; form filling; interpersonal and social skills, accessing information in maps and timetables. The learning materials and experiences are ideal for ākonga in Years 9–10.

Recommended prior learning: No prior learning needed.

This course can be accessed through My Te Kura, our online learning environment. A paper equivalent is also available.

Mathematics and Statistics

Te Mātauranga Pāngarau

Mathematics is more than just numbers. It is the exploration and use of patterns and relationships in quantities, space and time. Statistics focuses on patterns and relationships in data. Ākonga are equipped with powerful communication and problem solving tools for investigating, interpreting and making sense of the world. Using symbols, graphs and diagrams to investigate patterns and relationships, ākonga model real-life and hypothetical situations in a range of contexts: social, cultural, scientific, technological, health, environmental and economic. Mathematics and Statistics develops ākonga's ability to think creatively, critically, strategically and logically. Ākonga also learn to structure, organise, process and communicate information.

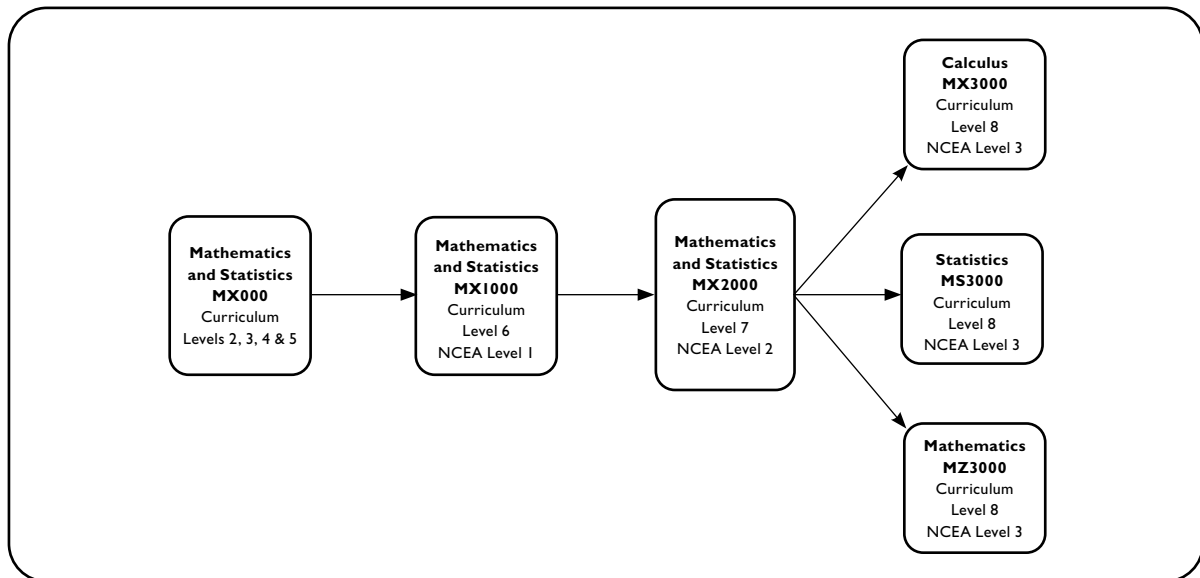

MX000

Mathematics and Statistics

Curriculum Levels 2–5

Individualised courses are designed to give ākonga a strong basis in the fundamentals of mathematics and statistics and to build confidence in the development and application of basic skills.

Each curriculum level develops the concepts of statistics, probability, geometry, measurement, number and algebra, which are applied to practical problems. In the lower curriculum levels, the focus is on core skills of numeracy, measurement, money, reading tables and graphs, using a calculator, basic arithmetic and shape patterns. After mastering these, ākonga progress towards an understanding of whole numbers, decimals, fractions, percentages and integers, and learn the skills needed to construct and interpret statistical graphs.

Other topics covered include: perimeter, area and volume, investigating mass, capacity, time and temperature, ratios, mean and range, exploring patterns, equations and locating position. Curriculum Level 5 is the foundation for NCEA Level 1.

Concepts are connected in new topics such as trigonometry. There is even greater emphasis on solving realistic problems using a variety of approaches and clearly and concisely communicating the thought processes.

Recommended prior learning: No prior learning needed.

This course is accessed through our online learning environment, My Te Kura.

MX1000

Mathematics and Statistics

NCEA Level 1 (course endorsement available)

This is a Level 1 course covering all areas of mathematics and statistics at Curriculum Level 6. Ākonga learn the skills needed for mathematical processes with a focus on algebra, angle geometry and trigonometry and probability. Teaching is also available in number, measurement, statistics, constructions and transformations. Ākonga can select from the achievement standards to a maximum total of 24 credits.

Recommended prior learning: Ākonga should have studied Mathematics at Curriculum Level 5 or equivalent. As an alternative pathway to the Achievement Standards, ākonga can study the Unit Standards. The three Unit Standards are Number, Statistics and Measurement. By completing these, ākonga will gain 10 Level 1 Mathematics credits to achieve the Numeracy requirements. Ākonga cannot, however, progress to Level 2 Mathematics by only gaining the Unit Standards at Level 1.

This course is accessed through our online learning environment, My Te Kura.

Use number to solve problems

US26623 (nu) UEnu Internal 4 credits

Interpret statistical information for a purpose

US26626 (nu) UEnu Internal 3 credits

Use measurement to solve problems

US26627 (nu) UEnu Internal 3 credits

Apply numeric reasoning in solving problems

AS91026 (na) UEna Co Ma Pr Se So Cr Internal 4 credits

Apply algebraic procedures in solving problems

AS91027 (na) UEna Co Ma Pr SSe So Cr External 4 credits

Investigate relationships between tables, equations and graphs

AS91028 (na) UEna Co Ma Pr Se Cr External 4 credits

Apply linear algebra in solving problems

AS91029 (na) UEna Co Ma Pr SSe So Cr Internal 3 credits

Apply measurement in solving problems

AS91030 (na) UEna Co Ma Pr Se So Cr Internal 3 credits

Apply geometric reasoning in solving problems

AS91031 (na) UEna Co Ma Pr SSe Cr External 4 credits

Apply right-angled triangles in solving measurement problems

AS91032 (na) UEna Co Ma Pr Se Cr Internal 3 credits

Apply knowledge of geometric representations in solving problems

AS91033 (na) UEna Co Ma Pr Cr Internal 3 credits

Apply transformation geometry in solving problems

AS91034 (na) UEna Co Ma Pr Se Cr Internal 2 credits

Investigate a given multivariate data set using the statistical enquiry cycle

AS91035 (Ina) UEna Co Ma Pr Se So Internal 4 credits

Investigate bivariate numerical data using the statistical enquiry cycle

AS91036 (Ina) UEna Pr Se So Cr Internal 3 credits

Demonstrate understanding of chance and data

AS91037 (na) UEna Pr Se So Cr External 4 credits

MX2000

Mathematics and Statistics

NCEA Level 2 (course endorsement available)

This course covers all major areas of mathematics and statistics at Curriculum Level 7. Ākonga learn skills needed for mathematical processes with a focus on algebra, geometry, measurement, probability and statistics. Ākonga can select from the achievement standards to a maximum total of 24 credits.

Recommended prior learning: A minimum of 12–14 NCEA Level 1 Mathematics and Statistics achievement standard credits or equivalent. NCEA Level 1 numeracy unit standards are not sufficient prior learning.

This course is accessed through our online learning environment, My Te Kura.

Apply co-ordinate geometry methods in solving problems

AS91256 (na) UEna Co Ma Se Cr Internal 2 credits

Apply graphical methods in solving problems

AS91257 (na) UEna Co Ma Pr Se Cr Internal 4 credits

Apply sequences and series in solving problems

AS91258 (na) UEna Co Ma Pr So Cr Internal 2 credits

Apply trigonometric relationships in solving problems

AS91259 (na) UEna Co Ma Cr Internal 3 credits

Apply network methods in solving problems

AS91260 (na) UEna Co Ma Pr Se So Cr Internal 2 credits

Apply algebraic methods in solving problems

AS91261 (na) UEna Co Ma Pr External 4 credits

Apply calculus methods in solving problems

AS91262 (na) UEna Co Ma Pr External 5 credits

Design a questionnaire

AS91263 (Ina) UEna Pr Se So Cr Internal 3 credits

Use statistical methods to make an inference

AS91264 (Ina) UEna Pr Se So Internal 4 credits

Evaluate a statistically based report

AS91266 (Ina) UElrna Co SMa Pr Se Cr Internal 2 credits

Apply probability methods in solving problems

AS91267 (Ina) UEna Pr Se So External 4 credits

Apply systems of equations in solving problems

AS91269 (na) UEna Co Ma Cr Internal 2 credits

MX3000

Calculus

NCEA Level 3 (course endorsement available)

This course is designed to prepare ākonga for the study of mathematics, pure and applied sciences or engineering at a tertiary level. The focus is on calculus, with ākonga encountering algebra and trigonometry topics, as well as the manipulation of real and complex numbers and geometry and conic sections. Ākonga can select from the achievement standards to a maximum total of 24 credits.

Recommended prior learning: A minimum of 12–14 NCEA Level 2 Mathematics and Statistics credits or equivalent.

This course is accessed through our online learning environment, My Te Kura.

Apply the geometry of conic sections in solving problems

AS91573 (na) UEna Co Ma Cr Internal 3 credits

Apply linear programming methods in solving problems

AS91574 (na) UEna Co Ma Pr Internal 3 credits

Apply trigonometric methods in solving problems

AS91575 (na) UEna Co Ma Internal 4 credits

Use critical path analysis in solving problems

AS91576 (na) UEna Co Pr So Internal 2 credits

Apply the algebra of complex numbers in solving problems

AS91577 (na) UEna External 5 credits

Apply differentiation methods in solving problems

AS91578 (na) UEna Co Ma Pr So External 6 credits

Apply integration methods in solving problems

AS91579 (na) UEna Co Ma Pr External 6 credits

Apply systems of simultaneous equations in solving problems

AS91587 (na) UEna Co Ma Pr Internal 3 credits

MS3000

Statistics

NCEA Level 3 (course endorsement available)

Ākonga interested in the analysis and interpretation of quantitative data will find this course useful. With a focus on statistics, this course explores probability, sampling and statistical inference as well as the analysis of time series and bivariate data. Part of this course is writing reports that justify the findings of an analysis.

This course is appropriate as a foundation in statistical exploration to support any area of study at tertiary level, especially the biological sciences, social sciences or commerce.

Access to statistical software, such as iNZight or NZgrapher for internal standards and a graphing or CAS calculator for external exams is essential. Ākonga can select from the following achievement standards to a maximum total of 24 credits.

Recommended prior learning: A minimum of 12–14 NCEA Level 2 Mathematics and Statistics credits or equivalent.

This course is accessed through our online learning environment, My Te Kura.

Investigate time series data

AS91580 (Ina) UEna Pr So Internal 4 credits

Investigate bivariate measurement data

AS91581 (Ina) UEna Pr Internal 4 credits

Use statistical methods to make a formal inference

AS91582 (Ina) UEna Pr Se So Cr Internal 4 credits

Conduct an experiment to investigate a situation using experimental design principles

AS91583 (Ina) UEna Pr Se So Internal 4 credits

Evaluate statistically based reports

AS91584 (Ina) UEnlwra Pr Se So External 4 credits

Apply probability concepts in solving problems

AS91585 (na) UEna Pr Se So External 4 credits

Apply probability distributions in solving problems

AS91586 (na) UEna Pr Se So External 4 credits

MZ3000**Mathematics**

NCEA Level 3 (course endorsement available)

This course takes a number of achievement standards from the Calculus and Statistics courses and creates a blended course. The focus of this course is on linear programming, networks, calculus and trigonometry, with ākongā also having an opportunity to develop statistical and probabilistic skills encountered in time series, statistical reports, bivariate analysis and statistical inference.

Ākongā can select from the following achievement standards to a maximum total of 24 credits.

Recommended prior learning: A minimum of 12–14 NCEA Level 2 Mathematics and Statistics credits or equivalent.

This course is accessed through our online learning environment, My Te Kura.

Apply linear programming methods in solving problems

AS91574 (na) UEna Co Ma Pr Internal 3 credits

Apply trigonometric methods in solving problems

AS91575 (na) UEna Co Ma Internal 4 credits

Use critical path analysis in solving problems

AS91576 (na) UEna Co Pr So Internal 2 credits

Apply differentiation methods in solving problems

AS91578 (na) UEna Co Ma Pr So External 6 credits

Investigate time series data

AS91580 (Ina) UEna Pr So Internal 4 credits

Investigate bivariate measurement data

AS91581 (Ina) UEna Pr Internal 4 credits

Use statistical methods to make a formal inference

AS91582 (Ina) UEna Pr Se So Cr Internal 4 credits

Evaluate statistically based reports

AS91584 (Ina) UEnlwa Pr Se So External 4 credits

Apply systems of simultaneous equations in solving problems

AS91587 (na) UEna Co Ma Pr Internal 3 credits

Media Studies

Te Akoranga Pāpāho

In Media Studies ākonga learn various journalism, close reading and analytical skills. Ākonga can create their own media product through studies in representation, genre, and narrative. Media Studies enables ākonga to be more media aware and savvy, which are vital skills in today's society.

MDI000

Media Studies

NCEA Level 1 (course endorsement available)

Level 1 Media Studies looks at many aspects of the media including: film, television, radio, print, social networks and the internet. Ākonga work closely with their kaiako to work out an appropriate programme based on their strengths, interests and literacy.

Recommended prior learning: Ākonga will need to have strong literacy and computer skills and have worked successfully in literacy rich subjects at NCEA Level 1.

This course is accessed through our online learning environment, My Te Kura.

Demonstrate understanding of how individuals interact with the media

AS90989 (1na) UEna Se Cr Internal 3 credits

Demonstrate understanding of selected elements of media text(s)

AS90990 (1a) Cr Internal 3 credits

Demonstrate understanding of characteristics of a media genre

AS90992 (1a) Se Cr External 4 credits

Produce a design and plan for a media product using a specified range of conventions

AS90993 Se Cr Internal 3 credits

Complete a media product from a design and plan using a specified range of conventions

AS90994 Cr Internal 6 credits

Write media texts for a specific target audience

AS90996 (1a) Se Cr Internal 3 credits

MD2000

Media Studies

NCEA Level 2 (course endorsement available)

Level 2 Media Studies looks at many aspects of the media including: film, print, social networks and the internet. Ākonga work closely with their kaiako to work out an appropriate programme based on their strengths, interests and literacy.

Recommended prior learning: Ākonga will need to have strong literacy and computer skills and have worked successfully in literacy rich subjects at NCEA Level 1.

This course is accessed through our online learning environment, My Te Kura.

Demonstrate understanding of narrative in media texts

AS91249 (1a) Cr Internal 4 credits

Demonstrate understanding of representation in the media

AS91250 (1a) Cr Internal 3 credits

Demonstrate understanding of an aspect of a media genre

AS91251 (1a) UElwa Cr External 4 credits

Produce a design and plan for a developed media product using a range of conventions

AS91252 (1a) Cr Internal 4 credits

Complete a developed media product from a design and plan using a range of conventions

AS91253 (1a) SCr Internal 6 credits

Write developed media text for a specific target audience

AS91255 (1a) UElwa SCr Internal 3 credits

MD3000**Media Studies**

NCEA Level 3 (course endorsement available)

Level 3 Media Studies looks at many aspects of the media including: film, television, print, social networks and the internet. Ākonga work closely with their kaiako to work out an appropriate programme based on their strengths, interests and literacy.

Recommended prior learning: Ākonga will need to have strong literacy and computer skills and have worked successfully in literacy rich subjects at NCEA Level 2.

This course is accessed through our online learning environment, My Te Kura.

Demonstrate understanding of the meaning of a media text through different readings

AS91491 (la) Cr Internal 3 credits

Demonstrate understanding of the media representation of an aspect of New Zealand culture or society

AS91492 (la) Cr Internal 3 credits

Demonstrate understanding of a relationship between a media genre and society

AS91493 (la) UElwra Cr External 4 credits

Produce a design for a media product that meets the requirements of a brief

AS91494 (la) Cr Internal 4 credits

Produce a media product to meet the requirements of a brief

AS91495 (la) Cr Internal 6 credits

Write a media text to meet the requirements of a brief

AS91497 (la) UElwa Se Cr Internal 3 credits

Music

Te Mātauranga Pūoru

Music is a fundamental form of personal and cultural expression. By making, sharing and responding to music, ākongā have opportunities to nurture their own creative potential as well as lay a foundation for lifelong enjoyment of and participation in music.

MC000

General Music

Curriculum Level 5

This course helps ākongā nurture their enjoyment and understanding of music. It offers opportunities in a wide range of different styles and types of music activities. Those ākongā intending to do music at NCEA levels can develop appropriate skills and knowledge through developing skills in instrumental performance, composition, song writing, basic piano and vocal techniques, elementary notation and the rudiments of music theory and an introduction to dance; as well as developing an understanding of the nature of sound and the elements and features of music, the use of notation and digital composition software, and the connection between the Arts.

Ākongā are strongly encouraged to have their own instrument (voice is an instrument) and have access to a music mentor and instrumental lessons within their own community.

Recommended prior learning: No prior learning needed.

This course is accessed through our online learning environment, My Te Kura.

performing arts or both.

This course is accessed through our online learning environment, My Te Kura.

Demonstrate and apply introductory knowledge of music technology equipment and techniques

US27656 Cr Internal 4 credits

Perform dance sequences

AS90002 Cr Internal 6 credits

Demonstrate ensemble skills in a dance

AS90859 Cr Internal 4 credits

Perform two pieces of music as a featured soloist

AS91090 Cr Internal 6 credits

Demonstrate ensemble skills through performing a piece of music as a member of a group

AS91091 Cr Internal 4 credits

Compose two original pieces of music

AS91092 Cr Internal 6 credits

Demonstrate aural and theoretical skills through transcription

AS91093 Cr External 4 credits

Demonstrate knowledge of conventions used in music scores

AS91094 (la) Cr External 4 credits

Demonstrate knowledge of two music works from contrasting contexts

AS91095 (la) Cr Internal 6 credits

MP1000

Music

NCEA Level 1 (course endorsement available)

This course builds skills in solo and group performance on an instrument or with voice. It also provides study of composition, music knowledge, aural perception, score reading and music technology (only in consultation with the senior kaiako).

All ākongā need their own instrument and access to a music mentor within their own community.

As a way of acknowledging ākongā's strengths in broader performing arts disciplines, some Level 1 dance standards are also offered within this course.

Recommended prior learning: Ākongā should have two or more years of music learning. To undertake the dance standards, ākongā should have two or more years experience in dance or Māori

MP2000

Music

NCEA Level 2 (course endorsement available)

This course continues to build skills in solo and group performance on an instrument or with voice. It also provides further study of composition, music knowledge, score reading and music technology (only in consultation with the senior kaiako).

All ākongā need their own instrument and access to a music mentor within their own community.

As a way of acknowledging ākonga's strengths in broader performing arts disciplines, some Level 2 dance standards are also offered within this course.

Recommended prior learning: Ākonga should have three or more years of music learning. To undertake the dance standards ākonga should have completed Level 1 dance standards and have three or more years experience in either dance or Māori performing arts or both.

This course is accessed through our online learning environment, My Te Kura.

Demonstrate knowledge of the development and usage of music technology techniques and associated equipment

US27657 SCr Internal 4 credits

Demonstrate and apply knowledge of electronic music production and music notation application(s)

US27658 SCr Internal 4 credits

Perform an ethnic or social dance to communicate understanding of the style

AS91207 SCr Internal 4 credits

Perform a repertoire of dance

AS91209 Cr Internal 6 credits

Perform two substantial pieces of music as a featured soloist

AS91270 Cr Internal 6 credits

Compose two substantial pieces of music

AS91271 Cr Internal 6 credits

Demonstrate ensemble skills by performing a substantial piece of music as a member of a group

AS91272 SCr Internal 4 credits

Devise an instrumentation for an ensemble

AS91273 Cr Internal 4 credits

Perform a substantial piece of music as a featured soloist on a second instrument

AS91274 Cr Internal 3 credits

Demonstrate knowledge of conventions in a range of music scores

AS91276 (1a) SCr External 4 credits

Investigate an aspect of New Zealand music

AS91278 (1a) Cr Internal 4 credits

MP3000

Music

NCEA Level 3 (course endorsement available)

This course focuses on extending practical music making including composition, arranging and music technology as well as providing topics to increase musical literacy and music research skills.

Ākonga need their own instrument and access to a music mentor within their own community.

New Zealand Scholarship exams are designed to extend very high achieving Level 3 ākonga. Those who wish to enter the New Zealand Scholarship exam in this subject must discuss this option with their Te Kura subject kaiako.

Recommended prior learning: Ākonga should have four or more years of music learning.

This course is accessed through our online learning environment, My Te Kura.

Operate music sequencing, editing, and music notation application(s)

US23730 Internal 8 credits

Perform two programmes of music as a featured soloist

AS91416 Cr Internal 8 credits

Perform a programme of music as a featured soloist on a second instrument

AS91417 Cr Internal 4 credits

Demonstrate ensemble skills by performing two substantial pieces of music as a member of a group

AS91418 Cr Internal 4 credits

Communicate musical intention by composing three original pieces of music

AS91419 Cr Internal 8 credits

Demonstrate understanding of harmonic and tonal conventions in a range of music scores

AS91421 Cr External 4 credits

Create two arrangements for an ensemble

AS91424 Cr Internal 4 credits

Research a music topic

AS91425 (1a) UEIra Cr Internal 6 credits

Perform a solo or duet dance

AS91590 Cr Internal 4 credits

Perform a group dance

AS91591 Cr Internal 4 credits

Perform a repertoire of contrasting dances

AS91592 Cr Internal 6 credits

Compose three original songs that express imaginative thinking

AS91849 Internal 8 credits

Pathways Education

Te Mātauranga Rapuara

Pathways Education provides learning opportunities to develop the foundation skills required to move successfully between school and work, be prepared for further education and move into paid employment or work in the voluntary sector.

PW1000

Skills for the workplace

NCEA Level I

Pathways Education helps ākongā develop the skills and knowledge for the workplace. Please note this course is easier for ākongā who have or have had a work placement. This can be voluntary work, a part-time job, work experience or a Gateway placement.

Recommended prior learning: Ākongā should have a reasonable level of literacy.

This course is accessed through our online learning environment, My Te Kura.

Perform calculations for a specified workplace

US64 Se Internal 2 credits

Produce, implement, and reflect on a plan to improve own personal wellbeing

US496 So Internal 3 credits

Demonstrate knowledge of workplace health and safety requirements

US497 SCo Ma Pr Internal 3 credits

Produce a CV (curriculum vitae)

US504 Internal 2 credits

Describe community agencies and services provided

US526 So Internal 2 credits

Recognise discrimination and describe ways of responding

US542 Internal 3 credits

Be interviewed in an informal, one-to-one, face-to-face interview

US1293 Internal 2 credits

Describe basic employment rights and responsibilities, and sources of information and/or assistance

US1978 Internal 3 credits

Fill in a form

US3483 Internal 2 credits

Complete an incident report

US3490 Internal 2 credits

Participate and communicate in a team or group to complete a routine task

US3503 Internal 2 credits

Describe obligations as an employee

US4249 SCo Internal 3 credits

Demonstrate knowledge of anger management

US12348 So Internal 2 credits

Perform income-related calculations for personal financial capability

US24697 Internal 2 credits

Interpret and confirm accuracy of financial documents for personal financial capability

US24705 Internal 2 credits

Produce a balanced budget to manage personal finances

US24709 So Internal 3 credits

Describe how employee behaviours and/or attitudes contribute to positive workplace relationships & performance

US30909 Internal 2 credits

PW2000**Customer Service****NCEA Level 2**

Pathways Education helps ākongā develop the skills and knowledge for the workplace. The course offers six modules.

Ākongā will begin in the first module **Getting Ready for Work (PW2001)** and then choose any three of the other modules.

Please note that ākongā may need a work placement for some standards. This can be voluntary work, a part-time job, work experience or a Gateway placement.

Recommended prior learning: Ākongā should have a reasonable level of literacy.

This course is accessed through our online learning environment, My Te Kura.

Provide customer service

US57 Pr SSe Internal 2 credits

Maintain personal presentation and a positive attitude in a workplace involving customer contact

US62 Pr SSe Internal 3 credits

Demonstrate and apply knowledge of office equipment and administration processes

US121 SSe Internal 4 credits

Demonstrate knowledge of diversity in workplaces

US377 Internal 2 credits

Be interviewed in a formal interview

US1294 Internal 2 credits

Be assertive in a range of specified situations

US1299 So Internal 4 credits

Identify support services and resources within the community

US1827 SSo Internal 2 credits

Describe employment agreements

US1979 Internal 3 credits

Demonstrate knowledge of traffic law for the purpose of safe driving

US3462 Internal 3 credits

Produce a personal targeted CV (curriculum vitae)

US4252 Internal 2 credits

Demonstrate knowledge of job search skills

US4253 Internal 3 credits

Develop strategies to enhance own learning

US7117 Internal 2 credits

Apply a problem-solving method

US7123 Internal 3 credits

Complete a work experience placement

US10780 Internal 3 credits

Produce a plan for own future directions

US10781 Internal 3 credits

Demonstrate knowledge of time management

US12349 SCo Internal 3 credits

Describe legal implications of living in rented accommodation and means to prevent and resolve related problems

US12354 Internal 4 credits

Explore career options and their implications

US12383 Internal 3 credits

Make an informed decision relating to personal income and explain its impacts

US24699 Internal 2 credits

Complete complex forms

US24871 Internal 2 credits

PCI000**Pregnancy and Wellbeing of Children**

NCEA Level 1

This course enables ākonga to gain knowledge about pregnancy and the wellbeing of children up to five years.

Ākonga will gain practical skills around filling in documentation and acquire knowledge about the help and support agencies in the community for whānau and young children.

There is one Level 2 standard that focuses on common childhood illnesses and how to manage children's health and wellbeing.

Ākonga interested in furthering their knowledge in the area of early childhood can pursue this pathway through the Gateway programme or PORSE Child Care course.

Recommended prior learning: No prior learning is required.

This course is accessed through our online learning environment, My Te Kura.

Produce, implement, and reflect on a plan to improve own personal wellbeing

US496 So Internal 3 credits

Describe community agencies and the services provided

US526 So Internal 2 credits

Fill in a form

US3483 Internal 2 credits

Demonstrate knowledge of health issues and services available to protect and enhance the wellbeing of young children

US29853 Internal 3 credits

Performing Arts

Ngāmahi āte Rēhia

Performing Arts explores challenges and celebrates practical expressions of self and culture. Ākonga have the opportunity to develop their practical performing arts skills, which can foster their creative and critical abilities as well as enjoyment of performance.

PA1000

Performing Arts

NCEA Levels 1–3

This programme offers opportunities in solo and group dance performance with the additional possibility of group music performance.

A range of Level 1, Level 2 and Level 3 standards is offered.

The assessment focus is on individual performance, captured with quality video recording within solo or group contexts.

Recommended prior learning: At least two years or more experience is required in one or more of dance, Māori performing arts or music for the Level 1 standards. It is recommended that ākonga have at least three years or more experience at Levels 2 and 3.

This course is accessed through our online learning environment, My Te Kura. It includes a mix of interactive online modules and downloadable resources in PDF format, so access to a computer and broadband internet is essential.

Level 1

Perform dance sequences

AS90002 Cr Internal 6 credits

Demonstrate ensemble skills in a dance

AS90859 Cr Internal 4 credits

Demonstrate ensemble skills through performing a piece of music as a member of a group

AS91091 Cr Internal 4 credits

Level 2

Perform an ethnic or social dance to communicate understanding of the style

AS91207 SCr Internal 4 credits

Perform a theatre dance to communicate understanding of the dance

AS91208 SCr Internal 4 credits

Perform a repertoire of dance

AS91209 Cr Internal 6 credits

Demonstrate ensemble skills by performing a substantial piece of music as a member of a group

AS91272 SCr Internal 4 credits

Level 3

Perform a solo or duet dance

AS91590 Cr Internal 4 credits

Perform a group dance

AS91591 Cr Internal 4 credits

Perform a repertoire of contrasting dances

AS91592 Cr Internal 6 credits

Physical Education

Mātauranga Hākinakina

In Physical Education ākonga consider factors affecting physical performance and work towards promoting physical activity in their communities. Ākonga can engage in a variety of physical activities as well as explore the body systems, training programmes and how to improve performances for themselves and others. Physical Education can be studied at tertiary level as a science or humanities subject. It leads to a wide variety of careers in tourism, sports science, community and health sectors.

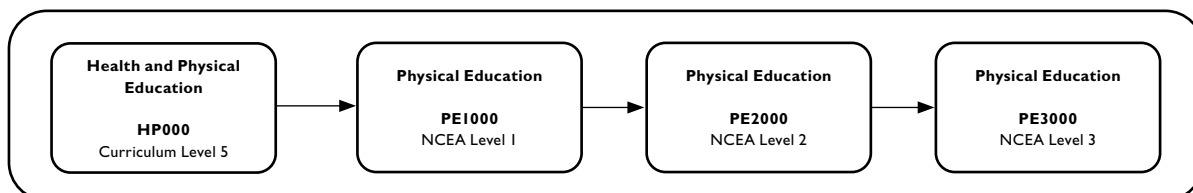

HP000

Health and Physical Education

Curriculum Level 5

In this course ākonga explore health issues (such as wellbeing, nutrition, communication, decision making and problem solving) and safety issues (such as drug use and understanding gender and sexuality). Ākonga also study physical education topics such as understanding the body, fitness testing, participating in a variety of activities and being involved in training programmes.

Recommended prior learning: No prior learning needed.

This course is accessed through our online learning environment, My Te Kura.

PE1000

Physical Education

NCEA Level I (course endorsement available)

This course follows on from Health and Physical Education (HP000). In Physical Education, ākonga study anatomy and physiology, practical performances and influences that affect participation in physical activity.

The Physical Education topics offer 19 credits towards NCEA Level I. There are 5 internal standards and no external standards. Physical Education topics offer 11 Literacy credits.

To gain course endorsement ākonga need to complete 14 credits in Physical Education.

Recommended prior learning: No prior learning needed.

This course is accessed through our online learning environment, My Te Kura.

Participate actively in a variety of physical activities and explain factors that influence own participation

AS90962 Se So Cr Internal 5 credits

Demonstrate understanding of the function of the body as it relates to the performance of physical activity

AS90963 (1a) Se So Cr Internal 5 credits

Demonstrate quality movement in the performance of a physical activity

AS90964 Se So Cr Internal 3 credits

Demonstrate strategies to improve the performance of a physical activity and describe the outcomes

AS90967 (1a) Se So Cr Internal 3 credits

Take action to enhance an aspect of personal well-being

AS90971 (1a) Pr Se So Cr Internal 3 credits

PE2000**Physical Education**

NCEA Level 2 (course endorsement available)

This course follows on from Physical Education – NCEA Level 1 (PE1000) and is useful and often essential for ākongā intending to continue with Level 3 Physical Education courses.

The Physical Education topics include biophysical principles, practical performances, influences of a training programme, and examining the impact of a sport on society.

The Physical Education topics offer 17 credits towards NCEA Level 2. There are 4 internal standards and no external standards. Physical Education topics also offer 13 Literacy credits.

To gain course endorsement ākongā need to complete 14 credits in Physical Education.

Recommended prior learning: NCEA Level 1 PE or equivalent.

This course is accessed through our online learning environment, My Te Kura.

Demonstrate understanding of how and why biophysical principles relate to the learning of physical skills

AS91328 (la) SSe So Cr Internal 5 credits

Demonstrate understanding of the application of biophysical principles to training for physical activity

AS91329 (la) SSe SCr Internal 4 credits

Perform a physical activity in an applied setting

AS91330 Se Cr Internal 4 credits

Examine the significance for self, others and society of a sporting event, a physical activity, or a festival

AS91331 (la) Se So Cr Internal 4 credits

PE3000**Physical Education**

NCEA Level 3 (course endorsement available)

This course follows on from Physical Education – NCEA Level 2 (PE2000) and is often essential for ākongā intending to continue with Physical Education courses at tertiary institutions.

Physical Education ākongā can study topics on analysing an activity, practical performances, evaluating a training programme, evaluating safety management and examining an issue or trend in society.

The Physical Education topics offer 18 credits towards NCEA Level 3. There are 5 internal standards worth 18 credits and no external standards. These Physical Education topics also offer 14 Literacy credits and 4 Numeracy credits.

To gain course endorsement or entry to a tertiary institution you will need to complete 14 credits in Physical Education.

Recommended prior learning: NCEA Level 2 Physical Education or equivalent.

This course is accessed through our online learning environment, My Te Kura.

Analyse a physical skill performed by self or others

AS91499 (la) Se So Cr Internal 3 credits

Evaluate the effectiveness of a performance improvement programme

AS91500 (lna) UElra Se Cr Internal 4 credits

Demonstrate quality performance of a physical activity in an applied setting

AS91501 (na) UEna Se Cr Internal 4 credits

Examine a current physical activity event, trend, or issue and its impact on New Zealand society

AS91502 (la) UElra Se So Internal 4 credits

Analyse issues in safety management for outdoor activity to devise safety management strategies

AS91504 (la) UElra Se So Internal 3 credits

Physics

Te Mātauranga Ahupūngao

Physics is the study of the matter and energy that makes up the physical world. It offers an insight into the fundamental ways the world works scientifically and its relationship with technology. This includes topics such as light, sound, heat, movement, forces, atomic physics as well as electricity and magnetism. Ākonga encounter many key scientific ideas and concepts that support study in other science subjects and related areas such as engineering and health science.

PH1000

Physics

NCEA Level 1 (course endorsement available)

This is an introductory course into the study of Physics, which features the main themes of heat, electricity and waves. Over the duration of the course, ākonga gain an understanding of the basic concepts in Physics.

This course offers three external standards and two internal standards. Ākonga who wish to study Physics at Level 2 must include at least one externally assessed standard from the list below or the Mechanics standard AS90940, which is offered in Science – NCEA Level 1 (SC1000).

Science – NCEA Level 1 (SC1000) also offers three standards, AS90941, AS90942 and AS90943. These standards will not lead to Level 2 Physics.

Recommended prior learning: Ākonga should have a reasonable level of literacy and numeracy.

This course is accessed through our online learning environment, My Te Kura.

Carry out a practical physics investigation that leads to a linear mathematical relationship, with direction

AS90935 (na) UEna Co Ma Pr So Cr Internal 4 credits

Demonstrate understanding of the physics of an application

AS90936 (la) Co Ma Pr So Cr Internal 2 credits

Demonstrate understanding of aspects of electricity and magnetism

AS90937 (na) UEna Co Ma Cr External 4 credits

Demonstrate understanding of aspects of wave behaviour

AS90938 (na) UEna Co Ma Cr External 4 credits

Demonstrate understanding of aspects of heat

AS90939 (na) UEna Co Ma Pr Cr External 4 credits

PH2000

Physics

NCEA Level 2 (course endorsement available)

This course is for ākonga interested in studying sciences, engineering, medicine, veterinary science and for those who are interested in careers as pilots, medical laboratory assistants and electricians.

The main themes of the course are mechanics, waves, electricity and atomic and nuclear physics. It is suitable for ākonga who have successfully studied some physics and mathematics at NCEA Level 1.

This course offers 26 credits of which 16 are externally assessed by NCEA examination.

Recommended prior learning: NCEA Level 1 Physics or equivalent.

This course is accessed through our online learning environment, My Te Kura.

Carry out a practical physics investigation that leads to a nonlinear mathematical relationship

AS91168 (lna) UEna Co Ma Pr Internal 4 credits

Demonstrate understanding of physics relevant to a selected context

AS91169 (la) Co Ma Pr So Cr Internal 3 credits

Demonstrate understanding of waves

AS91170 (lna) UEna Co Ma Pr So External 4 credits

Demonstrate understanding of mechanics

AS91171 (lna) UEna Co Ma Pr So External 6 credits

Demonstrate understanding of atomic and nuclear physics

AS91172 (la) Ma So Internal 3 credits

Demonstrate understanding of electricity and electromagnetism

AS91173 (lna) UEna Co Ma Pr External 6 credits

PH3000

Physics

NCEA Level 3 (course endorsement available)

This course is designed for ākonga interested in studying sciences, engineering, medicine or veterinary science at tertiary level and other physics-related technical studies at diploma level.

The main themes of the course are mechanics, waves, electricity and modern physics. It builds on the theory already covered in Level 2 Physics, so it is essential that ākonga who intend to study this course have successfully completed NCEA Level 2 Physics and have studied trigonometry, algebra and graphing in Level 2 mathematics.

This course offers 29 credits of which 16 are externally assessed by NCEA examination.

Recommended prior learning: NCEA Level 2 Physics or equivalent. Ākonga with limited prerequisites are advised to contact a physics kaiako to discuss their programme.

This course is accessed through our online learning environment, My Te Kura.

Carry out a practical investigation to test a physics theory relating two variables in a nonlinear relationship

AS91521 (1a) Co Ma So Internal 4 credits

Demonstrate understanding of the application of physics to a selected context

AS91522 (1a) Co Ma Pr So Internal 3 credits

Demonstrate understanding of wave systems

AS91523 (1a) Co Ma Pr So External 4 credits

Demonstrate understanding of mechanical systems

AS91524 (1a) Co Ma Pr So External 6 credits

Demonstrate understanding of Modern Physics

AS91525 (1a) Co Ma So Internal 3 credits

Demonstrate understanding of electrical systems

AS91526 (1a) Co Ma Pr So External 6 credits

Use physics knowledge to develop an informed response to a socio-scientific issue

AS91527 (1a) UEIra Co Ma Pr So Internal 3 credits

Primary Production (Agriculture/Horticulture)

Te Ahumahi Matua

Agriculture and horticulture are two main parts of New Zealand's primary industry sector. Primary industries form the backbone for many New Zealand communities and are the country's biggest export earner. Primary Production is about producing living things from the land and water. This includes producing and rearing large livestock, such as cattle, sheep, pigs and deer, or smaller animals such as poultry, bees and earthworms. Aquatic animals such as fish and shellfish are farmed in New Zealand fresh and salt waters. Plants are grown in large-scale forests, plantations, vineyards and fields or in smaller scale market gardens. Plants are also grown for pleasure in ornamental gardens, turf culture and in landscape design.

Knowing the principles of producing and selling these primary products using methods that care for our environment gives ākonga a huge range of career choices. Possibilities range from 'hands-on' production to science, business, marketing, law and finance-related roles. All Primary Production courses link well with subjects such as science, biology, geography and economics.

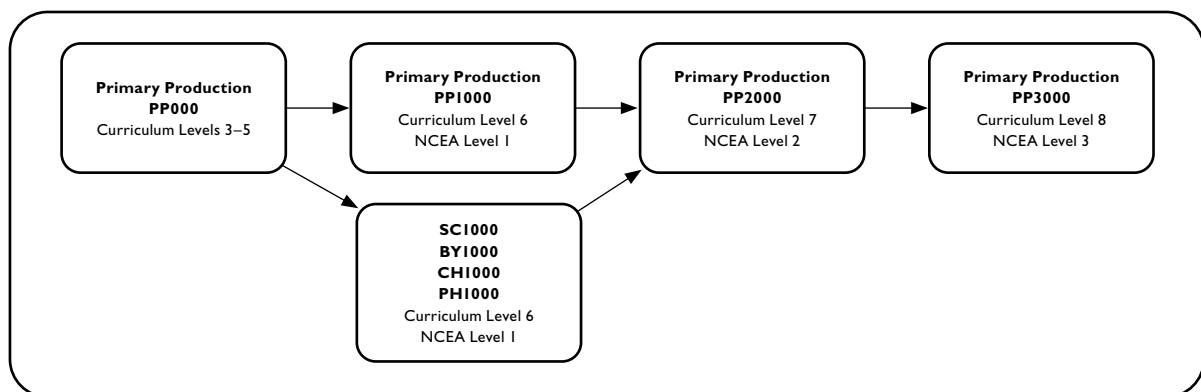

PP000

Introduction to Primary Production

Curriculum Levels 3–5

These Primary Production modules provide a basic introduction to agriculture and horticulture. There are agriculture modules about the farming of sheep, dairy cattle and pigs as well as forestry, bee keeping and aspects of farm safety. In the horticulture modules ākonga learn about the biological make-up of plants, what plants need to survive to produce high yields, the make-up of soil and soil communities, principles of garden design and care of the environment.

From the range of Primary Production modules offered, ākonga can select a programme to suit their interests. This could be a traditional agriculture or horticulture course, or a mixture of modules from both. This course provides a foundation for progression on to Level 1 standards in agricultural and horticultural science.

Recommended prior learning: No prior learning needed.

This course is accessed through our online learning environment, My Te Kura.

PP1000

Primary Production – Agricultural and Horticultural Science

NCEA Level 1 (course endorsement available)

As an introduction to Primary Production, this course covers the commercial production aspects of the agriculture and horticulture industries in New Zealand.

The agriculture standards look at the care and production of farm animals, pasture and crops. Ākonga develop the fundamental knowledge needed to manage livestock, pasture, farm equipment and soils.

The horticulture standards cover a variety of general horticultural topics including plant propagation and landscaping.

Ākonga can select only agriculture standards or horticulture standards or a combination of both that will fit their interests and needs. Within some standards, ākonga can choose between an agricultural or horticultural perspective. The overall focus is on the New Zealand primary production industries, what is involved in maximising production of producing primary products and the associated environmental issues.

Recommended prior learning: Ākonga should have a reasonable level of literacy.

This course is accessed through our online learning environment, My Te Kura.

Demonstrate knowledge of pasture/crop management practices

AS90155 (la) Pr Internal 4 credits

Demonstrate practical skills used in agricultural or horticultural production

AS90157 Pr Internal 4 credits

Demonstrate knowledge of the impact on the environment of primary production management practices

AS90160 (la) Pr Internal 3 credits

Carry out a practical agricultural or horticultural investigation

AS90918 (na) UEna Pr Internal 4 credits

Demonstrate knowledge of soil management practices

AS90919 (la) Pr External 4 credits

Demonstrate knowledge of the geographic distribution of agricultural and horticultural primary production in New Zealand

AS90920 (la) Pr Internal 3 credits

Demonstrate knowledge of livestock management practices

AS90921 (la) Pr External 5 credits

Design a landscape plan that reflects user requirements

AS90922 Pr Internal 3 credits

Demonstrate knowledge of basic plant propagation techniques

AS90923 (la) Pr Internal 4 credits

Demonstrate knowledge of horticultural plant management practices and related plant physiology

AS90924 (la) Pr External 5 credits

PP2000

Primary Production – Agricultural and Horticultural Science

NCEA Level 2 (course endorsement available)

This primary production course covers Level 2 agriculture and horticulture achievement standards.

Agriculture topics include livestock topics related to reproductive technologies, livestock behaviour and livestock growth and development.

Horticulture topics include plant propagation, plant management practices, landscaping and a practical investigation.

Ākonga can select only agriculture standards or horticulture standards or a combination of both that will fit their interests and needs.

During this course, ākonga learn how to describe and analyse the physical, environmental and biological factors that affect primary production. There are some standards where ākonga can choose between an agricultural or horticultural perspective.

Recommended prior learning: Ākonga should have a reasonable level of literacy.

This course is accessed through our online learning environment, My Te Kura.

Carry out an extended practical agricultural or horticultural investigation

AS91289 (na) UEIna SPr Internal 4 credits

Demonstrate understanding of techniques used to modify physical factors of the environment for NZ plant production

AS91290 (la) SPr External 4 credits

Demonstrate understanding of advanced plant propagation techniques used for commercial production in New Zealand

AS91291 (la) SPr Internal 4 credits

Demonstrate understanding of how management practices influence plant growth and development in NZ commercial production

AS91292 (la) SPr Internal 4 credits

Demonstrate understanding of livestock reproductive techniques in commercial production in New Zealand

AS91293 (la) SPr Internal 4 credits

Demonstrate understanding of how NZ commercial management practices influence livestock growth and development

AS91294 (la) SPr External 4 credits

Demonstrate understanding of interactions between livestock behaviour and NZ commercial management practices

AS91295 (la) SPr Internal 4 credits

Produce a landscape plan

AS91296 (la) Co SPr Internal 4 credits

Report on the environmental impact of the production of a locally produced primary product

AS91298 (la) SPr Internal 4 credits

PP3000

Primary Production – Agricultural and Horticultural Science

NCEA Level 3 (course endorsement available)

This combined agriculture and horticulture course will appeal to ākonga with an interest in commercial production of primary products and their marketing to maximise profits. Based on the production process, ākonga are given an insight into New Zealand's agricultural and horticultural exports, with a particular focus on lamb meat and apple crop production.

Other standards provide ākonga with the option of investigating other primary products of their choice and the environmental factors associated. The course links well with subjects such as science, biology, geography and economics.

Recommended prior learning: Ākonga should have a reasonable level of literacy and have studied achievement standards in agriculture or horticulture.

This course is accessed through our online learning environment, My Te Kura.

Carry out an investigation into an aspect of a New Zealand primary product or its production

AS91528 (Ina) UEna Pr Internal 4 credits

Research and report on the impact of factors on the profitability of a New Zealand primary product

AS91529 (Ina) UEnlma Pr Internal 6 credits

Demonstrate understanding of how market forces affect supply of and demand for New Zealand primary products

AS91530 (Ina) UEnlrwaPr External 5 credits

Demonstrate understanding of how the production process meets market requirements for a New Zealand primary product(s)

AS91531 (Ina) UEnlrwaPr External 4 credits

Analyse a New Zealand primary production environmental issue

AS91532 (Ina) UEnlrwaPr External 5 credits

Samoa

Te Reo Hāmoa

Samoa Language (Gagana Samoa) is spoken by nearly half a million people worldwide, including 85 thousand people in New Zealand, making it the third most widely spoken language in New Zealand (after English and te reo Māori). Whether ākongā are learning Samoan to strengthen their identity as Samoan, to communicate with family members, for career enhancement or another reason, this subject will provide them with an opportunity to build on prior learning and to develop problem-solving, risk-taking and communication skills.

SA1000

Samoa

NCEA Level 1 (course endorsement available)

This Samoan course helps ākongā develop their reading, writing, listening and speaking skills through a range of topics such as family, home life and, celebrations. The course is structured to allow flexibility in terms of the order in which topics are studied and also includes an open-ended topic that enables ākongā to investigate an area of their own interest.

Recommended prior learning: Ākongā must have completed Year 10 Samoan or equivalent or have a Samoan language background.

This course is accessed through our online learning environment, My Te Kura. Ākongā will be required to make and submit audio and/or video recordings, so a microphone and camera or mobile device are essential.

Demonstrate understanding of a variety of spoken Samoan texts on areas of most immediate relevance

AS90903 Pr Se So SCr External 5 credits

Give a spoken presentation in Samoan that communicates a personal response

AS90904 Pr Internal 4 credits

Interact using spoken Samoan to communicate personal information, ideas and opinions in different situations

AS90905 Se So Cr Internal 5 credits

Demonstrate understanding of a variety of Samoan texts on areas of most immediate relevance

AS90906 Se External 5 credits

Write a variety of text types in Samoan on areas of most immediate relevance

AS90907 Se SCr Internal 5 credits

SA2000

Samoa

NCEA Level 2 (course endorsement available)

This course further extends the ability to read, write, speak and listen in Samoan. A range of topics are explored through the eyes of two Samoan families, one living in New Zealand and the other in Samoa.

Recommended prior learning: NCEA Level 1 Samoan course or equivalent.

This course is accessed through our online learning environment, My Te Kura. Ākongā will be required to make and submit audio and/or video recordings, so a microphone and camera or mobile device are essential.

Demonstrate understanding of a variety of spoken Samoan texts on familiar matters

AS91143 External 5 credits

Interact using spoken Samoan to share information and justify ideas and opinions in different situations

AS91144 Internal 5 credits

Give a spoken presentation in Samoan that communicates information, ideas and opinions

AS91145 Internal 4 credits

Demonstrate understanding of a variety of written and/or visual Samoan text(s) on familiar matters

AS91146 External 5 credits

Write a variety of text types in Samoan to convey information, ideas, and opinions in genuine contexts

AS91147 Internal 5 credits

SA3000**Samoan**

NCEA Level 3 (course endorsement available)

Samoan Language (Gagana Samoa) is spoken by nearly half a million people worldwide, including 85 thousand people in New Zealand, making it the third most widely spoken language in New Zealand (after English and te reo Māori). Whether ākonga are learning Samoan to strengthen their identity as Samoan, to communicate with family members, for career enhancement, or another reason, this subject will provide them with an opportunity to build on prior learning and to develop problem-solving, risk-taking and communication skills.

Recommended prior learning: NCEA Level 2 Samoan course or equivalent.

This course is accessed through our online learning environment, My Te Kura. Ākonga will be required to make and submit audio and/or video recordings, so a microphone and camera or mobile device are essential.

Demonstrate understanding of a variety of extended spoken Samoan texts

AS91563 External 5 credits

Give a clear spoken presentation in Samoan that communicates a critical response to stimulus material

AS91564 Internal 3 credits

Interact clearly using spoken Samoan to explore and justify varied ideas and perspectives in different situations

AS91565 Internal 6 credits

Demonstrate understanding of a variety of extended written and/or visual Samoan texts

AS91566 External 5 credits

Write a variety of text types in clear Samoan to explore and justify varied ideas and perspectives

AS91567 Internal 5 credits

Science

Te Mātauranga Pūtaiao

Science is a discipline that provides ākonga with a range of skills and ways of thinking that are valuable in many aspects of life and work. Have you thought about why you need to eat, why cars rust, how batteries produce electrical energy or why clouds produce rain? Science helps ākonga discover answers to such questions. Ākonga explore not just the world of living things, but all types of substances and how they react while gaining an understanding of concepts such as force and energy that affect the Earth and space. Many issues that confront us today, such as environmental concerns, energy use, manufacturer product claims, growing our own food, maintaining good health and raising children, have scientific aspects. Many choices we make in life have a scientific perspective. This subject is not just learning about science, but understanding how to make sense of scientific information we are bombarded with on a daily basis.

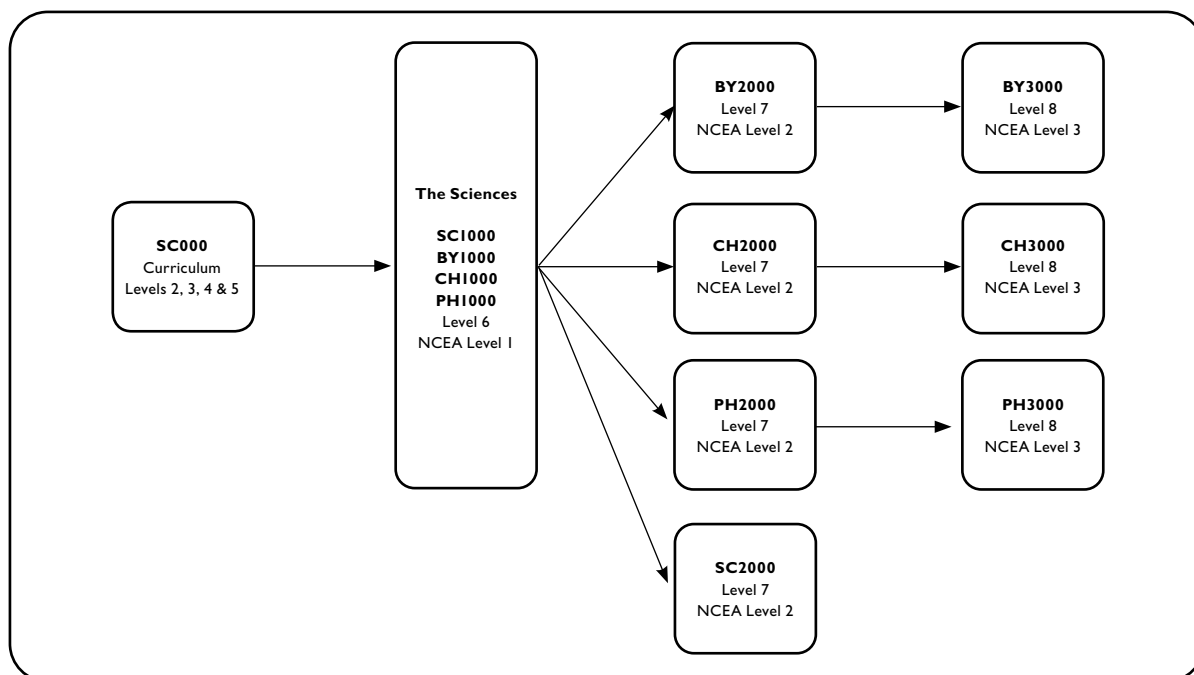

SC000

Introducing Science

Curriculum Levels 2–5

This course is aimed at ākonga in Year 9 and above who are studying at Curriculum Levels 2–5. It offers a flexible programme with a wide variety of topics that help ākonga build skills and understanding. By studying the living world, the material world (chemistry), the physical world, Earth and beyond, ākonga learn about the nature of science, what science is and how scientists work. Some of the current topics are space, electrical circuits, forces, acids and bases and how the body works.

The course includes hands-on experimental work, online activities and research investigations. Ākonga can progress through this course, year by year, up to Curriculum Level 5. When they have studied a range of topics at Curriculum Level 5, they will be well-prepared for NCEA study of the sciences.

Recommended prior learning: No prior learning needed.

This course is accessed through our online learning environment, My Te Kura.

SCI000**Science**

NCEA Level 1 (course endorsement available)

This course offers a broad selection of standards in Science at Level 1. In one year, ākongā normally study for around five standards offering 18–20 credits from a choice of 16 possible achievement standards.

The wide range of standards allows ākongā to study different aspects of science. Ākongā's selection of science topics and standards are based on their interests and goals. For example, ākongā with an interest in medical science can choose standards in genetics, microbes, acids and bases, life processes and the implications of burning carbon-based fuels.

Advice is available from Te Kura science kaiakos. Kaiakos help to select the right standards to ensure ākongā study an appropriate range of standards that involve the physical world, the material world, the living world, Earth and beyond.

Ākongā are encouraged to contact their kaiako soon after enrolment to discuss topic choices and whether they prefer to complete work that is only internally assessed or assessed by both internal and external assessment.

Ākongā committed to a science-related career should consider choosing an additional NCEA Level 1 specialist science course. The course includes hands-on experimental work, computer-based activities and research investigations. It provides a good preparation for study of the sciences at Level 2.

Enrolling in more than one science course: SCI000 provides ākongā with a broad introduction to the sciences which then leads to a greater choice of subjects at level 2. If ākongā want to have a career in the sciences/engineering/medicine then they can be enrolled in the specialised level 1 courses (BY1000, CH1000 and/or PH1000) where they will be assigned to specialist kaiakos.

Recommended prior learning: Ākongā should have a reasonable level of literacy and numeracy.

This course is accessed through our online learning environment, My Te Kura.

Carry out a practical investigation in a biological context, with direction

AS90925 Ma Pr SSe So Internal 4 credits

Carry out a practical chemistry investigation, with direction

AS90930 Co Ma Pr SSe Internal 4 credits

Demonstrate understanding of the chemistry in a technological application

AS90931 Co Ma Pr SSe Cr Internal 2 credits

Demonstrate understanding of aspects of mechanics

AS90940 (na) UEna Co Ma Pr Se So Cr External 4 credits

Investigate implications of electricity and magnetism for everyday life

AS90941 (na) UEna SCo Ma Pr Cr Internal 4 credits

Investigate implications of wave behaviour for everyday life

AS90942 (na) UEna SCo Ma Pr Cr Internal 4 credits

Investigate implications of heat for everyday life

AS90943 (na) UEna Co Ma Pr So Cr Internal 4 credits

Demonstrate understanding of aspects of acids and bases

AS90944 Co Ma Pr Cr External 4 credits

Investigate implications of the use of carbon compounds as fuels

AS90945 Co Ma Pr SSe So Internal 4 credits

Investigate the implications of the properties of metals for their use in society

AS90946 Co Ma Pr Cr Internal 4 credits

Investigate selected chemical reactions

AS90947 Co Ma Pr So Cr Internal 4 credits

Demonstrate understanding of biological ideas relating to genetic variation

AS90948 (la) SMa Pr So External 4 credits

Investigate life processes and environmental factors that affect them

AS90949 Pr Se So Cr Internal 4 credits

Investigate biological ideas relating to interactions between humans and micro-organisms

AS90950 Co Ma Pr Se So Cr Internal 4 credits

Investigate the biological impact of an event on a New Zealand ecosystem

AS90951 Pr Se Cr Internal 4 credits

Demonstrate understanding of the formation of surface features in New Zealand

AS90952 (la) Internal 4 credits

Demonstrate understanding of carbon cycling

AS90953 (la) Internal 4 credits

Demonstrate an understanding of the effects of astronomical cycles on planet Earth

AS90954 (la) Internal 4 credits

Investigate an astronomical or Earth science event

AS90955 (la) Pr So Internal 4 credits

SC2000

Science

NCEA Level 2 and some Level 3
(course endorsement available)

This course is available to ākonga who want a general science course at Level 2 that can be done along with Social Sciences, Arts, English, Health and PE or Technology.

There are three new Earth and Space Science standards available at Level 2 and also three at Level 3.

Science offers valuable skills and ways of thinking that help ākonga become informed about the world and are beneficial to those who are considering careers in a range of different industries.

Recommended prior learning: Recommended prior learning is Level 1 in a Science subject. This course should not be done with BY2000, CH2000 or PH2000 due to the overlap of standards.

This course is accessed through our online learning environment, My Te Kura.

Carry out a practical investigation in a biology context, with supervision

AS91153 (na) UEna Ma Pr SSe So Internal 4 credits

Analyse the biological validity of information presented to the public

AS91154 (la) Pr So Internal 3 credits

Demonstrate understanding of adaptation of plants or animals to their way of life

AS91155 (la) Pr SSe SSo Internal 3 credits

Investigate a pattern in an ecological community, with supervision

AS91158 (la) Pr Internal 4 credits

Demonstrate understanding of the chemistry used in the development of a current technology

AS91163 (la) Co Ma Pr SSe So Cr Internal 3 credits

Demonstrate understanding of oxidation-reduction

AS91167 Co Ma Pr So Internal 3 credits

Carry out a practical physics investigation that leads to a nonlinear mathematical relationship

AS91168 (lna) UEna Co Ma Pr Internal 4 credits

Demonstrate understanding of physics relevant to a selected context

AS91169 (la) Co Ma Pr So Cr Internal 3 credits

Demonstrate understanding of atomic and nuclear physics

AS91172 (la) Ma So Internal 3 credits

Carry out a practical Earth and Space Science Investigation

AS91187 la Internal 4 credits

Examine an Earth and Space Science Issue and the validity of the information communicated to the public

AS91188 la Internal 4 credits

Investigate how organisms survive in an extreme environment

AS91190 la Internal 4 credits

Investigate a socio-scientific issue in an Earth and Space Science context

AS91411 (la) UElwr Internal 4 credits

Investigate the evidence related to dating geological event(s)

AS91412 (la) Internal 4 credits

Investigate an aspect of astronomy

AS91415 (la) UElr Internal 4 credits

Investigate geological processes in a New Zealand locality

AS91189 la Internal 4 credits

Social Studies

Te Akoranga Tikanga ā-iwi

In Social Studies, ākonga learn about people, places, cultures, histories and the economic world within and beyond New Zealand. Social Studies helps ākonga understand people by exploring different points of view and beliefs. Ākonga are given opportunities to develop communication, critical thinking and decision-making skills. These attributes help ākonga become responsible and informed individuals with the ability to analyse the world that surrounds them. The course for each ākonga is developed in consultation with the kaiako to meet their particular needs and interests.

SS000

Social Studies

Curriculum Levels 3–5

In this course, ākonga investigate issues in society and the interactions between cultures both within New Zealand and globally. Topics have a past, present and future focus.

The course is based around five overarching themes: connections, accessibility, organisation, survival and movement. Within these themes, ākonga study topics such as sustainability, human rights, cultural diversity and enterprise. Ākonga investigate how change affects New Zealand cultures, societies and communities, which helps them understand the past and the present and to imagine possible futures.

Ākonga are given starting modules but are encouraged to choose modules by personal interest, passions, and links to other subject concepts and themes.

Recommended prior learning: No prior learning needed.

This course is accessed through our online learning environment, My Te Kura.

Spanish

Te Reo Pāniora

Spanish is the third most widely spoken language and is used by over 500 million people in Spain and both North and South America. By studying Spanish, ākongā gain insight into a rich history and a variety of cultures and societies that have spanned the globe. Many New Zealanders are choosing to learn Spanish for its importance as both a commercial and cultural language.

PYSP

Primary Spanish

Curriculum Levels 1 & 2

This is a Year 7 course that is only available online. It is a taster course that introduces basic communication in Spanish. In the course, ākongā learn how to greet people, ask where someone is from, talk about family, ask about and give the time as well as talk about other everyday topics.

This course is only available to full-time Year 7 and 8 ākongā and fee-paying ākongā. Ākongā registered in this course are required to work online on My Te Kura.

Recommended prior learning: No prior learning needed.

This course is accessed through our online learning environment, My Te Kura.

SP000

Beginners' Spanish

Curriculum Levels 1–5

This is a course for beginners (Curriculum Levels 1–5). Ākongā are introduced to basic listening, speaking, reading and writing skills using everyday Spanish. They learn how to greet people and communicate basic information about themselves and others including looks, hobbies, birthdays, family and their home.

They also learn to communicate about food, shopping and countries. Ākongā also investigate Hispanic culture, giving them a broad understanding of the different countries where Spanish is spoken and their customs. Communication activities are emphasised throughout.

Recommended prior learning: No prior learning needed.

This course is accessed through our online learning environment, My Te Kura. Ākongā will be required to make and submit audio and/or video recordings, so a microphone and camera or mobile device are essential.

SPI000

Spanish

NCEA Level 1 (course endorsement available)

This course develops the four main language skills: listening, speaking, reading and writing. Ākongā hear and learn the Spanish language as it is spoken in both Spain and Latin America.

Throughout the course, the style remains conversational and learning is set to a backdrop of realistic and everyday situations. From introducing oneself to describing family and friends, this course provides ākongā with the ability to socially converse in basic Spanish.

Other topics covered include holidays and travel, school life and sports and leisure activities.

Recommended prior learning: Previous basic knowledge of Spanish is an advantage but not necessary.

This course is accessed through our online learning environment, My Te Kura. Ākongā will be required to make and submit audio and/or video recordings, so a microphone and camera or mobile device are essential.

Demonstrate understanding of a variety of spoken Spanish texts on areas of most immediate relevance

AS90908 Pr Se So SCr External 5 credits

Give a spoken presentation in Spanish that communicates a personal response

AS90909 Pr Internal 4 credits

Demonstrate understanding of a variety of Spanish texts on areas of most immediate relevance

AS90911 Se External 5 credits

Write a variety of text types in Spanish on areas of most immediate relevance

AS90912 Se SCr Internal 5 credits

SP2000**Spanish**

NCEA Level 2 (course endorsement available)

Over this course ākonga learn how to use Spanish vocabulary, structures and functions to communicate a wide range of language for varying situations. Ākonga further their basic Spanish skills and are able to talk about a wide range of events, express their opinions and make comparisons and contrasts. In turn, they gain the necessary ability to give instructions and make suggestions and expand their knowledge on how to use and distinguish between past, present and future tenses.

Recommended prior learning: NCEA Level 1 Spanish or equivalent.

This course is accessed through our online learning environment, My Te Kura. Ākonga will be required to make and submit audio and/or video recordings, so a microphone and camera or mobile device are essential.

Demonstrate understanding of a variety of spoken Spanish texts on familiar matters

AS91148 Se External 5 credits

Interact using spoken Spanish to share information and justify ideas and opinions in different situations

AS91149 SSe So Cr Internal 5 credits

Give a spoken presentation in Spanish that communicates information, ideas and opinions

AS91150 Internal 4 credits

Demonstrate understanding of a variety of written and/or visual Spanish text(s) on familiar matters

AS91151 SSe External 5 credits

Write a variety of text types in Spanish to convey information, ideas, and opinions in genuine contexts

AS91152 Internal 5 credits

SP3000**Spanish**

NCEA Level 3 (course endorsement available)

Having an understanding of the cultures that surround a language is integral to communicating in that language. This course focuses on authentic Spanish for conversation in a variety of situations in both Latin America and Spain.

There will be many opportunities to speak Spanish throughout, and language skills are also furthered through exercises in listening for understanding, interest and enjoyment. Reading and writing work also helps ākonga develop an appreciation for both the Spanish language and the culture.

New Zealand Scholarship exams are designed to extend very high-achieving Level 3 ākonga. Those who wish to enter the New Zealand Scholarship exam in this subject must discuss this option with their Te Kura subject kaiako.

Recommended prior learning: NCEA Level 2 Spanish or equivalent.

This course is accessed through our online learning environment, My Te Kura. Ākonga will be required to make and submit audio and/or video recordings, so a microphone and camera or mobile device are essential.

Demonstrate understanding of a variety of extended spoken Spanish texts

AS91568 Se External 5 credits

Give a clear spoken presentation in Spanish that communicates a critical response to stimulus material

AS91569 Internal 3 credits

Interact clearly using spoken Spanish to explore and justify varied ideas and perspectives in different situations

AS91570 Se So Cr Internal 6 credits

Demonstrate understanding of a variety of extended written and/or visual Spanish texts

AS91571 External 5 credits

Write a variety of text types in clear Spanish to explore and justify varied ideas and perspectives

AS91572 Se Internal 5 credits

Technology

Te Mātauranga Hangarau

Ākonga who enjoy designing and making things should enrol in this subject. Technology ākonga can choose to work in food technology, hard materials or fashion/textiles technology. Ākonga use the design process and develop their technological skills in areas that interest them. Technology encourages ākonga to think creatively and design practical solutions to problems they have identified. Ākonga are expected to work with people and with resources in their community so that their projects are meaningful and authentic.

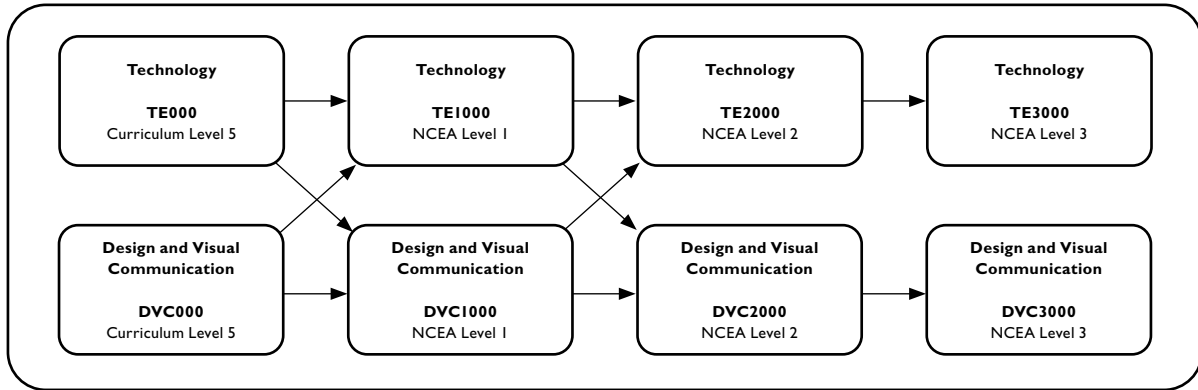

TE000

Technology

Curriculum Level 5

This course offers ākonga a variety of exciting learning opportunities to explore, design and create solutions to authentic practical problems. Ākonga develop their technological practice by a pick and mix of topics from any technological area. They can also specialise in one if they wish.

Topics are based on ākonga interests and help them develop practical technological skills in design and construction. In some topics, wider issues such as sustainability and the impact of technology on the environment and society are introduced.

Ākonga are guided to understand the designer/stakeholder relationship, to identify issues, gather research and think in a visual way as they plan and make in a range of materials.

Recommended prior learning: No prior learning needed.

This course is accessed through our online learning environment, My Te Kura.

TE1000

Technology

NCEA Level 1 (course endorsement available)

This course is for ākonga who like designing and creating practical solutions in real life situations. Technology ākonga work with stakeholders in a setting that interests them.

Technology offers topics in food technology, hard materials and soft materials (fashion/textiles) and ākonga can choose from a number of different topics or they can specialise in one. Worksheets are used to guide ākonga to develop their design, investigation, planning and construction skills.

Ākonga are also encouraged to think creatively and communicate visually as they develop their technological practice and apply their technological knowledge. Individual projects can be developed on request.

Recommended prior learning: No prior learning needed.

This course is accessed through our online learning environment, My Te Kura.

Undertake brief development to address a need or opportunity

AS91044 (1a) Co Ma Pr Cr Internal 4 credits

Use design ideas to produce a conceptual design for an outcome to address a brief

AS91046 Co Ma Pr Cr Internal 6 credits

Undertake development to make a prototype to address a brief

AS91047 Co Ma Pr Cr Internal 6 credits

Demonstrate understanding of how technological modelling supports decision-making

AS91048 (la) Co Ma Pr Cr External 4 credits

Implement basic procedures using resistant materials to make a specified product

AS91057 Co Ma Pr Internal 6 credits

Implement basic procedures using textile materials to make a specified product

AS91058 Co Ma SCr Internal 6 credits

Implement basic procedures to process a specified product

AS91082 Ma Pr Internal 4 credits

Make basic adaptations to a pattern to enable a design to fit a person or item

AS91096 Ma SCr Internal 4 credits

TE2000

Technology

NCEA Level 2 (course endorsement available)

This course is for ākonga who enjoy innovating and creating practical things. Ākonga chose an area that interests them (food technology, hard materials or fashion and textiles) and work with people to identify real-life opportunities to design, develop and construct technological solutions.

Ākonga work creatively to combine function and aesthetics, and consider a technologist's responsibility to the wider community. Ākonga follow a case study that models the design process and the designer/stakeholder relationship and provides practical teaching and guidance. Ākonga use this case study to develop their understanding of design, visual thinking, investigation, planning and construction. Individual projects can be developed on request.

Recommended prior learning: NCEA Level 1 Technology or equivalent.

This course is accessed through our online learning environment, My Te Kura.

Implement advanced procedures using resistant materials to make a specified product with special features

AS91344 SCo SMa Cr Internal 6 credits

Implement advanced procedures using textile materials to make a specified product with special features

AS91345 SMa Cr Internal 6 credits

Make advanced adaptations to a pattern to change the structural and style features of a design

AS91350 SCo SMa SCr Internal 4 credits

Implement advanced procedures to process a specified product

AS91351 SMa Pr Internal 4 credits

Undertake brief development to address an issue

AS91354 (la) Co Ma Pr SCr Internal 4 credits

Develop a conceptual design for an outcome

AS91356 Co Ma Pr SCr Internal 6 credits

Undertake effective development to make and trial a prototype

AS91357 Co SMa Pr Cr Internal 6 credits

Demonstrate understanding of how technological modelling supports risk management

AS91358 (la) Co Ma External 4 credits

TE3000**Technology**

NCEA Level 3 (course endorsement available)

This course challenges ākongā to identify real-life opportunities for innovative design work within their community. A setting is provided, ākongā identify an opportunity that interests them and then choose a context to work in including food technology, hard or soft materials (fashion/textiles). Ākongā frequently work in a combination of these contexts.

This course broadens their experience of the design process from concept to completion. Ākongā work closely with stakeholders as they plan, design and model their concepts before finally creating a solution that is fit for its purpose.

New Zealand Scholarship exams are designed to extend very high-achieving Level 3 ākongā. Those who wish to enter the New Zealand Scholarship exam in this subject must discuss this option with their Te Kura subject kaiako.

Recommended prior learning: NCEA Level 2 Technology or equivalent.

This course is accessed through our online learning environment, My Te Kura.

Undertake brief development to address an issue within a determined context

AS91608 (la) Co Ma Cr Internal 4 credits

Develop a conceptual design considering fitness for purpose in the broadest sense

AS91610 (la) Co Ma Pr Cr Internal 6 credits

Develop a prototype considering fitness for purpose in the broadest sense

AS91611 (la) Co Ma Pr Cr Internal 6 credits

Demonstrate understanding of how technological modelling supports technological development and implementation

AS91612 (la) UElwa Co Ma External 4 credits

Undertake a critique of a technological outcome's design

AS91617 (la) UElwra Co Ma Pr External 4 credits

Implement complex procedures to integrate parts using resistant materials to make a specified product

AS91620 Co Ma Cr Internal 6 credits

Implement complex procedures using textile materials to make a specified product

AS91621 Co Ma Cr Internal 6 credits

Implement complex procedures to create an applied design for a specified product

AS91623 Co Ma Cr Internal 4 credits

Draft a pattern to interpret a design for a garment

AS91626 Ma Cr Internal 6 credits

Implement complex procedures to process a specified product

AS91643 (la) Ma Pr Se Internal 6 credits

Te Reo Māori

Te Reo Māori

Māori is one of the official languages of New Zealand and is an integral part of the country's culture. There are numerous reasons to learn Māori including personal enjoyment or career requirements. Whatever the reason may be, learning Māori provides great satisfaction, a greater connection with New Zealand and an enhanced understanding of our culture and society.

MA000

Beginners' Māori

Curriculum Levels 1–5

This course comprises of three levels – introduction to Māori, Basic Māori and Pre-NCEA Māori. Ākonga are introduced to listening, speaking, reading and writing skills using everyday te reo Māori. They learn how to greet people and communicate basic information about themselves and others including weather, colours, birthdays, family and their home. They also learn how to communicate about time, body parts, food, shopping and roles and responsibilities on the marae. Māori culture is also investigated to give ākonga a broad understanding of the different dialects and customs where Māori is spoken. Communication activities are emphasised throughout.

Recommended prior learning: No prior learning needed.

This is an online course available through our online learning environment, My Te Kura. Ākonga will be required to make and submit video recordings, so a microphone and camera or mobile device are required.

MA1000

Te Reo Māori

NCEA Level 1 (course endorsement available)

A range of themes and skills will be practised through listening, speaking, reading and writing in Māori. The following topics will be covered: Kei te Kainga, Te Ao Taiohi, Kei te Marae and Kei te Kura.

Additional possibilities: Performing Arts offers Dance and Music standards. Ākonga can be assessed individually, or as part of a group.

Recommended prior learning: Ākonga are required to have two or more years experience in Te Reo Māori.

This is an online course available through our online learning environment, My Te Kura. Ākonga will be required to make and submit video recordings, so a microphone and camera or mobile device are required.

Perform dance sequences

AS90002 Cr Internal 6 credits

Demonstrate ensemble skills in a dance

AS90859 Cr Internal 4 credits

Whakarongo kia mōhio ki te reo o tōna ao

AS91085 (la) Pr Se So Cr Internal 6 credits

Kōrero kia whakamahi i te reo o tōna ao

AS91086 (la) Pr Se So Cr Internal 6 credits

Pānui kia mōhio ki te reo o tōna ao

AS91087 (la) Pr Se So Cr External 6 credits

Tuhi i te reo o tōna ao

AS91088 (la) Pr Se So Cr External 6 credits

Waihanga tuhinga i te reo o tōna ao

AS91089 (la) Pr Se So Cr Internal 6 credits

Demonstrate ensemble skills through performing a piece of music as a member of a group

AS91091 Cr Internal 4 credits

MA2000**Te Reo Māori**

NCEA Level 2 (course endorsement available)

A range of themes and skills will be practised through listening, speaking, reading and writing in Māori. The following topics will be covered: Nga Atua Māori, Toku Ao, He Huihuinga, Ko Te Ao Marama and Tangata Rongonui.

Additional possibilities: Performing Arts offers physical education, dance and music standards. Ākonga can be assessed individually, or as part of a group.

Ākonga are expected to have three years or more experience in Te Reo Māori.

Recommended prior learning: NCEA Level 1 Māori or equivalent.

This is an online course available through our online learning environment, My Te Kura. Ākonga will be required to make and submit video recordings, so a microphone and camera or mobile device are required.

Perform an ethnic or social dance to communicate understanding of the style

AS91207 SCr Internal 4 credits

Perform a repertoire of dance

AS91209 Cr Internal 6 credits

Demonstrate ensemble skills by performing a substantial piece of music as a member of a group

AS91272 SCr Internal 4 credits

Whakarongo kia mōhio ki te reo o te ao torotoro

AS91284 (la) Pr Se So Cr Internal 4 credits

Kōrero kia whakamahi i te reo o te ao torotoro

AS91285 (la) Pr SSe So Cr Internal 6 credits

Pānui kia mōhio ki te reo o te ao torotoro

AS91286 (la) UElra Pr Se Cr External 6 credits

Tuhi i te reo o te ao torotoro

AS91287 (la) UElwa Pr Se Cr External 6 credits

Waihanga tuhinga auaha, i te reo o te ao torotoro

AS91288 (la) UElwa Pr SSe So Cr Internal 6 credits

MA3000**Te Reo Māori**

NCEA Level 3 (course endorsement available)

A range of themes and skills will be practised through listening, speaking, reading and writing in Māori. Some of the topics include: whānaungatanga, Te Whenua Ora, Nga Mahi Raranga, Whaikorero, Etahi tikanga, Nga Kai, Taranaki, Nga Toi Māori Tuku iho, Te Māori Ki Te Whenua Hou, Te Maunga Taranaki and Tangihanga.

Additional possibilities: Performing Arts offers Dance and Music standards. Ākonga can be assessed individually, or as part of a group.

Ākonga are expected to have three years or more experience in Te Reo Māori.

Recommended prior learning: NCEA Level 2 Māori or equivalent.

This is an online course available through our online learning environment, My Te Kura. Ākonga will be required to make and submit video recordings, so a microphone and camera or mobile device are required.

Whakarongo kia mōhio ki te reo Māori o te ao whānui

AS91650 (la) Co Ma Pr Se So Cr Internal 4 credits

Kōrero kia whakamahi i te reo Māori o te ao whānui

AS91651 (la) Co Ma Pr Se So Cr Internal 6 credits

Pānui kia mōhio ki te reo Māori o te ao whānui

AS91652 (la) UElra Co Ma Pr Se So Cr External 6 credits

Tuhi i te reo Māori o te ao whānui

AS91653 (la) UElwa Co Ma Pr Se So Cr External 6 credits

Waihanga tuhinga whai take i te reo Māori o te ao whānui

AS91654 (la) UElwa Co Ma Pr Se So Cr Internal 6 credits

Tertiary Link/Huarahi

Te Wānanga Hononga/Huarahi

Year 12 and 13 full-time ākonga and full-time young adult ākonga can take a Tertiary Link course. These courses are purchased from outside providers and ākonga can gain standards towards National Certificates through these courses.

Year 11–13 full-time ākonga and full-time young adult ākonga can apply for a place in Huarahi Trades Academy. We have partners throughout New Zealand where our ākonga can attend a tertiary programme for one or two days a week working towards a vocational pathway. Most Trades Academy programmes can only be started at the beginning of the year but there is provision with some providers to start mid-year or at any time during the year.

TERTLNK

Tertiary Link

NCEA Levels 1–3

The following options are available.

Automotive – Distance units available at NCEA Level 1 and 2.

Early Childhood Education – Distance units available at NCEA Levels 2 and 3. Practical experience looking after a child under the age of five years is required either at home or in a workplace. Ākonga can work towards the National Certificate in Early Childhood Education Level 3.

Farm Based Skills – Distance units available from a wide range of unit standards at NCEA Levels 2 and 3 in General Agriculture, Vehicles and Machinery, Fencing, Dairy, Deer, Sheep, Cattle, Farming Agrichemicals and pest plant control, Apiculture (Beekeeping), Equine, Horticulture and Forestry.

Travel – Distance units available at NCEA Levels 2 and 3. Ākonga can gain the National Certificate in Tourism (Introductory Skills) Level 2.

Recommended prior learning: No prior learning needed.

Huarahi

Trades Academy

NCEA Levels 1–3

Huarahi Trades Academy offers ākonga the opportunity to achieve NCEA Level 2 and standards towards a Vocational Pathway endorsement. We partner with a range of Tertiary providers across New Zealand and seek to offer a range of courses to cater for your interests while you also complete work in your Te Kura courses.

Not all programmes are offered in all areas so it is worth asking or checking on the Te Kura website. Ākonga can complete the qualifications over one, two or three years, while ākonga remain on target to achieve NCEA Level 2.

Ākonga must complete a registration form, provide the required documentation and in some cases attend an interview.

Trades Academy places are limited.

Recommended prior learning: No prior learning needed.