



+91-8048967206

# Karam Chucks (Regd.)

<https://www.indiamart.com/karam-chucks/>

**Power Chuck, True Chuck, Dog Chuck, Lathe Chuck,  
Soft Jaw, Revolving Centre, Pipe Centre, Milling Vice,  
Rotary Cylinder, Collet Chuck**

**Dealer: SECO, GMT, KITAGAWA, AIRTECH, TRUMAX,  
ZITHER, JAINSON, KKF, TURNO**



## About Us

We **Karam Chucks**, are a popular name in the trading, distributing & exporting of all kind of Lathe Chucks both Manual cum Power Operated.

We are also enjoying the clientage of the leading of India for the last thirty-two years. We are quality conscious company, which believes in delivering quality equipments to our esteemed clients in related industries. Apart from that, our company is led by **Mr. Didarjit Singh** , whose skills and guidance have helped us to reach this height of success. His intense knowledge in this field and our employees combine dedications have pave the way of success for our company.

As a leading trader and exporter in the engineering sector, we also undertake rewinding services for **Drill Chuck, Special Purpose Chuck, Soft Jaws, Rotary Cylinder & Back Plate.**

Hi-tech facilities, proven expertise, and assiduous professionals have enabled us to offer chucks as per international quality standards. Be it non-cylindrical or special component, our professionals provide solution to all work holding problems. We provide regular training to our professionals so that they can undertake calibration and retrofitting services with ease and accuracy. We are continuously progressing under the visionary guidance of our founder, **Mr. Didarjit Singh**, who has provided effective solutions to various import substitution problems. Due to his sharp business acumen and strong...

**For more information, please visit**

<https://www.indiamart.com/karam-chucks/profile.html>



# POWER CHUCK FOR CNC

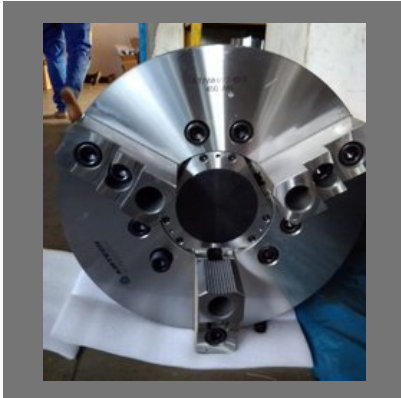

Airtech 450WH Open  
Centre Power Chuck

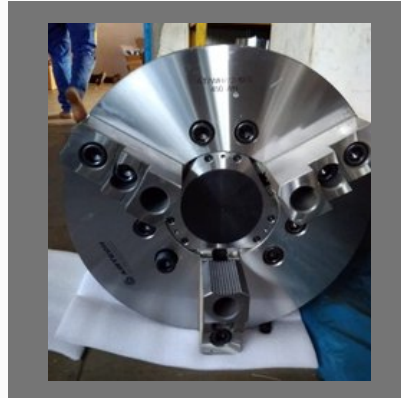

Airtech 250WH Open  
Centre Power Chuck

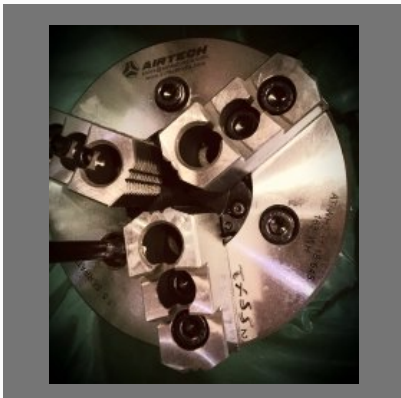

Airtech 135WH Open  
Centre Power Chuck

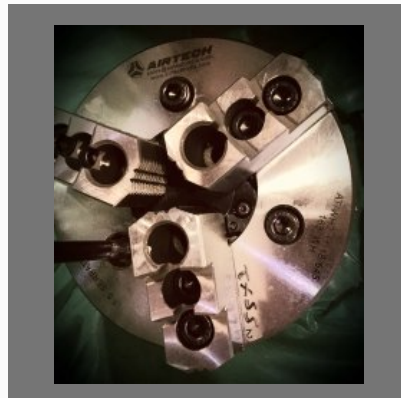

Airtech 165WH Open  
Centre Power Chuck

# CHUCK SPARES



Power Chuck Dust Cover



Self Centering Chuck Pinion



HMT Chuck Backplate



Hiwin Guide Block

# HYDRAULIC POWER CHUCK



Autogrip 3H-206 Large Bore Power Chuck



Open Centre Power Chuck



Unnat High Speed Power Chuck



Samchully MH-208V1 Power Chuck

# SELF CENTERING TRUE CHUCK



Seco SJ3 Self Centering Chucks



6 Jaw Drill Point Grinder Chuck



Bonmac Screw Operated 2 Jaw Chuck

# STATIONARY POWER CHUCK



VH-304 Stationary Power Chuck



Stationary Power Chuck



4 Jaw Stationary Power Chuck

## ROTARY CYLINDER



Pragati Make Rotary  
Cylinder PHS 1246 (Bore  
46mm)



Close Centre Rotary  
Cylinder



Hydraulic Rotary Cylinder  
Open Bore OBC 120 SECO



# INDEPENDENT DOG CHUCK



Shasons 4 Jaw  
Independent Dog Chucks  
305mm 12"



4 Jaw Screw Operated Self  
Centering Chuck



SECO Independent Chucks  
/ Dog Chucks

# SOFT JAWS

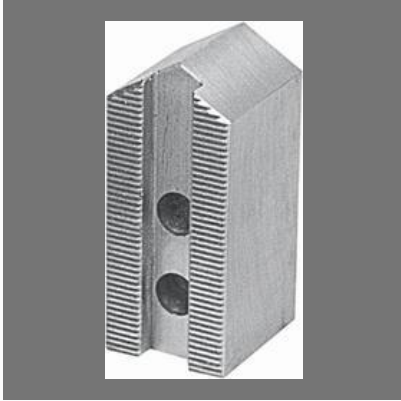

Power Chuck Soft Jaw



CNC Soft Jaw



200mm Threaded Soft Jaw

# CNC REVOLVING CENTER



Heavy Duty CNC Revolving Center Spare Point



Revolving Centre Spare Pins



Turnmax CNC Revolving Center Spare Point

## OTHER PRODUCTS:



Soft Jaw Boring Ring



Self Centering Chuck  
Pinion Pins



JA7-44 Rotary Power Chuck

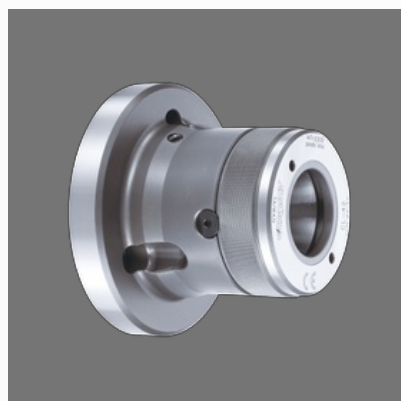

Power Operated Collet  
Chuck

## OTHER PRODUCTS:

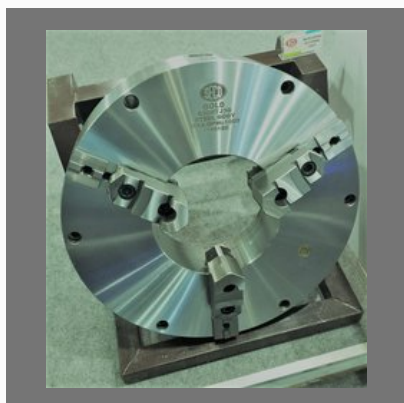

630 Mm 3 Jaw True Chuck



Seco Gold MTJ3 Master Gripping Self Centering Chuck



Kitagawa B208 Power Chuck



Kitagawa BR08 Large Thru-Hole High Accuracy Power Chuck

## OTHER PRODUCTS:



Molykote TP-42 Adhesive Grease Paste



OKS 265 Chuck Jaw Paste



Power Chuck Mounting Plate



Power Chuck Backplate

## OTHER PRODUCTS:



Round Permanent Magnet Chuck



Rectangular Magnet Chuck



KEM-CS-A5 Expanding Mandrel



Expanding Mandrel



## OTHER PRODUCTS:

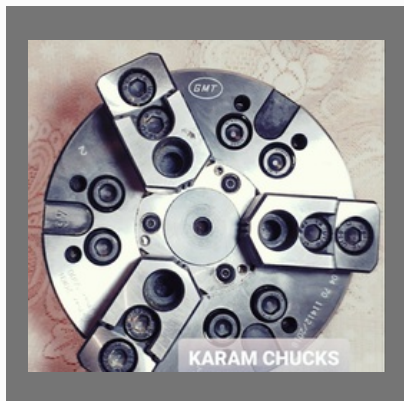

GMT Power Operated High Speed Chuck



Unique U 310 Milling Machine Vice



200mm 4 Jaw Steel Combination Chuck



Big Bore 4 Jaw Independent Dog Chuck



## OTHER PRODUCTS:



Jaw Compensating Chuck



Samchully IAHT-230 Auto Indexing Chuck



Power Chuck Top Hard Jaw



Heavy Duty Bench Vice

## OTHER PRODUCTS:



Seco Gold DP3G Dust Proof Self Centering Chuck



Power Chuck T Nuts



Unique U-3510 Hydraulic Pressure Vice



Lathe Chuck Independent Dog Chuck 14"

## OTHER PRODUCTS:



Unique U 335 Precision  
Dual Station Vice



CNC Machine Turret  
Sleeves



Pipe Center For CNC  
Machine



Turnmax Keyless Drill  
Chuck

## OTHER PRODUCTS:



Unique U3333 Modular Precision Machine Vice

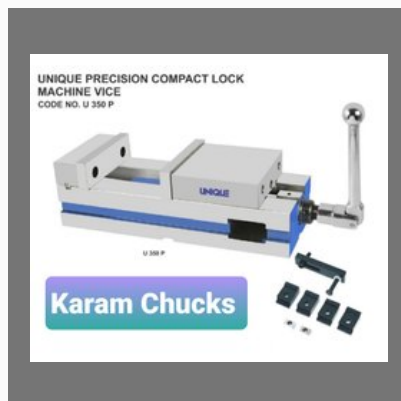

Precision Compact Lock Machine Vice



JT6 Drill Chuck



Dog Chuck Mounting Bolts

## OTHER PRODUCTS:



Bonet Face Plate Jaws



Kitagawa MK200RAV00 NC Rotary Table

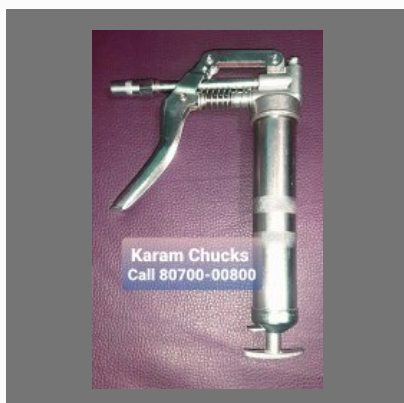

Grease Gun



Luthra Granite Surface Plate

# Factsheet

Year of Establishment : 1979

---

Nature of Business : Exporter and Distributor / Channel Partner

---

Total Number of Employees : Upto 10 People

---



## CONTACT US

### **Karam Chucks (Regd.)**

Contact Person: Didarjit Singh Lotey

701

Ludhiana - 141003, Punjab, India



+91-8048967206



<https://www.indiamart.com/karam-chucks/>