

Item	Description	Qty
A	Control Module	1
B	Wiring Harness	1
C	Motor	1
G	M8-1.25 x 20mm Lg. FHCS	3
K	M6-1.0 x 16mm Lg. HHCS	2
L	M6 Flat Washers	4
N	M6-1.0 Nylock Nuts	2
P	M6-1.0 x 20mm Lg. HHCS	2
Q	M8-1.25 x 16mm Lg. FHCS	2

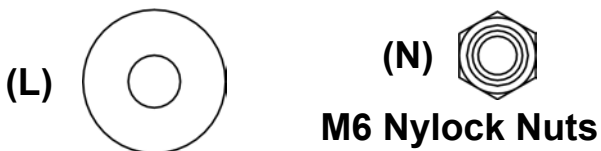

M6 Nylock Nuts

(Kit Contents continue on following page)

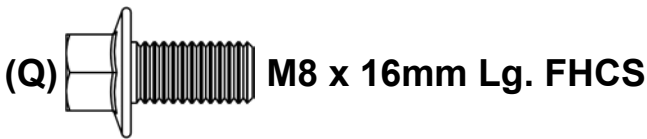

Read instructions and view illustrations before beginning.

Need help with your installation?



sales@superatv.com



www.superatv.com



1-812-574-7777



8:00am - 9:00pm EST M-Th
8:00am - 7:00pm EST Friday
9:00am - 2:00pm EST Saturday

Thank You

For Choosing

SUPERATV.COM

Liability Statement

SuperATV's products are designed to best fit users ATV/UTV under stock conditions. Adding, modifying, or fabricating any factory, or aftermarket, parts will void any warranty provided by SuperATV and is not recommended. SuperATV's products could interfere with other aftermarket accessories. If user has aftermarket products on machine, contact SuperATV to verify that they will work together.

Although SuperATV has thousands of satisfied customers, user should be aware that installing lift kits, long travel, or suspension kits, tires, etc will change the ride of machine and may increase maintenance and part wear. Operating any off-road machine while, or after, consuming alcohol and/or drugs increases risk of bodily harm or death. No warranty or representation is made as to this product's ability to protect user from severe injury or death. SuperATV urges operators and occupants to wear a helmet and appropriate riding gear at all times.

By purchasing and installing SuperATV products, user agrees that should damages occur, SuperATV will not be held responsible for loss of time, use, labor fees, replacement parts, or freight charges. SuperATV, nor any 3rd party, will not be held responsible for any direct, indirect, incidental, special, or consequential damages that result from any product purchased from SuperATV. The total liability of seller to user for all damages, losses, and causes of action, if any, shall not exceed the total purchase price paid for the product that gave rise to the claim.

SuperATV will warranty only parts provided by SuperATV. Any damage or problems with OEM housings, bearings, seals, or other manufacturers products will not be covered by SuperATV. SuperATV parts and products are not warranted if item was not installed properly, misused, or modified.

(Kit Contents continued)

Item	Description	Qty
D	Upper Shaft	1
E	Lower Shaft	1
F	Motor Bracket	1
H	Wiring Connectors Kit	1
M	Control Module Bracket	1

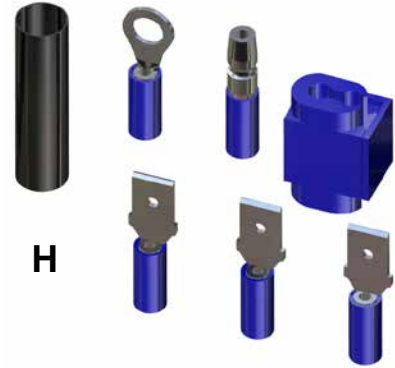

H

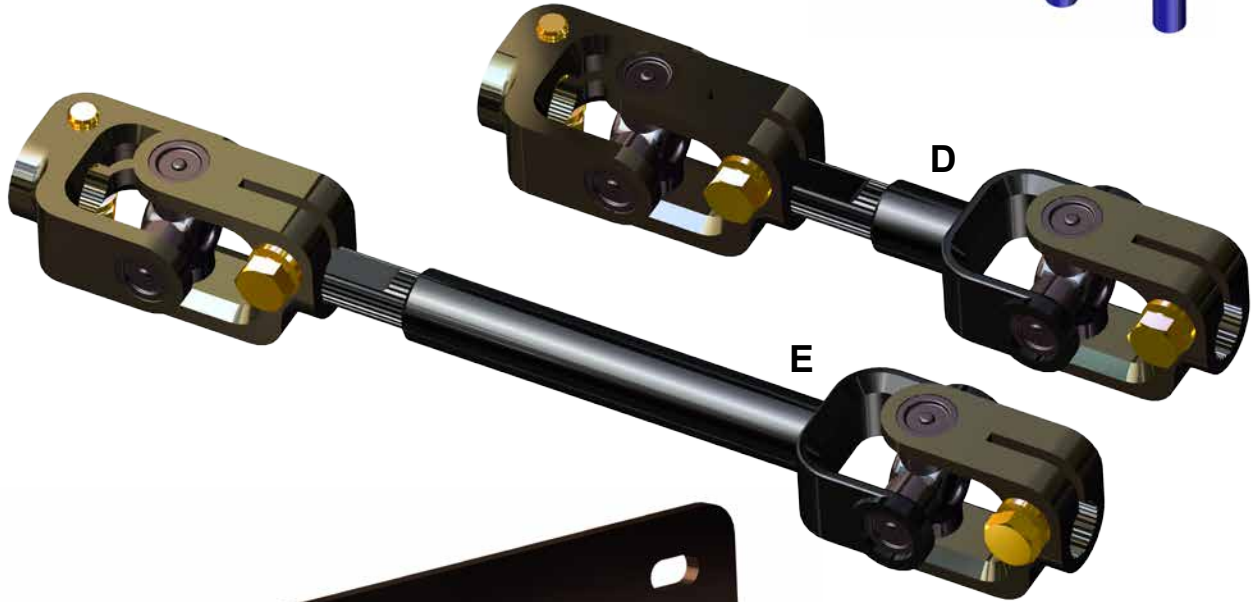

D

E

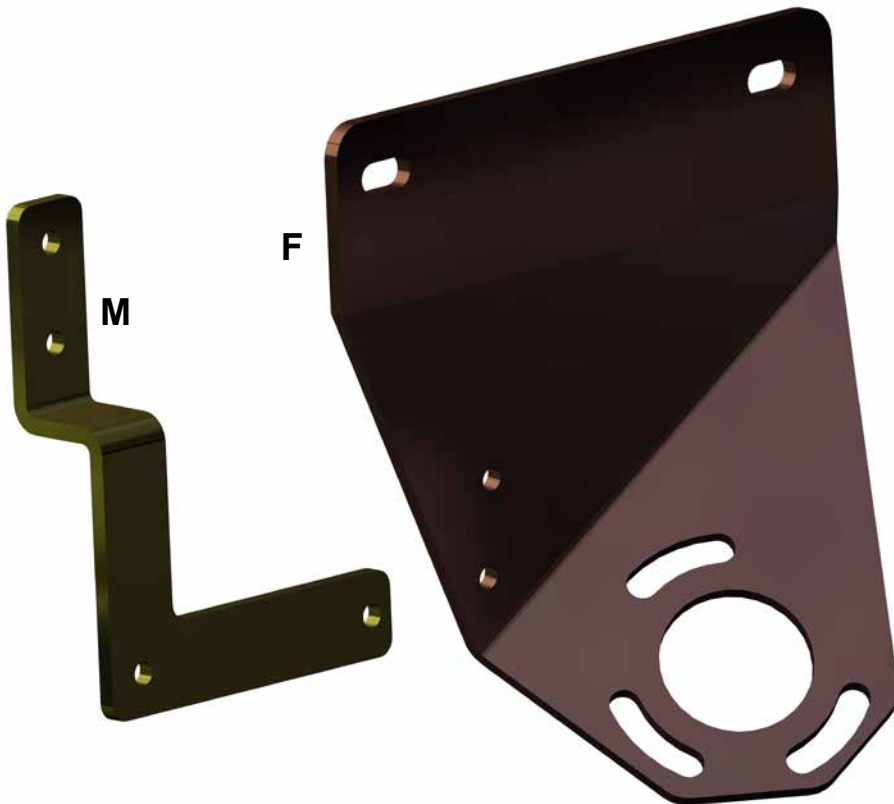

F

M



Before starting installation, ensure all connections are as follows:



- Before installing, ensure that all waterproof connections are properly seated.
- If Gaskets are not seated, as shown, use a Flathead Screwdriver to seat.

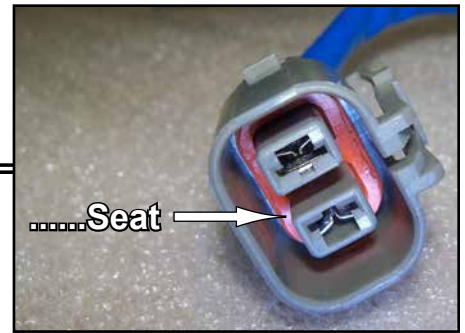
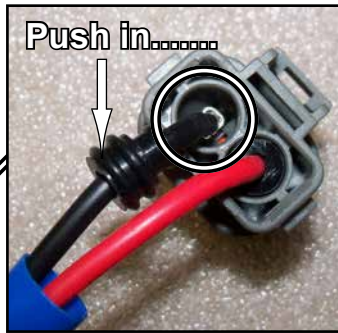
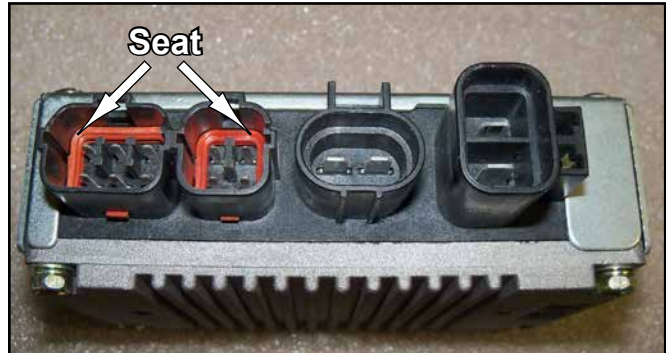
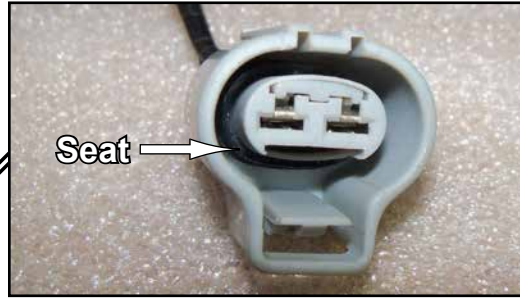

Removal: *Keep all stock hardware.*

1. Remove Screws and Plastic Rivets from Dash. Disconnect Wire Harness' and remove hardware from Driver Side of Roll Cage; remove Dash. See Figs. 1 - 1c.
2. Remove hardware from Upper and Lower Shafts. See Figs. 2 - 2a.
3. Remove (4) Bolts from stock Mounting Bracket. See Fig. 3.
4. Remove Upper Shaft, Mounting Bracket, and Lower Shaft from machine. See Figs. 4 - 4a.

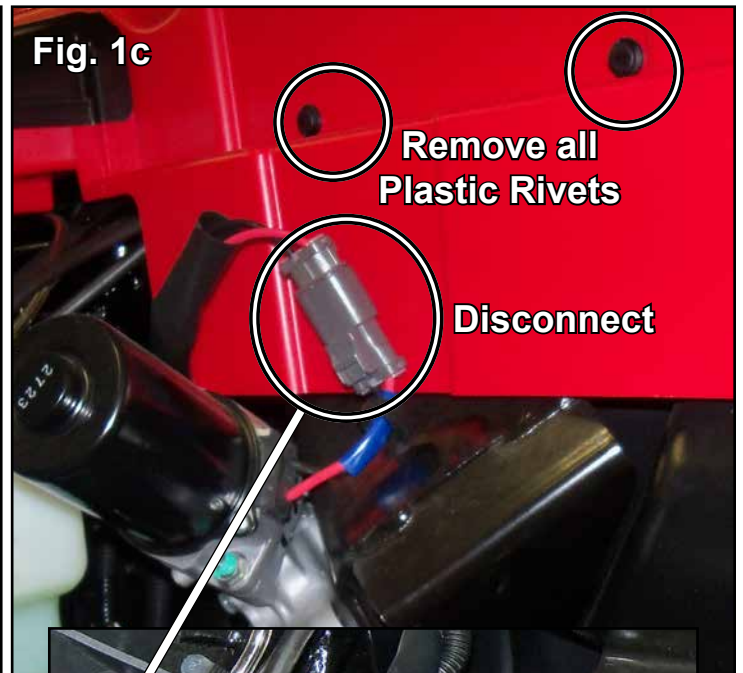
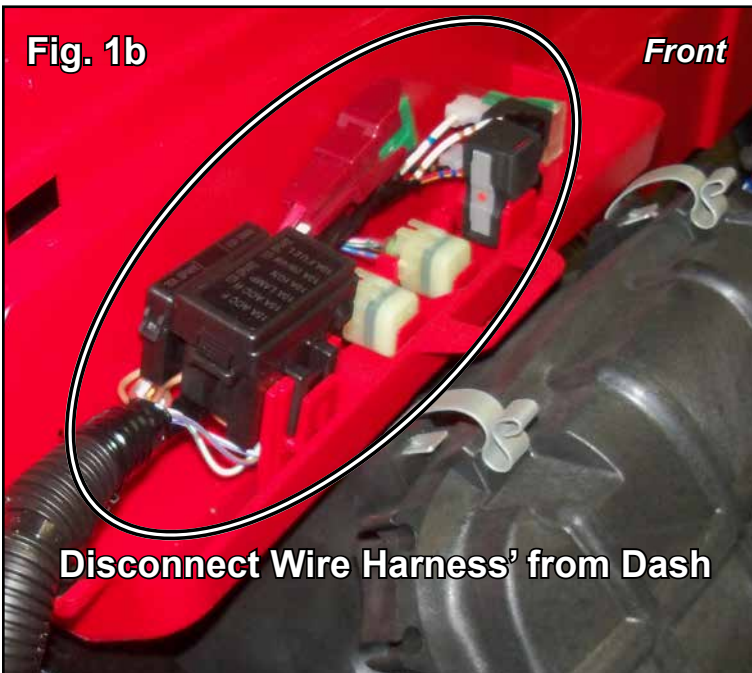
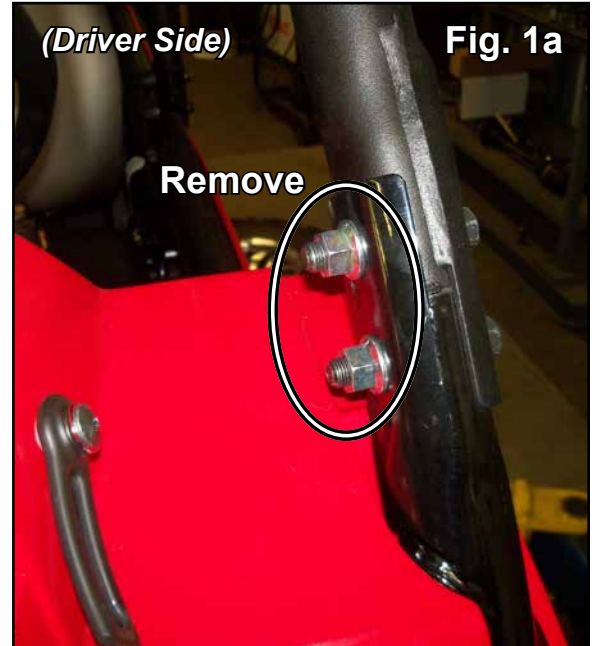

(removal illustrations continue on following pages)

(removal illustrations continued)

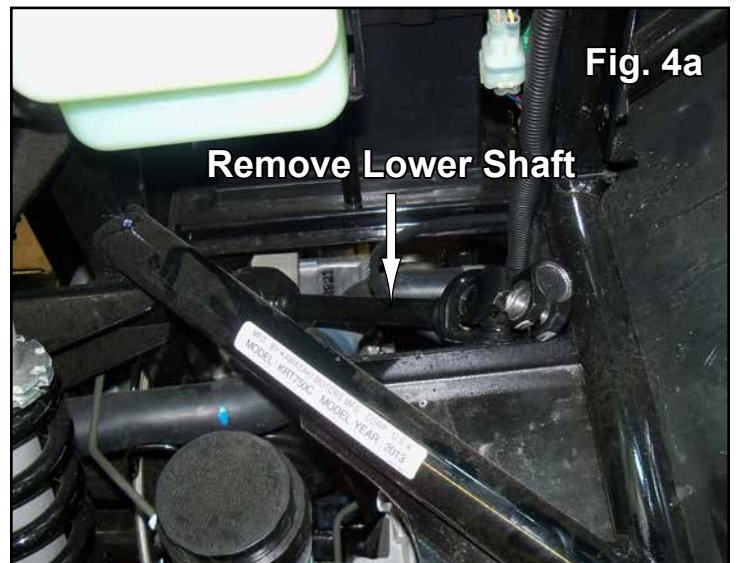
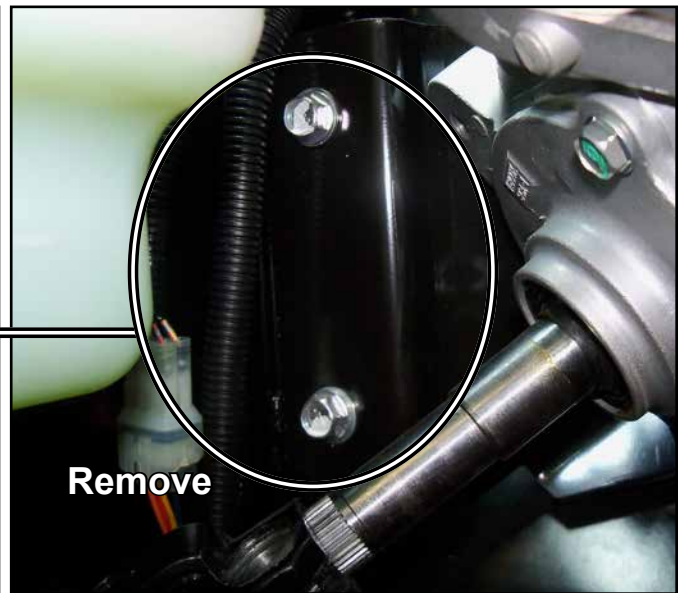
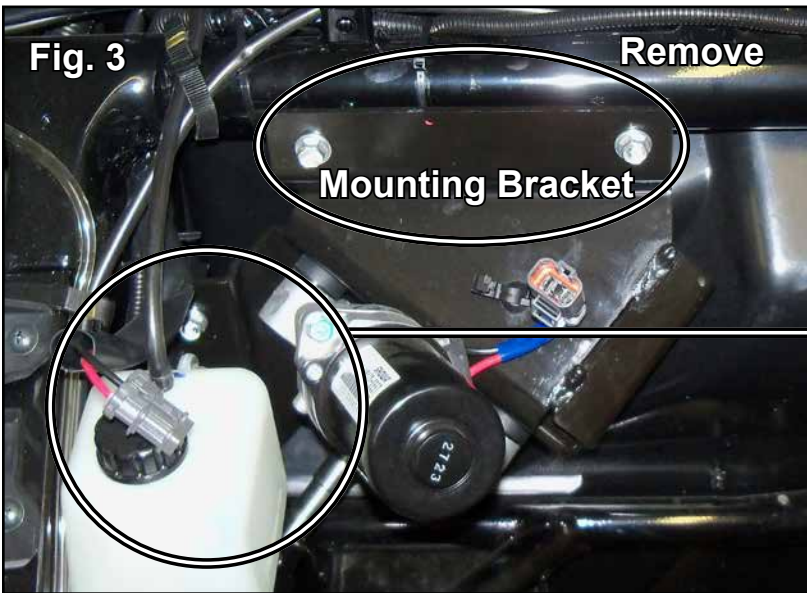
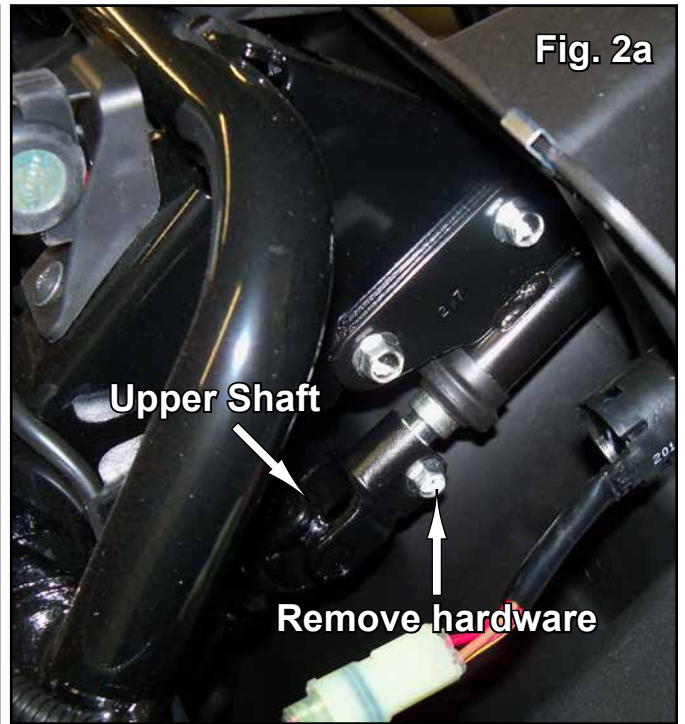
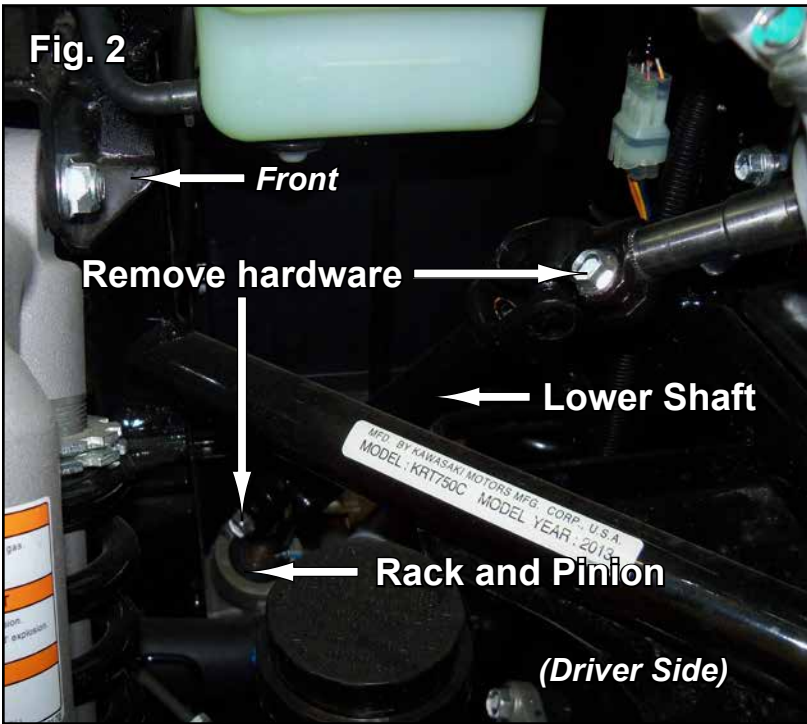

Do not tighten hardware completely unless noted.

1. Install Motor Bracket (F) to Motor (C) with M8-1.25 x 20mm Lg. FHCS (G). See Fig. 1.
2. Install Control Module (A) to Control Module Bracket (M) with M6-1.0 x 16mm Lg. HHCS (K); tighten hardware. See Fig. 2.
3. Install Lower Shaft (E) to Rack and Pinion with supplied hardware. See Figs. 3 - 3a.
4. Install Motor (C) to Lower Shaft (E) with supplied hardware. See Motor Shafts Detail and Fig. 4.
5. Install Upper Shaft (D) to stock Upper Steering Shaft with supplied hardware. See Figs. 5 - 5a.
6. Join Upper Shaft (D) to Motor (C) with supplied hardware. See Fig. 5a.
7. Locate (2) mounting locations, as shown in Fig. 6, and install Motor Bracket (F) with M8-1.25 x 16mm Lg. FHCS (Q). See Fig. 6.
8. Install Control Module Bracket (M) to Motor Bracket (F) with M6-1.0 x 20mm Lg. HHCS (P), M6 Flat Washers (L), and M6-1.0 Nylock Nuts (N). See Fig. 6.
9. Plug Wiring Harness (B) into Control Module (A) and connect wiring. See Wiring Details, page 9.
10. Ensure no components are binding, rubbing, or causing interference and tighten all hardware completely.
11. Reinstall necessary compents uninstalled during "Removal".

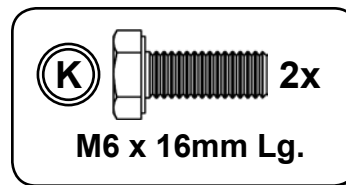
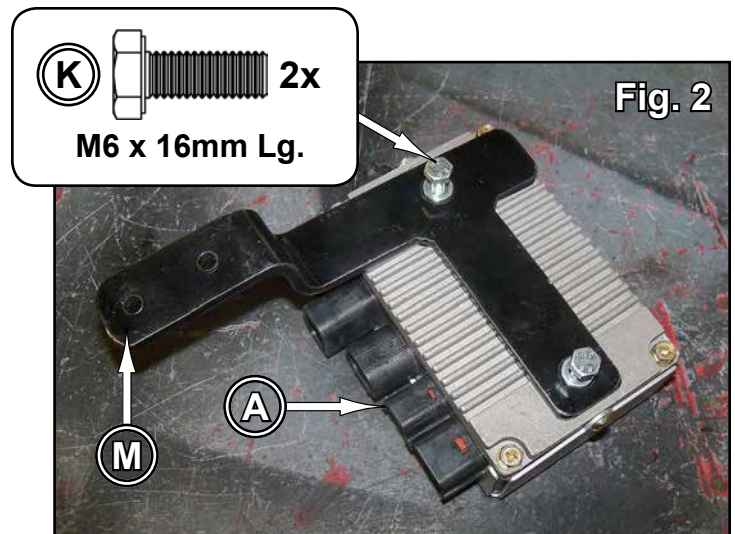
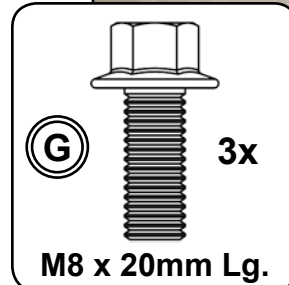
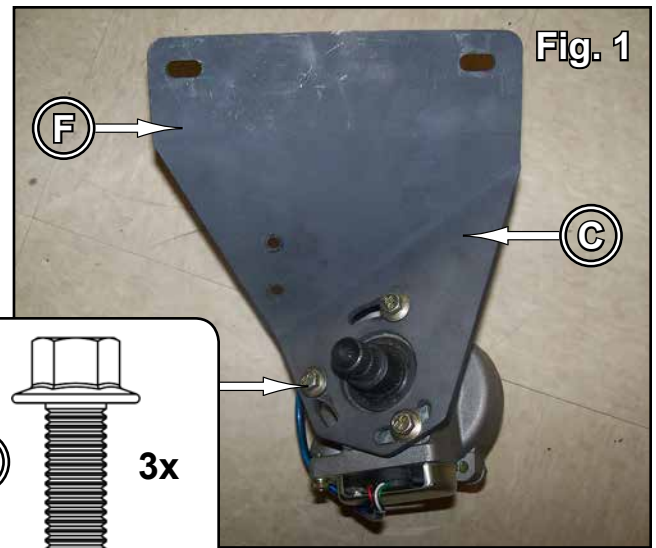

PARTS REFERENCE

Item	Description
A	Control Module
B	Wiring Harness
C	Motor
D	Upper Shaft
E	Lower Shaft
F	Motor Bracket
G	M8-1.25 x 20mm Lg. FHCS
H	Wiring Connectors Kit
K	M6-1.0 x 16mm Lg. HHCS
L	M6 Flat Washers
M	Control Module Bracket
N	M6-1.0 Nylock Nuts
P	M6-1.0 x 20mm Lg. HHCS
Q	M8-1.25 x 16mm Lg. FHCS

(Illustrations continue on following pages)

(Illustrations continued)

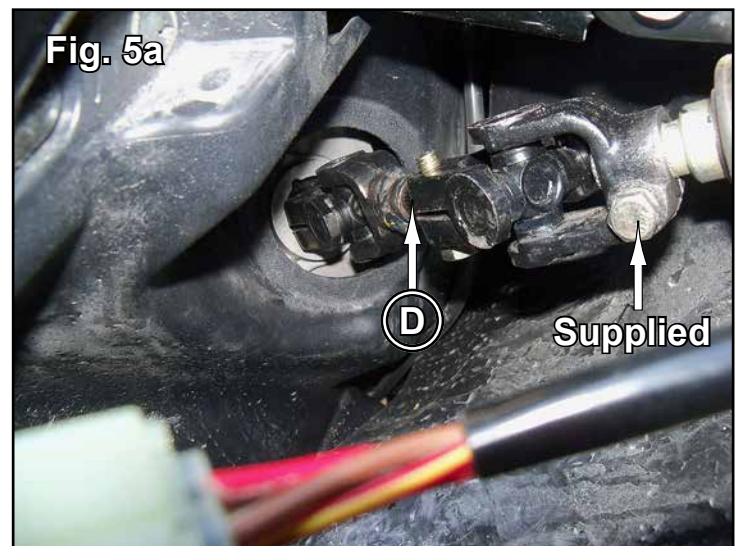
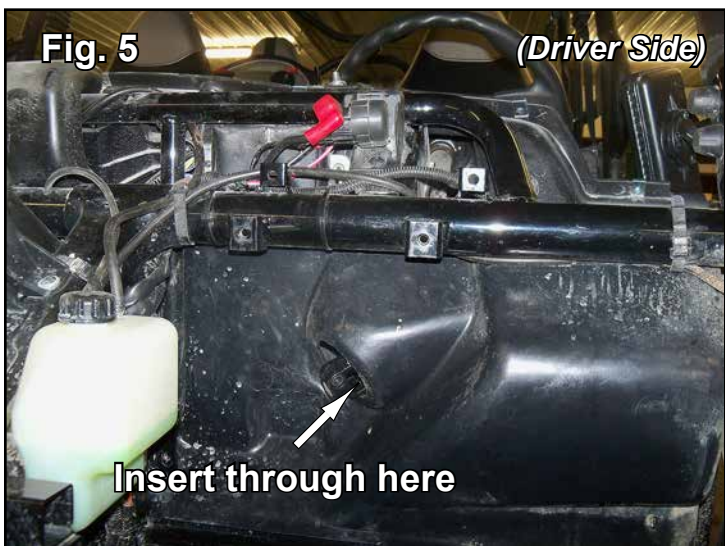
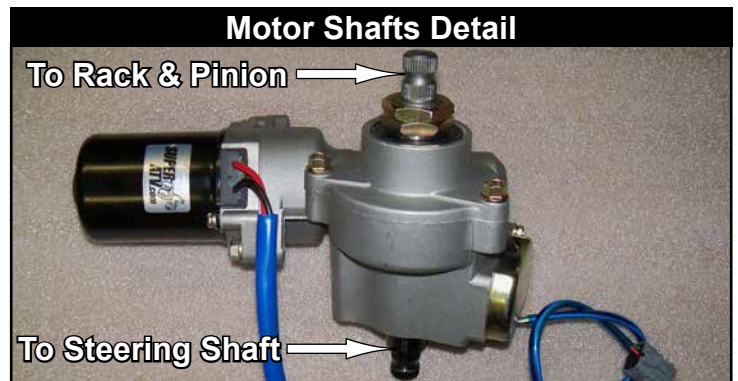
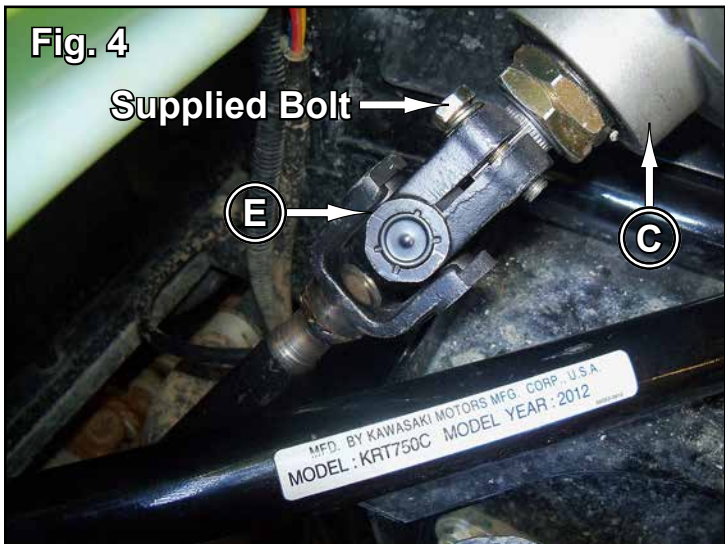
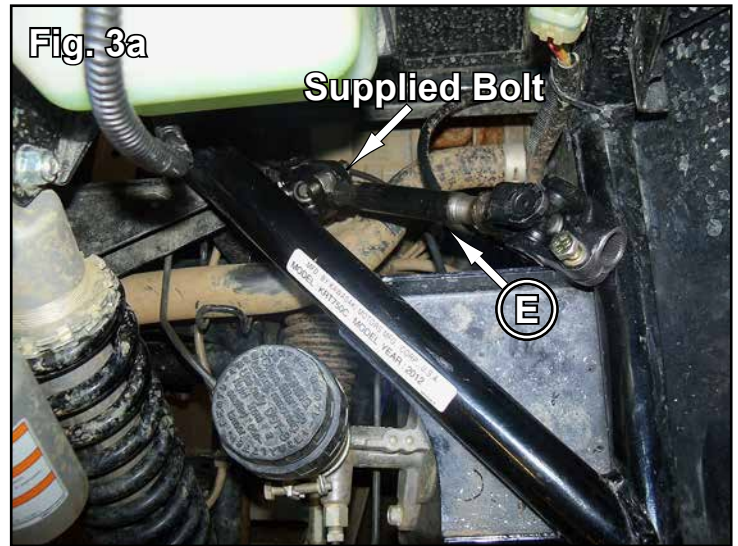
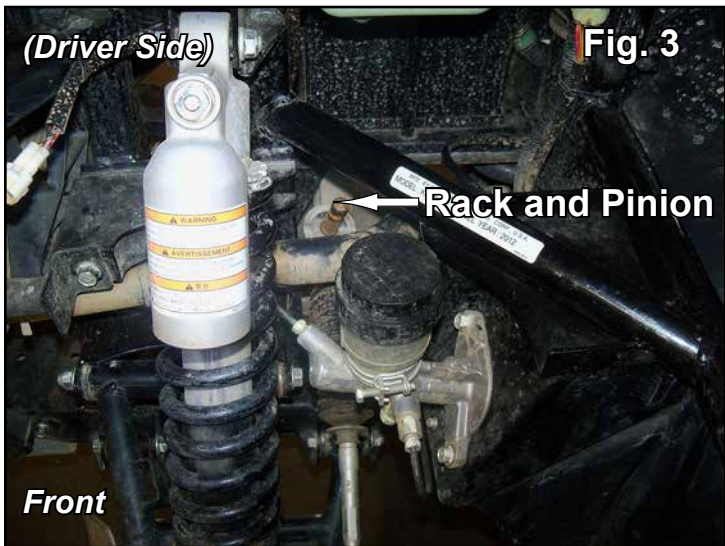

(Illustrations continue on following pages)

(Illustrations continued)

Bracket Mountings, Fig. 6

PARTS REFERENCE

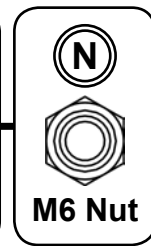
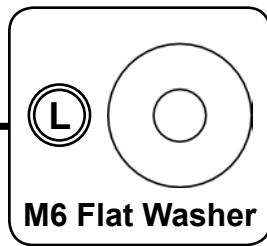
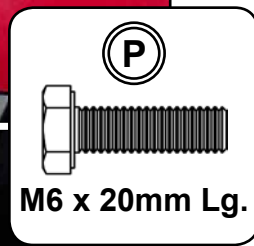
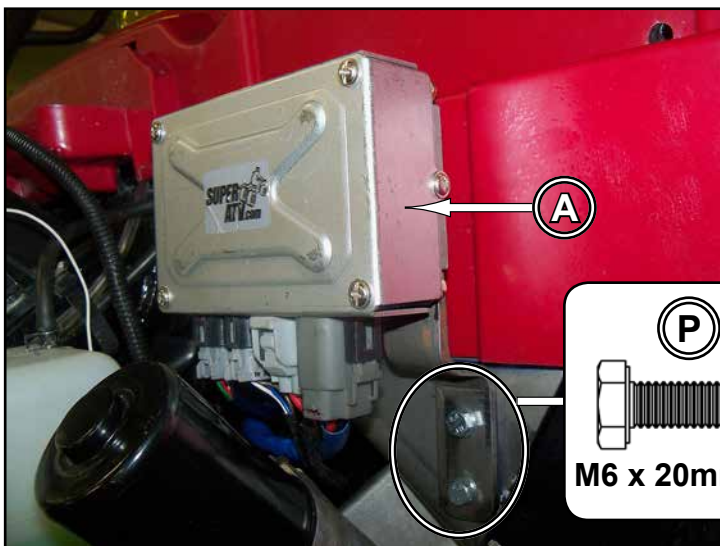
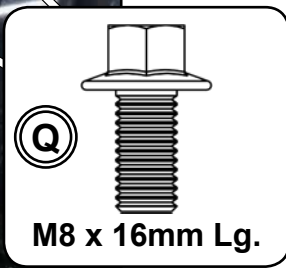
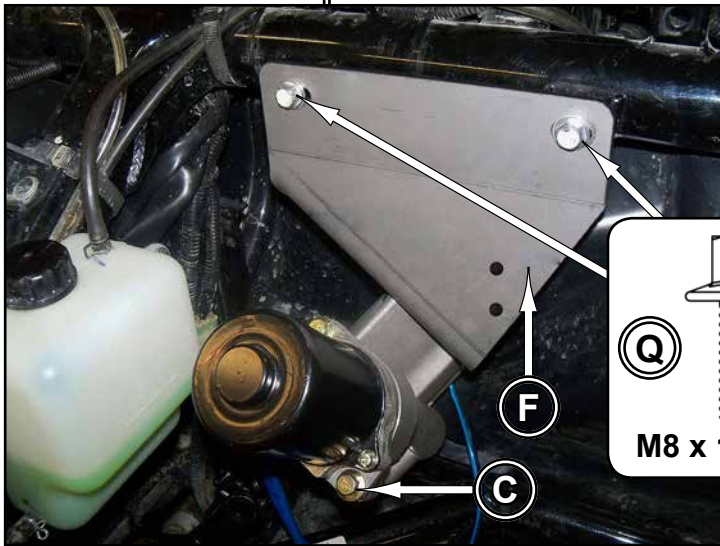
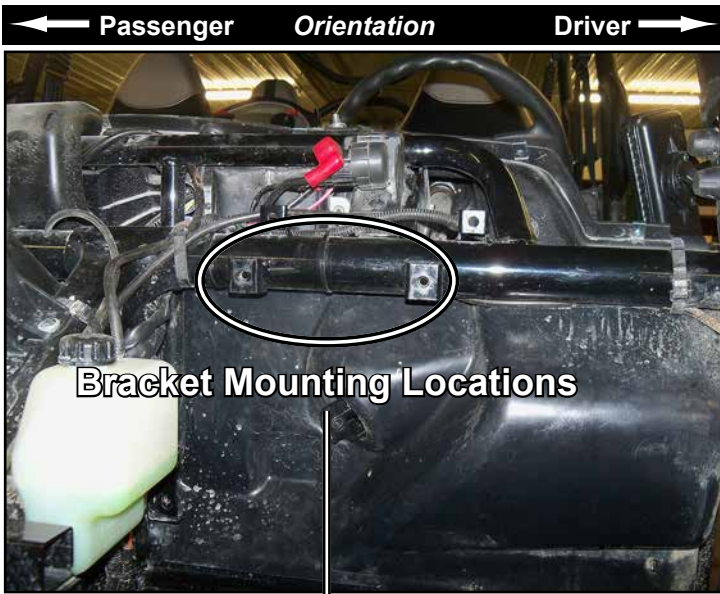

Item	Description
A	Control Module
B	Wiring Harness
C	Motor
D	Upper Shaft
E	Lower Shaft
F	Motor Bracket
G	M8-1.25 x 20mm Lg. FHCS
H	Wiring Connectors Kit
K	M6-1.0 x 16mm Lg. HHCS
L	M6 Flat Washers
M	Control Module Bracket
N	M6-1.0 Nylock Nuts
P	M6-1.0 x 20mm Lg. HHCS
Q	M8-1.25 x 16mm Lg. FHCS

Wiring Details

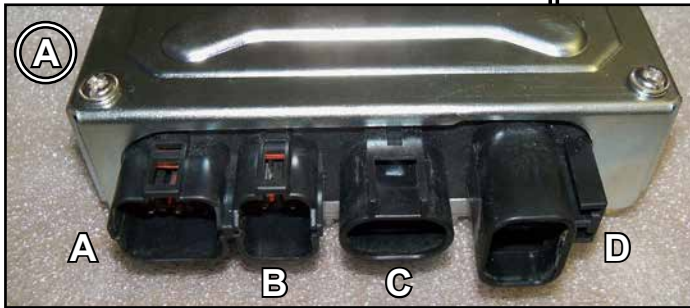
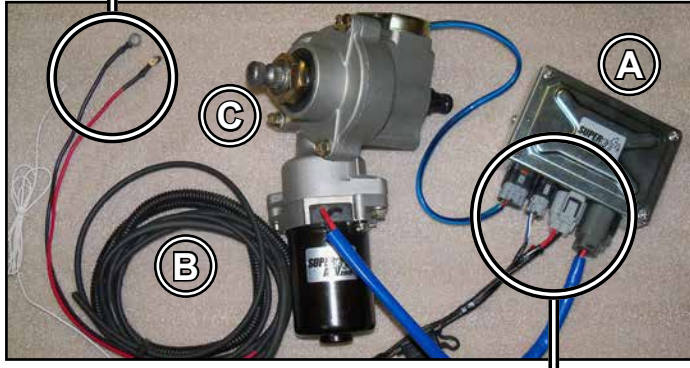

Plug	Function
A	Torque Sensor
B	Switched 12V Source
C	Power
D	Motor

Secure Diagnostic Light in a visible location.



When activated, Diagnostic Light will flash (1) time for about (1) second before turning off indicating proper function. Should different patterns occur, contact SuperATV.

Switched 12V Source Connection Details

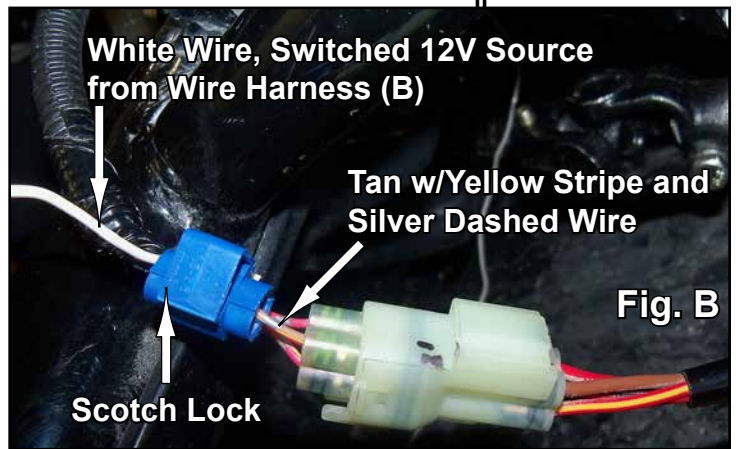
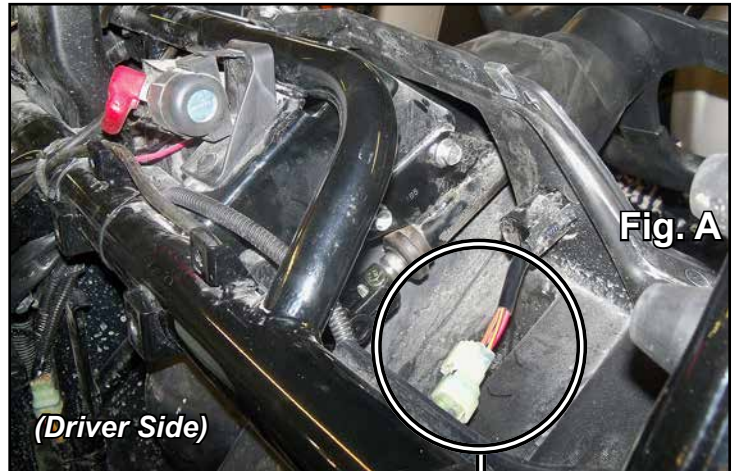

Soldering connection is recommended however, installer may use other forms of connecting.

1. Locate Connector shown in Fig. A.
2. Connect White Wire from Wire Harness (B) to Tan with Yellow Stripe and Silver Dashed wire. Scotch Lock (included) or solder. See Fig. B.

Battery Connections

