

# KNAPHEIDE®

SINCE 1848

# KUV<sup>CC</sup>™



KC96U1478J



KC96M1478J



KC108M2094J



KC132H2094J

\*Some models shown with optional equipment.

# Standard Features



**A** Double panel, 20 gauge galvanized steel doors lock and seal into the body frame and employ slam latches, nitrogen gas struts, and window guards.



**B** Two conduit chutes to transport copper pipes, PVC, and conduit.



**C** Master Locking System for peace of mind, locks down all of the side compartments in one move.



**D** Interior light guards provide protection for recessed lighting and wiring package

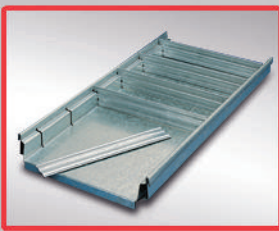

**E** 25 lb. capacity adjustable divider shelves made of rugged spangled galvanized steel. Divider slots on 4" centers. Shelves are covered through Knapheide's six year warranty.



**F** Double spring over-center door retainer on all vertical doors eliminates involuntary swing and keeps the door in positive open or closed position.



**G** Thick automotive bulb-type neoprene door seals protect compartments from the weather.



**H** Continuous hinge for unmet and corrosion. Backed by year warranty.

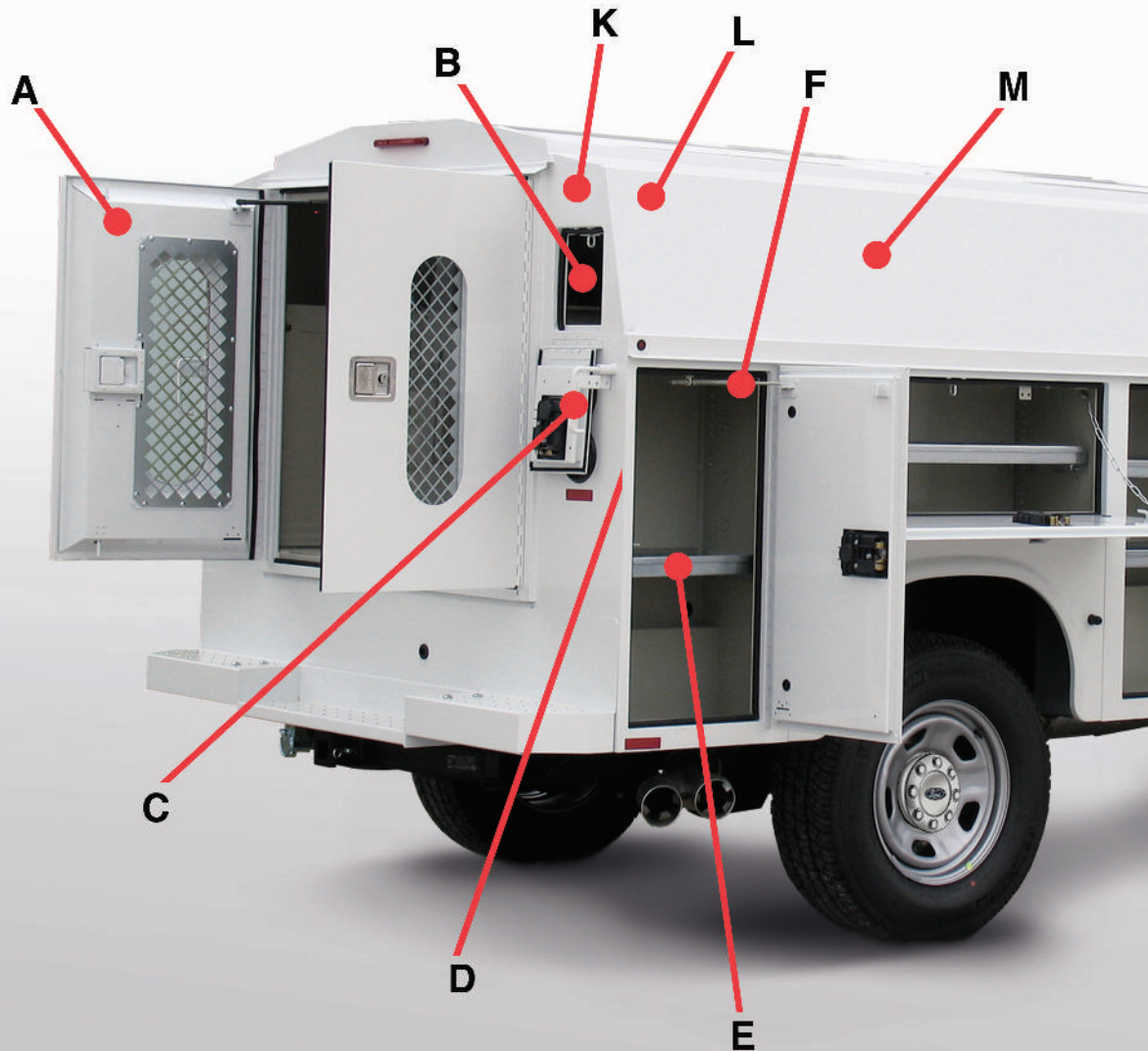



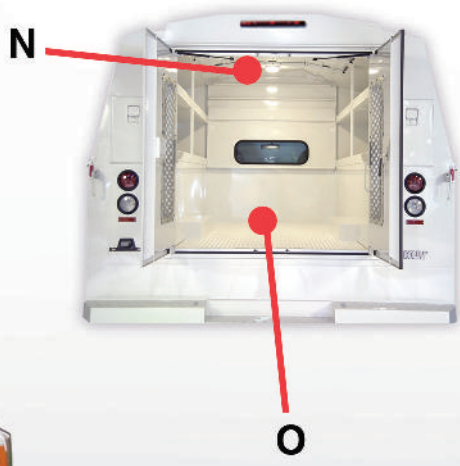
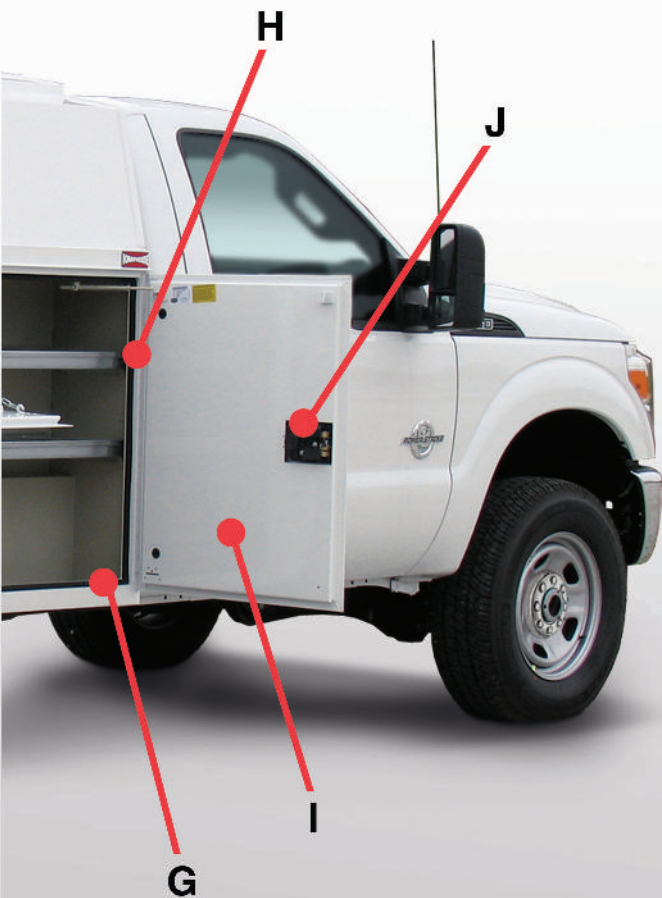

**O** Spacious cargo area for transporting oversized tools and equipment.



**N** Two interior dome lights in cargo area for improved visibility in low light conditions. Light switch located inside rear cargo area.



**M** Flat panel space great for advertising company graphics and contact information.



stainless steel matched security resistance. Knapheide's six

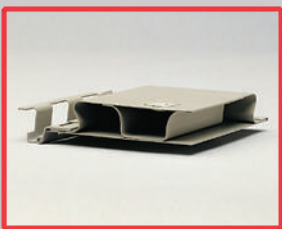

**I** Double-shell 20 gauge, two sided A-40 galvanized steel hat section reinforced doors for durability and long life.



**J** Stainless steel paddle activated, rotary-style latches close easily and stay closed. Individually lockable bolt-on latches can be removed for repair or maintenance. Comes with Knapheide's six year warranty.

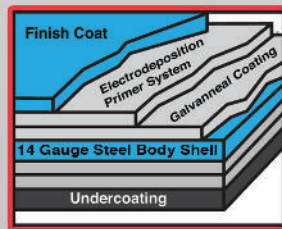

**K** Rugged 14 gauge two-sided A-40 galvanized steel body shell with a six year warranty. Complete undercoating provides an additional layer of corrosion protection.



**L** Complete immersion in Knapheide's electrodeposition prime paint system for superior corrosion resistance.

# 56" CA Single Rear Wheel

Model	Body Length	Body Height	Body Width	Compartment Depth	Clear Door Width	Clear Door Height	Interior Clear Height	Body Weight
KC96U1478J	97.25"	62"	78"	14.5"	44.5"	38.1"	45.1"	1,627 lb.
KC96L1478J	97.25"	68"	78"	14.5"	44.5"	41.1"	51.1"	1,747 lb.
KC96M1478J	97.25"	78"	78"	14.5"	44.5"	50.5"	61.1"	1,770 lb.

Applicable Chassis	Cab	Wheel Base	GVWR
X2A	Super	158"	9,600/10,000 lb.
W2A	Crew	172"	9,600/10,000 lb.
F3A/F3B	Reg.	137"	10,400/11,200 lb.
X3A/X3B	Super	158"	10,200/11,500 lb.
W3A/W3B	Crew	172"	10,200/11,500 lb.

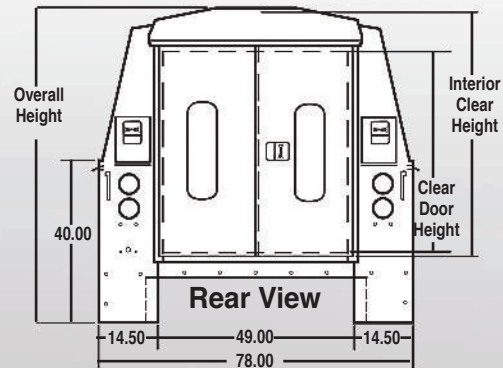
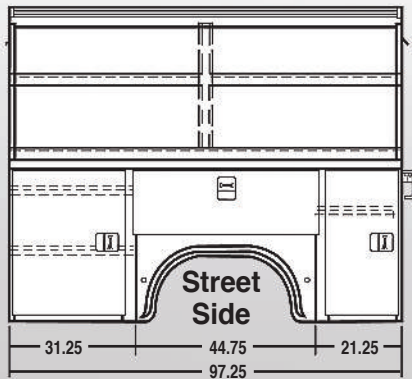

# 56" CA Dual Rear Wheel

Model	Body Length	Body Height	Body Width	Compartment Depth	Clear Door Width	Clear Door Height	Interior Clear Height	Body Weight
KC96U2094J	97.25"	62"	94"	20"	49.5"	38.1"	45.1"	1,753 lb.
KC96L2094J	97.25"	68"	94"	20"	49.5"	41.1"	51.1"	1,891 lb.
KC96M2094J	97.25"	78"	94"	20"	49.5"	50.5"	61.1"	1,914 lb.
KC96H2094J	97.25"	90"	94"	20"	49.5"	63.1"	73.1"	2,032 lb.

Applicable Chassis	Cab	Wheel Base	GVWR
F3C/F3D	Reg.	137"	12,200/13,000 lb.
W2A	Crew	172"	12,600/13,000 lb.
F3A/F3B	Reg.	137"	12,600/13,000 lb.

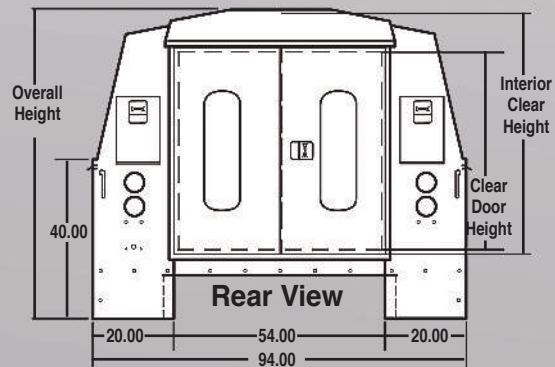
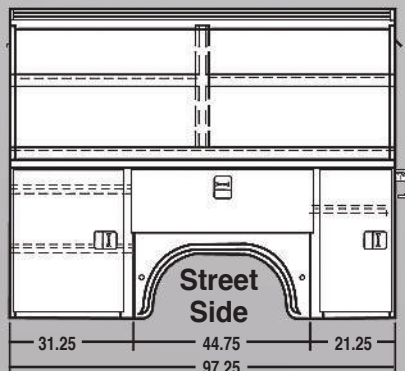

# 60" CA Single Rear Wheel

Model	Body Length	Body Height	Body Width	Compartment Depth	Clear Door Width	Clear Door Height	Interior Clear Height	Body Weight
KC108U1478J	107.25"	62"	78"	14.5"	44.5"	38.1"	45.1"	1,648 lb.
KC108L1478J	107.25"	68"	78"	14.5"	44.5"	41.1"	51.1"	1,773 lb.
KC108M1478J	107.25"	78"	78"	14.5"	44.5"	50.5"	61.1"	1,799 lb.

Applicable Chassis	Cab	Wheel Base	GVWR
F3E/F3F	Reg.	141"	9,800/11,000 lb.
X3E/X3F	Super	162"	9,800/11,500 lb.
W3E/W3F	Crew	176"	9,800/11,500 lb.

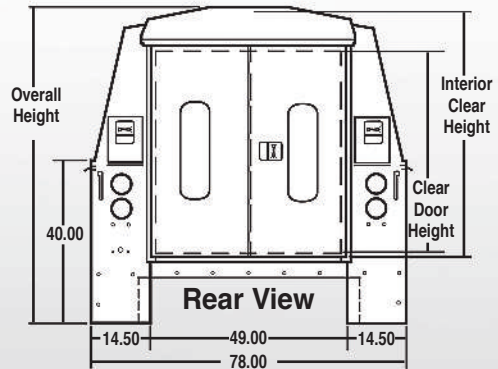
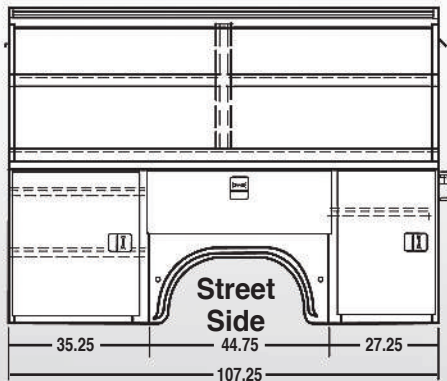

# 60" CA Dual Rear Wheel

Model	Body Length	Body Height	Body Width	Compartment Depth	Clear Door Width	Clear Door Height	Interior Clear Height	Body Weight
KC108L2094J	107.25"	68"	94"	20"	49.5"	41.1"	51.1"	2,093 lb.
KC108M2094J	107.25"	78"	94"	20"	49.5"	50.5"	61.1"	2,112 lb.
KC108H2094J	107.25"	90"	94"	20"	49.5"	63.1"	73.1"	2,232 lb.

Applicable Chassis	Cab	Wheel Base	GVWR
F3G/F3H	Reg.	141"	13,300 lb.
X3G/X3H	Super	162"	13,300 lb.
W3G/W3H	Crew	176"	13,300 lb.
F4G/F4H	Reg.	141"	15,000/16,500 lb.
X4G/X4H	Super	162"	15,000/16,500 lb.
W4G/W4H	Crew	176"	15,000/16,500 lb.
F5G/F5H	Reg.	141"	17,500/19,500 lb.
X5G/X5H	Super	162"	17,500/19,500 lb.
W5G/W5H	Crew	176"	17,500/19,500 lb.

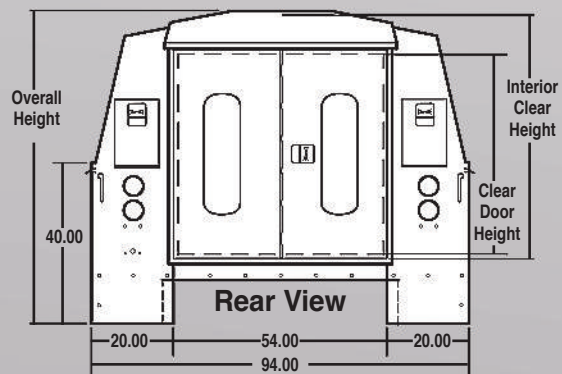
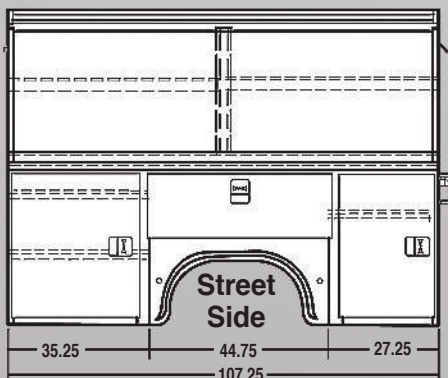

# 84" CA Dual Rear Wheel

Model	Body Length	Body Height	Body Width	Compartment Depth	Clear Door Width	Clear Door Height	Interior Clear Height	Body Weight
KC132L2094J	133.25"	68"	94"	20"	49.5"	41.1"	51.1"	2,506 lb.
KC132M2094J	133.25"	78"	94"	20"	49.5"	50.5"	61.1"	2,532 lb.
KC132H2094J	133.25"	90"	94"	20"	49.5"	63.1"	73.1"	2,652 lb.

Applicable Chassis	Cab	Wheel Base	GVWR
F3G/F3H	Reg.	141"	13,300 lb.
F4G/F4H	Reg.	165"	15,000/16,500 lb.
X4G/F4H	Super	186"	15,000/16,500 lb.
W4G/W4H	Crew	200"	15,000/16,500 lb.
F5G/F5H	Reg.	165"	17,500/19,500 lb.
X5G/X5H	Super	186"	17,500/19,500 lb.
W5G/W5H	Crew	200"	17,500/19,500 lb.

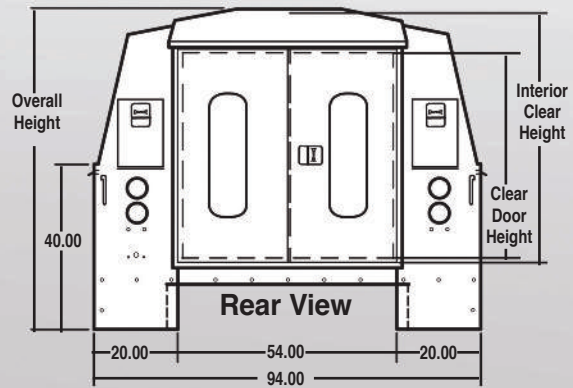
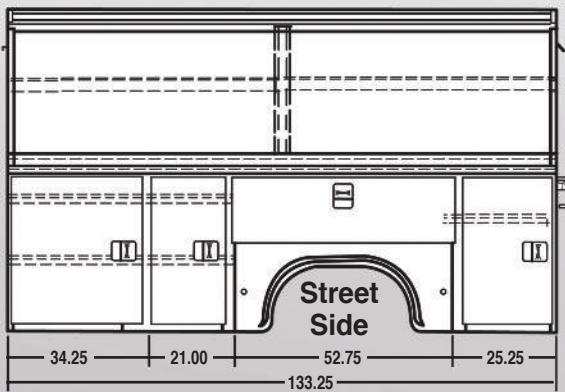

## Because Rust Never Sleeps

Rust shouldn't be a concern when you buy quality Knapheide products. To give you the best protection from rust and corrosion, we installed our state of the art, custom-designed electrodeposition prime paint system. Our E-coat system bonds paint to steel by an electroplating process, to give you a superior coat of primer resulting in better corrosion protection compared to spraying methods. Complete immersion in our E-coat results in a prime coat that provides the best chemical and solvent resistance.

Rust never sleeps, and neither does our E-coat protection so you should never worry about the quality of your Knapheide products.



**KUVcc**

**6**

- No rust through
- Door hinges will not fail or come off body
- Latches and lock cylinders will not fail to operate
- Shelves will not bend under max. load of 250lbs.

**Year Limited Warranty**



# 108" CA Dual Rear Wheel

Model	Body Length	Body Height	Body Width	Compartment Depth	Clear Door Width	Clear Door Height	Interior Clear Height	Body Weight
KC157M2094J	157.25"	78"	94"	20"	49.5"	50.5"	61.1"	2,886 lb.
KC157H2094J	157.25"	90"	94"	20"	49.5"	63.1"	73.1"	3,027 lb.

Applicable Chassis	Cab	Wheel Base	GVWR
F4G/F4H	Reg.	189"	15,000/16,500 lb.
F5G/F5H	Reg.	189"	17,500/19,500 lb.

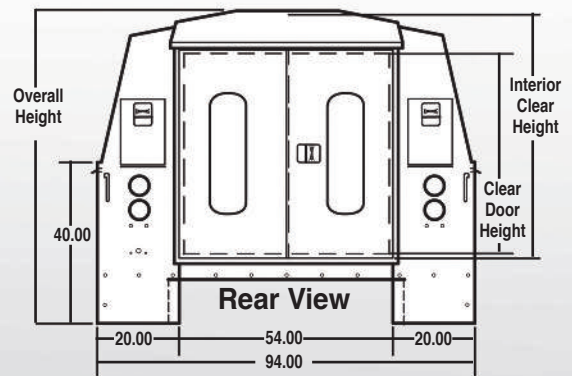
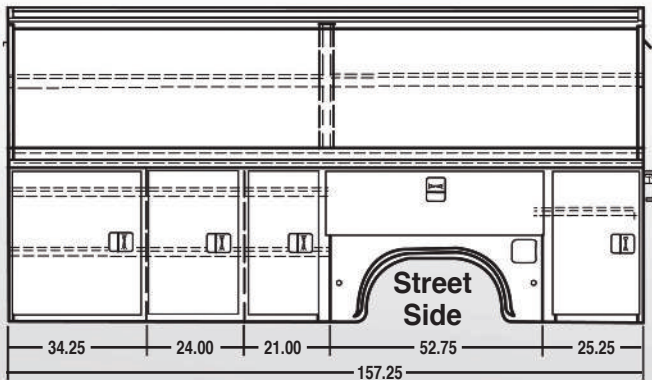

# 120" CA Dual Rear Wheel

Model	Body Length	Body Height	Body Width	Compartment Depth	Clear Door Width	Clear Door Height	Interior Clear Height	Body Weight
KC169M2094J	169.25"	78"	94"	20"	49.5"	50.5"	61.1"	3,063 lb.
KC169H2094J	169.25"	90"	94"	20"	49.5"	63.1"	73.1"	3,215 lb.

Applicable Chassis	Cab	Wheel Base	GVWR
F4G/F4H	Reg.	201"	15,000/16,500 lb.
F5G/F5H	Reg.	201"	17,500/19,500 lb.

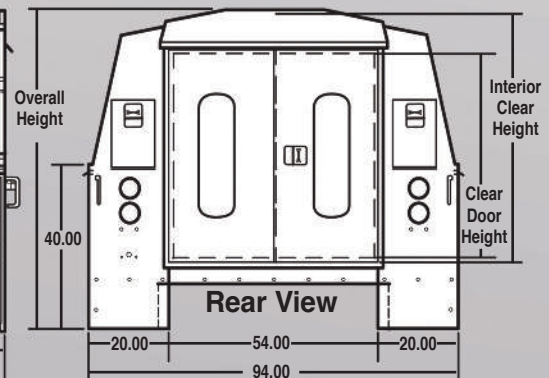
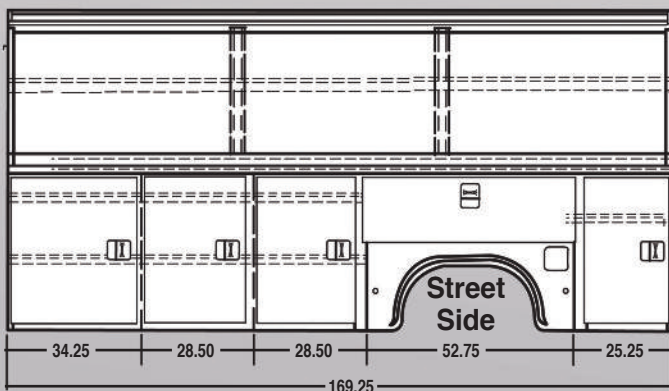

# Popular Options



**Power Locks**



**Codeable Padlock**



**Rear Vision Camera**



**Solid Rear Doors**



**Sortimo**



**Mechanic Drawers**



**Pull Out Tray**



**Cargo Management System**



**Knapliner Bumper**



**Mechanics Vise Bracket**



**Lift Gate**

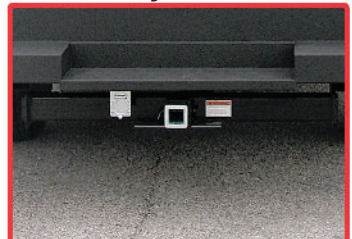

**Class V Reciver Hitch**



**SpitzLift Crane**



**Power Ladder Rack**



**3 Bow Ladder Rack**

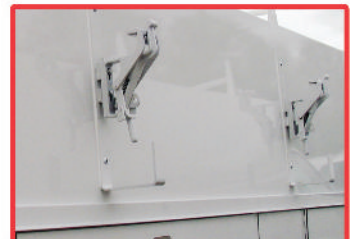

**Side Mount Ladder Rack**



**LED Lights**



**LED Compartment Lighting**



**Wheel Chock Holders**



**Side Access Doors**

The Knapheide Manufacturing Company  
 1848 Westphalia Strasse  
 Quincy, Illinois 62305  
**(217) 222-7131**  
[www.knapheide.com](http://www.knapheide.com)  
[knapheide@knapheide.com](mailto:knapheide@knapheide.com)



**SINCE 1848**

Copyright© 2011 The Knapheide Manufacturing Company

**For more information:**

Specifications subject to change without notice.  
 Some models shown with optional equipment.