

**KEMET**


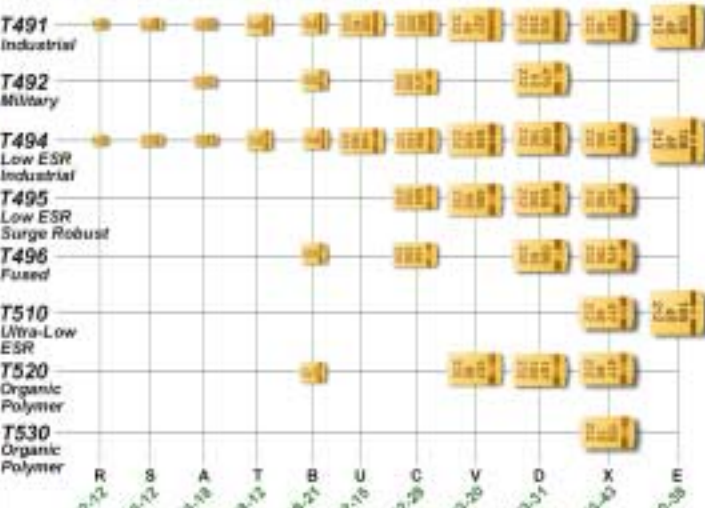


# *Surface Mount Capacitors*

**Capacitor**  **dge**

[www.kemet.com](http://www.kemet.com)

F3102H 04/03

<p><b>ALUMINUM</b>  <b>CHIPS AO-CAP</b>          (Surface Mounted Device) 33-470µF</p> <p><b>A700</b>          Organic Polymer</p>  <p>Case Sizes - KEMET (EIA)</p>	<p><b>TANTALUM</b>  <b>CHIPS</b> (Surface Mounted Device) 0.1-1500µF</p> <p><b>T491</b> Industrial</p> <p><b>T492</b> Military</p> <p><b>T494</b> Low ESR Industrial</p> <p><b>T495</b> Low ESR Surge Robust</p> <p><b>T496</b> Fused</p> <p><b>T510</b> Ultra-Low ESR</p> <p><b>T520</b> Organic Polymer</p> <p><b>T530</b> Organic Polymer</p>  <p>Case Sizes - KEMET (EIA)</p>
<p><b>CERAMIC</b>  <b>CHIPS</b>          (Surface Mounted Device) 0.5pF-22.0µF</p> <p>*0402 *0603 *0805 *1206 *1210</p> <p>CDR01 CDR31 CKS51          CDR32 CDR33 CKS52</p> <p>*1812 *1825 2220 2225 *1632</p> <p>CDR04 CDR34 CDR05 CDR25 CDR06 CKS54          Array</p> <p>*EIA Standard Style</p>	<p><b>CONFORMALLY COATED RADIAL</b>          Golden Max 1µF-6.8µF</p> <p>C315 C320 C322 C323 C326</p> <p>C330 C333 C340 C350</p> <p><b>CONFORMALLY COATED RADIAL</b>          Ultradip T350 Series 0.1-680µF</p> <p>T350 T351 T352 T353 T354 T355 T356</p> <p>T36X Series 0.1-330µF</p> <p>T363 (CX02) T368 T369 (CX12)</p> <p>Ultradip III T396/T398 0.1-680µF</p>
<p><b>CONFORMALLY COATED AXIAL</b>          Aximax 10pF-1µF</p> <p>C410 C412 C420 C430 C440</p> <p><b>MOLDED RADIAL</b> 1pF-1.0µF</p> <p>C052 (CK05) (CKR05) C062 (CK06) (CKR06) C056 (CKR05) C066 (CKR06)</p>	<p><b>MOLDED AXIAL</b> 0.1-330µF</p> <p>T322/T323 (CX01/CX05) A, B, C, D, E, &amp; F Case Sizes</p> <p><b>HERMETICALLY SEALED</b> 0.0047-1200µF</p> <p>T110, T140, T210(GR500), T212(CSR13), T216(CSS13), T222, T240(GR500), T242(CSR23), T252(CSR33), T256, T262(CSR21) Series</p>
<p><b>MOLDED AXIAL</b> 1pF-3.3µF</p> <p>C114 (CK12) (CKR11), C124 (CK13) (CKR12), C192 (CK14) (CKR14), C202 (CK15) (CKR15), C222 (CK16) (CKR16)</p>	<p><b>MOLDED RADIAL</b></p> <p>T330 Series 0.1-220µF</p> <p>T340 Series 0.1-330µF</p> <p><b>MICRON</b> 0.68-220µF</p> <p>T370 Series T378 Series (CX06)</p>

Parts shown are actual size  
 Due to ever changing technology, all series may not be depicted.

**SOLID TANTALUM CHIP CAPACITORS**

	PAGE
GENERAL PERFORMANCE CHARACTERISTICS.....	4-14
T491 SERIES — INDUSTRIAL GRADE .....	15-18
T492 SERIES — CWR11 STYLE PER MIL-PRF-55365/8.....	19-20
T494 SERIES — LOW ESR, INDUSTRIAL GRADE .....	21-23
T495 SERIES — LOW ESR, SURGE ROBUST .....	24-27
T496 SERIES — FAIL-SAFE WITH BUILT-IN FUSE .....	28-29
T510 SERIES — ULTRA-LOW ESR .....	30-32

**POLYMER TANTALUM CHIP CAPACITORS**

	PAGE
GENERAL PERFORMANCE CHARACTERISTICS.....	33-38
T520 SERIES — KO-CAP POLYMER .....	39-41
T530 SERIES — KO-CAP POLYMER - MULTIPLE ANODE.....	42-43

**CERAMIC CHIP CAPACITORS**

	PAGE
GENERAL PERFORMANCE CHARACTERISTICS.....	44-48
CERAMIC CHIP-STANDARD .....	49-54
LAND DIMENSIONS .....	53
THICKNESS CODE REFERENCE CHART.....	54
CERAMIC CAPACITOR ARRAY .....	55-56
MIL-PRF-55681 ESTABLISHED RELIABILITY .....	57-61
MIL-PRF-55681 TAPE AND REEL QUANTITIES .....	61

Mil-PRF-123 and GR900 high-reliability ceramic chips are also available. Refer to KEMET Catalog F-3054 for detailed information.

**TANTALUM & CERAMIC CHIP PACKAGING**

	PAGE
TANTALUM CHIP PACKAGING INFORMATION.....	62
CERAMIC CHIP PACKAGING INFORMATION .....	63
EMBOSSED CARRIER TAPE REELING INFORMATION .....	64-65
PUNCHED CARRIER TAPE (PAPER TAPE) REELING INFORMATION .....	66
BULK CASSETTE PACKAGING .....	67
CERAMIC CHIP MARKING.....	67

**NOTICE**

Although the information in this catalog has been carefully checked for accuracy, and is believed to be correct and current, no warranty, either express or implied, is made as to either its applicability to, or its compatibility with, specific requirements; nor does KEMET Electronics Corporation assume any responsibility for correctness of this information, nor for damages consequent to its use. All design characteristics, specifications, tolerances, and the like are subject to change without notice.

**NOTICE**

Any capacitor misapplied may fail and there by damage other circuit components. Please refer to application notes and recommendations in this catalog for a complete description of capacitor characteristics.



**ISO 9001 Registration**  
The quality management system for manufacture of solid tantalum chips for surface mount applications has satisfied the requirements of ISO 9001.



**ISO 9001 Registration**  
The quality management system for the manufacture of ceramic chips for surface mount applications has satisfied the requirements of ISO 9001.

## PRODUCT DESCRIPTION

KEMET's family of solid tantalum chip capacitors is designed and manufactured with the demanding requirements of surface mount technology in mind.

These devices extend the advantages of solid tantalum technology to today's surface mount circuit applications. Complementing multilayer ceramic chip convenience with capacitance ratings through 1000  $\mu\text{F}$ , tantalum chip capacitors permit circuit designers to take full advantage of the benefits of surface mount technology.

### T491 Series — Industrial

The leading choice in today's surface mount designs is the KEMET T491 Series. This product meets or exceeds the requirements of EIA standard 535BAAC. The physical outline and dimensions of this series conform to this global standard.

Five low profile case sizes have been added to the T491 family. The R/2012-12, S/3216-12 and T/3528-12 case sizes have a maximum height of 1.2 mm. The U/6032-15 size has a maximum height of 1.5 mm, and the V/7343-20 has a maximum height of 2.0 mm.

This product was designed specifically for today's highly automated surface mount processes and equipment. This series uses the same proven solid tantalum KEMET technology acclaimed and respected throughout the world. Added to this is the latest in materials, processes and automation which result in a component unsurpassed worldwide in total performance and value.

The standard solder-coated terminations provide excellent wetting characteristics and compatibility with today's surface mount solder systems. 100% tin terminations are available upon request for any part number. Gold-plated terminations are also available for use with conductive epoxy attachment processes. The symmetrical terminations offer total compliance to provide the thermal and mechanical stress relief required in today's technology. Lead frame attachments to the tantalum pellet are made via a microprocessor-controlled welding operation, and a high temperature silver epoxy adhesive system.

Standard packaging of these devices is tape and reel in accordance with EIA 481-1. This system provides perfect compatibility with all tape-fed placement units.

### T492 Series — Military

KEMET is approved to MIL-PRF-55365/8 (CWR11), Weibull failure rate "D" level or 0.001% failures per 1,000 hours. This CWR11 product — designated as KEMET's T492 Series — is a precision-molded device, with compliant leadframe terminations and indelible laser marking. This is the military version of the global IEC/EIA standard represented by KEMET's T491 Series. Tape and reeling per EIA 481-1 is standard.

### T494 Series — Low ESR, Industrial Grade

The T494 is a low ESR series that is available in all the same case sizes and CV ratings as the popular T491 series. The T494 offers low ESR performance with the economy of an industrial grade device. This series is targeted for output filtering and other applications that may benefit from improved efficiency due to low ESR.

### T495 Series — Low ESR, Surge Robust

The low ESR, surge robust T495 series is an important member of KEMET's tantalum chip family. Designed primarily for output filtering in switch-mode power supplies and DC-to-DC converters, the standard CV T495 values are also an excellent choice for battery-to-ground input filter applications.

This series builds upon proven technology used for industrial grade tantalum chip capacitors to offer several important advantages: very low ESR, high ripple current capability,

excellent capacitance stability, plus improved ability to withstand high inrush currents. These benefits are achieved through a combination of proprietary design, material, and process parameters, as well as high-stress, low impedance electrical conditioning performed prior to screening. Capacitance values range from 4.7  $\mu\text{F}$  to 470  $\mu\text{F}$ , in voltage ratings from 6 to 50.

### T496 Series — Fused

KEMET also offers a "fail-safe" fused solid tantalum chip capacitor. The built-in fuse element provides excellent protection from damaging short circuit conditions in applications where high fault currents exist. Protection from costly circuit damage due to reversed installation is offered with this device. Package sizes include the EIA standard 3528-12, 6032-15, 7343-31, and 7343-43 case size. Capacitance values range from 0.15  $\mu\text{F}$  to 470.0  $\mu\text{F}$ , in voltage ratings from 6 to 50. Standard capacitance tolerances include  $\pm 20\%$  and  $\pm 10\%$ . Tape and reeling per EIA 481-1 is standard.

### T510 Series — Ultra-Low ESR

The ultra-low ESR T510 Series is a breakthrough in solid tantalum capacitor technology. KEMET's T510 Series offers the low ESR in the popular EIA 7343-43 and 7360-38 case sizes. The ultra-low ESR and high ripple current capability make the T510 an ideal choice for SMPS filtering and power decoupling of today's high speed microprocessors.

KEMET has developed an innovative construction platform that incorporates multiple capacitor elements, in parallel, inside a single package. This unique assembly, combined with KEMET's superior processing technology, provides the best combination of high CV, low ESR, and small size in a user friendly, molded, surface mount package.

### T520 SERIES — KO-CAP Polymer Tantalum

The KO-CAP is a Tantalum capacitor, with Ta anode and Ta<sub>2</sub>O<sub>5</sub> dielectric. However, a conductive, organic, polymer replaces the MnO<sub>2</sub> as the cathode plate of the capacitor. This results in very low ESR and improved cap retention at high frequency. The KO-CAP also exhibits a benign failure mode, which eliminates the ignition failures that can occur in standard MnO<sub>2</sub> Tantalum types. Note also that KO-CAPS may be operated at voltages up to 80% of rated voltage with equivalent or better reliability than standard tantalums operated at 50% of rated voltage.

The T520 series captures the best features of multilayer ceramic caps (low ESR and high frequency cap retention), aluminum electrolytics (benign failure mode), and proven solid tantalum technology (volumetric efficiency, surface mount capability, and no wearout mechanism). The KO-CAP can reduce component counts, eliminate through-hole assembly by replacing cumbersome leaded aluminum capacitors, and offer a more cost effective solution to high-cost high-cap ceramic capacitors. These benefits allow the designer to save both board space and money. See pages 32-39 for complete details.

### T530 SERIES — Organic Polymer Multiple Anode

KEMET is offering a multiple anode tantalum chip capacitor with a polymer material replacing the MnO<sub>2</sub> offering non-ignition, self-healing, 125°C performance capability with a higher conductivity materials that lowers the ESR. Packaged as multiple anodes to reduce depth that the signal must penetrate, this parallel arrangement reduces the ESR further still to achieve the highest capacitance and lowest ESR of any other type of SMT capacitor with typical ESR of 7 milliohms. With the reduced ESR, the enhanced capacitance retention in higher frequencies results in the lowest total capacitance solution and provides for the most economical solution in high power applications.

## COMPONENT PERFORMANCE CHARACTERISTICS

### Introduction

KEMET solid tantalum capacitors are identified by the initial "T," followed by a unique "Series" number; for example, T491, T492, etc. Each Series denotes a general physical form and type of encapsulation, as well as limits on dimensions and certain electrical characteristics under standard conditions of 25°C, 50% relative humidity, and one atmosphere pressure. Specific requirements are set forth in the respective Product Series in this catalog. All series are 100% screened for leakage, capacitance, dissipation factor, and ESR. All Series are inspected to electrical limits using a minimum .1% AQL sampling plan, according to the Military Standard MIL-STD-105, even after 100% testing. This sampling plan, to the best of KEMET Electronics' knowledge, meets or exceeds the generally accepted industry standard for similar products. KEMET capacitors may also be supplied, with prior agreement, to meet specifications with requirements differing from those of KEMET catalogs.

## ELECTRICAL

### 1. General Application Class

Solid tantalum capacitors are usually applied in circuits where the AC component is small compared to the DC component. Typical uses known to KEMET Electronics include blocking, by-passing, decoupling, and filtering. They are also used in timing circuits. General purpose devices are recommended to have an external series resistance of 0.1Ω/volt to reduce the failure due to surge current. Newer devices designed for power applications (T495, T5XX), are built to eliminate this series resistance requirement. Because tantalum capacitors can experience scintillation (self-healing) in their life, the circuit impedance should not exceed 100KΩ or this will circumvent the scintillation and degrade leakage.

### 2. Operating Temperature Range

- -55 °C to +125 °C

Voltage derating is specified in Section 5. Performance characteristics over this temperature range are presented within the following sections.

### 3. Non-Operating Temperature Range

- -55 °C to +125 °C

Tantalum capacitors do not lose capacitance from the "de-forming" effect as do liquid-electrolytic capacitors. Storage at high temperature may cause a small, temporary increase in leakage current (measured under standard conditions), but the original value is usually restored within a few minutes after application of rated voltage.

Tantalum chips are not hermetically sealed, therefore they do exhibit reversible changes in parameters with respect to relative humidity (RH). Capacitance increases with increasing humidity. The limiting change, reached upon establishment

of equilibrium with the environment, is approximately -5% to +12% over the range from 25% to 95% RH, referred to the standard 50% RH. The amount of change is dependent upon size (capacitance and voltage rating, ie: CV product); small sizes might change no more than ±5%. Equilibrium at such extremes is seldom attained by plastic-cased capacitors, and the change in capacitance is consequently less. The rate of response to humidity changes increases with increasing temperature. Dissipation factor and ESR also increase with increasing RH.

DC leakage current may rise upon exposure to a combination of high temperature and high humidity, but is normally restored by voltage conditioning under standard conditions. The increase will be greater than that experienced under temperature influence alone because of conduction through absorbed water.

Tantalum chips may be affected by absorption of water on external insulating surfaces. The water film may also attract a layer of dust from the air, increasing the effect. The most sensitive parameter is leakage current.

### 4. Capacitance

- 0.1 μF to 1000 μF

Refer to part number tables for available capacitance ratings and tolerances by series.

Capacitance is measured at 120 Hz, up to 1.0 volt rms maximum and up to 2.5 volts DC maximum, at +25°C. DC bias causes only a small reduction in capacitance, up to about 2% when full rated voltage is applied. DC bias is not commonly used at room temperature, but is more commonly used at elevated temperatures. Capacitance decreases with increasing frequency.

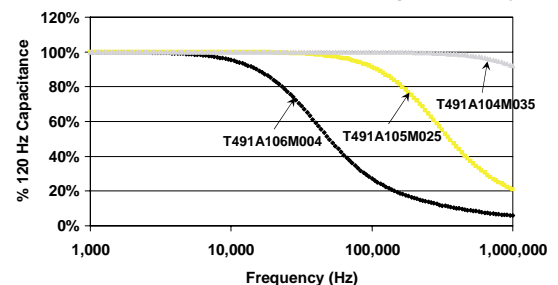


FIGURE 1 Typical Effect of Frequency upon Capacitance

Capacitance increases with increasing temperature.

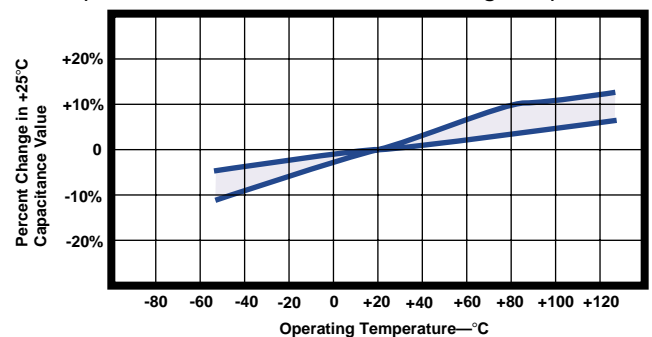


FIGURE 2 Typical Effect of Temperature upon Capacitance

**COMPONENT PERFORMANCE CHARACTERISTICS (con't.)**

**TABLE 1 Maximum Capacitance Change with Temperature (ref: 25 °C)**

Ambient Temperature		
-55°C	+85°C	+125°C
-10%	+10%	*+12% or +15%

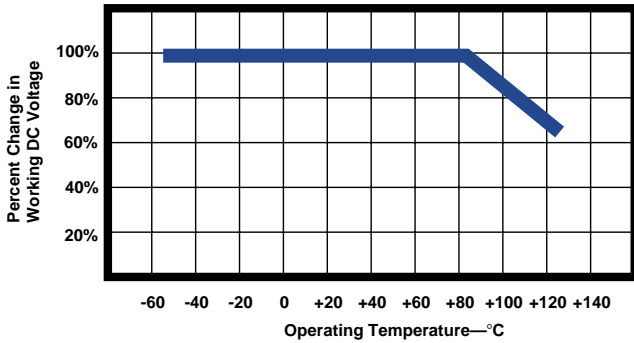
\*+12% is standard. +15% applies to certain extended CV values as noted in part number tables.

**5. Working DC Voltage (WVDC)**

• 3 to 50 volts

Refer to part number tables for available voltage ratings by series.

These voltages are the maximum recommended peak DC operating voltages from -55°C to +85°C for continuous duty. These voltages are derated linearly above +85°C to 2/3 rated voltage for operation at +125°C (See Figure 3). Figure 3 applies to all tantalum including the tantalum polymer series.



**FIGURE 3 Working DC Voltage Change with Temperature**

**6. Surge Voltage**

**TABLE 2 Surge Voltage Ratings at +25°C, +85°C & +125°C**

Rated Working Volts @ +25°C & +85°C	Surge Voltage @ +25°C & +85°C	Derated DC Volts @ +125°C	Surge Voltage @ +125°C
3	4	2	2.4
4	5.2	2.7	3.2
6	8	4	5
10	13	7	8
16	20	10	12
20	26	13	16
25	33	17	20
35	46	23	28
50	65	33	40

Surge voltage is the maximum voltage to which the capacitor can be subjected under transient

conditions, including the sum of peak AC ripple, DC bias and any transients.

Surge voltage tests are performed at +25°C, +85°C and +125°C with the applicable surge voltage. The surge voltage is applied for 1000 cycles of 30 seconds at voltage through a 33 ohm series resistor and 30 seconds off voltage with the capacitor discharged through a 33 ohm resistor. Upon completing the test, the capacitors are allowed to stabilize at room temperature. Capacitance, DCL and DF are then tested:

- Capacitance — within ± 5% of initial value
- DC Leakage — within initial limit
- Dissipation Factor — within initial limit
- ESR — within initial limit

**7. Reverse Voltage and Polarity**

**TABLE 3 Reverse Voltage Ratings**

Temperature	Permissible Reverse Voltage
+25°C	<b>15% of Rated Voltage</b>
+85°C	<b>5% of Rated Voltage</b>
+125°C	<b>1% of Rated Voltage</b>

Solid tantalum capacitors are polarized devices and may be permanently damaged or destroyed if connected with the wrong polarity. The positive terminal is identified on the capacitor body by a stripe and a beveled edge. A small degree of transient reverse voltage is permissible for short periods per Table 3. The capacitors should not be operated continuously in reverse mode, even within these limits.

**8. DC Leakage Current (DCL)**

Refer to part number tables for maximum leakage current limits.

DC leakage current is the current that, after a one-to five-minute charging period, flows through a capacitor when voltage is applied. Leakage is measured at +25°C with full rated DC voltage applied to the capacitor through a 1000 ohm resistor in series with the capacitor.

DC leakage current increases with increasing temperature.

**TABLE 4 Leakage Limit Multipliers at Specified Temperatures (ref: 25 °C limits)**

Ambient Temperature		
-55°C	+85°C	+125°C
N/A	10X	12X

COMPONENT PERFORMANCE CHARACTERISTICS (con't.)

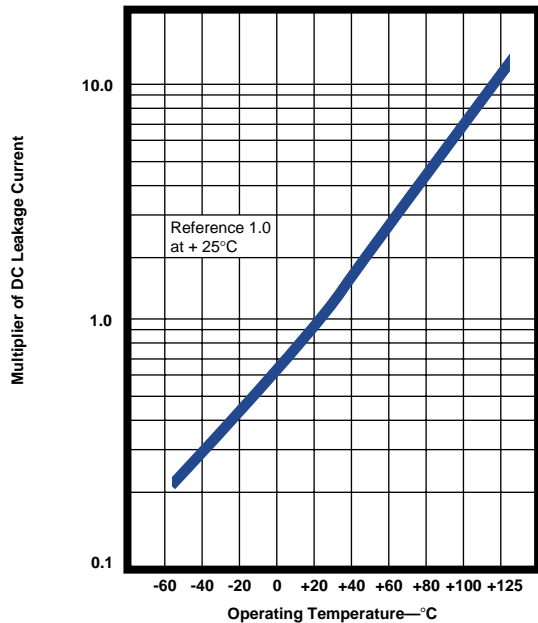


FIGURE 4 Typical Effect of Temperature upon DC Leakage Current

DC leakage current decreases with decreasing applied voltage.

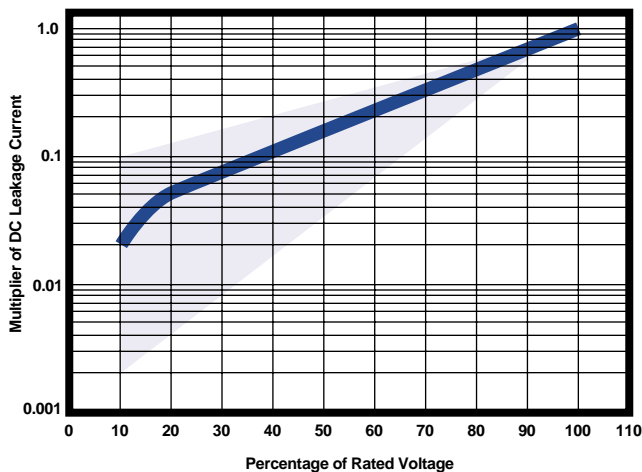


FIGURE 5 Typical Effect of Applied Voltage on DC Leakage Current.

9. Dissipation Factor (DF)

Refer to part number tables for maximum DF limits.

Dissipation factor is measured at 120 Hz, up to 1.0 volt rms maximum, and up to 2.0 volts DC maximum at +25°C. The application of DC bias causes a small reduction in DF, about 0.2% when full rated voltage is applied. DF increases with increasing frequency.

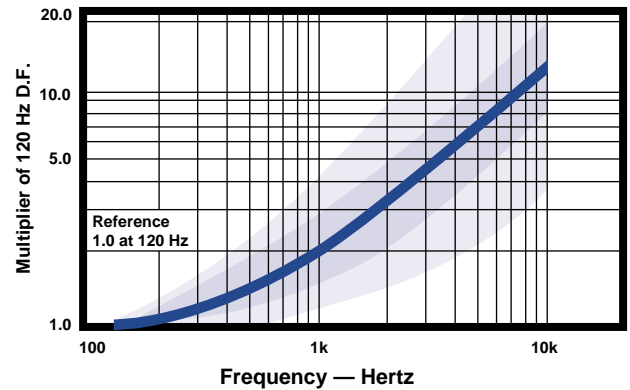


FIGURE 6 Typical Effect of Frequency upon Dissipation Factor

Dissipation factor is a very useful low frequency (120 Hz) measurement of the resistive component of a capacitor. It is the ratio of the equivalent series resistance (ESR) to the capacitive reactance, ( $X_c$ ) and is usually expressed as a percentage. It is directly proportional to both capacitance and frequency. Dissipation factor loses its importance at higher frequencies, (above about 1 kHz), where impedance (Z) and equivalent series resistance (ESR) are the normal parameters of concern.

$$DF = \frac{R}{X_c} = 2\pi fCR$$

DF = Dissipation Factor  
 R = Equivalent Series Resistance (Ohms)  
 $X_c$  = Capacitive Reactance (Ohms)  
 f = Frequency (Hertz)  
 C = Series Capacitance (Farads)

DF is also referred to as  $\tan \delta$  or "loss tangent." The "Quality Factor," "Q," is the reciprocal of DF.

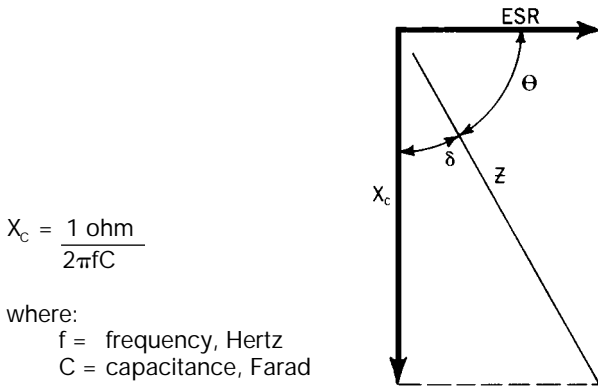
DF increases with temperature above +25°C and may also increase at lower temperatures. Unfortunately, one general limit for DF cannot be specified for all capacitance/voltage combinations, nor can response to temperature be simply stated. DC bias is not commonly used at room temperature, but is more commonly used at elevated temperatures.

10. Equivalent Series Resistance (ESR) and Impedance (Z)

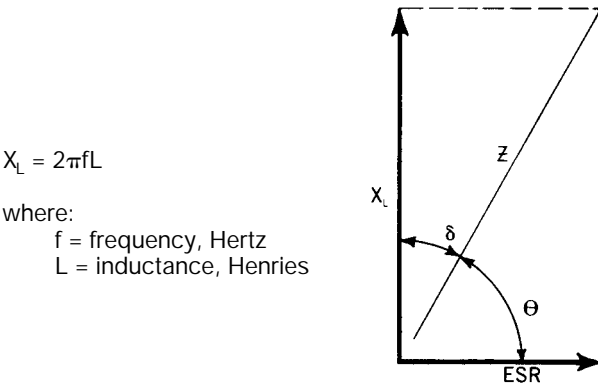
Equivalent Series Resistance (ESR) is the preferred high-frequency statement of the resistance unavoidably appearing in these capacitors. ESR is not a pure resistance, and it decreases with increasing frequency.

Total impedance of the capacitor is the vector sum of capacitive reactance ( $X_c$ ) and ESR, below resonance; above resonance total impedance is the vector sum of inductive reactance ( $X_L$ ) and ESR.

**COMPONENT PERFORMANCE CHARACTERISTICS (con't.)**

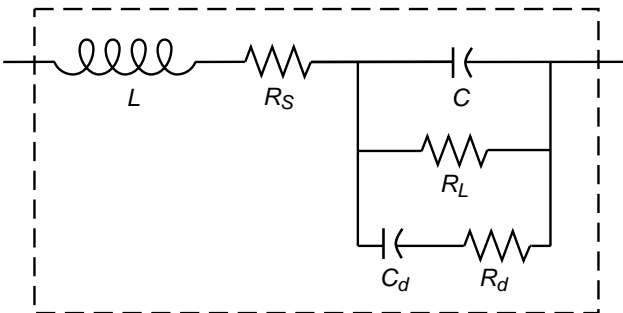


**FIGURE 7a Total Impedance of the Capacitor Below Resonance**



**FIGURE 7b Total Impedance of the Capacitor Above Resonance**

To understand the many elements of a capacitor, see Figure 8.



**FIGURE 8 The Real Capacitor**

A capacitor is a complex impedance consisting of many series and parallel elements, each adding to the complexity of the measurement system.

L — Represents lead wire and construction inductance. In most instances (especially in solid tantalum and monolithic ceramic capacitors) it is insignificant at the basic measurement frequencies of 120 and 1000 Hz.

$R_s$  — Represents the actual ohmic series resistance in series with the capacitance. Lead wires and capacitor electrodes are contributing sources.

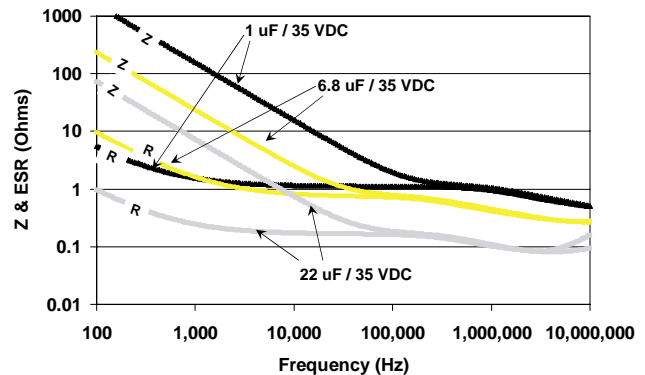
$R_L$  — Capacitor Leakage Resistance. Typically it can reach 50,000 megohms in a tantalum capacitor. It can exceed  $10^{12}$  ohms in monolithic ceramics and in film capacitors.

$R_d$  — The dielectric loss contributed by dielectric absorption and molecular polarization. It becomes very significant in high frequency measurements and applications. Its value varies with frequency.

$C_d$  — The inherent dielectric absorption of the solid tantalum capacitor which typically equates to 1-2% of the applied voltage.

As frequency increases,  $X_c$  continues to decrease according to its equation above. There is unavoidable inductance as well as resistance in all capacitors, and at some point in frequency, the reactance ceases to be capacitive and becomes inductive. This frequency is called the self-resonant point. In solid tantalum capacitors, the resonance is damped by the ESR, and a smooth, rather than abrupt, transition from capacitive to inductive reactance follows.

Typical ESR/Z frequency response curves are shown in Figures 9a and 9b. These curves are for selected ratings and represent typical T491 Series performance. Maximum limits for 100 kHz ESR are listed in the part number tables for each series. Note that the T494 Series offers low ESR and the T495 Series is specially designed for very low ESR performance. Refer to pages 21 and 24 for more information. See also KEMET's T510 Series low ESR ratings on page 29.



**FIGURE 9a ESR & Impedance (Z) vs Frequency**



## COMPONENT PERFORMANCE CHARACTERISTICS (con't.)

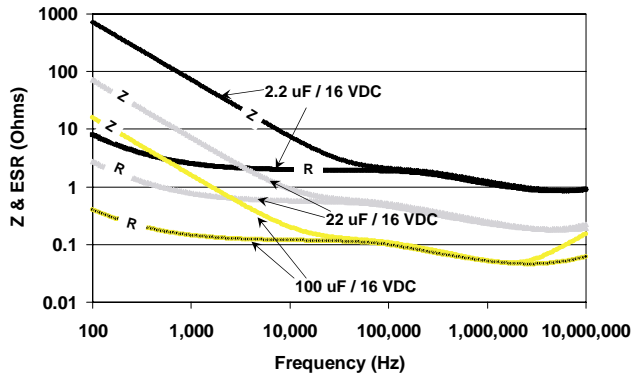


FIGURE 9b ESR & Impedance (z) vs Frequency

ESR and Z are also affected by temperature. At 100 kHz, ESR decreases with increasing temperature. The amount of change is influenced by the size of the capacitor and is generally more pronounced on smaller ratings.

### Multiplier of 100kHz ESR

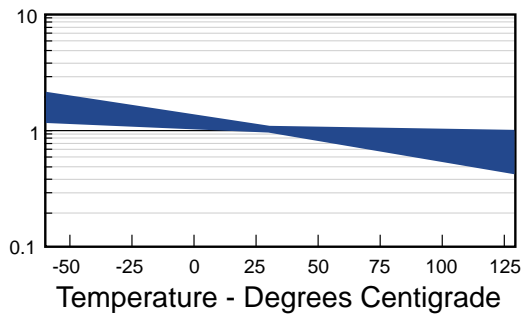


FIGURE 10 Typical Effect of Temperature on 100 kHz ESR

## 11. AC Power Dissipation

Power dissipation is a function of capacitor size and materials. Maximum power ratings have been established for all case sizes to prevent overheating. In actual use, the capacitor's ability to dissipate the heat generated at any given power level may be affected by a variety of circuit factors. These include board density, pad size, heat sinks and air circulation.

TABLE 5 Tantalum Chip Power Dissipation Ratings

Case Code		Maximum Power Dissipation mW @ +25°C w/+20°C Rise
KEMET	EIA	
R	2012-12	25
S	3216-12	60
T	3528-12	70
U	6032-15	90
V	7343-20	125
A	3216-18	75
B	3528-21	85
C	3062-28	110
D	7343-31	150
X	7343-43	165
E	7260-38	200
T530D	7343-31	255
T510X, T530X	7343-43	270
T510E, T530E	7260-38	285

## 12. AC Operation

Permissible AC ripple voltage and current are related to equivalent series resistance (ESR) and power dissipation capability.

Permissible AC ripple voltage which may be applied is limited by three criteria:

- The positive peak AC voltage plus the DC bias voltage, if any, must not exceed the DC voltage rating of the capacitor.
- The negative peak AC voltage, in combination with the bias voltage, if any, must not exceed the permissible reverse voltage ratings presented in Table 3.
- The power dissipated in the ESR of the capacitor must not exceed the appropriate value specified in Table 5.

Actual power dissipated may be calculated from the following:

$$P = I^2 R$$

$$\text{Substituting } I = \frac{E}{Z}, \quad P = \frac{E^2 R}{Z^2}$$

where:

I = rms ripple current (amperes)

E = rms ripple voltage (volts)

P = power (watts)

Z = impedance at specified frequency (ohms)

R = equivalent series resistance at specified frequency (ohms)

Using P max from Table 5, maximum allowable rms ripple current or voltage may be determined as follows:

$$I (\text{max}) = \sqrt{P \text{ max}} / R \quad E (\text{max}) = Z \sqrt{P \text{ max}} / R$$

These values should be derated at elevated temperatures as follows:

Temperature	Derating Factor
85°C	.9
125°C	.4

## ENVIRONMENTAL

### 13. Temperature Stability

TABLE 6 Temperature Stability Limits

Step No.	Temp.	Δ Capacitance	Leakage Current	Dissipation Factor
1	+25°C	within specified tolerance	within original limit	within original limit
2	-55°C	within ± 10% of initial value	N/A	within original limit**
3	+25°C	within ± 5% of initial value	within original limit	within original limit**
4	+ 85°C	within ± 10% of initial value	within 10X original limit	within original limit***
5	+125°C	*within ± 12% or 20% of initial value	within 12X original limit	within original limit***
6	+25°C	within ± 5% of initial value	within original limit	within original limit

\*+12% is standard. +15% or +20% applies to certain extended CV values as noted in part number table.

\*\*within 1.5x initial limit for extended CV values.

\*\*\*within 1.15x initial limit for extended CV values.

## COMPONENT PERFORMANCE CHARACTERISTICS (con't.)

Mounted capacitors withstand extreme temperature testing at a succession of continuous steps at +25°C, -55°C, +25°C, +85°C, +125°C, +25°C, in the order stated. Capacitors shall be brought to thermal stability at each test temperature. Capacitance, DF and DCL are measured at each test temperature except that DCL is not measured at -55°C. DC bias of 2.0± 0.5 is recommended for the capacitance and D F requirements.

### 14. Thermal Shock

#### • Mil-Std-202, Method 107, Condition B

Minimum temperature -55°C, mounted

Post Test Performance:

- Capacitance — within ±5% of initial value
- DC Leakage — within initial limit
- Dissipation Factor — within initial limit
- ESR — within initial limit

### 15. Moisture Resistance

#### • Mil-Std-202, Method 106

Steps 7a and 7b excluded, rated voltage, 42 cycles, mounted

Post Test Performance:

- Capacitance — within ±10% of initial value
- DC Leakage — within initial limit
- Dissipation Factor — within initial limit
- ESR — within initial limit

### 16. Electrostatic Discharge (ESD)

#### • Human Body Model

*2,000 ±50 volts, 1,500 ±5% ohms, 40 nanosecond pulse each polarity, 1 pulse each polarity, 5 seconds between pulses, +25°C.*

#### • Charged Device Model

*200 ± 5 volts, 0 ohms, 40 nanosecond pulse, each polarity, 9 pulses each polarity, 5 seconds between pulses, +25°C.*

Product subjected to above test condition demonstrate *no sensitivity* to electrostatic discharge.

### 17. Long Term Stability

Within the general class of electrolytic capacitors, solid tantalum capacitors offer unusual stability of the three important parameters: capacitance, dissipation factor and leakage current. These solid-state devices are not subject to the effects of electrolysis, deforming or drying-out associated with liquid-electrolyte capacitors.

When stabilized for measurement at standard conditions, capacitance will typically change less than ±3% during a 10,000 hour life test +85°C.

The same comparative change has been observed in shelf tests at +25°C extending for 50,000 hours. (Some of this change may stem from instrument or fixture error.)

Dissipation factor exhibits no typical trend. Data from 10,000 hour life test at +85°C show that initial limits (at standard conditions) are not exceeded at the conclusion of these tests.

Leakage current is more variable than capacitance or DF; in fact, leakage current typically exhibits a logarithmic dependence in several respects. Military Specifications permit leakage current (measured at standard conditions) to rise by a factor of four over 10,000 hour life tests. Typical behavior shows a lower rate of change, which may be negative or positive. Initial leakage currents are frequently so low (less than 0.1 nanoampere in the smallest CV capacitors) that changes of several orders of magnitude have no discernable effect on the usual circuit designs.

### 18. Failure Mode

Capacitor failure may be induced by exceeding the rated conditions of forward DC voltage, reverse DC voltage, surge current, power dissipation, or temperature. As with any practical device, these capacitors also possess an inherent, although low, failure rate when operated within the rated condition.

The dominant failure mode is by short-circuit. Minor parametric drifts are of no consequence in circuits suitable for solid tantalum capacitors. Catastrophic failure occurs as an avalanche in DC leakage current over a short (millisecond) time span. The failed capacitor, while called "short-circuited", may exhibit a DC resistance of 10 to 10<sup>4</sup> ohm.

If a failed capacitor is in an unprotected low-impedance circuit, continued flow of current through the capacitor may obviously produce severe overheating. The over-heated capacitor may damage the circuit board or nearby components. Protection against such occurrence is obtained by current-limiting devices or fuses provided by the circuit design. KEMET's T496 series offers a built-in fuse to convert the normal short circuit failure mode to an open circuit.

Fortunately, the inherent failure rate of KEMET solid tantalum capacitors is low, and this failure rate may be further improved by circuit design. Statistical failure rates are provided for military capacitors. Relating circuit conditions to failure rate is aided by the guides in the section following.

## COMPONENT PERFORMANCE CHARACTERISTICS (con't.)

### RELIABILITY

#### 19. Reliability Prediction

Solid tantalum capacitors exhibit no degradation failure mode during shelf storage and show a constantly decreasing failure rate (i.e., absence of any wear out mechanism) during life tests. This failure rate is dependent upon three important application conditions; DC Voltage, ambient temperature, and circuit impedance. Additional effects are attributable to the capacitance of the device and atmospheric and mechanical exposure of the assembled circuit. The 1000 multiplier at the end converts the failure rate to parts-per-billion piece-hours. A prediction of the failure rate can be made using these application conditions and the formulas and tables listed in MIL-HDBK-217F (Notice 2).

**Base Multiplier:** The first multiplier is the base multiplier (2) established for the capacitor type. For "CWR-Chips" or surface mount components the base multiplier is 0.00005, and for "CSR-Leaded" devices, the base multiplier is 0.00040.

**Temperature:** The temperature factor is given as (3). From this formula, it can be seen that the unity factor, or 1, is derived at an ambient temperature of +25°C (+298°K), and that at temperatures below this the multiplier is decreasing and at temperatures above this the multiplier is increasing.

**Voltage:** The multiplier for application voltage (4) is a two step process: first, the application voltage is compared to 60% of rated voltage, and then this ratio is raised to an exponential power of 17 and added to unity. Consider applications of 50%, 60%, 70%, 80% and 90% of rated voltage. The multipliers for these applications would be 1.045, 2.00, 14.7, 134, and 986, respectively. From these results it is evident why manufacturers recommend application voltages not to exceed 50% rated voltages.

**Capacitance:** There is a factor (5) applied to the capacitance (in µF) which effectively increases the failure rate for increasing capacitance (increases in effective area resulting in increases in possible faults).

**Series Resistance:** The series resistance is only concerned with the resistance per application bias (ohms per volt) external to the capacitor, and does not include the ESR as a factor.

**Environmental:** The environmental factor is determined by the harshness of the ambient conditions beyond temperature. An explanation of these ratings is included in the MIL specification and are too extensive to be covered here. In most cases, this factor is set to ground benign or G<sub>B</sub>, with the resulting factor equal to "1".

- (1)  $\lambda_v = \lambda_b \pi_T \pi_C \pi_V \pi_{SR} \pi_Q \pi_E \times 1000$
- (2)  $\lambda_b = 0.00005_{CWR} \text{ or } 0.0004_{CSR}$
- (3)  $\pi_T = \exp \left[ \frac{-0.15}{8.617 \cdot 10^{-5}} \left( \frac{1}{T_{Amb}} - \frac{1}{298} \right) \right]$
- (4)  $S = \frac{\text{Application-Voltage}}{\text{Rated-Voltage}} \quad \pi_V = \left( \frac{S}{0.6} \right)^{17} + 1$
- (5)  $\pi_C = 1.0 \cdot C^{.023}$
- (6)  $\pi_{SR} = \text{Lookup Table} \quad \pi_E = \text{Lookup Table}$
- (7)  $\pi_Q = \sqrt[4]{\left( \frac{\text{Pcs. Fail}}{\text{Pcs. Tested} \times \text{Hrs. Tested}} \times 100,000 \right)}$

FIGURE 11a. MIL-HDBK-217F Notice 2 formulas.

CR (ΩV)	π <sub>SR</sub>
>0.8	0.66
0.6-0.8	1.0
0.4-0.6	1.3
0.2-0.4	2.0
0.1-0.2	2.7
<0.1	3.3

FIGURE 11b. Table for circuit resistance multipliers.

**Quality Factor:** All of these multipliers are applied to the established or base failure rate of the part. The T492 Series is qualified under U.S. military specification MIL-PRF-55365. Failure rates as low as 0.001% kHr are available under this test program.

For series not covered by military specifications, an internal sampling program is operated by KEMET Quality Assurance whereby parts are put on life test at rated voltage for 2000 hours. The confidence level chosen for the reporting data is 60%. (The cost of sampling each batch would be prohibitive, and no claim is made to guarantee the failure rate of each batch.) With this testing and each new qualification test for new parts, the average failure rate for all commercial Series lies between 0.1% and 1.0% per thousand-piece-hours.

#### FIT Calculator

All of these factors are gathered into a Windows based software, available free from the KEMET web site (www.kemet.com). The "FIT Calculator" software does all the calculations and look-ups based on information entered or selected by the operator. A manual may also be downloaded from the same web page to explain the controls and displays. The manual as well as a help screen also detail the environmental conditions.

**COMPONENT PERFORMANCE CHARACTERISTICS (con't.)**

**20. Surge Current**

All conventional reliability testing is conducted under steady-state DC voltage. Experience indicates that AC ripple, within the limits prescribed, has little effect on failure rate. Heavy surge currents are possible in some applications, however. Circuit impedance may be very low (below the recommended 0.1 ohm/volt) or there may be driving inductance to cause voltage "ringing." Surge current may appear during turn-on of equipment, for example. Failure rate under current-surge conditions may not be predictable from conventional life test data.

Capacitors are capable of withstanding a 4 ±1 second charge of rated voltage (±2%) through a total circuit resistance (excluding the capacitor) of 1 ±0.2 ohms at +25°C, followed by a 4 ±1 second discharge to a voltage below 1% of the rated voltage. This cycle is repeated consecutively three (3) times. Post test performance:

- a. Capacitance — within ±5% of initial value
- b. DC Leakage — within initial limit
- c. Dissipation Factor — within initial limit

100% production surge current testing is performed on all Tantalum Chip series for case sizes C, D, E, X, U, V. The total test circuit resistance is ≤ 0.5 ohms. The applied voltage is 75% of rated voltage for all series except the T495 and T510 which are surged at 100% of rated voltage. Four surge cycles are applied. Parts not capable of surviving this test are removed at subsequent electrical screening.

**21. Storage Life Test**

- **2,000 hours, +125°C, Unbiased, Mounted**

Post Test Performance:

- a. Capacitance — within ±10% of initial value
- b. DC Leakage — within initial limit
- c. Dissipation Factor — within initial limit
- d. ESR — within initial limit
- e. Physical — no degradation of function

**22. Standard Life Test**

- **2,000 hours, +85°C, Rated Voltage, Mounted**

Post Test Performance:

- a. Capacitance — within ±10% of initial value
- b. DC Leakage — within 125% of initial limit
- c. Dissipation Factor — within initial limit
- d. ESR — within initial limit
- e. Physical — no degradation of function

**23. High Temperature Life Test**

- **2,000 hours, +125°C, 2/3 Rated Voltage, Mounted**

Post Test Performance:

- a. Capacitance — within ±10% of initial value
- b. DC Leakage — within 125% of initial limit
- c. Dissipation Factor — within initial limit
- d. ESR — within initial limit
- e. Physical — no degradation of function

**MECHANICAL**

**24. Resistance to Solvents**

- **Mil-Std-202, Method 215**

Post Test Performance:

- a. Capacitance — within ±10% of initial value
- b. DC Leakage — within initial limit
- c. Dissipation Factor — within initial limit
- d. Physical — no degradation of case, terminals or marking.

**25. Fungus**

- **Mil-Std-810, Method 508**

**26. Flammability**

- **UL94 VO Classification**

Encapsulant materials meet this classification.

**27. Resistance to Soldering Heat**

- **Wave Solder**  
**+260 ±5°C, 10 Seconds**
- **Infrared Reflow**  
**+230 ±5°C, 30 Seconds**
- **Vapor Phase Reflow**  
**+215 ±5°C, 2 minutes**

Post Test Performance:

- a. Capacitance — within ±10% of Initial Value
- b. DC Leakage — within Initial Limit
- c. Dissipation Factor — within Initial Limit

**28. Solderability**

- **Mil-Std-202, Method 208**
- **ANSI/J-STD-002, Test B**

Applies to Solder and Tin Coated terminations only. Does not apply to optional gold-plated terminations.

**29. Vibration**

- **Mil-Std-202, Method 204, Condition D, 10 Hz to 2,000 Hz, 20G Peak**

Post Test Performance:

- a. Capacitance — within ± 10% of initial value
- b. DC Leakage — within initial limit
- c. Dissipation Factor — within initial limit

**30. Shock**

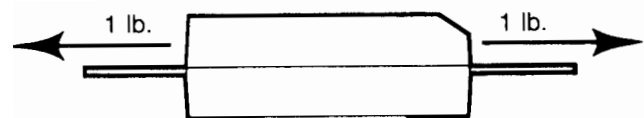
- **Mil-Std-202, Method 213, Condition I, 100 G Peak**

Post Test Performance:

- a. Capacitance — within ±10% of initial value
- b. DC Leakage — within initial limit
- c. Dissipation Factor — within initial limit

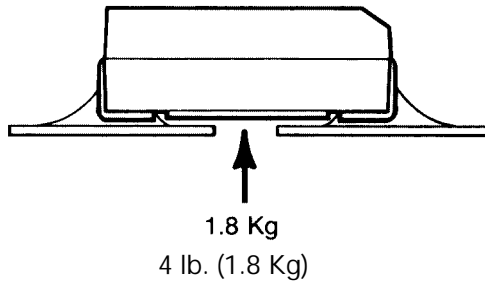
**31. Terminal Strength**

- **Pull Force**  
• **One Pound (454 grams), 30 Seconds**



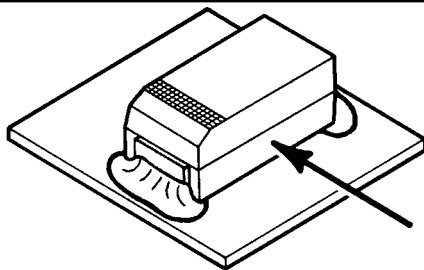
## COMPONENT PERFORMANCE CHARACTERISTICS (con't.)

- **Tensile Force**
- **Four Pounds (1.8 kilograms), 60 Seconds**



- **Shear Force**
- Table 8 Maximum Shear Loads**

Case Code		Maximum Shear Loads	
KEMET	EIA	Kilograms	Pounds
R	2012-12	2.4	5.3
S	3216-12	3.2	7.0
T	3528-12	3.6	8.0
U	6032-15	4.5	10.0
V	7343-20	5.0	11.0
A	3216-18	3.2	7.0
B	3528-21	3.6	8.0
C	6032-28	4.5	10.0
D	7343-31	5.0	11.0
X	7343-43	5.0	11.0
E	7260-38	5.0	11.0



Post Test Performance:

- Capacitance — within  $\pm 5\%$  of initial value
- DC Leakage — within initial limit
- Dissipation Factor — within initial limit

## APPLICATIONS

### 32. Handling

Automatic handling of encapsulated components is enhanced by the molded case which provides compatibility with all types of high speed pick and place equipment. Manual handling of these devices presents no unique problems. Care should be taken with your fingers, however, to avoid touching the solder-coated terminations as body oils, acids and salts will degrade the solderability of these terminations. Finger cots should be used whenever manually handling all solderable surfaces.

### 33. Termination Coating

The standard finish coating for all molded series is 90/10 Sn/Pb solder (Tin/Lead-solder coated).

For conductive adhesive attachment processes,

a gold termination finish is available, at additional cost, on the T491, T494 and T495 Series only. The gold finish is not recommended for solder attachment.

For Pb-free soldering processes, we offer a 100% reflowed tin (Sn) termination finish.

### 34. Recommended Mounting Pad Geometries

Proper mounting pad geometries are essential for successful solder connections. These dimensions are highly process sensitive and should be designed to maximize the integrity of the solder joint, and to minimize component rework due to unacceptable solder joints.

Figure 12 illustrates pad geometry. Tables 9 & 10 provide recommended pad dimensions for both wave and reflow soldering techniques. These dimensions are intended to be a starting point for circuit board designers, to be fine tuned, if necessary, based upon the peculiarities of the soldering process and/or circuit board design.

Contact KEMET for Engineering Bulletin Number F-2100 entitled "Surface Mount Mounting Pad Dimensions and Considerations" for further details on this subject.

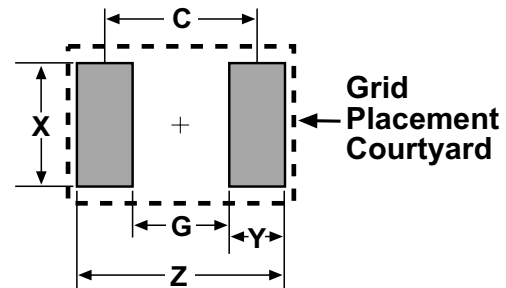


Figure 12

Table 9 – Land Pattern Dimensions for Reflow Solder

KEMET/EIA Size Code	Pad Dimensions - mm				
	Z	G	X	Y (ref)	C (ref)
R/2012-12	3.90	0.80	1.80	1.55	2.35
A/3216-18, S/3216-12	4.70	0.80	1.50	1.95	2.75
B/3528-21, T/3528-12	5.00	1.10	2.50	1.95	3.05
C/6032-28, U/6032-15	7.60	2.50	2.50	2.55	5.05
D/7343-31, V/7343-20, X/7343-43	8.90	3.80	2.70	2.55	6.35
E/7260-38	8.90	3.80	4.40	2.55	6.35

Table 10 – Land Pattern Dimensions for Wave Solder

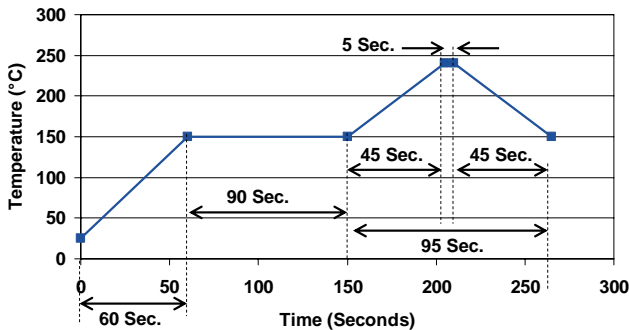
KEMET/EIA Size Code	Pad Dimensions - mm				
	Z	G	X	Y (ref)	C (ref)
R/2012-12	4.30	0.80	1.26	1.75	2.55
A/3216-18, S/3216-12	5.10	0.80	1.10	2.15	2.95
B/3528-21, T/3528-12	5.40	1.10	1.80	2.15	3.25
C/6032-28, U/6032-15	8.00	2.50	1.80	2.75	5.25
D/7343-31, V/7343-20, X/7343-43	9.70	3.80	2.70	2.95	6.75
E/7260-38	9.70	3.80	4.40	2.95	6.75

**COMPONENT PERFORMANCE CHARACTERISTICS (con't.)**

**35. Soldering**

KEMET's families of surface mount tantalum capacitors are compatible with wave (single or dual) soldering and IR or vapor phase reflow techniques. Solder-coated terminations have excellent wetting characteristics for high integrity solder fillets. Preheating of these components is recommended to avoid extreme thermal stress. The maximum recommended preheat rate is 2°C per second. Figure 13 represents recommended maximum solder temperature / time combinations for these devices.

Note that although the X/7343-43 case size can withstand wave soldering, the tall profile (4.3mm maximum) dictates care in wave process development.



**FIGURE 13 Time/Temperature Soldering Profile**

Hand-soldering should be performed with care due to the difficulty in process control. If performed, care should be taken to avoid contact of the soldering iron to the molded case. The iron should be used to heat the solder pad, applying solder between the pad and the termination, until reflow occurs. The iron should be removed. "Wiping" the edges of a chip and heating the top surface is not recommended.

During typical reflow operations a slight darkening of the gold-colored epoxy may be observed.

This slight darkening is normal and is not harmful to the product. Marking permanency is not affected by this change.

**36. Washing**

Standard washing techniques and solvents are compatible with all KEMET surface mount tantalum capacitors. Solvents such as Freon TMC and TMS, Trichlorethane, methylene chloride, prelete, and isopropyl alcohol are not harmful to these components.

If ultrasonic agitation is utilized in the cleaning process, care should be taken to minimize energy levels and exposure times to avoid damage to the terminations.

KEMET tantalum chips are also compatible with newer aqueous and semi-aqueous processes. Please follow the recommendations for cleaning as defined by the solder vendor.

**37. Encapsulations**

Under normal circumstances, potting or encapsulation of KEMET tantalum chips is not required.

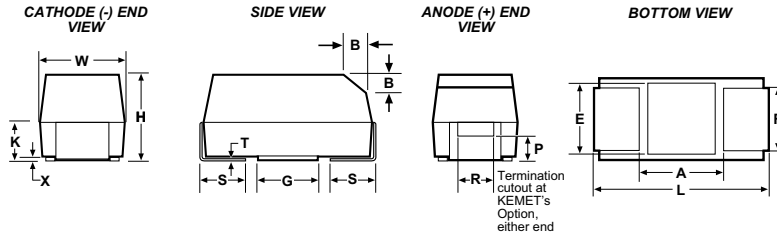
**38. Storage Environment**

Tantalum chip capacitors should be stored in normal working environments. While the chips themselves are quite robust in other environments, solderability will be degraded by exposure to high temperatures, high humidity, corrosive atmospheres, and long term storage. In addition, packaging materials will be degraded by high temperature – reels may soften or warp, and tape peel force may increase. KEMET recommends that maximum storage temperature not exceed 40 degrees C, and maximum storage humidity not exceed 60% relative humidity. In addition, temperature fluctuations should be minimized to avoid condensation on the parts, and atmospheres should be free of chlorine and sulfur bearing compounds. For optimized solderability, chip stock should be used promptly, preferably within 1.5 years of receipt.

### FEATURES

- Meets or Exceeds EIA Standard 535BAAC
- Taped and Reeled per EIA 481-1
- Symmetrical, Compliant Terminations
- Optional Gold-plated Terminations
- Laser-marked Case
- 100% Surge current test on C, D, E, U, V, X sizes
- Capacitance: 0.1  $\mu\text{F}$  to 1000  $\mu\text{F}$
- Tolerance:  $\pm 10\%$ ,  $\pm 20\%$
- Voltage: 3-50 VDC
- Extended Range Values
- New Low Profile Case Sizes

### CAPACITOR OUTLINE DRAWING



### STANDARD T491 DIMENSIONS

Millimeters (inches)

CASE SIZE		COMPONENT													
KEMET	EIA	L*	W*	H*	K* $\pm 0.20$ $\pm (.008)$	F* $\pm 0.1$ $\pm (.004)$	S* $\pm 0.3$ $\pm (.012)$	B $\pm 0.15$ $(\text{Ref}) \pm (.006)$	X (Ref)	P (Ref)	R (Ref)	T (Ref)	A (Min)	G (Ref)	E (Ref)
A	3216-18	3.2 $\pm 0.2$ (.126 $\pm .008$ )	1.6 $\pm 0.2$ (.063 $\pm .008$ )	1.6 $\pm 0.2$ (.063 $\pm .008$ )	0.9 (.035)	1.2 (.047)	0.8 (.031)	0.4 (.016)	0.10 $\pm 0.10$ (.004 $\pm .004$ )	0.4 (.016)	0.4 (.016)	0.13 (.005)	0.8 (.031)	1.1 (.043)	1.3 (.051)
B	3528-21	3.5 $\pm 0.2$ (.138 $\pm .008$ )	2.8 $\pm 0.2$ (.110 $\pm .008$ )	1.9 $\pm 0.2$ (.075 $\pm .008$ )	1.1 (.043)	2.2 (.087)	0.8 (.031)	0.4 (.016)	0.10 $\pm 0.10$ (.004 $\pm .004$ )	0.5 (.020)	1.0 (.039)	0.13 (.005)	1.1 (.043)	1.8 (.071)	2.2 (.087)
C	6032-28	6.0 $\pm 0.3$ (.236 $\pm .012$ )	3.2 $\pm 0.3$ (.126 $\pm .012$ )	2.5 $\pm 0.3$ (.098 $\pm .012$ )	1.4 (.055)	2.2 (.087)	1.3 (.051)	0.5 (.020)	0.10 $\pm 0.10$ (.004 $\pm .004$ )	0.9 (.035)	1.0 (.039)	0.13 (.005)	2.5 (.098)	2.8 (.110)	2.4 (.094)
D	7343-31	7.3 $\pm 0.3$ (.287 $\pm .012$ )	4.3 $\pm 0.3$ (.169 $\pm .012$ )	2.8 $\pm 0.3$ (.110 $\pm .012$ )	1.5 (.059)	2.4 (.094)	1.3 (.051)	0.5 (.020)	0.10 $\pm 0.10$ (.004 $\pm .004$ )	0.9 (.035)	1.0 (.039)	0.13 (.005)	3.8 (.150)	3.5 (.138)	3.5 (.138)
X	7343-43	7.3 $\pm 0.3$ (.287 $\pm .012$ )	4.3 $\pm 0.3$ (.169 $\pm .012$ )	4.0 $\pm 0.3$ (.157 $\pm .012$ )	2.3 (.091)	2.4 (.094)	1.3 (.051)	0.5 (.020)	0.10 $\pm 0.10$ (.004 $\pm .004$ )	1.7 (.067)	1.0 (.039)	0.13 (.005)	3.8 (.150)	3.5** (.138)	3.5** (.138)
E	7260-38	7.3 $\pm 0.3$ (.287 $\pm .012$ )	6.0 $\pm 0.3$ (.236 $\pm .012$ )	3.6 $\pm 0.2$ (.142 $\pm .008$ )	2.3 (.091)	4.1 (.161)	1.3 (.051)	0.5 (.020)	0.10 $\pm 0.10$ (.004 $\pm .004$ )	0.9 (.035)	1.0 (.039)	0.13 (.005)	3.8 (.150)	3.5 (.138)	3.5 (.138)

- Notes: 1. Metric dimensions govern.  
 2. (Ref) - Dimensions provided for reference only.  
 \* Mil-C-55365/8 Specified Dimensions  
 \*\* Round Glue Pad: 2.9  $\pm 0.1$ mm (0.114"  $\pm 0.004$ ") in diameter at KEMET's option

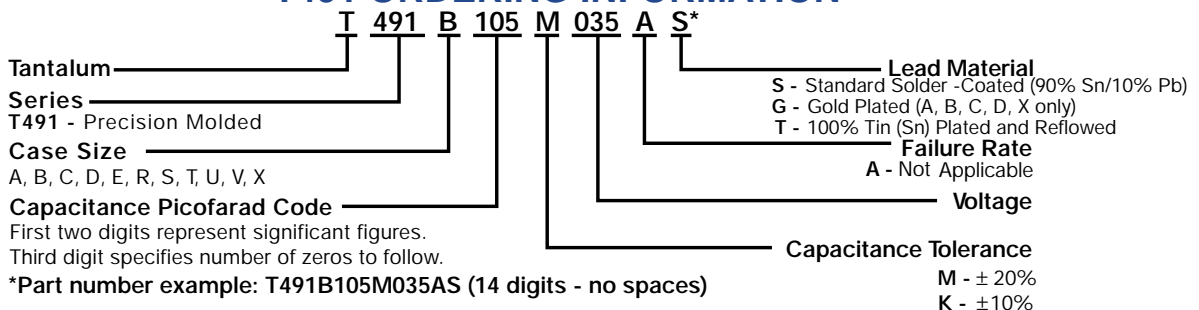
### LOW PROFILE T491 DIMENSIONS

Millimeters (inches)

CASE SIZE		COMPONENT										
KEMET	EIA	L	W	H Max.	K Min.	F $\pm 0.1$	S $\pm 0.3$	X (Ref)	T (Ref)	A (Min)	G (Ref)	E (Ref)
R	2012-12	2.0 $\pm 0.2$ (.079 $\pm .008$ )	1.3 $\pm 0.2$ (.051 $\pm .008$ )	1.2 (.047)	0.3 (.012)	0.9 (.035)	0.5 (.020)	0.05 (.002)	0.13 (.005)	0.8 (.031)	0.5 (.020)	0.8 (.031)
S	3216-12	3.2 $\pm 0.2$ (.126 $\pm .008$ )	1.6 $\pm 0.2$ (.063 $\pm .008$ )	1.2 (.047)	0.3 (.012)	1.2 (.047)	0.8 (.031)	0.05 (.002)	0.13 (.005)	0.8 (.031)	1.1 (.043)	1.3 (.051)
T	3528-12	3.5 $\pm 0.2$ (.138 $\pm .008$ )	2.8 $\pm 0.2$ (.110 $\pm .008$ )	1.2 (.047)	0.3 (.012)	2.2 (.087)	0.8 (.031)	0.05 (.002)	0.13 (.005)	1.1 (.043)	1.8 (.071)	2.2 (.087)
U	6032-15	6.0 $\pm 0.3$ (.236 $\pm .012$ )	3.2 $\pm 0.3$ (.126 $\pm .012$ )	1.5 (.059)	0.5 (.020)	2.2 (.087)	1.3 (.051)	0.05 (.002)	0.13 (.005)	2.5 (.098)	2.8 (.110)	2.4 (.094)
V	7343-20	7.3 $\pm 0.3$ (.287 $\pm .012$ )	4.3 $\pm 0.3$ (.169 $\pm .012$ )	2.0 (.079)	0.9 (.035)	2.4 (.094)	1.3 (.051)	0.05 (.002)	0.13 (.005)	3.8 (.150)	3.5 (.138)	3.5 (.138)

- Notes: 1. Metric dimensions govern.  
 2. (Ref) - Dimensions provided for reference only.  
 3. No dimensions provided for B, P or R because low profile cases do not have a bevel or a notch.

### T491 ORDERING INFORMATION



### T491 TANTALUM CHIP CAPACITANCE VALUES Case Size by Capacitance and Voltage

#### Standard Capacitance Values

#### Extended Capacitance Values

Capacitance		Rated Voltage @ +85°C								Capacitance		Rated Voltage @ +85°C									
μF	Code	4	6	10	16	20	25	35	50	μF	Code	3	4	6	10	16	20	25	35	50	
0.10	104							A	A	0.10	104										
0.15	154							A	B	0.15	154										A
0.22	224							A	B	0.22	224										
0.33	334						A	A	B	0.33	334										
0.47	474						A	A/B	C	0.47	474										B
0.68	684					A	A	B	C	0.68	684								A	A	B
1.0	105				A	S/A	B	B	C	1.0	105						R	A	A	A	V
1.5	155			A	A	S/A	B	B/C	D	1.5	155							A	A	A	C
2.2	225		A	A	S/A	A/B	B/C	C	D	2.2	225									B	C
3.3	335	A	A	S/A	A/B	B/T	C	C	D	3.3	335				R		A	B	B	B	
4.7	475	A	S/A	A/B	AB/T	B/C	C	C/D	D	4.7	475				R/S		A	B	B	B	
6.8	685	S/A	A/B	AB/T	B/C	C/U	C	D	X	6.8	685			R/S	S	A	B	B	C	D	
10.0	106	A/B	AB/T	B/C	BCU	C/U	D	D		10.0	106		R/S	R/S	ST/A	T/A	B	C	C/V	X	
15.0	156	AB/T	B/C	BCU	C/U	D	D	X		15.0	156		S	ST/A	T/A	B	C	C	D	X	
22.0	226	B/C	BCU	C/U	C/D	D/V	D	X		22.0	226			ST/A	T/A	T/AB	U/B	C	V	D	
33.0	336	BCU	C/U	CD/V	D	D	X			33.0	336	A	T/A	T/AB	U/B	U/C		D	X		
47.0	476	C/U	C/D	D/V	D/V					47.0	476		T/AB	U/B/A	U/C	C	D	D/X			
68.0	686	C/D	D	D/V		X				68.0	686		UB/A	U/C	U/C	V/D	D	X			
100.0	107	D	D/V	D	X					100.0	107		T/UC/A	B/TC	V/C	D	X				
150.0	157	D/V	D	X						150.0	157		B/C	V/C	V/CD	X					
220.0	227		X							220.0	227		V	C/VD	D/X						
330.0	337									330.0	337		V/CD	D/X	D/X						
470.0	477									470.0	477		D/X	X	E						
680.0	687									680.0	687		D/X	E							
1000.0	108									1000.0	108		X/E								

Note that standard values are preferred. Extended values are available for use where size constraints exist. Note that standard values demonstrate inherently lower failure rates than extended values, especially in low impedance applications.





### T491 RATINGS & PART NUMBER REFERENCE

Capacitance µF	Case Size	KEMET Part Number	DC Leakage mA @ 25°C Max	DF % @ +25°C 120 Hz Max	ESR W @ +25°C 100 kHz Max
<b>20 Volt Rating at +85°C (13 Volt Rating at +125°C)</b>					
1.0	A	T491A684(1)020AS	0.5	4.0	12.0
1.0	A	T491A105(1)020AS	0.5	4.0	10.0
1.0	S	T491S105(1)020AS	0.5	6.0	18.0
#1.0	R	T491R105M020AS	0.5	6.0	20.0
1.5	A	T491A155(1)020AS	0.5	6.0	8.0
1.5	S	T491S155(1)020AS	0.5	6.0	15.0
2.2	B	T491B225(1)020AS	0.5	6.0	3.5
2.2	A	T491A225(1)020AS	0.5	6.0	7.0
3.3	B	T491B335(1)020AS	0.7	6.0	3.5
#3.3	*A	T491A335(1)020AS	0.7	6.0	7.0
3.3	*T	T491T335(1)020AS	0.7	6.0	5.0
4.7	C	T491C475(1)020AS	1.0	6.0	2.4
4.7	B	T491B475(1)020AS	1.0	6.0	3.5
#4.7	*A	T491A475M020AS	1.0	8.0	6.0
6.8	C	T491C685(1)020AS	1.4	6.0	1.9
6.8	U	T491U685(1)020AS	1.4	6.0	1.9
#6.8	*B	T491B685(1)020AS	1.4	6.0	3.5
10.0	C	T491C106(1)020AS	2.0	6.0	1.8
10.0	U	T491U106(1)020AS	2.0	6.0	1.8
#10.0	*B	T491B106(1)020AS	2.0	6.0	3.0
15.0	D	T491D156(1)020AS	3.0	6.0	1.0
15.0	*C	T491C156(1)020AS	3.0	6.0	1.7
22.0	D	T491D226(1)020AS	4.4	6.0	0.8
22.0	V	T491V226(1)020AS	4.4	6.0	0.7
#22.0	*C	T491C226(1)020AS	4.4	6.0	1.2
33.0	D	T491D336(1)020AS	6.6	6.0	0.8
#33.0	*C	T491C336M020AS	6.6	6.0	1.2
†33.0	*V	T491V336M020AS	6.6	8.0	0.7
47.0	*D	T491D476(1)020AS	9.4	6.0	0.7
68.0	X	T491X686(1)020AS	13.6	6.0	0.7
#68.0	*D	T491D686(1)020AS	13.6	8.0	0.7
#100.0	*X	T491X107(1)020AS	20.0	8.0	0.5
<b>25 Volt Rating at +85°C (17 Volt Rating at +125°C)</b>					
0.33	A	T491A334(1)025AS	0.5	4.0	15.0
0.47	A	T491A474(1)025AS	0.5	4.0	14.0
0.68	A	T491A684(1)025AS	0.5	4.0	10.0
1.0	B	T491B105(1)025AS	0.5	4.0	5.0
1.0	*A	T491A105(1)025AS	0.5	4.0	8.0
1.5	B	T491B155(1)025AS	0.5	6.0	5.0
1.5	*A	T491A155(1)025AS	0.5	6.0	10.0
2.2	C	T491C225(1)025AS	0.6	6.0	3.5
2.2	B	T491B225(1)025AS	0.6	6.0	4.5
3.3	C	T491C335(1)025AS	0.9	6.0	2.5
3.3	*B	T491B335(1)025AS	0.9	6.0	3.5
4.7	C	T491C475(1)025AS	1.2	6.0	2.4
#4.7	*B	T491B475M025AS	1.2	6.0	1.5
6.8	C	T491C685(1)025AS	1.7	6.0	1.9
10.0	D	T491D106(1)025AS	2.5	6.0	1.0
10.0	*C	T491C106(1)025AS	2.5	6.0	1.5
15.0	D	T491D156(1)025AS	3.8	6.0	1.0
#15.0	*C	T491C156(1)025AS	3.8	6.0	1.5
22.0	D	T491D226(1)025AS	5.5	6.0	0.8
22.0	*V	T491V226(1)025AS	5.5	6.0	0.7
33.0	X	T491X336(1)025AS	8.3	6.0	0.7
#33.0	*D	T491D336(1)025AS	8.3	6.0	0.7
#47.0	*X	T491X476(1)025AS	11.8	6.0	0.7
†47.0	*D	T491D476M025AS	11.8	10.0	0.7
†68.0	*X	T491X686M025AS	17.0	8.0	0.7

Capacitance µF	Case Size	KEMET Part Number	DC Leakage mA @ 25°C Max	DF % @ +25°C 120 Hz Max	ESR W @ +25°C 100 kHz Max
<b>35 Volt Rating at +85°C (23 Volt Rating at +125°C)</b>					
0.10	A	T491A104(1)035AS	0.5	4.0	20.0
0.15	A	T491A154(1)035AS	0.5	4.0	19.0
0.22	A	T491A224(1)035AS	0.5	4.0	18.0
0.33	A	T491A334(1)035AS	0.5	4.0	15.0
0.47	B	T491B474(1)035AS	0.5	4.0	8.0
0.47	A	T491A474(1)035AS	0.5	4.0	14.0
0.68	B	T491B684(1)035AS	0.5	4.0	6.5
0.68	*A	T491A684(1)035AS	0.5	4.0	10.0
1.0	B	T491B105(1)035AS	0.5	4.0	5.0
1.0	*A	T491A105(1)035AS	0.5	4.0	10.0
1.5	C	T491C155(1)035AS	0.5	6.0	4.5
1.5	B	T491B155(1)035AS	0.5	6.0	5.0
2.2	C	T491C225(1)035AS	0.8	6.0	3.5
2.2	*B	T491B225(1)035AS	0.8	6.0	4.0
3.3	C	T491C335(1)035AS	1.2	6.0	2.5
#3.3	*B	T491B335M035AS	1.2	6.0	3.5
4.7	D	T491D475(1)035AS	1.7	6.0	1.5
4.7	C	T491C475(1)035AS	1.7	6.0	2.5
6.8	D	T491D685(1)035AS	2.4	6.0	1.3
6.8	*C	T491C685(1)035AS	2.4	6.0	2.0
10.0	D	T491D106(1)035AS	3.5	6.0	1.0
#10.0	*C	T491C106M035AS	3.5	6.0	2.0
#10.0	*V	T491V106(1)035AS	3.5	6.0	2.0
15.0	X	T491X156(1)035AS	5.3	6.0	0.9
15.0	*D	T491D156(1)035AS	5.3	6.0	0.8
22.0	X	T491X226(1)035AS	7.7	6.0	0.7
#22.0	*D	T491D226(1)035AS	7.7	6.0	0.7
#33.0	*X	T491X336(1)035AS	11.6	6.0	0.6
#47.0	*X	T491X476(1)035AS	16.5	8.0	0.6
<b>50 Volt Rating at +85°C (33 Volt Rating at +125°C)</b>					
0.10	A	T491A104(1)050AS	0.5	4.0	20.0
0.15	B	T491B154(1)050AS	0.5	4.0	16.0
0.15	*A	T491A154(1)050AS	0.5	4.0	19.0
0.22	B	T491B224(1)050AS	0.5	4.0	14.0
0.33	B	T491B334(1)050AS	0.5	4.0	10.0
0.47	C	T491C474(1)050AS	0.5	4.0	8.0
0.47	*B	T491B474(1)050AS	0.5	4.0	9.0
0.68	C	T491C684(1)050AS	0.5	4.0	7.0
0.68	*B	T491B684(1)050AS	0.5	4.0	8.0
1.0	C	T491C105(1)050AS	0.5	4.0	5.5
1.0	*V	T491V105M050AS	0.5	4.0	6.0
1.5	D	T491D155(1)050AS	0.8	6.0	3.5
1.5	*C	T491C155(1)050AS	0.8	6.0	4.5
2.2	D	T491D225(1)050AS	1.1	6.0	2.5
2.2	*C	T491C225(1)050AS	1.1	6.0	3.5
3.3	D	T491D335(1)050AS	1.7	6.0	2.0
4.7	D	T491D475(1)050AS	2.4	6.0	1.5
6.8	X	T491X685(1)050AS	3.5	6.0	1.0
#6.8	*D	T491D685M050AS	3.4	6.0	1.0
#10.0	*X	T491X106M050AS	5.0	6.0	0.7
#15.0	*X	T491X156(1)050AS	7.5	8.0	0.7

\*Extended Values

\*\*6 Volt product equivalent to 6.3 volt product.

(1) To complete KEMET Part Number, insert M for ±20% tolerance or K for ±10% tolerance.

Higher voltage ratings, lower ESR, and tighter capacitance tolerance product may be substituted within the same size at KEMET's option. Voltage substitutions will be marked with the higher voltage rating.

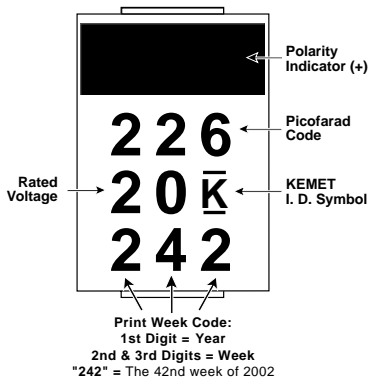
#Maximum Capacitance Change @ 125°C=+15%.

†Maximum Capacitance Change @ 125°C=+20%.

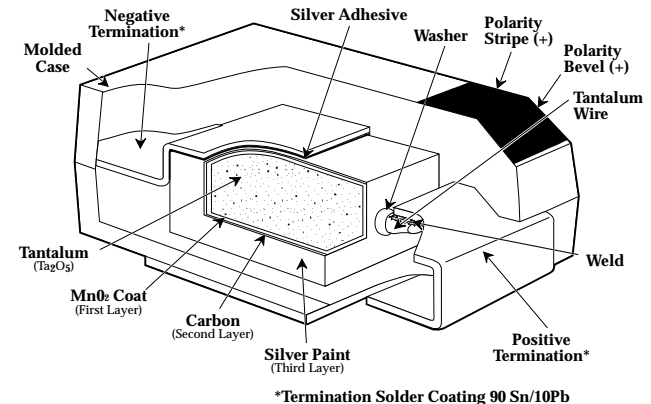
New values are in red.

### CAPACITOR MARKINGS

#### T491 Series — All Case Sizes



### CONSTRUCTION



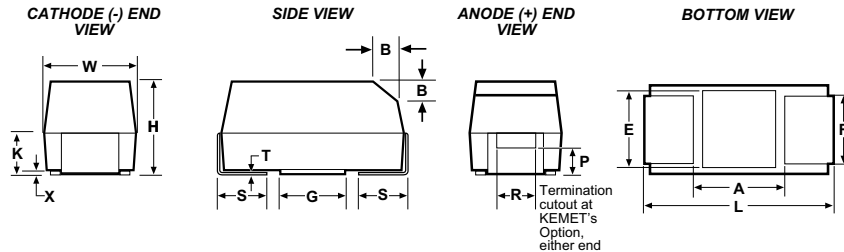
# SOLID TANTALUM CHIP CAPACITORS

T492 SERIES—Style CWR11 Per Mil-PRF-55365/8



- Established reliability military version of Industrial Grade T491 series
- Taped and reeled per EIA 481-1
- Precision-molded, laser-marked case
- Symmetrical, compliant terminations
- 100% Surge Current test on C, D sizes
- Qualified to MIL-PRF-55365/8, Style CWR11:
  - Termination Code H, solder-plated
  - Weibull failure rate codes B, C and D
  - Capacitance values and voltages as shown in following part number table. (Contact KEMET for latest qualification status)

## T492 OUTLINE DRAWINGS

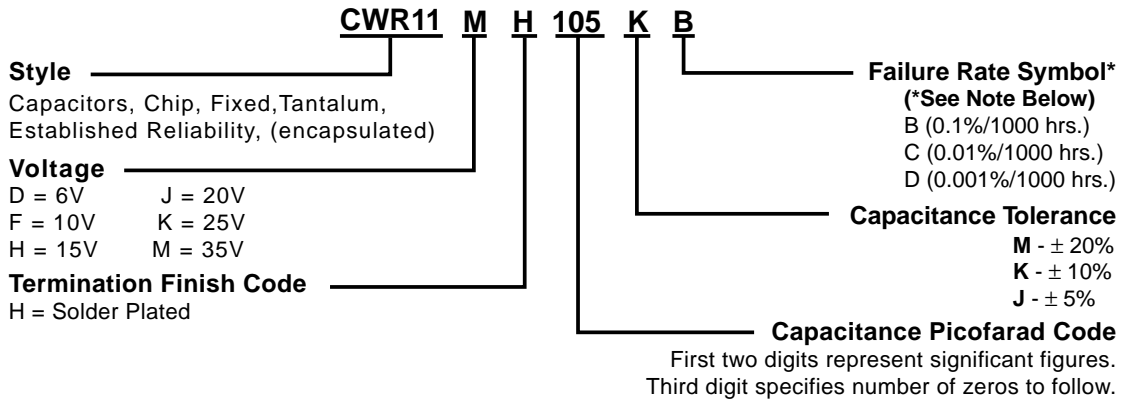


## DIMENSIONS – Millimeters (Inches)

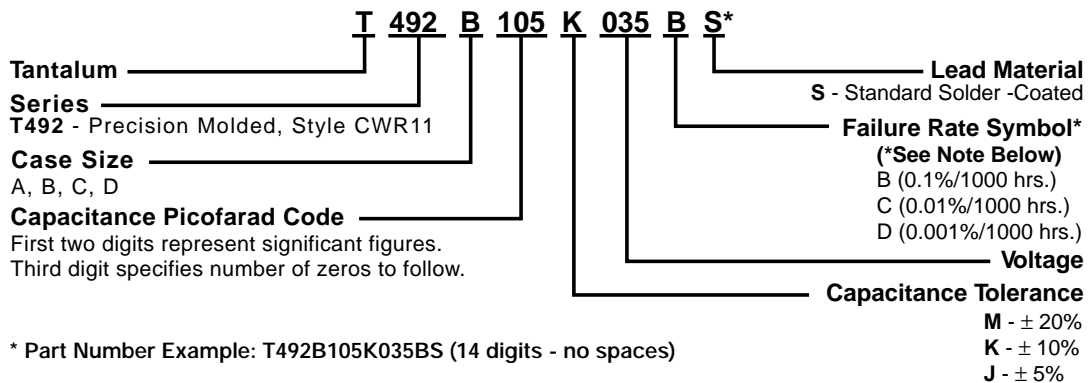
CASE SIZE		COMPONENT													
KEMET	EIA	L*	W*	H*	K* ±0.20 ±(.008)	F* ±0.1 ±(.004)	S* ±0.3 ±(.012)	B ±0.15 (Ref) ± (.006)	X (Ref)	P (Ref)	R (Ref)	T (Ref)	A (Min)	G (Ref)	E (Ref)
A	3216-18	3.2 ± 0.2 (.126 ± .008)	1.6 ± 0.2 (.063 ± .008)	1.6 ± 0.2 (.063 ± .008)	0.9 (.035)	1.2 (.047)	0.8 (.031)	0.4 (.016)	0.10 ± 0.10 (.004 ± .004)	0.4 (.016)	0.4 (.016)	0.13 (.005)	0.8 (.031)	1.1 (.043)	1.3 (.051)
B	3528-21	3.5 ± 0.2 (.138 ± .008)	2.8 ± 0.2 (.110 ± .008)	1.9 ± 0.2 (.075 ± .008)	1.1 (.043)	2.2 (.087)	0.8 (.031)	0.4 (.016)	0.10 ± 0.10 (.004 ± .004)	0.5 (.020)	1.0 (.039)	0.13 (.005)	1.1 (.043)	1.8 (.071)	2.2 (.087)
C	6032-28	6.0 ± 0.3 (.236 ± .012)	3.2 ± 0.3 (.126 ± .012)	2.5 ± 0.3 (.098 ± .012)	1.4 (.055)	2.2 (.087)	1.3 (.051)	0.5 (.020)	0.10 ± 0.10 (.004 ± .004)	0.9 (.035)	1.0 (.039)	0.13 (.005)	2.5 (.098)	2.8 (.110)	2.4 (.094)
D	7343-31	7.3 ± 0.3 (.287 ± .012)	4.3 ± 0.3 (.169 ± .012)	2.8 ± 0.3 (.110 ± .012)	1.5 (.059)	2.4 (.094)	1.3 (.051)	0.5 (.020)	0.10 ± 0.10 (.004 ± .004)	0.9 (.035)	1.0 (.039)	0.13 (.005)	3.8 (.150)	3.5 (.138)	3.5 (.138)

Notes: 1. Metric dimensions govern. 2. (Ref) - Dimensions provided for reference only. \* Mil-C-55365/8 Specified Dimensions

## ORDERING INFORMATION — MIL-PRF-55365 Part Number



## T492 SERIES ORDERING INFORMATION — KEMET Part Number

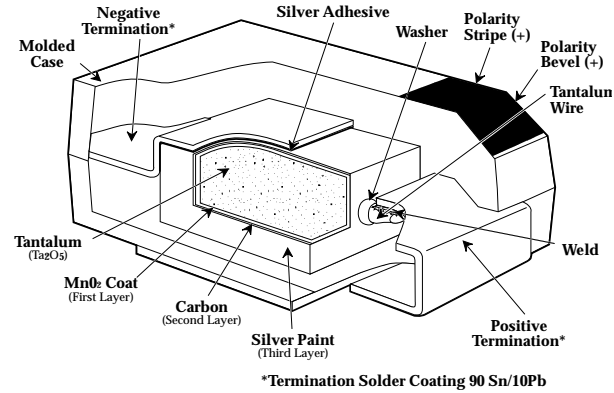


\*Note on Failure Rates: Exponential failure rate levels M, P, R and S are inactive for new design per Mil-C-55365. Parts qualified to Weibull failure rate levels are substitutable for exponential failure rate levels.

### T492 (CWR11) RATINGS AND PART NUMBER REFERENCE

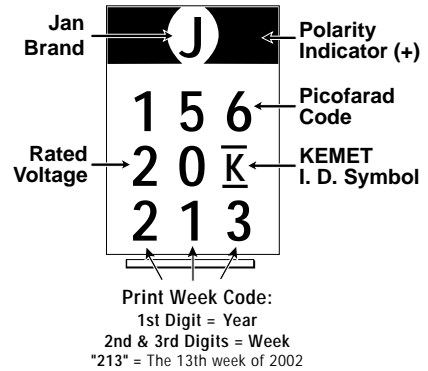
Capacitance μF	Case Size	KEMET Part Number	Mil-C-55365/8 Part Number	DC Leakage μA @ +25°C Max	DF % @ +25°C 120 Hz Max	ESR Ω @ +25°C 100kHz Max
<b>6 Volt Rating at +85°C (4 Volt Rating at +125°C)</b>						
1.5	A	T492A155(1)006(2)S	CWR11DH155(1)(2)	0.5	6.0	8.0
2.2	A	T492A225(1)006(2)S	CWR11DH225(1)(2)	0.5	6.0	8.0
3.3	A	T492A335(1)006(2)S	CWR11DH335(1)(2)	0.5	6.0	8.0
4.7	B	T492B475(1)006(2)S	CWR11DH475(1)(2)	0.5	6.0	5.5
6.8	B	T492B685(1)006(2)S	CWR11DH685(1)(2)	0.5	6.0	4.5
10.0	B	T492B106(1)006(2)S	CWR11DH106(1)(2)	0.6	6.0	3.5
15.0	C	T492C156(1)006(2)S	CWR11DH156(1)(2)	0.9	6.0	3.0
22.0	C	T492C226(1)006(2)S	CWR11DH226(1)(2)	1.4	6.0	2.2
47.0	D	T492D476(1)006(2)S	CWR11DH476(1)(2)	2.8	6.0	1.1
<b>10 Volt Rating at +85°C (7 Volt Rating at 125°C)</b>						
1.0	A	T492A105(1)010(2)S	CWR11FH105(1)(2)	0.5	4.0	10.0
1.5	A	T492A155(1)010(2)S	CWR11FH155(1)(2)	0.5	6.0	8.0
2.2	A	T492A225(1)010(2)S	CWR11FH225(1)(2)	0.5	6.0	8.0
3.3	B	T492B335(1)010(2)S	CWR11FH335(1)(2)	0.5	6.0	5.5
4.7	B	T492B475(1)010(2)S	CWR11FH475(1)(2)	0.5	6.0	4.5
6.8	B	T492B685(1)010(2)S	CWR11FH685(1)(2)	0.7	6.0	3.5
15.0	C	T492C156(1)010(2)S	CWR11FH156(1)(2)	1.5	6.0	2.5
33.0	D	T492D336(1)010(2)S	CWR11FH336(1)(2)	3.3	6.0	1.1
<b>15 Volt Rating at +85°C (10 Volt Rating at +125°C)</b>						
0.68	A	T492A684(1)015(2)S	CWR11HH684(1)(2)	0.5	4.0	12.0
1.0	A	T492A105(1)015(2)S	CWR11HH105(1)(2)	0.5	4.0	10.0
1.5	A	T492A155(1)015(2)S	CWR11HH155(1)(2)	0.5	6.0	8.0
2.2	B	T492B225(1)015(2)S	CWR11HH225(1)(2)	0.5	6.0	5.5
3.3	B	T492B335(1)015(2)S	CWR11HH335(1)(2)	0.5	6.0	5.0
4.7	B	T492B475(1)015(2)S	CWR11HH475(1)(2)	0.7	6.0	4.0
10.0	C	T492C106(1)015(2)S	CWR11HH106(1)(2)	1.6	6.0	2.5
22.0	D	T492D226(1)015(2)S	CWR11HH226(1)(2)	3.3	6.0	1.1
<b>20 Volt Rating at +85°C (13 Volt Rating at +125°C)</b>						
0.47	A	T492A474(1)020(2)S	CWR11JH474(1)(2)	0.5	4.0	14.0
0.68	A	T492A684(1)020(2)S	CWR11JH684(1)(2)	0.5	4.0	12.0
1.0	A	T492A105(1)020(2)S	CWR11JH105(1)(2)	0.5	4.0	10.0
1.5	B	T492B155(1)020(2)S	CWR11JH155(1)(2)	0.5	6.0	6.0
2.2	B	T492B225(1)020(2)S	CWR11JH225(1)(2)	0.5	6.0	5.0
3.3	B	T492B335(1)020(2)S	CWR11JH335(1)(2)	0.7	6.0	4.0
4.7	C	T492C475(1)020(2)S	CWR11JH475(1)(2)	1.0	6.0	3.0
6.8	C	T492C685(1)020(2)S	CWR11JH685(1)(2)	1.4	6.0	2.4
15.0	D	T492D156(1)020(2)S	CWR11JH156(1)(2)	3.0	6.0	1.1
<b>25 Volt Rating at +85°C (17 Volt Rating at +125°C)</b>						
0.33	A	T492A334(1)025(2)S	CWR11KH334(1)(2)	0.5	4.0	15.0
0.47	A	T492A474(1)025(2)S	CWR11KH474(1)(2)	0.5	4.0	14.0
0.68	B	T492B684(1)025(2)S	CWR11KH684(1)(2)	0.5	4.0	7.5
1.0	B	T492B105(1)025(2)S	CWR11KH105(1)(2)	0.5	4.0	6.5
1.5	B	T492B155(1)025(2)S	CWR11KH155(1)(2)	0.5	6.0	6.5
2.2	C	T492C225(1)025(2)S	CWR11KH225(1)(2)	0.6	6.0	3.5
3.3	C	T492C335(1)025(2)S	CWR11KH335(1)(2)	0.9	6.0	3.5
4.7	C	T492C475(1)025(2)S	CWR11KH475(1)(2)	1.2	6.0	2.5
6.8	D	T492D685(1)025(2)S	CWR11KH685(1)(2)	1.7	6.0	1.4
10.0	D	T492D106(1)025(2)S	CWR11KH106(1)(2)	2.5	6.0	1.2
<b>35 Volt Rating at +85°C (23 Volt Rating at +125°C)</b>						
0.10	A	T492A104(1)035(2)S	CWR11MH104(1)(2)	0.5	4.0	24.0
0.15	A	T492A154(1)035(2)S	CWR11MH154(1)(2)	0.5	4.0	21.0
0.22	A	T492A224(1)035(2)S	CWR11MH224(1)(2)	0.5	4.0	18.0
0.33	A	T492A334(1)035(2)S	CWR11MH334(1)(2)	0.5	4.0	15.0
0.47	B	T492B474(1)035(2)S	CWR11MH474(1)(2)	0.5	4.0	10.0
0.68	B	T492B684(1)035(2)S	CWR11MH684(1)(2)	0.5	4.0	8.0
1.0	B	T492B105(1)035(2)S	CWR11MH105(1)(2)	0.5	4.0	6.5
1.5	C	T492C155(1)035(2)S	CWR11MH155(1)(2)	0.5	6.0	4.5
2.2	C	T492C225(1)035(2)S	CWR11MH225(1)(2)	0.8	6.0	3.5
3.3	C	T492C335(1)035(2)S	CWR11MH335(1)(2)	1.2	6.0	2.5
4.7	D	T492D475(1)035(2)S	CWR11MH475(1)(2)	1.7	6.0	1.5

### CONSTRUCTION



### CAPACITOR MARKINGS

#### T492 Series — All Case Sizes



**Note on Failure Rates:**  
Exponential failure rate levels M, P, R and S are inactive for new design per MIL-C-55365. Parts qualified to Weibull failure rate levels are substitutable for exponential failure rate levels.  
**Note: ESR limits are per Mil-C-55365/8**

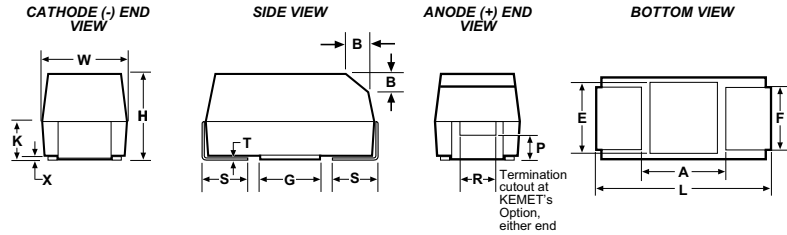
To complete Part Numbers:

- (1) Insert "M" for ±20% tolerance, "K" for ±10% tolerance or "J" for ±5% tolerance.
- (2) Insert Failure Rate Symbol: B (0.1%/1000 hours), C (0.01%/1000 hours) or D (0.001%/1000 hours).

### FEATURES

- Low ESR values in EIA 535BAAC sizes
- Taped and Reeled per EIA 481-1
- Symmetrical, Compliant Terminations
- Optional Gold-plated Terminations
- Laser-marked Case
- 100% Surge Current test on C, D, E, U, V, X sizes
- Capacitance: 0.1  $\mu$ F to 1000  $\mu$ F
- Tolerance:  $\pm 10\%$ ,  $\pm 20\%$
- Voltage: 3-50 VDC
- Extended Range Values
- New Low Profile Case Sizes

### CAPACITOR OUTLINE DRAWING



### STANDARD T494 DIMENSIONS Millimeters (inches)

CASE SIZE		COMPONENT													
KEMET	EIA	L*	W*	H*	K* $\pm 0.20$ $\pm (.008)$	F* $\pm 0.1$ $\pm (.004)$	S* $\pm 0.3$ $\pm (.012)$	B $\pm 0.15$ $(\text{Ref}) \pm (.006)$	X (Ref)	P (Ref)	R (Ref)	T (Ref)	A (Min)	G (Ref)	E (Ref)
A	3216-18	3.2 $\pm 0.2$ (.126 $\pm .008$ )	1.6 $\pm 0.2$ (.063 $\pm .008$ )	1.6 $\pm 0.2$ (.063 $\pm .008$ )	0.9 (.035)	1.2 (.047)	0.8 (.031)	0.4 (.016)	0.10 $\pm 0.10$ (.004 $\pm .004$ )	0.4 (.016)	0.4 (.016)	0.13 (.005)	0.8 (.031)	1.1 (.043)	1.3 (.051)
B	3528-21	3.5 $\pm 0.2$ (.138 $\pm .008$ )	2.8 $\pm 0.2$ (.110 $\pm .008$ )	1.9 $\pm 0.2$ (.075 $\pm .008$ )	1.1 (.043)	2.2 (.087)	0.8 (.031)	0.4 (.016)	0.10 $\pm 0.10$ (.004 $\pm .004$ )	0.5 (.020)	1.0 (.039)	1.1 (.005)	1.1 (.043)	1.8 (.071)	2.2 (.087)
C	6032-28	6.0 $\pm 0.3$ (.236 $\pm .012$ )	3.2 $\pm 0.3$ (.126 $\pm .012$ )	2.5 $\pm 0.3$ (.098 $\pm .012$ )	1.4 (.055)	2.2 (.087)	1.3 (.051)	0.5 (.020)	0.10 $\pm 0.10$ (.004 $\pm .004$ )	0.9 (.035)	1.0 (.039)	0.13 (.005)	2.5 (.098)	2.8 (.110)	2.4 (.094)
D	7343-31	7.3 $\pm 0.3$ (.287 $\pm .012$ )	4.3 $\pm 0.3$ (.169 $\pm .012$ )	2.8 $\pm 0.3$ (.110 $\pm .012$ )	1.5 (.059)	2.4 (.094)	1.3 (.051)	0.5 (.020)	0.10 $\pm 0.10$ (.004 $\pm .004$ )	0.9 (.035)	1.0 (.039)	0.13 (.005)	3.8 (.150)	3.5 (.138)	3.5 (.138)
X	7343-43	7.3 $\pm 0.3$ (.287 $\pm .012$ )	4.3 $\pm 0.3$ (.169 $\pm .012$ )	4.0 $\pm 0.3$ (.157 $\pm .012$ )	2.3 (.091)	2.4 (.094)	1.3 (.051)	0.5 (.020)	0.10 $\pm 0.10$ (.004 $\pm .004$ )	1.7 (.067)	1.0 (.039)	0.13 (.005)	3.8 (.150)	3.5** (.138)	3.5** (.138)
E	7260-38	7.3 $\pm 0.3$ (.287 $\pm .012$ )	6.0 $\pm 0.3$ (.236 $\pm .012$ )	3.6 $\pm 0.2$ (.142 $\pm .008$ )	2.3 (.091)	4.1 (.161)	1.3 (.051)	0.5 (.020)	0.10 $\pm 0.10$ (.004 $\pm .004$ )	0.9 (.035)	1.0 (.039)	0.13 (.005)	3.8 (.150)	3.5 (.138)	3.5 (.138)

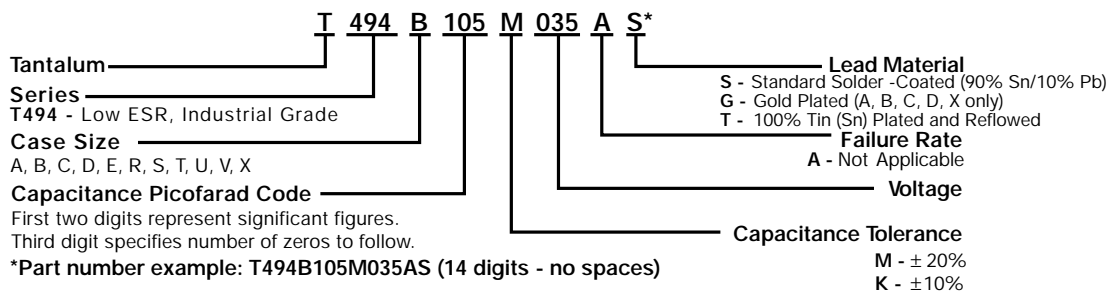
- Notes: 1. Metric dimensions govern.  
 2. (Ref) - Dimensions provided for reference only.  
 \* Mil-C-55365/8 Specified Dimensions  
 \*\* Round Glue Pad: 2.9  $\pm 0.1$ mm (0.114"  $\pm 0.004$ ") in diameter at KEMET's option

### LOW PROFILE T494 DIMENSIONS Millimeters (inches)

CASE SIZE		COMPONENT										
KEMET	EIA	L	W	H Max.	K Min.	F $\pm 0.1$	S $\pm 0.3$	X (Ref)	T (Ref)	A (Min)	G (Ref)	E (Ref)
R	2012-12	2.0 $\pm 0.2$ (.079 $\pm .008$ )	1.3 $\pm 0.2$ (.051 $\pm .008$ )	1.2 (.047)	0.3 (.012)	0.9 (.035)	0.5 (.020)	0.05 (.002)	0.13 (.005)	0.8 (.031)	0.5 (.020)	0.8 (.031)
S	3216-12	3.2 $\pm 0.2$ (.126 $\pm .008$ )	1.6 $\pm 0.2$ (.063 $\pm .008$ )	1.2 (.047)	0.3 (.012)	1.2 (.047)	0.8 (.031)	0.05 (.002)	0.13 (.005)	0.8 (.031)	1.1 (.043)	1.3 (.051)
T	3528-12	3.5 $\pm 0.2$ (.138 $\pm .008$ )	2.8 $\pm 0.2$ (.110 $\pm .008$ )	1.2 (.047)	0.3 (.012)	2.2 (.087)	0.8 (.031)	0.05 (.002)	0.13 (.005)	1.1 (.043)	1.8 (.071)	2.2 (.087)
U	6032-15	6.0 $\pm 0.3$ (.236 $\pm .012$ )	3.2 $\pm 0.3$ (.126 $\pm .012$ )	1.5 (.059)	0.5 (.020)	2.2 (.087)	1.3 (.051)	0.05 (.002)	0.13 (.005)	2.5 (.098)	2.8 (.110)	2.4 (.094)
V	7343-20	7.3 $\pm 0.3$ (.287 $\pm .012$ )	4.3 $\pm 0.3$ (.169 $\pm .012$ )	2.0 (.079)	0.9 (.035)	2.4 (.094)	1.3 (.051)	0.05 (.002)	0.13 (.005)	3.8 (.150)	3.5 (.138)	3.5 (.138)

- Notes: 1. Metric dimensions govern.  
 2. (Ref) - Dimensions provided for reference only.  
 3. No dimensions provided for B, P or R because low profile cases do not have a bevel or a notch.

### T494 ORDERING INFORMATION



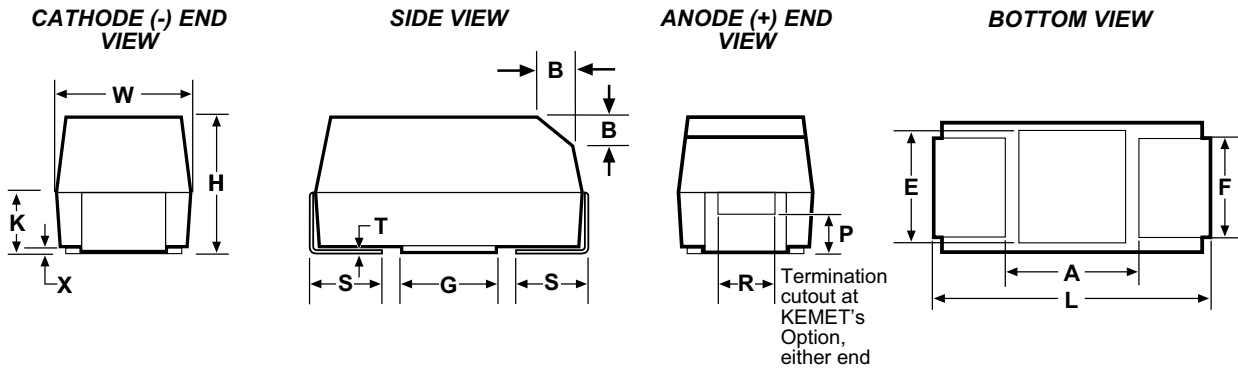




### FEATURES

- Designed for very low ESR
- High ripple current capability
- High surge current capability
- 100% accelerated steady-state aging
- 100% Surge Current test
- Meets or Exceeds EIA Standard 535BAAC
- Available tested per DSCC Dwg. 95158
- New Extended Values for Low ESR
- Low Equivalent Series Inductance (<2.5nH ESL)
- Precision-molded, laser-marked case
- Symmetrical, compliant terminations
- Taped and reeled per EIA 481-1

### OUTLINE DRAWING



### STANDARD T495 DIMENSIONS

Millimeters (Inches)

CASE SIZE		COMPONENT													
KEMA	EIA	L	W	H	K ± 0.20 ± (.008)	F ± 0.1 ± (.004)	S ± 0.3 ± (.012)	B ± 0.15 (Ref) ± (.006)	X (Ref)	P (Ref)	R (Ref)	T (Ref)	A (Min)	G (Ref)	E (Ref)
B	3528-21	3.5 ± 0.2 (.138 ± .008)	2.8 ± 0.2 (.110 ± .008)	1.9 ± 0.2 (.075 ± .008)	1.1 (.043)	2.2 (.087)	0.8 (.031)	0.4 (.016)	0.10 ± 0.10 (.004 ± .004)	0.5 (.020)	1.0 (.039)	0.13 (.005)	1.1 (.043)	1.8 (.071)	2.2 (.087)
C	6032-28	6.0 ± 0.3 (.236 ± .012)	3.2 ± 0.3 (.126 ± .012)	2.5 ± 0.3 (.098 ± .012)	1.4 (.055)	2.2 (.087)	1.3 (.051)	0.5 (.020)	0.10 ± 0.10 (.004 ± .004)	0.9 (.035)	1.0 (.039)	0.13 (.005)	2.5 (.098)	2.8 (.110)	2.4 (.094)
D	7343-31	7.3 ± 0.3 (.287 ± .012)	4.3 ± 0.3 (.169 ± .012)	2.8 ± 0.3 (.110 ± .012)	1.5 (.059)	2.4 (.094)	1.3 (.051)	0.5 (.020)	0.10 ± 0.10 (.004 ± .004)	0.9 (.035)	1.0 (.039)	0.13 (.005)	3.8 (.150)	3.5 (.138)	3.5 (.138)
X	7343-43	7.3 ± 0.3 (.287 ± .012)	4.3 ± 0.3 (.169 ± .012)	4.0 ± 0.3 (.157 ± .012)	2.3 (.091)	2.4 (.094)	1.3 (.051)	0.5 (.020)	0.10 ± 0.10 (.004 ± .004)	1.7 (.067)	1.0 (.039)	0.13 (.005)	3.8 (.150)	3.5* (.138)	3.5* (.138)

- Notes: 1. Metric dimensions govern.  
 2. (Ref) - Dimensions provided for reference only.  
 \* Round Glue Pad; 2.9 ± 0.1mm (0.114" ± 0.004") in diameter at KEMET's option.

### LOW PROFILE T495 DIMENSIONS

Millimeters (Inches)

CASE SIZE		COMPONENT										
KEMET	EIA	L	W	H Max.	K Min.	F ± 0.1	S ± 0.3	X (Ref)	T (Ref)	A (Min)	G (Ref)	E (Ref)
T	3528-12	3.5 ± 0.2 (.138 ± .008)	2.8 ± 0.2 (.110 ± .008)	1.2 (.047)	0.3 (.012)	2.2 (.087)	0.8 (.031)	0.05 (.002)	0.13 (.005)	1.1 (.043)	1.8 (.071)	2.2 (.087)
V	7343-20	7.3 ± 0.3 (.287 ± .012)	4.3 ± 0.3 (.169 ± .012)	2.0 (0.079)	0.9 (.035)	2.4 (.094)	1.3 (.051)	0.05 (.002)	0.13 (.005)	3.8 (.150)	3.5 (.138)	3.5 (.138)

- Notes: 1. Metric dimensions govern.  
 2. (Ref) - Dimensions provided for reference only.  
 3. No dimensions provided for B, P or R because low profile cases do not have a bevel or a notch.



# SOLID TANTALUM CHIP CAPACITORS

## T495 SERIES—Low ESR, Surge Robust



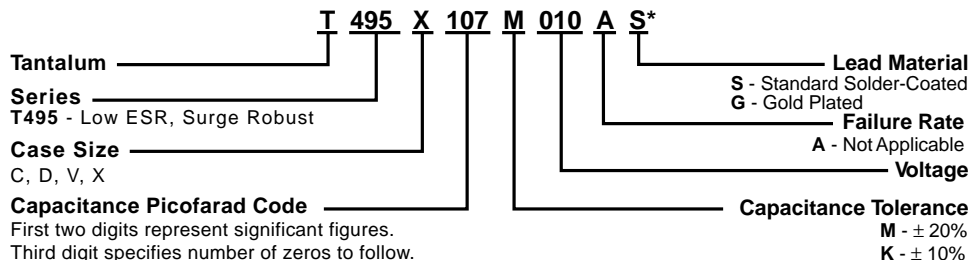
### T495 RATINGS & PART NUMBER REFERENCE

Capacitance $\mu$ F	Case Size	KEMET Part Number	DSCC Dwg. No. 95158 Part Number	DC Leakage $\mu$ A @ 25°C Max	DF% @ 25°C 120 Hz Max	ESR MW @ 25°C 100 kHz Max	Ripple Current mA rms at 25°C, 100 kHz Max		
							25°C	85°C	125°C
<b>4 Volt Rating @ +85°C (2.7 Volt Rating at +125°C)</b>									
150.0	B	T495B157M004AS		6.0	12.0	90	307	277	123
330.0	*C	T495C337(1)004AS		13.2	12.0	700	396	357	159
1000.0	*X	T495X108(1)004AS		40.0	12.0	70	1535	1381	614
<b>6/6.3 Volt Rating @ +85°C (4 Volt Rating at +125°C)</b>									
68.0	D	T495D686(1)006AS		3.3	4.0	175	926	833	370
68.0	D	T495D686(1)006AS4095	95158-01(1)(2)	3.3	4.0	175	926	833	370
100.0	*C	T495C107(1)006AS		6.0	8.0	150	856	770	342
100.0	*V	T495V107(1)006AS		6.0	8.0	150	913	822	365
100.0	*B	T495B107M006AS		6.3	15.0	700	348	313	139
150.0	C	T495C157M006AS		9.0	8.0	200	742	668	297
150.0	X	T495X157(1)006AS		7.2	6.0	100	1285	1156	514
150.0	*X	T495X157(1)006AS4095	95158-02(1)(2)	7.2	6.0	125	1150	1040	460
220.0	*C	T495C227(1)006AS		13.9	10.0	225	700	600	300
220.0	*D	T495D227(1)006AS		13.2	8.0	100	1225	1102	490
220.0	*D	T495D227(1)006AS4095	95158-25(1)(2)	13.2	8.0	100	1225	1102	490
220.0	*X	T495X227(1)006AS		13.2	8.0	100	1285	1156	514
220.0	*X	T495X227(1)006AS4095	95158-03(1)(2)	13.2	8.0	100	1285	1156	514
330.0	*D	T495D337(1)006AS		20.8	8.0	100	1225	1102	490
330.0	*X	T495X337(1)006AS		19.8	8.0	100	1285	1156	514
330.0	*X	T495X337(1)006AS4823		19.8	8.0	65	1593	1434	637
470.0	*D	T495D477(1)006AS		29.6	12.0	125	1095	986	438
470.0	*X	T495X477(1)006AS		28.2	10.0	65	1593	1434	637
470.0	*X	T495X477(1)006AS4823		28.2	10.0	50	1816	1634	726
<b>10 Volt Rating @ +85°C (7 Volt Rating at +125°C)</b>									
22.0	C	T495C226(1)010AS		2.2	6.0	345	565	508	226
47.0	D	T495D476(1)010AS		3.8	4.0	200	866	780	346
47.0	D	T495D476(1)010AS4095	95158-04(1)(2)	3.8	4.0	200	866	780	346
68.0	*B	T495B686M010AS		6.8	10.0	900	307	276	123
68.0	*C	T495C686(1)010AS		6.8	6.0	225	700	630	280
68.0	*V	T495V686(1)010AS		6.8	6.0	140	945	850	378
68.0	D	T495D686(1)010AS		6.8	6.0	150	1000	900	400
68.0	X	T495X686(1)010AS		5.4	4.0	150	1049	944	420
68.0	X	T495X686(1)010AS4095	95158-05(1)(2)	5.4	4.0	150	1049	944	420
100.0	*V	T495V107(1)010AS		10.0	8.0	150	913	822	365
100.0	*D	T495D107(1)010AS4095	95158-06(1)(2)	10.0	8.0	100	1220	1100	490
100.0	*D	T495D107(1)010AS4823		10.0	8.0	80	1369	1232	548
100.0	X	T495X107(1)010AS		8.0	6.0	100	1285	1156	514
100.0	X	T495X107(1)010AS4095	95158-07(1)(2)	8.0	6.0	100	1285	1156	514
150.0	V	T495V157M010AS		15.0	8.0	150	913	822	365
150.0	*D	T495D157(1)010AS		15.0	8.0	100	1225	1102	490
150.0	*D	T495D157(1)010AS4095	95158-26(1)(2)	15.0	8.0	100	1225	1102	490
150.0	*X	T495X157(1)010AS		15.0	8.0	100	1285	1156	514
150.0	*X	T495X157(1)010AS4095	95158-08(1)(2)	15.0	8.0	100	1285	1156	514
150.0	*X	T495X157(1)010AS4823		15.0	8.0	85	1393	1254	557
220.0	*D	T495D227(1)010AS		22.0	8.0	125	1095	986	438
220.0	*X	T495X227(1)010AS		22.0	8.0	100	1285	1156	514
220.0	*X	T495X227(1)010AS4095	95158-28(1)(2)	15.0	8.0	100	1285	1156	514
220.0	*X	T495X227(1)010AS4823		22.0	8.0	70	1535	1382	614
330.0	*D	T495D337(1)010AS		33.0	10.0	125	1095	986	438
330.0	*X	T495X337(1)010AS		33.0	10.0	60	1658	1492	663
<b>16 Volt Rating @ +85°C (10 Volt Rating at +125°C)</b>									
10.0	*T	T495T106M016AS		1.6	8.0	4000	132	119	53
33.0	*C	T495C336(1)016AS		5.3	6.0	275	632	569	253
33.0	*D	T495D336(1)016AS4095	95158-09(1)(2)	4.2	4.0	250	770	700	310
47.0	*D	T495D476(1)016AS		7.5	6.0	150	1000	900	400
47.0	*D	T495D476(1)016AS4095	95158-10(1)(2)	7.5	6.0	200	870	780	345
68.0	*D	T495D686(1)016AS		10.9	6.0	150	1000	900	400
100.0	*D	T495D107(1)016AS		16.0	8.0	125	1095	986	438
100.0	*X	T495X107(1)016AS		16.0	8.0	100	1285	1156	514
100.0	*X	T495X107(1)016AS4095	95158-11(1)(2)	16.0	8.0	125	1285	1156	514
100.0	*X	T495X107(1)016AS4823		16.0	8.0	80	1436	1293	574
150.0	*x	T495X157(1)016AS		24.0	8.0	100	1285	1156	514

- To complete KEMET Part Number, insert M for  $\pm 20\%$  or K for  $\pm 10\%$  tolerance.
- To complete KEMET Part Number, insert "B" for gold plated or "H" for solder plated termination finish.

Higher voltage ratings and tighter capacitance tolerance product may be substituted within the same size at KEMET's option. Voltage substitutions will be marked with the higher voltage rating.  
 \*Extended Values \*\*6 Volt product equivalent to 6.3 volt product.

### T495 Series – ORDERING INFORMATION



### T495 RATINGS & PART NUMBER REFERENCE

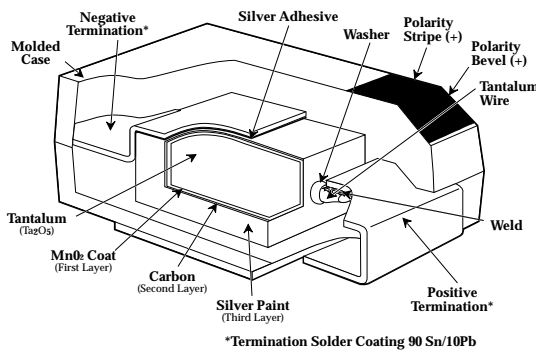
Capacitance $\mu$ F	Case Size	KEMET Part Number	DSCC Dwg. No. 95158 Part Number	DC Leakage $\mu$ A @ 25°C Max	DF% @ 25°C 120 Hz Max	ESR MW @ 25°C 100 kHz Max	Ripple Current mA rms at 25°C, 100 kHz Max		
<b>20 Volt Rating @ +85°C (13 Volt Rating at +125°C)</b>									
15.0	D	T495D156(1)020AS		2.4	4.0	275	738	665	295
15.0	D	T495D156(1)020AS4095	95158-12(1)(2)	2.4	4.0	275	738	665	295
22.0	D	T495D226(1)020AS		3.5	4.0	225	816	735	326
22.0	D	T495D226(1)020AS4095	95158-13(1)(2)	3.5	4.0	275	816	735	326
33.0	*D	T495D336(1)020AS		6.6	6.0	200	866	780	346
47.0	*D	T495D476(1)020AS		9.4	6.0	175	926	833	370
47.0	X	T495X476(1)020AS		7.5	4.0	150	1049	944	420
47.0	X	T495X476(1)020AS4095	95158-14(1)(2)	7.5	4.0	150	1049	944	420
68.0	*D	T495D686(1)020AS		13.6	8.0	150	1000	900	400
68.0	*X	T495X686(1)020AS		13.6	6.0	150	1049	944	420
68.0	*X	T495X686(1)020AS4095	95158-15(1)(2)	13.6	6.0	150	1049	944	420
<b>25 Volt Rating @ +85°C (17 Volt Rating at +125°C)</b>									
6.8	C	T495C685(1)025AS		1.7	6.0	500	469	422	188
10.0	*C	T495C106(1)025AS		2.5	6.0	450	494	445	198
15.0	D	T495D156(1)025AS		3.8	6.0	275	738	665	295
15.0	D	T495D156(1)025AS4095	95158-16(1)(2)	3.8	6.0	275	738	665	295
15.0	X	T495X156(1)025AS		3.0	4.0	200	908	817	363
15.0	X	T495X156(1)025AS4095	95158-17(1)(2)	3.0	4.0	200	908	817	363
22.0	*D	T495D226(1)025AS		5.5	6.0	200	866	780	346
22.0	X	T495X226(1)025AS		4.4	4.0	225	856	771	343
22.0	X	T495X226(1)025AS4095	95158-18(1)(2)	4.4	4.0	225	856	771	343
33.0	*D	T495D336(1)025AS		8.3	6.0	300	707	636	283
33.0	X	T495X336(1)025AS		6.6	4.0	175	971	874	388
33.0	X	T495X336(1)025AS4095	95158-19(1)(2)	6.6	4.0	175	971	874	388
47.0	X	T495X476M025AS		11.8	6.0	200	908	817	363
68.0	*X	T495X686(1)025AS		17.0	8.0	200	908	817	363
<b>35 Volt Rating @ +85°C (23 Volt Rating at +125°C)</b>									
4.7	*C	T495C475(1)035AS		1.7	6.0	600	428	385	171
6.8	*D	T495D685(1)035AS		2.4	6.0	400	612	551	245
6.8	X	T495X685(1)035AS		1.9	4.0	300	742	667	297
6.8	X	T495X685(1)035AS4095	95158-20(1)(2)	1.9	4.0	300	742	667	297
10.0	D	T495D106(1)035AS		3.5	6.0	300	707	636	283
10.0	D	T495D106(1)035AS4095	95158-27(1)(2)	3.5	4.0	300	707	636	283
10.0	X	T495X106(1)035AS		2.8	4.0	250	812	731	325
10.0	X	T495X106(1)035AS4095	95158-21(1)(2)	2.8	4.0	250	812	731	325
15.0	*D	T495D156(1)035AS		5.3	6.0	300	707	636	283
15.0	*X	T495X156(1)035AS		5.3	6.0	225	856	771	343
15.0	*X	T495X156(1)035AS4095	95158-22(1)(2)	5.3	6.0	225	856	771	343
22.0	*D	T495D226(1)035AS		7.7	6.0	300	707	636	283
22.0	*X	T495X226(1)035AS		7.7	6.0	275	775	697	410
22.0	*X	T495X226(1)035AS4095	95158-23(1)(2)	7.7	6.0	300	742	667	297
33.0	*X	T495X336(1)035AS		11.6	6.0	250	812	731	325
47.0	*X	T495X476(1)035AS		16.5	8.0	300	742	667	297
<b>50 Volt Rating @ +85°C (33 Volt Rating at +125°C)</b>									
4.7	X	T495X475(1)050AS		1.9	4.0	300	742	667	297
4.7	X	T495X475(1)050AS4095	95158-24(1)(2)	1.9	4.0	300	742	667	297
6.8	*D	T495D685(1)050AS		3.4	8.0	300	700	600	300
15.0	*X	T495X156(1)050AS		7.5	8.0	300	742	667	297

- (1) To complete KEMET Part Number, insert M for  $\pm 20\%$  or K for  $\pm 10\%$  tolerance.
- (2) To complete KEMET Part Number, insert "B" for gold plated or "H" for solder plated termination finish.

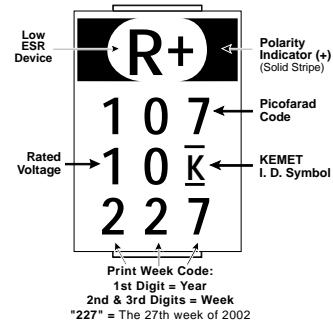
Higher voltage ratings and tighter capacitance tolerance product may be substituted within the same size at KEMET's option. Voltage substitutions will be marked with the higher voltage rating.

\*Extended Values      \*\*6 Volt product equivalent to 6.3 volt product.

### CONSTRUCTION



### CAPACITOR MARKINGS



### T495 TANTALUM CHIP CAPACITANCE VALUES

Case Size and Max. ESR (mΩ) by Capacitance & Voltage

*Standard Capacitance Values*

Capacitance		Rated Voltage @ +85°C						
μF	Code	6	10	16	20	25	35	50
4.7	475							X,300
6.8	685					C,500	X,300	
10.0	106						D,300 X,250	
15.0	156				D,275	D,275 X,200		
22.0	226		C,345		D,225	X,225		
33.0	336			D,225		X,175		
47.0	476		D,200		X,150			
68.0	686	D,175	D,150 X,150					
100.0	107		X,100					
150.0	157	X,100						
220.0	227							
330.0	337							

### *Extended Capacitance Values*

Capacitance		Rated Voltage @ +85°C							
μF	Code	4	6	10	16	20	25	35	50
4.7	475							C,600	
6.8	685							D,400	D,300
10.0	106				T,4000		C,450		
15.0	156							D,300 X,225	X,300
22.0	226						D,200	D,300 X,275	
33.0	336				C,275	D,200	D,300	X,250	
47.0	476				D,150	D,175	X,200	X,300	
68.0	686			B, 900 C, 225 V, 140	D,150	X,150	X,200		
100.0	107		B, 700 V, 150 C, 150	V, 150 D, 100 X, 80*	D, 125 X, 100 X, 80*				
150.0	157	B,90	C,200	D, 100 X, 100 V, 150	X,100				
220.0	227		C, 225 D, 100 X, 100	X,100 X,70*					
330.0	337	C,700	D, 100 X, 100 X, 65*	X,60 D,125					
470.0	477		X, 65 X, 50* D, 125						
1000.0	108	X,70							

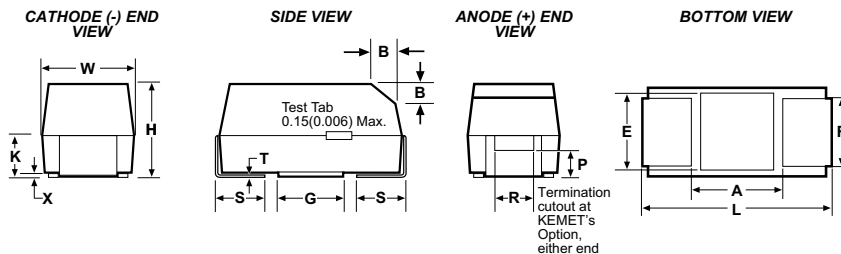
Note that standard values are preferred, especially where high surge currents are possible. Extended values are available to increase capacitance and reduce ESR. Note that standard CV values demonstrate inherently lower failure rates than extended CV values, especially in low impedance applications.

\* Super Low ESR limits available with part number suffix 4823.

### FEATURES

- Built-in fuse protects against damaging short circuit failure mode
- Precision-molded, laser-marked case
- Symmetrical, compliant terminations
- Taped and reeled per EIA 481-1
- Case geometry and footprints equivalent to Industrial Grade T491 Series. (Case sizes B, C, D and X only)
- 100% Surge Current test on C, D, X sizes
- Patented fuse assembly
- Fuse actuation, 25°C: within 1 second at fault currents of 4 amps and higher.
- Continuous current capability: 0.75 amps
- Post-actuation resistance, 25°C: 10 megohms minimum
- Test tabs on the sides of the case bypass the capacitor element to allow direct testing of the fuse assembly.

### OUTLINE DRAWINGS

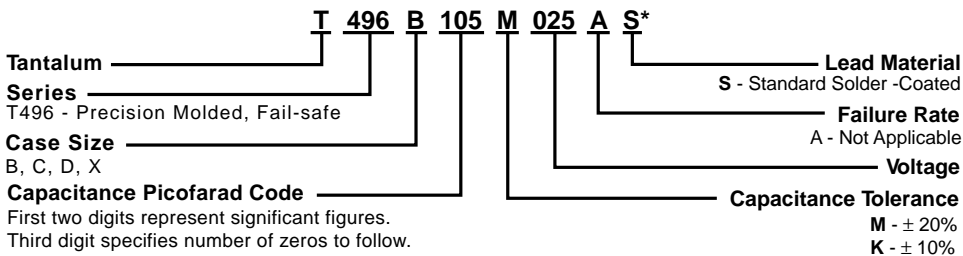


### DIMENSIONS — Millimeters (Inches)

CASE SIZE		COMPONENT													
KEMET	EIA	L	W	H	K ± 0.20 ± (.008)	F ± 0.1 ± (.004)	S ± 0.3 ± (.012)	B ± 0.15 (Ref) ± (.006)	X (Ref)	P (Ref)	R (Ref)	T (Ref)	A (Min)	G (Ref)	E (Ref)
B	3528-21	3.5 ± 0.2 (.138 ± .008)	2.8 ± 0.2 (.110 ± .008)	1.9 ± 0.2 (.075 ± .008)	1.1 (.043)	2.2 (.087)	0.8 (.031)	0.4 (.016)	0.10 ± 0.10 (.004 ± .004)	0.5 (.020)	1.0 (.039)	0.13 (.005)	1.1 (.043)	1.8 (.071)	2.2 (.087)
C	6032-28	6.0 ± 0.3 (.236 ± .012)	3.2 ± 0.3 (.126 ± .012)	2.5 ± 0.3 (.098 ± .012)	1.4 (.055)	2.2 (.087)	1.3 (.051)	0.5 (.020)	0.10 ± 0.10 (.004 ± .004)	0.9 (.035)	1.0 (.039)	0.13 (.005)	2.5 (.098)	2.8 (.110)	2.4 (.094)
D	7343-31	7.3 ± 0.3 (.287 ± .012)	4.3 ± 0.3 (.169 ± .012)	2.8 ± 0.3 (.110 ± .012)	1.5 (.059)	2.4 (.094)	1.3 (.051)	0.5 (.020)	0.10 ± 0.10 (.004 ± .004)	0.9 (.035)	1.0 (.039)	0.13 (.005)	3.8 (.150)	3.5 (.138)	3.5 (.138)
X	7343-43	7.3 ± 0.3 (.287 ± .012)	4.3 ± 0.3 (.169 ± .012)	4.0 ± 0.3 (.157 ± .012)	2.3 (.091)	2.4 (.094)	1.3 (.051)	0.5 (.020)	0.10 ± 0.10 (.004 ± .004)	1.7 (.067)	1.0 (.039)	0.13 (.005)	3.8 (.150)	3.5* (.138)	3.5* (.138)

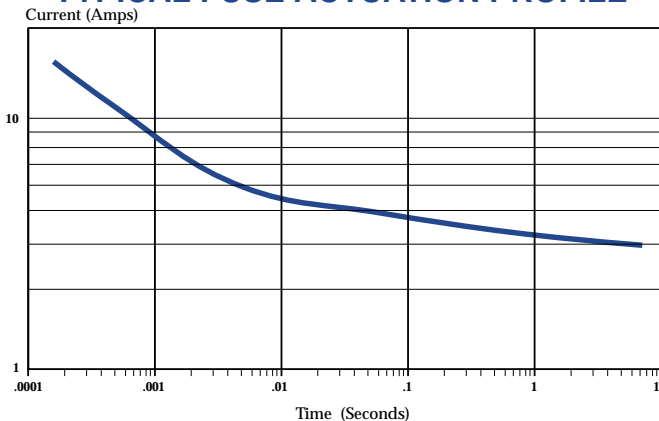
Notes: 1. Metric dimensions govern.  
 2. (Ref) - Dimensions provided for reference only.  
 \* Round glue pad: 2.9 ± 0.1mm (.114" ± .004") in diameter at KEMET's option.

### T496 Series – ORDERING INFORMATION



\* Part Number Example: T496B105M025AS (14 digits - no spaces)

### TYPICAL FUSE ACTUATION PROFILE

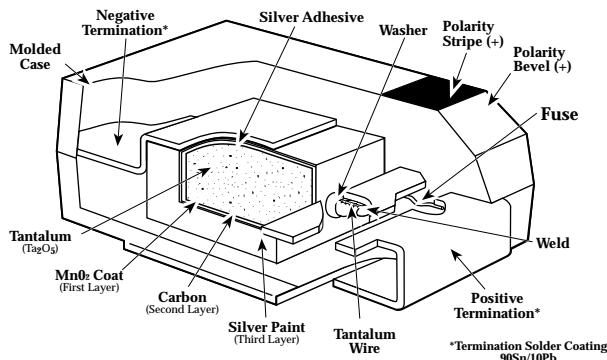


### T496 RATINGS & PART NUMBER REFERENCE

Capacitance $\mu\text{F}$	Case Size	KEMET Part Number	DCL $\mu\text{A}$ @ +25°C Max.	DF % @ +25°C 120 Hz. Max.	ESR $\Omega$ @ +25°C 100 kHz Max.
<b>4 Volt Rating at +85°C (2.7 Volt Rating at +125°C)</b>					
68.0	*C	T496C686(1)004AS	2.7	6.0	1.6
100.0	*C	T496C107(1)004AS	4.0	8.0	1.2
150.0	D	T496D157(1)004AS	6.0	8.0	0.8
220.0	*D	T496D227(1)004AS	8.8	8.0	0.7
#330.0	*D	T496D337(1)004AS	13.2	8.0	0.7
330.0	*X	T496X337(1)004AS	13.2	8.0	0.7
#470.0	*X	T496X477(1)004AS	18.8	8.0	0.5
<b>**6 Volt Rating at +85°C (4 Volt Rating at +125°C)</b>					
4.7	B	T496B475(1)006AS	0.5	6.0	3.5
6.8	B	T496B685(1)006AS	0.5	6.0	3.5
10.0	B	T496B106(1)006AS	0.6	6.0	3.5
22.0	B	T496B226(1)006AS	1.3	6.0	3.5
15.0	C	T496C156(1)006AS	0.9	6.0	2.0
22.0	C	T496C226(1)006AS	1.4	6.0	2.0
33.0	C	T496C336(1)006AS	2.0	6.0	2.0
47.0	D	T496D476(1)006AS	2.9	6.0	1.0
47.0	*C	T496C476(1)006AS	2.9	6.0	1.6
68.0	D	T496D686(1)006AS	4.1	6.0	1.0
#68.0	*C	T496C686(1)006AS	4.1	6.0	1.2
100.0	X	T496X107(1)006AS	6.0	8.0	0.9
100.0	D	T496D107(1)006AS	6.0	8.0	0.8
150.0	*D	T496D157(1)006AS	9.0	8.0	0.7
#220.0	*D	T496D227(1)006AS	13.2	8.0	0.7
220.0	*X	T496X227(1)006AS	13.2	8.0	0.7
#330.0	*X	T496X337(1)006AS	19.8	8.0	0.5
<b>10 Volt Rating at +85°C (7 Volt Rating at +125°C)</b>					
3.3	B	T496B335(1)010AS	0.5	6.0	3.5
4.7	B	T496B475(1)010AS	0.5	6.0	3.5
6.8	B	T496B685(1)010AS	0.7	6.0	3.5
15.0	B	T496B156(1)010AS	1.5	6.0	3.5
10.0	C	T496C106(1)010AS	1.0	6.0	2.0
15.0	C	T496C156(1)010AS	1.5	6.0	2.0
22.0	C	T496C226(1)010AS	2.2	6.0	2.0
33.0	D	T496D336(1)010AS	3.3	6.0	1.0
33.0	*C	T496C336(1)010AS	3.3	6.0	1.6
47.0	D	T496D476(1)010AS	4.7	6.0	1.0
#47.0	*C	T496C476(1)010AS	4.7	6.0	1.2
68.0	X	T496X686(1)010AS	6.8	6.0	0.9
68.0	D	T496D686(1)010AS	6.8	6.0	0.8
100.0	D	T496D107(1)010AS	10.0	8.0	0.7
150.0	*X	T496X157(1)010AS	15.0	8.0	0.7
#150.0	*D	T496D157(1)010AS	15.0	8.0	0.7
#220.0	*X	T496X227(1)010AS	22.0	8.0	0.5
<b>16 Volt Rating at +85°C (10 Volt Rating at +125°C)</b>					
2.2	B	T496B225(1)016AS	0.5	6.0	3.5
3.3	B	T496B335(1)016AS	0.5	6.0	3.5
4.7	B	T496B475(1)016AS	0.8	6.0	3.5
10.0	B	T496B106(1)016AS	1.6	6.0	3.5
6.8	C	T496C685(1)016AS	1.1	6.0	2.0
10.0	C	T496C106(1)016AS	1.6	6.0	2.0
15.0	C	T496C156(1)016AS	2.4	6.0	2.0
22.0	D	T496D226(1)016AS	3.6	6.0	1.0
22.0	*C	T496C226(1)016AS	3.6	6.0	1.6
33.0	D	T496D336(1)016AS	5.3	6.0	1.0
47.0	X	T496X476(1)016AS	7.5	6.0	0.9
47.0	D	T496D476(1)016AS	7.5	6.0	0.8
100.0	*X	T496X107(1)016AS	16.0	8.0	0.7

\*\* Note: 6V rating equivalent to 6.3 rating \*Extended Ratings  
# Maximum capacitance change @ 125°C = +15% (all others =12%)

### T496 SERIES CONSTRUCTION



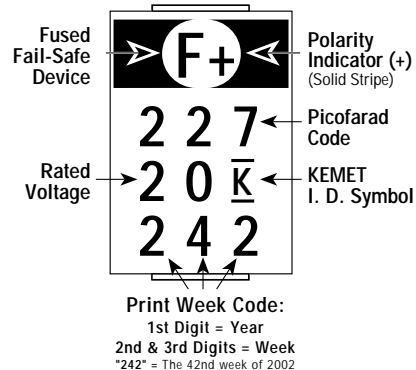
Capacitance $\mu\text{F}$	Case Size	KEMET Part Number	DCL $\mu\text{A}$ @ +25°C Max.	DF % @ +25°C 120 Hz. Max.	ESR $\Omega$ @ +25°C 100 kHz Max.
<b>20 Volt Rating at +85°C (13 Volt Rating at +125°C)</b>					
1.5	B	T496B155(1)020AS	0.5	6.0	5.0
2.2	B	T496B225(1)020AS	0.5	6.0	3.5
3.3	B	T496B335(1)020AS	0.7	6.0	3.5
4.7	C	T496C475(1)020AS	1.0	6.0	2.0
6.8	C	T496C685(1)020AS	1.4	6.0	2.0
10.0	C	T496C106(1)020AS	2.0	6.0	2.0
15.0	D	T496D156(1)020AS	3.0	6.0	1.0
22.0	D	T496D226(1)020AS	4.4	6.0	1.0
33.0	X	T496X336(1)020AS	6.6	6.0	0.9
<b>25 Volt Rating at +85°C (17 Volt Rating at +125°C)</b>					
0.68	B	T496B684(1)025AS	0.5	4.0	6.5
1.0	B	T496B105(1)025AS	0.5	4.0	5.0
1.5	B	T496B155(1)025AS	0.5	6.0	5.0
2.2	C	T496C225(1)025AS	0.6	6.0	3.5
3.3	C	T496C335(1)025AS	0.9	6.0	2.5
4.7	C	T496C475(1)025AS	1.2	6.0	2.5
6.8	C	T496C685(1)025AS	1.7	6.0	2.0
10.0	D	T496D106(1)025AS	2.5	6.0	1.2
15.0	D	T496D156(1)025AS	3.8	6.0	1.0
22.0	X	T496X226(1)025AS	5.5	6.0	0.9
22.0	D	T496D226(1)025AS	5.5	6.0	0.8
<b>35 Volt Rating at +85°C (23 Volt Rating at +125°C)</b>					
0.47	B	T496B474(1)035AS	0.5	4.0	8.0
0.68	B	T496B684(1)035AS	0.5	4.0	6.5
1.0	B	T496B105(1)035AS	0.5	4.0	5.0
1.5	C	T496C155(1)035AS	0.5	6.0	4.5
2.2	C	T496C225(1)035AS	0.8	6.0	3.5
3.3	C	T496C335(1)035AS	1.2	6.0	2.5
4.7	D	T496D475(1)035AS	1.7	6.0	1.5
6.8	D	T496D685(1)035AS	2.4	6.0	1.3
10.0	X	T496X106(1)035AS	3.5	6.0	1.0
15.0	*X	T496X156(1)035AS	5.3	6.0	0.9
<b>50 Volt Rating at +85°C (33 Volt Rating at +125°C)</b>					
0.15	B	T496B154(1)050AS	0.5	4.0	16.0
0.22	B	T496B224(1)050AS	0.5	4.0	14.0
0.33	B	T496B334(1)050AS	0.5	4.0	10.0
0.47	C	T496C474(1)050AS	0.5	4.0	8.0
0.68	C	T496C684(1)050AS	0.5	4.0	7.0
1.0	C	T496C105(1)050AS	0.5	4.0	5.5
1.5	C	T496C155(1)050AS	0.8	6.0	5.0
2.2	D	T496D225(1)050AS	1.1	6.0	2.5
3.3	D	T496D335(1)050AS	1.7	6.0	2.0
4.7	X	T496X475(1)050AS	2.4	6.0	1.5

(1) To complete KEMET Part Number, insert M for  $\pm 20\%$  tolerance or K for  $\pm 10\%$  tolerance.

Higher voltage ratings and tighter capacitance tolerance product may be substituted within the same size at KEMET's option. Voltage substitutions will be marked with the higher voltage rating.

### CAPACITOR MARKINGS

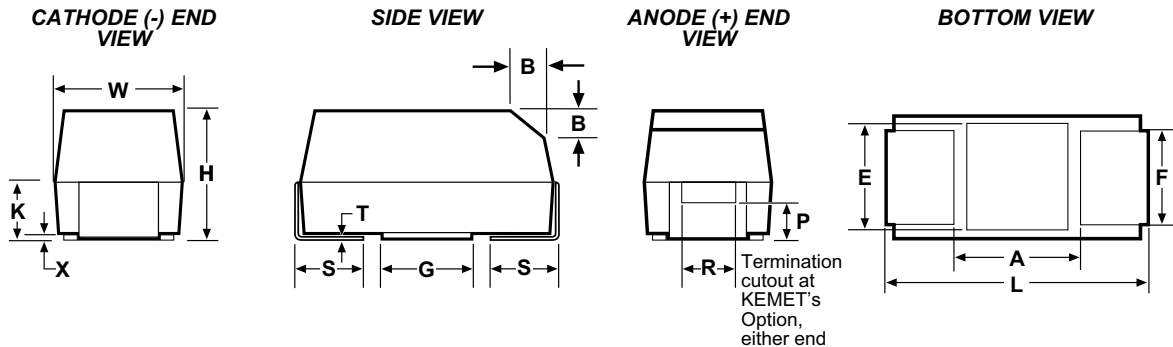
T496 Series — All Case Sizes



### FEATURES

- Ultra Low ESR < 30 mΩ
- New E/7260 Case with ESR < 18 mΩ
- Up to 4 Amps ripple current
- 100% accelerated steady-state aging
- 100% Surge current test
- Precision - molded, laser-marked case
- Symmetrical compliant terminations
- Taped and reeled per EIA 481-1

### OUTLINE DRAWING



### DIMENSIONS - Millimeters (Inches)

CASE SIZE		COMPONENT													
KEMET	EIA	L	W	H	K ± 0.20 ± (.008)	F ± 0.1 ± (.004)	S ± 0.3 ± (.012)	B ± 0.15 (Ref) ± (.006)	X (Ref)	P (Ref)	R (Ref)	T (Ref)	A (Min)	G (Ref)	E (Ref)
X	7343-43	7.3 ± 0.3 (.287 ± .012)	4.3 ± 0.3 (.169 ± .012)	4.0 ± 0.3 (.157 ± .012)	2.3 (.091)	2.4 (.094)	1.3 (.051)	0.5 (.020)	0.10 ± 0.10 (.004 ± .004)	0.9 (.035)	1.0 (.039)	0.13 (.005)	3.8 (.150)	3.5 (.138)	3.5 (.138)
E	7260-38	7.3 ± 0.3 (.287 ± .012)	6.0 ± 0.3 (.236 ± .012)	3.6 ± 0.2 (.142 ± .008)	2.3 (.091)	4.1 (.161)	1.3 (.051)	0.5 (.020)	0.10 ± 0.10 (.004 ± .004)	0.9 (.035)	1.0 (.039)	0.13 (.005)	3.8 (.150)	3.5 (.138)	3.5 (.138)

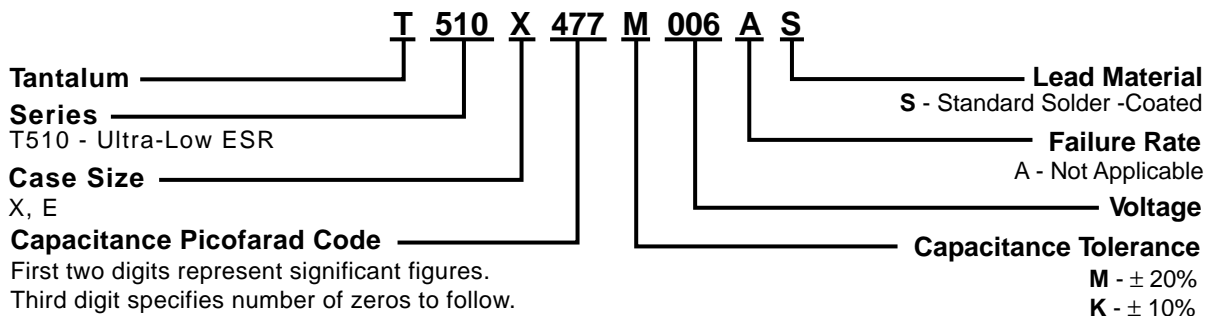
Notes: Metric Dimensions govern  
(Ref) - Dimensions provided for reference only.

### T510 RATINGS & PART NUMBER REFERENCE

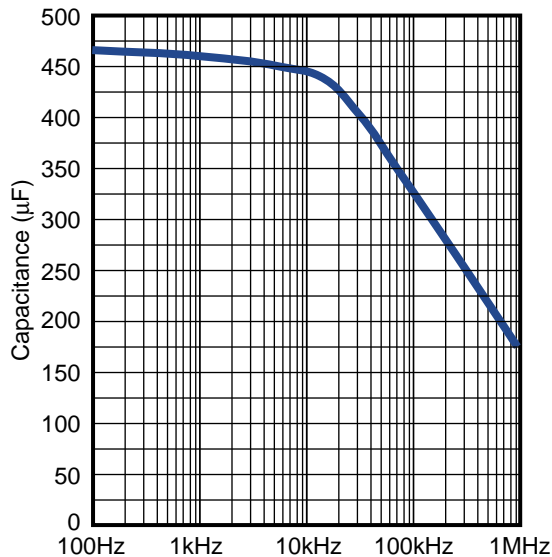
Cap. μF	Case Size	KEMET Part Number	DC Leakage μA @ 25°C Max	DF % @ 25°C 120Hz Max	ESR mΩ @ 25°C 100 kHz Max	Ripple Current A rms @ 25°C 100 kHz, max		
						25°C	85°C	125°C
<b>4 Volt Rating at +85°C (2.7 Volt Rating at 125°C)</b>								
680	X	T510X687(1)004AS	27.2	6.0	30	3.0	2.7	1.2
1,000	E	T510E108(1)004AS	40.0	6.0	18	4.0	3.6	1.6
1,000	E	T510E108(1)004AS4115	40.0	6.0	10	5.3	4.8	2.1
<b>6/6.3 Volt Rating at +85°C (4 Volt Rating at 125°C)</b>								
470	X	T510X477(1)006AS	28.2	6.0	30	3.0	2.7	1.2
680	E	T510E687(1)006AS	40.8	6.0	23	3.5	3.2	1.4
680	E	T510E687(1)006AS4115	40.8	6.0	12	4.8	4.3	1.9
<b>10 Volt Rating at +85°C (7 Volt Rating at 125°C)</b>								
330	X	T510X337(1)010AS	33.0	6.0	35	2.8	2.5	1.1

(1) To complete the KEMET part number, insert "K" - ±10% or "M" - ±20% capacitance tolerance.

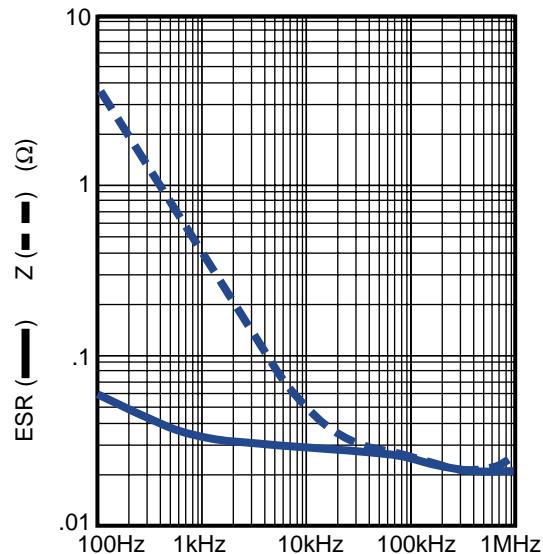
### T510 ORDERING INFORMATION



**TYPICAL CAP FREQUENCY SCAN @25°C**  
**T510X477M006AS**

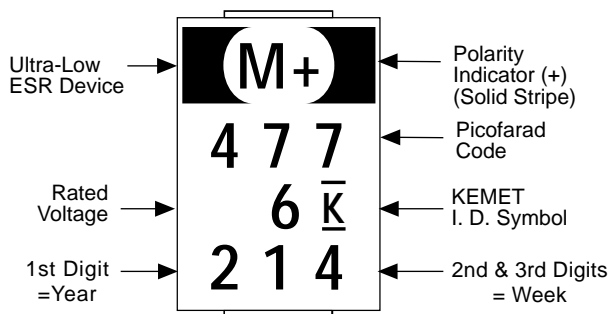


**TYPICAL ESR/Z FREQUENCY SCAN @25°C**  
**T510X477M006AS**



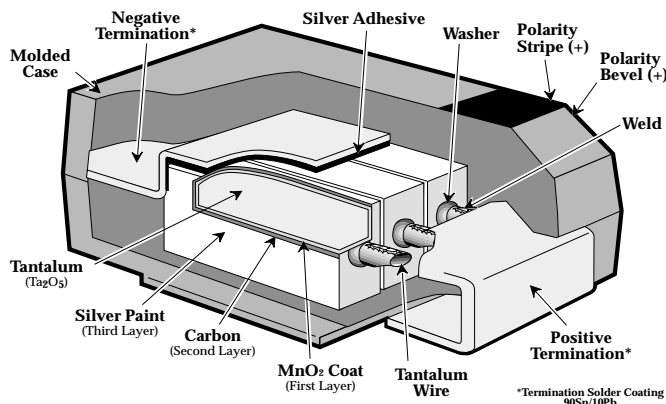
Solid Tantalum Surface Mount

### CAPACITOR MARKINGS

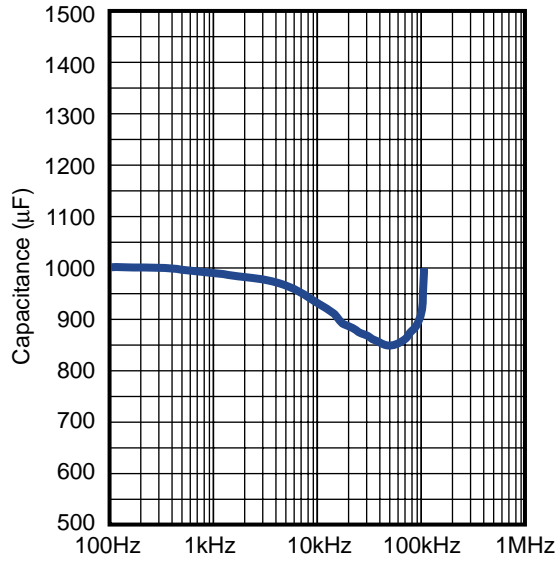


"214" = The 14th week of 2002.

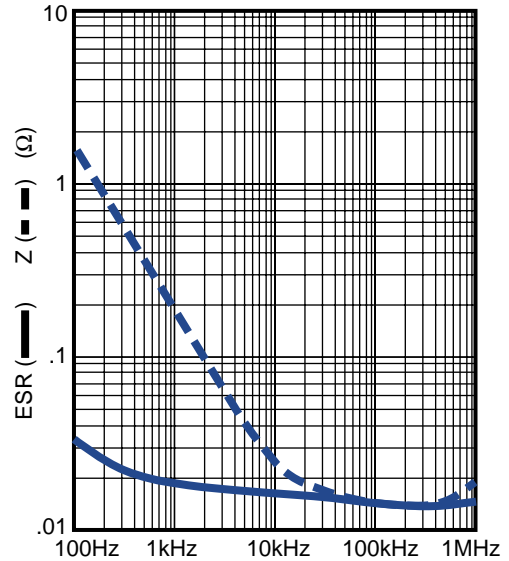
### T510 SERIES CONSTRUCTION



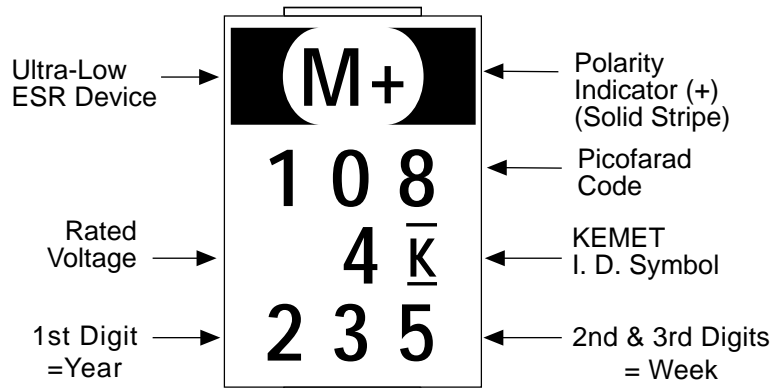
**TYPICAL CAP FREQUENCY SCAN @ 25°C**  
T510E108M004AS



**TYPICAL ESR/Z FREQUENCY SCAN @ 25°C**  
T510E108M004AS



**CAPACITOR MARKINGS**



**T510E SERIES CONSTRUCTION**





## COMPONENT PERFORMANCE CHARACTERISTICS

### Introduction

KEMET has developed a new type of tantalum capacitor that replaces the solid manganese dioxide electrode with a solid conductive polymer. This product is named the KO-CAP for **KEMET Organic Capacitor**. The basic families are the T520 and T530 series. A separate detail of performance characteristics is presented here as there are some differences between the polymer tantalums and the standard MnO<sub>2</sub> types. Like all KEMET tantalum chips, these series are 100% screened for all electrical parameters: Capacitance @ 120 Hz, Dissipation Factor (DF) @ 120 Hz, ESR @ 100 kHz and DC Leakage. It is also 100% surge current tested at full rated voltage through a low impedance circuit. The advantages of the polymer include very low ESR and elimination of the potentially catastrophic failure mode that may occur with standard tantalum capacitors in a high surge current application. Although the natural KO-CAP series failure mechanism is a short circuit, it does not exhibit an explosive failure mode.

## ELECTRICAL

### 1. Operating Temperature Range

- -55°C to +105°C

Above 85°C, the voltage rating is reduced linearly from 1.0 x rated voltage to 0.8 x rated voltage at 105°C.

### 2. Non-Operating Temperature Range

- -55°C to +105°C

### 3. Capacitance and Tolerance

- 33µF to 1500µF
- ±20% Tolerance

Capacitance is measured at 120 Hz, up to 1.0 volt rms maximum and up to 2.5V DC maximum. DC bias causes only a small reduction in capacitance, up to about 2% when full rated voltage is applied. DC bias is not commonly used for room temperature measurements but is more commonly used when measuring at temperature extremes.

Capacitance does decrease with increasing frequency, but not nearly as much or as quickly as standard tantalums. Figure 1 compares the frequency induced cap roll-off between the KO-CAP and traditional MnO<sub>2</sub> types. Capacitance also increases with increasing temperature. See section 12 for temperature coefficients.

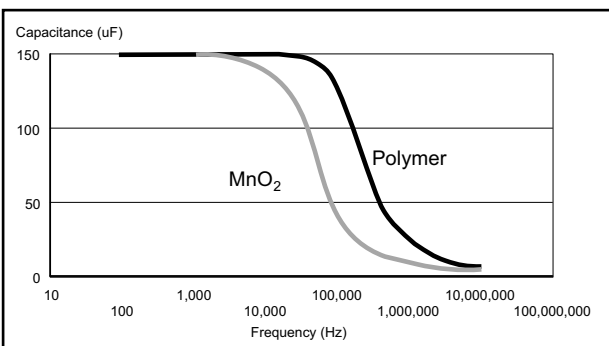


FIGURE 1

### 4. Voltage Ratings

- 2V-16V DC Rated Voltage

This is the maximum peak DC operating voltage from -55°C to +85°C for continuous duty. Above 85°C, this voltage is derated linearly to 0.8 times the rated voltage for operation at 105°C.

- Surge Voltage Ratings

Surge voltage is the maximum voltage to which the part can be subjected under transient conditions including the sum of peak AC ripple, DC bias and any transients. Surge voltage capability is demonstrated by application of 1000 cycles of the relevant voltage, at 25°C, 85°C or 105°C. The parts are charged through a 33 ohm resistor for 30 seconds and then discharged through a 33 ohm resistor for 30 seconds for each cycle.

#### • Voltage Ratings • Table 1

Rated Voltage	Surge Voltage	Derated Voltage	Derated Surge Voltage
-55°C to +85°C		+105°C	
2V	2.6V	1.6V	2.1V
2.5V	3.3V	2.0V	2.8V
3V	3.9V	2.4V	3.1V
4V	5.2V	3.3V	4.3V
6.3V	8V	5V	6.5V
8V	10.4V	6.4V	8.7V
10V	13V	8V	10.4V
16V	20.8V	12.8V	16.6V

### 5. Reverse Voltage Rating & Polarity

Polymer tantalum capacitors are polar devices and may be permanently damaged or destroyed if connected in the wrong polarity. The positive terminal is identified by a laser-marked stripe and may also include a beveled edge. These capacitors will withstand a small degree of transient voltage reversal for short periods as shown in the following table. Please note that these parts may not be operated continuously in reverse, even within these limits.

Table 2

Temperature	Permissible Transient Reverse Voltage
25°C	15% of Rated Voltage
55°C	10% of Rated Voltage
85°C	5% of Rated Voltage
105°C	3% of Rated Voltage

### 6. DC Leakage Current

Because of the high conductivity of the polymer, the KO-CAP family has higher leakage currents than traditional MnO<sub>2</sub> type Tantalum caps. The DC Leakage limits at 25°C are calculated as 0.1 x C x V, where C is cap in µF and V is rated voltage in Volts. Limits for all part numbers are listed in the ratings tables.

DC Leakage current is the current that flows through the capacitor dielectric after a five minute charging period at rated voltage. Leakage is measured at 25°C with full rated voltage applied to the capacitor through a 1000 ohm resistor in series with the capacitor.

## COMPONENT PERFORMANCE CHARACTERISTICS

DC Leakage current does increase with temperature. The limits for 85°C @ Rated Voltage and 105°C @ 0.8 x Rated Voltage are both 10 times the 25°C limit.

### 7. Surge Current Capability

Certain applications may induce heavy surge currents when circuit impedance is very low (<0.1 ohm per volt). Driving inductance may also cause voltage ringing. Surge currents may appear as transients during turn-on of equipment.

The KO-CAP has a very high tolerance for surge current. And although the failure mechanism is a short circuit, they do not explode as may occur with standard tantalums in such applications.

The KO-CAP series receives 100% screening for surge current in our production process. Capacitors are surged 4 times at full rated voltage applied through a total circuit resistance of <0.5 ohms. Failures are removed during subsequent electrical testing.

### 8. Dissipation Factor (DF)

Refer to part number tables for maximum DF limits.

Dissipation factor is measured at 120 Hz, up to 1.0 volt rms maximum, and up to 2.5 volts DC maximum at +25°C. The application of DC bias causes a small reduction in DF, about 0.2% when full rated voltage is applied. DF increases with increasing frequency.

Dissipation factor is the ratio of the equivalent series resistance (ESR) to the capacitive reactance, ( $X_c$ ) and is usually expressed as a percentage. It is directly proportional to both capacitance and frequency. Dissipation factor loses its importance at higher frequencies, (above about 1 kHz), where impedance ( $Z$ ) and equivalent series resistance (ESR) are the normal parameters of concern.

$$DF = \frac{R}{X_c} = 2 \pi f CR$$

DF = Dissipation Factor  
 R = Equivalent Series Resistance (Ohms)  
 $X_c$  = Capacitive Reactance (Ohms)  
 f = Frequency (Hertz)  
 C = Series Capacitance (Farads)

DF is also referred to as  $\tan \delta$  or "loss tangent." The "Quality Factor," "Q," is the reciprocal of DF.

### 9. Equivalent Series Resistance (ESR) and Impedance (Z)

The Equivalent Series Resistance (ESR) of the KO-CAP is much lower than standard Tantalum caps because the polymer cathode has much higher conductivity. ESR is not a pure resistance, and it decreases with increasing frequency.

Total impedance of the capacitor is the vector sum of capacitive reactance ( $X_c$ ) and ESR, below resonance; above resonance total impedance is the vector sum of inductive reactance ( $X_L$ ) and ESR.

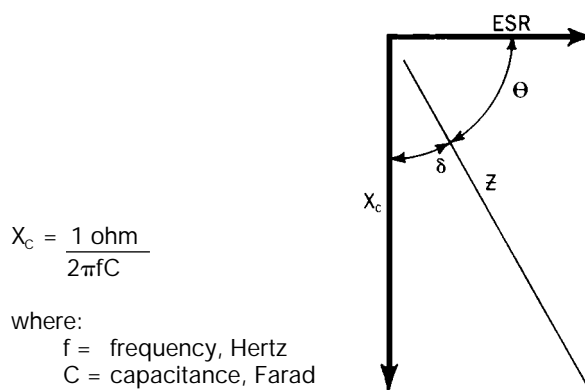


FIGURE 2a Total Impedance of the Capacitor Below Resonance

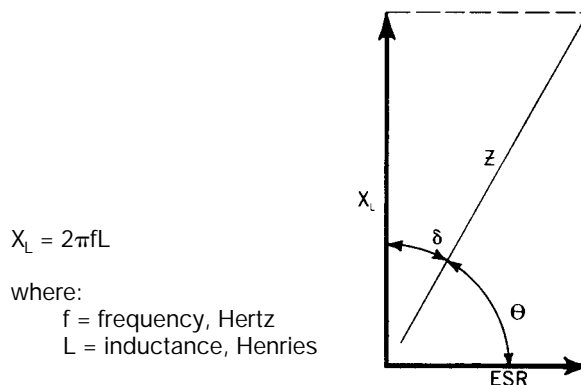


FIGURE 2b Total Impedance of the Capacitor Above Resonance

To understand the many elements of a capacitor, see Figure 3.

## COMPONENT PERFORMANCE CHARACTERISTICS

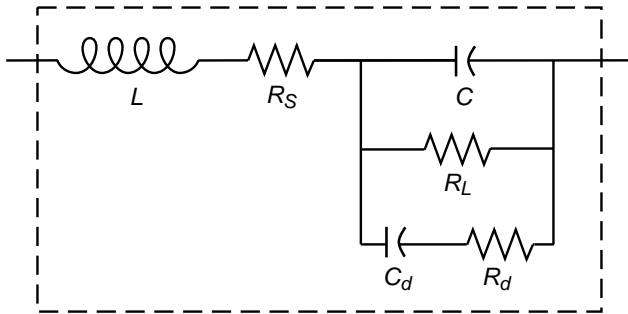


FIGURE 3 The Real Capacitor

A capacitor is a complex impedance consisting of many series and parallel elements, each adding to the complexity of the measurement system.

$L$  — Represents lead wire and construction inductance. In most instances (especially in solid tantalum and monolithic ceramic capacitors) it is insignificant at the basic measurement frequencies of 120 and 1000 Hz.

$R_s$  — Represents the actual ohmic series resistance in series with the capacitance. Lead wires and capacitor electrodes are contributing sources.

$R_L$  — Capacitor Leakage Resistance. Typically it can reach 50,000 megohms in a tantalum capacitor. It can exceed  $10^{12}$  ohms in monolithic ceramics and in film capacitors.

$R_d$  — The dielectric loss contributed by dielectric absorption and molecular polarization. It becomes very significant in high frequency measurements and applications. Its value varies with frequency.

$C_d$  — The inherent dielectric absorption of the solid tantalum capacitor which typically equates to 1-2% of the applied voltage.

As frequency increases,  $X_c$  continues to decrease according to its equation above. There is unavoidable inductance as well as resistance in all capacitors, and at some point in frequency, the reactance ceases to be capacitive and becomes inductive. This frequency is called the self-resonant point. In solid tantalum capacitors, the resonance is damped by the ESR, and a smooth, rather than abrupt, transition from capacitive to inductive reactance follows.

Figure 4 compares the frequency response of a KO-CAP to a standard Tantalum chip. See also frequency curves shown in the T520 section, p.39. Maximum limits for 100 kHz ESR are listed in the part number tables for each series.

The T530 Capacitance, Impedance and ESR vs. Frequency Comparisons are located on page 43. Maximum limits for 100 kHz are listed in the part number table on page 42.

### ESR and Impedance

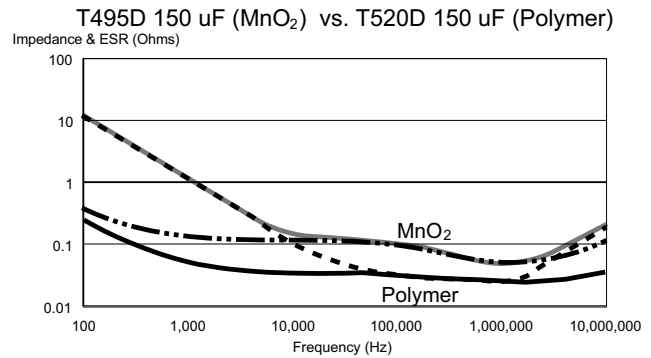


FIGURE 4

### 10. AC Power Dissipation

Power dissipation is a function of capacitor size and materials. Maximum power ratings have been established for all case sizes to prevent overheating. In actual use, the capacitor's ability to dissipate the heat generated at any given power level may be affected by a variety of circuit factors. These include board density, pad size, heat sinks and air circulation.

Table 3  
Tantalum Chip Power Dissipation Ratings

Case Code		Maximum Power Dissipation mWatts @ +25°C w/+20°C Rise
KEMET	EIA	
T520/T	3528-12	70
T520/B	3528-21	85
T520/V	7343-20	125
T520/D	7343-31	150
T520/Y	7343-40	156
T520/X	7343-43	165
T530/D	7343-31	255
T530/X	7343-43	270
T530/E	7260-38	285

### 11. AC Operation

Permissible AC ripple voltage and current are related to equivalent series resistance (ESR) and power dissipation capability.

Permissible AC ripple voltage which may be applied is limited by three criteria:

- The positive peak AC voltage plus the DC bias voltage, if any, must not exceed the DC voltage rating of the capacitor.
- The negative peak AC voltage, in combination with bias voltage, if any, must not exceed the permissible reverse voltage ratings presented in Section 5.
- The power dissipated in the ESR of the capacitor must not exceed the appropriate value specified in Section 10.

## COMPONENT PERFORMANCE CHARACTERISTICS

Actual power dissipated may be calculated from the following:

$$P = I^2R$$

$$\text{Substituting } I = \frac{E}{Z} \quad P = \frac{E^2R}{Z^2}$$

where:

I = rms ripple current (amperes)

E = rms ripple voltage (volts)

P = power (watts)

Z = impedance at specified frequency (ohms)

R = equivalent series resistance at specified frequency (ohms)

Using P max from Table 3, maximum allowable rms ripple current or voltage may be determined as follows:

$$I(\text{max}) = \sqrt{P \text{ max}/R} \quad E(\text{max}) = Z \sqrt{P \text{ max}/R}$$

These values should be derated at elevated temperatures as follows:

Temperature	Derating Factor
85°C	.9
105°C	.4

## ENVIRONMENTAL

### 12. Temperature Stability

Mounted capacitors withstand extreme temperature testing at a succession of continuous steps at +25°C, -55°C, +25°C, +85°C, +105°C, +25°C in that order. Capacitors are allowed to stabilize at each temperature before measurement. Cap, DF, and DCL are measured at each temperature except DC Leakage is not measured at -55°C.

**Table 4**

Acceptable limits are as follows:

Step	Temp.	ΔCap	DCL	DF
1	+25°C	Specified Tolerance	Catalog Limit	Catalog Limit
2	-55°C	±20% of initial value	N/A	Catalog Limit
3	+25°C	±10% of initial value	Catalog Limit	Catalog Limit
4	+85°C	±20% of initial value	10x Catalog Limit	1.2x Catalog Limit
5	+105°C	±30% of initial value	10x Catalog Limit	1.5x Catalog Limit
6	+25°C	±10% of initial value	Catalog Limit	Catalog Limit

### 13. Standard Life Test

• **85°C, Rated Voltage, 2000 Hours**

Post Test Performance:

- Capacitance: within -20%/+10% of initial value
- DF: within initial limit
- DC Leakage: within initial limit
- ESR: within initial limit

### 14. High Temperature Life Test

• **105°C, 0.8 x Rated Voltage, 2000 hours**

Post Test Performance:

- Capacitance: within -20%/+10% of initial value
- DF: within initial limit
- DC Leakage: within 1.25 x initial limit
- ESR: within 2 x initial limit

### 15. Storage Life Test

• **105°C, 0VDC, 2000 Hours**

Post Test Performance:

- Capacitance: within -20%/+10% of initial value
- DF: within initial limit
- DC Leakage: within 1.25 x initial limit
- ESR: within 2 x initial limit

### 16. Thermal Shock

• **Mil-Std-202, Method 107, Condition B**

Minimum temperature is -55°C

Maximum temperature is +105°C

500 Cycles

Post Test Performance:

- Capacitance: within +10%/-20% of initial value
- DF: within initial limit
- DC Leakage: within initial limit
- ESR: within 2 x initial limit

### 17. Moisture Resistance Testing

• **J-Std-020**

Steps 7a and 7b excluded, 0V, 21 cycles

Post Test Performance:

- Capacitance: within ±30% of initial value
- DF: within initial limit
- DC Leakage: within initial limit
- ESR: within initial limit

### 18. Load Humidity

• **85°C, 85% RH, Rated Voltage, 500 Hours**

Post Test Performance:

- Capacitance: within +35%/-5% of initial value
- DF: within initial limit
- DC Leakage: within 5 x initial limit
- ESR: within 2 x initial limit

### 19. ESD

• **Polymer tantalum capacitors are not sensitive to Electro-Static Discharge (ESD).**

### 20. Failure Mechanism and Reliability

The normal failure mechanism is dielectric breakdown. Dielectric failure can result in high DC Leakage current and may proceed to the level of a short circuit. With sufficient time to charge, healing may occur by one of two potential mechanisms. The polymer adjacent to the dielectric fault site may overheat and vaporize, disconnecting the fault site from the circuit. The polymer may also

**COMPONENT PERFORMANCE CHARACTERISTICS**

oxidize into a more resistive material that plugs the defect site in the dielectric and reduces the flow of current.

Capacitor failure may be induced by exceeding the rated conditions of forward DC voltage, reverse DC voltage, surge current, power dissipation or temperature. Excessive environmental stress, such as prolonged or high temperature reflow processes may also trigger dielectric failure.

Failure rates may be improved in application by derating the voltage applied to the capacitor. KEMET recommends that KO-CAPs be derated to 80% or less of the rated voltage in application.

KO-CAPs exhibit a benign failure mode in that they do not fail catastrophically even under typical fault conditions. If a shorted capacitor is allowed to pass unlimited current, it may overheat and the case may discolor. But this is distinctly different from the explosive "ignition" that may occur with standard MnO<sub>2</sub> cathode tantalums. Replacement of the MnO<sub>2</sub> by the polymer removes the oxygen that fuels ignition during a failure event.

**MECHANICAL**

**21. Resistance to Solvents**

- *Mil-Std-202, Method 215*

Post Test Performance:

- a. Capacitance — within ±10% of initial value
- b. DC Leakage — within initial limit
- c. Dissipation Factor — within initial limit
- d. ESR — within initial limit
- e. Physical — no degradation of case, terminals or marking

**22. Fungus**

- *Mil-Std-810, Method 508*

**23. Flammability**

- *UL94 VO Classification*

Encapsulant materials meet this classification

**24. Resistance to Soldering Heat**

- *Maximum Reflow*  
*+240 ±5°C, 10 seconds*
- *Typical Reflow*  
*+230 ±5°C, 30 seconds*

Post Test Performance:

- a. Capacitance — within ±10% of initial value
- b. DC Leakage — within initial limit
- c. Dissipation Factor — within initial limit
- d. ESR — within initial limit

**25. Solderability**

- *Mil-Std-202, Method 208*
- *ANSI/J-STD-002, Test B*

Applies to Solder Coated terminations only.

**26. Vibration**

- *Mil-Std-202, Method 204, Condition D, 10 Hz to 2,000 Hz, 20G Peak*

Post Test Performance:

- a. Capacitance — within ±10% of initial value
- b. DC Leakage — within initial limit
- c. Dissipation Factor — within initial limit
- d. ESR — within initial limit

**27. Shock**

- *Mil-Std-202, Method 213, Condition I, 100 G Peak*

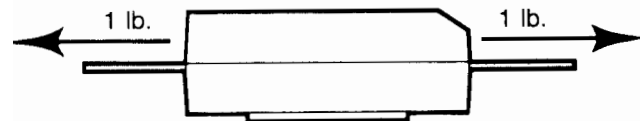
Post Test Performance:

- a. Capacitance — within ±10% of initial value
- b. DC Leakage — within initial limit
- c. Dissipation Factor — within initial limit
- d. ESR - within initial limit

**28. Terminal Strength**

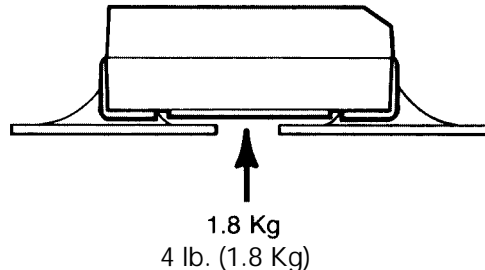
- **Pull Force**

- *One Pound (454 grams), 30 Seconds*



- **Tensile Force**

- *Four Pounds (1.8 kilograms), 60 Seconds*



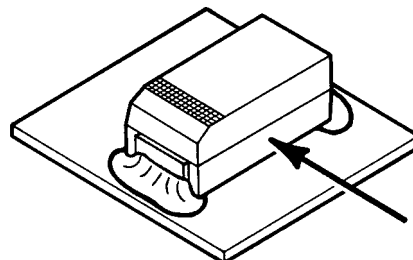
- **Shear Force**

**Table 5 Maximum Shear Loads**

Case Code		Maximum Shear Loads	
KEMET	EIA	Kilograms	Pounds
B	3528-21	3.6	8.0
V	7343-20	5.0	11.0
D	7343-31	5.0	11.0
X	7343-43	5.0	11.0

Post Test Performance:

- a. Capacitance — within ±5% of initial value
- b. DC Leakage — within initial limit
- c. Dissipation Factor — within initial limit
- d. ESR - within initial limit



Polymer Tantalum Surface Mount

## COMPONENT PERFORMANCE CHARACTERISTICS APPLICATIONS

### 29. Handling

Automatic handling of encapsulated components is enhanced by the molded case which provides compatibility with all types of high speed pick and place equipment. Manual handling of these devices presents no unique problems. Care should be taken with your fingers, however, to avoid touching the solder-coated terminations as body oils, acids and salts will degrade the solderability of these terminations. Finger cots should be used whenever manually handling all solderable surfaces.

### 30. Termination Coating

The standard finish coating is 90/10 Sn/Pb solder (Tin/Lead-solder coated). 100% tin coating is available upon request.

### 31. Recommended Mounting Pad Geometries

Proper mounting pad geometries are essential for successful solder connections. These dimensions are highly process sensitive and should be designed to maximize the integrity of the solder joint, and to minimize component rework due to unacceptable solder joints.

Figure 5 illustrates pad geometry. The table provides recommended pad dimensions for reflow soldering techniques. These dimensions are intended to be a starting point for circuit board designers, to be fine tuned, if necessary, based upon the peculiarities of the soldering process and/or circuit board design.

Contact KEMET for Engineering Bulletin Number F-2100 entitled "Surface Mount Mounting Pad Dimensions and Considerations" for further details on this subject.

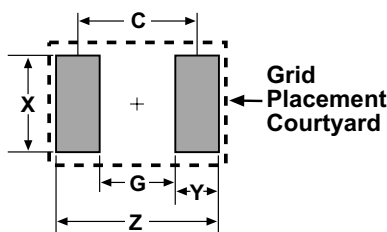


Figure 5

Table 6 - Land Pattern Dimensions for Reflow Solder

KEMET/EIA Size Code	Pad Dimensions				
	Z	G	X	Y (ref)	C (ref)
B/3528-21	5.00	1.10	2.50	1.95	3.05
D/7343-31, V/7343-20, X/7343-43	8.90	3.80	2.70	2.55	6.35

### 32. Soldering

The T520 KO-CAP family has been designed for reflow solder processes. They are not recommended for wave solder. Solder-coated terminations have excellent wetting characteristics for

high integrity solder fillets. Preheating of these components is recommended to avoid extreme thermal stress. The maximum recommended preheat rate is 2°C per second.

Hand-soldering should be avoided. If necessary, it should be performed with care due to the difficulty in process control. Care should be taken to avoid contact of the soldering iron to the molded case. The iron should be used to heat the solder pad, applying solder between the pad and the termination, until reflow occurs. The iron should be removed. "Wiping" the edges of a chip and heating the top surface is not recommended.

During typical reflow operations a slight darkening of the gold-colored epoxy may be observed. This slight darkening is normal and is not harmful to the product. Marking permanency is not affected by this change.

### 33. Washing

Standard washing techniques and solvents are compatible with all KEMET surface mount tantalum capacitors. Solvents such as Freon TMC and TMS, Trichlorethane, methylene chloride, prelete, and isopropyl alcohol are not harmful to these components. Please note that we are not endorsing the use of banned or restricted solvents. We are simply stating that they would not be harmful to the components.

If ultrasonic agitation is utilized in the cleaning process, care should be taken to minimize energy levels and exposure times to avoid damage to the terminations.

KEMET tantalum chips are also compatible with newer aqueous and semi-aqueous processes.

### 34. Encapsulations

Under normal circumstances, potting or encapsulation of KEMET tantalum chips is not required.

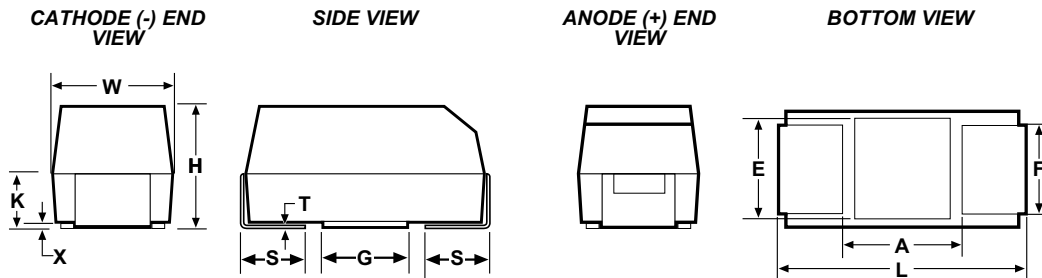
### 35. Storage Environment

Tantalum chip capacitors should be stored in normal working environments. While the chips themselves are quite robust in other environments, solderability will be degraded by exposure to high temperatures, high humidity, corrosive atmospheres, and long term storage. In addition, packaging materials will be degraded by high temperature - reels may soften or warp, and tape peel force may increase. KEMET recommends that maximum storage temperature not exceed 40 degrees C, and the maximum storage humidity not exceed 60% relative humidity. In addition, temperature fluctuations should be minimized to avoid condensation on the parts, and atmospheres should be free of chlorine and sulfur bearing compounds. For optimized solderability, chip stock should be used promptly, preferably within 1.5 years of receipt.

## FEATURES

- Polymer Cathode Technology
- Low ESR
- High Frequency Cap Retention
- No-Ignition Failure Mode
- Use Up to 80% of Rated Voltage (20% Derating)
- Capacitance 15 to 1000 $\mu$ F ( $\pm$ 20%)
- Voltage 2V to 25V
- EIA Standard Case Sizes
- 100% Surge Current Tested

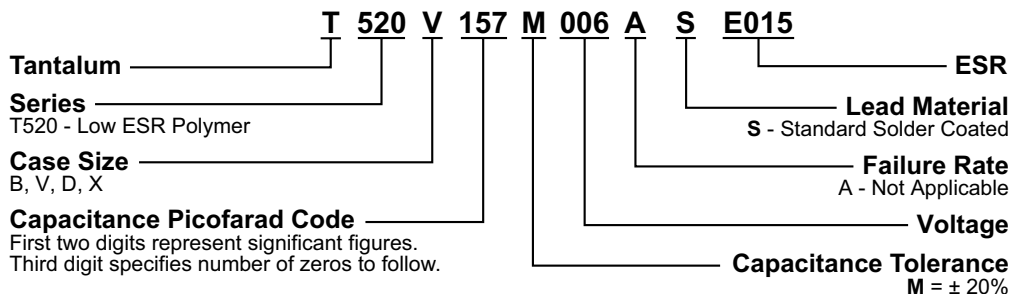
## OUTLINE DRAWING



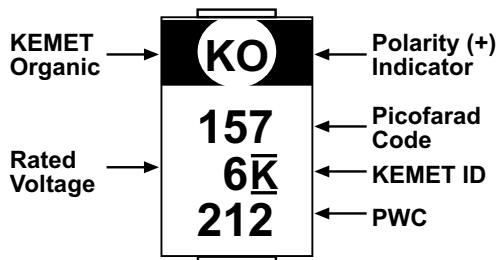
## DIMENSIONS - MILLIMETERS

Case Size		L	W	H	K $\pm$ 0.20	F $\pm$ 0.1	S $\pm$ 0.3	X(Ref)	T(Ref)	A(Min)	G(ref)	E(ref)
KEMET	EIA											
T	3528-12	3.5 $\pm$ 0.2	2.8 $\pm$ 0.2	1.2 max	0.3	2.2	0.8	0.05	0.13	1.1	1.8	2.2
B	3528-21	3.5 $\pm$ 0.2	2.8 $\pm$ 0.2	1.9 $\pm$ 0.2	0.9	2.2	0.8	0.10 $\pm$ 0.10	0.13	1.1	1.8	2.2
V	7343-20	7.3 $\pm$ 0.3	4.3 $\pm$ 0.3	1.9 max	0.9	2.4	1.3	0.05	0.13	3.8	3.5	3.5
D	7343-31	7.3 $\pm$ 0.3	4.3 $\pm$ 0.3	2.8 $\pm$ 0.3	1.5	2.4	1.3	0.10 $\pm$ 0.10	0.13	3.8	3.5	3.5
Y	7343-40	7.3 $\pm$ 0.3	4.3 $\pm$ 0.3	4.0 max	1.9	2.4	1.3	0.10 $\pm$ 0.10	0.13	3.8	3.5	3.5
X	7343-43	7.3 $\pm$ 0.3	4.3 $\pm$ 0.3	4.0 $\pm$ 0.3	2.3	2.4	1.3	0.10 $\pm$ 0.10	0.13	3.8	3.5	3.5

## T520 ORDERING INFORMATION

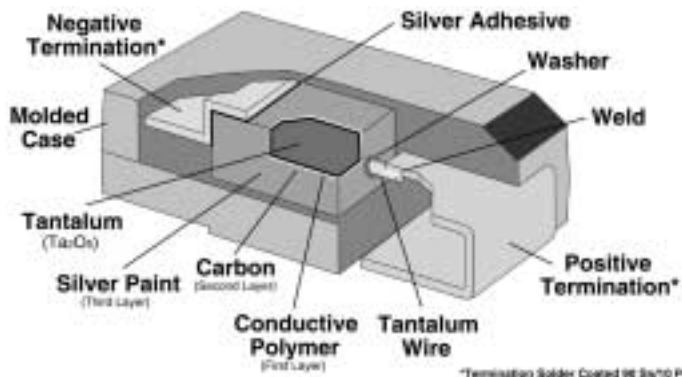


## COMPONENT MARKING



212 = 12th week of 2002

## T520 SERIES CONSTRUCTION



Polymer Tantalum Surface Mount

### T520 RATINGS & PART NUMBER REFERENCE

Capacitance $\mu$ F	Case Size	KEMET Part Number	DC Leakage $\mu$ A @ 25°C Max	DF% @ 25°C 120 Hz Max	ESR mW @ 25°C 100 kHz Max	Ripple Current mA rms @ 25°C, 100 kHz Max		
						25°C	85°C	105°C
<b>2 Volt Rating @ +85°C (1.6 Volt Rating at 105°C)</b>								
470.0	V	T520V477M002ASE040	94	10	40	1.8	1.6	0.7
<b>2.5 Volt Rating @ 85°C (2.0 Volt Rating at 105°C)</b>								
100.0	B	T520B107M2R5ASE040	25	8	40	1.5	1.3	0.6
100.0	B	T520B107M2R5ASE070	25	8	70	1.1	1.0	0.4
220.0	V	T520V227M2R5ASE015	55	10	15	2.9	2.6	1.2
220.0	V	T520V227M2R5ASE025	55	10	25	2.2	2.0	0.9
220.0	V	T520V227M2R5ASE045	55	10	45	1.7	1.5	0.7
330.0	V	T520V337M2R5ASE009	99	10	9	3.7	3.4	1.5
330.0	V	T520V337M2R5ASE015	83	10	15	2.9	2.6	1.2
330.0	V	T520V337M2R5ASE025	83	10	25	2.2	2.0	0.9
470.0	V	T520V477M2R5ASE012	118	10	12	3.2	2.9	1.3
470.0	V	T520V477M2R5ASE015	118	10	15	2.9	2.6	1.2
680.0	D	T520D687M2R5ASE015	170	10	15	3.2	2.8	1.3
680.0	D	T520D687M2R5ASE040	170	10	40	1.9	1.7	0.8
680.0	Y	T520Y687M2R5ATE025	170	10	25	2.5	2.3	1.0
1000.0	Y	T520Y108M2R5ATE025	250	10	25	2.5	2.3	1.0
<b>3 Volt Rating at 85°C (2.4 Volt Rating at 105°C)</b>								
100.0	B	T520B107M003ASE040	30	8	40	1.5	1.3	0.6
100.0	B	T520B107M003ASE070	30	8	70	1.1	1.0	0.4
150.0	B	T520B157M003ASE040	45	8	40	1.5	1.3	0.6
150.0	B	T520B157M003ASE070	45	8	70	1.1	1.0	0.4
330.0	V	T520V337M003ASE012	99	10	12	3.2	2.9	1.3
330.0	V	T520V337M003ASE015	99	10	15	2.9	2.6	1.2
330.0	V	T520V337M003ASE025	99	10	25	2.2	2.0	0.9
680.0	D	T520D687M003ASE015	204	10	15	3.2	2.8	1.3
680.0	D	T520D687M003ASE040	204	10	40	1.9	1.7	0.8
1000.0	X	T520X108M003ASE015	300	10	15	3.3	3.0	1.3
1000.0	X	T520X108M003ASE030	300	10	30	2.3	2.1	0.9
<b>4 Volt Rating @ +85°C (3.3 Volt Rating at +105°C)</b>								
15.0	T	T520T156M004ASE100	6	8	100	0.8	0.7	0.3
68.0	B	T520B686M004ASE040	27	8	40	1.5	1.3	0.6
68.0	B	T520B686M004ASE070	27	8	70	1.1	1.0	0.4
100.0	B	T520B107M004ASE040	40	8	40	1.5	1.3	0.6
100.0	B	T520B107M004ASE070	40	8	70	1.1	1.0	0.4
150.0	B	T520B157M004ASE040	60	8	40	1.5	1.3	0.6
150.0	B	T520B157M004ASE070	60	8	70	1.1	1.0	0.4
150.0	V	T520V157M004ASE015	60	10	15	2.9	2.6	1.2
150.0	V	T520V157M004ASE025	60	10	25	2.2	2.0	0.9
220.0	V	T520V227M004ASE015	88	10	15	2.9	2.6	1.2
220.0	V	T520V227M004ASE025	88	10	25	2.2	2.0	0.9
220.0	V	T520V227M004ASE045	88	10	45	1.7	1.5	0.7
220.0	D	T520D227M004ASE065	88	10	65	1.5	1.4	0.6
330.0	V	T520V337M004ASE025	132	10	25	2.2	2.0	0.9
330.0	V	T520V337M004ASE040	132	10	40	1.8	1.6	0.7
330.0	D	T520D337M004ASE015	132	10	15	3.2	2.8	1.3
330.0	D	T520D337M004ASE040	132	10	40	1.9	1.7	0.8
330.0	D	T520D337M004ASE045	132	10	45	1.8	1.6	0.7
470.0	D	T520D477M004ASE012	188	10	12	3.5	3.2	1.4
470.0	D	T520D477M004ASE015	188	10	15	3.2	2.8	1.3
470.0	D	T520D477M004ASE018	188	10	18	2.9	2.6	1.2
470.0	D	T520D477M004ASE025	188	10	25	2.4	2.2	1.0
470.0	D	T520D477M004ASE040	188	10	40	1.9	1.7	0.8
680.0	Y	T520Y687M004ATE025	272	10	25	2.5	2.3	1.0
680.0	X	T520X687M004ASE015	272	10	15	3.3	3.0	1.3
680.0	X	T520X687M004ASE035	272	10	35	2.2	2.0	0.9
<b>6/6.3 Volt Rating @ +85°C (5 Volt Rating at +105°C)</b>								
15.0	T	T520T156M006ASE100	9.5	8	100	0.8	0.7	0.3
33.0	B	T520B336M006ASE040	21	8	40	1.5	1.3	0.6
33.0	B	T520B336M006ASE070	21	8	70	1.1	1.0	0.4
33.0	T	T520T336M006ATE070	21	8	70	1	0.9	0.4
47.0	B	T520B476M006ASE040	30	8	40	1.5	1.3	0.6
47.0	B	T520B476M006ASE070	30	8	70	1.1	1.0	0.4
68.0	B	T520B686M006ASE040	43	8	40	1.5	1.3	0.6
68.0	B	T520B686M006ASE070	43	8	70	1.1	1.0	0.4
100.0	B	T520B107M006ASE040	63	8	40	1.5	1.3	0.6
100.0	B	T520B107M006ASE070	63	8	70	1.1	1.0	0.4
150.0	V	T520V157M006ASE015	95	10	15	2.9	2.6	1.2
150.0	V	T520V157M006ASE025	95	10	25	2.2	2.0	0.9
150.0	V	T520V157M006ASE040	95	10	40	1.8	1.6	0.7
150.0	V	T520V157M006ASE045	95	10	45	1.7	1.5	0.7
150.0	D	T520D157M006ASE015	95	10	15	3.2	2.8	1.3
150.0	D	T520D157M006ASE025	95	10	25	2.4	2.2	1.0
150.0	D	T520D157M006ASE055	95	10	55	1.7	1.5	0.7
220.0	V	T520V227M006ASE015	139	10	15	2.9	2.6	1.2
220.0	V	T520V227M006ASE025	139	10	25	2.2	2.0	0.9
220.0	V	T520V227M006ASE040	139	10	40	1.8	1.6	0.7
220.0	D	T520D227M006ASE015	139	10	15	3.2	2.8	1.3
220.0	D	T520D227M006ASE040	139	10	40	1.9	1.7	0.8
220.0	D	T520D227M006ASE050	139	10	50	1.7	1.6	0.7
330.0	V	T520V337M006ASE025	208	10	25	2.2	2.0	0.9
330.0	V	T520V337M006ASE040	208	10	40	1.8	1.6	0.7
330.0	D	T520D337M006ASE015	208	10	15	3.2	2.8	1.3
330.0	D	T520D337M006ASE025	208	10	25	2.4	2.2	1.0
330.0	D	T520D337M006ASE040	208	10	40	1.9	1.7	0.8
330.0	D	T520D337M006ASE045	208	10	45	1.8	1.6	0.7
330.0	D	T520Y337M006ATE025	208	10	25	2.5	2.3	1.0
470.0	Y	T520Y477M006ATE025	296	10	25	2.5	2.3	1.0
470.0	X	T520X477M006ASE018	296	10	18	3.0	2.7	1.2
470.0	X	T520X477M006ASE035	296	10	35	2.2	2.0	0.9
470.0	X	T520X477M006ASE040	296	10	40	2.0	1.8	0.8



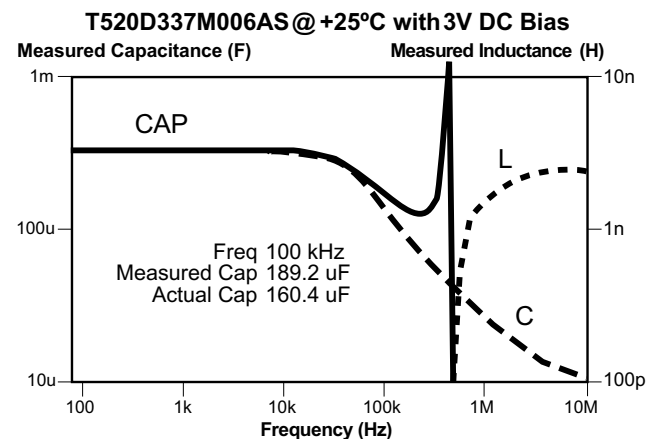
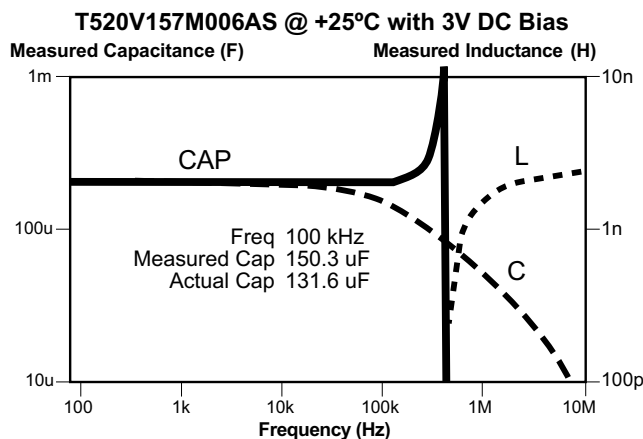
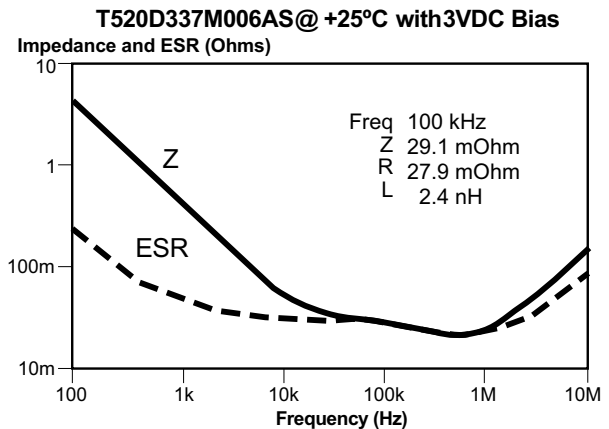
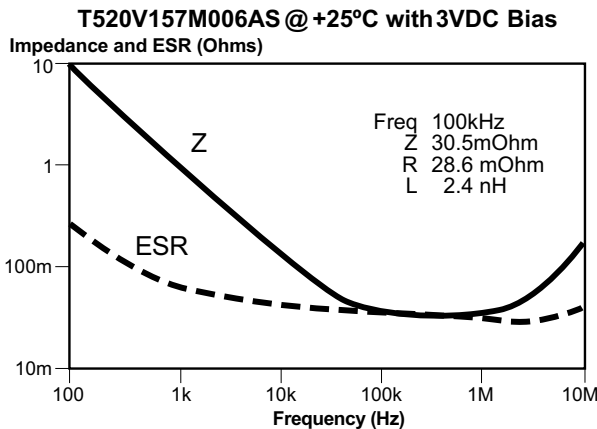
## T520 RATINGS & PART NUMBER REFERENCE

Capacitance $\mu\text{F}$	Case Size	KEMET Part Number	DC Leakage $\mu\text{A}$ @ 25°C Max	DF% @ 25°C 120 Hz Max	ESR mW @ 25°C 100 kHz Max	Ripple Current A rms @ 25°C, 100 kHz Max		
<b>8 Volt Rating @ +85°C (6.4 Volt Rating at +105°C)</b>								
33.0	B	T520B336M008ASE040	26	8	40	1.5	1.3	0.6
33.0	B	T520B336M008ASE070	27	8	70	1.1	1.0	0.4
150.0	D	T520D157M008ASE025	120	10	25	2.4	2.2	1.0
150.0	D	T520D157M008ASE040	120	10	40	1.9	1.7	0.8
150.0	D	T520D157M008ASE055	120	10	55	1.7	1.5	0.7
<b>10 Volt Rating @ +85°C (8 Volt Rating at +105°C)</b>								
33.0	B	T520B336M010ASE040	33	8	40	1.5	1.3	0.6
33.0	B	T520B336M010ASE070	33	8	70	1.1	1.0	0.4
68.0	V	T520V686M010ASE045	68	10	45	1.7	1.5	0.7
68.0	V	T520V686M010ASE060	68	10	60	1.4	1.3	0.6
100.0	V	T520V107M010ASE018	100	10	18	2.6	2.4	1.1
100.0	V	T520V107M010ASE025	100	10	25	2.2	2.0	0.9
100.0	V	T520V107M010ASE045	100	10	45	1.7	1.5	0.7
100.0	V	T520V107M010ASE050	100	10	50	1.6	1.4	0.6
100.0	D	T520D107M010ASE018	100	10	18	3.2	2.8	1.3
100.0	D	T520D107M010ASE055	100	10	55	1.7	1.5	0.7
100.0	D	T520D107M010ASE080	100	10	80	1.4	1.2	0.5
150.0	D	T520D157M010ASE025	150	10	25	2.4	2.2	1.0
150.0	D	T520D157M010ASE040	150	10	40	1.9	1.7	0.8
150.0	D	T520D157M010ASE055	150	10	55	1.7	1.5	0.7
220.0	D	T520D227M010ASE018	220	10	18	2.9	2.6	1.2
220.0	D	T520D227M010ASE025	220	10	25	2.4	2.2	1.0
220.0	D	T520D227M010ASE040	220	10	40	1.9	1.7	0.8
330.0	X	T520X337M010ASE025	330	10	25	2.6	2.3	1.0
330.0	X	T520X337M010ASE040	330	10	40	2.0	1.8	0.8
<b>16 Volt Rating @ +85°C (12.8 Volt Rating at +105°C)</b>								
33.0	V	T520V336M016ASE060	53	10	60	1.4	1.3	0.6
47.0	V	T520V476M016ASE070	76	10	70	1.3	1.2	0.5
47.0	D	T520D476M016ASE070	75	10	70	1.5	1.3	0.6
<b>25 Volt Rating @ +85°C (20 Volt Rating at +105°C)</b>								
15.0	D	T520D156M025ASE080	38	10	80	1.4	1.2	0.5

Newest values indicated in RED

Polymer Tantalum Surface Mount

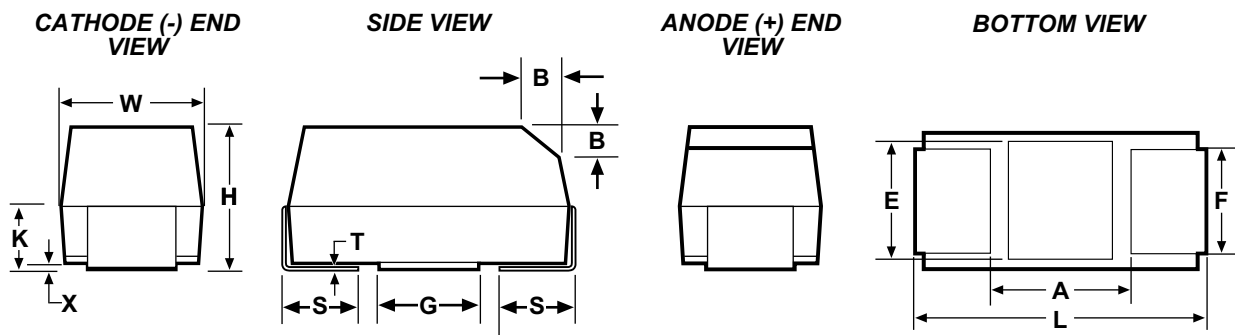
## TYPICAL FREQUENCY RESPONSE CURVES



### FEATURES

- Highest CV in Standard EIA Size
- Extremely Low ESR
- 125°C Max, Temperature Capability
- Polymer Cathode Technology
- High Frequency Capacitance Retention
- Non-Ignition Failure Mode
- Capacitance: 330 to 1500  $\mu$ F
- Voltage: 3V to 10V
- Molded Case (pick-and-place precision)
- 100% Accelerated Steady State Aging
- 100% Surge Current Testing
- Utilizes Multiple Tantalum Anode Technology
- Volumetric Efficiency
- Use Up to 80% of Rated Voltage (20% Derating)
- Self-Healing Mechanism
- True SMT Capability

### OUTLINE DRAWINGS



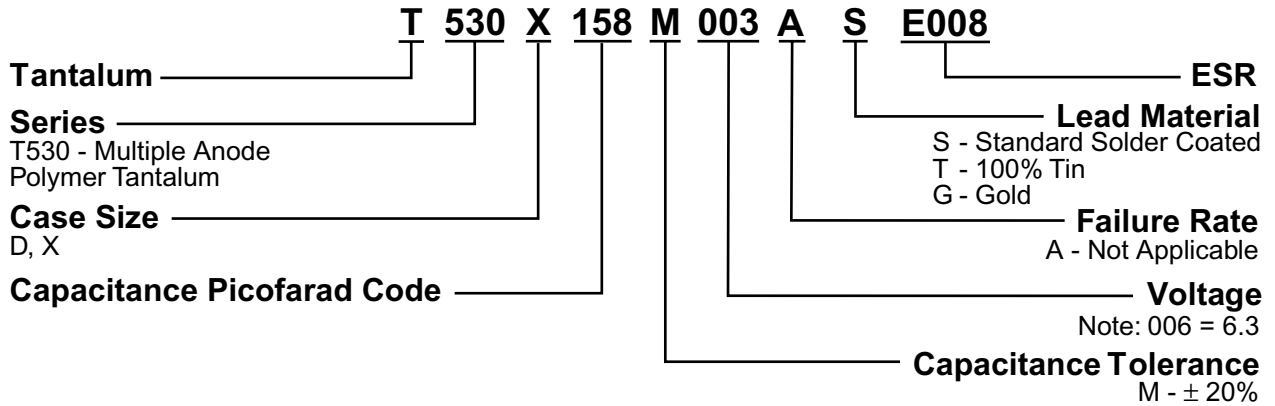
### DIMENSIONS - MILLIMETERS (INCHES)

CASE SIZE		L	W	H	K $\pm 0.20$ $\pm (.008)$	F $\pm 0.1$ $\pm (.004)$	S $\pm 0.3$ $\pm (.012)$	B $\pm 0.15$ $(Ref) \pm (.006)$	X (Ref)	T (Ref)	A (Min)	G (Ref)	E (Ref)
KEMET	EIA/IECQ												
D	7343-31	7.3 $\pm 0.3$ (.287 $\pm .012$ )	4.3 $\pm 0.3$ (.169 $\pm .012$ )	2.8 $\pm 0.3$ (.11 $\pm .012$ )	1.5 (.059)	2.4 (.094)	1.3 (.051)	0.5 (.020)	0.10 $\pm 0.10$ (.004 $\pm .004$ )	0.13 (.005)	3.8 (.150)	3.5 (.138)	3.5 (.138)
X	7343-43	7.3 $\pm 0.3$ (.287 $\pm .012$ )	4.3 $\pm 0.3$ (.169 $\pm .012$ )	4.0 $\pm 0.3$ (.157 $\pm .012$ )	2.3 (.091)	2.4 (.094)	1.3 (.051)	0.5 (.020)	0.10 $\pm 0.10$ (.004 $\pm .004$ )	0.13 (.005)	3.8 (.150)	3.5 (.138)	3.5 (.138)

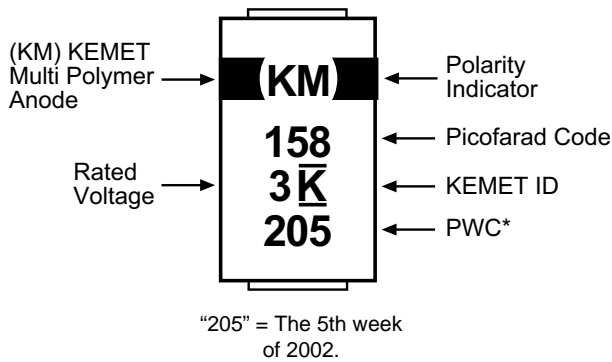
### T530 RATINGS & PART NUMBER REFERENCE

Capacitance $\mu$ F	Case Size	KEMET Part Number	DCL $V_R$	DF % 120Hz	ESR mW @100 kHz 25°C Max	Ripple Current (Arms) @ 100 kHz			
						25°C	85°C	105°C	125°C
<b>2.5 Volt Rating at 85°C (2 Volt Rating at 105°C)</b>									
470.0	D/7343-31	T530D477M2R5ASE010	117 $\mu$ A	10.0	10	5.0	4.5	4.5	2.0
560.0	D/7343-31	T530D567M2R5ASE005	140 $\mu$ A	8.0	5	7.1	6.4	6.4	2.9
680.0	D/7343-31	T530D687M2R5ASE010	170 $\mu$ A	8.0	10	5.0	4.5	4.5	2.0
<b>3 Volt Rating at 85°C (2.4 Volt Rating at 105°C)</b>									
680.0	D/7343-31	T530D687M003ASE010	204 $\mu$ A	8.0	10	5.0	4.5	4.5	2.0
1000.0	X/7343-43	T530X108M003ASE010	300 $\mu$ A	8.0	10	5.2	4.7	4.7	2.1
1500.0	X/7343-43	T530X158M003ASE008	450 $\mu$ A	8.0	8	5.8	5.2	5.2	2.3
<b>4 Volt Rating at 85°C (3.3 Volt Rating at 105°C)</b>									
470.0	D/7343-31	T530D477M004ASE010	188 $\mu$ A	8.0	10	5.0	4.5	4.5	2.0
680.0	X/7343-43	T530X687M004ASE010	272 $\mu$ A	8.0	10	5.2	4.7	4.7	2.1
<b>6 Volt Rating at 85°C (5 Volt Rating at 105°C)</b>									
330.0	D/7343-31	T530D337M006ASE010	208 $\mu$ A	8.0	10	5.0	4.5	4.5	2.0
470.0	X/7343-43	T530X477M006ASE010	296 $\mu$ A	8.0	10	5.2	4.7	4.7	2.1
<b>10 Volt Rating at 85°C (8 Volt Rating at 105°C)</b>									
220.0	D/7343/31	T530D227M010ASE010	220 $\mu$ A	8.0	10	5.0	4.5	4.5	2.0
330.0	X/7343-43	T530X337M010ASE010	330 $\mu$ A	8.0	10	5.2	4.7	4.7	2.1

## T530 ORDERING INFORMATION



## COMPONENT MARKING

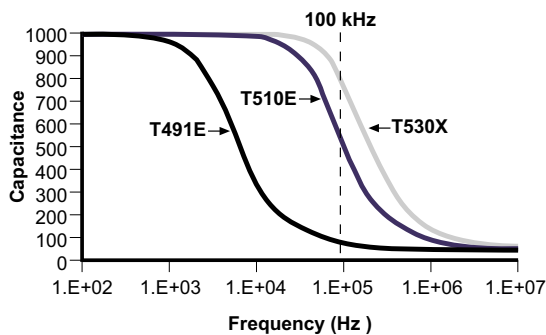


## T530 Series Construction

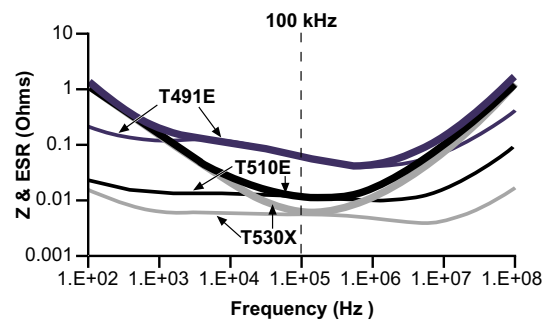


Polymer Tantalum Surface Mount

## T530X/T510E/T491E 1,000µF Capacitance vs. Frequency



## T530X/T510E/T491E 1,000µF Impedance & ESR vs. Frequency



## INTRODUCTION

Ceramic chips consist of formulated ceramic dielectric materials which have been fabricated into thin layers, interspersed with metal electrodes alternately exposed on opposite edges of the laminated structure. The entire structure is then fired at high temperature to produce a monolithic block which provides high capacitance values in a small physical volume. After firing, conductive terminations are applied to opposite ends of the chip to make contact with the exposed electrodes. Standard end terminations use a nickel barrier layer and a tin overplate to provide excellent solderability for the customer.

KEMET multilayer ceramic chip capacitors are produced in plants designed specifically for chip capacitor manufacture. The process features a high degree of mechanization as well as precise controls over raw materials and process conditions. Manufacturing is supplemented by extensive Technology, Engineering and Quality Assurance programs.

KEMET ceramic chip capacitors are offered in the five most popular temperature characteristics. These are designated by the Electronics Industries Association (EIA) as the ultra-stable C0G (also known as NP0, military version BP), the stable X7R (military BX or BR), the stable X5R, and the general purpose Z5U and Y5V. A wide range of sizes are available. KEMET multilayer ceramic chip capacitors are available in KEMET's tape and reel packaging, compatible with automatic placement equipment. Bulk cassette packaging is also available (0805,0603 and 0402 only) for those pick and place machines requiring its use.

## ELECTRICAL CHARACTERISTICS

### 1. Working Voltage:

Refers to the maximum continuous DC working voltage permissible across the entire operating temperature range. The reliability of multilayer ceramic capacitors is not extremely sensitive to voltage, and brief applications of voltage above rated will not result in immediate failure. However, reliability will be degraded by sustained exposure to voltages above rated.

### 2. Temperature Characteristics:

Within the EIA classifications, various temperature characteristics are identified by a three-symbol code; for example: C0G, X7R, X5R, Z5U and Y5V.

For Class I temperature compensating dielectrics (includes C0G), the first symbol designates the significant figures of the temperature coefficient in PPM per degree Celsius, the second designates the multiplier to be applied, and the third designates the tolerance in PPM per degrees Celsius. EIA temperature characteristic codes for Class I dielectrics are shown in Table 1.

**Table 1 – EIA Temperature Characteristic Codes for Class I Dielectrics**

Significant Figure of Temperature Coefficient		Multiplier Applied to Temperature Coefficient		Tolerance of Temperature Coefficient	
PPM per Degree C	Letter Symbol	Multiplier	Number Symbol	PPM per Degree C	Letter Symbol
0.0	C	-1	0	± 30	G
0.3	B	-10	1	± 60	H
0.9	A	-100	2	± 120	J
1.0	M	-1000	3	± 250	K
1.5	P	-10000	4	± 500	L

KEMET supplies the C0G characteristic.

For Class II and III dielectrics (including X7R, X5R, Z5U & Y5V), the first symbol indicates the lower limit of the operating temperature range, the second indicates the upper limit of the operating temperature range, and the third indicates the maximum capacitance change allowed over the operating temperature range. EIA type designation codes for Class II and III dielectrics are shown in Table 2.

**Table 2 – EIA Temperature Characteristic Codes for Class II & III Dielectrics**

Low Temperature Rating		High Temperature Rating		Maximum Capacitance Shift		
Degree Celsius	Letter Symbol	Degree Celsius	Number Symbol	Percent	Letter Symbol	EIA Class
+10C	Z	+45C	2	± 1.0%	A	II
-30C	Y	+65C	4	± 1.5%	B	II
-55C	X	+85C	5	± 2.2%	C	II
		+105C	6	± 3.3%	D	II
		+125C	7	± 4.7%	E	II
		+150C	8	± 7.5%	F	II
		+200C	9	± 10.0%	P	II
				± 15.0%	R	II
				± 22.0%	S	III
				+ 22/-33%	T	III
				+22/-56%	U	III
				+22/-82%	V	III

KEMET supplies the X7R, X5R, Z5U and Y5V characteristics.

### 3. Capacitance Tolerance:

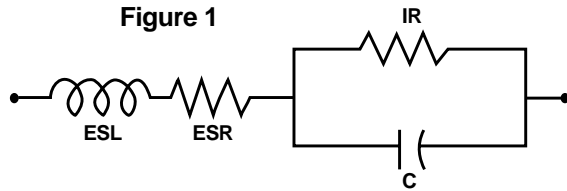
See tables on pages 50-53.

### 4. Capacitance:

**Within specified tolerance when measured per Table 3.**

The standard unit of capacitance is the farad. For practical capacitors, capacitance is usually expressed in microfarads ( $10^{-6}$  farad), nanofarads ( $10^{-9}$  farad), or picofarads ( $10^{-12}$  farad). Standard measurement conditions are listed in Table 3 - Specified Electrical Limits.

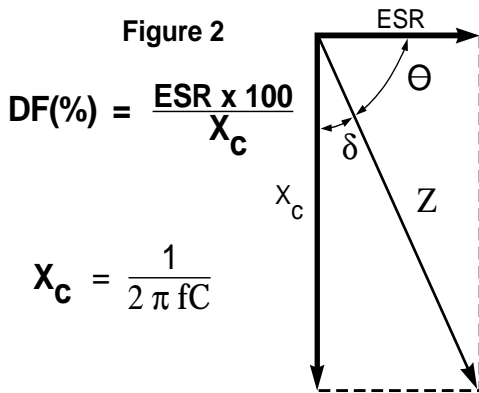
Like all other practical capacitors, multilayer ceramic capacitors also have resistance and inductance. A simplified schematic for the single frequency equivalent circuit is shown in Figure 1. At high frequency more complex models apply - see KEMET SPICE models at [www.kemet.com](http://www.kemet.com) for details.



C = Capacitance  
 ESL = Equivalent Series Inductance  
 ESR = Equivalent Series Resistance  
 IR = Insulation Resistance

### 5. Dissipation Factor: Measured under same conditions as capacitance. (See Table 3)

Dissipation factor (DF) is a measure of the losses in a capacitor under AC application. It is the ratio of the equivalent series resistance to the capacitive reactance, and is usually expressed in percent. It is normally measured simultaneously with capacitance, and under the same conditions. The vector diagram below illustrates the relationship between DF, ESR and impedance. The reciprocal of the dissipation factor is called the "Q" or quality factor. For convenience, the "Q" factor is often used for very low values of dissipation factor especially when measured at high frequencies. DF is sometimes called the "loss tangent" or "tangent δ", as shown in Figure 2.



### 6. Impedance:

Since the parallel resistance (IR) is normally very high, the total impedance of the capacitor can be approximated by:

Figure 3

$$Z = \sqrt{ESR^2 + (X_L - X_C)^2}$$

Where: Z = Total Impedance

ESR = Equivalent Series Resistance

$X_C$  = Capacitive Reactance =  $1/(2 \pi f C)$

$X_L$  = Inductive Reactance =  $(2 \pi f) (ESL)$

The variation of a capacitor's impedance with frequency determines its effectiveness in many applications. At high frequency more detailed models apply - see KEMET SPICE models for such instances.

### 7. Insulation Resistance: Measured after 2 minutes electrification at 25°C and rated voltage: Limits per Table 3.

Insulation Resistance is the measure of a capacitor to resist the flow of DC leakage current. It is sometimes referred to as "leakage resistance". Insulation resistance (IR) is the DC resistance measured across the terminals of a capacitor, represented by the parallel resistance (IR) shown in Figure 1. For a given dielectric type, electrode area increases with capacitance, resulting in a decrease in the insulation resistance. Consequently, insulation resistance limits are usually specified as the "RC" (IR x C) product, in terms of ohm-farads or megohm-micro-farads. The insulation resistance for a specific capacitance value is determined by dividing this product by the capacitance. However, as the nominal capacitance values become small, the insulation resistance calculated from the RC product

Table 3 – Specified Electrical Limits

Parameter	Temperature Characteristics				
	C0G	X7R/X5R	Z5U	Y5V	
Capacitance & Dissipation Factor: Measured at following conditions: C0G – 1kHz and 1 vrms if capacitance >1000 pF 1MHz and 1 vrms if capacitance ≤1000 pF X7R/X5R/Y5V – 1kHz and 1 vrms* if capacitance ≤ 10 μF X7R/X5R/Y5V – 120Hz and 0.5 vrms if capacitance > 10 μF Z5U – 1kHz and 0.5 vrms Y5V – 1kHz and 1 vrms DF Limits:	50 - 200 volts – 25 volts – 16 volts – 6.3/10 volts –	0.10% 0.10% ----- -----	2.5% 3.5% 3.5% 5.0%	4.0% 4.0% ----- -----	5.0% 7.0% 7.0% 10.0%
Dielectric Strength: At 2.5 times rated DC voltage	Pass Subsequent IR Test				
Insulation Resistance (IR): At rated DC voltage, whichever of the two is smaller. To get IR limit, divide MΩ-μF value by the capacitance and compare to GΩ limit. Select the lower of the two limits.	1,000 MΩ – μF or 100 GΩ (100,000 MΩ)	1,000 MΩ – μF or 100 GΩ (100,000 MΩ)	100 MΩ – μF or 10 GΩ (10,000 MΩ)	100 MΩ – μF or 10 G (≥16 volt) 50 MΩ – μF or 10G (≤10v) (10,000 MΩ)	
Temperature: Range, °C Capacitance Change (without DC voltage)	-55 to +125 0 ± 30 ppm/°C	X7R: -55 to +125 ±15% X5R: -55 to +85 ±15%	+10 to +85 +22% -56%	-30 to +85 +22% -82%	

\*Note: Some values measured at ½ volt, see X7R Table for specific details on pages 49 and 50.

reaches values which are impractical. Consequently, IR specifications usually include both a minimum RC product and a maximum limit based on the IR calculated from that value. For example, a typical IR specification might read "1,000 megohm-microfarads or 100 gigohms, whichever is less". The DC leakage current may be calculated by dividing the applied voltage by the insulation resistance (Ohm's Law).

**8. Dielectric Withstanding Voltage: 250% of rated voltage for 5 seconds with current limited to 50mA at 25°C. Limits per Table 3.**

Dielectric withstanding voltage (DWV) is the peak DC voltage which a capacitor is designed to withstand without damage for short periods of time. All KEMET multilayer ceramic surface mount capacitors will withstand a DC test voltage of 2.5 x the rated voltage for 60 seconds.

KEMET specification limits for all electrical characteristics at standard measurement conditions are shown in Table 3. Variations in these properties caused by changing conditions (temperature, voltage, frequency, and time) are covered in the following sections.

**9. Aging Rate: Maximum % Capacitance Loss/Decade Hour**  
**C0G - 0%**  
**X7R - 2.0%**  
**X5R - 2.5%**  
**Z5U - 7.0%**  
**Y5V - 7.0%**  
**Actual rates may be lower. Consult factory for details.**

The capacitance of Class II and III dielectric changes with time as well as with temperature, voltage and frequency. The change with time as known as "aging". It is caused by gradual realignment of the crystalline structure of the ceramic dielectric material as it is cooled below its Curie temperature, which produces a loss of capacitance with time. The aging process is predictable and follows a logarithmic decay.

The aging process is reversible. If the capacitor is heated to a temperature above its Curie point for some period of time, de-aging will occur and the capacitor will regain the capacitance lost during the aging process. The amount of de-aging depends on both the elevated temperature and the length of time at that temperature. Exposure to 150°C for one-half hour is sufficient to return the capacitor to its initial value.

Because the capacitance changes rapidly immediately after de-aging, capacitance measurements are usually delayed for at least 10 - 24 hours after the de-aging process, which is often referred to as the "last heat". In addition, manufacturers utilize the aging rates to set factory test

limits which will bring the capacitance within the specified tolerance at some future time, to allow for customer receipt and use.

**10. Effect of Temperature:**

Both capacitance and dissipation factor are affected by variations in temperature. The maximum capacitance change with temperature is defined by the temperature characteristic.

However, this only defines an "envelope" bounded by the upper and lower operating temperatures and the minimum and maximum capacitance values. Within this "envelope", the variation with temperature depends upon the specific dielectric formulation.

Insulation resistance decreases with temperature. Typically, the insulation resistance limit at maximum rated temperature is 10% of the 25°C value.

**11. Effect of Voltage:**

C0G ceramic capacitors are not affected by variations in applied AC or DC voltages. For Class II and III ceramic capacitors (including X7R, X5R, Z5U and Y5V), variations in voltage affect the capacitance and dissipation factor. The application of DC voltages higher than 5 vdc reduces both the capacitance and dissipation factor. The application of AC voltages up to 10-20 vac tends to increase both capacitance and dissipation factor. At higher AC voltages, both capacitance and dissipation factor begin to decrease.

**12. Effect of Frequency:**

Frequency affects both capacitance and dissipation factor. Typical curves for KEMET multilayer ceramic capacitors are shown in Figures 4, 5 and 6.

The variation of impedance with frequency is an important consideration in the application of multilayer ceramic capacitors. Total impedance of the capacitor is the vector summation of the capacitive reactance, the inductive reactance, and the ESR, as illustrated in Figure 2. As frequency increases, the capacitive reactance decreases. However, the series inductance (L) shown in Figure 1 produces some inductive reactance, which increases with frequency. At some frequency, the impedance ceases to be capacitive and becomes inductive. This point, at the bottom of the V-shaped impedance versus frequency curves, is the self-resonant frequency. At the self-resonant frequency, the reactance is zero, and the impedance consists of the ESR only. At high frequency more detailed models apply - See KEMET SPICE models for such instances.

Typical impedance versus frequency curves for KEMET multilayer ceramic capacitors are shown in Figures 4, 5 and 6.

## ENVIRONMENTAL AND PHYSICAL

- 13. **Thermal Shock:**  
EIA-198, Method 202, Condition B (5 cycles -55° to + 125°C).
- 14. **Life Test:**  
EIA-198, Method 201, 1000 hours at 200% of rated voltage at 125°C. (Except 85°C for Z5U and Y5V).  
See Table 4 on page 48 for limits.
- 15. **Humidity Test:**  
EIA-198, Method 206, ( Except 1000 hours,85°C, 85% RH, Rated Voltage).  
See Table 4 on page 48 for limits.
- 16. **Moisture Resistance:**  
EIA-198, Method 204, Condition B (20 cycles with 50 volts applied).  
See Table 4 on page 48 for limits.
- 17. **Solderability:**  
EIA-198, Method 301 (245°, 5 secs, Sn62 solder) 95% smooth solder on terminations.
- 18. **Resistance to Soldering Heat:**  
EIA-198, Method 302, Condition B (260°C, 10 seconds) no leaching of nickel barrier.
- 19. **Terminal Strength:**  
EIA-198, Method 303, Condition D .

## RELIABILITY

- 20. A well constructed multilayer ceramic capacitor chip is extremely reliable and, for all practical purposes, has no wearout mechanism when used within the maximum voltage and temperature ratings. Most failures occur as a result of mechanical or thermal damage during mounting on the board, or during subsequent testing. Capacitor failure may also be induced by sustained operation at voltages that exceed the rated DC voltage, voltage spikes or transients that exceed the dielectric's voltage capability, sustained operation at temperatures above the maximum rated temperature, internal defects, or excessive temperature rise due to power dissipation. As with any practical device, multilayer ceramic capacitors also possess an inherent, although low, failure rate when operated within rated conditions. The primary failure mode is by short-circuit or low insulation resistance, resulting from cracks or from dielectric breakdown at a defect site. KEMET monitors reliability with a periodic sampling program for selected values. Results are available in our FIT (Failure in Time) report for commercial chips.
- 21. **Storage and Handling:**  
Ceramic chip capacitors should be stored in normal working environments. While the chips themselves are quite robust in other environ-

ments, solderability will be degraded by exposure to high temperatures, high humidity, corrosive atmospheres, and long term storage. In addition, packaging materials will be degraded by high temperature – reels may soften or warp, and tape peel force may increase. KEMET recommends that maximum storage temperature not exceed 40 degrees C, and maximum storage humidity not exceed 70% relative humidity. In addition, temperature fluctuations should be minimized to avoid condensation on the parts, and atmospheres should be free of chlorine and sulfur bearing compounds. For optimized solderability, chip stock should be used promptly, preferably within 1.5 years of receipt.

## MISAPPLICATION

- 22. Ceramic capacitors, like any other capacitors, may fail if they are misapplied. Some misapplications include mechanical damage, such as impact or excessive flexing of the circuit board. Others include severe mounting or rework cycles that may also introduce thermal shock. Still others include exposure to excessive voltage, current or temperature. If the dielectric layer of the capacitor is damaged by misapplication, the circuit may fail. The electrical energy of the circuit can be released as heat, which may damage the circuit board and other components as well.

## ADDITIONAL INFORMATION

- 23. Detailed application information can be found in KEMET Engineering Bulletins.
  - F-2100 Surface Mount-Mounting Pad Dimensions and Considerations
  - F-2102 Reflow Soldering Process
  - F-2105 Wave Solder Process
  - F-2103 Surface Mount Repair
  - F-2110 Capacitance Monitoring while Flex Testing

For analysis of high frequency applications, KEMET has SPICE models of most chip capacitors. Models may be downloaded from KEMET's website [www.kemet.com](http://www.kemet.com).

Additional information is also available - See your KEMET representative for details or post your questions to KEMET's homepage on the web <http://www.kemet.com>.

## TABLE 4 – ENVIRONMENTAL LIMITS

Body	Rated DC Voltage	Initial DF (%)	IR (GΩ or ΩF) whichever is less	DF (%) Post Life/ Hum/Moisture Resistance	Cap Shift (% or pf, whichever is greater) Post Life/ Hum/Moisture Resistance	IR (GΩ or ΩF) whichever is less Post Life/ Hum/Moisture Resistance
C0G	200*	0.1	100/1000	0.5	0.3% or ± 0.25 pf	10/100
	100	0.1	100/1000	0.5	0.3% or ± 0.25 pf	10/100
	50	0.1	100/1000	0.5	0.3% or ± 0.25 pf	10/100
	25	0.1	100/1000	0.5	0.3% or ± 0.25 pf	10/100
	16	0.1	100/1000	0.5	0.3% or ± 0.25 pf	10/100
X7R/X5R	200*	2.5	100/1000	3.0	± 20%	10/100
	100	2.5	100/1000	3.0	± 20%	10/100
	50	2.5	100/1000	3.0	± 20%	10/100
	25	3.5	100/1000	5.0	± 20%	10/100
	16	3.5	100/1000	5.0	± 20%	10/100
	6.3/10	5.0	100/1000	7.5	± 20%	10/100
Z5U	100	4.0	10/100	5.0	± 30%	1/10
	50	4.0	10/100	5.0	± 30%	1/10
	25	4.0	10/100	7.5	± 30%	1/10
Y5V	100	5.0	10/100	7.5	± 30%	1/10
	50	5.0	10/100	7.5	± 30%	1/10
	25	7.0	10/100	10.0	± 30%	1/10
	16	7.0	10/100	10.0	± 30%	1/10
	6.3/10	10.0	10/50	15.0	± 30%	1/5

\*200 Volt limits not currently included in EIA-198.

### TYPICAL PERFORMANCE CURVES EFFECT OF FREQUENCY (See SPICE models for specific ratings.)

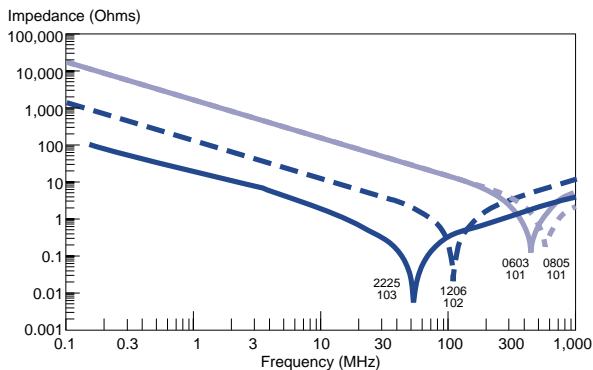


FIGURE 4. Impedance versus Frequency C0G Dielectric

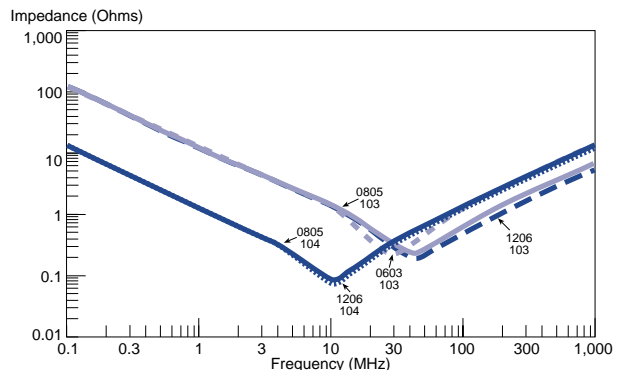


FIGURE 5. Impedance versus Frequency X7R Dielectric

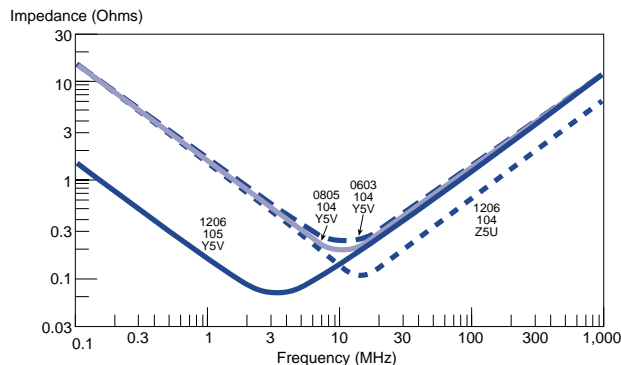


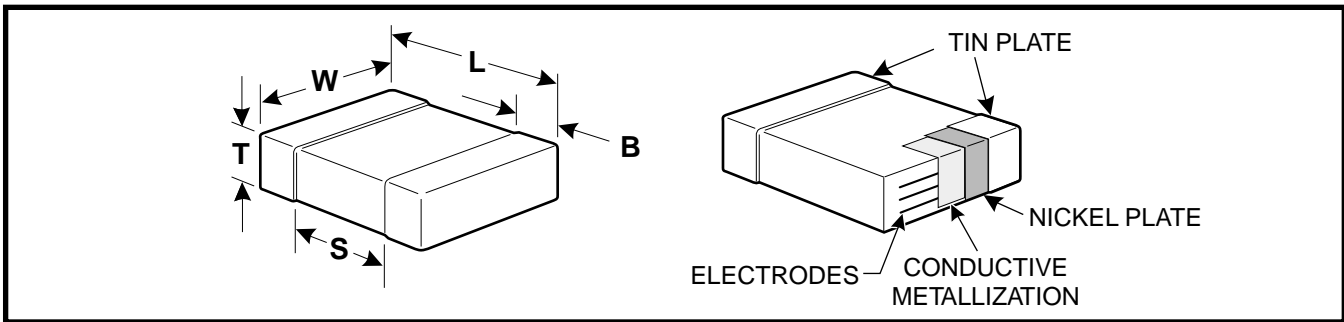
FIGURE 6. Impedance versus Frequency Z5U/Y5V Dielectric



## FEATURES

- COG (NP0), X7R, X5R, Z5U and Y5V Dielectrics
- 10, 16, 25, 50, 100 and 200 Volts
- Standard End Metallization: Tin-plate over nickel barrier
- Available Capacitance Tolerances:  $\pm 0.10$  pF;  $\pm 0.25$  pF;  $\pm 0.5$  pF;  $\pm 1\%$ ;  $\pm 2\%$ ;  $\pm 5\%$ ;  $\pm 10\%$ ;  $\pm 20\%$ ; and  $+80\%$ - $20\%$
- Tape and reel packaging per EIA481-1. (See page 61 for specific tape and reel information.) Bulk Cassette packaging (0402, 0603, 0805 only) per IEC60286-6 and EIAJ 7201.

## CAPACITOR OUTLINE DRAWINGS



## DIMENSIONS—MILLIMETERS AND (INCHES)

EIA SIZE CODE	METRIC SIZE CODE (Ref only)	L # LENGTH	W # WIDTH	B BANDWIDTH	S MIN. SEPARATION	MOUNTING TECHNIQUE
0402*	1005	1.0 (.04) $\pm$ .05 (.002)	0.5 (.02) $\pm$ .05 (.002)	0.20 (0.008)-0.40 (0.016)	0.3 (.012)	Solder Reflow
0603*	1608	1.6 (.063) $\pm$ 0.15 (.006)	0.8 (.032) $\pm$ 0.15 (.006)	0.35 (.014) $\pm$ 0.15 (.006)	0.7 (.028)	Solder Wave † or Solder Reflow
0805*	2012	2.0 (.079) $\pm$ 0.2 (.008)	1.25 (.049) $\pm$ 0.2 (.008)	0.5 (.02) $\pm$ .25 (.010)	0.75 (.030)	
1206*	3216	3.2 (.126) $\pm$ 0.2 (.008)	1.6 (.063) $\pm$ 0.2 (.008)	0.5 (.02) $\pm$ .25 (.010)	N/A	
1210*	3225	3.2 (.126) $\pm$ 0.2 (.008)	2.5 (.098) $\pm$ 0.2 (.008)	0.5 (.02) $\pm$ .25 (.010)	N/A	Solder Reflow
1812	4532	4.5 (.177) $\pm$ 0.3 (.012)	3.2 (.126) $\pm$ 0.3 (.012)	0.6 (.024) $\pm$ .35 (.014)	N/A	
1825*	4564	4.5 (.177) $\pm$ 0.3 (.012)	6.4 (.252) $\pm$ 0.4 (.016)	0.6 (.024) $\pm$ .35 (.014)	N/A	
2220	5650	5.6 (.220) $\pm$ 0.4 (.016)	5.0 (.197) $\pm$ 0.4 (.016)	0.6 (.024) $\pm$ .35 (.014)	N/A	
2225	5664	5.6 (.220) $\pm$ 0.4 (.016)	6.3 (.248) $\pm$ 0.4 (.016)	0.6 (.024) $\pm$ .35 (.014)	N/A	

See pages 48-52 for thickness dimensions.

\* Note: Indicates EIA Preferred Case Sizes (Tightened tolerances apply for 0402, 0603, and 0805 packaged in bulk cassette, see page 65.)

#Note: These thicknesses are EIA maximums. Most chips are considerably thinner. Consult factory for details. Also, some extended values may be slightly thicker than EIA maximums.

† For extended value 1210 case size - solder reflow only.

## CAPACITOR ORDERING INFORMATION (Standard Chips - For Military see page 55)

**CERAMIC SIZE CODE SPECIFICATION** C - Standard

**CAPACITANCE CODE** Expressed in Picofarads (pF)  
First two digits represent significant figures.  
Third digit specifies number of zeros. (Use 9 for 1.0 through 9.9pF. Use 8 for 0.5 through 0.99pF)  
(Example: 2.2pF = 229 or 0.50 pF = 508)

**CAPACITANCE TOLERANCE**

B - $\pm 0.10$ pF	J - $\pm 5\%$
C - $\pm 0.25$ pF	K - $\pm 10\%$
D - $\pm 0.5$ pF	M - $\pm 20\%$
F - $\pm 1\%$	P - (GMV) - special order only
G - $\pm 2\%$	Z - $+80\%$ , $-20\%$

**END METALLIZATION**  
C-Standard (Tin-plated nickel barrier)

**FAILURE RATE LEVEL**  
A- Not Applicable

**TEMPERATURE CHARACTERISTIC**  
Designated by Capacitance Change Over Temperature Range

G - COG (NP0) ( $\pm 30$ PPM/ $^{\circ}$ C)
R - X7R ( $\pm 15\%$ ) ( $-55^{\circ}$ C + $125^{\circ}$ C)
P - X5R ( $\pm 15\%$ ) ( $-55^{\circ}$ C + $85^{\circ}$ C)
U - Z5U ( $+22\%$ , $-56\%$ ) ( $+10^{\circ}$ C + $85^{\circ}$ C)
V - Y5V ( $+22\%$ , $-82\%$ ) ( $-30^{\circ}$ C + $85^{\circ}$ C)

**VOLTAGE**

1 - 100V	3 - 25V
2 - 200V	4 - 16V
5 - 50V	8 - 10V
	9 - 6.3V

**\* Part Number Example: C0805C103K5RAC\* (14 digits - no spaces)**







## Z5U CAPACITANCE RANGE (KEMET's Z5U also meets Y5V Characteristics)

CAP. PF	CAP CODE	CAP TOL	C0805*		C1206*		C1210*		C1812*		C1825*		C2225	
			50V	100V	50V	100V	50V	100V	50V	100V	50V	100V	50V	100V
6800	682	M,Z	DC	DC										
8200	822	M,Z	DC	DC										
10,000	103	M,Z	DC	DC	EB	EB								
12,000	123	M,Z	DC	DC	EB	EB								
15,000	153	M,Z	DC		EB	EB								
18,000	183	M,Z	DC		EB	EB								
22,000	223	M,Z	DC		EB	EB								
27,000	273	M,Z	DC		EB	EB								
33,000	333	M,Z	DC		EB	EB								
39,000	393	M,Z	DD		EB	EC								
47,000	473	M,Z	DD		EB	EC	FB	FB						
56,000	563	M,Z	DD		EB	EB	FB	FB						
68,000	683	M,Z	DD		EB	EB	FB	FB						
82,000	823	M,Z	DD		EB	EB	FB	FC	GB	GB				
100,000	104	M,Z	DD		EB	EB	FB	FD	GB	GB				
120,000	124	M,Z			EC		FB	FD	GB	GB				
150,000	154	M,Z			EC		FC	FD	GB	GB				
180,000	184	M,Z			EC		FC		GB		HB	HB		
220,000	224	M,Z			EC		FC		GB		HB	HB		
270,000	274	M,Z					FC		GB		HB	HB		
330,000	334	M,Z					FD		GB		HB	HB	KB	KB
390,000	394	M,Z					FD		GB		HB	HD	KB	KB
470,000	474	M,Z					FD		GB		HB		KB	KB
560,000	564	M,Z					FD		GC		HB		KB	KB
680,000	684	M,Z					FD		GC		HB		KB	KB
820,000	824	M,Z					FF		GE		HB		KB	KB
1,000,000	105	M,Z					FH		GE		HB		KB	KB
1,200,000	125	M,Z									HB		KB	KB
1,500,000	155	M,Z									HB		KB	KB
1,800,000	185	M,Z									HB		KD	KD
2,200,000	225	M,Z									HB		KD	KD

NOTE: For non-standard capacitance values or voltages, contact your local KEMET sales representative.  
50 Volt Ceramic Chips can be used for 63 volt applications.  
\* EIA preferred chip sizes

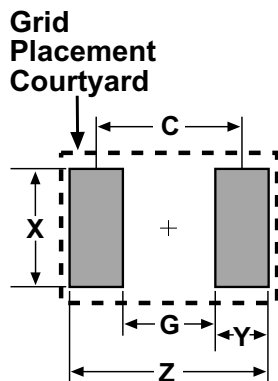
## Y5V CAPACITANCE RANGE

Cap. pF	CAP CODE	Cap. Tol.	C0402			C0603			C0805					C1206					C1210								
			6.3V	10V	16V	6.3V	10V	16V	25V	6.3V	10V	16V	25V	50V	6.3V	10V	16V	25V	50V	6.3V	10V	16V	25V	50V			
22,000	223	Z											DC						EB								
33,000	333	Z											DC						EB								
47,000	473	Z	BB	BB	BB								DD						EB								
68,000	683	Z	BB	BB	BB								DD						EB								
100,000	104	Z	BB	BB	BB	CB	CB	CB	CB				DD						EB								
150,000	154	Z				CB	CB	CB	CB				DC						EC								
220,000	224	Z				CB	CB	CB	CB	DC	DC	DC	DC						EC								
330,000	334	Z				CB	CB	CB	CB	DC	DC	DC	DC						EB						FD+	FD+	FD+
470,000	474	Z				CB	CB			DE	DE	DE	DE						EC						FD+	FD+	FD+
680,000	684	Z				CB	CB			DE	DE	DE	DE						EB						FD+	FD+	FD+
1,000,000	105	Z				CB	CB			DG	DG	DG	DG						EB						FH+	FH+	FH+
1,500,000	155	Z								DG	DG	DG	DG														
2,200,000	225	Z								DG	DG	DG	DG														
3,300,000	335	Z								DE	DE	DE	DE														
4,700,000	475	Z								DG	DG	DG	DG														
6,800,000	685	Z								DH																	
10,000,000	106	Z								DH																	
15,000,000	156	Z																									
22,000,000	226	Z																									

NOTE: For non-standard capacitance values or voltages, contact your local KEMET sales representative.  
50 Volt Ceramic Chips can be used for 63 volt applications.  
\* EIA preferred chip sizes  
+ Relflow only

See page 54 for Thickness Code Reference Chart.

## SURFACE MOUNT LAND DIMENSIONS - CERAMIC CHIP CAPACITORS - MM



Dimension	Reflow Solder					Wave Solder				
	Z	G	X	Y(ref)	C(ref)	Z	G	X	Y(ref)	Smin
0402	2.14	0.28	0.74	0.93	1.21	Not Recommended				
0603	2.78	0.68	1.08	1.05	1.73	3.18	0.68	0.80	1.25	1.93
0805	3.30	0.70	1.60	1.30	2.00	3.70	0.70	1.10	1.50	2.20
1206	4.50	1.50	2.00	1.50	3.00	4.90	1.50	1.40	1.70	3.20
1210	4.50	1.50	2.90	1.50	3.00	4.90	1.50	2.00	1.70	3.20
1812	5.90	2.30	3.70	1.80	4.10	6.30	2.30	2.60	2.00	4.30
1825	5.90	2.30	6.90	1.80	4.10	Not Recommended				
2220	7.00	3.30	5.50	1.85	5.15	Not Recommended				
2225	7.00	3.30	6.80	1.85	5.15	Not Recommended				

Calculation Formula  
 $Z = L_{min} + 2J_t + T_t$   
 $G = S_{max} - 2J_h - T_h$   
 $X = W_{min} + 2J_s + T_s$   
 $T_t, T_h, T_s = \text{Combined tolerances}$

## THICKNESS CODE REFERENCE CHART PACKAGING QTY BASED ON FINISHED CHIP THICKNESS SPECIFICATIONS

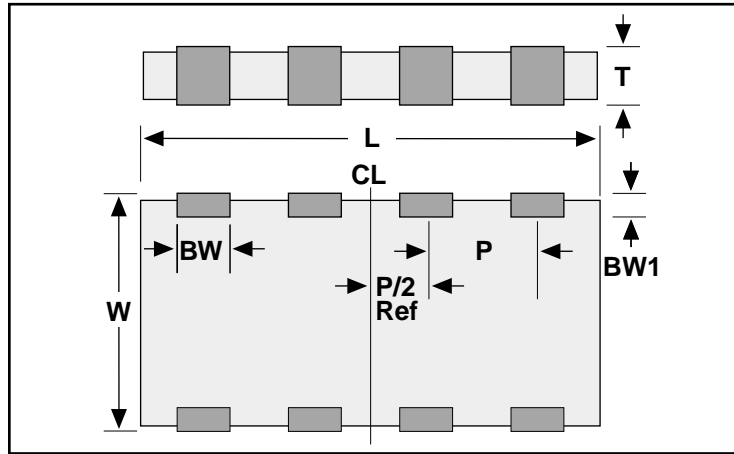
Thickness Code	Chip Size	Chip Thickness Range (mm)	Qty per Reel 7" Plastic	Qty per Reel 13" Plastic	Qty per Reel 7" Paper	Qty per Reel 13" Paper	Qty per Bulk Cassette
AA	0201	.30 ± .03	N/A	N/A	15,000	N/A	N/A
BB	0402	.50 ± .05	N/A	N/A	10,000	50,000	50,000
CB	0603	.80 ± .07	N/A	N/A	4,000	10,000	15,000
CC	0603	.80 ± .10	N/A	N/A	4,000	10,000	N/A
DB	0805	.60 ± .10	N/A	N/A	N/A	N/A	10,000
DC	0805	.78 ± .10	4,000	10,000	4,000	10,000	N/A
DD	0805	.90 ± .10	4,000	10,000	N/A	N/A	N/A
DE	0805	1.00 ± .10	2,500	10,000	N/A	N/A	N/A
DF	0805	1.10 ± .10	2,500	10,000	N/A	N/A	N/A
DG	0805	1.25 ± .15	2,500	10,000	N/A	N/A	N/A
DH	0805	1.25 ± .20	2,500	10,000	N/A	N/A	N/A
EB	1206	.78 ± .10	4,000	10,000	4,000	10,000	N/A
EC	1206	.90 ± .10	4,000	10,000	N/A	N/A	N/A
ED	1206	1.00 ± .10	2,500	10,000	N/A	N/A	N/A
EE	1206	1.10 ± .10	2,500	10,000	N/A	N/A	N/A
EF	1206	1.20 ± .15	2,500	10,000	N/A	N/A	N/A
EG	1206	1.60 ± .15	2,000	8,000	N/A	N/A	N/A
EH	1206	1.60 ± .20	2,000	8,000	N/A	N/A	N/A
EJ	1206	1.70 ± .20	2,000	8,000	N/A	N/A	N/A
FB	1210	.78 ± .10	4,000	10,000	N/A	N/A	N/A
FC	1210	.90 ± .10	4,000	10,000	N/A	N/A	N/A
FD	1210	.95 ± .10	4,000	10,000	N/A	N/A	N/A
FE	1210	1.00 ± .10	2,500	10,000	N/A	N/A	N/A
FF	1210	1.10 ± .10	2,500	10,000	N/A	N/A	N/A
FG	1210	1.25 ± .15	2,500	10,000	N/A	N/A	N/A
FH	1210	1.55 ± .15	2,000	8,000	N/A	N/A	N/A
FJ	1210	1.85 ± .15	2,000	8,000	N/A	N/A	N/A
FK	1210	2.10 ± .20	2,000	8,000	N/A	N/A	N/A
GB	1812	1.00 ± .10	1,000	4,000	N/A	N/A	N/A
GC	1812	1.10 ± .10	1,000	4,000	N/A	N/A	N/A
GD	1812	1.25 ± .15	1,000	4,000	N/A	N/A	N/A
GE	1812	1.30 ± .10	1,000	4,000	N/A	N/A	N/A
GF	1812	1.50 ± .10	1,000	4,000	N/A	N/A	N/A
GG	1812	1.55 ± .10	1,000	4,000	N/A	N/A	N/A
GH	1812	1.40 ± .15	1,000	4,000	N/A	N/A	N/A
GJ	1812	1.70 ± .15	1,000	4,000	N/A	N/A	N/A
HB	1825	1.10 ± .15	1,000	4,000	N/A	N/A	N/A
HD	1825	1.30 ± .15	1,000	4,000	N/A	N/A	N/A
HE	1825	1.40 ± .15	1,000	4,000	N/A	N/A	N/A
HF	1825	1.50 ± .15	1,000	4,000	N/A	N/A	N/A
JB	2220	1.00 ± .15	1,000	4,000	N/A	N/A	N/A
JC	2220	1.10 ± .15	1,000	4,000	N/A	N/A	N/A
JD	2220	1.30 ± .15	1,000	4,000	N/A	N/A	N/A
JE	2220	1.40 ± .15	1,000	4,000	N/A	N/A	N/A
JF	2220	1.50 ± .15	1,000	4,000	N/A	N/A	N/A
KB	2225	1.00 ± .15	1,000	4,000	N/A	N/A	N/A
KC	2225	1.10 ± .15	1,000	4,000	N/A	N/A	N/A
KD	2225	1.30 ± .15	1,000	4,000	N/A	N/A	N/A
KE	2225	1.40 ± .15	1,000	4,000	N/A	N/A	N/A

This chart refers to ceramic chip thickness codes on pages 50-53.

## FEATURES

- Four individual capacitors inside one 1206 monolithic structure
- Saves board and inventory space
- One placement instead of four - less costly
- Easier to handle and solder than 4 smaller chips
- Tape and reel per EIA 481-1

## CAPACITOR OUTLINE DRAWING



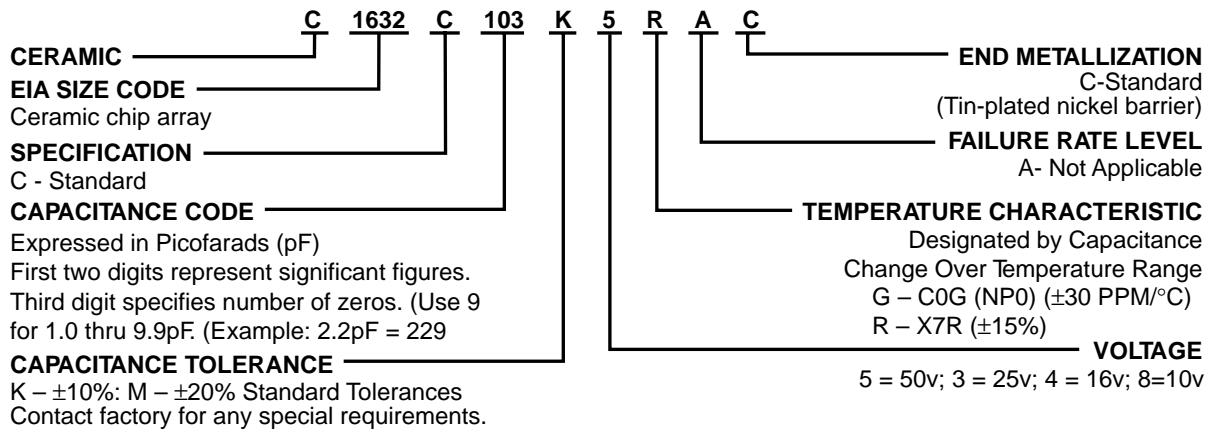
**TABLE 1**  
**EIA DIMENSIONS – MILLIMETERS (INCHES)**

Size Code	Length L	Width W	Thickness T (max.)	Bandwidth BW	Bandwidth BW1	Pitch P
1632	3.2 (0.126) ± 0.2 (0.008)	1.6 (.063) ± 0.2 (.008)	0.7 - 1.35 (0.027 - 0.053)	0.40 (0.016) ± 0.2 (0.008)	0.1 - 0.5 (0.004 - 0.020)	0.8 (0.031) ± 0.1 (0.004)

**Notes:**

1. Metric is controlling - English for reference only.
2. Pitch (P) tolerances are non-cumulative along the package.
3. Thickness (T) depends on capacitance.

## CERAMIC ARRAY ORDERING INFORMATION



Ceramic Surface Mount

**TABLE 2A**  
**COG DIELECTRIC – CAPACITANCE RANGE**

Capacitance Values (pF)	KEMET Part Number	Capacitance Tolerance	10V 16V	25V	50V	100V	200V
10	C1632C100(1)(2)GAC	K,M	100	100	100	100	100
12	C1632C120(1)(2)GAC	K,M	120	120	120	120	120
15	C1632C150(1)(2)GAC	K,M	150	150	150	150	150
18	C1632C180(1)(2)GAC	K,M	180	180	180	180	180
22	C1632C220(1)(2)GAC	K,M	220	220	220	220	220
27	C1632C270(1)(2)GAC	K,M	270	270	270	270	270
33	C1632C330(1)(2)GAC	K,M	330	330	330	330	330
39	C1632C390(1)(2)GAC	K,M	390	390	390	390	390
47	C1632C470(1)(2)GAC	K,M	470	470	470	470	470
56	C1632C560(1)(2)GAC	K,M	560	560	560	560	560
68	C1632C680(1)(2)GAC	K,M	680	680	680	680	680
82	C1632C820(1)(2)GAC	K,M	820	820	820	820	820
100	C1632C101(1)(2)GAC	K,M	101	101	101	101	
120	C1632C121(1)(2)GAC	K,M	121	121	121	121	
150	C1632C151(1)(2)GAC	K,M	151	151	151	151	
180	C1632C181(1)(2)GAC	K,M	181	181	181	181	
220	C1632C221(1)(2)GAC	K,M	221	221	221		
270	C1632C271(1)(2)GAC	K,M	271	271	271		
330	C1632C331(1)(2)GAC	K,M	331	331	331		
390	C1632C391(1)(2)GAC	K,M	391	391	391		
470	C1632C471(1)(2)GAC	K,M	471	471	471		

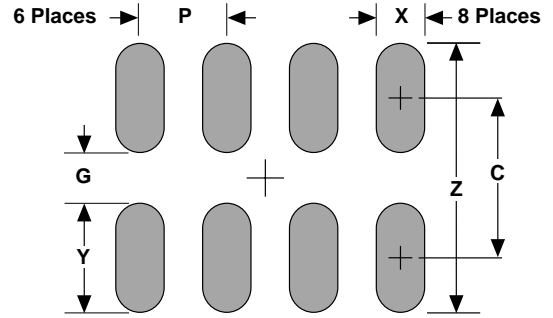
- (1) To complete the KEMET part number, insert the alpha code for the tolerance desired.  
K = ±10% and M = ±20% – standard tolerance. Contact factory for any special requirements.  
(2) To complete the KEMET part number, insert appropriate number for voltage desired:  
"5" = 50 volts, "3" = 25 volts, "4" = 16 volts, and "8" = 10 volts.

**TABLE 2B**  
**X7R DIELECTRIC – CAPACITANCE RANGE**

Capacitance Values (pF)	KEMET Part Number	Capacitance Tolerance	10V 16V	25V	50V	100V	200V
330	C1632C331(1)(2)RAC	K,M	331	331	331	331	331
390	C1632C391(1)(2)RAC	K,M	391	391	391	391	391
470	C1632C471(1)(2)RAC	K,M	471	471	471	471	471
560	C1632C561(1)(2)RAC	K,M	561	561	561	561	561
680	C1632C681(1)(2)RAC	K,M	681	681	681	681	
820	C1632C821(1)(2)RAC	K,M	821	821	821	821	
1000	C1632C102(1)(2)RAC	K,M	102	102	102	102	
1200	C1632C122(1)(2)RAC	K,M	122	122	122	122	
1500	C1632C152(1)(2)RAC	K,M	152	152	152	152	
1800	C1632C182(1)(2)RAC	K,M	182	182	182	182	
2200	C1632C222(1)(2)RAC	K,M	222	222	222	222	
2700	C1632C272(1)(2)RAC	K,M	272	272	272	272	
3300	C1632C332(1)(2)RAC	K,M	332	332	332	332	
3900	C1632C392(1)(2)RAC	K,M	392	392	392	392	
4700	C1632C472(1)(2)RAC	K,M	472	472	472	472	
5600	C1632C562(1)(2)RAC	K,M	562	562	562		
6800	C1632C682(1)(2)RAC	K,M	682	682	682		
8200	C1632C822(1)(2)RAC	K,M	822	822	822		
10,000	C1632C103(1)(2)RAC	K,M	103	103	103		
12,000	C1632C123(1)(2)RAC	K,M	123	123	123		
15,000	C1632C153(1)(2)RAC	K,M	153	153	153		
18,000	C1632C183(1)(2)RAC	K,M	183	183	183		
22,000	C1632C223(1)(2)RAC	K,M	223	223	223		
27,000	C1632C273(1)(2)RAC	K,M	273				
33,000	C1632C333(1)(2)RAC	K,M	333				
39,000	C1632C393(1)(2)RAC	K,M	393				
47,000	C1632C473(1)(2)RAC	K,M	473				
56,000	C1632C563(1)(2)RAC	K,M	563				
68,000	C1632C683(1)(2)RAC	K,M	683				
82,000	C1632C823(1)(2)RAC	K,M	823				
100,000	C1632C104(1)(2)RAC	K,M	104				

- (1) To complete the KEMET part number, insert the alpha code for the tolerance desired:  
K = ±10% and M = ±20% – standard tolerances. Contact factory for any special requirements.  
(2) To complete the KEMET part number, insert appropriate number for voltage desired:  
"5" = 50 volts, "3" = 25 volts, "4" = 16 volts, and "8" = 10 volts.

## 1632 CERAMIC ARRAY LAND PATTERN LAYOUT



Additional pad dimension information is available in KEMET Technical Bulletin F-2100.

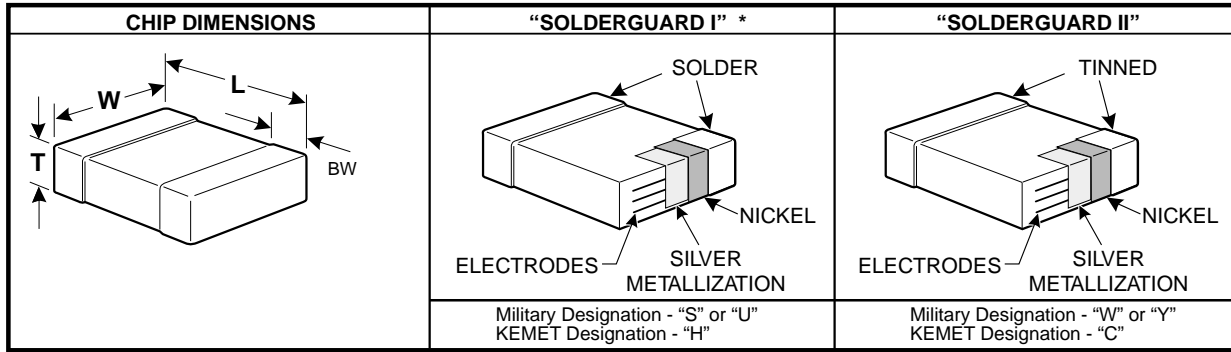
## LAND PATTERN DIMENSIONS - CERAMIC CHIP CAPACITOR ARRAYS - MM

Dimension	Reflow Solder					
	Z	G	X	Y(ref)	C(ref)	P(ref)
3216	2.80	0.40	0.52	1.20	1.60	0.80

**Calculation Formula**  
 $Z = L_{min} + 2J_t + T_t$   
 $G = S_{max} - 2J_h - T_h$   
 $X = W_{min} + 2J_s + T_s$   
 $T_t, T_h, T_s = \text{Combined tolerances}$



## CAPACITOR OUTLINE DRAWINGS



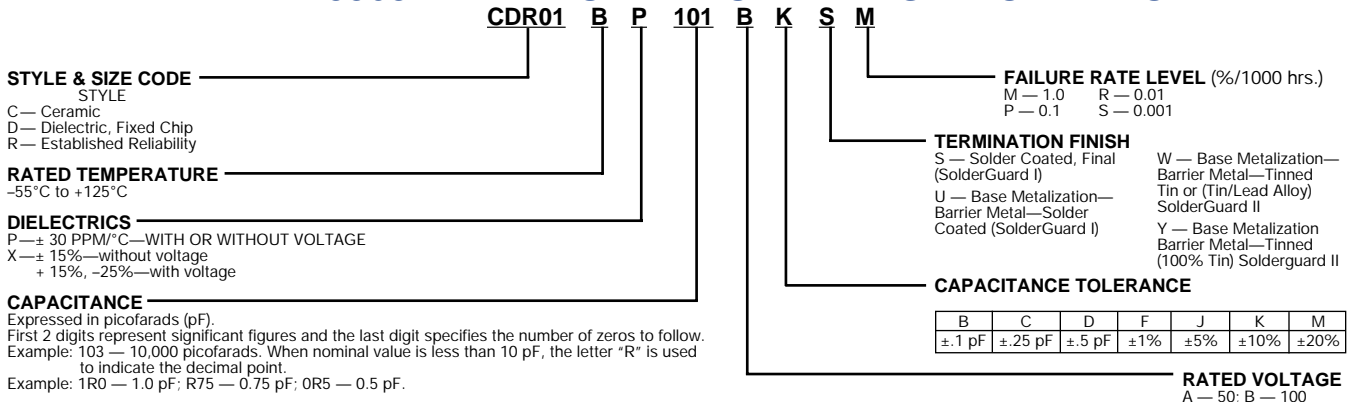
## DIMENSIONS—MILLIMETERS AND (INCHES)

STYLE	KEMET SIZE CODE	L	W	T		BW
				MIN.	MAX.	
CDR01	C0805	2.03 ± .38 (.080 ± .015)	1.27 ± .38 (.050 ± .015)	.56 (.022)	1.40 (.055)	.51 ± 0.25 (.020 ± .010)
CDR02	C1805	4.57 ± .38 (.180 ± .015)	1.27 ± .38 (.050 ± .015)	.56 (.022)	1.40 (.055)	.51 ± 0.25 (.020 ± .010)
CDR03	C1808	4.57 ± .38 (.180 ± .015)	2.03 ± .38 (.080 ± .015)	.56 (.022)	2.03 (.080)	.51 ± 0.25 (.020 ± .010)
CDR04	C1812	4.57 ± .38 (.180 ± .015)	3.18 ± .38 (.125 ± .015)	.56 (.022)	2.03 (.080)	.51 ± 0.25 (.020 ± .010)
CDR05	C1825	4.57 $\left( \begin{smallmatrix} +.51 & +.020 \\ .180 & \\ -.38 & -.015 \end{smallmatrix} \right)$	6.35 $\left( \begin{smallmatrix} +.51 & +.020 \\ .250 & \\ -.38 & -.015 \end{smallmatrix} \right)$	.51 (.020)	2.03 (.080)	.51 ± 0.25 (.020 ± .010)
CDR06	C2225	5.72 ± .51 (.225 ± .020)	6.35 ± .51 (.250 ± .020)	.51 (.020)	2.03 (.080)	.51 ± 0.25 (.020 ± .010)
CDR31	C0805	2.00 ± .20 (.078 ± .008)	1.25 ± .20 (.049 ± .008)		1.30 (.051)	.50 ± 0.20 (.020 ± .008)
CDR32	C1206	3.20 ± .20 (.125 ± .008)	1.60 ± .20 (.062 ± .008)		1.30 (.051)	.50 ± 0.20 (.020 ± .008)
CDR33	C1210	3.20 ± .25 (.125 ± .010)	2.50 ± .25 (.098 ± .010)		1.50 (.059)	.50 ± 0.25 (.020 ± .010)
CDR34	C1812	4.50 ± .25 (.176 ± .010)	3.20 ± .25 (.125 ± .010)		1.50 (.059)	.50 ± 0.25 (.020 ± .010)
CDR35	C1825	4.50 ± .30 (.176 ± .012)	6.40 ± .30 (.250 ± .012)		1.50 (.059)	.50 ± 0.30 (.020 ± .012)

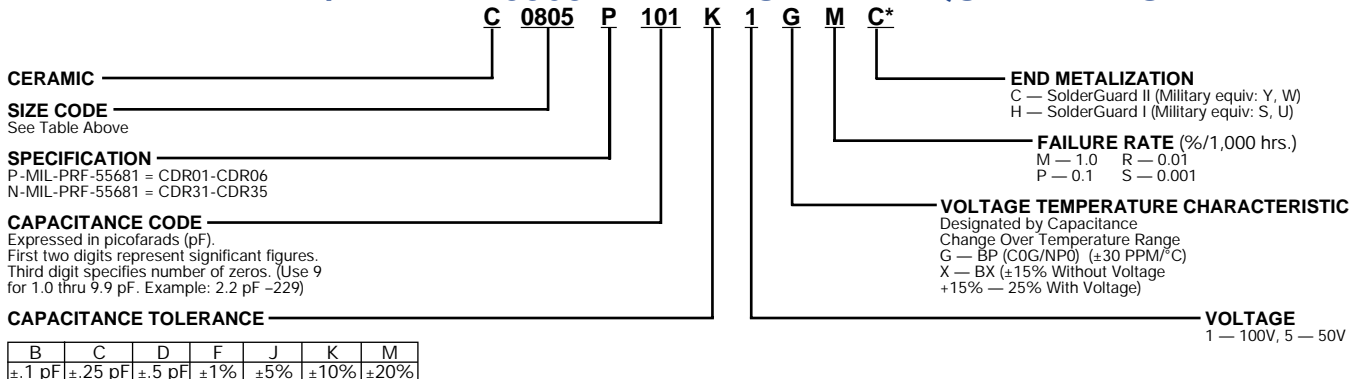
Note: For Solderguard I (MIL-C55681 "S" or "U" Endmets), the length, width and thickness positive tolerances (including bandwidth) cited above are allowed to increase by the following amounts:

	Length	Width/Thickness
CDR01	0.51MM (.020)	0.38MM (.015)
CDR02-06	0.64MM (.025)	0.38MM (.015)
CDR31-35	0.60MM (.023)	0.30MM (.012)

## MIL-PRF-55681 PART NUMBER ORDERING INFORMATION



## KEMET/MIL-PRF-55681 PART NUMBER EQUIVALENTS



\* Part Number Example: C0805P101K1GMC (14 digits - no spaces)

KEMET Electronics Corporation, P.O. Box 5928, Greenville, S.C. 29606, (864) 963-6300

Military Ceramic Surface Mount

## RATINGS & PART NUMBER REFERENCE

CHARACTERISTIC	CAP. pF	AVAIL. TOL.	KEMET CAPACITORS	MIL-PRF-55681 PART NUMBER
<b>100 Volt — C0805 SIZE (MILITARY CDR01)</b>				
BP	10	J,K	C0805P100(3)1G(4)C	CDR01BP100B(3)W(4)
	12	J	C0805P120J1G(4)C	CDR01BP120BJW(4)
	15	J,K	C0805P150(3)1G(4)C	CDR01BP150B(3)W(4)
	18	J	C0805P180J1G(4)C	CDR01BP180BJW(4)
	22	J,K	C0805P220(3)1G(4)C	CDR01BP220B(3)W(4)
	27	J	C0805P270J1G(4)C	CDR01BP270BJW(4)
	33	J,K	C0805P330(3)1G(4)C	CDR01BP330B(3)W(4)
	39	J	C0805P390J1G(4)C	CDR01BP390BJW(4)
	47	J,K	C0805P470(3)1G(4)C	CDR01BP470B(3)W(4)
	56	J	C0805P560J1G(4)C	CDR01BP560BJW(4)
	68	J,K	C0805P680(3)1G(4)C	CDR01BP680B(3)W(4)
	82	J	C0805P820J1G(4)C	CDR01BP820BJW(4)
	100	J,K	C0805P101(3)1G(4)C	CDR01BP101B(3)W(4)
	BP or BX	120	J,K	C0805P121(3)1(2)(4)C
150		J,K	C0805P151(3)1(2)(4)C	CDR01B(1)151B(3)W(4)
180		J,K	C0805P181(3)1(2)(4)C	CDR01B(1)181B(3)W(4)
BX	220	K,M	C0805P221(3)1X(4)C	CDR01BX221B(3)W(4)
	270	K	C0805P271K1X(4)C	CDR01BX271BKW(4)
	330	K,M	C0805P331(3)1X(4)C	CDR01BX331B(3)W(4)
	390	K	C0805P391K1X(4)C	CDR01BX391BKW(4)
	470	K,M	C0805P471(3)1X(4)C	CDR01BX471B(3)W(4)
	560	K	C0805P561K1X(4)C	CDR01BX561BKW(4)
	680	K,M	C0805P681(3)1X(4)C	CDR01BX681B(3)W(4)
	820	K	C0805P821K1X(4)C	CDR01BX821BKW(4)
	1,000	K,M	C0805P102(3)1X(4)C	CDR01BX102B(3)W(4)
	1,200	K	C0805P122K1X(4)C	CDR01BX122BKW(4)
	1,500	K,M	C0805P152(3)1X(4)C	CDR01BX152B(3)W(4)
	1,800	K	C0805P182K1X(4)C	CDR01BX182BKW(4)
	2,200	K,M	C0805P222(3)1X(4)C	CDR01BX222B(3)W(4)
	2,700	K	C0805P272K1X(4)C	CDR01BX272BKW(4)
3,300	K,M	C0805P332(3)1X(4)C	CDR01BX332B(3)W(4)	
<b>50 Volt — C0805 SIZE (MILITARY CDR01)</b>				
BX	3,900	K	C0805P392K5X(4)C	CDR01BX392AKW(4)
	4,700	K,M	C0805P472(3)5X(4)C	CDR01BX472A(3)W(4)
<b>100 Volt — C1805 SIZE (MILITARY CDR02)</b>				
BP	220	J,K	C1805P221(3)1G(4)C	CDR02BP221B(3)W(4)
	270	J	C1805P271J1G(4)C	CDR02BP271BJW(4)
BX	3,900	K	C1805P392K1X(4)C	CDR02BX392BKW(4)
	4,700	K,M	C1805P472(3)1X(4)C	CDR02BX472B(3)W(4)
	5,600	K	C1805P562K1X(4)C	CDR02BX562BKW(4)
	6,800	K,M	C1805P682(3)1X(4)C	CDR02BX682B(3)W(4)
	8,200	K	C1805P822K1X(4)C	CDR02BX822BKW(4)
	10,000	K,M	C1805P103(3)1X(4)C	CDR02BX103B(3)W(4)
<b>50 Volt — C1805 SIZE (MILITARY CDR02)</b>				
BX	12,000	K	C1805P123K5X(4)C	CDR02BX123AKW(4)
	15,000	K,M	C1805P153(3)5X(4)C	CDR02BX153A(3)W(4)
	18,000	K	C1805P183K5X(4)C	CDR02BX183AKW(4)
	22,000	K,M	C1805P223(3)5X(4)C	CDR02BX223A(3)W(4)
<b>100 Volt — C1808 SIZE (MILITARY CDR03)</b>				
BP	330	J,K	C1808P331(3)1G(4)C	CDR03BP331B(3)W(4)
	390	J	C1808P391J1G(4)C	CDR03BP391BJW(4)
	470	J,K	C1808P471(3)1G(4)C	CDR03BP471B(3)W(4)

CHARACTERISTIC	CAP. pF	AVAIL. TOL.	KEMET CAPACITORS	MIL-PRF-55681 PART NUMBER
<b>100 Volt — C1808 SIZE (MILITARY CDR03) (Cont'd)</b>				
BP	560	J	C1808P561J1G(4)C	CDR03BP561BJW(4)
	680	J,K	C1808P681(3)1G(4)C	CDR03BP681B(3)W(4)
	820	J	C1808P821J1G(4)C	CDR03BP821BJW(4)
	1,000	J,K	C1808P102(3)1G(4)C	CDR03BP102B(3)W(4)
BX	12,000	K	C1808P123K1X(4)C	CDR03BX123BKW(4)
	15,000	K,M	C1808P153(3)1X(4)C	CDR03BX153B(3)W(4)
	18,000	K	C1808P183K1X(4)C	CDR03BX183BKW(4)
	22,000	K,M	C1808P223(3)1X(4)C	CDR03BX223B(3)W(4)
	27,000	K	C1808P273K1X(4)C	CDR03BX273BKW(4)
	33,000	K,M	C1808P333(3)1X(4)C	CDR03BX333B(3)W(4)
<b>50 Volt — C1808 SIZE (MILITARY CDR03)</b>				
BX	39,000	K	C1808P393K5X(4)C	CDR03BX393AKW(4)
	47,000	K,M	C1808P473(3)5X(4)C	CDR03BX473A(3)W(4)
	56,000	K	C1808P563K5X(4)C	CDR03BX563AKW(4)
	68,000	K,M	C1808P683(3)5X(4)C	CDR03BX683A(3)W(4)
<b>100 Volt — C1812 SIZE (MILITARY CDR04)</b>				
BP	1,200	J	C1812P122J1G(4)C	CDR04BP122BJW(4)
	1,500	J,K	C1812P152(3)1G(4)C	CDR04BP152B(3)W(4)
	1,800	J	C1812P182J1G(4)C	CDR04BP182BJW(4)
	2,200	J,K	C1812P222(3)1G(4)C	CDR04BP222B(3)W(4)
	2,700	J	C1812P272J1G(4)C	CDR04BP272BJW(4)
	3,300	J,K	C1812P332(3)1G(4)C	CDR04BP332B(3)W(4)
BX	39,000	K	C1812P393K1X(4)C	CDR04BX393BKW(4)
	47,000	K,M	C1812P473(3)1X(4)C	CDR04BX473B(3)W(4)
	56,000	K	C1812P563K1X(4)C	CDR04BX563BKW(4)
	68,000	K	C1812P683K5X(4)C	CDR04BX683AKW(4)
BX	100,000	K,M	C1812P104(3)5X(4)C	CDR04BX104A(3)W(4)
	120,000	K	C1812P124K5X(4)C	CDR04BX124AKW(4)
	150,000	K,M	C1812P154(3)5X(4)C	CDR04BX154A(3)W(4)
	180,000	K	C1812P184K5X(4)C	CDR04BX184AKW(4)
	<b>100 Volt — C1825 SIZE (MILITARY CDR05)</b>			
BP	3,900	J,K	C1825P392(3)1G(4)C	CDR05BP392B(3)W(4)
	4,700	J,K	C1825P472(3)1G(4)C	CDR05BP472B(3)W(4)
	5,600	J,K	C1825P562(3)1G(4)C	CDR05BP562B(3)W(4)
BX	68,000	K,M	C1825P683(3)1X(4)C	CDR05BX683B(3)W(4)
	82,000	K	C1825P823K1X(4)C	CDR05BX823BKW(4)
	100,000	K,M	C1825P104(3)1X(4)C	CDR05BX104B(3)W(4)
	120,000	K	C1825P124K1X(4)C	CDR05BX124BKW(4)
	150,000	K,M	C1825P154(3)1X(4)C	CDR05BX154B(3)W(4)
<b>50 Volt — C1825 SIZE (MILITARY CDR05)</b>				
BX	220,000	K,M	C1825P224(3)5X(4)C	CDR05BX224A(3)W(4)
	270,000	K	C1825P274K5X(4)C	CDR05BX274AKW(4)
	330,000	K,M	C1825P334(3)5X(4)C	CDR05BX334A(3)W(4)
<b>100 Volt — C2225 SIZE (MILITARY CDR06)</b>				
BP	6,800	J,K	C2225P682(3)1G(4)C	CDR06BP682B(3)W(4)
	8,200	J,K	C2225P822(3)1G(4)C	CDR06BP822B(3)W(4)
	10,000	J,K	C2225P103(3)1G(4)C	CDR06BP103B(3)W(4)
<b>50 Volt — C2225 SIZE (MILITARY CDR06)</b>				
BX	390,000	K	C2225P394K5X(4)C	CDR06BX394AKW(4)
	470,000	K,M	C2225P474(3)5X(4)C	CDR06BX474A(3)W(4)

- (1) To complete Part Number for Dielectric, insert P or X symbol – as defined by Military specification.
- (2) To complete Part Number for Dielectric, insert G or X symbol. ("G" for Military "BP," or "X" for Military "BX.")
- (3) To complete Part Number, insert Capacitance Tolerance Symbol (when applicable) as available in MIL-PRF-55681: B – ±0.1 pF, C – ±0.25 pF, D – ±0.5pF, F – ±1%, J – ±5%, K – ±10%, M – ±20%. **NOTE: Available tolerances are listed in columns above.**
- (4) To complete Part Number, insert Failure Rate Symbol: M –1.0%; P –0.1%; R –0.01%; S –.001%.

Note: All MIL-PRF-55681 and KEMET Part Numbers tabulated above assume use of Solderguard II (MIL-PRF-55681 "W"; KEMET "C") end metalization. If MIL-PRF-55681 "U" or "S" (KEMET "H") or MIL-PRF-55681 "Y" (KEMET "C") is required, please change designators accordingly.

## RATINGS & PART NUMBER REFERENCE

CAP. pF	AVAIL. TOL.	KEMET CAPACITORS	MIL-PRF-55681 PART NUMBER
<b>100 Volt — BP — C0805 SIZE (MILITARY CDR31)</b>			
1.0	B,C	C0805N109(3)1G(4)C	CDR31BP1R0B(3)W(4)
1.1	B,C	C0805N119(3)1G(4)C	CDR31BP1R1B(3)W(4)
1.2	B,C	C0805N129(3)1G(4)C	CDR31BP1R2B(3)W(4)
1.3	B,C	C0805N139(3)1G(4)C	CDR31BP1R3B(3)W(4)
1.5	B,C	C0805N159(3)1G(4)C	CDR31BP1R5B(3)W(4)
1.6	B,C	C0805N169(3)1G(4)C	CDR31BP1R6B(3)W(4)
1.8	B,C	C0805N189(3)1G(4)C	CDR31BP1R8B(3)W(4)
2.0	B,C	C0805N209(3)1G(4)C	CDR31BP2R0B(3)W(4)
2.2	B,C	C0805N229(3)1G(4)C	CDR31BP2R2B(3)W(4)
2.4	B,C	C0805N249(3)1G(4)C	CDR31BP2R4B(3)W(4)
2.7	B,C,D	C0805N279(3)1G(4)C	CDR31BP2R7B(3)W(4)
3.0	B,C,D	C0805N309(3)1G(4)C	CDR31BP3R0B(3)W(4)
3.3	B,C,D	C0805N339(3)1G(4)C	CDR31BP3R3B(3)W(4)
3.6	B,C,D	C0805N369(3)1G(4)C	CDR31BP3R6B(3)W(4)
3.9	B,C,D	C0805N399(3)1G(4)C	CDR31BP3R9B(3)W(4)
4.3	B,C,D	C0805N439(3)1G(4)C	CDR31BP4R3B(3)W(4)
4.7	B,C,D	C0805N479(3)1G(4)C	CDR31BP4R7B(3)W(4)
5.1	B,C,D	C0805N519(3)1G(4)C	CDR31BP5R1B(3)W(4)
5.6	B,C,D	C0805N569(3)1G(4)C	CDR31BP5R6B(3)W(4)
6.2	B,C,D	C0805N629(3)1G(4)C	CDR31BP6R2B(3)W(4)
6.8	B,C,D	C0805N689(3)1G(4)C	CDR31BP6R8B(3)W(4)
7.5	B,C,D	C0805N759(3)1G(4)C	CDR31BP7R5B(3)W(4)
8.2	B,C,D	C0805N829(3)1G(4)C	CDR31BP8R2B(3)W(4)
9.1	B,C,D	C0805N919(3)1G(4)C	CDR31BP9R1B(3)W(4)
10	F,J,K	C0805N100(3)1G(4)C	CDR31BP100B(3)W(4)
11	F,J,K	C0805N110(3)1G(4)C	CDR31BP110B(3)W(4)
12	F,J,K	C0805N120(3)1G(4)C	CDR31BP120B(3)W(4)
13	F,J,K	C0805N130(3)1G(4)C	CDR31BP130B(3)W(4)
15	F,J,K	C0805N150(3)1G(4)C	CDR31BP150B(3)W(4)
16	F,J,K	C0805N160(3)1G(4)C	CDR31BP160B(3)W(4)
18	F,J,K	C0805N180(3)1G(4)C	CDR31BP180B(3)W(4)
20	F,J,K	C0805N200(3)1G(4)C	CDR31BP200B(3)W(4)
22	F,J,K	C0805N220(3)1G(4)C	CDR31BP220B(3)W(4)
24	F,J,K	C0805N240(3)1G(4)C	CDR31BP240B(3)W(4)
27	F,J,K	C0805N270(3)1G(4)C	CDR31BP270B(3)W(4)
30	F,J,K	C0805N300(3)1G(4)C	CDR31BP300B(3)W(4)
33	F,J,K	C0805N330(3)1G(4)C	CDR31BP330B(3)W(4)
36	F,J,K	C0805N360(3)1G(4)C	CDR31BP360B(3)W(4)
39	F,J,K	C0805N390(3)1G(4)C	CDR31BP390B(3)W(4)
43	F,J,K	C0805N430(3)1G(4)C	CDR31BP430B(3)W(4)
47	F,J,K	C0805N470(3)1G(4)C	CDR31BP470B(3)W(4)
51	F,J,K	C0805N510(3)1G(4)C	CDR31BP510B(3)W(4)
56	F,J,K	C0805N560(3)1G(4)C	CDR31BP560B(3)W(4)
62	F,J,K	C0805N620(3)1G(4)C	CDR31BP620B(3)W(4)
68	F,J,K	C0805N680(3)1G(4)C	CDR31BP680B(3)W(4)
75	F,J,K	C0805N750(3)1G(4)C	CDR31BP750B(3)W(4)
82	F,J,K	C0805N820(3)1G(4)C	CDR31BP820B(3)W(4)

CAP. pF	AVAIL. TOL.	KEMET CAPACITORS	MIL-PRF-55681 PART NUMBER
<b>100 Volt — BP — C0805 SIZE (MILITARY CDR31)</b>			
91	F,J,K	C0805N910(3)1G(4)C	CDR31BP910B(3)W(4)
100	F,J,K	C0805N101(3)1G(4)C	CDR31BP101B(3)W(4)
110	F,J,K	C0805N111(3)1G(4)C	CDR31BP111B(3)W(4)
120	F,J,K	C0805N121(3)1G(4)C	CDR31BP121B(3)W(4)
130	F,J,K	C0805N131(3)1G(4)C	CDR31BP131B(3)W(4)
150	F,J,K	C0805N151(3)1G(4)C	CDR31BP151B(3)W(4)
160	F,J,K	C0805N161(3)1G(4)C	CDR31BP161B(3)W(4)
180	F,J,K	C0805N181(3)1G(4)C	CDR31BP181B(3)W(4)
200	F,J,K	C0805N201(3)1G(4)C	CDR31BP201B(3)W(4)
220	F,J,K	C0805N221(3)1G(4)C	CDR31BP221B(3)W(4)
240	F,J,K	C0805N241(3)1G(4)C	CDR31BP241B(3)W(4)
270	F,J,K	C0805N271(3)1G(4)C	CDR31BP271B(3)W(4)
300	F,J,K	C0805N301(3)1G(4)C	CDR31BP301B(3)W(4)
330	F,J,K	C0805N331(3)1G(4)C	CDR31BP331B(3)W(4)
360	F,J,K	C0805N361(3)1G(4)C	CDR31BP361B(3)W(4)
390	F,J,K	C0805N391(3)1G(4)C	CDR31BP391B(3)W(4)
430	F,J,K	C0805N431(3)1G(4)C	CDR31BP431B(3)W(4)
470	F,J,K	C0805N471(3)1G(4)C	CDR31BP471B(3)W(4)
<b>50 Volt — BP — C0805 SIZE (MILITARY CDR31)</b>			
510	F,J,K	C0805N511(3)5G(4)C	CDR31BP511A(3)W(4)
560	F,J,K	C0805N561(3)5G(4)C	CDR31BP561A(3)W(4)
620	F,J,K	C0805N621(3)5G(4)C	CDR31BP621A(3)W(4)
680	F,J,K	C0805N681(3)5G(4)C	CDR31BP681A(3)W(4)
<b>100 Volt — BX — C0805 SIZE (MILITARY CDR31)</b>			
470	K,M	C0805N471(3)1X(4)C	CDR31BX471B(3)W(4)
560	K,M	C0805N561(3)1X(4)C	CDR31BX561B(3)W(4)
680	K,M	C0805N681(3)1X(4)C	CDR31BX681B(3)W(4)
820	K,M	C0805N821(3)1X(4)C	CDR31BX821B(3)W(4)
1,000	K,M	C0805N102(3)1X(4)C	CDR31BX102B(3)W(4)
1,200	K,M	C0805N122(3)1X(4)C	CDR31BX122B(3)W(4)
1,500	K,M	C0805N152(3)1X(4)C	CDR31BX152B(3)W(4)
1,800	K,M	C0805N182(3)1X(4)C	CDR31BX182B(3)W(4)
2,200	K,M	C0805N222(3)1X(4)C	CDR31BX222B(3)W(4)
2,700	K,M	C0805N272(3)1X(4)C	CDR31BX272B(3)W(4)
3,300	K,M	C0805N332(3)1X(4)C	CDR31BX332B(3)W(4)
3,900	K,M	C0805N392(3)1X(4)C	CDR31BX392B(3)W(4)
4,700	K,M	C0805N472(3)1X(4)C	CDR31BX472B(3)W(4)
<b>50 Volt — BX — C0805 SIZE (MILITARY CDR31)</b>			
5,600	K,M	C0805N562(3)5X(4)C	CDR31BX562A(3)W(4)
6,800	K,M	C0805N682(3)5X(4)C	CDR31BX682A(3)W(4)
8,200	K,M	C0805N822(3)5X(4)C	CDR31BX822A(3)W(4)
10,000	K,M	C0805N103(3)5X(4)C	CDR31BX103A(3)W(4)
12,000	K,M	C0805N123(3)5X(4)C	CDR31BX123A(3)W(4)
15,000	K,M	C0805N153(3)5X(4)C	CDR31BX153A(3)W(4)
18,000	K,M	C0805N183(3)5X(4)C	CDR31BX183A(3)W(4)

- To complete Part Number for Dielectric, insert P or X symbol – as defined by Military specification.
- To complete Part Number for Dielectric, insert G or X symbol. (“G” for Military “BP,” or “X” for Military “BX.”)
- To complete Part Number, insert Capacitance Tolerance Symbol (when applicable) as available in MIL-PRF-55681: B – ±0.1 pF, C – ±0.25 pF, D – ±0.5pF, F – ±1%, J – ±5%, K – ±10%, M – ±20%. **NOTE: Available tolerances are listed in columns above.**
- To complete Part Number, insert Failure Rate Symbol: M –1.0%; P –0.1%; R –0.01%; S –.001%.

Note: All MIL-PRF-55681 and KEMET Part Numbers tabulated above assume use of Solderguard II (MIL-PRF-55681 “W”; KEMET “C”) end metal-ization. If MIL-PRF-55681 “U” or “S” (KEMET “H”) or MIL-PRF-55681 “Y” (KEMET “C”) is required, please change designators accordingly.

### MARKING

See page 67 for MIL-PRF-55681 Marking

## RATINGS & PART NUMBER REFERENCE

CAP. pF	AVAIL. TOL.	KEMET CAPACITORS	MIL-PRF-55681 PART NUMBER
<b>100 Volt — BP — C1206 SIZE (MILITARY CDR32)</b>			
1.0	B,C	C1206N109(3)1G(4)C	CDR32BP1R0B(3)W(4)
1.1	B,C	C1206N119(3)1G(4)C	CDR32BP1R1B(3)W(4)
1.2	B,C	C1206N129(3)1G(4)C	CDR32BP1R2B(3)W(4)
1.3	B,C	C1206N139(3)1G(4)C	CDR32BP1R3B(3)W(4)
1.5	B,C	C1206N159(3)1G(4)C	CDR32BP1R5B(3)W(4)
1.6	B,C	C1206N169(3)1G(4)C	CDR32BP1R6B(3)W(4)
1.8	B,C	C1206N189(3)1G(4)C	CDR32BP1R8B(3)W(4)
2.0	B,C	C1206N209(3)1G(4)C	CDR32BP2R0B(3)W(4)
2.2	B,C	C1206N229(3)1G(4)C	CDR32BP2R2B(3)W(4)
2.4	B,C	C1206N249(3)1G(4)C	CDR32BP2R4B(3)W(4)
2.7	B,C,D	C1206N279(3)1G(4)C	CDR32BP2R7B(3)W(4)
3.0	B,C,D	C1206N309(3)1G(4)C	CDR32BP3R0B(3)W(4)
3.3	B,C,D	C1206N339(3)1G(4)C	CDR32BP3R3B(3)W(4)
3.6	B,C,D	C1206N369(3)1G(4)C	CDR32BP3R6B(3)W(4)
3.9	B,C,D	C1206N399(3)1G(4)C	CDR32BP3R9B(3)W(4)
4.3	B,C,D	C1206N439(3)1G(4)C	CDR32BP4R3B(3)W(4)
4.7	B,C,D	C1206N479(3)1G(4)C	CDR32BP4R7B(3)W(4)
5.1	B,C,D	C1206N519(3)1G(4)C	CDR32BP5R1B(3)W(4)
5.6	B,C,D	C1206N569(3)1G(4)C	CDR32BP5R6B(3)W(4)
6.2	B,C,D	C1206N629(3)1G(4)C	CDR32BP6R2B(3)W(4)
6.8	B,C,D	C1206N689(3)1G(4)C	CDR32BP6R8B(3)W(4)
7.5	B,C,D	C1206N759(3)1G(4)C	CDR32BP7R5B(3)W(4)
8.2	B,C,D	C1206N829(3)1G(4)C	CDR32BP8R2B(3)W(4)
9.1	B,C,D	C1206N919(3)1G(4)C	CDR32BP9R1B(3)W(4)
10	F,J,K	C1206N100(3)1G(4)C	CDR32BP100B(3)W(4)
11	F,J,K	C1206N110(3)1G(4)C	CDR32BP110B(3)W(4)
12	F,J,K	C1206N120(3)1G(4)C	CDR32BP120B(3)W(4)
13	F,J,K	C1206N130(3)1G(4)C	CDR32BP130B(3)W(4)
15	F,J,K	C1206N150(3)1G(4)C	CDR32BP150B(3)W(4)
16	F,J,K	C1206N160(3)1G(4)C	CDR32BP160B(3)W(4)
18	F,J,K	C1206N180(3)1G(4)C	CDR32BP180B(3)W(4)
20	F,J,K	C1206N200(3)1G(4)C	CDR32BP200B(3)W(4)
22	F,J,K	C1206N220(3)1G(4)C	CDR32BP220B(3)W(4)
24	F,J,K	C1206N240(3)1G(4)C	CDR32BP240B(3)W(4)
27	F,J,K	C1206N270(3)1G(4)C	CDR32BP270B(3)W(4)
30	F,J,K	C1206N300(3)1G(4)C	CDR32BP300B(3)W(4)
33	F,J,K	C1206N330(3)1G(4)C	CDR32BP330B(3)W(4)
36	F,J,K	C1206N360(3)1G(4)C	CDR32BP360B(3)W(4)
39	F,J,K	C1206N390(3)1G(4)C	CDR32BP390B(3)W(4)
43	F,J,K	C1206N430(3)1G(4)C	CDR32BP430B(3)W(4)
47	F,J,K	C1206N470(3)1G(4)C	CDR32BP470B(3)W(4)
51	F,J,K	C1206N510(3)1G(4)C	CDR32BP510B(3)W(4)
56	F,J,K	C1206N560(3)1G(4)C	CDR32BP560B(3)W(4)
62	F,J,K	C1206N620(3)1G(4)C	CDR32BP620B(3)W(4)
68	F,J,K	C1206N680(3)1G(4)C	CDR32BP680B(3)W(4)
75	F,J,K	C1206N750(3)1G(4)C	CDR32BP750B(3)W(4)
82	F,J,K	C1206N820(3)1G(4)C	CDR32BP820B(3)W(4)
91	F,J,K	C1206N910(3)1G(4)C	CDR32BP910B(3)W(4)
100	F,J,K	C1206N101(3)1G(4)C	CDR32BP101B(3)W(4)

CAP. pF	AVAIL. TOL.	KEMET CAPACITORS	MIL-PRF-55681 PART NUMBER
<b>100 Volt — BP — C1206 SIZE (MILITARY CDR32)</b>			
110	F,J,K	C1206N111(3)1G(4)C	CDR32BP111B(3)W(4)
120	F,J,K	C1206N121(3)1G(4)C	CDR32BP121B(3)W(4)
130	F,J,K	C1206N131(3)1G(4)C	CDR32BP131B(3)W(4)
150	F,J,K	C1206N151(3)1G(4)C	CDR32BP151B(3)W(4)
160	F,J,K	C1206N161(3)1G(4)C	CDR32BP161B(3)W(4)
180	F,J,K	C1206N181(3)1G(4)C	CDR32BP181B(3)W(4)
200	F,J,K	C1206N201(3)1G(4)C	CDR32BP201B(3)W(4)
220	F,J,K	C1206N221(3)1G(4)C	CDR32BP221B(3)W(4)
240	F,J,K	C1206N241(3)1G(4)C	CDR32BP241B(3)W(4)
270	F,J,K	C1206N271(3)1G(4)C	CDR32BP271B(3)W(4)
300	F,J,K	C1206N301(3)1G(4)C	CDR32BP301B(3)W(4)
330	F,J,K	C1206N331(3)1G(4)C	CDR32BP331B(3)W(4)
360	F,J,K	C1206N361(3)1G(4)C	CDR32BP361B(3)W(4)
390	F,J,K	C1206N391(3)1G(4)C	CDR32BP391B(3)W(4)
430	F,J,K	C1206N431(3)1G(4)C	CDR32BP431B(3)W(4)
470	F,J,K	C1206N471(3)1G(4)C	CDR32BP471B(3)W(4)
510	F,J,K	C1206N511(3)1G(4)C	CDR32BP511B(3)W(4)
560	F,J,K	C1206N561(3)1G(4)C	CDR32BP561B(3)W(4)
620	F,J,K	C1206N621(3)1G(4)C	CDR32BP621B(3)W(4)
680	F,J,K	C1206N681(3)1G(4)C	CDR32BP681B(3)W(4)
750	F,J,K	C1206N751(3)1G(4)C	CDR32BP751B(3)W(4)
820	F,J,K	C1206N821(3)1G(4)C	CDR32BP821B(3)W(4)
910	F,J,K	C1206N911(3)1G(4)C	CDR32BP911B(3)W(4)
1,000	F,J,K	C1206N102(3)1G(4)C	CDR32BP102B(3)W(4)
<b>50 Volt — BP — C1206 SIZE (MILITARY CDR32)</b>			
1,100	F,J,K	C1206N112(3)5G(4)C	CDR32BP112A(3)W(4)
1,200	F,J,K	C1206N122(3)5G(4)C	CDR32BP122A(3)W(4)
1,300	F,J,K	C1206N132(3)5G(4)C	CDR32BP132A(3)W(4)
1,500	F,J,K	C1206N152(3)5G(4)C	CDR32BP152A(3)W(4)
1,600	F,J,K	C1206N162(3)5G(4)C	CDR32BP162A(3)W(4)
1,800	F,J,K	C1206N182(3)5G(4)C	CDR32BP182A(3)W(4)
2,000	F,J,K	C1206N202(3)5G(4)C	CDR32BP202A(3)W(4)
2,200	F,J,K	C1206N222(3)5G(4)C	CDR32BP222A(3)W(4)
<b>100 Volt — BX — C1206 SIZE (MILITARY CDR32)</b>			
4,700	K,M	C1206N472(3)1X(4)C	CDR32BX472B(3)W(4)
5,600	K,M	C1206N562(3)1X(4)C	CDR32BX562B(3)W(4)
6,800	K,M	C1206N682(3)1X(4)C	CDR32BX682B(3)W(4)
8,200	K,M	C1206N822(3)1X(4)C	CDR32BX822B(3)W(4)
10,000	K,M	C1206N103(3)1X(4)C	CDR32BX103B(3)W(4)
12,000	K,M	C1206N123(3)1X(4)C	CDR32BX123B(3)W(4)
15,000	K,M	C1206N153(3)1X(4)C	CDR32BX153B(3)W(4)
<b>50 Volt — BX — C1206 SIZE (MILITARY CDR32)</b>			
18,000	K,M	C1206N183(3)5X(4)C	CDR32BX183A(3)W(4)
22,000	K,M	C1206N223(3)5X(4)C	CDR32BX223A(3)W(4)
27,000	K,M	C1206N273(3)5X(4)C	CDR32BX273A(3)W(4)
33,000	K,M	C1206N333(3)5X(4)C	CDR32BX333A(3)W(4)
39,000	K,M	C1206N393(3)5X(4)C	CDR32BX393A(3)W(4)

- To complete Part Number for Dielectric, insert P or X symbol – as defined by Military specification.
- To complete Part Number for Dielectric, insert G or X symbol. (“G” for Military “BP,” or “X” for Military “BX.”)
- To complete Part Number, insert Capacitance Tolerance Symbol (when applicable) as available in MIL-PRF-55681: B – ±0.1 pF, C – ±0.25 pF, D – ±0.5pF, F – ±1%, J – ±5%, K – ±10%, M – ±20%. **NOTE: Available tolerances are listed in columns above.**
- To complete Part Number, insert Failure Rate Symbol: M –1.0%; P –0.1%; R –0.01%; S –.001%.

Note: All MIL-PRF-55681 and KEMET Part Numbers tabulated above assume use of Solderguard II (MIL-PRF-55681 “W”; KEMET “C”) end metalization. If MIL-PRF-55681 “U” or “S” (KEMET “H”) or MIL-PRF-55681 “Y” (KEMET “C”) is required, please change designators accordingly.

## RATINGS & PART NUMBER REFERENCE

CAP. pF	AVAIL. TOL.	KEMET CAPACITORS	MIL-PRF-55681 PART NUMBER
<b>100 Volt — BP — C1210 SIZE (MILITARY CDR33)</b>			
1,000	F,J,K	C1210N102(3)1G(4)C	CDR33BP102B(3)W(4)
1,100	F,J,K	C1210N112(3)1G(4)C	CDR33BP112B(3)W(4)
1,200	F,J,K	C1210N122(3)1G(4)C	CDR33BP122B(3)W(4)
1,300	F,J,K	C1210N132(3)1G(4)C	CDR33BP132B(3)W(4)
1,500	F,J,K	C1210N152(3)1G(4)C	CDR33BP152B(3)W(4)
1,600	F,J,K	C1210N162(3)1G(4)C	CDR33BP162B(3)W(4)
1,800	F,J,K	C1210N182(3)1G(4)C	CDR33BP182B(3)W(4)
2,000	F,J,K	C1210N202(3)1G(4)C	CDR33BP202B(3)W(4)
2,200	F,J,K	C1210N222(3)1G(4)C	CDR33BP222B(3)W(4)
<b>50 Volt — BP — C1210 SIZE (MILITARY CDR33)</b>			
2,400	F,J,K	C1210N242(3)5G(4)C	CDR33BP242A(3)W(4)
2,700	F,J,K	C1210N272(3)5G(4)C	CDR33BP272A(3)W(4)
3,000	F,J,K	C1210N302(3)5G(4)C	CDR33BP302A(3)W(4)
3,300	F,J,K	C1210N332(3)5G(4)C	CDR33BP332A(3)W(4)
<b>100 Volt — BX — C1210 SIZE (MILITARY CDR33)</b>			
15,000	K,M	C1210N153(3)1X(4)C	CDR33BX153B(3)W(4)
18,000	K,M	C1210N183(3)1X(4)C	CDR33BX183B(3)W(4)
22,000	K,M	C1210N223(3)1X(4)C	CDR33BX223B(3)W(4)
27,000	K,M	C1210N273(3)1X(4)C	CDR33BX273B(3)W(4)
<b>50 Volt — BX — C1210 SIZE (MILITARY CDR33)</b>			
39,000	K,M	C1210N393(3)5X(4)C	CDR33BX393A(3)W(4)
47,000	K,M	C1210N473(3)5X(4)C	CDR33BX473A(3)W(4)
56,000	K,M	C1210N563(3)5X(4)C	CDR33BX563A(3)W(4)
68,000	K,M	C1210N683(3)5X(4)C	CDR33BX683A(3)W(4)
82,000	K,M	C1210N823(3)5X(4)C	CDR33BX823A(3)W(4)
100,000	K,M	C1210N104(3)5X(4)C	CDR33BX104A(3)W(4)
<b>100 Volt — BP — C1812 SIZE (MILITARY CDR34)</b>			
2,200	F,J,K	C1812N222(3)1G(4)C	CDR34BP222B(3)W(4)
2,400	F,J,K	C1812N242(3)1G(4)C	CDR34BP242B(3)W(4)
2,700	F,J,K	C1812N272(3)1G(4)C	CDR34BP272B(3)W(4)
3,000	F,J,K	C1812N302(3)1G(4)C	CDR34BP302B(3)W(4)
3,300	F,J,K	C1812N332(3)1G(4)C	CDR34BP332B(3)W(4)
3,600	F,J,K	C1812N362(3)1G(4)C	CDR34BP362B(3)W(4)
3,900	F,J,K	C1812N392(3)1G(4)C	CDR34BP392B(3)W(4)
4,300	F,J,K	C1812N432(3)1G(4)C	CDR34BP432B(3)W(4)
4,700	F,J,K	C1812N472(3)1G(4)C	CDR34BP472B(3)W(4)
<b>50 Volt — BP — C1812 SIZE (MILITARY CDR34)</b>			
5,100	F,J,K	C1812N512(3)5G(4)C	CDR34BP512A(3)W(4)
5,600	F,J,K	C1812N562(3)5G(4)C	CDR34BP562A(3)W(4)
6,200	F,J,K	C1812N622(3)5G(4)C	CDR34BP622A(3)W(4)
6,800	F,J,K	C1812N682(3)5G(4)C	CDR34BP682A(3)W(4)
7,500	F,J,K	C1812N752(3)5G(4)C	CDR34BP752A(3)W(4)
8,200	F,J,K	C1812N822(3)5G(4)C	CDR34BP822A(3)W(4)
9,100	F,J,K	C1812N912(3)5G(4)C	CDR34BP912A(3)W(4)
10,000	F,J,K	C1812N103(3)5G(4)C	CDR34BP103A(3)W(4)

CAP. pF	AVAIL. TOL.	KEMET CAPACITORS	MIL-PRF-55681 PART NUMBER
<b>100 Volt — BX — C1812 SIZE (MILITARY CDR34)</b>			
27,000	K,M	C1812N273(3)1X(4)C	CDR34BX273B(3)W(4)
33,000	K,M	C1812N333(3)1X(4)C	CDR34BX333B(3)W(4)
39,000	K,M	C1812N393(3)1X(4)C	CDR34BX393B(3)W(4)
47,000	K,M	C1812N473(3)1X(4)C	CDR34BX473B(3)W(4)
56,000	K,M	C1812N563(3)1X(4)C	CDR34BX563B(3)W(4)
<b>50 Volt — BX — C1812 SIZE (MILITARY CDR34)</b>			
100,000	K,M	C1812N104(3)5X(4)C	CDR34BX104A(3)W(4)
120,000	K,M	C1812N124(3)5X(4)C	CDR34BX124A(3)W(4)
150,000	K,M	C1812N154(3)5X(4)C	CDR34BX154A(3)W(4)
180,000	K,M	C1812N184(3)5X(4)C	CDR34BX184A(3)W(4)
<b>100 Volt — BP — C1825 SIZE (MILITARY CDR35)</b>			
4,700	F,J,K	C1825N472(3)1G(4)C	CDR35BP472B(3)W(4)
5,100	F,J,K	C1825N512(3)1G(4)C	CDR35BP512B(3)W(4)
5,600	F,J,K	C1825N562(3)1G(4)C	CDR35BP562B(3)W(4)
6,200	F,J,K	C1825N622(3)1G(4)C	CDR35BP622B(3)W(4)
6,800	F,J,K	C1825N682(3)1G(4)C	CDR35BP682B(3)W(4)
7,500	F,J,K	C1825N752(3)1G(4)C	CDR35BP752B(3)W(4)
8,200	F,J,K	C1825N822(3)1G(4)C	CDR35BP822B(3)W(4)
9,100	F,J,K	C1825N912(3)1G(4)C	CDR35BP912B(3)W(4)
10,000	F,J,K	C1825N103(3)1G(4)C	CDR35BP103B(3)W(4)
<b>50 Volt — BP — C1825 SIZE (MILITARY CDR35)</b>			
11,000	F,J,K	C1825N113(3)5G(4)C	CDR35BP113A(3)W(4)
12,000	F,J,K	C1825N123(3)5G(4)C	CDR35BP123A(3)W(4)
13,000	F,J,K	C1825N133(3)5G(4)C	CDR35BP133A(3)W(4)
15,000	F,J,K	C1825N153(3)5G(4)C	CDR35BP153A(3)W(4)
16,000	F,J,K	C1825N163(3)5G(4)C	CDR35BP163A(3)W(4)
18,000	F,J,K	C1825N183(3)5G(4)C	CDR35BP183A(3)W(4)
20,000	F,J,K	C1825N203(3)5G(4)C	CDR35BP203A(3)W(4)
22,000	F,J,K	C1825N223(3)5G(4)C	CDR35BP223A(3)W(4)
<b>100 Volt — BX — C1825 SIZE (MILITARY CDR35)</b>			
56,000	K,M	C1825N563(3)1X(4)C	CDR35BX563B(3)W(4)
68,000	K,M	C1825N683(3)1X(4)C	CDR35BX683B(3)W(4)
82,000	K,M	C1825N823(3)1X(4)C	CDR35BX823B(3)W(4)
100,000	K,M	C1825N104(3)1X(4)C	CDR35BX104B(3)W(4)
120,000	K,M	C1825N124(3)1X(4)C	CDR35BX124B(3)W(4)
150,000	K,M	C1825N154(3)1X(4)C	CDR35BX154B(3)W(4)
<b>50 Volt — BX — C1825 SIZE (MILITARY CDR35)</b>			
180,000	K,M	C1825N184(3)5X(4)C	CDR35BX184A(3)W(4)
220,000	K,M	C1825N224(3)5X(4)C	CDR35BX224A(3)W(4)
270,000	K,M	C1825N274(3)5X(4)C	CDR35BX274A(3)W(4)
330,000	K,M	C1825N334(3)5X(4)C	CDR35BX334A(3)W(4)
390,000	K,M	C1825N394(3)5X(4)C	CDR35BX394A(3)W(4)
470,000	K,M	C1825N474(3)5X(4)C	CDR35BX474A(3)W(4)

- (1) To complete Part Number for Dielectric, insert P or X symbol – as defined by Military specification.
- (2) To complete Part Number for Dielectric, insert G or X symbol. ("G" for Military "BP," or "X" for Military "BX.")
- (3) To complete Part Number, insert Capacitance Tolerance Symbol (when applicable) as available in MIL-PRF-55681: B – ±0.1 pF, C – ±0.25 pF, D – ±0.5pF, F – ±1%, J – ±5%, K – ±10%, M – ±20%. **NOTE: Available tolerances are listed in columns above.**
- (4) To complete Part Number, insert Failure Rate Symbol: M –1.0%; P –0.1%; R –0.01%; S –.001%.

Note: All MIL-PRF-55681 and KEMET Part Numbers tabulated above assume use of Solderguard II (MIL-PRF-55681 "W"; KEMET "C") end metal-ization. If MIL-PRF-55681 "U" or "S" (KEMET "H") or MIL-PRF-55681 "Y" (KEMET "C") is required, please change designators accordingly.

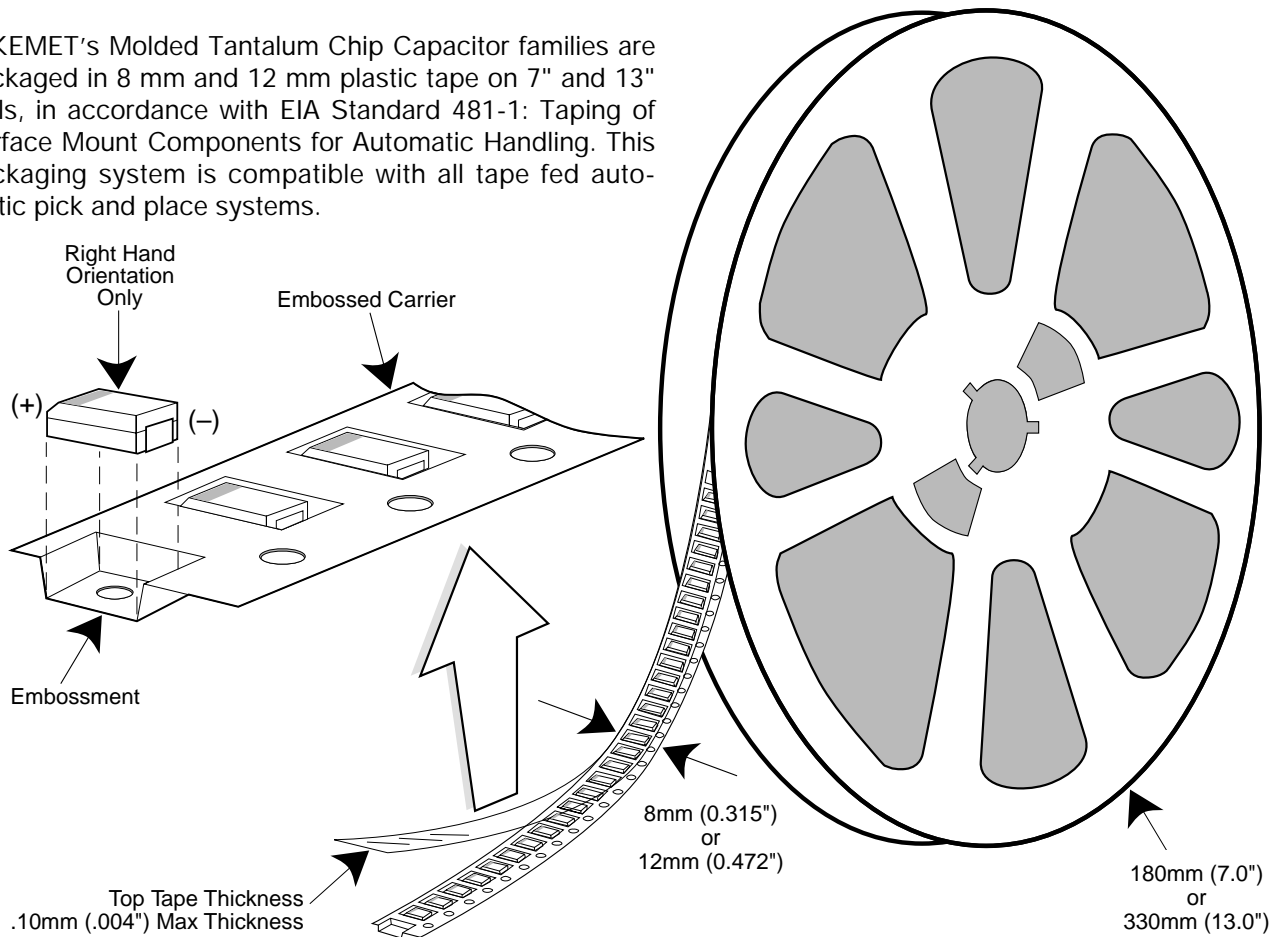
## MIL-PRF-55681 MAXIMUM INDIVIDUAL PACKAGING QUANTITIES

CHIP SIZE	BULK - ANTI-STATIC			CHIP SIZE	BULK - ANTI-STATIC		
	REELED	STD BAG	BAG		REELED	STD BAG	BAG
C0805	2,500	25,000	10,000	C1808	2,500	7,500	3,000
C1206	2,500	25,000	10,000	C1812	1,100	7,500	3,000
C1210	2,500	25,000	10,000	C1825	1,100	7,500	1,000
C1805	2,500	7,500	3,000	C2225	1,100	5,000	1,000

MIL-PRF-55681 chips available in 7" reels only.

### Tape & Reel Packaging

KEMET's Molded Tantalum Chip Capacitor families are packaged in 8 mm and 12 mm plastic tape on 7" and 13" reels, in accordance with EIA Standard 481-1: Taping of Surface Mount Components for Automatic Handling. This packaging system is compatible with all tape fed automatic pick and place systems.



**Labeling:** Bar code labeling (standard or custom) shall be on the side of the reel opposite the sprocket holes. Refer to EIA-556.

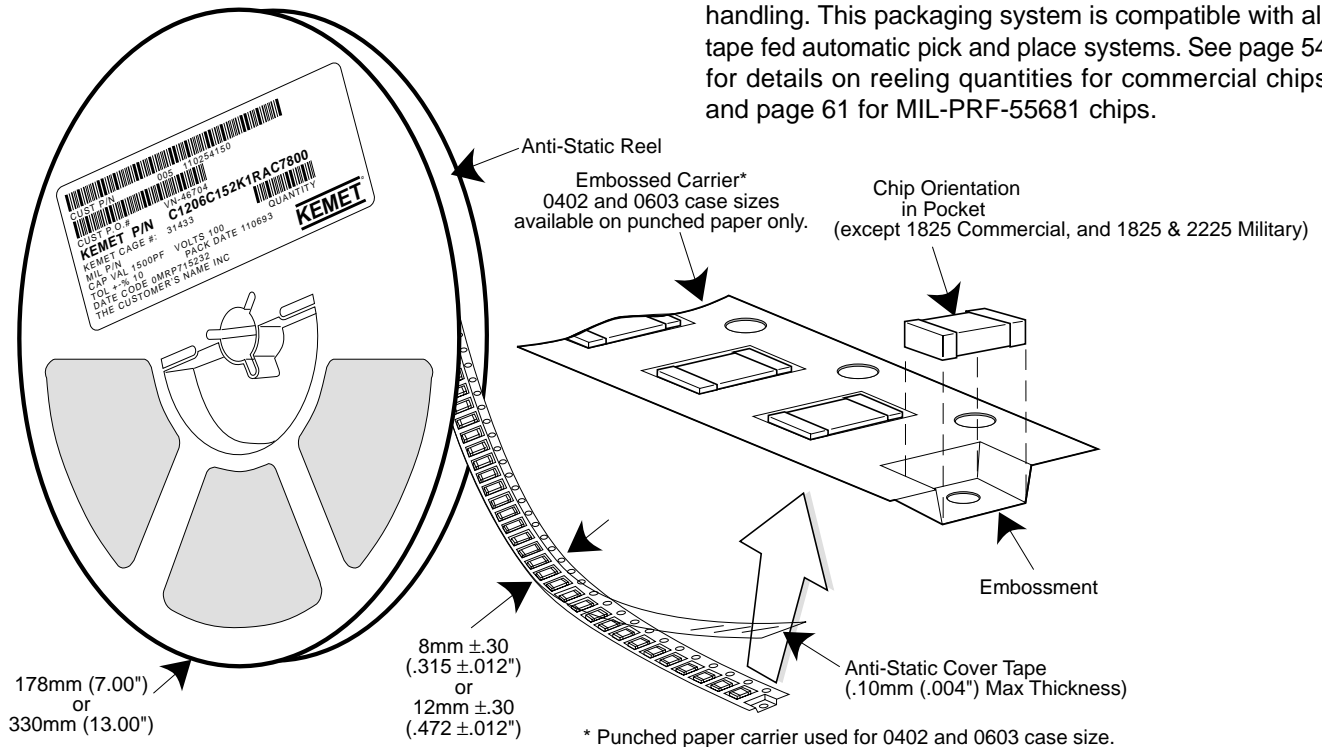
### QUANTITIES PACKAGED PER REEL

Case Code		Tape Width-mm	7" Reel*	13" Reel*
KEMET	EIA			
R	2012-12	8	2,500	10,000
S	3216-12	8	2,500	10,000
T	3528-12	8	2,500	10,000
U	6032-15	12	1,000	5,000
V	7343-20	12	1,000	3,000
A	3216-18	8	2,000	9,000
B	3528-21	8	2,000	8,000
C	6032-28	12	500	3,000
D	7343-31	12	500	2,500
X	7343-43	12	500	2,000
E	7260-38	12	500	2,000

\* No c-spec required for 7" reel packaging. C-7280 required for 13" reel packaging.

### Tape & Reel Packaging

KEMET offers Multilayer Ceramic Chip Capacitors packaged in 8mm and 12mm plastic tape on 7" and 13" reels in accordance with EIA standard 481-1: Taping of surface mount components for automatic handling. This packaging system is compatible with all tape fed automatic pick and place systems. See page 54 for details on reeling quantities for commercial chips and page 61 for MIL-PRF-55681 chips.



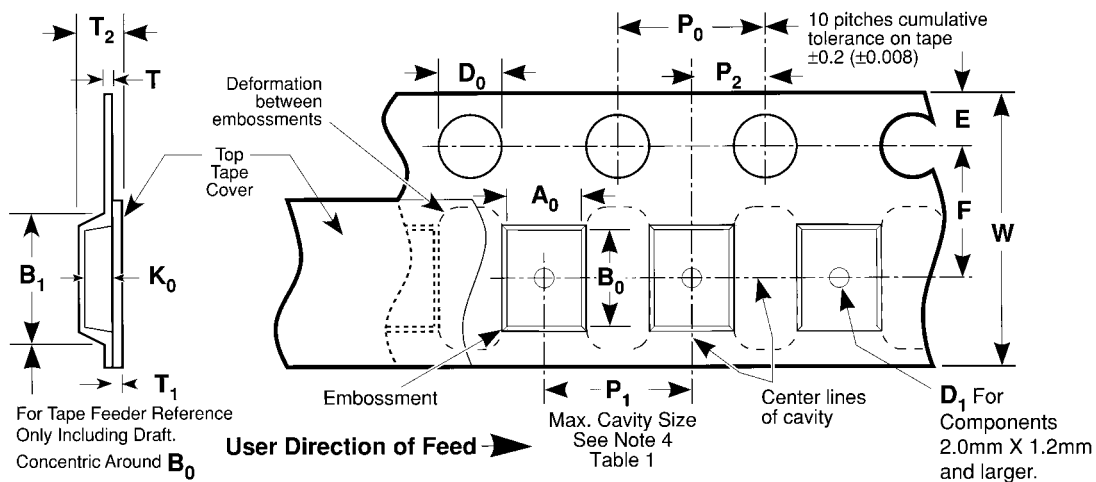
### Performance Notes

- Cover Tape Break Force:** 1.0 Kg Minimum.
- Cover Tape Peel Strength:** The total peel strength of the cover tape from the carrier tape shall be:
 

Tape Width	Peel Strength
8 mm	0.1 Newton to 1.0 Newton (10g to 100g)
12 mm	0.1 Newton to 1.3 Newton (10g to 130g)

The direction of the pull shall be opposite the direction of the carrier tape travel. The pull angle of the carrier tape shall be 165° to 180° from the plane of the carrier tape. During peeling, the carrier and/or cover tape shall be pulled at a velocity of 300 ±10 mm/minute.
- Reel Sizes:** Molded tantalum capacitors are available on either 180 mm (7") reels (standard) or 330 mm (13") reels (with C-7280). Note that 13" reels are preferred.
- Labeling:** Bar code labeling (standard or custom) shall be on the side of the reel opposite the sprocket holes. Refer to EIA-556.

### Embossed Carrier Tape Configuration: Figure 1



**Table 1 — EMBOSSED TAPE DIMENSIONS (Metric will govern)**

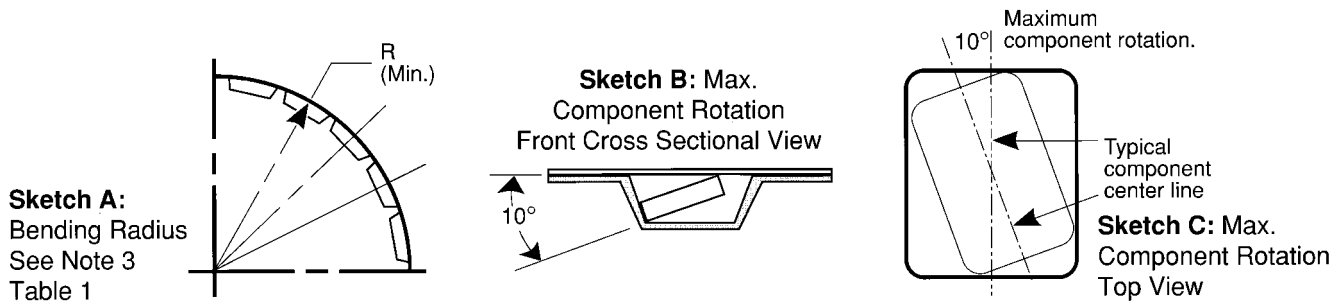
Constant Dimensions — Millimeters (Inches)									
Tape Size	D <sub>0</sub>	E	P <sub>0</sub>	P <sub>2</sub>	T Max	T <sub>1</sub> Max			
8 mm and 12 mm	1.5 +0.10 -0.0 (0.059 +0.004, -0.0)	1.75 ±0.10 (0.069 ±0.004)	4.0 ±0.10 (0.157 ±0.004)	2.0 ±0.05 (0.079 ±0.002)	0.600 (0.024)	0.100 (0.004)			
Variable Dimensions — Millimeters (Inches)									
Tape Size	Pitch	B, Max. Note 1	D <sub>1</sub> Min. Note 2	F	P <sub>1</sub>	R Min. Note 3	T <sub>2</sub> Max	W	A <sub>0</sub> B <sub>0</sub> K <sub>0</sub> Note 4
8 mm	Single (4 mm)	4.4 (0.173)	1.0 (0.039)	3.5 ±0.05 (0.138 ±0.002)	4.0 ±0.10 (0.157 ±0.004)	25.0 (0.984)	2.5 (0.098)	8.0 +0.3 -0.1 (0.315 +0.012, -0.004)	
12 mm	Double (8 mm)	8.2 (0.323)	1.5 (0.059)	5.5 ±0.05 (0.217 ±0.002)	8.0 ±0.10 (0.315 ±0.004)	30.0 (1.181)	4.6 (0.181)	12.0 ±0.30 (0.472 ±0.012)	

### NOTES

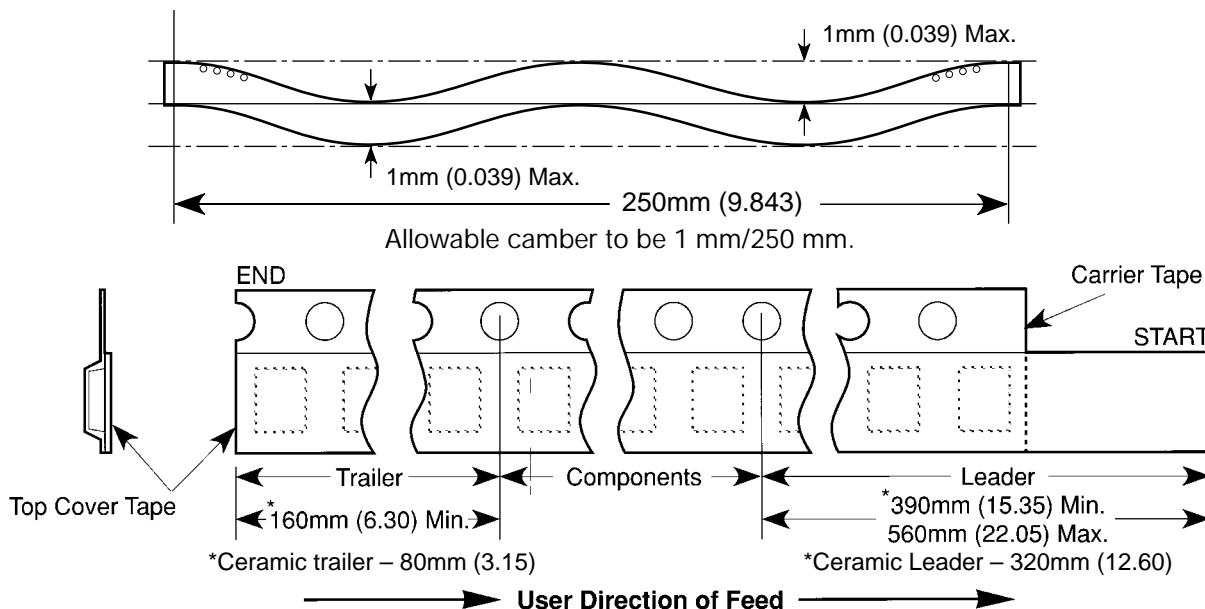
- B1 dimension is a reference dimension for tape feeder clearance only.
- The embossment hole location shall be measured from the sprocket hole controlling the location of the embossment. Dimensions of embossment location and hole location shall be applied independent of each other.
- Tape with components shall pass around radius "R" without damage (see sketch A). The minimum trailer length (Fig. 2) may require additional length to provide R min. for 12 mm embossed tape for reels with hub diameters approaching N min. (Table 2)
- The cavity defined by A<sub>0</sub>, B<sub>0</sub>, and K<sub>0</sub> shall be configured to surround the part with sufficient clearance such that the chip does not protrude beyond the sealing plane of the cover tape, the chip can be removed from the cavity in a vertical direction without mechanical restriction, rotation of the chip is limited to 20 degrees maximum in all 3 planes, and lateral movement of the chip is restricted to 0.5 mm maximum in the pocket (not applicable to vertical clearance.)



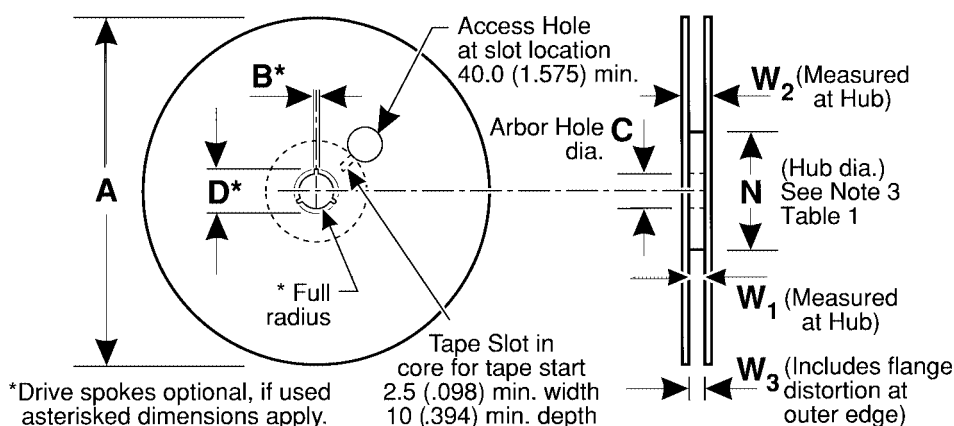
### Tantalum & Embossed Carrier Tape Configuration (cont.)



**Sketch D:** Tape Camber (Top View)



**Figure 2:** Tape Leader & Trailer Dimensions (Metric Dimensions Will Govern)

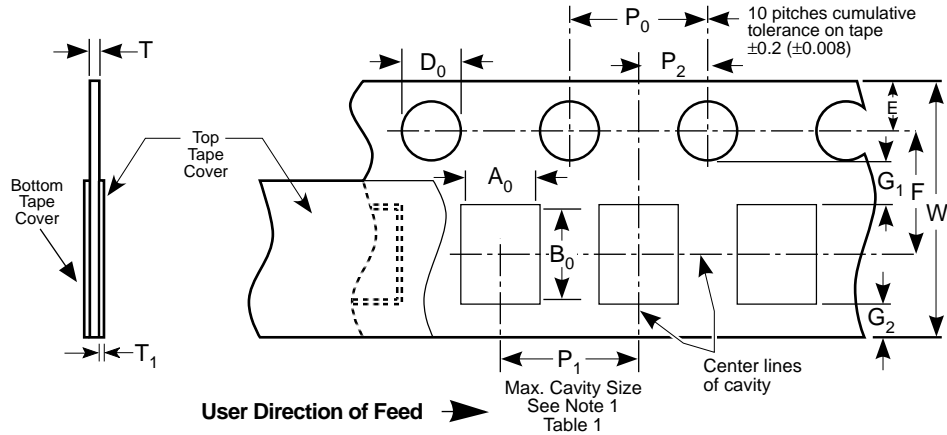


**Figure 3:** Reel Dimensions (Metric Dimensions will govern)

**Table 2 – REEL DIMENSIONS (Metric will govern)**

Tape Size	A Max	$B^*$ Min	C	$D^*$ Min	N Min	$W_1$	$W_2$ Max	$W_3$
8 mm	330.0 (12.992)	1.5 (0.059)	13.0 ± 0.20 (0.512 ± 0.008)	20.2 (0.795)	50.0 (1.969) See Note 3	8.4 +1.5, -0.0 (0.331 +0.059, -0.0)	14.4 (0.567)	7.9 Min (0.311) 10.9 Max (0.429)
12 mm	330.0 (12.992)	1.5 (0.059)	13.0 ± 0.20 (0.512 ± 0.008)	20.2 (0.795)	Table 1	12.4 +2.0, -0.0 (0.488 +0.078, -0.0)	18.4 (0.724)	11.9 Min (0.469) 15.4 Max (0.606)

### Punched Carrier (Paper Tape) Configuration (Ceramic Chips Only):



**Table 1: 8 & 12mm Punched Tape**  
(Metric Dimensions Will Govern)

**Constant Dimensions - Millimeters (Inches)**

Tape Size	D <sub>0</sub>	E	P <sub>0</sub>	P <sub>2</sub>	T <sub>1</sub>	G <sub>1</sub>	G <sub>2</sub>	R Min.
8mm and 12mm	1.5 +0.10, -0.0 (.059 +0.004, -0.0)	1.75 ±0.10 (.069 ±0.004)	4.0 ± 0.10 (.157 ± 0.004)	2.0 ± 0.05 (.079 ± 0.002)	0.10 (.004) Max.	0.75 (.030) Min.	0.75 (.030) Min.	25 (.984) See Note 2 Table 1

**Table 1: 8 & 12mm Punched Tape**  
(Metric Dimensions Will Govern)

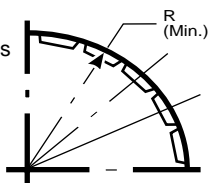
**Variable Dimensions - Millimeters (Inches)**

Tape Size	P <sub>1</sub>	F	W	A <sub>0</sub> B <sub>0</sub>	T
8mm 1/2 Pitch	2.0 ± 0.10 (.079 ± .004) See Requirements Section 3.3 (d)	3.5 ± 0.05 (.138 ± .002)	8.0 + 0.3, - 0.1 (.315 + .012, -.004)	See Note 1 Table 1	1.1mm (.043) Max. for Paper Base Tape and 1.6mm (.063) Max. for Non- Paper Base Compositions. See Note 3.
8mm	4.0 ± 0.10 (0.157 ± .004)				
12mm	4.0 ± 0.10 (0.157 ± .004)	5.5 ± 0.05	12.0 ± 0.3		
12mm Double Pitch	8.0 ± 0.10 (0.315 ± .004)	(.217 ± .002)	(.472 ± .012)		

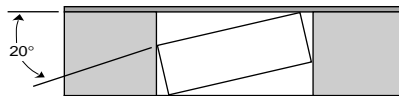
**Note:**

1. A<sub>0</sub>, B<sub>0</sub> and T determined by the maximum dimensions to the ends of the terminals extending from the body and/or the body dimensions of the component. The clearance between the ends of the terminals or body of the component to the sides and depth of the cavity (A<sub>0</sub>, B<sub>0</sub> and T) must be within 0.05mm (.002) minimum and 0.50mm (.020) maximum. The clearance allowed must also prevent rotation of the component within the cavity of not more than 20 degrees (see sketches A and B).
2. Tape with components shall pass around radius "R" without damage.
3. KEMET nominal thicknesses are: 0402 = 0.6mm and all others 0.95mm minimum.

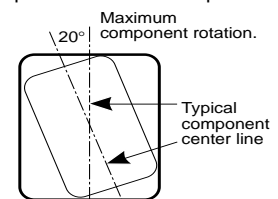
**Sketch A:**  
Bending Radius  
See Note 2  
Table 1



**Sketch B:**  
Max. Component  
Rotation - Front  
Cross Sectional View



**Sketch C:**  
Component Rotation - Top View



### Bulk Cassette Packaging (Ceramic Chips only) (Meets Dimensional Requirements IEC-286-6 and EIAJ 7201)

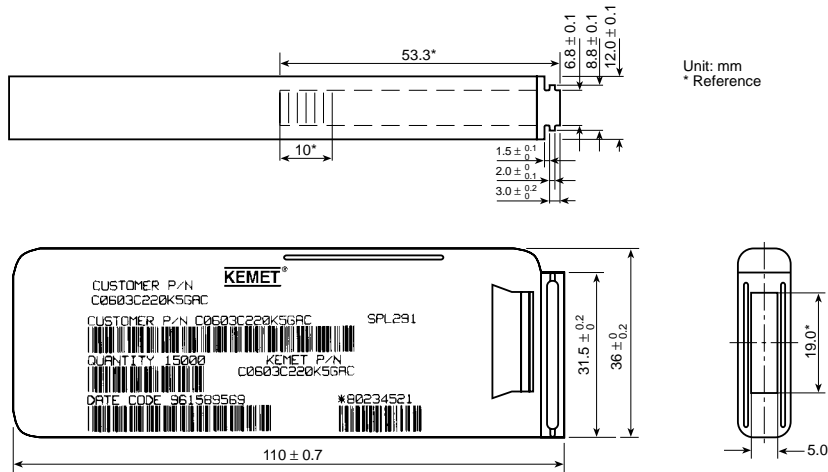


Table 2 – Capacitance Values Available In Bulk Cassette Packaging

Case Size	Dielectric	Voltage	Min. Cap Value	Max. Cap Value
0402	All	All	All	All
0603	All	All	All	All
0805	C0G	200	109	181
		100	109	331
		50	109	102
	X7R	200	221	392
100		221	103	
50		221	273	
25		221	104	
Y5V	25	104	224	
	16	104	224	

Table 1 – Capacitor Dimensions for Bulk Cassette Packaging – Millimeters

Metric Size Code	EIA Size Code	Length L	Width W	Thickness T	Bandwidth B	Minimum Separation S	Number of Pcs/Cassette
1005	0402	1.0 ± 0.05	0.5 ± 0.05	0.5 ± .05	0.2 to 0.4	0.3	50,000
1608	0603	1.6 ± 0.07	0.8 ± 0.07	0.8 ± .07	0.2 to 0.5	0.7	15,000
2012	0805	2.0 ± 0.10	1.25 ± 0.10	0.6 ± .10	0.5 to 0.75	0.75	10,000

Terminations: KEMET nickel barrier layer with a tin overplate.

### CAPACITOR MARKING TABLE (Marking Optional - Not Available for 0402 Size or Y5V Dielectric)

Alpha Character	Numerical	Capacitance (pF) For Various Numerical Identifiers							
		9	0	1	2	3	4	5	6
A	0.10	1.0	10	100	1000	10,000	100,000	1,000,000	10,000,000
B	0.11	1.1	11	110	1100	11,000	110,000	1,100,000	11,000,000
C	0.12	1.2	12	120	1200	12,000	120,000	1,200,000	12,000,000
D	0.13	1.3	13	130	1300	13,000	130,000	1,300,000	13,000,000
E	0.15	1.5	15	150	1500	15,000	150,000	1,500,000	15,000,000
F	0.16	1.6	16	160	1600	16,000	160,000	1,600,000	16,000,000
G	0.18	1.8	18	180	1800	18,000	180,000	1,800,000	18,000,000
H	0.20	2.0	20	200	2000	20,000	200,000	2,000,000	20,000,000
J	0.22	2.2	22	220	2200	22,000	220,000	2,200,000	22,000,000
K	0.24	2.4	24	240	2400	24,000	240,000	2,400,000	24,000,000
L	0.27	2.7	27	270	2700	27,000	270,000	2,700,000	27,000,000
M	0.30	3.0	30	300	3000	30,000	300,000	3,000,000	30,000,000
N	0.33	3.3	33	330	3300	33,000	330,000	3,300,000	33,000,000
P	0.36	3.6	36	360	3600	36,000	360,000	3,600,000	36,000,000
Q	0.39	3.9	39	390	3900	39,000	390,000	3,900,000	39,000,000
R	0.43	4.3	43	430	4300	43,000	430,000	4,300,000	43,000,000
S	0.47	4.7	47	470	4700	47,000	470,000	4,700,000	47,000,000
T	0.51	5.1	51	510	5100	51,000	510,000	5,100,000	51,000,000
U	0.56	5.6	56	560	5600	56,000	560,000	5,600,000	56,000,000
V	0.62	6.2	62	620	6200	62,000	620,000	6,200,000	62,000,000
W	0.68	6.8	68	680	6800	68,000	680,000	6,800,000	68,000,000
X	0.75	7.5	75	750	7500	75,000	750,000	7,500,000	75,000,000
Y	0.82	8.2	82	820	8200	82,000	820,000	8,200,000	82,000,000
Z	0.91	9.1	91	910	9100	91,000	910,000	9,100,000	91,000,000
a	0.25	2.5	25	250	2500	25,000	250,000	2,500,000	25,000,000
b	0.35	3.5	35	350	3500	35,000	350,000	3,500,000	35,000,000
d	0.40	4.0	40	400	4000	40,000	400,000	4,000,000	40,000,000
e	0.45	4.5	45	450	4500	45,000	450,000	4,500,000	45,000,000
f	0.50	5.0	50	500	5000	50,000	500,000	5,000,000	50,000,000
m	0.60	6.0	60	600	6000	60,000	600,000	6,000,000	60,000,000
n	0.70	7.0	70	700	7000	70,000	700,000	7,000,000	70,000,000
t	0.80	8.0	80	800	8000	80,000	800,000	8,000,000	80,000,000
y	0.90	9.0	90	900	9000	90,000	900,000	9,000,000	90,000,000

Laser marking is available as an extra-cost option for most KEMET ceramic chips. Such marking is two sided, and includes a  $\bar{K}$  to identify KEMET, followed by two characters (per EIA-198 - see table below) to identify the capacitance value. Note that marking is not available for size 0402 nor for any Y5V chip. In addition, the 0603 marking option is limited to the  $\bar{K}$  only.



Example shown is 1,000 pF capacitor.

**World Sales Headquarters**  
**P.O. Box 5928 • Greenville, SC 29606 • [www.kemet.com](http://www.kemet.com)**  
**Phone: (864) 963-6300 • Fax: (864) 963-6521**

## **USA/Canada Locations**

KEMET Electronics Corporation  
26 Corporate Plaza, Suite 170  
Newport Beach, CA 92660  
Phone: 949-640-9320  
Fax: 949-720-9807

KEMET Electronics Corporation  
2350 Mission College Blvd., Suite 390  
Santa Clara, CA 95054  
Phone: 408-986-0424  
Fax: 408-986-1442

KEMET Electronics Corporation  
Schaumburg Corporate Center  
Suite 350, 1515 Woodfield Road  
Schaumburg, IL 60173  
Phone: 847-517-1030  
Fax: 847-517-1037

KEMET Electronics Corporation  
444 Washington Street, Suite 510  
Woburn, MA 01801  
Phone: 781-933-1010  
Fax: 781-376-0929

KEMET Electronics Corporation  
8445 Freeport Parkway, Suite 320  
Irving, TX 75063  
Phone: 972-870-9530  
Fax: 972-870-9537

KEMET Electronics Canada Ltd.  
105-7145 West Credit Ave., Bldg. #2  
Mississauga, L5N 6J7, ON  
Canada  
Phone: 905-542-7930  
Fax: 905-542-7949

KEMET Electronics Canada Ltd.  
65 boul. Brunswick, Suite 214  
Dollard-des-Ormeaux, H9B-2N4 QC  
Canada  
Phone: 514-685-3773  
Fax: 514-685-4077

## **Europe/Africa Locations**

KEMET Electronics S.A.R.L.  
2, Rue Nicolas Ledoux  
Silic 254  
Rungis Cedex 94568  
France  
Phone: 33-1-4512-5320  
Fax: 33-1-4687-4087

KEMET Electronics GmbH  
Hans-StieBberger-StraBe 2A  
D85540 Haar/Munich  
Germany  
Phone: 49-89-456-4200  
Fax: 49-89-460-4117

KEMET Electronics S.A.  
1-3, Avenue de la Paix  
P.O.B. 76  
CH-1211 Geneva 20,  
Switzerland  
Phone: 41-22-715-0100  
Fax: 41-22-715-0170

KEMET Electronics Ltd.  
Waterfront House, 55/61 South St.  
Bishop's Stortford  
Hertfordshire, CM23 3AL  
United Kingdom  
Phone: 44-1279-75-7343  
Fax: 44-1279-75-7188

Aviv Electronics Ltd.  
Hayetzira St. No. 4  
P.O. Box 2433  
Ra'anana, 43100  
Israel  
Phone: 972-9-748-3232  
Fax: 972-9-741-6510

Avnet South Africa  
P.O. Box 13004  
Belmont Office Park  
14 Belmont Road  
Rodebbasch  
Capetown, South Africa 7705  
Phone: 27-(0)21 689 4141  
Fax: 27-(0)21 686 4709

Arrow Altech Distribution PTY LTD  
P.O. Box 701  
Isando, 1600  
South Africa  
Phone: 27-11-923-9699  
Fax: 27-11-923-9720

## **Asia Locations**

KEMET Electronics (Shanghai) Co., Ltd.  
2/F, No. 7 Bldg., 330 Xlya Rd.  
Waigaoqiao Free Trade Zone  
Pudong, Shanghai 200137, China  
Phone: 86-21-5046-0983  
Fax: 86-21-5046-0981

KEMET Electronics Asia Ltd.  
Rm 605, Citic Bldg.  
No. 19 Jian Guo Men Wai Da Jie  
Beijing, 100004, China  
Phone: 86-10-8526-3628  
Fax: 86-10-8526-3626

KEMET Electronics Asia Ltd.  
4A Chuan Hing Industrial Bldg.  
14 Wang Tai Road  
Kowloon Bay, Hong Kong  
Phone: 852-2305-1168  
Fax: 852-2759-0345

KEMET Electronics Marketing PTE Ltd.  
8-2-04, Sunny Point Kompleks, Jalan  
Batu Uban, 11700 Penang  
Penang, Malaysia  
Phone: 60-4-6595200  
Fax: 60-4-6595220

KEMET Electronics Marketing PTE Ltd.  
101 Thomson Road, #23-03  
United Square  
Singapore, 307591, Singapore  
Phone: 65-353-6636  
Fax: 65-353-6656

KEMET Electronics Corporation  
Taiwan Branch, 3-4F, No. 148, Section 4  
Chung-Hsaio E. Rd.  
Taipei, Taiwan ROC  
Phone: 886-2-27528585  
Fax: 886-2-27213129

WesTech Electronics & System Co. Ltd  
302/12 Central Condominium  
Ladproa Soil, Ladproa Road  
Ladyao, Jatujak  
Bangkok, Thailand 109000  
Phone: 662-939-3482-6  
Fax: 662-939-3491

Crusader Electronics Pty. Ltd.  
Unit 3, 92 Bryant Street  
Padstow, NSW 2211, Australia  
Phone: 02-9792-3922  
Fax: 02-9792-1446

Unicom International Corporation  
702 Shinhwa Bldg., Mapo-Gu  
Seoul, 121050, Korea  
Phone: 82-2712-5821  
Fax: 82-2712-5823