

OEM & Aftermarket RECREATIONAL VEHICLE AND MARINE APPLICATION GUIDE



ELIXIR
INDUSTRIES
SINCE 1948

TABLE OF CONTENTS

<p>STD. MOUNT UNIVERSAL VENTS1</p> <p>STD. MOUNT PAINTED METAL BASE VENTS.....3</p> <p>E-Z MOUNT PAINTED METAL BASE VENTS.....6</p> <p>GARNISH LISTING.....9</p> <p>EXIT AND PLUMBING VENTS.....10</p> <p>FAN & LIGHT POWER RANGE HOODS..... 11</p> <p>EXTERIOR VENT COVERS..... 13</p> <p>MONITOR PANEL RANGE HOODS.....14</p> <p>DUCTLESS & STAINLESS STEEL RANGE HOODS.16</p> <p>CONVERTERS (POWER),.....17</p> <p>STAINLESS STEEL SINKS.....18</p> <p>TABLE LEGS19</p>	<p>UTILITY DOOR SPEC SHEET.....20</p> <p>ROOF COATINGS 22</p> <p>PATCHING CEMENT..... 23</p> <p>METAL SHELVING / DOOR LOCKS.....24</p> <p>ALUMINUM / STEEL SIDING, ROOFING.....26</p> <p>ALUMINUM & STEEL SEAMLESS ROOFING... 25</p> <p>ALUMINUM TREAD PLATE.....25</p> <p>ALUMINUM BOWED ROOF RAFTERS.....25</p> <p>TIRE CARRIERS.....25</p> <p>BUTANE STRAPS.....25</p> <p>SEALANTS / PUTTY TAPES.....26</p> <p>SEALANTS / NON TRIMMABLE BUTYL.....27</p> <p>PARTS LISTING.....28-32</p>
--	--



STD. MOUNT ELIXIR UNIVERSAL VENTS



Features:

- Self centering metal base w/radius corners
- Interior garnish w/wider 1-1/4" flange and radius corners
- Available in standard, 12 volt, C.S.A. and UL approved 110 volt
- Designed to withstand excessive wind and weather

Advantages:

- Universal - fits all rough openings
- Flange covers all screw holes
- One piece metal frame, deep drawn metal base
- Covers all interior stains left by previous garnishes
- Positive-Seal weather stripping is leak resistant and water tight. Interchangeable with existing Ventline products.

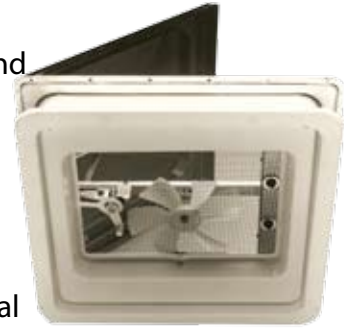

Vent Numbers listed are packed 10 per master carton without garnish.
Garnish is sold separately - see garnish listing page 7.

Galvanized Metal Base: Non Powered

Part #	Screen Frame	Lid Color
71111	Pure White	White
74111	Pure White	Smoke
73111	Pure White	Amber
71211	Colonial White	White
74211	Colonial White	Smoke
73211	Colonial White	Amber

Galvanized Metal Base: 12volt CSA Fan

Part #	Screen Frame	Lid Color
71111	Pure White	White
74111	Pure White	Smoke
73111	Pure White	Amber
71211	Colonial White	White
74211	Colonial White	Smoke
73211	Colonial White	Amber

Galvanized Metal Base: 12volt Fan

Part #	Screen Frame	Lid Color
71111	Pure White	White
74111	Pure White	Smoke
73111	Pure White	Amber
71211	Colonial White	White
74211	Colonial White	Smoke
73211	Colonial White	Amber

Galvanized Metal Base: 110volt Fan

Part #	Screen Frame	Lid Color
71111	Pure White	White
74111	Pure White	Smoke
73111	Pure White	Amber
71211	Colonial White	White
74211	Colonial White	Smoke
73211	Colonial White	Amber

STD. MOUNT ELIXIR UNIVERSAL VENTS (continued)
White Metal Base Non-Powered

Part #	Screen Frame	Lid Color
71311	Pure White	White
74311	Pure White	Smoke
73311	Pure White	Amber

White Metal Base 12V Fan

Part #	Screen Frame	Lid Color
71312	Pure White	White
74312	Pure White	Smoke
73312	Pure White	Amber

Colonial White Metal Base Non-Powered

Part #	Screen Frame	Lid Color
71411	Colonial White	White
74411	Colonial White	Smoke
73411	Colonial White	Amber

Colonial White Metal Base 12V Fan

Part #	Screen Frame	Lid Color
71412	Colonial White	White
74412	Colonial White	Smoke
73412	Colonial White	Amber

White Metal Base 12V CSA Fan

Part #	Screen Frame	Lid Color
71315	Pure White	White
74315	Pure White	Smoke
73315	Pure White	Amber

White Metal Base 110V Fan

Part #	Screen Frame	Lid Color
71316	Pure White	White
74316	Pure White	Smoke
73316	Pure White	Amber

Colonial White Metal Base 12V CSA Fan

Part #	Screen Frame	Lid Color
71415	Colonial White	White
74415	Colonial White	Smoke
73415	Colonial White	Amber

Colonial White Metal Base 110V Fan

Part #	Screen Frame	Lid Color
71416	Colonial White	White
74416	Colonial White	Smoke
73416	Colonial White	Amber

STD. MOUNT Painted Metal Base Elixir / Jensen Vents



A unique hinge system allows the lid to be attached without the need of hinge pins thus minimizing the number of parts exposed to weathering.

Features:

- Self-Centering Device eliminates installation guess work and assures perfect alignment in roof opening
- Attractive radius corners are standard
- Screen allows air through while keeping insects out
- Positive-seal weather stripping is leak resistant and water tight
- One piece seamless frame with a deep drawn painted metal base

Advantages:

- Acrylic UV Resistant translucent lid conforms to Federal Motor Vehicle Safety Standard (FMVSS) No. 205 glazing materials
- Injection molded telescoping garnish accommodates a variety of roof thicknesses
- Hand crank to open and close lid securely or available with power lift lid with remote switch available



Vent With 12 Volt Light

Vent With 12 Volt Fan and Light



Remote Switch

Retail Packaged Replacement Covers

Lid in a bag	#J7291RWH	White	#J7291RSM	Smoke	#J7291RBZ	Bronze
Lid in a bag	#J7291WH-R	White	#J7291SM-R	Smoke	#J7291BZ-R	Bronze

Vent numbers listed below are packed 10 per master carton without garnish.

Garnish sold separately - see garnish listing on page 7.

White Base Non-Powered

Part #	Screen Frame	Lid Color
V771201	Pure White	White
V774201	Pure White	Smoke
V773201	Pure White	Bronze
V771301	Colonial White	White
V774301	Colonial White	Smoke
V773301	Colonial White	Bronze

White Base W/12V Fan Only

Part #	Screen Frame	Lid Color
V771202	Pure White	White
V774202	Pure White	Smoke
V773202	Pure White	Bronze
V771302	Colonial White	White
V774302	Colonial White	Smoke
V773302	Colonial White	Bronze

White Base W/12V Fan & Light

Part #	Screen Frame	Lid Color
V771212	Pure White	White
V774212	Pure White	Smoke
V773212	Pure White	Bronze
V771312	Colonial White	White
V774312	Colonial White	Smoke
V773312	Colonial White	Bronze

Remote Switches

Part #	Screen Frame	Lid Color
JRP2133B	Fan & P/Lift	Brown
JRP2134B	Fan, Light & P/Lift	Brown

White Base W/12V CSA Fan Only

Part #	Screen Frame	Lid Color
V771205	Pure White	White
V774205	Pure White	Smoke
V773205	Pure White	Bronze
V771305	Colonial White	White
V774305	Colonial White	Smoke
V773305	Colonial White	Bronze

White Base W/12V CSA Fan & Light

Part #	Screen Frame	Lid Color
V771215	Pure White	White
V774215	Pure White	Smoke
V773215	Pure White	Bronze
V771315	Colonial White	White
V774315	Colonial White	Smoke
V773315	Colonial White	Bronze

STD. MOUNT Painted Metal Base Elixir / Jensen Vents (continued)

White Base W/12V Fan & P/Lift
Requires Remote Switch *

Part #	Screen Frame	Lid Color
V771232	Pure White	White
V774232	Pure White	Smoke
V773232	Pure White	Bronze
V771332	Colonial White	White
V774332	Colonial White	Smoke
V773332	Colonial White	Bronze

Colonial White Base W/12V Fan & Light

Part #	Screen Frame	Lid Color
V771412	Pure White	White
V774412	Pure White	Smoke
V773412	Pure White	Bronze
V771512	Colonial White	White
V774512	Colonial White	Smoke
V773512	Colonial White	Bronze

White Base W/12V Fan, Light & P/Lift
Requires Remote Switch *

Part #	Screen Frame	Lid Color
V771252	Pure White	White
V774252	Pure White	Smoke
V773252	Pure White	Bronze
V771352	Colonial White	White
V774352	Colonial White	Smoke
V773352	Colonial White	Bronze

Colonial White Base W/12V Fan & P/Lift
Requires Remote Switch *

Part #	Screen Frame	Lid Color
V771432	Pure White	White
V774432	Pure White	Smoke
V773432	Pure White	Bronze
V771532	Colonial White	White
V774532	Colonial White	Smoke
V773532	Colonial White	Bronze

Colonial White Base Non-Powered

Part #	Screen Frame	Lid Color
V771401	Pure White	White
V774401	Pure White	Smoke
V773401	Pure White	Bronze
V771501	Colonial White	White
V774501	Colonial White	Smoke
V773501	Colonial White	Bronze

Colonial White Base W/12V Fan, Light, P/
Lift, Requires Remote Switch *

Part #	Screen Frame	Lid Color
V771455	Pure White	White
V774455	Pure White	Smoke
V773455	Pure White	Bronze
V771555	Colonial White	White
V774555	Colonial White	Smoke
V773555	Colonial White	Bronze

Colonial White Base W/12V Fan Only

Part #	Screen Frame	Lid Color
V771201	Pure White	White
V774201	Pure White	Smoke
V773201	Pure White	Bronze
V771301	Colonial White	White
V774301	Colonial White	Smoke
V773301	Colonial White	Bronze

STD. MOUNT Painted Metal Base Elixir / Jensen Vents (continued)

White Base W/12V CSA Fan and P/Lift
Requires Remote Switch *

Part #	Screen Frame	Lid Color
V771235	Pure White	White
V774235	Pure White	Smoke
V773235	Pure White	Bronze
V771335	Colonial White	White
V774335	Colonial White	Smoke
V773335	Colonial White	Bronze

Colonial White Base W/12V CSA Fan &
Light

Part #	Screen Frame	Lid Color
V771415	Pure White	White
V774415	Pure White	Smoke
V773415	Pure White	Bronze
V771515	Colonial White	White
V774515	Colonial White	Smoke
V773515	Colonial White	Bronze

White Base W/12V CSA Fan, Light, P/Lift,
Requires Remote Switch *

Part #	Screen Frame	Lid Color
V771255	Pure White	White
V774255	Pure White	Smoke
V773255	Pure White	Bronze
V771355	Colonial White	White
V774355	Colonial White	Smoke
V773355	Colonial White	Bronze

Colonial White Base W/12V CSA Fan,
P/Lift, Requires Remote Switch *

Part #	Screen Frame	Lid Color
V771435	Pure White	White
V774435	Pure White	Smoke
V773435	Pure White	Bronze
V771535	Colonial White	White
V774535	Colonial White	Smoke
V773535	Colonial White	Bronze

Colonial White Base W/12V CSA Fan Only

Part #	Screen Frame	Lid Color
V771405	Pure White	White
V774405	Pure White	Smoke
V773405	Pure White	Bronze
V771505	Colonial White	White
V774505	Colonial White	Smoke
V773505	Colonial White	Bronze

Colonial White Base W/12V CSA Fan, Light,
P/Lift, Requires Remote Switch *

Part #	Screen Frame	Lid Color
V771455	Pure White	White
V774455	Pure White	Smoke
V773455	Pure White	Bronze
V771555	Colonial White	White
V774555	Colonial White	Smoke
V773555	Colonial White	Bronze

E-Z MOUNT Painted Metal Base Elixir/Jensen Vents

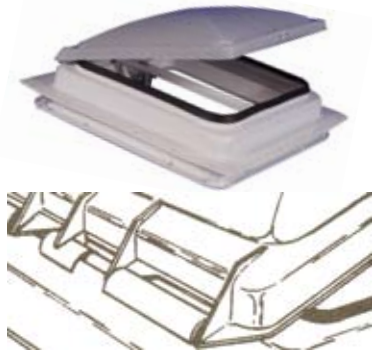

A unique hinge system allows the lid to be attached without the need of hinge pins thus minimizing the number of parts exposed to weathering.

Features:

- Self-Centering Device eliminates installation guess work and assures perfect alignment in roof opening
- Exclusive four-screw inside flange mount feature for attaching base garnish to lid mount. Saves labor on installation
- Screen allows air through while keeping insects out
- Attractive radius corners are standard
- Positive-seal weather stripping is leak resistant and water tight
- One piece seamless frame with a deep drawn painted metal base
- Unique integral hinge system on lid

Advantages:

- Acrylic UV Resistant translucent lid conforms to Federal Motor Vehicle Safety Standard (FMVSS) No. 205 glazing materials
- Injection molded telescoping garnish accommodates a variety of roof thicknesses
- Hand crank to open and close lid securely or available with power lift lid with remote switch available



The E-Z Mount™ Roof Vent significantly reduces installation cost, as there are only four internal fasteners to be used. No external screws are used which eliminates the possibility of water seeping past fasteners

E-Z Compression Clamp Mount



Four corner interior screws sandwich top metal base and inside garnish together to make a water tight seal.
(see page XXX for screw applications)



Remote Switch

Retail Packaged Replacement Covers

Lid in a bag	#J7291RWH	White	#J7291RSM	Smoke	#J7291RBZ	Bronze
Lid in a bag	#J7291WH-R	White	#J7291SM-R	Smoke	#J7291BZ-R	Bronze

White Base Non-Powered

Part #	Screen Frame	Lid Color
V971201	Pure White	White
V974201	Pure White	Smoke
V973201	Pure White	Bronze
V971301	Colonial White	White
V974301	Colonial White	Smoke
V973301	Colonial White	Bronze

White Base W/12V Fan Only

Part #	Screen Frame	Lid Color
V971202	Pure White	White
V974202	Pure White	Smoke
V973202	Pure White	Bronze
V971302	Colonial White	White
V974302	Colonial White	Smoke
V973302	Colonial White	Bronze

White Base W/12V Fan & Light

Part #	Screen Frame	Lid Color
V971212	Pure White	White
V974212	Pure White	Smoke
V973212	Pure White	Bronze
V971312	Colonial White	White
V974312	Colonial White	Smoke
V973312	Colonial White	Bronze

Remote Switches

Part #	Screen Frame	Lid Color
JRP2133B	Fan & P/Lift	Brown
JRP2134B	Fan, Light & P/Lift	Brown

White Base W/12V CSA Fan Only

Part #	Screen Frame	Lid Color
V971205	Pure White	White
V974205	Pure White	Smoke
V973205	Pure White	Bronze
V971305	Colonial White	White
V974305	Colonial White	Smoke
V973305	Colonial White	Bronze

White Base W/12V CSA Fan & Light

Part #	Screen Frame	Lid Color
V971215	Pure White	White
V974215	Pure White	Smoke
V973215	Pure White	Bronze
V971315	Colonial White	White
V974315	Colonial White	Smoke
V973315	Colonial White	Bronze

Vent Numbers listed are without garnish. Garnish is sold separately - See garnish listings.

White Base W/12V Fan, P/lift.
Requires Remote Switch

Part #	Screen Frame	Lid Color
V971232	Pure White	White
V974232	Pure White	Smoke
V973232	Pure White	Bronze
V971332	Colonial White	White
V974332	Colonial White	Smoke
V973332	Colonial White	Bronze

White Base W/12V Fan, P/lift and Light
Requires Remote Switch

Part #	Screen Frame	Lid Color
V971252	Pure White	White
V974252	Pure White	Smoke
V973252	Pure White	Bronze
V971352	Colonial White	White
V974352	Colonial White	Smoke
V973352	Colonial White	Bronze

Colonial White Base Non-Powered

Part #	Screen Frame	Lid Color
V971401	Pure White	White
V974401	Pure White	Smoke
V973401	Pure White	Bronze
V971501	Colonial White	White
V974501	Colonial White	Smoke
V973501	Colonial White	Bronze

Colonial White Base W/12V Fan Only

Part #	Screen Frame	Lid Color
V971402	Pure White	White
V974402	Pure White	Smoke
V973402	Pure White	Bronze
V971502	Colonial White	White
V974502	Colonial White	Smoke
V973502	Colonial White	Bronze

Colonial White Base W/12V Fan and Light

Part #	Screen Frame	Lid Color
V971412	Pure White	White
V974412	Pure White	Smoke
V973412	Pure White	Bronze
V971512	Colonial White	White
V974512	Colonial White	Smoke
V973512	Colonial White	Bronze

Colonial White Base W/12V fan, P/Lift
Requires Remote Switch

Part #	Screen Frame	Lid Color
V971432	Pure White	White
V974432	Pure White	Smoke
V973432	Pure White	Bronze
V971532	Colonial White	White
V974532	Colonial White	Smoke
V973532	Colonial White	Bronze

Colonial White Base W/12V fan, P/Lift,
Light. Requires Remote Switch

Part #	Screen Frame	Lid Color
V971452	Pure White	White
V974452	Pure White	Smoke
V973452	Pure White	Bronze
V971552	Colonial White	White
V974552	Colonial White	Smoke
V973552	Colonial White	Bronze

Vent Numbers listed are without garnish. Garnish is sold separately - See garnish listings.

White Base W/12V CSA Fan, P/lift.
Requires Remote Switch

Part #	Screen Frame	Lid Color
V971235	Pure White	White
V974235	Pure White	Smoke
V973235	Pure White	Bronze
V971335	Colonial White	White
V974335	Colonial White	Smoke
V973335	Colonial White	Bronze

Colonial White Base W/12V CSA Fan &
Light

Part #	Screen Frame	Lid Color
V971415	Pure White	White
V974415	Pure White	Smoke
V973415	Pure White	Bronze
V971515	Colonial White	White
V974515	Colonial White	Smoke
V973515	Colonial White	Bronze

White Base W/12V Fan, P/lift.
Requires Remote Switch

Part #	Screen Frame	Lid Color
V971255	Pure White	White
V974255	Pure White	Smoke
V973255	Pure White	Bronze
V971355	Colonial White	White
V974355	Colonial White	Smoke
V973355	Colonial White	Bronze

Colonial White Base W/12V CSA Fan,
P/Lift - Requires Remote Switch

Part #	Screen Frame	Lid Color
V971435	Pure White	White
V974435	Pure White	Smoke
V973435	Pure White	Bronze
V971535	Colonial White	White
V974535	Colonial White	Smoke
V973535	Colonial White	Bronze

Colonial White Base W/12V CSA Fan Only

Part #	Screen Frame	Lid Color
V971405	Pure White	White
V974405	Pure White	Smoke
V973405	Pure White	Bronze
V971505	Colonial White	White
V974505	Colonial White	Smoke
V973505	Colonial White	Bronze

Colonial White Base W/12V CSA Fan,
P/Lift, Light - Requires Remote Switch

Part #	Screen Frame	Lid Color
V971455	Pure White	White
V974455	Pure White	Smoke
V973455	Pure White	Bronze
V971555	Colonial White	White
V974555	Colonial White	Smoke
V973555	Colonial White	Bronze

For Remote Switches, See Page 6

Garnish Listings

STD. Mount Garnish With 1-1/2" Wide Mounting Flange

Part #	Description	Color	Pack
JRP120	1-3/8" Vertical Leg	White	70

STD. Mount Garnish With 1-1/4" Wide Mounting Flange

Part #	Description	Color	Pack
* 90090	1-1/8" Vertical Leg	White	56
* 90095	1-1/8" Vertical Leg	Colonial White	56
90091	2-1/8" Vertical Leg	White	48
90096	2-1/8" Vertical Leg	Colonial White	48
90092	3" Vertical Leg	White	32
90097	3" Vertical Leg	Colonial White	32
90094	4" Vertical Leg	White	20
90098	4" Vertical Leg	Colonial White	20
90104	5" Vertical Leg	White	14
90103	5" Vertical Leg	Colonial White	14
90144	5-1/4" Vertical Leg	White	14
90145	5-1/4" Vertical Leg	Colonial White	14
90146	6" Vertical Leg	White	10
90147	6" Vertical Leg	Colonial White	10
90149	7" Vertical Leg	White	8
90148	7" Vertical Leg	Colonial White	8
90102	8" Vertical Leg	White	8
90143	8" Vertical Leg	Colonial White	8

STD. Mount Garnish With 1" Wide Mounting Flange

Part #	Description	Color	Pack
JRP1118	1-1/2" Vertical Leg	White	70
JRP1119	1-1/2" Vertical Leg	Colonial White	70
JRP1120	3" Vertical Leg	White	40
JRP1121	3" Vertical Leg	Colonial White	40
JRP1122	4-1/2" Vertical Leg	White	26
JRP1123	4-1/2" Vertical Leg	Colonial White	26

STD. Mount Garnish With 1" Wide Mounting Flange

(garnish for E-Z mount/compression clamp style vents only)

Part #	Description	Color	Pack
JRP1118	1-1/2" Vertical Leg	White	70
JRP1119	1-1/2" Vertical Leg	Colonial White	70
JRP1120	3" Vertical Leg	White	40
JRP1121	3" Vertical Leg	Colonial White	40
JRP1122	4-1/2" Vertical Leg	White	26
JRP1123	4-1/2" Vertical Leg	Colonial White	26

* Will not fit Jensen Vents

Escape Hatches, Exit Vents, Mini Roof Vents, Plumbing Vents

Escape Hatch / Exit Vent



Features:

- Fresh air ventilation: A turn of the crank provides a large vent area. Lets air through, keeps insects out
- Includes opaque white plastic lid
- Sturdy frame installs easily and is made of heavy aluminum extrusion to assure secure mounting
- Dependable operation featuring leak-resistant lid and weather-tight frame
- White garnish included

Advantages:

- Instant exit. Screen opens quickly to assure fast exit through opening
- Largest selection: 13x20 to 26x26
- A strong fine mesh screen

Escape Hatch / Exit Vents

Part #	Description	CTN. QTY.
31121	13x20 White Lid, Plastic frame w/2-3/8" Plastic Garnish included	4
58621	15x22 White Lid, Metal frame, w/4 pc., 2" White Metal Garnish	4
48621	17x24 White Lid, Metal frame, w/4 pc., 2" White Metal Garnish (RVIA)	4
66621	22x22 White Lid, Metal Frame, w/4pc., 2" White Metal Garnish	4
68631	26x26 White Lid, Metal Frame, w/4pc., 2" White Metal Garnish (RVIA)	4

For Parts, Refer to Parts List on Page XX

Mini Roof Vents

This convenient 9"x9" lightweight vent is ideal for providing fresh air in small places such as bathrooms, passageways, galleys, etc. This mini vent is weather-proof due to the quality high-impact plastic used in its construction. Available in white and colonial white with 7/8" plastic garnish



Part #	Description	CTN. QTY.
17511G-1	Colonial White opaque roof vent, Ind. boxed	16
18511G-1	White opaque roof vent, Ind. boxed	16

For Parts, Refer to Parts List on Page XX

Plumbing Vent

Made of tough exterior plastic with a weather resistant finish. They feature a unique cap which can be locked on or removed with a twist of the wrist without the need of tools. These vents are made to fit pipes up to 2" in diameter with a 2-1/2" projection above the roof.



Part #	Description	CTN. QTY.
10001	White Plumbing Vent	100
10002	Colonial White Plumbing Vent	100
10003	Metal Plumbing Vent	100

Fan & Light Power Exhaust Range Hoods



Slope Nose/Designed to fit 12" to 18" Cabinet Depths

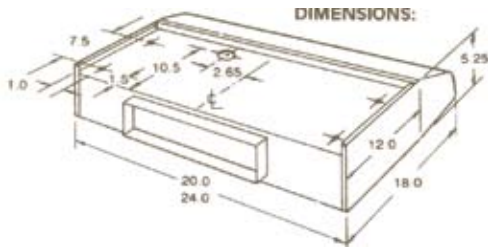

FEATURES:

- Listed for use in U.S.A. and Canada (CSA)
- Single switch gauging of all systems
- Totally enclosed light
- Washable aluminum filter

- Total current draw: 2.5 amps (12 VDC)
- Current draw may vary on CSA models
- Air exhaust volume: 138 CFM

- Standard finish: backed enamel in almond, white, and black
- Optional exterior vent covers (Refer to page 10)

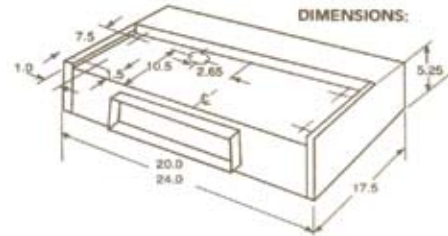

Slope Nose Models For J116

Part #	Width	Color
R0421500	20"	Almond
R0422500	20"	White
R0423500	20"	Black
R0424500	20"	Stainless Steel
R0425500	20"	Aluminum
R0621500	22"	Almond
R0622500	22"	White
R0623500	22"	Black
R0624500	22"	Stainless Steel
R0625500	22"	Aluminum
R0821500	24"	Almond
R0822500	24"	White
R0823500	24"	Black
R0824500	24"	Stainless Steel
R0825500	24"	Aluminum

Slope Nose Models For J121

Part #	Width	Color
R0421400	20"	Almond
R0422400	20"	White
R0423400	20"	Black
R0424400	20"	Stainless Steel
R0425400	20"	Aluminum
R0621400	22"	Almond
R0622400	22"	White
R0623400	22"	Black
R0624400	22"	Stainless Steel
R0625400	22"	Aluminum
R0821400	24"	Almond
R0822400	24"	White
R0823400	24"	Black
R0824400	24"	Stainless Steel
R0825400	24"	Aluminum

Listings Continued on Next Page

Fan & Light Power Exhaust Range Hoods

Slope Nose Models For J121

Part #	Width	Color
R0421400	20"	Almond
R0422400	20"	White
R0423400	20"	Black
R0424400	20"	Stainless Steel
R0425500	20"	Aluminum
R0621400	22"	Almond
R0622400	22"	White
R0623400	22"	Black
R0624400	22"	Stainless Steel
R0625400	22"	Aluminum
R0821400	24"	Almond
R0822400	24"	White
R0823400	24"	Black
R0824400	24"	Stainless Steel
R0825400	24"	Aluminum

Flat Nose Models For J116

Part #	Width	Color
R0461500	20"	Almond
R0462500	20"	White
R0463500	20"	Black
R0465500	20"	Aluminum
R0661500	22"	Almond
R0662500	22"	White
R0663500	22"	Black
R0665500	22"	Aluminum
R0861500	24"	Almond
R0862500	24"	White
R0863500	24"	Black
R0865500	24"	Aluminum

Flat Nose Models For J121

Part #	Width	Color
R0461400	20"	Almond
R0462400	20"	White
R0463400	20"	Black
R0465400	20"	Aluminum
R0661400	22"	Almond
R0662400	22"	White
R0663400	22"	Black
R0665400	22"	Aluminum
R0861400	24"	Almond
R0862400	24"	White
R0863400	24"	Black
R0865500	24"	Aluminum

Flat Nose CSA Models For J116

Part #	Width	Color
R0561500	20"	Almond
R0562500	20"	White
R0563500	20"	Black
R0761500	22"	Almond
R0762500	22"	White
R0763500	22"	Black
R0961500	24"	Almond
R0962500	24"	White
R0963500	24"	Black

Flat Nose CSA Models For J121

Part #	Width	Color
R0561400	20"	Almond
R0562400	20"	White
R0563400	20"	Black
R0761400	22"	Almond
R0762400	22"	White
R0763400	22"	Black
R0961400	24"	Almond
R0962400	24"	White
R0963400	24"	Black

Optional Exterior Vent Covers

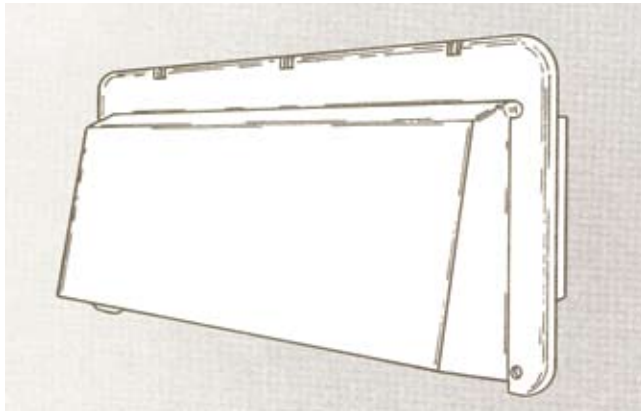

An Innovative Exhaust System

This ELIXIR exhaust system is available in two standard colors: Model J116 OW Outside Exhaust Assembly in off white (almond), and Model J116 WH in white. Other colors available upon request.

This unit consists of an attractive exterior vent cover designed to keep rain and dust out of your vehicle with an outside manual release damper.

Once the outside manual release damper is unsecured, the damper automatically opens when the range hood fan is activated to allow cooking odors and smoke to be exhausted. The damper automatically closes to prohibit insects and dust from entering when the range hood is not in operation. The manual release damper must be secured before traveling.

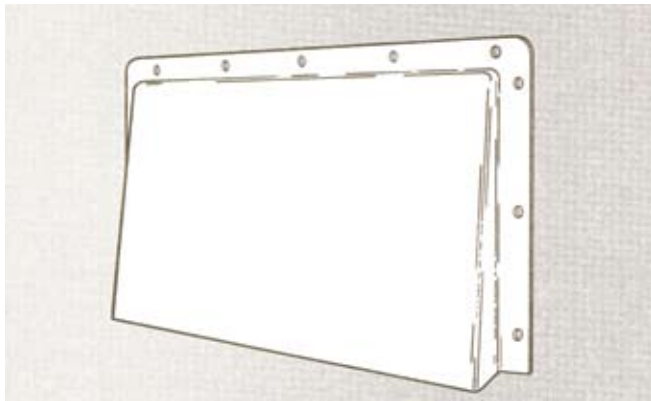
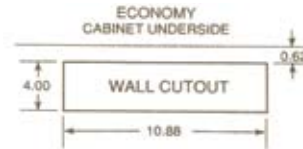
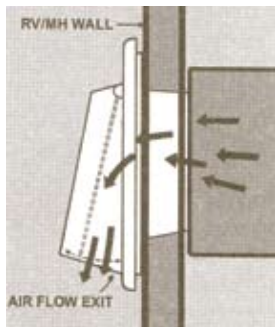

An Innovative Exhaust System

The ELIXIR exhaust system is available in two colors: Model J121 OW Outside Exhaust Assembly in off white (almond), and Model J121 WH in white.

Unit consists of an attractive exterior vent cover designed to keep rain and dust out of your vehicle, while allowing the range hood exhaust to exit past the internal automatic damper.

The Automatic Gravity Damper is made of heavy duty galvanized metal with mounting holes. A gravity operated damper automatically opens when the range hood fan is activated to allow cooking odors and smoke to be exhausted, and automatically closes to prohibit insects and dust from entering when the range hood is not in operation.

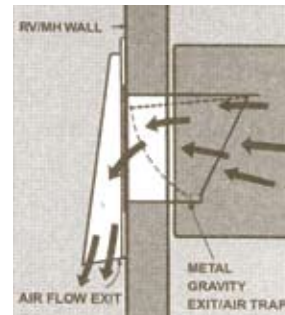
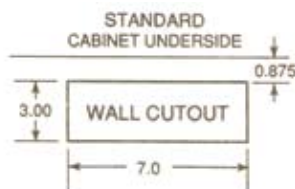

Montior Panel Range Hoods

FEATURES:

- | | | |
|---|---|--|
| <ul style="list-style-type: none"> • Listed for use in U.S.A. and Canada (CSA) • Single switch gauging of all systems • Totally enclosed light | <ul style="list-style-type: none"> • Total current draw: 2.5 amps (12 VDC) • Current draw may vary on CSA models • Air exhaust volume: 138 CFM • Washable Aluminum Filter | <ul style="list-style-type: none"> • Standard finish: backed enamel in almond, white, and black • Optional exterior vent covers (Refer to page 10) |
|---|---|--|

MONITOR PANELS



COMMON FEATURES

- | | |
|--|---|
| <ul style="list-style-type: none"> • Simplified Uni-Wire system requires only three sensors per tank, plus common wire • Function levels display simultaneously at the touch of a single switch • Fluid levles gauged in 1/3 increments • Concealed, moulded fasteners • Convenient lift-out panel removal for easy servicing • Mar-resistant face - polycarbonate plastic • European style rocker switches • All graphics screened for lifetime readability | <ul style="list-style-type: none"> • All solid state electronics unsing advanced integrated analogue circuit design • Custom plug-in-type wire harness to simplify installation • L.E.D. readouts in meaningful green-yellow-red • Designed to conform to ANSI A119.2 and NFPA 501C |
|--|---|
- Standard Functions**
- | | |
|---|--|
| <ul style="list-style-type: none"> • Hood, fan, light • Holding tanks (black and grey) • Water pump with indicator light • Battery condition with indicator light | <ul style="list-style-type: none"> • Fresh water tank • LP Gas |
|---|--|

CUSTOM VERSION MONITOR PANELS MAY INCLUDE THE ADDITIONAL FUNCTIONS:

- | | |
|---|---|
| <ul style="list-style-type: none"> • Generator start/stop switch with indicator • Generator hour meter • Water heater ignitor switch | <ul style="list-style-type: none"> • L.C.D. clock • Two speed fan • Custom logos sold separately |
|---|---|

Monitor Panel (M.P.) Range Hoods - U.S.A. 12 Volt

J116 Slope Nose / Standard Functions MP

Part #	Width	Color	L.P.*
R0441504	20"	Almond	No
R0442504	20"	White	No
R0443604	20"	Black	No
R0441505	20"	Almond	Yes
R0442505	20"	White	Yes
R0443605	20"	Black	Yes

J116 Flat Nose / Standard Functions MP

Part #	Width	Color	L.P.*
R0471504	20"	Almond	No
R0472504	20"	White	No
R0473604	20"	Black	No
R0471505	20"	Almond	Yes
R0472505	20"	White	Yes
R0473605	20"	Black	Yes

J121 Slope Nose / Standard Functions MP

Part #	Width	Color	L.P.*
R0441404	20"	Almond	No
R0442404	20"	White	No
R0443404	20"	Black	No
R0441405	20"	Almond	Yes
R0442405	20"	White	Yes
R0443045	20"	Black	Yes

J121 Flat Nose / Standard Functions MP

Part #	Width	Color	L.P.*
R0471404	20"	Almond	No
R0472404	20"	White	No
R0473404	20"	Black	No
R0471405	20"	Almond	Yes
R0472405	20"	White	Yes
R0473045	20"	Black	Yes

Monitor Panel (M.P.) Range Hoods - U.S.A. 12 Volt - CSA

J116 Slope Nose / Standard Functions MP

Part #	Width	Color	L.P.*
R0541504	20"	Almond	No
R0542504	20"	White	No
R0543604	20"	Black	No
R0541505	20"	Almond	Yes
R0542505	20"	White	Yes
R0543605	20"	Black	Yes

J116 Flat Nose / Standard Functions MP

Part #	Width	Color	L.P.*
R0571504	20"	Almond	No
R0572504	20"	White	No
R0573604	20"	Black	No
R0571505	20"	Almond	Yes
R0572505	20"	White	Yes
R0573605	20"	Black	Yes

J121 Slope Nose / Standard Functions MP

Part #	Width	Color	L.P.*
R0541404	20"	Almond	No
R0542404	20"	White	No
R0543404	20"	Black	No
R0541405	20"	Almond	Yes
R0542405	20"	White	Yes
R0543405	20"	Black	Yes

J121 Flat Nose / Standard Functions MP

Part #	Width	Color	L.P.*
R0571404	20"	Almond	No
R0572404	20"	White	No
R0573404	20"	Black	No
R0571405	20"	Almond	Yes
R0572405	20"	White	Yes
R0573405	20"	Black	Yes

Ductless Range Hoods / Stainless Steel Range Hood

Duct Free Installation



Ductless Range Hood Features:

- Listed for use in U.S.A. and Canada
- Designed to conform to ANSI A119.2 and NFPA 501C
- Replacable aluminum screen with charcoal filter
- No exterior ducting required
- Monitor and Non-monitor versions available; single switch gauging of all systems
- Totally enclosed light



Stainless Steel Range Hood:

- Constructed with 22 gauge stainless steel.
- 20" wide x 18" deep

Ductless Air Flow

- Air drawn through Venturi and filtered
- Aluminum filter element eliminates airborne grease
- Charcoal element reduces cooking odors
- Clean exhaust air is directed upward, away from stove hood
- Roof ventilation must be installed within 5' to meet code requirements



Charcoal Filter System

- Hood Fan/light
- Fresh Water Tank
- Holding Tanks (black and gray)
- Water Pump with indicator light
- Battery condition with indicator light

Slope Nose / Standard Functions MP Ductless 12 Volt USA

Part #	Width	Color	L.P.*
R0451804	20"	Almond	No
R0452804	20"	White	No
R0453804	20"	Black	No
R0455804	20"	Aluminum	No
R0451805	20"	Almond	Yes
R0452805	20"	White	Yes
R0453805	20"	Black	Yes
R0455805	20"	Aluminum	Yes
R0651804	22"	Almond	?
R0652804	22"	White	
R0653804	22"	Black	
R0655804	22"	Aluminum	

Slope Nose Fan and Light (only) Ductless / 12 Volt USA

Part #	Width	Color
R0451803	20"	Almond
R0452803	20"	White
R0453803	20"	Black

Slope Nose / Standard Functions MP Ductless 12 Volt CSA

Part #	Width	Color	L.P.*
R0551804	20"	Almond	No
R0552804	20"	White	No
R0553804	20"	Black	No
R0555804	20"	Aluminum	No
R0551805	20"	Almond	Yes
R0552805	20"	White	Yes
R0553805	20"	Black	Yes
R0555804	20"	Aluminum	Yes
R0751805	22"	Almond	?
R0752805	22"	White	
R0753805	22"	Black	
R0755805	22"	Aluminum	

Slope Nose Fan and Light (only) Ductless / 12 Volt CSA

Part #	Width	Color
R0551803	20"	Almond
R0552803	20"	White
R0553803	20"	Black

For Parts, Refer to Parts Listing on Page 27-31

Solid State Converters

SOLID STATE ELECTRONIC CONVERTERS

- Automatic Shut Off: Will not overcharge
- Stable DC Output: In an overload situation, eliminates “flicker” and saves life on appliances by maintaining a constant DC output to appliances instead of alternating DC power supply between the converter and the battery
- Audible Buzzer: Two distinct tones to clearly indicate overload or short circuit
- Constant Battery Charging: This unique feature is achieved with separate supply lines between DC output and battery charge. In a no-load situation, full unity amperage is directed to battery recharge. Under a load situation, amperage directed to battery recharge is reduced according to the load level, but always maintains a constant rate of at least 1 amp to extend battery life
- Reverse Polarity Protection: If battery cables are connected incorrectly, a fuse in the converter will protect the circuit board
- Reduced Battery Leakage: Delivers 8 mili-amp leakage versus 20 mili-amp leakage in competitive products
- Quiet Operation: Fan bearing and thermal control unit provide extremely quiet operation

Solid State Electronic Cabinet Mount



Part #	12V Output	W/Charger	Dimensions			LBS.	CTN.
			W	H	D		
ELX 12	12 Amps	12 Amps	12 1/4"	5 3/4"	4 1/4"	5 1/2	6
ELX 20	20 Amps	20 Amps	12 1/4"	5 3/4"	4 1/4"	6	6
ELX 25	25 Amps	25 Amps	12 1/4"	5 3/4"	4 1/4"	6 1/2	6
ELX 30	30 Amps	30 Amps	12 1/4"	5 3/4"	4 1/4"	6 1/2	6

Solid State Electronic Cabinet Mount



Part #	12V Output	W/Charger	Dimensions			LBS.	CTN.
			W	H	D		
ELX 35	35 Amps	35 Amps	14"	11 3/4"	7"	20	6
ELX 45	45 Amps	45 Amps	14"	11 3/4"	7"	20	2
ELX 60	60 Amps	60 Amps	14"	11 3/4"	7"	20	2

Solid State Electronic Deck Mount



Part #	12V Output	W/Charger	Dimensions			LBS.	CTN.
			W	H	D		
DM4000	40 Amps	40 Amps	5 1/2"	4 5/8"	10"	10	1
DM6000	60 Amps	60 Amps	5 1/2"	4 5/8"	10"	10	1
DM8000	80 Amps	80 Amps	5 1/2"	4 5/8"	10"	10	1

Stainless Steel Sinks



- 13" W x 10" L Oval
- Self-Rimming
 - Single Oval Bowl
 - 300 Series Nickel-Chrome 22 gauge Stainless Steel
 - Packaged 40 units / pallet



- SSS- 1315-5
13"W x 15"L x 5"D
- Self-Rimming
 - Single Bowl
 - 300 Series Nickel-Chrome 22 gauge Stainless Steel
 - Packaged 40 unit / pallet



- SSS-15152-5
13"W x 15"L x 5"D
- Self-Rimming
 - 2-Hole Single Bowl
 - 300 Series Nickel-Chrome 22 gauge Stainless Steel
 - Packaged 40 units / pallet



- SSD-2315-5
23"W x 15.75" L x 5" D
- Self-Rimming
 - Double Bowl
 - 300 Series Nickel-Chrome 22 gauge Stainless Steel
 - Packaged 40 unit / pallet



- SSD-2515-5
25"W x 15"L x 5"D
- Self-Rimming
 - Double Bowl
 - 300 Series Nickel-Chrome 22 gauge Stainless Steel
 - Packaged 40 unit / pallet



- SSD-25173-5
25"W x 17"L x 5"D
- Self-Rimming
 - 3-Hole Double Bowl
 - 300 Series Nickel-Chrome 22 gauge Stainless Steel
 - Packaged 40 unit / pallet



- SSD- 2716-6
27"W x 16"L x 6"D
- Self-Rimming
 - Double Bowl
 - 300 Series Nickel-Chrome 20 gauge Stainless Steel
 - Packaged 40 unit / pallet



- SSD-33193-6 / SSD-33194-6
33"W x 19"L x 6"D
- Self-Rimming
 - 3 or 4 Hole Double Bowl
 - 300 Series Nickel-Chrome 20 gauge Stainless Steel
 - Packaged 40 unit / pallet
- SSD-33193-7 / SSD-33194-7
33"W x 19"L x 6"D
- Self-Rimming
 - 3 or 4 Hole Double Bowl
 - 300 Series Nickel-Chrome 20 gauge Stainless Steel
 - Packaged 40 unit / pallet

All sinks are CSA & IAPMO Certified

Table Legs / Door Chains



ELX-809



ELX-FL275
ELX-FL295



ELX-170L
ELX-255L
ELX-275L
ELX-295L
ELX-315L
*Special
Sizes
Available on
Request



ELX-SB



ELX-RB



Cargo Door Chain

Part Number / Description	Size
ELX-809 / Adjustable Table Leg	Adjust to 25", 26", 27", 28", or 29"
ELX-FL275 / Folding Table Leg	27 1/2"
ELX-FL295 / Folding Table Leg	29 1/2"
ELX-170L / Chrome Plated Steel Table Leg	17"
ELX-225L / Chrome Plated Steel Table Leg	25 1/2"
ELX-275L / Chrome Plated Steel Table Leg	27 1/2"
ELX-295L / Chrome Plated Steel Table Leg	29 1/2"
ELX-315L / Chrome Plated Steel Table Leg	31 1/2"
ELX-RB / Recessed Table Leg Base	N/A
ELX-SB / Standard Table Leg Base	N/A
Cargo Door Chain	

Square Utility Door - Spec Sheet

Vent Division - Divresified Products Division
Administration Offices - 2040 Industrial Parkway - Elkhart IN 46516 - 574/294-5685 or 800/443-5473

Fax (order entry / Customer Service) 574//295-8550

Square Utility Door

Indicate Rough Opening - 1/4" H: _____ W: _____

Note: Enter Height minus 1/4" and width minus 1/4". Example: Exact opening is 12" x 12" enter 11 3/4" x 11 3/4"

Insulation: Insulated-Styrofoam (SC4350) _____ or Non-Insulated (SC4300) _____

Exterior Skin: {
Type Fiberglass _____ Metal _____
Texture Smooth (sm) _____ Stucco (s) _____
Color White (8016 reg) _____ Colonial White (479) ____ Other (specify Code) ____
 (If fiberglass)
Color White (5000) _____ Colonial White (5100) ____ Other (specify Code) ____
 (If metal)

Space above provided for Lock location etc.

Inner Panel (insulated doors only) {
 White ABS Plastic _____
 Smooth Mill Metal (SMM) _____ Stucco Mill Metal (SM) _____
 Smooth White Metal (SMW) _____ Stucco White Metal (SW) _____

Frame {
Type Standard w/screw cover channel only X
Color Mill _____ White (PWF) _____ Other (specify) _____

Hinge Location
 (Viewed from outside) Top (TH) _____ Bottom (BH) _____ Left (LH) _____ Right (RH) _____ Other (specify) _____

NOTE: Hinge type is extruded if a piano hinge is needed, please order a notched door or radius door.

Screw Cover White (WSC) _____ Colonial White (CWSC) _____ Black (BKSC) _____

Lock Type Key Lock (CH751) Quantity (K) _____ Thumb Lock Quantity (T) _____ Finger Pull Quantity (FP) _____
 Key Location _____ Thumb Location _____ Finger Pull Location _____

Louvers (metal core only)
 Number of rows across _____
 Number of rows down _____

Example:
 2 Rows Across
 4 Rows Down
 (2R-4LVRS)

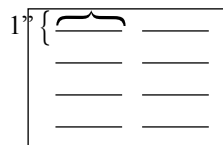

Louvers are 5" in width with 1" space between in height

NOTE: Specify other locations. Example: Louvers Centered, Louvers 3" from top, Louvers at Top and Bottom, etc.

Mesh {
 Horizontal (HM) _____
 At top _____
 Inches from top _____
 At bottom _____
 Inches from Bottom _____
 Centered _____
 Vertical (VM) _____
 At left _____
 Inches from left _____
 At right _____
 Inches from Right _____
 Centered _____

Please Provide Sketch for Louvers or mesh

Space provided for sketch of mesh or louver locations.

Baffle Yes ___ or No ___ Hinged Baffle Yes ___ or No ___ (note: Baffle can only be made from metal)

Other Options: Brace Bars Quantity (BB) ___ Chains (bottom hinge door) Quantity ___ Plywood Insulation Quantity ___
 NOTE: Brace bars are added: 1 for R.O. that = 36" but < 48" and 2 or more for R.O. that = 48" or > .
 you may choose NO BRACE BAR by specifying NO in space provided for quantity.

Other Information: _____

Radius Utility Door - Spec Sheet

Vent Division - Divresified Products Division
Administration Offices - 2040 Industrial Parkway - Elkhart IN 46516 - 574/294-5685 or 800/443-5473

Fax (order entry / Customer Service) 574//295-8550

Radius Utility Door

Indicate Rough Opening - 1/4" H: _____ W: _____

Note: Enter Height minus 1/4" and width minus 1/4". Example: Exact opening is 12" x 12" enter 11 3/4" x 11 3/4"

Insulation:

Exterior Skin:

Insulated-Styrofoam (SC450) _____ or Non-Insulated (SC400) _____

{	<u>Type</u>	Fiberglass _____	Metal _____
	<u>Texture</u>	Smooth (sm) _____	Stucco (s) _____
	<u>Color</u>	White (8016 reg) _____	Colonial White (479) _____ Other (specify Code) _____
	(If fiberglass)		
	<u>Color</u>	White (5000) _____	Colonial White (5100) _____ Other (specify Code) _____
	(If metal)		

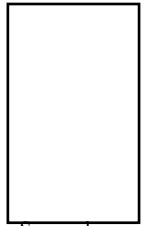

Space above provided for Lock location etc.

Inner Panel (insulated doors only)

{	White ABS Plastic _____	
	Smooth Mill Metal (SMM) _____	Stucco Mill Metal (SM) _____
	Smooth White Metal (SMW) _____	Stucco White Metal (SW) _____

Frame

{	<u>Type</u> Standard w/screw cover channel _____	}	OR	{	Inner Mount - No Exterior Screw Holes (-IM) _____	}	
	<u>Color</u> Mill _____ White (PWF) _____				Narrow (PWF-IM) _____ Wide (WPWF-IM) _____		
				Other _____			

Note: we do not supply screw cover inserts for radius doors.

Hinge Location

(Viewed from outside) Top (TH) _____ Bottom (BH) _____ Left (LH) _____ Right (RH) _____ Other (specify) _____

NOTE: Hinge type is extruded if a piano hinge is needed, please order a notched door or radius door.

Screw Cover

White (WSC) _____ Colonial White (CWSC) _____ Black (BKSC) _____

Lock Type

Key Lock (CH751) Quantity (K) _____ Thumb Lock Quantity (T) _____ Finger Pull Quantity (FP) _____
Key Location _____ Thumb Location 5" _____ Finger Pull Location _____

Louvers (metal core only)

Number of rows across _____
Number of rows down _____

Example:
2 Rows Across
4 Rows Down
(2R-4LVRS)

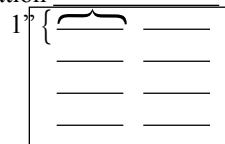

Louvers are 5" in width with 1" space between in height

NOTE: Specify other locations. Example: Louvers Centered, Louvers 3" from top, Louvers at Top and Bottom, etc.

Mesh

{	Horizontal (HM) _____	}	{	Vertical (VM) _____	}
	At top _____			At left _____	
	Inches from top _____			Inches from left _____	
	At bottom _____			At right _____	
	Inches from Bottom _____			Inches from Right _____	
Centered _____	Centered _____				

Please Provide Sketch for Louvers or mesh



Baffle

Yes ___ or No ___ Hinged Baffle Yes ___ or No ___ (note: Baffle can only be made from metal)

Other Options:

Brace Bars Quantity (BB) ___ Chains (bottom hinge door) Quantity ___ Plywood Insulation Quantity ___

NOTE: Brace bars are added: 1 for R.O. that = 36" but < 48" and 2 or more for R.O. that = 48" or >. you may choose NO BRACE BAR by specifying NO in space provided for quantity.

Other Information: _____

Plas-T-Cote Roof Coatings

Alkyd Fibered Roof Coating

Coating for metal and fiberglass roofs

(not suitable for rubber roofs or homes with asphalt roofing)

Plas-T-Cote is a non-asphalt, high quality chemically engineered roof coating that contains long fibers, pigments and non-drying resins. It is a thick, white fibered or aluminum fibered colored coating with an amazing ability to conform to, and protect against all weather conditions. It has excellent acoustical and insulating qualities. Plas-T-Cote alkyd stays flexible, contracts and expands with roof seams.

Part#	Description	Color	Carton Qty	Weight/Case
45032	1 Qt. Alkyd	White Fibered	12	32 lbs
45128	1 Gal. Alkyd	White Fibered	4	42 lbs
45448	3 1/2 Gal Alkyd	White Fibered	—	40 lbs
45640	5 Gal. Alkyd	White Fibered	—	55 lbs
43032	1 Qt. Alkyd	Aluminum Fibered	12	32 lbs
43128	1 Gal. Alkyd	Aluminum Fibered	4	42 lbs
43448	3 1/2 Gal Alkyd	Aluminum Fibered	—	50 lbs
43640	5 Gal. Alkyd	Aluminum Fibered	—	55 lbs

Formulated
for
Recreational
Vehicles



Fibered Aluminum Roof Coating

(not suitable for rubber roofs)

Fibered aluminum coating seals and protects roofs from 80% of ultra-violet sun rays. It reduces inside room temperature up to 15%. Formulated to protect metal and aluminum roofs. One gallon covers 80-100 square feet. Meets ANSI/ASTM No. D-2820 Type II.

Part#	Description	Color	Carton Qty	Weight/Case
48128	1 Gal.	Aluminum	4	33 lbs
48640	5 Gal.	Aluminum	—	42 lbs

For
Recreational
Vehicles



Plas-T-Cote Elastomeric 100% Acrylic Roof Coating

Use over asphalt roof shingles, galvanized steel, concrete, wood, polyurethane foam and bitumas built up roofs (BUR's). Used as a reflective and protective coating. Has outstanding exterior durability and UV resistance. Expands and contracts with the roof. Resists cracking and withstands impact. Non-polluting and non-toxic.

Part#	Description	Color	Carton Qty	Weight/Case
47032	1 Qt. Acrylic	White	12	33 lbs
47128	1 Gal. Acrylic	White	4	44 lbs
47640	5 Gal. Acrylic	White	—	55 lbs

For all Roofs



Plas-T-Cote Rubber Roof Coating

Use over rubber roofs, at seams and tears, and to seal vents, air conditioners, etc. Has outstanding exterior durability and high adhesion to rubber. It is UV resistant, and expands and contracts with roof. Resists cracking and withstands impact. Non-polluting and non-toxic.

Part#	Description	Color	Carton Qty	Weight/Case
46032	1 Quart	White	12	33 lbs
46128	1 Gallon	White	4	44 lbs

For RV
Rubber Roofs



Emergency Patching Cement / Repair Kits

Plas-T-Cote Patching Cement

Long Lasting patching cements, stops leaks fast. Just brush it on.

Part#	Description	Color	Case Qty	Case Wt
51125	1 Gal. Wet or Dry Patching Cement	N/A	4	32 lbs
51011	11 oz. Tube Wet or Dry Patching Cement	Black	12	10 lbs



Plas-T-Cote Glass Fabric

A reinforcing membrane for use on cracks 1/4" or larger. This fabric can be used with patching cement, fibered aluminum and alkyl roof coatings

Part#	Description	Color	Case Qty	Case Wt
500001	Roll of Glass Fabric 4" x 50'	Black	6	4
500002	Roll of Glass Fabric 4" x 50'	White	6	4
500003	Roll of Glass Fabric 6" x 150'	Black	12	28
500004	Roll of Glass Fabric 6" x 150'	White	12	28



Plas-T-Cote Patching Tapes

Pliable butyl rubber press-on tapes for roof repairs. Stops leaks fast

Part#	Description	Color	Case Qty	Case Wt
5029	1/8" x 2" x 42" Roll	Black	12	14
5129	1/8" x 2" x 42" Roll	White	12	14



Plas-T-Cote Repair Kit

A general purpose white or black plastic cement and patching compound for patching and filling cracks and holes prior to applying other coatings

Part#	Description	Color	Case Qty	Case Wt
52001	Black Patching Cement	Black	4	20
51001	White Patching Cement	White	4	24



Plas-T-Cote Acrylic & Silicone Sealants

Part#	Description	Color	Case Qty	Case Wt
9400	Siliconized Acrylic Latex Caulking Cartridge	Clear	12	9
9402	Siliconized Acrylic Latex Caulking Cartridge	White	12	9
9300	General Purpose Silicone Caulking Cartridge	Clear	12	9
9301	General Purpose Silicone Caulking Cartridge	Black	12	9
9302	General Purpose Silicone Caulking Cartridge	White	12	9
9303	General Purpose Silicone Caulking Cartridge	Aluminum	12	9
9306	General Purpose Silicone Caulking Cartridge	Almond	12	9
9305	General Purpose Silicone Caulking Cartridge	Maple	12	8
96600	Nuflex 640 Gun Grade Sealant 10.3 oz. Tube	Clear	12	12
96602	Nuflex 640 Gun Grade Sealant 10.3 oz. Tube	White	12	12
9701	Nuflex 110 Butyl Sealant 10.5 oz. Tube	Black	12	12
95022	Nuflex 110 Butyl Sealant 10.5 oz. Tube	White	12	12
9706	AP 77 Butyl Sealant 10.5 oz. Tube	Bronze	30	30
95023	Nuflex 110 Butyl Sealant 10.5 oz. Tube	Alum/Gray	12	12
9503640	SS 300 Self-Leveling Sealant 5 gal pail	Alum/Gray	—	50 lbs.
95502	Nuflex 311 Self Leveling Joint Sealant	White	12	12



Elixir Metal Shelving

Elixir Metal Shelving has a superior phosphate baked on coating that protects it against rust, salt and corrosion. This unique, all white shelving can be easily installed in a variety of configurations to fit your requirements.

Features:

- Phosphate coating
- Available in 12' lengths (allows cutting to fit work area)
- Required hardware provided
- Creates storage spaces in closets, pantries, laundry areas, etc.
- Easy to install

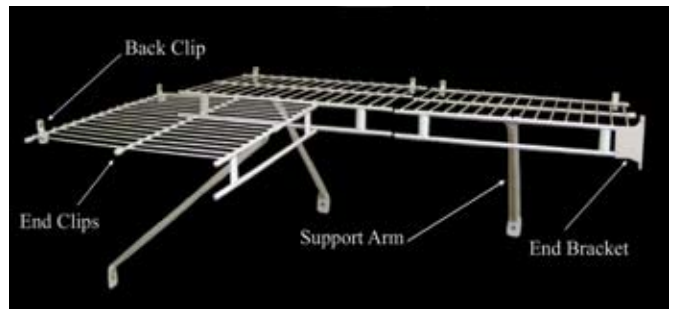

Part#	Description	Color	Carton Qty
3010	12" x 12' Shelving	white	14
3011	Back Clip - One hole	white	2,500
3012	Support Arm 12"	white	100
3013	End Bracket	white	500
3014	Link	white	200
3015	Tip (small)	white	1,000
3016	Tip (large)	white	1,000
3017	Shelving 12' x 16"	white	12
3018	Support Arm 16"	white	100
3019	Back Clip - Two hole	white	2,500

Door Locks - Replacement

Features:

- Universal Locks
- Inside Knob - Always Free for Exit
- Combination Lockset / Keyed Alike
- 1" Deadbolts
- Fits 1-3/8" - 1-3/4" door thickness
- For 2-3/8" or 2-3/4" backset
- For drive in or mortised latch
- Available in bright brass or stainless steel
- Each lock is packed with a 4/way universal latch, plastic gasket, installation instructions and a zinc die cast striker



Part#	Description	Carton Qty
T6409	Tulip Passage Indiv. Boxed	1
T6509	Tulip Privacy Indiv. Boxed	1



Part#	Description	Carton Qty
Q6721	Combination Lockset - Bright Brass	1
Q6621	Combination Lockset - Stainless Steel	1
T6709	Reg. Lock - Bright Brass	1
T6609	Reg. Lock - Stainless Steel	1
D271	1" Deadbolt - Bright Brass	1
D261	1" Deadbolt - Stainless Steel	1

Aluminum & Steel Siding

Painted Aluminum and Steel Siding for Recreational Vehicles and Manufactured Housing.



Board and Batten Vertical Die



4" Mesa 3



Yoder 120-C

Universal Tire Carriers

Features:

- Heavy gauge Painted Steel Construction
- Includes U-Bolts to Mount Bumper
- Sold in Bulk Quantities

Part #	Description	CTN
16-ELX-1-SW1	Fold Down Tire Carrier	4
16-ELX-1-ST	Stationary Tire Carrier	4



Fold Down Model
#16-ELX-1-SW1



Stationary Model
#16-ELX-1-ST

Butane Straps

Part #	Description	Length
90032	Strap for Single Tank	39 3/4"
90033	Strap for Double Tank	79"



Aluminum Bowed Roof Rafters



These prefabricated aluminum rafters will save your company time and money. No more costly in-plant construction costs. Elixir aluminum bowed roof rafters are available with flush or recessed ends. Constructed of 100% primary aluminum. Eliminates rafter building labor, scrap, cutting and welding expenses. Reduce construction time for building your recreational vehicles and manufactured housing units with Elixir's Aluminum Bowed Roof Rafters.

Sealants - Putty Tape

Putty Tape - 160 *Ideal for Rubber Roofs*

This natural colored putty tape is a heavy, flexible, non-hardening butyl material that remains pliable as packaged. It releases easily from its silicone-treated backer. For use under moldings; around windows, doors and vents. It can be used to seal and waterproof overlapping metals and can be easily shaped and formed to seal difficult areas. Also can be used under framed walls as a sound a moisture barrier.

160 Tape can be applied in temperatures between -20F to 180F; best results if applied at room temperature on dry materials. It has a one year shelf life and a two year application warranty.

Trimmable Butyl - 180 *Ideal for Rubber Roofs*

No. 180 Trimmable Butyl is an off-white, non-hardening elastic butyl based material. It provides excellent sealing adhesion to any type of metal, wood, concrete, glass, plastics and porous surfaces. Can be used under moldings; around windows, doors and vents. It can be trimmed easily with any stiff, pointed non-scratching object.

180 increases in adhesion with age, after it is applied. It can be pressed and formed to obtain a water and air tight seal. The recommended temperatures it can be applied at are between -30F and 200F; best results if applied at room temperature on dry materials. 180 has a one year shelf life and a two year application warranty.

#154B Black Putty		
Part#	Description	Rolls/Case
5431	1/8 x 3/4 x 30'	20rls / cs
5425	1/8 x 1 x 30'	16rls / cs
	1/8 x 1 1/4 x 30'	12rls / cs
5426	1/8 x 1 1/2 x 30'	12rls / cs
5429	1/8 x 1 3/4 x 30'	8rls / cs
5430	1/8 x 2 x 30'	8 rls / cs
5455	3/16 x 3/4 x 20'	20 rls / cs
5450	3/16 x 1 x 20'	16 rls / cs
5451	3/16 x 1 1/2 x 20'	12 rls / cs
5453	3/16 x 1 3/4 x 20'	8 rls / cs
5487	1/2 x 2 x 24"	24 rls / cs

#160 Gray Putty Tape		
Part#	Description	Rolls/Case
5625	1/8 x 1 x 30'	16 rls / cs
5620*	1/16 x 1/2 x 45'	28 rls / cs
5603	1/16 x 3/4 x 45'	20 rls / cs
5601*	1/16 x 1 x 45'	16 rls / cs
5636*	1/8 x 1/2 x 7'	96 rls / cs
5628	1/8 x 1/2 x 30'	28 rls / cs
5631	1/8 x 3/4 x 30'	20 rls / cs
5624*	1/18 x 1 x 8'	72 rls / cs
5625	1/8 x 1 x 30'	16 rls / cs
5627	1/8 x 1 1/4 x 30'	12 rls / cs
5626	1/8 x 1 1/2 x 30'	12 rls / cs
5629	1/8 x 1 3/4 x 30'	8 rls / cs
5630	1/8 x 2 x 30'	8 rls / cs
5634*	1/8 x 3 x 30'	4 rls / cs
5642*	1/8 x 4 x 30'	4 rls / cs
5646	1/8 x 6 x 8"	100 pads / cs
5645*	1/8 x 6 x 8"	100 pads/cs green
5649	1/8 x 6 x 8"	144 pads / cs
5657*	3/16 x 1/4 x 20'	28 rls / cs
5655	3/16 x 3/4 x 20'	20 rls / cs
5650	3/16 x 1 x 20'	16 rls / cs
5652*	3/16 x 1 1/4 x 20'	12 rls / cs
5651	3/16 x 1 1/2 x 20'	12 rls / cs
5653	3/16 x 1 3/4 x 20'	8 rls / cs
5654	3/16 x 2 x 20'	8 rls / cs
5676	1/4 x 1/2 x 18'	28 rls / cs
5677	1/4 x 3/4 x 18'	20 rls / cs
5675*	1/4 x 1 x 18'	16 rls / cs
5673*	1/4 x 1 1/4 x 18'	12 rls / cs
5681*	1/4 x 1 1/2 x 18'	12 rls / cs
5672*	1/4 x 1 3/4 x 18'	8 rls / cs
5683*	1/4 x 2 x 18'	8 rls / cs
5687*	1/2 x 2 x 24'	24 strips / cs
5694*	8" long 1lb. Duk Seal Log	50 / cs
5695	10" long 1lb. Duk Seal Log	40 / cs
5670*	3/16 x 30" Bead	504 beads / cs

#180 Trimmable Butyl		
Part#	Description	Rolls/Case
5820*	1/16 x 1/2 x 45'	28 rls / cs
5803	1/16 x 3/4 x 45'	20 rls / cs
5801	1/16 x 1 x 45'	16 rls / cs
5802	1/16 x 1 1/2 x 45'	12 rls / cs
5805	1/16 x 1 3/4 x 45'	8 rls / cs
5828	1/8 x 1/2 x 30'	28 rls / cs
5831	1/8 x 3/4 x 30'	20 rls / cs
5825	1/8 x 1 x 30'	16 rls / cs
5827	1/8 x 1 1/4 x 30'	12 rls / cs
5826	1/8 x 1 1/2 x 30'	12 rls / cs
5829	1/8 x 1 3/4 x 30'	8 rls / cs
5830	1/8 x 2 x 30'	8 rls / cs
5834*	1/8 x 3 x 30'	4 rls / cs
5857*	3/16 x 1/4 x 20'	28 rls / cs
5856*	3/16 x 5/8 x 20'	20 rls / cs
5855	3/16 x 3/4 x 20'	20 rls / cs
5850	3/16 x 1 x 20'	16 rls / cs
5852*	3/16 x 1 1/4 x 20'	12 rls / cs
5851	3/16 x 1 1/2 x 20'	12 rls / cs
5853	3/16 x 1 3/4 x 20'	8 rls / cs
5854	3/16 x 2 x 20'	8 rls / cs
5876*	1/4 x 1/2 x 18'	28 rls / cs
5871*	1/4 x 5/8 x 18'	20 rls / cs
5877	1/4 x 3/4 x 18'	20 rls / cs
5874*	1/4 x 1 x 12'	16 rls / cs
5875	1/4 x 1 x 18'	16 rls / cs
5873*	1/4 x 1 1/4 x 18'	12 rls / cs
5878*	1/4 x 1 1/2 x 12'	12 rls / cs
5879	1/4 x 1 1/2 x 18'	12 rls / cs
5872	1/4 x 1 3/4 x 18'	8 rls / cs
5880*	1/4 x 2 x 12'	8 rls / cs
5883	1/4 x 2 x 18'	8 rls / cs
5800*	5/16 x 3/4 x 12'	16 rls / cs
5870*	3/16 x 30" Bead	504 / cs
5887*	12 x 2 x 24" Bead	24 / cs
5931*	1/8 x 3/4 x 30' BLK	20 rls / cs
5925*	1/8 x 1 x 30' BLK	16 rls / cs
5954*	3/16 x 2 x 20' BLK	8 rls / cs
5977*	1/4 x 3/4 x 18' BLK	20 rls / cs

* Not Stock Items - 42 case Minimum order

Sealants - Non Trimmable Butyl

Non-Trimable 110 *Ideal for Rubber Roofs*

No. 110 sealing tape is a tough, white, non-hardening elastic butyl based material with excellent sealing properties. It is a pliable, tacky sealant tape which will adhere to any type of metal, wood, concrete, glass, plastics and porous surfaces. Excellent sealant for any lap joints. It is a non-trimmable material but could be cut with a utility knife. Its adhesion increases with age after being applied, assuring a long safe and durable seal. It is ideal for sealing roof and side panels such as aluminum to aluminum, galvanized to galvanized or aluminum to galvanized metal. The temperature limits 110 can be applied at are between -30F and 200F; best results are obtained if applied at room temperature on dry materials. It has a one year shelf life and a two year application warranty.



#101 Non-Trimable Black Butyl					
Part#	Description	Rolls/Case	Part#	Description	Rolls/Case
5020*	1/16 x 1/2 x 45'	28 rls / cs	5029	1/8 x 2 x 42"	12 rls / cs
5003*	1/16 x 3/4 x 45'	20 rls / cs	5030	1/8 x 2 x 30'	8 rls / cs
5001	1/16 x 1 x 45'	16 rls / cs	5034	1/8 x 3 x 30'	4 rls / cs
5002	1/16 x 1 1/2 x 45'	12 rls / cs	5042*	1/8 x 4 x 30'	4 rls / cs
5005*	1/16 x 1 3/4 x 45'	8 rls / cs	5058*	3/16 x 1/2 x 20'	28 rls / cs
5006*	1/16 x 2 x 45'	8 rls / cs	5055	3/16 x 3/4 x 20'	20 rls / cs
5004*	1/16 x 3 x 45'	4 rls / cs	5050	3/16 x 1 x 20'	16 rls / cs
5023*	1/8 x 3/8 x 30'	28 rls / cs	5052*	3/16 x 1 1/4 x 20'	12 rls / cs
5028*	1/8 x 1/2 x 30'	28 rls / cs	5051*	3/16 x 1 1/2 x 20'	12 rls / cs
5031	1/8 x 3/4 x 30'	20 rls / cs	5054*	3/16 x 2 x 20'	8 rls / cs
5038	1/8 x 9/16 x 30'	28 rls / cs	5077	1/4 x 3/4 x 18'	20 rls / cs
5025	1/8 c 1 x 30'	16 rls / cs	5075	1/4 x 1 x 18'	16 rls / cs
5027	1/8 x 1 1/4 x 30'	12 rls / cs	5080*	1/4 x 2 x 12'	8 rls / cs
5026	1/8 x 1 1/2 x 30'	12 rls / cs	5083	1/4 x 2 x 18'	8 rls / cs
5039*	1/8 x 1 3/4 x 30'	8 rls / cs			

#101 Non-Trimable White Butyl					
Part#	Description	Rolls/Case	Part#	Description	Rolls/Case
5120	1/16 x 1/2 x 45'	28 rls / cs	5130	1/8 x 2 x 30'	8 rls / cs
5103	1/16 x 3/4 x 45'	20 rls / cs	5133	1/8 x 2 1/2 x 30'	8 rls / cs
5101	1/16 x 1 x 45'	16 rls / cs	5158*	3/16 x 1/2 x 20'	28 rls / cs
5102	1/16 x 1 1/2 x 45'	12 rls / cs	5155	3/16 x 3/4 x 20'	20 rls / cs
5105	1/16 x 1 3/4 x 45'	8 rls / cs	5150	3/16 x 1 x 20'	16 rls / cs
5112*	3/32 x 1/2 x 35'	28 rls / cs	5152*	3/16 x 1 1/4 x 20'	12 rls / cs
5113*	3/32 x 1 1/2 x 35'	12 rls / cs	5151*	3/16 x 1 1/2 x 20'	12 rls / cs
5128	1/8 x 1/2 x 30'	28 rls / cs	5153*	3/16 x 1 3/4 x 20'	8 rls / cs
5131	1/8 x 3/4 x 30'	20 rls / cs	5154*	3/16 x 2 x 20'	8 rls / cs
5125	1/8 x 1 x 30'	16 rls / cs	5177	1/4 x 3/4 x 18'	20 rls / cs
5127	1/8 x 1 1/4 x 30'	12 rls / cs	5175*	1/4 x 1 x 18'	16 rls / cs
5126	1/8 x 1 1/2 x 30'	12 rls / cs	5181	1/4 x 1 1/2 x 18'	12 rls / cs
5139	1/8 x 1 3/4 x 30'	8 rls / cs	5183*	1/4 x 2 x 18'	8 rls / cs
5129	1/8 x 2 x 42"	12 rls / cs			

#101 Non-Trimable White Butyl					
Part#	Description	Rolls/Case	Part#	Description	Rolls/Case
5307*	1/16 x 3/8 x 45'	28 rls / cs	5330	1/8 x 2 x 30'	8 rls / cs
5320	1/16 x 1/2 x 45'	28 rls / cs	5355*	3/16 x 3/4 x 20'	20 rls / cs
5303*	1/16 x 3/4 x 45'	20 rls / cs	5350*	3/16 x 1 x 20'	16 rls / cs
5301*	1/16 x 1 x 45'	16 rls / cs	5352*	3/16 x 1 1/4 x 20'	12 rls / cs
5302*	1/16 x 1 1/2 x 45'	12 rls / cs	5351*	3/16 x 1 1/2 x 20'	12 rls / cs
5328*	1/8 x 1/2 x 30'	28 rls / cs	5377	1/4 x 3/4 x 18'	20 rls / cs
5331	1/8 x 3/4 x 30'	20 rls / cs	5375*	1/4 x 1 x 18'	16 rls / cs
5325	1/8 x 1 x 30'	16 rls / cs	5383*	1/4 x 2 x 18'	8 rls / cs
5327*	1/8 x 1 1/4 x 30'	12 rls / cs	5387	1/2 x 2 x 24"	24 strips / cs
5326	1/8 x 1 1/2 x 30'	12 rls / cs			

* Not Stock Items - 42 case Minimum order

Replacement Parts List

* following a part number indicates a part that is available in retail packaging. The next part number will be followed by a -1 or R to indicate the actual part number for the retail package version.

Roof Vents		
Part#	Description	Packaging
JRP1000B*	Metal operator assembly - for all Elixir & Jensen 14 x 14 vents	10
JRP1000R	Retail Package	5
90027	Operator assembly set for Elixir Venturi vent	10
90042	Operator assembly for Elixir 9 x 9 mini vent	10
JRP1002B*	Fan blade for 12volt power vents (counter clockwise rotation)	10
JRP1002R	Retail package	5
90038*	Fan blade for 12volt power vents (clockwise rotation)	10
90038-1	Retail package	5
90119	Fan blade for 110volt motor - Elixir	10
90037*	12volt motor for power vents - fits Elixir, Jensen, & Ventline vents (JRP1003B)	10
90037-1	Retail package (JRP1003R)	4
90048	CSA 12volt power vent motor - fits Elixir, Jensen & Ventline vents (JRP1004B)	10
90120	110volt motor - Elixir	5
JRP1099B	Power lift retro kit. Includes: motor, pinion gear, mounting bracket & gear holder. Can be used to repair Jensen power lift roof vents. Must be used to repair all horizontally shaft mounted motors	5
JRP1024B	Power lift operator drive gear - Jensen	10
JRP1025B	Pinion gear - for power lift vent (Jensen old design - 0.130" D-shaft)	N/A
JRP1026B	Pinion gear - for power lift vent (Jensen / Elixir new design - 0.197" D-shaft)	10
JRP1027B	Momentary on/of/on swich for Jensen power lift vent remote switch assembly	10
JRP1028B	Small rocker on/off switch (black) - Used with Jensen power left vents w/fan or fan & light useing remote assembly	10
JRP1041B	Push botton switch - Elixir, Jensen & Ventline 12volt fan vents - Black (27-0164)	10
JRP1042B	12volt light socket - Used for Jensen lighted roof vent (56-262-01)	10
JRP1006B	12volt light bulb - Used for Jensen lighted roof vent	10
JRP2160B*	Metal crank handle - Fits all Jensen, Elixir, and Ventline 14 x 14 roof vents	50
JRP2160R	Retail package	5
JRP2161B*	Off white crank handle - Fits Jensen 14 x 14 roof vent (substitute JRP2160B)	50
JRP2161R	Retail package - (substitute JRP2160R)	5
90128*	Black crank handle - Fits Elixir, Jensen & Ventline (substitute JRP2160B)	N/A
90128-1	Retail package - (substitute JRP2160R)	N/A
90040*	Off white butterfly operator handle - Fits Elixir and Jensen	50
90040-1	Retail package	5
JRP2111B	48" black dome seal - For Jensen 14 x 14 metal vent	10
90045	52" gray dome seal - For Elixir or Jensen plastic base	10
90121	52" white dome seal - Elixir universal metal base	10
JRP1118B	White Garnish - Jensen 1 1/2" vertical leg	10
JRP1119B	Off white garnish - Jensen 1 1/2" vertical leg	10
JRP1120B	White garnish - Jensen 3" vertical leg	10
JRP1121B	Off white garnish - Jensen 3" vertical leg	10
JRP1122B	White garnish - Jensen 4 1/2" vertical leg	10
JRP1123B	Off white garnish - Jensen 4 1/2" vertical leg	10
90090B	White garnish -1 1/4" mounting flange, 1 1/8 vertical leg (NOTE: does not fit Jensen)	10
90095B	Colonial white garnish - 1 1/4 mounting flange, 1 1/8 vertical leg (NOTE: does not fit Jensen)	10
90091B	White garnish, 1 1/4" mounting flange, 2 1/8" vertical leg	10
90096B	Colonial white garnish, 1 1/8" mounting flange, 2 1/8" vertical leg	10
90092B	White garnish, 1 1/4" mounting flange, 3" vertical leg	10
90097B	Colonial white garnish, 1 1/4" mounting flange, 3" vertical leg	10
90094B	White garnish, 1 1/4" mounting flange, 4" vertical leg	10
90098B	Colonial white garnish 1 1/4" mounting flange, 4" vertical leg	10

Replacement Parts List - Continued

Roof Vents (continued)		
Part#	Description	Packaging
90104B	White garnish, 1 1/4" mouting flange, 5" vertical leg	10
90103B	Colonial white garnish, 1 1/4" mounting flange, 5" vertical leg	10
JRP2101B	White E-Z mount garnish, 1 1/2" vertical leg	10
JRP2102B	Off white E-Z mount garnish, 1 1/2" vertical leg	10
JRP2103B	White E-Z mount garnish, 3" vertical leg	10
JRP2104B	Off white E-Z mount garnish, 3" Vertical leg	10
JRP2105B	White E-Z mount garnish, 4-1/2" vertical leg	10
JRP2106B	Off white E-Z mount garnish, 4-1/2" vertical leg	10
90034W	White garnish - for Elixir 9 x 9 mini vent	10
90034CW	Colonial white garnish - for Elixir 9 x 9 mini vent	10
JRP1210B*	White garnish, with square outside corners and radius inside corners, 1 3/8" vertical leg. - Fits Jensen, Elixir, and Ventline models.	10
JRP1210R	Retail package	5
JRP1124B*	White Jensen screen frame - radius corners	11
JRP1124R	Retail package	5
JRP1125B*	Off white Jensen screen frame - radius corners	10
JRP1125R	Retail package	5
JRP2180	White screen frame - for power lift vent	10
JRP2181	Off white screen frame - for power lift vent	10
90106*	White screen frame for Elixir Universal - garnish telescopes inside screen frame	10
90106-1	Retail package	5
90108	Colonial white screen frame for Elixir Universal - garnish telescopes inside screen frame	10
90109	12 volt colonial white screen frame for Elixir Universal - garnish telescopes inside of screen frame (substitute 90108)	N/A
JRP1161B*	Light lens for 14 x 14 radius corner Jensen roof vent	10
JRP1161R	Retail package	5
JRP2133B	Remote switch, function - fan & power lift (A9321)	10
JRP2134B	Remote switch, function - fan, power lift, and light (A8948)	10
JRP1001B	T-slide bar for Jensen pin hinge style lids	5
JRP2136B	Pin for pin hinge style Jensen lids	5
JRP1291B	T-slide bar for Jensen lids w/o hinge pin	5
90050	T-slide bar for Elixir standard vent prior to 1994	5
5690	Vent installation kit - includes putty tape and screws	10
JRP1295WH	E-Z mount screw 10-24 x 1" white for roof thickness 3/4" to 1 13/8"	1000
JRP1295CW	E-Z mount screw 10-24 x 1" colonial white for roof thickness 3/4" to 1 3/8"	1000
JRP1302WH	E-Z mount screw 10-24 x 1.25" white for roof thickness 7/8" to 1 3/4"	1000
JRP1302CW	E-Z mount screw 10-24 x 1.25" colonial white for roof thickness 7/8" to 1 3/4"	1000
JRP1298WH	E-Z mount screw 10-24 x 1.75" white for roof thickness 1 1/4" to 2 1/4"	1000
JRP1298CW	E-Z mount screw 10-24 x 1.75" colonial white for roof thickness 1 1/4" to 2 1/4"	1000
JRP1296WH	E-Z mount screw 10-24 x 2.5" white for roof thickness 2" to 2 7/4"	1000
JRP1296CW	E-Z mount screw 10-24 x 2.5" colonial white for roof thickness 2" to 2 7/8"	1000
JRP1301WH	E-Z mount screw 10-24 x 3" white for roof thickness 2 1/2" to 3 1/4"	1000
JRP1301CW	E-Z mount screw 10-24 x 3" colonial white for roof thickness 2 1/2" xto3 1/4"	1000
JRP1299WH	E-Z mount screw 10-24 x 3.25" white for roof thickness 2 3/4" to 3 3/4"	500
JRP1299CW	E-Z mount screw 10-24 x 3.25" colonial white for roof thickness 2 3/4" to 3 3/4"	500
JRP1300WH	E-Z mount screw 10-24 x 3.75" white for roof thickness 3 1/4" x 4 1/8"	500
JRP1300CW	E-Z mount screw 10-24 x 3.75" colonial white for roof thickness 3 1/4" x 4 1/8"	500
JRP1297WH	E-Z mount screw 10-24 x 5" white for roof thickness 4 1/2" to 5 3/8"	500
JRP 1297CW	E-Z mount screw 10-24 x 5" colonial white for roof thickness 4 1/2" x 5 3/8"	500

Replacement Parts List - Continued

Replacement Roof Vent Covers		
J294RWH	Lid, Jensen pin hinge style, white, lid in a bag	24
J291RSM	Lid, Jensen pin hinge style, smoke, lid in a bag	24
J291BRZ	Lid, Jensen pin hinge style, bronze, lid in a bag	24
J7291RWH	Lid, Jensen w/o hinge pin style, white, lid in a bag	24
J7291RSM	lid, Jensen w/o hinge pin style, smoke, lid in a bag	24
J7291RBZ	Lid, Jensen w/o hinge pin style, bronze, lid in a bag	24
90082-1	Lid, for Elixir old style series 20000, lid in a bag	24
90085-1	Lid, smoke, for Elixir old style series 20000, lid in a bag	24
90084-1	Lid, amber, for Elixir old style series 20000, lid in a bag	24
90110-1	Lid, white, Elixir Universal, lid in a bag, w/slide bar - fits Elixir Universal and Ventline vents	24
90112-1	Lid, smoke, Elixir Universal, lid in a bag, w/slide bar - fits Elixir Universal and Ventline vents	24
90115-1	Lid, amber, Elixir Universal, lid in a bag, w/slide bar - fits Elixir Universal and Ventline vents	24
90114-1	Lid, metal, Elixir Universal - fits Elixir Universal and Ventline vents	18
90117-1	Lid, white metal, Elixir Universal - fits Elixir Universal and Ventline vents	18
90006-1	Lid, colonial white metal, Elixir Universal - fits Elixir Universal and Ventline vents	18
90028-1S	Lid, smoke, Venturi vent	1
Range Hoods		
J108WH	Exhaust cover only, ABS, white (J121WH) (J122WH)	24
J1080W	Exhaust cover only, ABS, off white (J121OW) (J122OW)	24
J108PG	Exhaust cover only, Styrene, gray (J121PG) (J122PG)	24
J116AWH	Exhaust cover assembly, white w/exterior closing damper	12
J116AOW	Exhaust cover assembly, off white, w/exterior closing damper	12
JRP2120B	Damper for J116, white	12
JRP2121B	Damper for J116, off white	12
J117AWH	Exhaust cover assembly, white, for cable activated opening exhaust 117 operator	12
J117AOW	Exhaust cover assembly, off white, for cable activated opening exhaust 117 operator	12
J121OW	Exhaust cover assembly, white, inc. J108WH cover and metal gravity damper sleeve	12
J121OW	Exhaust cover assembly, off white, inc J1080W ABS cover and metal gravity damper sleeve	12
JRP2117B	Duct extension / gravity damper sleeve for J119 & J121 exhaust assemblies (substitute JRP2127B)	N/A
JRP2127B	Duct extension / gravity damper sleeve for J121 exhaust assembly cabinet underside	12
JRP2122B	Exhaust collar, Elixir range hood opening (4" x 10.88" opening wall cut down 0.62" from cabinet underside)	12
JRP2123B	Exhaust conversion collar, conversion for Jensen range hood opening (4"x10.88" opening wall cut down 1.12" from cabinet underside) to new Elixir exhaust opening (wall cut down 1.12" from cabinet underside)	12
JRP2124B	Exhaust conversion collar, conversion for New Elixir range hood opening (4"x10.88" opening wall cut down 0.62" from cabinet underside) to Jensen's exhaust opening (4"x10.88" opening wall cut down 1.12" from cabinet underside)	12
JRP2125B	Exhaust conversion collar, converts original Jensen range hood to fit new Elixir range hood opening (4"x10.88" opening wall cut down 0.62" from cabinet underside)	12
JRP2130B	Exhaust conversion kit, converts Elixir range hood to original Jensen wall hole cut (3"x7" opening wall cut down 1.12" from cabinet underside). Inc. JRP2126B exhaust adapter plate & JRP2127B duct extension / gravity damper sleeve. To be used when replacing range hood & the coach is equipped w/ the Jensen 121 exhaust cover & the referenced Jensen original wall cut.	12
JRP2131B	Exhaust conversion kit, converts original Jensen range hood to fit new Elixir range hood opening (3"x7" opening wall cut down 0.875" from cabinet underside). To be used to convert original Jensen range hood to fit a coach equipped w/ the Jensen 121 exhaust cover and the above referenced Elixir wall hole cut.	12
JA7552B	Tank harness	25
JA7538	Well nut (JPR1095B) standard 3/4" screw	50
JRP1223-1B	Cable 23" for 117 range hood exhaust cover operator, includes two cable clips	10
JRP1223-2B	Cable 25" for 117 range hood exhaust cover operator, includes two cable clips	10

Replacement Parts List - Continued

Range Hoods (Continued)		
JRP1223-3B	Cable 40" for 117 range hood exhaust cover operator, included two cable clips	10
JRP1227B	Cable clip 117 operator cable	50
JRP1286-1B	117 operator retrofit repair kit 23" cable. Includes cable RP1223-1B, support RP1224B, lever RP1228B & two clips RP1227B	2
JRP1286-2B	117 operator retrofit repair kit 25" cable. Includes cable RP1223-2B, support RP1224B, lever RP1228B & two clips RP1227B	2
JRP1286-3B	117 operator retrofit repair kit 40" cable. Includes cable RP1223-3B, support RP1224B, lever RP1228B & two clips RP1227B	2
JRP2100B	117 operator switch repair kit. Includes large & small bezel, holder, operator & stop lock	10
JA9243	117 slide switch / electrical on/off for range hood motor activation	10
90037*	12 volt motor	10
90037-1	retail package	4
JRP1002B*	Fan blade - 12 volt range hood with counter clockwise rotation	10
JRP1002R	Retail package	5
90038*	Fan blade - 12 volt range hood with clockwise rotation	10
90038-1	Retail package	5
JRP1204B	Grease filter - Aluminum 8 1/4" x 10"	10
JRP2132B*	Grease filter - charcoal 8 1/4" x 10"	10
JRP2132R	Retail package	10
JRP1205B	Range hood light lens 12 volt	10
JRP2188B	Range hood light lens 110 volt	10
JRP2118B	Light socket - 12 volt Jensen range hoods	10
JRP1206B	On/off rocker switch - for light or fan range hoods w/o a monitor panel	10
JRP2116B	Generator switch - Jensen monitor panel	10
JRP1028B	On/off rocker switch for fan, light, or water heaters for monitor panel range hoods	10
JRP1016B	Momentary rocker switch for monitor panel range hoods	10
JRP2135B	Nylon clip - for securing grease filter	10
Escape Hatches / Exit Vents		
90035	Garnish, white plastic - 2 3/8" roof, fits Elixir 13" x 20"	1
90039	Garnish, white metal - four piece, specify size - fits Elixir 15" x 20"	1
90089	Garnish, white metal - four piece, specify size - fits Elixir 17" x 24"	1
90131	Garnish, white metal - four piece, specify size - fits Elixir 22" x 22"	1
90015	Garnish, white metal - four piece, specify size - fits Elixir 26" x 26"	1
90013S	Screen - Elixir 13" x 20"	1
90012S	Screen - Elixir 15" x 20"	1
90018S	Screen - Elixir 17" x 24"	1
90130	Screen - Elixir 22" x 22"	1
90010S	Screen - Elixir 26" x 26"	1
90049	Dome seal - fits all Elixir escape hatches / exit vents	1
90025	Latch - red, spring loaded - for Elixir escape hatch only (substitute JRP2115)	N/A
JRP2115B	Latch - spring loaded - for Elixir and Jensen escape hatches	10
90150	Operator metal crank handle. Fit all except Elixir 31121 plastic exit vent	25
JRP1000B	Operator assembly - metal, fits all Elixir escape hatches / Exit vents	10
JRP1029B	T-slide bar, Jensen 22" x 22" & 26" x 26" escape hatch & Elixir 22" x 22" exit vent	10
90135	T-slide bar, Elixir 13" x 20" escape hatch / exit vent	10
90136	T-slide bar, Elixir 15" x 22" escape hatch / exit vent	10
90137	T-slide bar, Elixir 17" x 24" escape hatch / exit vent	10
90138	T-slide bar, Elixir 17" x 24" escape hatch / exit vent	10
Escape Hatch / Exit Vent Replacement Covers		
J294X16	Lid - Jensen 16" x 23" escape hatches - fits 702B-16, 703B-16, 704B-16, 705B-16	1
J294X18	Lid - Jensen 18" x 25" escape hatches - fits 705B-18, 706B-16, 707BN-18	
J294X22	Lid - Jensen 22" x 22" escape hatches - fits 200 x 22	
J294X26	Lid - Jensen 26" x 26" escape hatches - fits 200 x 26	
90007-1	Lid - Elixir 13" x 20" - fits escape hatch 31121	

Replacement Parts List - Continued

Escape Hatch / Exit Vent Replacment Covers (continued)		
90008-1	Lid - Elixir 15" x 22" - fits escape hatch 58621	1
90088-1	Lid - Elixir 17" x 24" - fits escape hatch 48621	1
90129-1	Lid - Elixir 22" x 22" - fits escape hatch 66621	1
90014-1	Lid - Elixir 26" x 26" - 1 5/8" hinge height - fits escape hatch 68631 current production	1
90014OS-1	Lid - Elixir 26" x 26" - 2 1/4" hinge height	1
90139	Hardware kit - Jensen or Elixir escape hatch replacement lids	10

Divisional Directory

with

Manufacturing Facilities and Products

01 Corporate Headquarters

Ph. (949) 860-5000 Fax. (949) 860-5011
24800 Chrisanta Drive • Suite 100/210
Mission Viejo, CA 92691

President / CEO: **Christopher A. Sahn**
Chief Financial Officer: **Robert Cuthbertson**
Director of National Purchasing: **Joe Hull**
Director of International Sales: **Julie Cameron**
Director of New Business Development: **John Willis**
Director of National Sales and Mrk.: **Tim Suttles**
National Sales / Mrk. Executive Assn: **Robert Powers**



11 Sacramento, CA Division

Ph. (916) 419-9262 Fax: (916) 419-9059
3321 Airport Rd • Sacramento, CA. 95834

Galvalume Metal Roofing, Ironwood Steel Siding, Custom Metal Fabrication, Steel Fabrication, Galvanized and Aluminum, Flashing, Pro Line™ Super Scraper

16 Elkhart, IN Division

Ph. (800) 443-5473 Fax: (574) 294-2568
640 Collins Rd. • Elkhart, IN. 46516

Adhesives, Putty and Butyl Tapes, Roof Coatings, Sealants, RV Power Converter, Spare Tire Carriers, Wire Closet Shelving, Door Hardware

* 17 Elkhart, IN Division

Ph (574) 295-7229 Fax: (574) 295-8550
2040 Industrial Parkway • Elkhart, IN 46516

LP Bottle Covers, Tire Carriers, Dome Vents, Escape Hatches, Tube Skylites, RV Range Hoods, Baggage Doors (RV), Block Windows, Fireplaces (MH), NOMACO Seals, Exterior Shutters, Table Legs, Cargo Trailer Vents, Utility Doors, Cargo Doors, Cargo Trailer Components, Residential Windows

* 24 Douglas, GA Division

Ph. (912) 384-2078 Fax: (912) 384-6480
1215 Pope Drive • Douglas, GA 31533

Entrance Doors, Mobile Office/Classroom Doors, RV Power Converter, Adhesives, Putty and Butyl Tapes, Roof Coatings, Sealants, Cargo Trailer Doors, Residential Brick Mould Doors

25 Fitzgerald, GA Division

Ph. (229) 423-4311 Fax: (229) 423-6722
243 Washington Ave. • Fitzgerald, GA 31750

Ironwood Steel Siding, Custom Metal Fabrication, Galvalume Metal Roofing, Power-Rib Steel Roofing and Siding, Aluminum Painted Coil, Cargo Trailer Components, Aluminum Treadplate, Wire Closet Shelving, Vinyl Lap Siding / Vinyl Soffit, RV Power Converters

* 26 Reidsville, NC Division

(336) 342-2353 Fax: (336) 342-0657
1203 Freeway Drive • Reidsville, NC 27320

Perforated Soffit, Ironwood Steel Siding, Entrance Doors, Aluminum Painted Coil, Residential Brick Mould Doors, Vinyl Lap Siding / Vinyl Soffit, Door Hardware, Residential Windows, RV Range Hoods, Adhesives, Putty and Butyl Tapes, Roof Coatings, Sealants, Galvalume Metal Roofing, Power-Rib Steel Roofing and Siding, Custom Metal Fabrication, Cargo Trailer Components, Commercial Doors, Cargo Trailer Vent, Steel Fabrication, Wire Closet Shelving, Atrium Doors, French Doors, Patio Doors

27 Douglas, GA Division

(912) 384-2078 Fax: (912) 384-6480
1300 Pope Drive • Douglas, GA 31533

Aluminum Painting, Aluminum Extrusion, Extrusion Fabrication, Powder-Coat Painting, Mechanical Finishing, Anodic Coatings, Aluminum Anodizing

28 Mishawaka, IN Division

(574) 259-7133 Fax: (574) 259-7317
5201 Lincoln Way East • Mishawaka, IN 46544

Extrusion Fabrication, Anodic Coatings, Aluminum Anodizing, Aluminum Extrusion, Aluminum Fabrication, Aluminum Painting, Powder-Coat Painting

34 Crossville, TN Division

(931) 484-2541 Fax: (931) 484-7121
P.O. Box 628 / 1765 Genesis Road • Crossville, TN 38557 / 38555
Entrance Doors, Patio Doors, French Doors

* Represents a Distribution Center

Divisional Directory

with

Manufacturing Facilities and Products

42	Elkhart, IN Division (800) 443-5473 Fax: (574) 293-0946 640 Collins Road • Elkhart, IN 46516 <i>Entrance Doors, Ironwood Steel Siding, Galvalume Metal Roofing, Custom Metal Fabrication, Aluminum Painted Coil, Aluminum Treadplate, Tie Connectors, Cargo Trailer Components, RV Components, Marine Components, Freezer/Refrigeration Components, Galvalume / Galvanized Underbellies</i>
55	Vancouver, WA Division Ph (360) 254-5077 Fax: (360) 254-4577 5600 N.E. 121st Ave. • Vancouver, WA 98682 <i>Custom Thermoformed Plastics, Travel Shields</i>
* 56	
* 57	Meridian, ID Division Ph (208) 888-1511 Fax: (208) 888-1556 535 North Eagle Road • Meridian, ID 83642 <i>RV Door Fabrication, Aluminum Fabrication, Power-Rib Steel Roofing and Siding, Cargo Trailer Components, Cargo Doors</i>
*65	Waco, TX Division Ph (254) 741-1060 Fax: (254) 741-0155 5500 Industrial Drive • Waco, TX 76710 <i>Aluminum Painted Coil, Cargo Doors, Entrance Doors, Ironwood Steel Siding, Galvalume Metal Roofing, Custom Metal Fabrication, Dome Vents, Escape Hatches, RV Range Hoods, RV Power Converter, Adhesives, Putty and Butyl Tapes, Roof Coatings, Sealants, Cargo Trailer Components, Aluminum Treadplate, Steel Fabrication, Wire Closet Shelving, Residential Brick Mould Doors</i>
*76	Mesa, AZ Division Ph (800) 555-3023 Fax: (480) 833-7569 219 S. Mulberry • Mesa, AZ 85202 <i>Entrance Doors, Ironwood Steel Siding, Galvalume Metal Roofing, Custom Metal Fabrication, Steel Fabrication, Utility Doors, Frame Parts, Laminating, Dome Vents, Escape Hatches, RV Range Hoods, RV Power Converter, Adhesives, Putty and Butyl Tapes, Roof Coatings, Sealants, Cargo Doors, Cargo Trailer Components, Aluminum Tread Plate, Wire Closet Shelving</i>
*81	Tuscumbia, AL Division Ph (256) 381-5932 Fax: (256) 381-0039 P.O. Box 309 / 505 Hwy 20 East • Tuscumbia, AL 35674 <i>Power-Rib Steel Roofing and Siding, Entrance Doors, Ironwood Steel Siding, Custom Metal Fabrication, Galvalume Metal Roofing, Vinyl Lap Siding / Vinyl Soffit, Dome Vents, Escape Hatches, RV Range Hoods, RV Power Converter, Adhesives, Putty and Butyl Tapes, Roof Coatings, Sealants, Wire Closet Shelving, Frame Parts, Fireplaces (MH), Stainless Steel Flashing, Cargo Doors, Block Windows, Residential Windows, Residential Brick Mould Doors</i>
*82	Leola, PA Division Ph. (717) 656-2831 Fax: (717) 656-0969 304 E. Main Street • Leola, PA 17540 <i>Aluminum Painted Coil, Cargo Doors, Entrance Doors, Ironwood Steel Siding, Aluminum Extrusion, Steel Fabrication, Aluminum Fabrication, Vinyl Siding / Vinyl Soffit, Atrium Doors, Dome Vents, Escape Hatches, RV Range Hoods, RV Power Converter, Putty and Butyl Tapes, Roof Coatings, Sealants, Adhesives, Table Legs, Aluminum Treadplate, Cargo Trailer Components, Custom Metal Fabrication, Wire Closet Shelving, Residential Brick Mould Doors, Extrusion Fabrication, Cargo Trailer Vent, Door Hardware, Locks, Utility Doors, Commercial Doors, Baggage Doors (RV), Tube Skylites, Stainless Steel Flashing, Galvalume Metal Roofing, Perforated Soffit, Tire Covers</i>

* Represents a Distribution Center

Distributor

Manufacturers Supply

Ph. (360) 690-4499 Fax: (360) 735-9386

3201 NW Lower River Road #9

Vancouver, WA 98660

Adhesives, Putty and Butyl Tapes, Roof Coatings, Sealants, RV Power Converters, Tire Carriers, Escape Hatches, RV Roof Vents, RV Range Hoods, Table Legs

Mission Statement

Elixir is a diversified manufacturer, fabricator and a distributor of a wide range of products. We strive to exceed the level of quality and service on which our customers have come to rely. Our focus is to partner with customers and suppliers in mutually profitable business relationships. The Elixir team is committed to conducting business with the highest integrity while meeting the changing needs of our customers, employees and community.