

KFV

GENIUS and A-opener

GENIUS and A-opener — Multi-point locks
with electromechanical drive and access control systems

Window systems

Door systems

Comfort systems

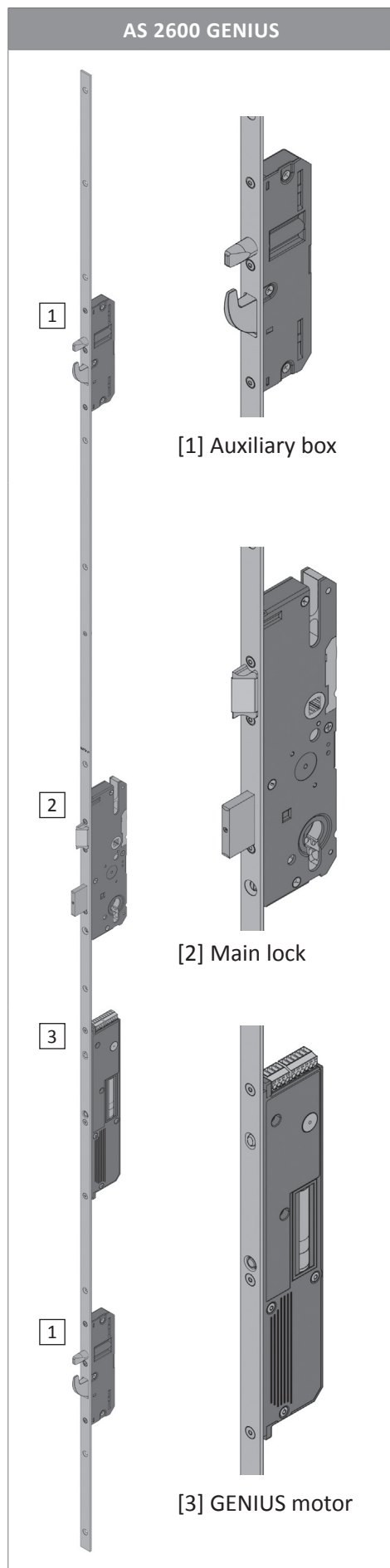

GENIUS: electromechanical locking and unlocking.

GENIUS has an integrated electronic control system and an electronically controlled gear motor. The powerful motor ensures a perfect tight sealing of the door as well as fast and quiet door locking and unlocking. All GENIUS variants can be combined with numerous access control systems.

GENIUS is available in four versions:

- GENIUS EA: Motorised unlocking via access control system and from inside via a button.
- GENIUS EB: Motorised unlocking via access control system and from inside via a button. It can be combined with an external clock timer or other external systems such as a motorised door drive or an alarm system.
- GENIUS CA: Functional scope like GENIUS EA, but with additional comfort function. Mechanical unlocking via the lever handle on the inside of the door is possible all the time.
- GENIUS CB: Functional scope like GENIUS EB, but with additional comfort function. Mechanical unlocking via the lever handle on the inside of the door is possible all the time.

For all variants: Manual use via the profile cylinder is also possible.

GENIUS PANIC multi-point lock

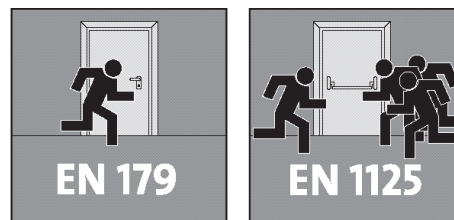

You will find electromechanical multi-point locks for use in escape and rescue route doors in accordance with EN 179 and EN 1125 in the separate [Product catalogue „Life saver“](#).

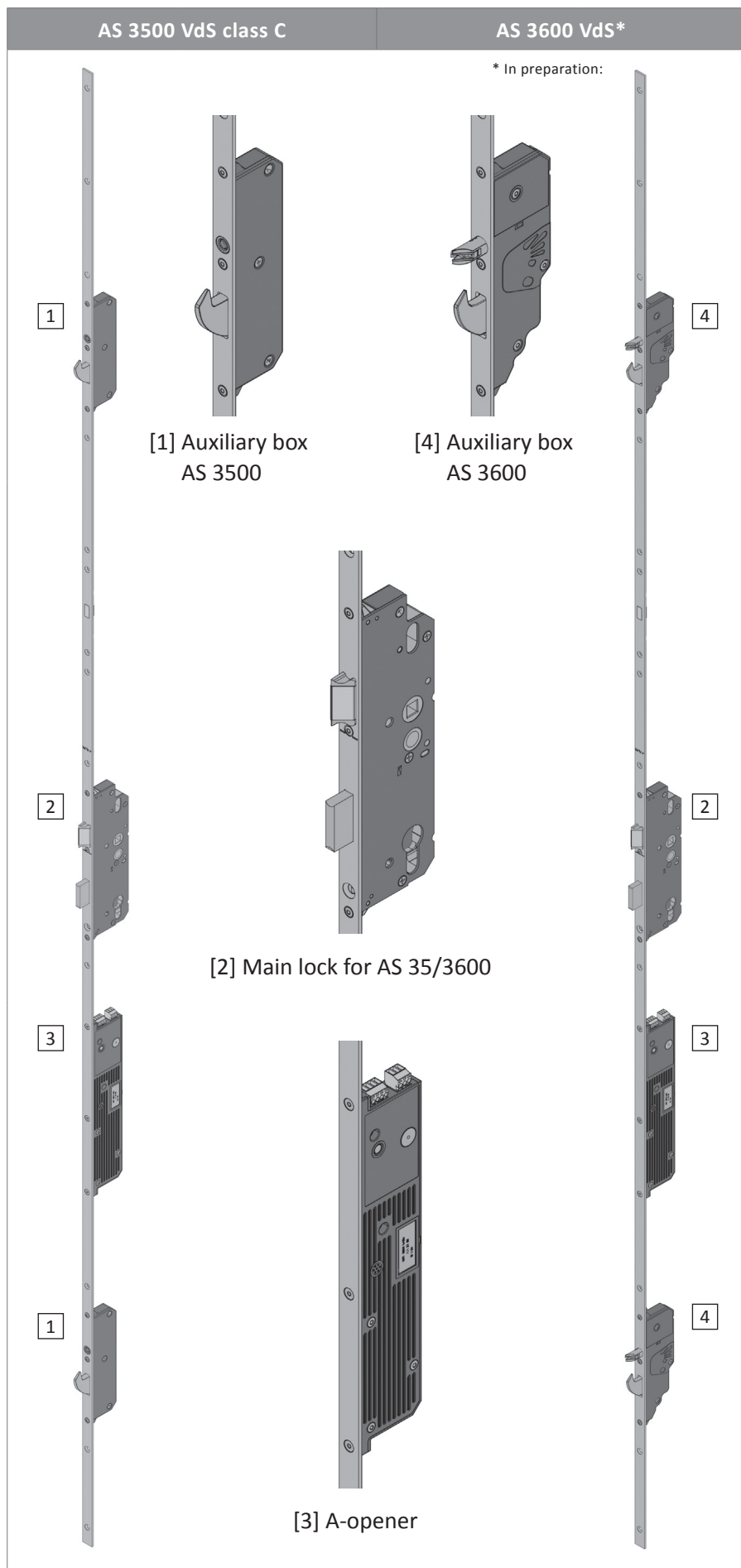

A-opener:

- Mechanical automatic locking mechanism
- Electromechanical unlocking

The A-opener is equipped with integrated control electronics and a motor which ensure quick unlocking.

The A-opener can also be combined with numerous external access control systems.

The A-opener can be retrofitted on the KfV multi-point locks AS 3500 and AS 3600.

FUNCTIONS	GENIUS 2.X EA	GENIUS 2.X CA	GENIUS 2.X EB	GENIUS 2.X CB	A-OPENER 2.X
Installation width from 16 mm faceplate	●	●	●	●	●
Installation depth from 35 mm backset	●	●	●	●	●
Can be combined with standard hardware	●	●	●	●	●
Openings to fix rosettes from 45 mm backset	●		●		
Mechanical automatic locking mechanism (in connection with MFV AS 3500 or AS 3600)					●
Electromechanical locking part	●	●	●	●	
Manual locking and release via cylinder even during a power failure	●	●	●	●	●
Gear in the main lock for forceful manual deadbolt and latch operation	●	●	●	●	
Permanent locking monitoring system (incomplete deadbolt throw is indicated acoustically)	●	●	●	●	
Manual operating mode changeover via LED menu buttons: Day function: The electromechanical door lock is deactivated but, due to the latch, the door still remains locked Night function: The electromechanical door lock is activated every time the door is closed into the frame	●	●	●	●	
Electromechanical opening via potential-free contact (push-button) of the external access control systems (e.g. transponder, wireless, fingerprint, Bluetooth, etc.)	●	●	●	●	●
Radio transmitter operation (can be operated from inside and outside)	○	○	○	○	○
Operation via transponder	○	○	○	○	○
Operation via fingerprint recognition	○	○	○	○	○
Operation via KfVkeyless	○	○	○	○	○
Automatic mode changeover via external clock timer			●	●	
Combination with external systems (e. g. motorised door drive or alarm system)			○	○	
Comfort function via the lever handle on the interior side of the door (not available for the A-opener when it is locked by the cylinder)		●		●	●
SI bus for the use of the SI bus analytic tool in conjunction with SI bus converter	●	●	●	●	●

- These functions are available ex-works.
- Additional accessories are required for these operating modes.

Select multi-point locks

Choose your required multi-point lock from the options on the following three pages and then assemble your GENIUS or A-opener set in four steps or select one the eight preconfigured Plug and Play sets.

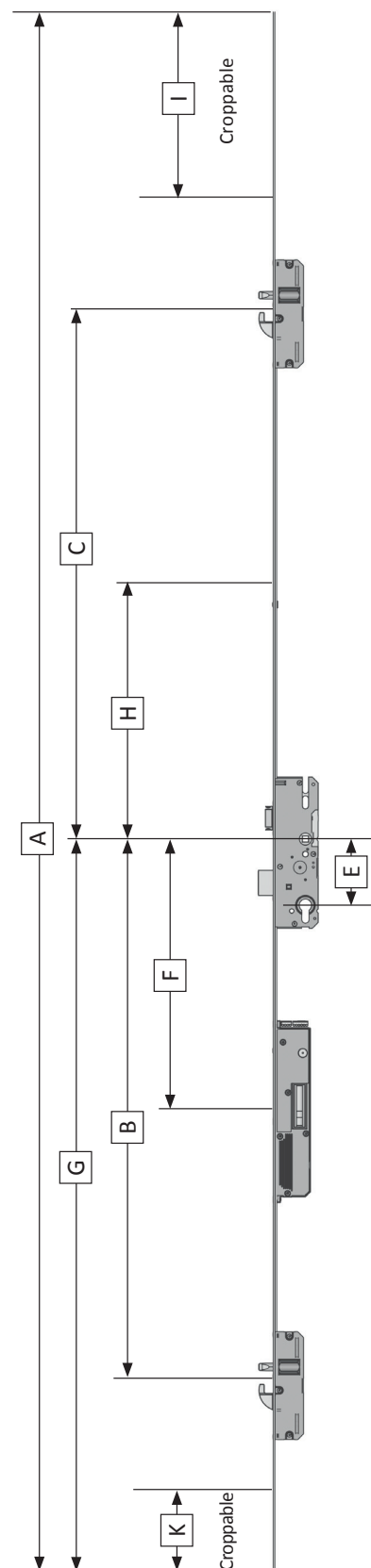

Figure shows GEN AS 2600 EA / EB / CA / CB
E* = PZ dimension



For all GENIUS multi-point locks (except GEP GENIUS PANIC and multi-point lock with A-opener), FZG-type free running key or knob cylinders are required. A locking rail or a striker plate with a magnetic bush is required for the frame side.

Standard dimension variant for timber and PVC doors *

Size ranges	A	B	C	F	G	I	K	Range of application	Sash rebate height
B001	2170	760	730	380	1020	290	130	Standard doors, Handle height 1020	1881 - 2170

Standard dimension variant for metal doors *

Size ranges	A	B	C	F	G	I	K	Range of application	Sash rebate height
K001	1817	760	730	380	892	—	—	Faceplate trimmed to size	1945
K002	1754	760	730	380	892	—	—	Faceplate trimmed to size	1882 - 2170

Version for apartment entrance doors made from timber

Size ranges	A	B	C	F	G	I	K	Range of application	Sash rebate height
K007	1847	822.5	730	380	970	—	—	Faceplate rounded	1882 - 2170

Other size variants for timber and PVC doors

Size ranges	A	B	C	F	G	I	K	Range of application	Sash rebate height
B003	2400	760	980	380	1020	270	130	High doors, Handle height 1020	2171 - 2400
B298	2170	760	605	380	1020	415	130	Low doors, Handle height 1020	1755 - 1880
B002	2170	760	730	380	1050	260	160	Standard doors, Handle height 1050	1882 - 2170
B166	1855	760	730	380	952	—	—	For apartment entrance doors, faceplate rounded	1882 - 2170

* The material numbers of the standard versions are listed on pages 7 - 8.
For orders/enquiries with different size variants, please use the form on pages 20 - 21

Rear backset

	PVC doors	Metal doors	Timber doors
GENIUS	17.5	17.5	23.5
AS 3500 / AS 3600	17.5	17.5	17.5

All dimensions are in mm

Select multi-point locks



GENIUS PANIC multi-point locks

You will find electromechanical multi-point locks for use in escape and rescue route doors in accordance with EN 179 and EN 1125 in the separate [Product catalogue „Life saver“](#).

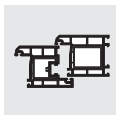

GENIUS multi-point locks for PVC doors

GEN AS 2600, 10 mm spindle square, 92 mm PZ dimension, size variant B001

Backset	Flat face plate 16 mm					Flat face plate 20 mm			Flat face plate 24 mm	U-profile faceplate 6 x 24 x 6 mm	
	35 mm	40 mm	45 mm	50 mm	55 mm	45 mm	50 mm	55 mm	45 mm	45 mm	55 mm
Version EA, 2 mm offset soft lock latch	3490310	3494593	3490485	3494772	3487546	3494866	3494890	3494949	3495021	3495125	3495230
Version EA, bevelled soft lock latch	3490366	3494672	3490490	3494846	3497763	3494881	3494936	3497817	3495098	3495152	3495272
Version CA, 2 mm offset soft lock latch	3490311	3494594	3490500	3484174	3487533	3494867	3494891	3498346	3490483	3490502	3495231
Version CA, bevelled soft lock latch	3490367	3494673	3494734	3494847	3497764	3490487	3494937	3494992	3495099	3490486	3495273
Version EB, 2 mm offset soft lock latch	3490312	3494595	3490278	3494773	3487558	3494868	3494892	3494951	3495022	3490503	3495232
Version EB, bevelled soft lock latch	3490368	3494674	3490491	3494848	3497765	3494882	3494938	3494993	3495100	3490492	3495274
Version CB, 2 mm offset soft lock latch	3490313	3494596	3490484	3484175	3497718	3494869	3494893	3499878	3495023	3495126	3495233
Version CB, bevelled soft lock latch	3490369	3494675	3490488	3494849	3497766	3490489	3494939	3497818	3495101	3495153	3495275



GENIUS multi-point locks for timber doors

GEN AS 2600, 10 mm spindle square, 92 mm PZ dimension, size variant B001

Backset	Flat face plate 20 mm		U-profile faceplate 10 x 30 x 10 mm
	55 mm	65 mm	65 mm
Version EA, 2 mm offset soft lock latch	3494949	3490193	—
Version EA, bevelled soft lock latch	3497817	3490049	3490107
Version CA, 2 mm offset soft lock latch	3498346	3497714	—
Version CA, bevelled soft lock latch	3494992	3490050	3462040
Version EB, 2 mm offset soft lock latch	3494951	3490194	—
Version EB, bevelled soft lock latch	3494993	3490051	3490108
Version CB, 2 mm offset soft lock latch	3499878	3497717	—
Version CB, bevelled soft lock latch	3497818	3490052	3459760



GENIUS multi-point locks for metal doors

GEN AS 2600, 8 mm spindle square, 92 mm distance

Size variant B001
Flat face plate 24 mm

Size variant K002
U-profile faceplate 6 x 24 x 6 mm

Backset	35 mm	45 mm
Version EA, bevelled soft lock latch	3455896	3497830
Version CA, bevelled soft lock latch	3456505	3497831
Version EB, bevelled soft lock latch	3447534	3498905
Version CB, bevelled soft lock latch	3449700	3497832

35 mm	45 mm
3497819	3497823
3497821	3497825
3497820	3497824
3497822	3497826



Automatic multi-point locking systems for metal doors

AS 3500, 8 mm spindle square, 92 mm distance with SKG stamp, matt brushed stainless steel faceplate

Size variant B001
Flat face plate 24 mm

Size variant K002
U-profile faceplate 6 x 24 x 6 mm

Backset	35 mm	45 mm
Version bevelled soft lock latch	3482607	3482527

35 mm	45 mm
3482399	3482403



Automatic multi-point locking systems for metal doors

AS 3600, 8 mm spindle square, 92 mm distance with SKG stamp, bright zinc-plated faceplate

Size variant K001
Flat face plate 24 mm

Size variant K001
U-profile faceplate 6 x 24 x 6 mm

Backset	35 mm	45 mm
Version bevelled soft lock latch	3507179	3507183

35 mm	45 mm
3507197	3507201



Automatic multi-point locking systems for timber doors

AS 3600, 10 mm spindle square, 92 mm distance, size variant B001, with SKG stamp, bright zinc-plated faceplate

Flat face plate 20 mm

U-profile faceplate
10 x 30 x 10 mm

Backset	55 mm	65 mm
Version 2 mm offset soft lock latch	3505371	3505377
Version bevelled soft lock latch	3505046	3505047

65 mm
—
3505063

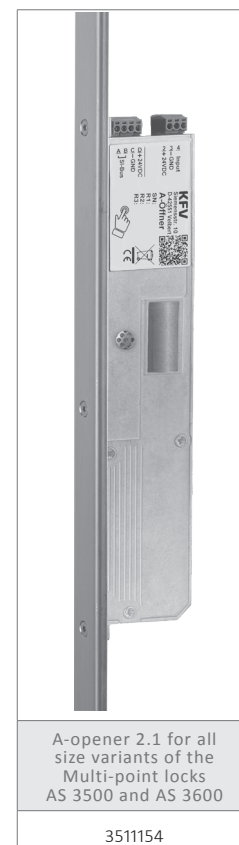

A-opener 2.1 for all size variants of the Multi-point locks AS 3500 and AS 3600

3511154

Configuration in four steps

- Step 1:** Magnet on the frame side for the reed contact (only required for GENIUS).
- Step 2:** Power supply
- Step 3:** Cable transfer
- Step 4:** Access control system

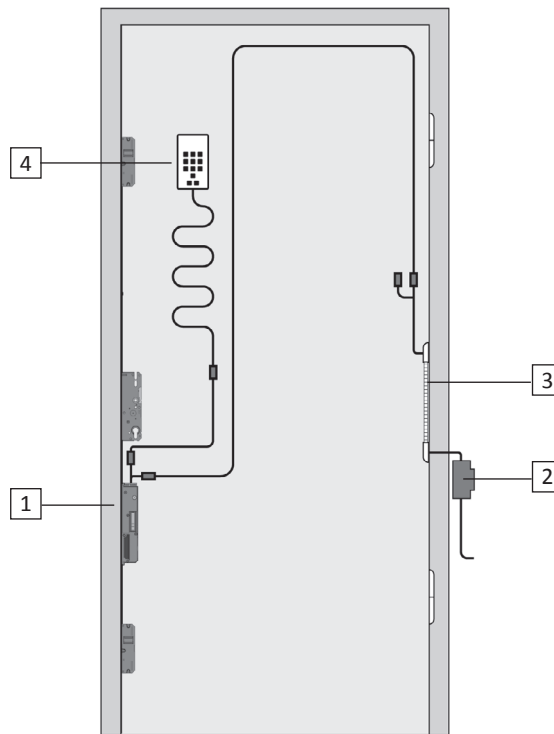

Step 1: Select magnet



A magnet is not required if an A-opener is used.

Round magnet bush



Magnet bush for drilling into a locking rail or into a timber profile.

3381675

Oval magnet bush



Magnet bush for installation in a round bolt strike plate 23xx, you can find matching frame parts in the multi-point locks catalogue.

3384792

Self-adhesive magnet



Magnet to be adhered into place

3405940

Step 2: Select power supply

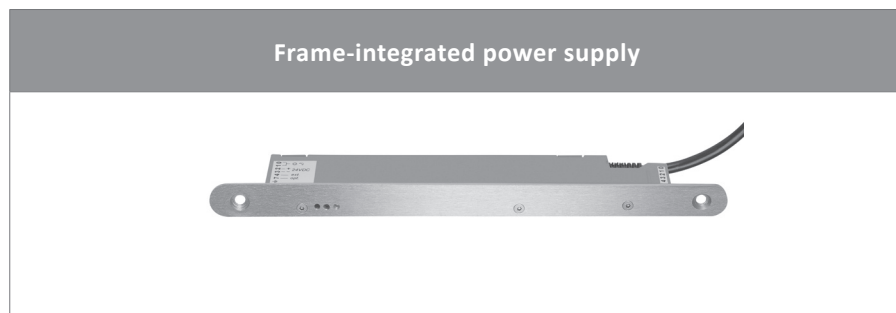

The power supply is designed to be installed in the door frame (milling required), suitable for GENIUS or A-opener and KfV access control systems.
Shield length 320 mm brushed matt stainless steel.

Casing dimensions (H x W x D)
245 mm x 20 mm x 35 mm

Input voltage: 115 up to 230 V AC; 50 / 60 Hz

Output voltage: 24 V DC / max. 0.9 A

A 12 V AC/DC switching signal (from the electric door opener or E-opener) can be used as an opening signal for GENIUS.

Flat face plate 20 mm, rounded **3498971**
Flat face plate 24 mm, rounded **3498972**

Flat face plate 20 mm, edged **3499718**
Flat face plate 24 mm, edged **3499715**

U-profile faceplate 6 x 24 x 6 mm **3498973**
U-profile faceplate 10 x 30 x 10 mm **3499717**

Special versions for separable cable transfer with extended faceplate and concealed connector fixing

Flat face plate 20 mm, rounded **3499719****
Flat face plate 24 mm, rounded **3499720****

** You can find the matching cable transfer with the material numbers **3499574** and **3499584** below.



The power supply is designed to be installed on a standardised top hat rail (35 mm), suitable for GENIUS or A-opener and KfV access control system.

Casing dimensions (H x W x D)
approx. 91 mm x 54 mm x 56 mm

Input voltage: 90 to 264 V AC; 50 / 60 Hz
Output voltage: 24 V DC / 60 W

3509884

Step 3: Select cable transfer

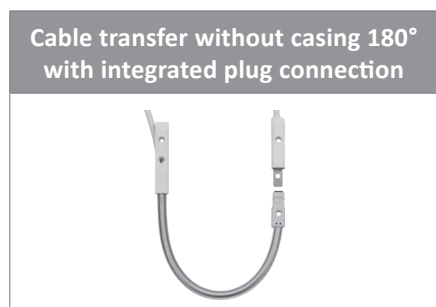

Cable transfer for concealed door rebate installation

11 x 220 x 8.5 mm (W x H x D)

Plug connection frame side*: **3496920**
Door side: 4 m, frame side: 8 m

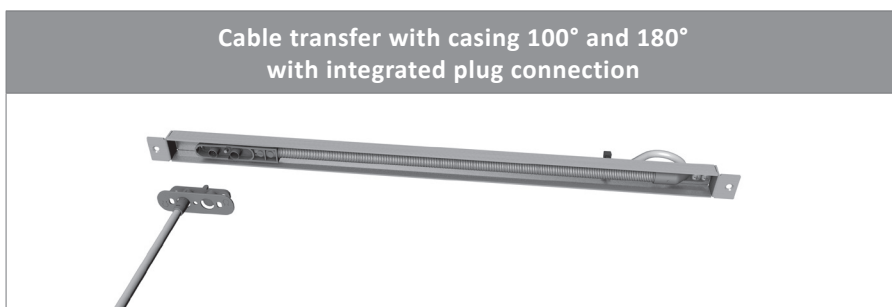

Cable transfer 100° for concealed door rebate installation.

24 x 302 x 18 mm (W x H x D)

Fitting case frame side:
Door side: 3 m, frame side: 8 m **3484333**
Door side: 4 m, frame side: 8 m **3484334**

Fitting case door side:
Door side: 3 m, frame side: 8 m **3484332**

Special versions to combine with the frame integrated power supply

Fitting case door side:
Door side: 3 m, frame side: 0.10 m **3499575**

Cable transfer 180° for concealed door rebate installation.

24 x 480 x 18 mm (W x H x D)

Fitting case frame side:
Door side: 3 m, frame side: 8 m **3475148**
Door side: 4 m, frame side: 8 m **3475149**

Fitting case door side:
Door side: 3 m, frame side: 8 m **3475147**

Special versions to combine with the frame integrated power supply

Fitting case door side:
Door side: 3 m, frame side: 0.10 m **3499574**
Door side: 3 m, frame side: 0.75 m **3499584**



Cable transfer 100° for concealed door rebate installation. The casing can be mounted in the door frame or the door leaf.

24 x 260 x 18 mm (W x H x D) **3308791**

Cable transfer 180° for concealed door rebate installation. The casing can be mounted in the door frame or the door leaf.

24 x 480 x 18 mm (W x H x D) **3308792**



The cable is equipped with a plug connection. It is used to transmit power or signals from the power supply to the GENIUS or A-opener motor. It is combined with a type B cable.

- pre-assembled on the motor side
- numbered
- with plug
- 6-wire
- shielded

Cable length 3 m **3381525**
 Cable length 4 m **3381527**
 Cable length 5 m **3381529**



The cable is equipped with a plug connection. It is used to transmit power or signals from the power supply to the GENIUS or A-opener motor. It is combined with a type F cable.

- pre-assembled on the power supply side
- numbered
- with bushing
- 6-wire
- shielded

Cable length 4 m **3308723**
 Cable length 6 m **3308724**
 Cable length 8 m **3308725**
 Cable length 12 m **3368937**

Assembly aid for cable transfers

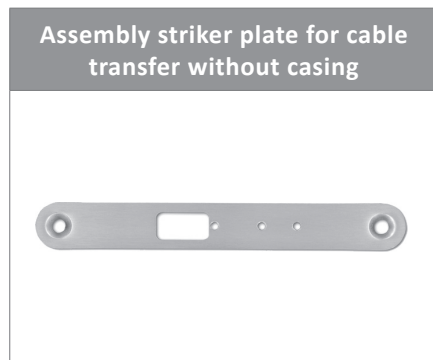

For installation in timber and PVC doors with 16 mm hardware groove eurogroove.

16 x 126 x 3 mm (W x H x D) **3508204**



For installation in PVC doors.

16 x 96 x 3 mm (W x H x D) **3498533**

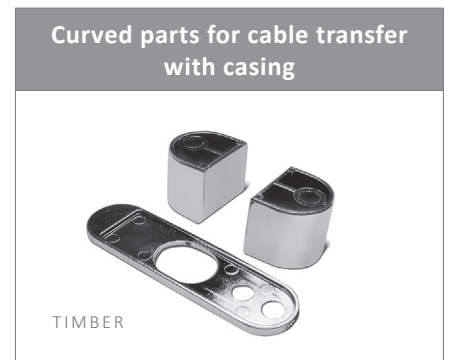

Assembly accessories for the installation of concealed cable transfers in timber doors.

24 x 302 x 18 mm (W x H x D) **3443749**

All details relating to length in metres (m) on this page refer to the cable lengths.

Step 4: Select access control system

WLAN module 2.0

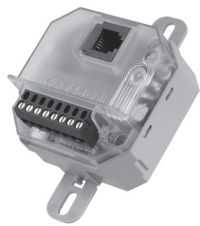

WLAN module to control GENIUS multi-point locks type A, type B and A-openers.

- Supply voltage: 12-24 V DC
- Two relay outputs
- One input
- Can be operated via the SIEGENIA Comfort app

WLAN module 2.0

3510885

SIEGENIA Comfort app for WLAN module



Operation of the WLAN module

- Opening the GENIUS or the A-opener
- Adjustment of the opening duration
- Adjustment of the access function
- Mode changeover for day/night function*
- Status display*

*only in conjunction with GENIUS type B

Fingerprint Scanner 3.1



The biometric access control system is used to open the door. Incl. pre-assembled cable (approx. 1.5 m) with plug and keypad and decoration element.

- Incl. pre-assembled cable (approx. 1.5 m) with plug
- Up to 99 memory slots can be programmed
- Can be operated via the ekey home app

Fingerprint scanner 3.1

3501219

ekey home app for fingerprint scanner 3.1

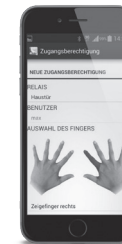

Management and administration of the fingerprint scanner 3.1.

- Create new users and access authorisations
- Administration of user and access authorisations
- Blocking users
- Deleting users
- Adjustment of illumination
- Available for iOS and Android

io lock controller 2.0



io lock controller 2.0 for somfy TaHoma

- Supply voltage: 8-24 V DC
- Two relay outputs
- Two inputs
- Can be operated via TaHoma by Somfy app

io lock controller 2.0

3504784

TaHoma by Somfy app for io lock controller 2.0



Operation of the io lock controller

- Opening the GENIUS or the A-opener
- Status display*

• Available for iOS and Android

*only in combination with the optionally available bolt switch contact, see page 14

KFVkeyless



The access control system is used to open the door with a Bluetooth-enabled mobile phone or smartphone. It can be kept in your pocket. Incl. pre-assembled cable (approx. 1.5 m) with plug and keypad.

- Simple coupling between KFVkeyless and a mobile phone or smartphone
- Encrypted AES 128Bit data transmission
- Up to 6 Bluetooth devices can be coupled
- Up to 18 keypad code users

3493375

KFVkeyless app

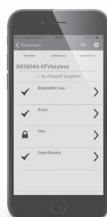

The app is designed to manage and administer the KFVkeyless module. Enables the administration of the coupled smartphone via app.

- Administration of up to 6 KFVkeyless modules is possible
- Activation of the contactless opening
- User administration/range
- Blocking/deleting users
- Change or delete the keyboard code
- Display access log
- Adjust illumination / of the beeper
- Available for iOS and Android

Glass faceplate for keypad



Optional for KFVkeyless. Mount with double-sided adhesive sealing tape.

- High-quality appearance
- Flush installation possible
- Available in 3 colours

Cover white **3497827**
 Cover anthracite **3497828**
 Cover silver (standard) **3497829**

2 channel handheld wireless transmitter



The 2 channel handheld wireless transmitter is used to transmit the data to the wireless receiver.

- Individually programmable buttons
- Suitable for opening up to 2 doors
- Colour: grey / white

3377395

External wireless receiver



The external wireless receiver is used to receive data from the wireless hand-held transmitter.

- Supply voltage 24 V DC
- Range of the wireless receiver is 10 to 50 m
- Up to 84 handheld wireless transmitters can be programmed

3377393

Cable type E



The type E cable is used to transmit power or signals from the external wireless receiver. Pre-assembled on both sides and fitted with wire-end ferrules.

Cable length 1 m **3378077**
 Cable length 4 m **3378078**
 Cable length 8 m **3378079**
 Cable length 12 m **3378080**

Transponder aerial



The transponder aerial is used to transmit the data to the transponder reader. Transponder aerial (reader) incl. LEDs for the inside and outside of the door (IP 67). Incl. cable, length of cable: 2 m. Silver cover cap. Installation can be visible or concealed. Up to 3 aerials (readers) can be connected in parallel.

3406518

Transponder reader



The external transponder is used to receive data from the transponder aerial. The 12 or 24 V AC/DC supply voltage can be drawn from the GENIUS power supply. Up to 99 transponder keys can be programmed.

3406512

Transponder key (range approx. 6 cm)

3406519

Cable type E



The type E cable is used to transmit power or signals from the external wireless receiver. Pre-assembled on both sides and fitted with wire-end ferrules.

Cable length 1 m **3378077**
 Cable length 4 m **3378078**
 Cable length 8 m **3378079**
 Cable length 12 m **3378080**

Select accessories

Coupling relays 12 V and 24 V



The 12 V coupling relay is used for retrofitting the E-opener to GENIUS or the A-opener.

12 V AC / DC; top hat rail mounting **3327769**

The 24 V coupling relay is used to confirm the GENIUS TYPE B to an alarm system or a motorised door drive.

24 V AC / DC; top hat rail mounting **3374274**

Button interior side of door



The button is used to open the door via the interior side of the door for multi-point locks without the "comfort" option (GENIUS EA / EB).

- Button made from matt stainless steel
- Dowels included
- Snap-in installation

Cable length 0.75 m **3386310**
 Cable length 1.00 m **3413891**

Clock timer



The clock timer is used to change modes of operation in the day/night function on the GENIUS TYPE B.

- With gold-plated relay contact (230 V AC)
- Top hat rail version
- Display illumination
- 56 memory slots
- 10 year power reserve (lithium battery)
- ON-OFF switching times
- Continuous circuit ON / OFF
- VDE

Casing dimensions (H x W x D)
 approx. 90 mm x 36 mm x 69 mm
 input voltage:
 230 to 240 V AC; 50 / 60Hz

3308731

Bolt switch contact



The bolt switch contact is used to query whether the hook bolt has been completely locked off.

- Installation in the locking rail or striker plate
- Replaces the Q-adjustment
- The Q-adjustment function is retained
- Protection class in accordance with DIN 40050 VdS environmental class III, IP 67
- Contact type: changeover contact
- Switching capacity max. 3 W / VA
- Switching voltage max. 30 V DC
- Switching current max. 0.2 A
- Installation location for external and internal doors
- Switching point adjustable
- Certification VdS class C G 114009
- Several bolt switch contacts can be connected in series

Cable length 6 m **3496082**
 Cable length 10 m **3501530**

Test unit PG03



The test unit is used to check / perform error analysis of the A-opener, GENIUS TYPE A and TYPE B as well as GENIUS PANC from version 2.1.

Test unit 115-230 VAC for A-opener, GENIUS A and B as well as GENIUS PANIC **3509874**

To use the test unit, you will require an additional adapter cable that matches the components used:

- Adapter for test unit, cable type B, 4 m **3509878**
- Adapter for test unit, plug-in cable transfer 100/180 degree, 4 metre **3509879**
- Adapter for test unit, cable transfer Mini **3509880**
- Adapter for test unit, cable type E, 4 m **3509881**
- Adapter for test unit, cable type K, 4 m **3509882**
- Adapter for test unit, Plug and Play **3509883**

Components for fire doors



Special versions must be used when GENIUS multi-point locks are installed in fire doors. Please contact our sales dept. to define the version required in your special case.

Cable transfer concealed with 20 mm casing 180°



Cable transfer for concealed door rebate installation. The casing can be mounted in the door frame or the door leaf.

20 x 382 x 16 mm (W x H x D) **3458247**

Optional:

Curved parts for cable transfer with casing

20 x 302 x 18 mm (W x H x D) **3458254**

Fire protection cable type OK - FS



The cable is used to transmit power or signals from the power supply or emergency power supply to the GENIUS or A-opener motor.

- pre-assembled on both sides and fitted with wire-end ferrules
- numbered on both sides
- 6-wire
- shielded
- Length: 12 m

3474871

Power supply with emergency power supply



The emergency power supply is designed for wall mounted installation, suitable for GENIUS or A-opener and KfV access control system. Mandatory when using GEP GENIUS PANIC-multi-point locks in fire doors.

Casing dimensions (H x W x D)
approx. 350 mm x 230 mm x 85 mm

Input voltage: 230 V AC; 50 / 60 Hz
Output voltage: 24 V DC / max. 2 A

LED status indicators, relay outputs for AC and rechargeable battery errors. **3471104**

To be ordered separately: 2 rechargeable batteries 7Ah / 12 Volt **3470680**

Plug and Play sets for timber doors

Basic components

The basic components for all Plug and Play sets consist of:

Adapter for the GENIUS A electromechanical drive or A-opener

- Connection cable between drive and cable transfer
- Both position magnets in round and oval version (the installation of one magnet is omitted if an A-opener is used)

Plug and Play set A

- Basic components*
- Frame power supply
- Preassembled cable transfer 180° with 20 mm casing
- KfVkeyless Bluetooth keypad

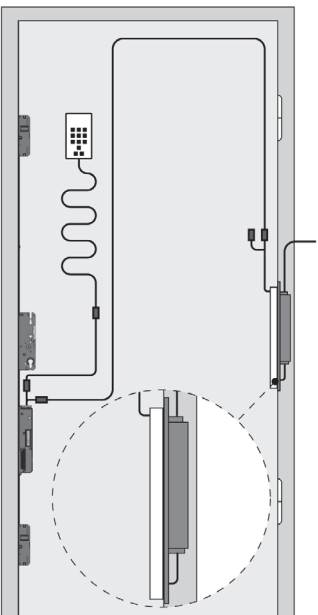

Material number
3505908

Plug and Play set B

- Basic components*
- Frame power supply
- Preassembled cable transfer 180° with 20 mm casing
- Bluetooth fingerprint scanner 3.1

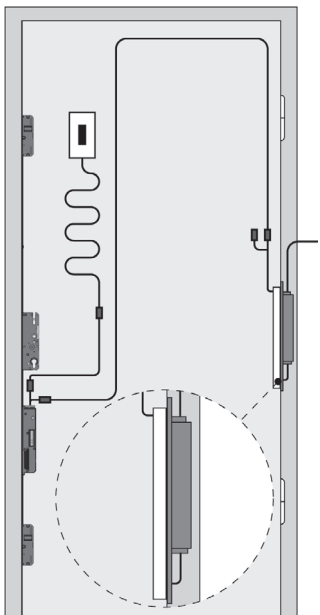

Material number
3505909

Plug and Play set E

- Basic components*
- Top hat rail power supply
- Cable transfer 180° with 20 mm casing
- Connection cable between cable transfer and top hat rail power supply
- KfVkeyless Bluetooth keypad

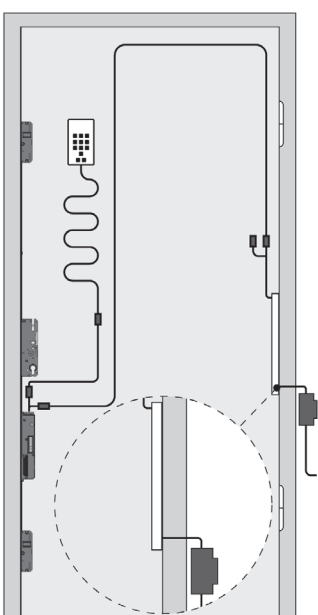

Material number:
3505912

Plug and Play set F

- Basic components*
- Top hat rail power supply
- Cable transfer 180° with 20 mm casing
- Connection cable between cable transfer and top hat rail power supply
- Bluetooth fingerprint scanner 3.1

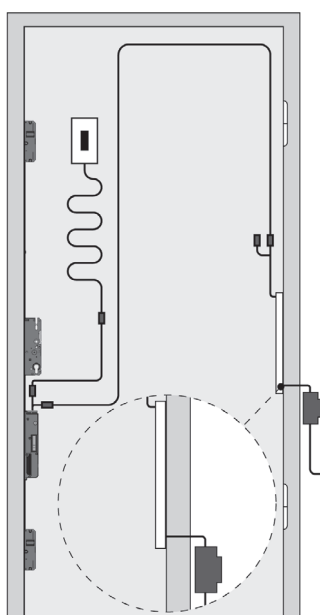

Material number
3505913

Plug and Play sets for aluminium and PVC doors

Basic components

The basic components for all Plug and Play sets consist of:

Adapter for the GENIUS A electromechanical drive or A-opener

- Connection cable between drive and cable transfer
- Both position magnets in round and oval version (the installation of one magnet is omitted if an A-opener is used)

Plug and Play set C

- Basic components*
- Frame power supply
- Cable transfer without casing
- KfVkeyless Bluetooth keypad

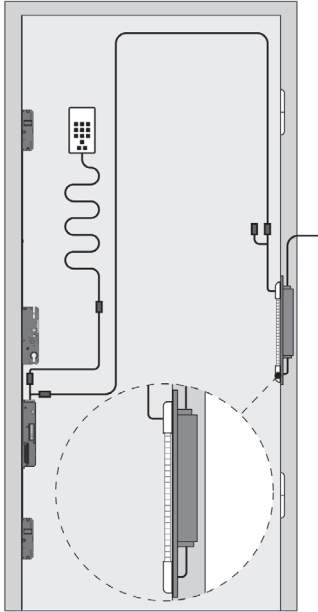

Material number:
3505910

Plug and Play set D

- Basic components*
- Frame power supply
- Cable transfer without casing
- Bluetooth fingerprint scanner 3.1

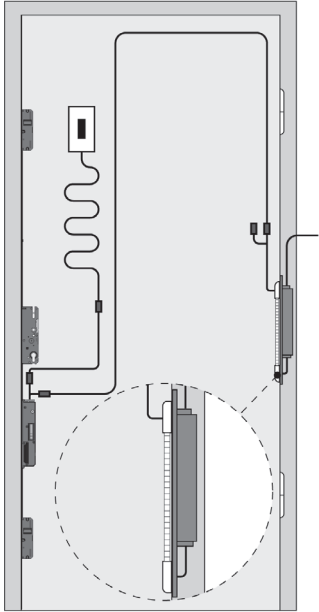

Material number
3505911

Plug and Play set G

- Basic components*
- Top hat rail power supply
- Cable transfer without casing
- Connection cable between cable transfer and top hat rail power supply
- KfVkeyless Bluetooth keypad

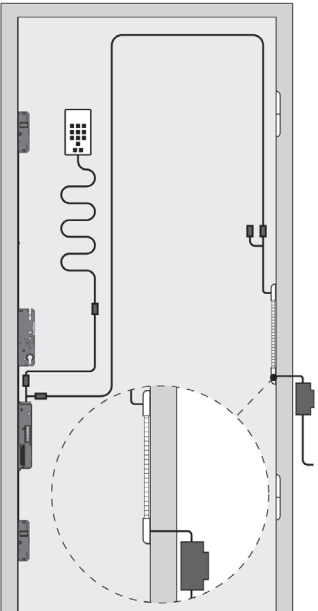

Material number:
3505914

Plug and Play set H

- Basic components*
- Top hat rail power supply
- Cable transfer without casing
- Connection cable between cable transfer and top hat rail power supply
- Bluetooth fingerprint scanner 3.1

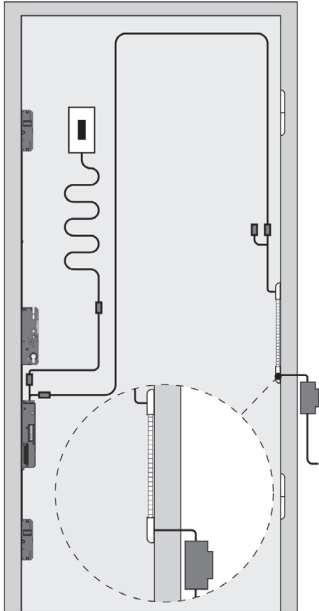

Material number
3505915

Accessories for Plug and Play sets

Accessories and extension modules for Plug and Play solution

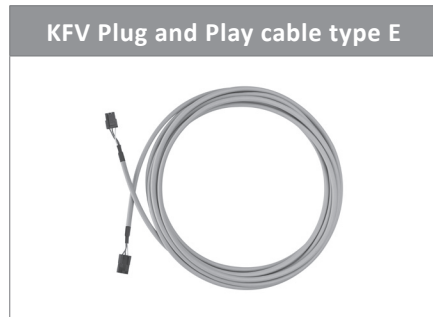

The KFV Plug and Play cable type E is used as a connection cable between the cable transfer and GENIUS or A-opener.

- Cable length 2.5 m **3501870**
- Cable length 3 m **3501871**
- Cable length 4 m **3501872**
- Cable length 5 m **3501873**

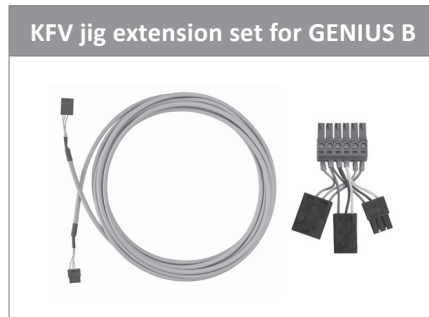

The KFV jig extension set for GENIUS B is used to retrofit a GENIUS A or A-opener Installation on a GENIUS B.

- The jig extension set consists of the Genius B adapter and the Plug and Play cable K, cable length 3 m
- Jig Extension set GENIUS B **3505917**

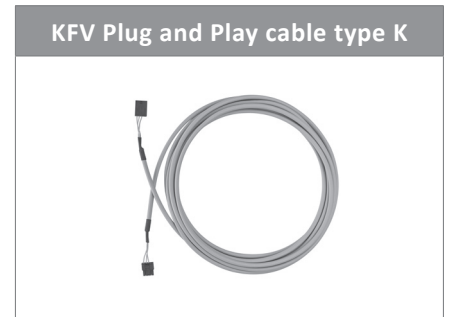

The KFV Plug and Play cable type E is used as a connection cable between the cable transfer and GENIUS or A-opener.

- Cable length 2.5 m **3503983**
- Cable length 3 m **3503984**
- Cable length 4 m **3503985**
- Cable length 5 m **3503986**

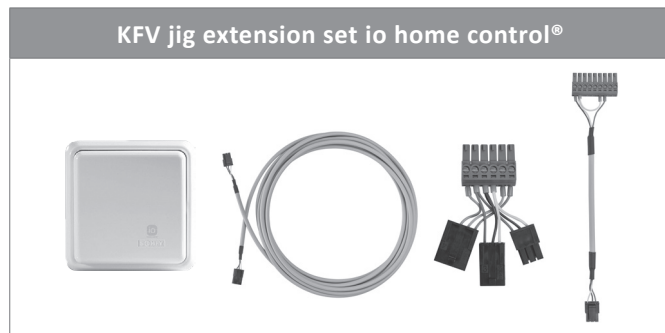

The KFV jig extension set io home control® is used to retrofit a GENIUS A, GENIUS B or A-opener Installation with the io lock controller. The jig extension set consists of io lock controller, adapter io lock controller, adapter GENIUS B and the Plug and Play cable E, cable length 2.5 m

- Jig extension set io home controller® **3505916**



The KFV WLAN module 2.0 is used to retrofit a GENIUS A, GENIUS B or A-opener installation with the WLAN function. A separate Plug & Play variant is not necessary.

- WLAN module 2.0 **3510885**
- Cable length 4 m **3507440**

Plug and Play set for GEZE motorised door drive ECTurn Inside

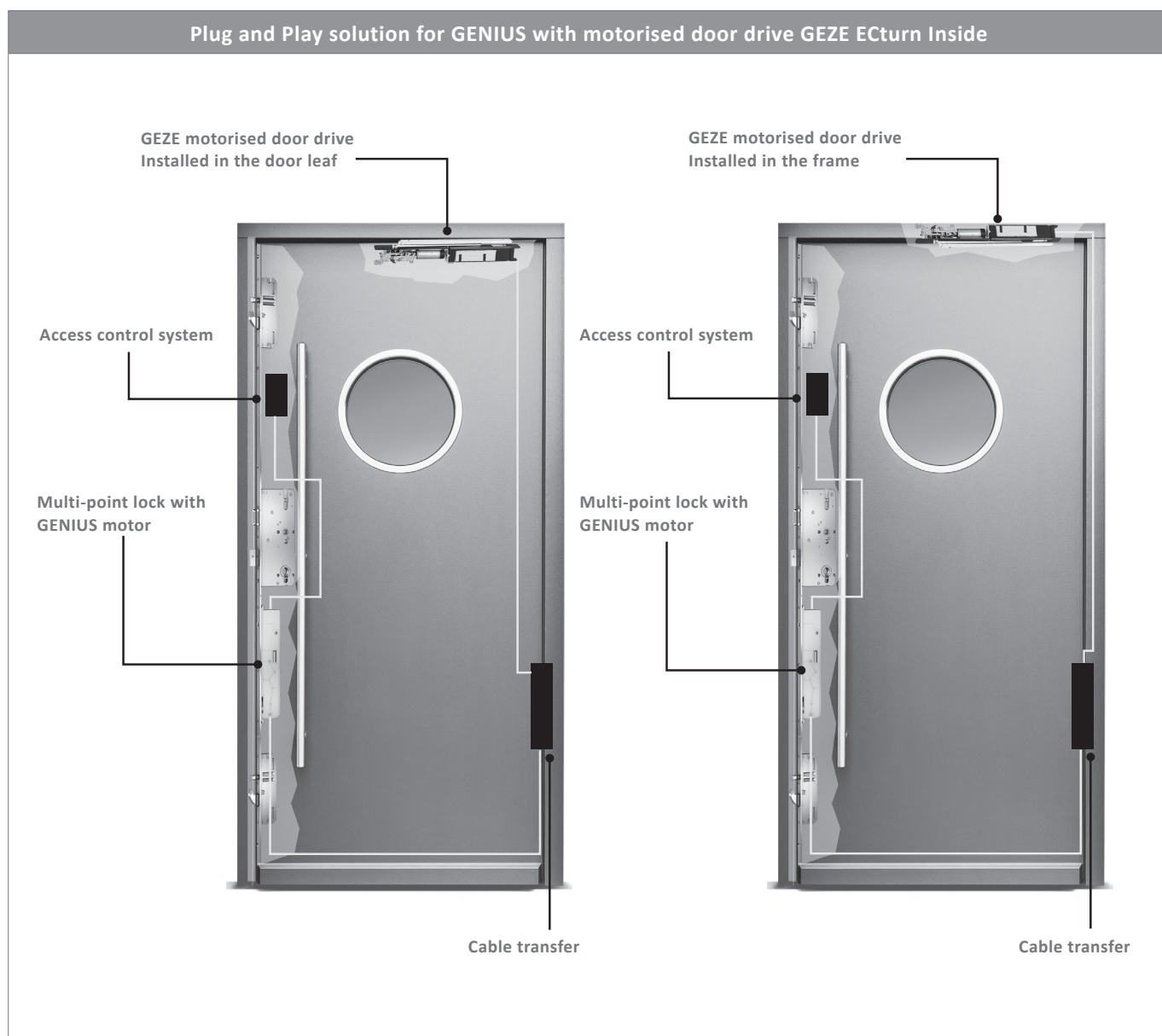

KFV Plug and Play solution for GENIUS and GEZE ECTurn Inside

The KFV Plug and Play solution enables the simple, fast and plug-in installation of the GENIUS in combination with the concealed motorised door drive GEZE ECTurn Inside. The cable set is suitable for the installation of the GEZE motorised door drive ECTurn Inside in the door leaf and in the frame.

With fingerprint scanner 3.1

Fingerprint scanner 3.1 with plug connection, cable length 1.5 m **3501435**

Cable GEZE ECTurn Inside, 1.5 m **3501874**

Cable GEZE power supply, supply voltage, 8 m **3501875**

Adapter for GEZE ECTurn Inside **3502884**

Plug-in cable transfer for GEZE ECTurn Inside,
Opening angle 100° **3501869**

Cable GENIUS, 3 m **3501871**

Adapter GENIUS **3501876**

With KFVkeyless

KFVkeyless with plug connection, cable length 1.5 m **3501140**

Cable GEZE ECTurn Inside, 1.5 m **3501874**

Cable GEZE power supply, supply voltage, 8 m **3501875**

Adapter for GEZE ECTurn Inside **3502884**

Plug-in cable transfer for GEZE ECTurn Inside,
Opening angle 100° **3501869**

Cable GENIUS, 3 m **3501871**

Adapter GENIUS **3501876**

Enquiry/Order form

Enquiry _____ Sets **Order** _____ Sets

Fabricator Retailer _____ Contact partner _____

Telephone _____ Fax _____ E-mail _____

Multi-point locks

Select material number from page 7 - 8 or specify desired variant below.

Attention: If you select a PZ dimensions deviating from 92 mm, please request a drawing of the multi-point lock so that you will be able to carry out the millings in the door properly!

Material number: _____ or Faceplate _____ Backset _____ Spindle square _____ Size variant _____

PZ dimension:

- 72 mm
 74 mm
 92 mm
 94 mm

Latch type:

- soft lock bevelled (SL)
 Soft lock 2 mm offset (SA)
 Fire protection latch bevelled (FS)

- GENIUS AS 2600 / AS 2602 type A without comfort function (EA)
 GENIUS AS 2600 / AS 2602 type A with comfort function (CA)
 GENIUS AS 2600 / AS 2602 type B without comfort function (EB)
 GENIUS AS 2600 / AS 2602 type B with comfort function (CB)
 MFS AS 3500 (only with 92 or 94 mm distance)
 MFS AS 3600 (only with 92 or 94 mm distance)

Step 1: Magnet

Not required if an A-opener is used.

- 3381675** Round magnet bush ZEM MB-A1 **3384792** Oval magnet bush ZEM FZ-MB2 **3405940** Self-adhesive magnet ZEM FZ-MB4

Step 2: Power supply

Frame-integrated power supply

- 3498971** Flat face plate rounded / 20 mm ZEM NT-RA-A0-F-20-A-115-230-41
 3498972 Flat face plate rounded / 24 mm ZEM NT-RA-A0-F-24-A-115-230-41
 3498973 U-profile faceplate 6 x 24 x 6 mm ZEM NT-RA-A0-P6-24-K-115-230-41
 3499715 Flat face plate edged / 24 mm ZEM NT-RA-A0-F-24-K-115-230-41
 3499717 U-profile faceplate 10 x 30 x 10 mm
 ZEM NT-RA-A0-P10-30-K-115-230-41
 3499718 Flat face plate edged / 20 mm ZEM NT-RA-A0-F-20-K-115-230-41

- 3499719** Flat face plate rounded / 20 mm ZEM NT-RA-A1-F-20-A-115-230-41
 3499720 Flat face plate rounded / 24 mm ZEM NT-RA-A1-F-24-A-115-230-41

Attention (3499719 and 3499720): Special version FACEPLATE with perforation for cable transfer

Power supply for top hat rail mounting

- 3509884** Power supply for top hat rail mounting ZEM NT-HU-C0-60W

Step 3: Cable transfer

Cable transfer without casing 180°

- 3496920** 4 m / 8 m ZEM KU-MI-VM-TB-SR-180-A0-F0-4M-B0-8M

Cable transfer with casing 100°

- 3484332** 3 m / 8 m ZEM KU-VM-TB-AT-100-24-A0-F0-3M-B0-8M-VS
 3484333 3 m / 8 m ZEM KU-VM-TB-AR-100-24-A0-F0-3M-B0-8M-VS
 3484334 4 m / 8 m ZEM KU-VM-TB-AR-100-24-A0-F0-4M-B0-8M-VS

Special versions in combination with the frame integrated power supply

- 3499574** 3 m / 0.10 m ZEM KU-VM-TB-AT-180-24-A0-F0-3M-B0-0.10M-VS
 3499584 3 m / 0,75 m ZEM KU-VM-TB-AT-180-24-A0-F0-3M-B0-0.75M-VS
 3499575 3 m / 0.10 m ZEM KU-VM-TB-AT-100-24-A0-F0-3M-B0-0.10M-VS
 3308791 Cable transfer with 24 mm casing 100° ZEM KU-VM-100-24-A0-VS
 3308792 Cable transfer with 24 mm casing 180° ZEM KU-VM-180-24-A0-VS

Assembly aid for cable transfers

- 3498533** Mounting plate for installation in PVC doors
 ZEM MH-KU-VM-MP-16-A0
 3443749 Rounded parts for installation in timber doors
 ZEM MH-KU-VM-RT-24-A0
 3458254 Rounded parts for installation in timber doors
 ZEM MH-KU-VM-RT-20-A0
 3508204 Mounting plate for installation in doors with 16 mm hardware
 groove eurogroove ZEM MH-KU-MI-MP-16-A0

Cable transfer with casing 180°

- 3475147** 3 m / 8 m ZEM KU-VM-TB-AT-180-24-A0-F0-3M-B0-8M-VS
 3475148 3 m / 8 m ZEM KU-VM-TB-AR-180-24-A0-F0-3M-B0-8M-VS
 3475149 4 m / 8 m ZEM KU-VM-TB-AR-180-24-A0-F0-4M-B0-8M-VS

Cable type F

- 3381525** 3 m ZEM KA-F0-3.0M
 3381527 4 m ZEM KA-F0-4.0M
 3381529 5 m ZEM KA-F0-5.0M

Cable type B

- 3308723** 4 m ZEM KA-B0-4.0M
 3308724 6 m ZEM KA-B0-6.0M
 3308725 8 m ZEM KA-B0-8.0M
 3368937 12 m ZEM KA-B0-12.0M

Step 4: Access control system

KFVkeyless:

3493375 KFVkeyless ZEM ZK-KP-AO

Fingerprint scanner

3501219 Fingerprint scanner 3.1 ZEM ZK-FS-C1

WLAN module 2.0

3510885 WLAN module 2.0 ZEM ZK-SM-B0

Wireless

3377393 Wireless receiver ZEM ZK-FE-AO-PB

3377395 2-channel handheld wireless transmitter ZEM ZK-FS-A0

Transponder:

3406512 External transponder ZEM ZK-TI-AO-PB

3406518 Transponder aerial ZEM ZK-TA-AO-2.0M

3406519 Transponder key ZEM ZK-TS-A1

Cable type E (needed for radio system and transponder)

3378077 1 m ZEM KA-E0-1.0M

3378078 4 m ZEM KA-E0-4.0M

3378079 8 m ZEM KA-E0-8.0M

3378080 12 m ZEM KA-E0-12M

Accessories

Signal transmitter

3327769 Coupling relay 12 V ZEM RE-HU-AO-12V

3374274 Coupling relay 24 V ZEM RE-HU-A1-24V

3386310 Button cable length 750 mm ZEM FZ-TA-01-750

3413891 Button cable length 1000 mm ZEM FZ-TA-01-1000

3308731 Clock timer ZEM FZ-ZU-H

Sensors

3496082 Bolt switch contact cable length 6 m ZEM RS-A0-6.0M

3501530 Bolt switch contact cable length 10 m ZEM RS-A1-10M

Test unit and adapter

3509874 Test unit 115-230 VAC for A-opener, GENIUS A, GENIUS B and GENIUS PANIC ZEM PG-CO-EU

3509878 Adapter for test unit cable type B ZEM AD-PG-C-B0-4M

3509879 Adapter for test unit plug-in cable transfer 100/180 degree ZEM AD-PG-C-KU-VM-TB-4M

3509880 Adapter for test unit cable transfer Mini ZEM AD-PG-C-KU-MI-VM-TB-4M

3509881 Adapter for test unit cable type E ZEM AD-PG-C-E0-4M

3509882 Adapter for test unit cable type K ZEM AD-PG-C-K0-4M

3509883 Adapter for test unit Plug and Play ZEM AD-PG-C-PP-8M

Components for fire doors

3458247 Cable transfer with 20 mm casing 180° ZEM KU-VM-180-20-AO-VS

3474871 Cable type OK - FS ZEM KA-K1-12.0M-FS

Emergency power supply

3471104 Emergency power supply ZEM NT-NS-AO-230V

3470680 12V rechargeable batteries for emergency power supply ZEM AK-NS-AO-12V (2 piece are required)

Plug and Play sets

3505908 Plug and Play set A ZEM PP-SE-A-RA-KU-180-KP

3505909 Plug and Play set B ZEM PP-SE-B-RA-KU-180-FS

3505910 Plug and Play set C ZEM PP-SET-C-RA-KU-MI-KP

3505911 Plug and Play set D ZEM PP-SE-D-RA-KU-MI-FS

3505912 Plug and Play set E ZEM PP-SE-E-HU-KU-180-KP

3505913 Plug and Play set F ZEM PP-SE-F-HU-KU-180-FS

3505914 Plug and Play set G ZEM PP-SE-G-HU-KU-MI-KP

3505915 Plug and Play set H ZEM PP-SE-H-HU-KU-MI-FS

Select material number from page 16 - 17 or specify desired components below

Accessories for Plug and Play sets

3501870 Cable length 2.5 m ZEM PP-KA-E0-2.5M

3501871 Cable length 3 m ZEM PP-KA-E0-3.0M

3501872 Cable length 4 m ZEM PP-KA-E0-4.0M

3501873 Cable length 5 m ZEM PP-KA-E0-5.0M

3505917 Jig extension set GENIUS B ZEM PP-SET-GEN-B

3505916 Jig extension set io home controller® ZEM PP-SE-IOHOME

3503983 Cable length 2.5 m ZEM PP-KA-E0-2.5M

3503984 Cable length 3 m ZEM PP-KA-E0-3.0M

3503985 Cable length 4 m ZEM PP-KA-E0-4.0M

3503986 Cable length 5 m ZEM PP-KA-E0-5.0M

3510885 WLAN module 2.0 ZEM ZK-SM-B0

3507440 Cable length 4 m ZEM PP-KA-KO-NT-RA-4M

Plug and Play set for GEZE motorised door drive Ecturn Inside

3501435 Fingerprint scanner 3.1 with plug connection, cable length 1.5 m ZEM PP-ZK-FS-C1

3501140 KFVkeyless with plug connection, cable length 1.5 m ZEM PP-ZK-KP-AO

3501874 Cable GEZE Ecturn Inside, 1.5 m ZEM PP-KA-DT-ECTURN-AO-1.5M

3501875 Cable GEZE power supply supply voltage, 8 m ZEM PP-KA-NT-ECTURN-AO-8.0M

3502884 Adapter for GEZE Ecturn Inside ZEM PP-AD-DT-ECTURN-AO

3501869 Plug-in cable transfer for GEZE Ecturn Inside, opening angle 100° ZEM PP-KU-DT-ECTURN-AO

3501871 Cable GENIUS, 3 m ZEM PP-KA-E0-3.0M

3501876 Adapter GENIUS ZEM PP-AD-GE-AO

www.siegenia.com



SIEGENIA[®]
brings spaces to life