

RAYHACK®

Kienbock Radial Shortening System

SURGICAL TECHNIQUE



Surgical Technique as described
by John M. Rayhack, MD

WRIGHT.

RAYHACK®

Kienbock Radial Shortening System

SURGICAL TECHNIQUE

Contents

| | | |
|-------------------|-----------|--|
| | | RAYHACK® Kienbock Radial Shortening System Surgical Technique |
| Chapter 1 | 4 | STEP 1 - Placement of the Kienbock Saw Guide |
| | 5 | STEP 2 - Positioning of the Straight Drill Guide <ul style="list-style-type: none">- Width of the Radial Osteotomy and Anticipated Linear Shortening |
| | 6 | STEP 3 - Performing the Oblique Radial Shortening Osteotomy |
| | 7 | STEP 4 - Kienbock Bone Plate Fixation <ul style="list-style-type: none">- Application of the Compression Device |
| | 8 | STEP 5 - Compression of the Radial Osteotomy |
| | 9 | STEP 6 - Drilling the 22 Degree Interfragmentary Lag Screw Hole |
| | 10 | STEP 7 - Oblique 2.7mm Interfragmentary Lag Screw Application <ul style="list-style-type: none">- Drilling of the Two Distal Screw Holes |
| | 11 | STEP 8 - Final Fixation of the Radial Osteotomy <ul style="list-style-type: none">- Kienbock Radial Osteotomy with Neutral Ulnar Variance |
| | 12 | <ul style="list-style-type: none">- Post-Operative Care- Care and Cleaning of the Instruments |
| Appendix 1 | 13 | RAYHACK® Kienbock Radial Shortening System Instrumentation |
| Appendix 2 | 14 | RAYHACK® Kienbock Radial Shortening System Saw Blade Guide |
| | 15 | Ordering Information |

Proper surgical procedures and techniques are the responsibility of the medical professional. The following guidelines are furnished for information purposes only. Each surgeon must evaluate the appropriateness of the procedures based on his or her personal medical training and experience. Prior to use of the system, the surgeon should refer to the product package insert for complete warnings, precautions, indications, contraindications and adverse effects. Package inserts are also available by contacting Wright Medical Technology, Inc.

RAYHACK® Kienbock Radial Shortening System Surgical Technique

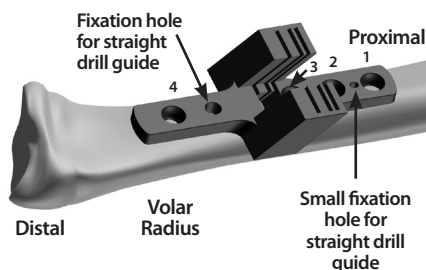

FIGURE 1

STEP 1 - Placement of the Kienbock Saw Guide

A volar approach is used to expose the radius. The distal end of the saw guide is placed just at the origin of the volar flare of the radius.

Due to the flare of the volar surface of the radius, the saw guide is inhibited from being placed too far distally in this approach. The radial osteotomy should be placed far enough proximally to avoid cutting into the distal radial-ulnar joint. | **FIGURE 1**

Protect all soft tissues from potential injury from the saw blade, drill bits, depth gauge, and taps. The median nerve is especially vulnerable and must be identified and protected.

The saw guide does not “capture” the saw blade in the Kienbock osteotomy system. The saw blade serves as its own guide once it enters the radius. Soft tissues must be protected from the saw blade on the medial and lateral sides as well as the dorsal cortex of the radius, and underlying tissues.

To judge approximate saw guide placement, first apply the Kienbock plate (after contouring) to the volar radius. Make sure the two distal plate holes are aligned to permit good bone purchase. Mark hole number two on the bone, then align the saw guide’s hole #2 over this mark.

NOTE: This precision oblique radial levelling procedure is not recommended for Lichtman stage IV Kienbock’s disease (Radial-Carpal Arthritis).

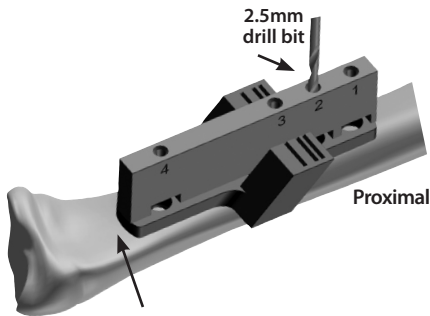

Distal NOTE: The distal end of the Kienbock saw guide is placed at the beginning of the radial volar flare. See Step 1 for the method to choose this saw guide placement position.

FIGURE 2

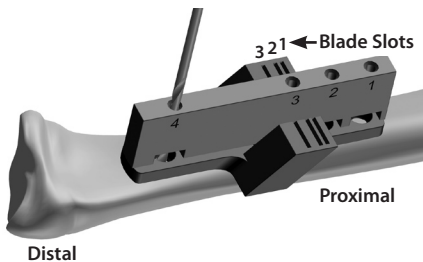

FIGURE 2A

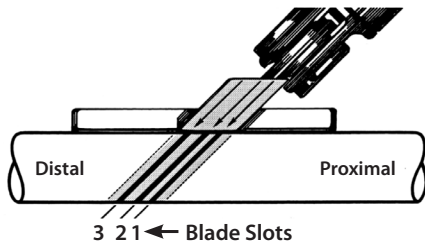

FIGURE 3

STEP 2 - Positioning of the Straight Drill Guide

Manually hold the saw guide centered over the radius, then drill hole #2 with a 2.5mm drill bit through the straight drill guide. The proximal portion of the straight drill guide has a small prong proximally and a larger prong distally to allow proper positioning on the saw guide.

Proper depth measurement of the screw holes is critical. The screws holding the saw guide will also be used to hold the Kienbock plate in position. Excessively long screws may be palpable on the patient's dorsal forearm.

Remove the drill guide, tap hole #2 with a 3.5mm tap and then measure the screw depth. Place the appropriate size screw in hole #2. | **FIGURE 2** (This avoids proximal-distal shifting of the saw guide.) Reapply the drill guide and drill hole #4. **Ensure the saw guide remains centered on the radius** and does not displace medially or laterally.

Measure, tap, and insert screw #4. | **FIGURE 2A** Once the saw guide is firmly attached, drill and tap screw holes #1 and #3, and gently apply the appropriately sized screws.

Do not overtighten the fixation screws (#1-#4) of the saw guide. This could lead to stripping of the screw head sockets upon removal of the saw guide. Self-tapping screws are not advisable.

Width of the Radial Osteotomy and Anticipated Linear Shortening

The stated distances between the slots are measured perpendicular to the osteotomy surfaces and represent the actual machined distances in the saw guide. The anticipated linear shortening of the bone; calculated as the hypotenuse of the right triangle is this perpendicular measurement times the square root of 2: (1.4142). Due to various clinical factors (amount of plate pre-bending, use of the specified saw blade, degree of linear compression, etc.) the actual degree of bone shortening may be slightly less than the anticipated linear shortening. | **FIGURE 3 AND 3A**

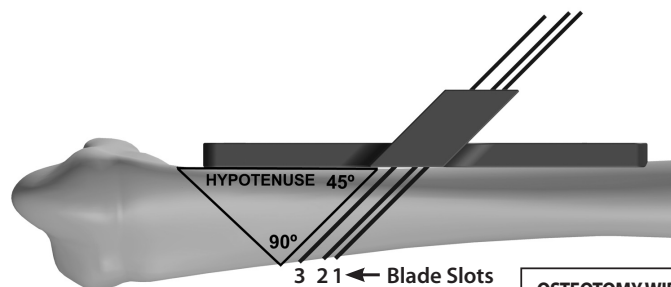

FIGURE 3A

| OSTEOTOMY WIDTH (Perpendicular to Osteotomy Surface) | ANTICIPATED SHORTENING |
|--|---------------------------|
| Slots 1-2 2.0mm | 2.8mm |
| Slots 2-3 3.0mm | 4.2mm |

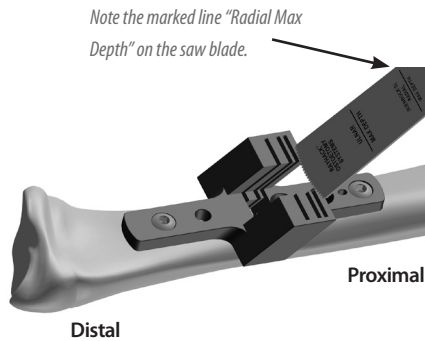

FIGURE 4

STEP 3 - Performing the Oblique Radial Shortening Osteotomy

Once the amount of bone to be removed is determined, the appropriate slots to be used are chosen according to **FIGURE 3A** on the previous page.

Slots 1 and 3 should not be used together to perform any osteotomy in this radial levelling procedure.

IMPORTANT: To create two parallel bone cuts, it is recommended that the distal cut be made first 50% of the way through the radius. Cut through the proximal slot with a 50% bone cut. Continue the distal cut 75% and then the proximal cut 75% in this order. Complete the distal cut and then the proximal cut. **Always complete the distal cut first.** This will help to maintain two parallel bone cuts without the saw blade “glancing” into the distal cut surface from the proximal cut. Carefully observe these steps visually to assure parallel bone cuts. | **FIGURE 4**

It is important to protect all soft tissues from the cutting area. The median nerve is particularly vulnerable in this procedure.

Periosteum must be stripped off the radius at the osteotomy site only. **It is important to irrigate with sterile slush to cool the bone** during the cutting procedures in order to minimize bone necrosis.

Only use a LINVATEC/HALL®, MICROAIRE® or STRYKER® sagittal saw. A pencil grip saw is advised while battery-operated saws are not.

Failure to use one of the two specific saw blades provided with the set may damage the saw guide and result in non-parallel bone surfaces.

Only pass the saw blade beyond the line marked “Radial Max Depth” on the saw blade with extreme care. The surgeon may allow this line to pass the top of the Kienbock saw guide a few millimeters to complete the osteotomy of a large caliber radius. Failure to pay strict attention to this detail may result in soft tissue and bone damage.

Once both osteotomy cuts are made, all screws are removed and placed in the appropriately numbered temporary holding slots in the tray. The osteotomy bone fragment is removed.

In removing the Kienbock saw guide, there may be a great deal of tension on the screws. **Carefully apply the screwdriver and apply dorsal forearm counter-pressure to avoid stripping of the 2.5mm hex slot in the screw head.** If the screw head socket becomes “stripped” and the saw guide cannot be removed, it may be necessary to carefully remove the screw head with screw removal instrumentation. (Not provided by Wright).

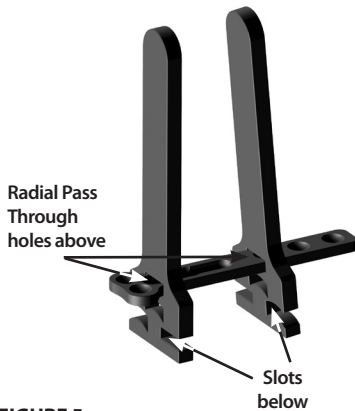

FIGURE 5

STEP 4 - Kienbock Bone Plate Fixation

Due to the volar flare of the radius the surgeon should slightly pre-bend the radial plate to the concave contour of the radius. This may be performed at the beginning of the procedure prior to the saw guide placement and marking of the radius.

Bending the plate is facilitated by using the specialized RAYHACK® plate benders. The unique Pass Through slots in the benders will help minimize plate scratching. Avoid torquing the plate benders to prevent longitudinal and rotational distortion of the plate. | **FIGURE 5**

The plate's elongated slot is positioned distally on the radius.

Affix the plate by reapplying screws #1 and #2 respectively taken from the temporary holding slots in the tray. These two screws should be firmly tightened at this time.

| **FIGURE 5**

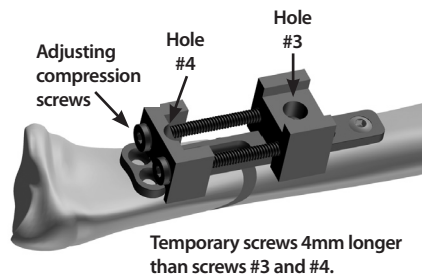

FIGURE 6

Application of the Compression Device

Place the compression device on the plate over the osteotomy site.

For approximate spacing of the compression device, place it over the saw guide. Loosen the compression screws so the holes coincide with the 3rd and 4th holes of the saw guide.

Using two additional 3.5mm cortical screws, affix the compression device through holes #3 and #4 as shown.

These two additional **temporary** screws should be 4mm longer than the measured length of screws #3 and #4 that were used to hold the Kienbock saw guide. It may be easier to apply the screw in hole #4 first and then apply screw #3. | **FIGURE 6**

Ensure the screw at the distal end of the elongated slot of the plate is slightly loose and free to move proximally along the plate slot.

The hex head of the horizontal compression screw has been modified to help prevent "stripping" of the socket over time. Ensure to fully seat the screwdriver shaft into the socket before tightening. This socket should be periodically checked for signs of excessive wear and replaced if necessary.

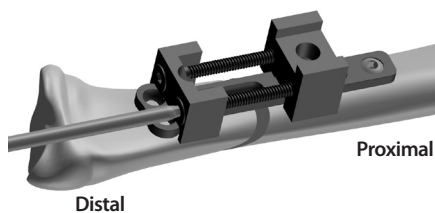

FIGURE 7

STEP 5 - Compression of the Radial Osteotomy

Observe the osteotomy for proper medial-lateral angulation while tightening the compression screws in a clockwise direction. If dissatisfied, back up the adjusting screws counterclockwise and repeat the procedure. If the osteotomy appears to be separating on the opposite cortex (dorsal radial surface), loosen the adjusting screws in the compression device and try loosening cortical screw #4 in the slotted hole and recompress the osteotomy. If this still results in separation of the osteotomy, consider pre-bending the plate an additional small amount. | **FIGURE 7**

A fixed-angle Allen wrench with a 2.5mm hex screwdriver tip may be used to compress the osteotomy. This will need to be removed from the adjusting screw's hex slot with each 90-180 degrees of turning but this should only be necessary over a very short distance. Spacing of the blocks of the compression device should be approximated as noted in **FIGURE 7A** prior to application over the Kienbock plate.

Observe the osteotomy surface while tightening the horizontal compression screws. Alternate between the two adjusting screws to provide even compression.

Once the osteotomy surfaces are visually well-approximated on both sides, stop further compression.

Over compression will only bend the temporary long screws #3 and #4 and will not further compress the osteotomy surfaces. Stripping of screw holes #3 and #4 could occur and prevent drilling of the interfragmentary screw hole through the angled drill guide.

NOTE: Make sure that no soft tissues are interposed between the osteotomy surfaces.

Adjusting Screw Binding: If bone debris causes locking or binding of the adjusting screws, remove the long screws #3 and #4 and remove the compression device. Reapply 28mm or longer screws in holes #3 and #4 through the plate leaving 10mm of screw length exposed. Compress the osteotomy with a Verbrugge or other similar clamp to these screws and manually drill and apply the interfragmentary screw. Apply the two distal screws (see | **FIGURE 10**). Release the clamp and replace the original screws #3 and #4.

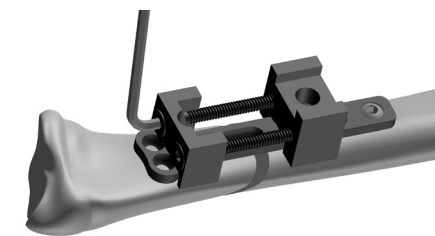

FIGURE 7A

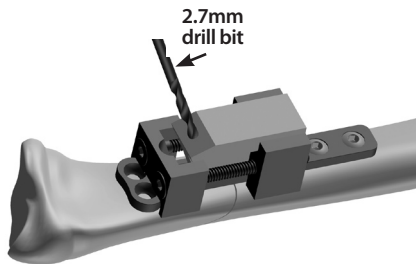

FIGURE 8A

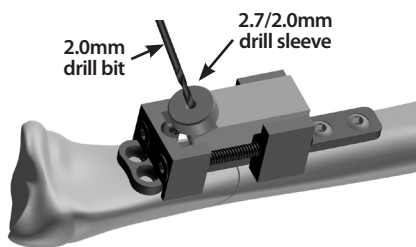

FIGURE 8B

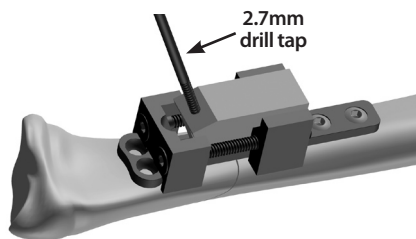

FIGURE 8C

STEP 6 - Drilling the 22 Degree Interfragmentary Lag Screw Hole

Place the angled drill guide on the fixed proximal block of the compression device once the osteotomy surface has been compressed. Press and hold the drill guide firmly on the fixed block to ensure the guide is in position prior to drilling the interfragmentary lag screw hole. Hold this guide during the drilling procedure.

This hole position is calculated on the assumption that the radius is 11mm thick, anterior to posterior, and that the 2.8mm osteotomy (slots 1 and 2) is used for the saw cuts. The most important part of this drill hole is the interfragmentary screw's far cortex (dorsal and proximal radius) which will be threaded to allow compression of the osteotomy. If a 4.2mm osteotomy is performed (slots 2 and 3) the interfragmentary screw will be slightly distal to the mid-line of the osteotomy but the critical threaded screw hole should allow firm compression by the interfragmentary screw. A thicker radius will make the interfragmentary screw fall proximal to the midline of the osteotomy in both the 2.8mm and 4.2mm osteotomies but it should still assure firm screw fixation at the osteotomy site.

If the interfragmentary screw will not "capture" enough cortical bone on the tapped (far) side of the hole when the angled drill guide is used, (for example in a very large or very small radius) or if it does not fall within the desired site of the osteotomy, a freehand drilling technique may be substituted.

Visualize the site of the drill hole with the drill bit in place **before** the hole is drilled in order to make this decision.

Drill the first cortex with a 2.7mm drill bit through the angled drill guide. | **FIGURE 8A**

Hold the angled drill guide firmly on the fixed block while drilling. Be sure not to drill the second (dorsal) cortex. Such a mistake can be salvaged by using a 3.5mm lag screw. Since this 3.5mm screw would project above the slotted plate in this narrowed area, be sure to check for appropriate screw length.

Apply the drill sleeve through the angled drill guide and volar radial cortex, and drill the opposite cortex with the 2.0mm drill bit. | **FIGURE 8B** Remove the drill sleeve, the angled drill guide and measure the depth of the hole.

Reapply the angled drill guide and tap the far cortex with a 2.7mm tap - (reapplication of the angled drill guide helps guide the tap to the opposite cortex). | **FIGURE 8C**

2.7mm (22°)
Interfragmentary
cortical lag screw

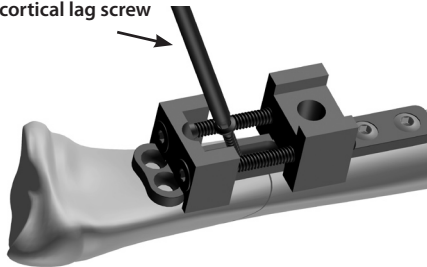

FIGURE 9

STEP 7 - Oblique 2.7mm Interfragmentary Lag Screw Application

Insert the appropriately sized 2.7mm interfragmentary cortical lag screw and gently tighten. | **FIGURE 9**

Do not overtighten the lag screws.

Do not remove the compression device before the interfragmentary screw and two divergent 3.5mm distal screws are inserted.

Drilling of the Two Distal Screw Holes

Complete the fixation of the plate by drilling the two distal screws. These screws must be divergent. The specialized guide which is applied over the plate to drill the two distal screw holes will ensure this divergence. | **FIGURE 10** The under surface of this drill guide is cut out to permit direct placement on the Kienbock plate. Be sure the guide is firmly held in position while the drilling occurs.

Alternatively, a handheld drill guide may be used to drill these divergent holes.

| **FIGURE 10A**

Measure and tap the holes and insert two 3.5mm cortical bone screws of appropriate size. | **FIGURE 10B**

With excessive bending (contouring) of the distal aspect of the plate on the distal radial flare, it may be difficult to use the divergent drill guide as it may impinge against the distal aspect of the compression device. The divergent drill guide has been contoured on its proximal aspect in order to clear the compression device. Also, soft tissue interference may prevent the divergent drill guide from firmly seating on the plate. In case the divergent drill guide cannot be used, the handheld drill guide will permit freehand drilling of these 2.5mm holes. Make sure to diverge the drill holes to avoid crossing of the screws. | **FIGURE 10B**

The 3.5mm cortical screws are preferred for these last two holes as the fixation is bicortical.

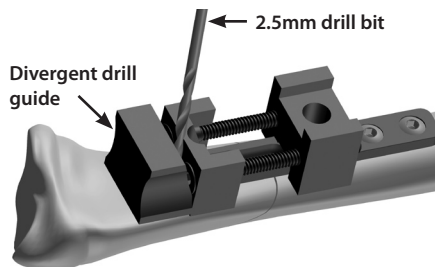

FIGURE 10

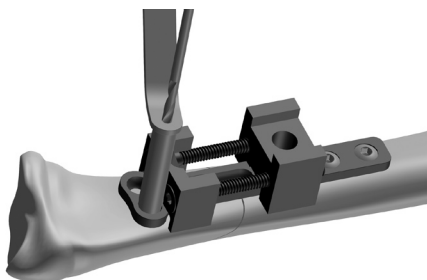

FIGURE 10A

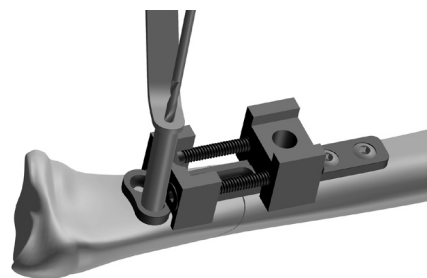
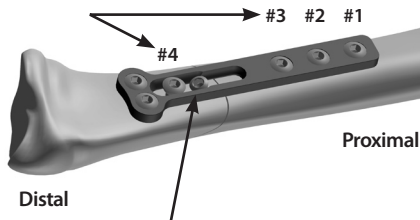

FIGURE 10B



The 2.7mm interfragmentary screw head seats at the top of the plate surface. The 3.5mm screw heads also seat flush on the surface of the plate.

FIGURE 11

STEP 8 - Final Fixation of the Radial Osteotomy

Remove the compression device by loosening the adjusting compression screws first and then removing temporary screws #3 and #4. Replace the appropriate original cortical screws #3 and #4 from the temporary holding slots in the tray. | **FIGURE 11** Discard the temporary fixation screws. Use of self-tapping screws is not advisable as a new “threaded hole” could be created leading to screw looseness.

Do not reinsert the temporary fixation screws that were used to hold the compression device (these temporary screws are 4mm longer than the measured hole and used solely to fix the compression device). Make sure all screws are tight.

Do not over-tighten to avoid thread stripping of the tapped bone hole.

Check X-ray. A final X-ray should confirm that no screws are too long or too short. | **FIGURE 12** Excessively long screws may be palpable on the patient’s dorsal forearm and should be replaced with screws of appropriate length | **FIGURE 13.**



FIGURE 12

Kienbock Radial Osteotomy with Neutral Ulnar Variance

It is possible to alter the radial articular inclination with the use of a single osteotomy cut. The distal radius inclination may be either decreased | **FIGURE 14** or increased at the surgeon’s discretion. | **FIGURE 15**

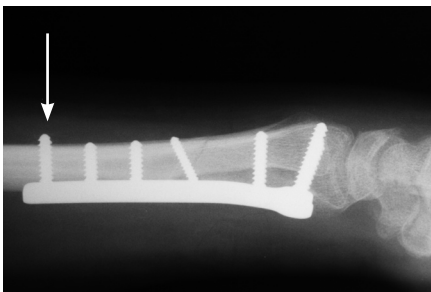

FIGURE 13

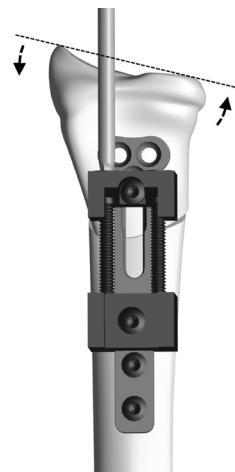

FIGURE 14

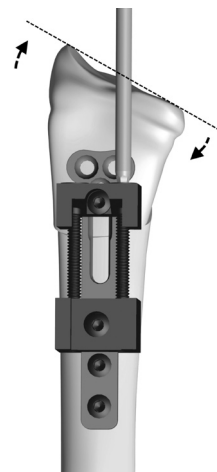

FIGURE 15

Post-Operative Care

In most cases a volar and dorsal plaster splint are used to immobilize the forearm until the sutures are removed at two weeks post surgery. Most patients are placed in a short arm removable thermoplastic splint at this time and protected until the fracture heals. **No activity resulting in loading or activity against resistance is permitted until fracture healing is assured.** In patients who have reckless tendencies, it is recommended that a sugar tong splint be applied at surgery and a short or long arm cast applied at the two week follow-up appointment. This can be converted to a thermoplastic splint when the surgeon is convinced that healing is satisfactory.

Care and Cleaning of the Instruments

The used saw blade may be manually placed in the saw guide slots in order to remove any bone debris. Visually inspect the saw guide slots to ensure cleanliness. Clean any remaining bone debris from the other instruments. **Sterilize the tray and instruments. Refer to package insert for complete cleaning and sterilization instructions.**

CAUTION: It is important to clean and thoroughly dry all instruments before replacing in the tray. Any rust spots that may appear may be lightly buffed using SCOTCH-BRITE™.

The tray cover is locked into position by pushing down on the button located on the cover and pushing this toward the top of the tray. Discard the used saw blade in an appropriate biohazardous container.

Discard the temporary screws used to fix the compression device through holes #3 and #4.

SCOTCH-BRITE™ is a registered trademark of the 3M Corporation.

RAYHACK® Kienbock Radial Shortening System Instrumentation

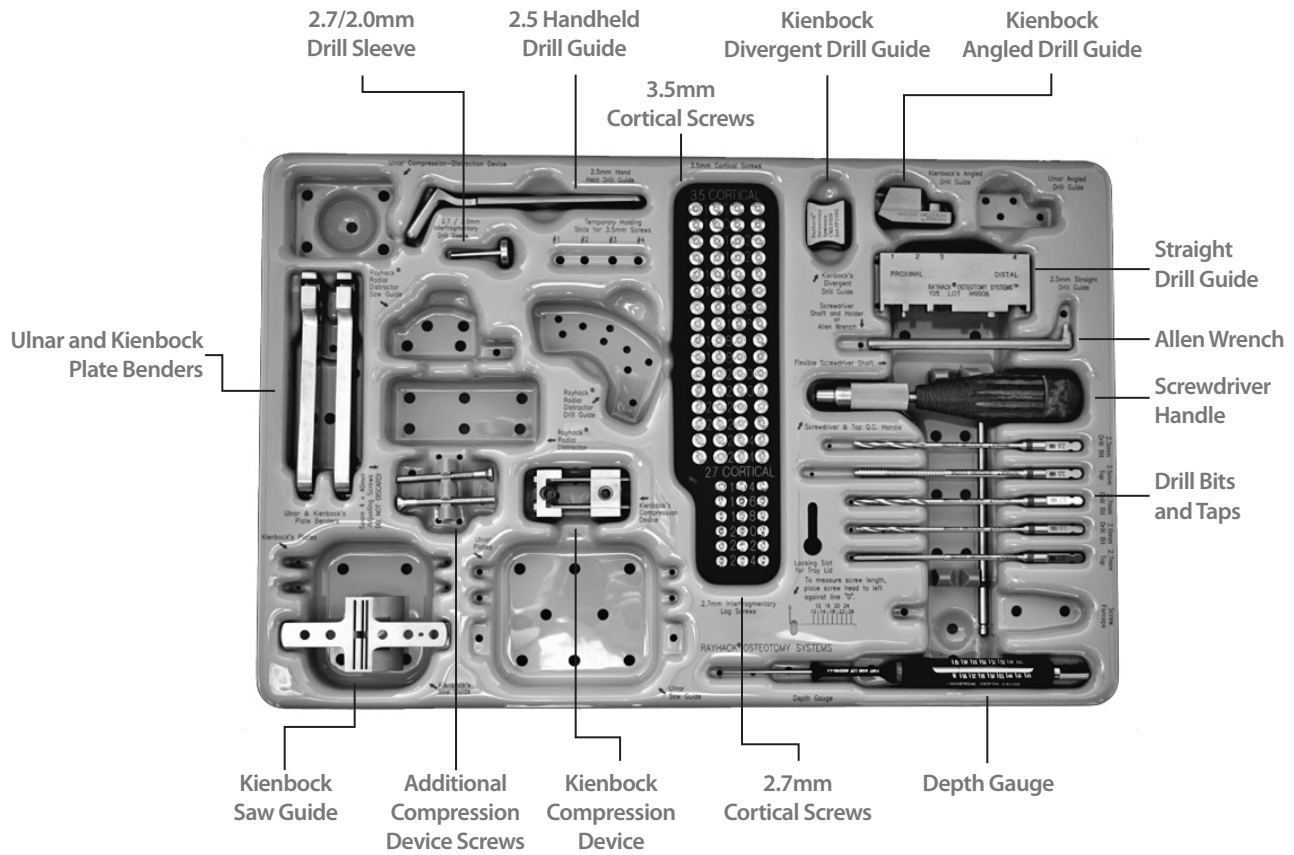

RAYHACK® Kienbock Radial Shortening System Saw Blade Summary



Two individually packaged sterile saw blades are provided with each RAYHACK® Ulnar and Kienbock system. Both saw blades 40100110 and 110 are compatible with the LINVATEC/HALL®/MICROAIRE® saws. Part numbers 40100410 and 410 saw blades are compatible with STRYKER® saws.

The provided saw blades are specifically designed for use with the RAYHACK® Ulnar and Kienbock systems. Using a generic blade is considered off-label and the responsibility of the user.

The below chart is for reference only. Due to manufacturer's specification changes Wright cannot guarantee the saw blades will fit all systems.

| | | WRIGHT PART NO | PNEUMATIC | ELECTRIC | BATTERY |
|-----------------------------|----------|-------------------|---|--|---|
| | | | 1000-100/1950 | 1000ET/1950 | 6642B/6672 |
| | | | 1000-100/1955 | 000ET/1955 | 6642B/6670 (Battery SmartDriver) |
| | | | | 1641/6672 (Electric SmartDriver) | |
| HALL® (LINVATEC) | ZS110* | 40100110 110 | 5053-011 MICRO 100™ | 6020-022 MICROPOWER® (Pencil Style) | Pro6200/Pro2043 MPOWER™ |
| | | | Pro6150/Pro2043 PNEUMATIC POWERPRO® | 6021-022 MICROPOWER® (Pencil Style) | Pro6200/Pro2043 MPOWER™ |
| | | | | 5020-022 MICROCHOICE® (Pencil Style) | Pro5100/Pro2043 POWERPRO® |
| | | | | Pro6100/Pro2043 (Electric POWERPRO®) | Pro5100/Pro2043 POWERPRO® |
| STRYKER® | SP440 R* | 40100410 410 | | Command II 2296-34 | Cordless Driver 4200 with 4100-400 Saw |
| | | | | TPS 5100-34 | |
| | | | | CORE 5400-34 | |
| | | | | 5400-99/4100-400 (Core Driver with Saw) | |

NOTE: Right angle grip of battery drivers is more difficult to use compared to pencil-type grips.

*MICROAIRE® Part No.

Ordering Information

RAYHACK® KIENBOCK RADIAL SHORTENING SYSTEM

| CATALOG NO. | CATALOG NO. | DESCRIPTION |
|-----------------|------------------|-------------------------------|
| 4015KITA | 4016KITA* | |
| 40100211 | 211 | RAYHACK® KIENBOCK PLATE |
| 40100110 | 110 | RAYHACK® SAW BLADE .020" |
| 40100410 | 410 | RAYHACK® SAW BLADE .020" |
| 40100910 | 910 | RAYHACK® CORT SCW 3.5MM, 10MM |
| 40100912 | 912 | RAYHACK® CORT SCW 3.5MM, 12MM |
| 40100914 | 914 | RAYHACK® CORT SCW 3.5MM, 14MM |
| 40100916 | 916 | RAYHACK® CORT SCW 3.5MM, 16MM |
| 40100918 | 918 | RAYHACK® CORT SCW 3.5MM, 18MM |
| 40100920 | 920 | RAYHACK® CORT SCW 3.5MM, 20MM |
| 40100922 | 922 | RAYHACK® CORT SCW 3.5MM, 22MM |
| 40100924 | 924 | RAYHACK® CORT SCW 3.5MM, 24MM |
| 40100954 | 954 | RAYHACK® CORT SCW 2.7MM, 14MM |
| 40100956 | 956 | RAYHACK® CORT SCW 2.7MM, 16MM |
| 40100958 | 958 | RAYHACK® CORT SCW 2.7MM, 18MM |
| 40100960 | 960 | RAYHACK® CORT SCW 2.7MM, 20MM |
| 40100962 | 962 | RAYHACK® CORT SCW 2.7MM, 22MM |
| 40100964 | 964 | RAYHACK® CORT SCW 2.7MM, 24MM |
| 40100520 | 520 | RAYHACK® DRILL BIT 2.0MM |
| 40100525 | 525 | RAYHACK® DRILL BIT 2.5MM |
| 40100527 | 527 | RAYHACK® DRILL BIT 2.7MM |

*4016KITA/1 US distribution only.

RAYHACK® KIENBOCK RADIAL SHORTENING SYSTEM

| CATALOG NO. | CATALOG NO. | DESCRIPTION |
|-----------------|------------------|--------------------------------|
| 4015KIT1 | 4016KIT1* | |
| 40100105 | 105 | RAYHACK® DRILL GUIDE BLOCK |
| 40100107 | 107 | RAYHACK® DRILL SLEEVE |
| 40100141 | 141 | RAYHACK® DRILL GUIDE 2.5MM |
| 40100144 | 144 | RAYHACK® PLATE BENDERS |
| 40100201 | 201 | RAYHACK® SAW GUIDE |
| 40100206 | 206 | RAYHACK® ANGLED DRILL GUIDE |
| 40100209 | 209 | RAYHACK® DIVERGENT DRILL GUIDE |
| 40100355 | 355 | RAYHACK® ALLEN WRENCH |
| 40100402 | 402 | RAYHACK® COMPRESSION BASE |
| 40100403 | 403 | RAYHACK® COMPRESSION BLOCK |
| 40100449 | 449 | RAYHACK® COMP SCREW |
| 40100480 | 480 | RAYHACK® DEPTH GAUGE |
| 40100627 | 627 | RAYHACK® BONE TAP 2.7MM |
| 40100635 | 635 | RAYHACK® BONE TAP 3.5MM |
| 40100725 | 725 | RAYHACK® SCREWDRIVER SHAFT |
| 40100750 | 750 | RAYHACK® SCREWDRIVER HANDLE |

**4016KITA/1 US distribution only.*

References

Rayhack, JM, Radius Shortening in Kienbock's Disease. In; Master Techniques in Orthopaedic Surgery: The Wrist, 3rd edition, edited by Gelberman, RH (2009).



Wright Medical Technology, Inc.

5677 Airline Road
Arlington, TN 38002
901.867.9971 phone
800.238.7188 toll-free
www.wmt.com

Wright Medical EMEA

Krijgsman 11
1186 DM Amstelveen
The Netherlands
011.31.20.545.0100
www.wmt-emea.com

SCOTCH-BRITE™ is a registered trademark of the 3M Corporation.
STRYKER® is a registered trademark of STRYKER® Orthopaedics.
MICRO100™, MICROCHOICE®, MICROPOWER®, POWERPRO®
and HALL® are a registered trademark of CONMED™ LINVATEC.
™Trademarks and ®Registered marks of Wright Medical Technology, Inc.
©2008 Wright Medical Technology, Inc. All Rights Reserved.