



ELECTRO-OPTICS

KILO[®]

KILO2200LRH 7x25mm LONG RANGE HUNTER RANGEFINDER CLASS 3R

OWNERS MANUAL

SIGSAUER[®]

TABLE OF CONTENTS

Introduction	3
Contents	4
Key Features	5
Product Identification	6
Operation	13
Display Information	17
Changing Modes of Operation	18
Programming Sequence	19
Frequently Asked Questions (FAQs)	22
Specifications	26
SIG SAUER® Electro-Optics Infinite Guarantee™	32

This manual is available in the following languages: French, Spanish, German, Italian, Portuguese, Russian, Afrikaans, Swedish, and Norwegian. Please visit sigoptics.com for Owners Manual downloads.

INTRODUCTION

Congratulations on the purchase of your SIG SAUER® Laser Rangefinder. The KILO2200LRH is the most advanced, yet simple to use rangefinder on the market. The KILO2200LRH features the fastest, digital signal processing engine while streamlining the user interface for a no hassle, out of the box experience.

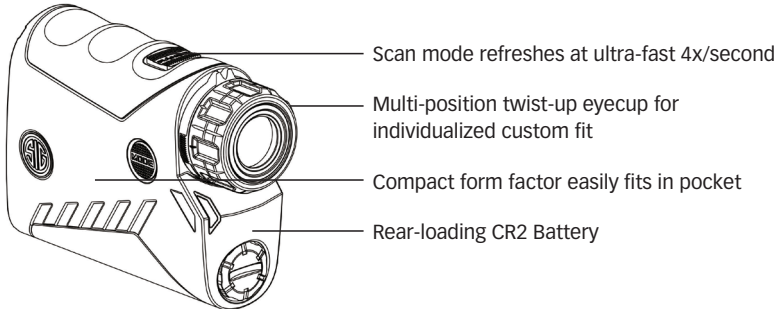

CONTENTS:

- KILO2200LRH 7x25mm Long Range Hunter Rangefinder Class 3R
- CR2 Battery (1)
- Premium Padded Ballistic Nylon Case
- Lanyard

KEY FEATURES:

- 7x25mm monocular with SpectraCoat™ anti-reflection coatings for superior light transmission and optical clarity.
- Revolutionary Lightwave™ DSP Technology for the fastest and longest distance rangefinder engine.
- HyperScan provides 4 range updates per second in scan mode while RangeLock reports the last range result when ranging distant targets.
- Features line of sight or angle modified range. Units in yards or meters to tenth Y/M resolution.
- Projected, segmented organic light emitting diode (OLED) display for daytime and low light use.
- Variable brightness OLED display with 9 settings.
- Compact, magnesium housing with binocular style eyecup and diopter adjustment.
- Simplified user interface with RANGE and MODE buttons only.
- Sleek design for one handed operation and lanyard attachment point.

PRODUCT IDENTIFICATION:

A- Power/Range Button

B- Diopter Focus Adjustment

C- Eyecup

D- Mode Button

E- Battery Compartment

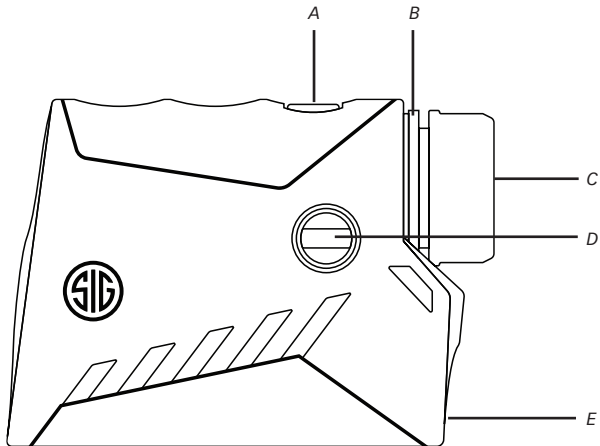

LIGHTWAVE™ DSP TECHNOLOGY

SIG SAUER's proprietary Lightwave DSP engine leverages HyperScan – an advanced power management technique that provides the fastest refresh rate in scan mode (4 times per second) even at distances over a mile. Our DSP engine uses the latest generation field programmable gate array (FPGA) running sophisticated signal processing algorithms to reduce false positives while finding weak or distant targets.

RANGING ACCURACY, RESOLUTION AND MAXIMUM RANGES

The KILO® provides line of sight or angle modified range information accurate to ± 0.5 yards or meters out to 500 yards; ± 1 yard from 500 - 1000 yards and ± 2 yards beyond 1000 yards. Range is displayed in 0.1 yard or meter resolution.

The KILO can range past 2000 yards / meters on reflective or semi-reflective targets such as houses, rock faces or other bright objects. Ranging performance in HyperScan mode is as follows: Reflective up to 2 miles, trees up to 1,600 yards and deer up to 1,300 yards. Actual range performance will vary based on changes in ambient light, temperature and haze.

LINE OF SIGHT (LOS) AND ANGLE MODIFIED RANGE (AMR™)

The KILO® provides 2 simple modes of operation. Line of sight is the range to the target independent of angle. It is comparable to the “hypotenuse” of a triangle. When ranging in LOS mode, the distance is displayed in addition to the angle of incline. This method is preferred for those long range shooters and hunters wanting to use the LOS range and angle of incline to calculate a very precise holdover using a ballistic calculator smartphone application and/or wind measurement device.

Angle modified range is the equivalent horizontal range to the target and is comparable to the “horizontal leg” of a triangle. AMR is also known as “rifleman’s rule” and uses the LOS range and angle of incline to calculate the horizontal distance the projectile travels between shooter and target. AMR is very accurate for most shooters and archers and should be used in most situations.

In this example, if the rangefinder is in LOS mode the line of sight range of 500 yards would be displayed along with the angle of -30 (degrees decline). Use LOS in combination with a ballistic calculator to calculate an exact holdover in minutes of angle or milliradians.

If the rangefinder is in AMR mode the angle modified range of 433.0 yards would be displayed. This is the equivalent horizontal range and can be used in combination with a ballistic / holdover reticle or with the SIG Ballistic Turret SBT™ dial.

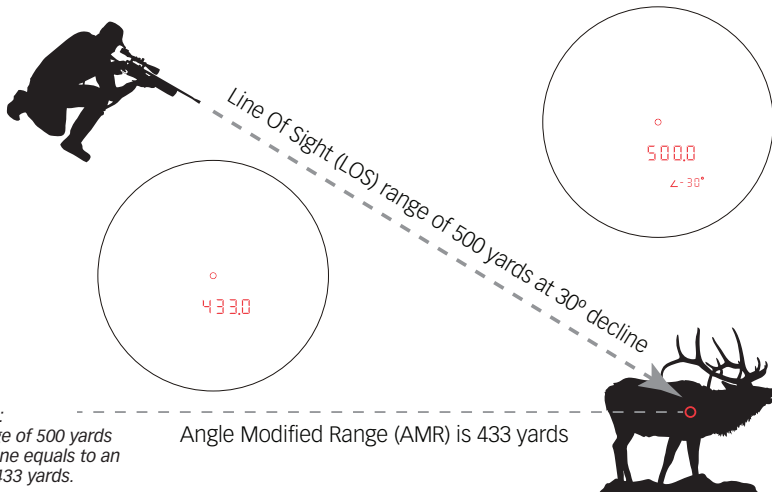

*Example:
LOS range of 500 yards
30° decline equals to an
AMR of 433 yards.*

- A - Center Aiming Circle (3 MRAD OD / 2.4 MRAD ID)
- B - 5 Character alphanumeric digits for range and angle display
- C - Battery Status indicator
- D - M and Y unit of measure selection
- E - BEST, LAST, LOS and AMR indicators
- F - Angle of Incline / Decline

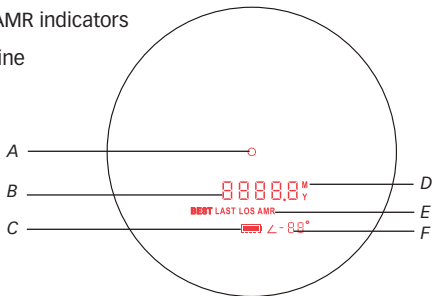



WARNING

Safety and Operation Procedures

The KILO2200LRH is classified as a Class 3R product.

- Do not depress the RANGE button while aiming at the human eye or while looking into the transmitting optics on the objective side
- Do not leave the KILO within reach of small children
- Do not take the product apart or modify the product in any way to expose internal electronics that might cause damage or electric shock
- Do not use any other power source other than a CR2 battery or equivalent.

OPERATION

The KILO was designed to get you up and running without the typical complexity of buried menus and programming modes. The rangefinder comes out of box in the following configuration:

- (a) Best Target (rangefinder returns the best or most likely target, not the first or last)
- (b) Manual brightness control (3 HI, 3 MED and 3 LOW settings)
- (c) Angle Modified Range (equivalent horizontal range)
- (d) Smaller Aiming Circle
- (e) Unit of Measure in Yards

SET UP

Installing the Battery

Remove the battery cap by turning the cap in a counter-clockwise direction. Insert (1) CR2 Primary Lithium battery (+) terminal side first. The (-) terminal should be facing out. Place the cap onto the (-) battery terminal and reinstall the battery cap by turning the cap in the clockwise direction.

⚠ CAUTION - Be careful to not cross-thread the cap.

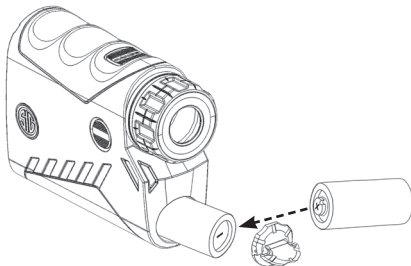

After installation of the battery and depressing the RANGE button, the status of the KILO is displayed:

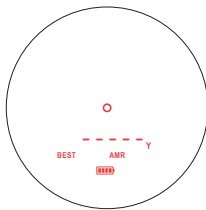

Installing the Lanyard

Install the lanyard loop through the lanyard attachment point.
Pass the lanyard back through the loop for secure attachment.

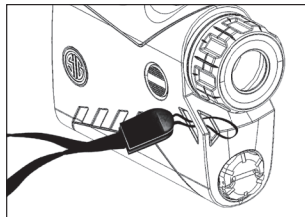

Diopter Adjustment

The diopter or focus adjustment is located just inside of the eyecup. The focus adjustment is used to bring the OLED display into sharp focus along with the target image. The diopter adjustment can turn clockwise or counter-clockwise depending upon the user's prescription.

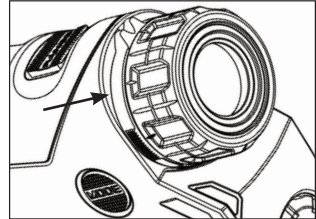

Eyecup Adjustment

The eyecup adjustment allows the user to adjust the eye relief for use with or without glasses. The eyecup rotates approximately 90 degrees counterclockwise allowing the user to adjust the eye relief by approximately 6 mm.

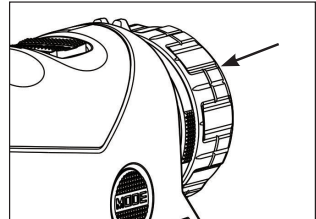

DISPLAY INFORMATION

The OLED display shows you the center aiming circle, the unit of measure (Y), Angle Modified Range mode (AMR) and the remaining battery status. The display will remain active for up to 10 seconds. You can then press the RANGE button to determine range to target.

If you press the RANGE button while the rangefinder is off and continue to hold the RANGE button down, the rangefinder will automatically switch into SCAN mode within 1 second.

After determining the distance to the target, the rangefinder will continue to display the center aiming circle and range data for 10 seconds – and only the range data. All other information is not shown after initial wakeup to prevent clutter in the field of view.

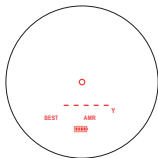

Display at initial wakeup

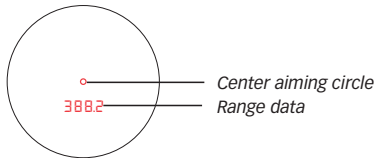

Display when ranging

HyperScan MODE

While the KILO® supports single button push ranging operation, it is highly recommended that you push and hold the RANGE button down to activate HyperScan mode. This mode allows you to scan targets at 4x/second which significantly improves ranging performance at extreme distances. As the ranging distances are updated very quickly in HyperScan mode, once you release the RANGE button the last acquired distance will be displayed. When in HyperScan mode ranging distant targets, the display may update between no result and a distant range - by using RangeLock technology the rangefinder will report the last range result when the RANGE button is released.

CHANGING MODES OF OPERATION

The KILO® ships with the most common modes already configured. However, you can access and change the following features:

- Best or Last Target
- OLED Brightness – 9 different modes – 3 LOW, 3 MED, 3 HIGH
- Line of Sight (LOS) or Angle Modified Range (AMR)
- Units of Measure (Y or M)

PROGRAMMING SEQUENCE

The sequence of the programming steps has been calibrated to reflect the frequency of potential setting changes, for example it is more likely that you would change from BEST to LAST target so it is the first programming step, whereas Unit of Measure (Y or M) is the last programming step as you will likely set that once and leave it in that setting.

1. BEST or LAST Target

To enter programming mode, press and release the RANGE button to wakeup the rangefinder. After wakeup, press and hold the MODE button for 2 seconds, then release the MODE button and the current selection will be flashing (BEST is default). You can toggle between BEST and LAST by pressing the RANGE button. Your selection will be flashing BEST or LAST. You can confirm your selection by pressing and releasing the MODE button – which will cause the Target Mode to stop flashing and save your selection. The rangefinder will then index to the next programming mode which is OLED Display Brightness. If you do not press and release the MODE button the rangefinder will save your displayed setting (BEST or LAST) and turn off. BEST Target Mode can be used in most settings, however when hunting through foliage or in high grass the LAST Target Mode is recommended.

2. OLED Display Brightness

After selecting and saving BEST or LAST Target, the rangefinder will then index to the next programming mode which is OLED Display Brightness. Your current selection will be flashing. You can toggle between LO1, LO2, LO3, MED1, MED2, MED3, HI1, HI2, or HI3 by pressing the RANGE button. You can confirm your selection by pressing and releasing the MODE button - which will cause the Display Mode to stop flashing and save your selection. The rangefinder will then index to the next programming mode which is Line of Sight (LOS) or Angle Modified Range (AMR). If you do not press and release the MODE button the rangefinder will save your displayed setting (Brightness Level Selected) and turn off.

3. Line of Sight (LOS) or Angle Modified Range (AMR)

After selecting and saving OLED Display Brightness, the rangefinder will then index to the next programming mode which is LOS or AMR. Your current selection will be flashing (AMR is default). You can toggle between LOS and AMR by pressing the RANGE button. You can confirm your selection by pressing and releasing the MODE button – which will cause LOS or AMR to stop flashing and confirm your selection. The rangefinder will then index to the next programming mode which

is Unit of Measure. If you do not press and release the MODE button the rangefinder will save your displayed setting (LOS or AMR) and turn off. If you choose LOS Mode, the rangefinder will display the Line of Sight range independent of angle of incline or decline. However, when set to LOS Mode and ranging targets, after the RANGE button is released, the rangefinder will display both the LOS distance and the angle of incline / decline for that last distance acquired. The distance value will be shown with the Unit of Measure (Y or M), while the angle of incline or decline will be displayed in the lower right with + (incline) or - (decline) and the corresponding angle. This method is supported for those long range shooters that need to know both the LOS range and angle, especially when used in combination with a ballistic drop calculator. If you choose AMR mode, the rangefinder will display only the Angle Modified Range, as explained elsewhere in this instruction manual.

4. Unit of Measure – Yards (Y) or Meters (M)

After selecting and saving your reticle selection, the rangefinder will then index to the next programming mode which is Unit of Measure, Yards (Y) or Meters (M). Your current selection will be flashing (Y is default for KILO2200LRH). You can toggle between Y and M by pressing the RANGE

button. You can confirm your selection by pressing and releasing the MODE button – which will cause Unit of Measure to stop flashing and confirm your selection. The rangefinder will then index out of programming mode and is ready to range targets. If you do not press and release the MODE button the rangefinder will save your displayed setting (Y or M) and turn off.

FREQUENTLY ASKED QUESTIONS (FAQ):

Q: I am pressing the RANGE button and nothing happens?

A: Check to make sure you have a fresh CR2 battery installed. If the battery is new, try loosening and tightening the battery cap until the cap is snug. If this doesn't fix the problem you may have switched the KILO into one of the low brightness settings for the OLED display. Go into a dark room and press the RANGE button. In this case, if the display becomes barely visible you need to go into programming mode and adjust the brightness to a medium or high setting, or put the display in AUTO adjust mode.

Q: Information on the display is disappearing, is this normal?

A: Yes. The KILO display was optimized to only present the most important information while in use. Upon initial wake up, all your settings are visible such as the battery indicator, Line of Sight (LOS) or Angle Modified Range (AMR), Last or Best target mode and unit of measure. After the first range is acquired or in Scan mode, after about 2 seconds, only the aiming circle and range information is displayed.

Q: I can't get the display to focus?

A: You need to adjust the diopter ring to your vision. The diopter ring is located in front of the eyecup and rotates approximately 40 degrees in either direction to accommodate your unique prescription.

Q: I can't seem to range past 1200 yards on trees?

A: The KILO will have very different performance based on changes in ambient conditions such as bright sunlight or snow, rain or fog, temperature and the reflectivity of the target being ranged. For example, at dusk or dawn your rangefinder may be able to range trees at over 2000 yards but in bright sunlight may only achieve 1100 yards. This is normal, however, the KILO is the highest performance compact rangefinder available.

Q: My battery seems to drain too fast?

A: Most commercial rangefinders will provide over 4000 individual range calculations using a fresh CR2 primary lithium battery. The KILO exceeds this specification, however, when heavily using Scan mode this will cause the battery to drain much faster as the FPGA remains active at all times and you will quickly exceed 4000 range calculations due to the HyperScan mode. This is normal operation but you should always keep a spare CR2 battery when heading out to remote locations.

KILO2200LRH SPECIFICATIONS

Magnification	7x		
Objective Clear Aperture	25mm		
Exit Pupil	3.6mm		
Eye Relief	15mm		
Angular (FOV)	6.78°		
FOV @ 100yds	35.67 ft		
Laser Divergence	1.3 mrad		
Range Response Time	.25 sec		
Scanning	Yes		
Range Accuracy Under 100 yds	.1 yds		
Max Range (Class 3R)	Reflective up to 2 miles	Trees up to 1,600yds	Deer up to 1,300yds
Weight with Battery	7.5 oz / 215 g		

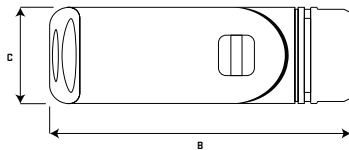
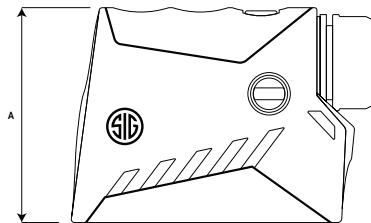

A – 3 in / 76mm
B – 4.2 in / 107mm
C – 1.3 in / 33mm

! DANGER

CLASS 3R LASER PRODUCT INVISIBLE LASER RADIATION - AVOID DIRECT EYE EXPOSURE

This product complies with IEC 60825-1: 2014-05 Ed 3.0 and complies with FDA performance standards for laser products except for deviations pursuant to Laser Notice No. 50, dated June 24, 2007. $P_o < 20W$, $\lambda = 905 \text{ nm}$, $t = 22 \text{ ns}$



This product has been tested and found to comply with the limits for a Class B digital device, pursuant to Part 15 of the FCC Rules. The equipment generates, uses and can radiate radio frequency energy and, if not installed and used in accordance with these instructions, may cause harmful interference to radio communications. However, there is no guarantee that interference will not occur in a particular installation. If this product does cause interference to radio or television reception the user is encouraged to try to correct the interference by one or more of the following:

- Reorient or relocate the receiving antenna
- Increase the separation between this product and the receiver
- Connect the equipment to an alternative outlet or receiver
- Consult a technician.

Shielded interference cable must be used with the equipment in order to comply with the limits for a digital device pursuant to Subpart B of Part 15 of FCC Rules.

Specifications and designs are subject to change without any notice or obligation on the part of the manufacturer.

CAUTION

Use of controls or adjustments or performance of procedures other than those specified herein may result in hazardous radiation exposure.



LASER APERTURE



SIG SAUER Electro-Optics Infinite Guarantee™

SIG SAUER has manufactured the most rugged, dependable high-performance firearms for over two centuries. Our heritage of design, engineering and precision-manufactured quality predates the existence of any other optics company worldwide. We understand the importance of quality in the line of fire, at the shooting range or on your next hunt. SIG SAUER Electro-Optics had to earn the right to wear that badge and the Infinite Guarantee has your back, forever. Period.

We will repair or replace your SIG SAUER product in the event it becomes damaged or defective, at no charge to you. If we cannot repair your product, we will replace it with a product in perfect working order of equal or better physical condition. It doesn't matter how it happened, whose fault it was, or where you purchased it.

SIG SAUER Infinite Guarantee™

- Unlimited Lifetime Guarantee
- Fully Transferable
- No Warranty Card Required
- No Receipt Required
- No Time Limit Applies
- No Charge

If you ever have a problem, no matter the cause, we promise to take care of you when it counts. Please note that our Infinite Guarantee does not provide coverage for intentional damage, misuse, cosmetic damage that does not affect the performance of the optic, loss, theft or unauthorized repair or modification. Excludes electronic components.



SIG SAUER Electronic & Tritium Component Limited 5-Year Warranty

For components not included under the SIG SAUER® Infinite Guarantee™, this warranty covers any defects in materials and workmanship in the electronic and Tritium components of illuminated riflescopes/sights, pistol sights, electronic sights, flashlights, lasers, binoculars, spotting scopes, and rangefinders. This warranty lasts for five years from the date of manufacture. If, during that five-year period, these products are found to have electronic or Tritium component defects in materials or workmanship, SIG SAUER will repair your product, at no charge to you. If we cannot repair your product, we will replace it with a product in perfect working order of equal or better physical condition.

NOTES:

NOTES:



FOR PRODUCT SERVICE ON THIS MODEL, PLEASE CALL 603-610-3000

19861 SW 95th Avenue, Portland, OR 97062 USA