



KONICA MINOLTA

TECHNOLOGY

Konica Minolta Print Production. Superior Quality, Digital Economy.

**production**



Giving Shape to Ideas

**Professional.** Konica Minolta color and B&W production printers offer superior performance and unsurpassed value for graphics professionals – delivering the power to increase your output, reduce your costs and satisfy your clients. You'll have digital color quality to rival offset prints, with advanced workflow and color management tools for reducing costs and fine-tuning accuracy. High speeds, simple setup and long-run image stability increase your efficiency. Inline finishing options get the job done right. Purpose-built reliability stands up to rugged production demands, with integrated software from leading graphic communication industry providers, IT solutions and more – all from a professional partner you can count on.



**Quality.** Konica Minolta's unique Screen-Enhancing Active Digital (SEAD IV) system combines highly accurate exposure controls, precision pixel placement and advanced screening to achieve resolution equivalent to 3,600 dpi. You'll also have flexible processing and image smoothing control to match the needs of any customer file.

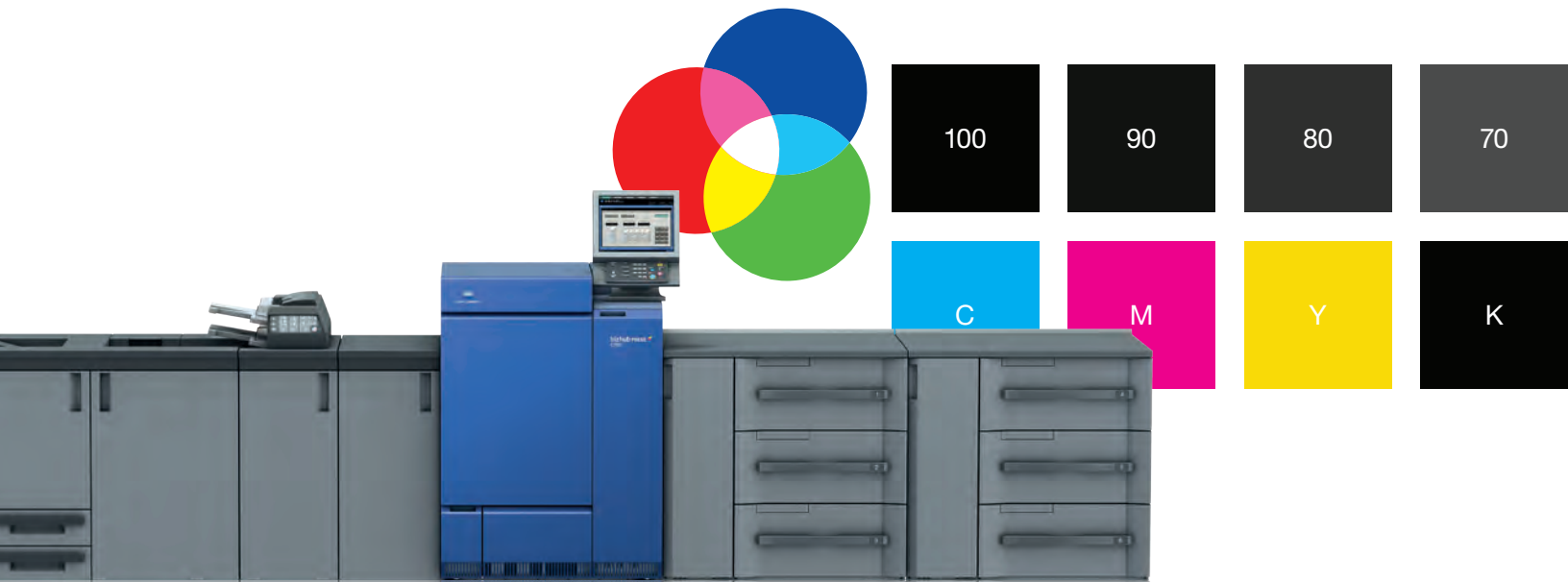

**Color.** Konica Minolta knows color. Our bizhub PRESS professionals can bring you pro-quality digital color at up to 100 ppm – 5,000 impressions or more per hour, through robust monthly duty cycles that stand up to the daily punishment of high-volume production. Whether you're doing small-lot jobs on tight turnaround or long print runs with complex finishing requirements, you'll get them out the door on time – spectacular full-color photo books and product brochures, direct-mail flyers, colorful newsletters, graphics presentations and more.

**Monochrome.** Getting it done in B&W. Konica Minolta high-speed B&W digital presses lead the industry in workhorse performance, high-resolution monochrome image quality and flexible substrate handling – ideal for training and instruction manuals, transactional printing, corporate reports, on-demand book publishing and more. Purpose-built reliability and workhorse production output stands up to rigorous long-run production, with cost-efficiency that protects your bottom line.

**Embedded Control.** Get the most from your bizhub PRESS. Konica Minolta's internal image controller was developed in-house for powerful, affordable color management. Job Centro functionality lets you hold up to 100 jobs in queue, editing pages and job tickets with drag-and-drop ease – even without special training. Color Centro technology lets you edit color with visible adjustments on screen. You'll have all the color tools you need, including calibration, tone curve adjustment with before-and-after comparison, an expandable library of spot colors (Pantone, Toyo, DIC and HKS) and more.

### Bindery.

Pro-quality options for every need. Stapling and hole-punching. 200-page saddle-stitch booklets. 600-page perfect-bound books. 6 folding options, including inline gatefold. Inline GBC punching and ring binding. A 5,000-sheet stacker with rollaway cart can quickly move your finished output to offline bindery. We also offer near-line full-bleed edge trimming and square folding.

### Alliances.

Best-in-class partners on your team. Konica Minolta's strategic partnerships with production professionals like EFI, Kodak Creo, Watkiss, Tecna, MGI, PageDNA, Xrite and others extend the range of capabilities we can offer you – another reason why production print professionals count on Konica Minolta for all of their digital printing needs.



60

50

40

30

20

10



### External Control Options.

Advanced color management tools. Fiery and Creo external image control options give graphics professionals advanced color management and production benefits. Fiery delivers improved color performance and upgraded functions, including hot folders, job batching, sample printing and more. Creo features advanced color profiling and destination profiles to spot colors, a complete Pantone GOE library, color sets, and full integration with Kodak Prinergy.

### And More.

A wide array of specialty printers. As an example of our strategic alliances, we can provide printers for specialized wide-format print applications in graphics, architecture, engineering and construction – giving your shop high-speed wide-format output, cut-sheet feeder options and fully integrated stacking and folding capabilities. The JETvarnish 3DS turns regular printed jobs into high-margin spot UV jobs – or even higher margin 3D embossing jobs. And now the iFOIL S is available, which offers digital embossing and hot foil stamping.

### High-Volume Color

bizhub PRESS C1100  
bizhub PRESS C1085  
bizhub PRESS C71hc  
bizhub PRESS C1070  
bizhub PRESS C1070P  
bizhub PRESS C1060  
bizhub PRO C1060L

### Digital B&W Presses

bizhub PRESS 2250P  
bizhub PRESS 1250  
bizhub PRESS 1250P  
bizhub PRESS 1052  
bizhub PRO 1100

### Wide-Format Models

#### Technical B&W

EFI H1625 LED  
KIP 770  
KIP 7170  
KIP 7770  
KIP 7970  
KIP 9900

#### Technical Color

KIP 800 Series  
KIP 940

#### Graphics Production

EFI H1625

### Specialty Printing

MGI JETvarnish 3DS  
+ iFOIL S

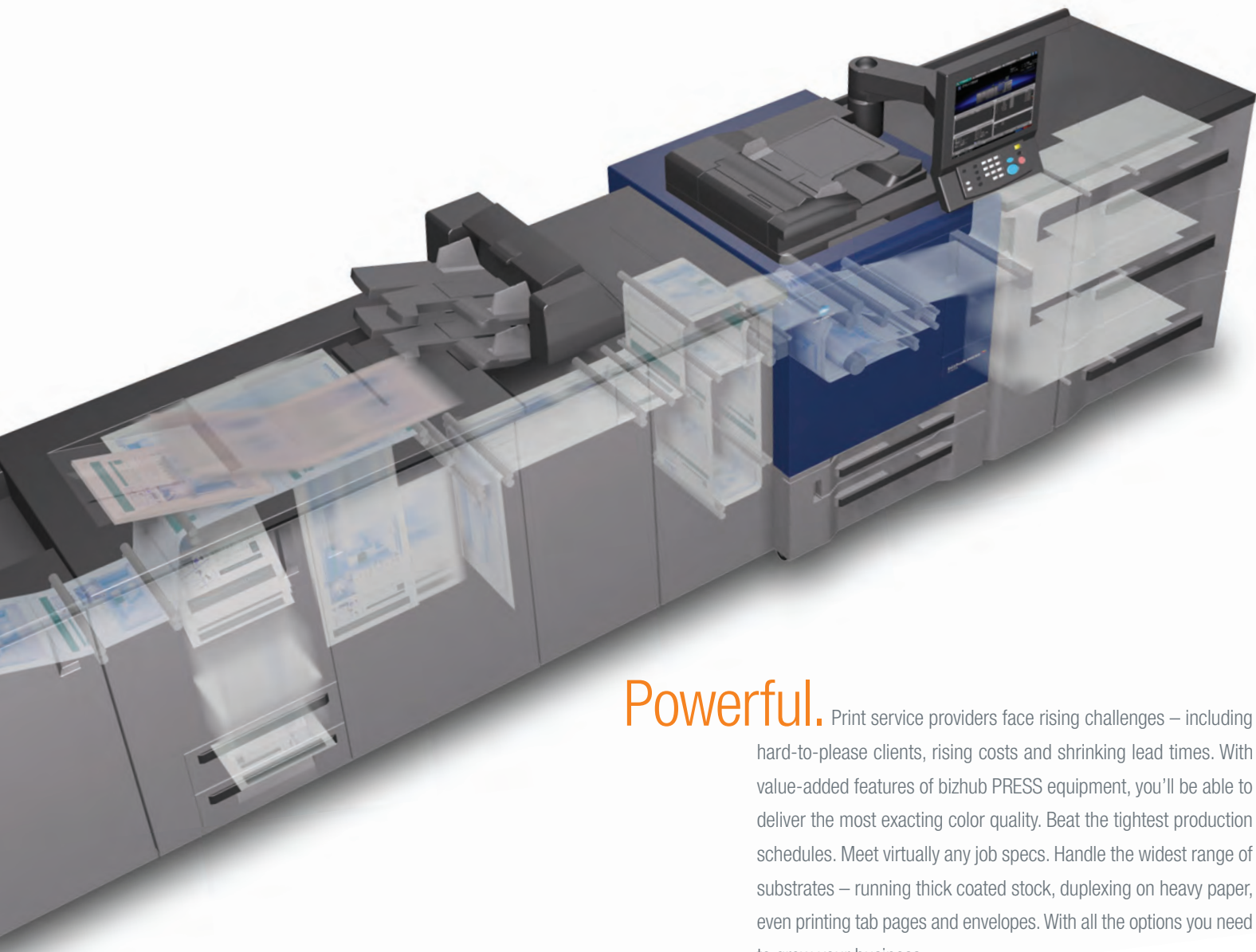

**Powerful.** Print service providers face rising challenges – including hard-to-please clients, rising costs and shrinking lead times. With value-added features of bizhub PRESS equipment, you'll be able to deliver the most exacting color quality. Beat the tightest production schedules. Meet virtually any job specs. Handle the widest range of substrates – running thick coated stock, duplexing on heavy paper, even printing tab pages and envelopes. With all the options you need to grow your business.

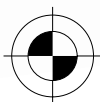

**Stability.**

Inline sensing for long-run precision. Automatic density adjustment, improved position accuracy and enhanced front-to-back registration control combine to keep your output stable without operator intervention. Real-time engine calibration is done inline to stabilize color values. Our enhanced color feedback system measures both CMYK and RGB for greater accuracy. The visible result: smoother edges, more legible text, and maximum color density without granularity or moiré distortion.



**High Chroma.**

Amazingly rich, vibrant color. bizhub High Chroma, or "hc", models use a special color toner formula that goes beyond the reproduction capabilities of conventional toner. With High Chroma, your production print output can have rich, fluorescent visuals. Colors become significantly brighter and more vivid. Presentations are more convincing. Packaging jumps off the shelf. And direct-mail campaigns come alive to pull higher response rates.



**Certification.**

Konica Minolta's digital presses were among the first to receive the IDEAlliance Digital Press Certification, passing all requirements for GRACol and G7 gray balance reproduction. G7 signifies a new level of color consistency – a specific colorimetric definition of grayscale balance in mid-range tones, weight and contrast. From highlights to shadows, corporate colors, products and services reproduced on G7 certified systems will look the same, be color-matched across media and on various substrates – even in different locations.



**Experts.**

Helping you get there faster. For print providers, attaining G7 Master Printer status can be an important next step in growing your business – and Konica Minolta has G7 experts available to help you bring your production facility to G7 status. Our team includes specialists who have completed the G7 Expert Training program and are experienced in color management, proofing quality control, prepress, plate making and print processes in offset as well as digital print.

## Strength.

These are purpose-built professionals. Whichever bizhub PRESS or bizhub PRO model you choose, you'll have robust design combining a powerful iron box-type chassis with long-lasting parts, heavy-duty metal paper trays and high-yield consumables. A manageable overall footprint saves space on your production floor.



## Color Care.

Accurate, repeatable and easy. Konica Minolta's Color Care Suite is a comprehensive color management solution for measuring, managing and controlling color output. Color Care enables you to maintain consistent, accurate color values without subjective guesswork or complex measurements and manual settings. And our CurveCore option helps you generate gray balance curves that meet the G7 standard. Color Care is a Certified G7 system by IDEAlliance.

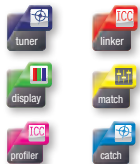

## Measurement.

Precision in the palm of your hand. Add the Konica Minolta FD-5 Spectrodensitometer to your color control system, and you can measure color values more accurately on any substrate. The FD-9 is an automated spectrophotometer that can be used to calibrate, linearize and profile bizhub PRESS units. It has both IP and USB connectivity and can read a color chart with 1,500 patches in about four minutes – making profiling a bizhub PRESS simple, quick and easy. And with network capability, one FD-9 can be used for multiple PRESSES.

## Simitri HD

## Brilliance.

Color that surpasses offset printing. Konica Minolta's next-generation Simitri HD<sup>e</sup> polymerized toner captures an expanded color gamut for superior accuracy. Deep blacks help colors pop. Improved magenta makes reds more vivid and enhanced electro-photographic properties make skin-tones more accurate and natural. Our 3-dimensional polymer structure adheres more precisely to rough paper surfaces. And 10% higher overall percentage of pigment creates rich areas of solid color and a smooth, natural luster on both glossy and matte stock.

**Scanning.**

Copy, scan and store. Most bizhub PRESS models offer document copy and scanning capabilities to speed your workflow. Large color touchscreens provide comprehensive user guides, with pull-down menus and point-and-click control for hands-on job management at the machine. Our latest models even provide an on-screen paper catalog with data you can load and update via web-based or USB input.



**Process Automation.**

Reduce touches, improve productivity, increase profits. Konica Minolta's game-changing automation tool lets you to offer your customers web-enabled, menu-based order control in a fully automated production process. Each customer selects from a secure menu of the print products they need: flyers, brochures, marketing bulletins, newsletters and more. Digital storefronts are fully integrated with your production cycle, through job ticketing, printing and delivery – and you can increase your output and capacity without adding expense to your bottom line.

**Marketing Automation.**

Multi-channel marketing tools to grow your business. With support for print, email, web, text messaging, PURLs, QR codes and social media, EngageIT XMedia gives you a fully integrated marketing tool to broaden your reach and realize today's hottest new media opportunities. Pull-down menus allow users to create targeted campaigns. And plug-and-play templates are easy to customize, opening up new opportunities for growth and additional revenue.



**Profitable.** Profitable operation depends on more than print quality.

You need a system enabling streamlined, automated workflows that allow web job submission to reduce overall manufacturing costs. On your production floor, every bizhub PRESS professional is a perfect fit – small footprint, network integration and touchscreen operation without special training. And together with award-winning automation solutions like EngageIT Automation, you'll have 24/7 job input, job ticketing and a fully integrated production cycle.





**Queue Management.**

The right printer for every job. Printgroove POD Queue helps you optimize device management on your print floor, recommending the most suitable output device based on speed or cost and automatically forwarding jobs to the correct printer. Jobs can also be split up among separate devices for optimal speed and efficiency, then automatically merged together in proper order for finishing.

**Partner Solutions.**

Integrated 3rd-party software. All bizhub PRESS and bizhub PRO devices provide smooth integration with a wide range of 3rd-party production solutions for web-to-print, variable data and more. You can personalize direct-mail flyers, advertising circulars, event announcements and billing statements, all in color at affordable costs – opening up new opportunities to serve your customers and grow your business.

**Substrate Handling.**

The sizes you want, in the capacity you need. With options, your bizhub PRESS and bizhub PRO equipment handles a wide range of sizes and weights – up to 13" x 19.2", in paper stocks from 55 to 350 gsm. You'll be able to load up to 13,500 sheets in multiple paper trays. Air separation helps both thick and thin stocks move more easily. Humidification and de-curling capabilities keep jobs moving quickly for direct-to-bindery operations.

**Data Conversion.**

Handling any print stream. Konica Minolta data conversion software portfolio includes industry-leading applications that enable you to receive mainframe and competitive print streams and output PostScript streams to bizhub PRESS and bizhub PRO equipment.

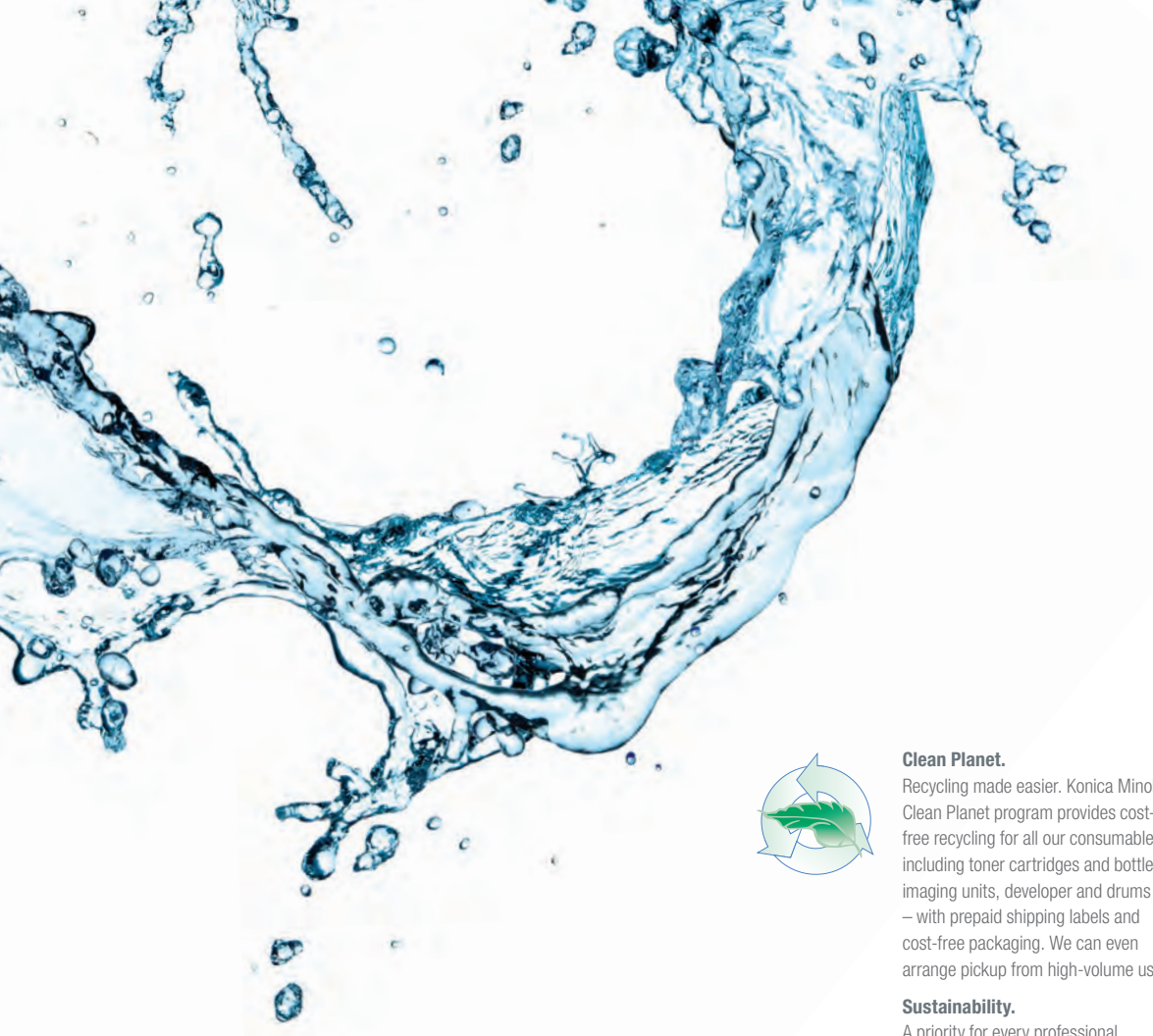

# Environment.

Protecting the planet is a top priority at Konica Minolta. As part of our worldwide Corporate Citizenship program, we pursue a broad array of environmental initiatives – eliminating pollutants, reducing energy consumption, and creating products and solutions that help our customers realize their own sustainability goals.

### Clean Planet.

Recycling made easier. Konica Minolta's Clean Planet program provides cost-free recycling for all our consumables, including toner cartridges and bottles, imaging units, developer and drums – with prepaid shipping labels and cost-free packaging. We can even arrange pickup from high-volume users.

### Sustainability.

A priority for every professional. Konica Minolta's exclusive Simitri toner formulation uses plant-based biomass material to reduce environmental impact – and also fuses to paper at lower temperatures, saving energy as it improves your image. Our bizhub PRESS professionals make greater use of recycled PC/ABS resins and bioplastics in construction.

### Eco Vision 2050.

A vision for the future. With Konica Minolta's Eco Vision 2050, we're committed to a mid-century goal of reducing CO<sub>2</sub> emissions by 80% over 2005 levels, minimizing greenhouse gases that may contribute to global warming. We pursue that goal every day – minimizing energy consumption, cutting pollution and using recycled materials in construction.

## Partnership

Konica Minolta can help give shape to your ideas and partner with you to achieve your corporate objectives. Contact us to realize opportunities in:

### Information Management

- Enterprise Content Management (ECM)
- Document Management
- Automated Workflow Solutions
- Business Process Automation
- Security and Compliance
- Mobility

### IT Services

- Application Services
- Cloud Services
- IT Security
- Managed IT Services
- IT Consulting & Projects

### Technology

- Office Multifunction Business Solutions
- Commercial and Production Printers
- 3D Printers
- Wide Format Printers
- Laptops, Desktops and Computer Hardware
- Servers and Networking Equipment
- Managed Print Services (MPS)
- Facilities Management



**KONICA MINOLTA**

© 2016 KONICA MINOLTA BUSINESS SOLUTIONS U.S.A., INC. All rights reserved. Reproduction in whole or in part without written permission is prohibited. KONICA MINOLTA, the KONICA MINOLTA logo, Count on Konica Minolta, bizhub, bizhub PRO, bizhub PRESS, PageScope, and Giving Shape to Ideas are registered trademarks or trademarks of KONICA MINOLTA, INC. All other product and brand names are trademarks or registered trademarks of their respective companies or organizations. All features and functions described here may not be available on some products. Design & specifications are subject to change without notice.

KONICA MINOLTA BUSINESS SOLUTIONS U.S.A., INC.  
100 Williams Drive, Ramsey, New Jersey 07446

[CountOnKonicaMinolta.com](http://CountOnKonicaMinolta.com)

Printed on a **bizhub PRESS**



Item #: PROPRINTBRO  
2/16 - S





KONICA MINOLTA

# **bizhub PRESS C1085/C1100 DATASHEET**

- ✦ Colour SRA3+ digital press
- ✦ Up to 5,192 pages per hour

To build up business by completing a wider range of high-volume jobs more efficiently in the fast-growing digital high-print-volume market, in-house printers and graphic communications providers need the highest performance available on the market. Konica Minolta's flagship models for digital colour on-demand printing reliably deliver the higher level of image quality, productivity, and price competitiveness you need to satisfy your clients' growing demands. And with very fast 85/100 ppm, and equal high-speed printing for a wide range of paper weights, the bizhub PRESS C1085/ C1100 achieve superior productivity fast – giving you more options to grow your business.



**bizhub PRESS**   
**C1085/C1100**

**COLOUR PRODUCTION PRINTING SYSTEM**

# YOUR ADVANTAGES WITH THE bizhub PRESS C1085/C1100

## DURABLE PERFORMANCE

- bizhub PRESS C1085
  - Up to 85 A4 pages per minute
  - Up to 4,413 A4 pages per hour
- bizhub PRESS C1100
  - Up to 100 A4 pages per minute
  - Up to 5,192 A4 pages per hour

## HIGHEST RELIABILITY

- Long-life platform, long-lasting parts and consumables
- Accurate front to back registration
- Fusing-rolling mechanism
- For prints with maximum efficiency
- For lucrative short-run printing

## READY-MADE PRINT PRODUCTS

- 50-sheet booklet making with front trimming
- Perfect binding for books of up to 30 mm
- 100-sheet stapling with cutting mechanism
- 102-sheet auto ring binding
- For highest automation and enormous productivity
- For more profit in the print room

## GEARED-UP FINISHING

- Multi (GBC) punching and 2- & 4-hole punching
- 6 different types of folding
- Large stacking
- Minimised human interaction
- For optimised budgets



## ENVIRONMENTAL AWARENESS

- Reduced power consumption with Simitri® HD E toner
- Increased usage rate of recycled PC/ABS materials for reduction of CO<sub>2</sub> emissions
- For reduced environmental impact
- Improved efficiency based on green values



**HIGH-END PRINT CONTROL**

- Flexible choice of controller technology: EFI®, CREO® or proprietary Konica Minolta controller
- Integration into hybrid workflows
- For intuitive operation
- Saves time and money



**EASE OF USE**

- Automated real-time engine calibration
- Simple paper catalogue settings
- Operator Replaceable Unit Management (ORUM)
- For maximum ease of operation
- Frees operators for other jobs

**SOPHISTICATED MEDIA HANDLING**

- Air-suction feeding technology
- Up to 13,890 sheets paper input capacity
- Up to 9 paper input trays
- For enhanced overall productivity
- For extreme cost savings

**PERFECT IMAGE QUALITY**

- S.E.A.D. IV technology and 1,200 x 1,200 dpi x 8 bit resolution (equivalent to 1,200 x 3,600 dpi)
- Simitri® HD E toner technology
- Automatic image density control technology
- For new print applications
- For growing your business

**Simitri HD<sup>E</sup>**  
THE EVOLUTION OF TECHNOLOGY



**COMPREHENSIVE MEDIA PROCESSING**

- Up to 350 gsm paper weight in simplex & duplex printing
- Reliable thin paper feeding through air-blow fusing separation
- Mechanical decurling
- Optional inter-cooler curl eliminator
- For highly flexible print products
- To stand out from the competition



## Recommended configurations

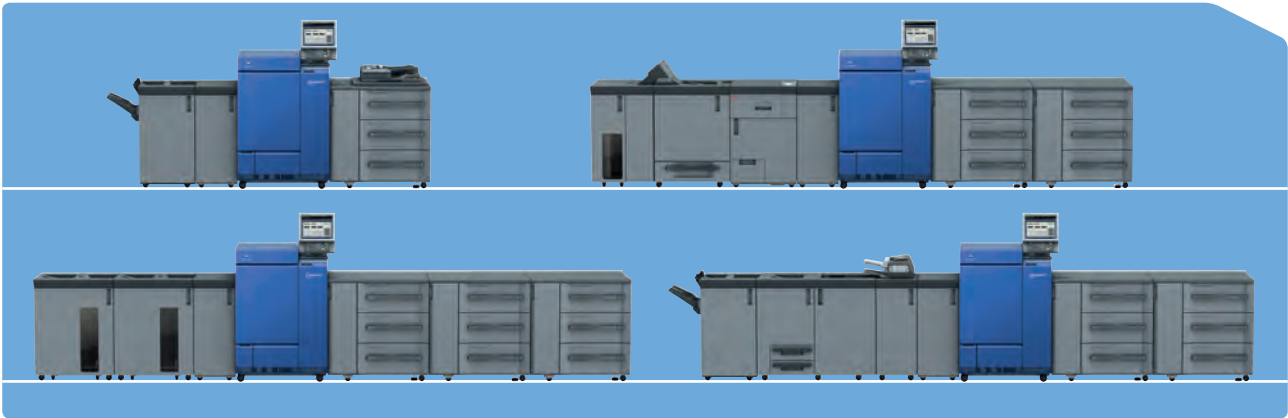

## Technical specifications

### SYSTEM SPECIFICATIONS

Resolution	1,200 x 1,200 dpi x 8 bit 1,200 x 3,600 dpi equivalent
Paper weight	55–350 gsm
Duplex unit	Non-stack type; 55–350 gsm
Paper sizes	330 x 487 mm
Maximum image area	321 x 480 mm
Paper input capacity	Max.: 13,890 sheets
Paper output capacity	Max.: 13,600 sheets
Main unit dimensions (W x D x H)	900 x 950 x 1,319 mm
Main unit weight	430 kg

### PRODUCTIVITY

#### bizhub PRESS C1100

A4 - max. per minute	100 ppm
A3 - max. per minute	53 ppm
SRA3 - max. per minute	50 ppm
A4 - max. per hour	5,192 pph
A3 - max. per hour	2,762 pph
SRA3 - max. per hour	2,581 pph

#### bizhub PRESS C1085

A4 - max. per minute	85 ppm
A3 - max. per minute	46 ppm
SRA3 - max. per minute	43 ppm
A4 - max. per hour	4,413 pph
A3 - max. per hour	2,399 pph
SRA3 - max. per hour	2,243 pph

### CONTROLLER

External EFI® Fiery Controller	IC-308
External EFI® Fiery Controller	IC-310
External CREO® Controller	IC-309
External CREO® Controller	IC-312
Internal Konica Minolta own controller	IC-602

### SCANNER SPECIFICATIONS\*

Scan speed A4	42 opm
Scan resolution	600 x 600 dpi
Scan modes	TWAIN scan; Scan-to-HDD; Scan-to-FTP; Scan-to-SMB; Scan-to-eMail
Scan formats	TIFF (single and multi page); PDF

### COPIER SPECIFICATIONS\*

Gradations	256 gradations
Magnification	25–400%; in 0.1% steps
Multiple copies	1–9,999

### ACCESSORIES

Working table	WT-512
Air suction paper feed unit	PF-707
Air suction paper feed unit with ADF	PF-708
Heating unit for PF-707/8	HT-506
Relay unit	RU-511
Humidification unit	HM-101
Multi (GBC) punching unit	GP-501
Relay unit	RU-510
Auto ring binding unit	GP-502
Folding and punching unit	FD-503
Stacking unit	LS-506
Booklet making unit	SD-506
Perfect binding unit	PB-503
Stapling unit	FS-532
Saddle stitch kit for FS-532	SD-510
Punch kit for FS-532	PK-522
Post inserter for FS-532	PI-502

\* Requires PF-708

- All specifications refer to A4-size paper of 80 gsm quality.
- The support and availability of the listed specifications and functionalities varies depending on operating systems, applications and network protocols as well as network and system configurations.
- The stated life expectancy of each consumable is based on specific operating conditions such as page coverage for a particular page size (5% coverage of A4).
- The actual life of each consumable will vary depending on use and other printing variables including page coverage, page size, media type, continuous or intermittent printing, ambient temperature and humidity.
- Some of the product illustrations contain optional accessories.
- Specifications and accessories are based on the information available at the time of printing and are subject to change without notice.
- Konica Minolta does not warrant that any prices or specifications mentioned will be error-free.
- All brand and product names may be registered trademarks or trademarks of their respective holders and are hereby acknowledged.



KONICA MINOLTA

# bizhub PRESS C1100/C1085

# Spec Sheet

## System

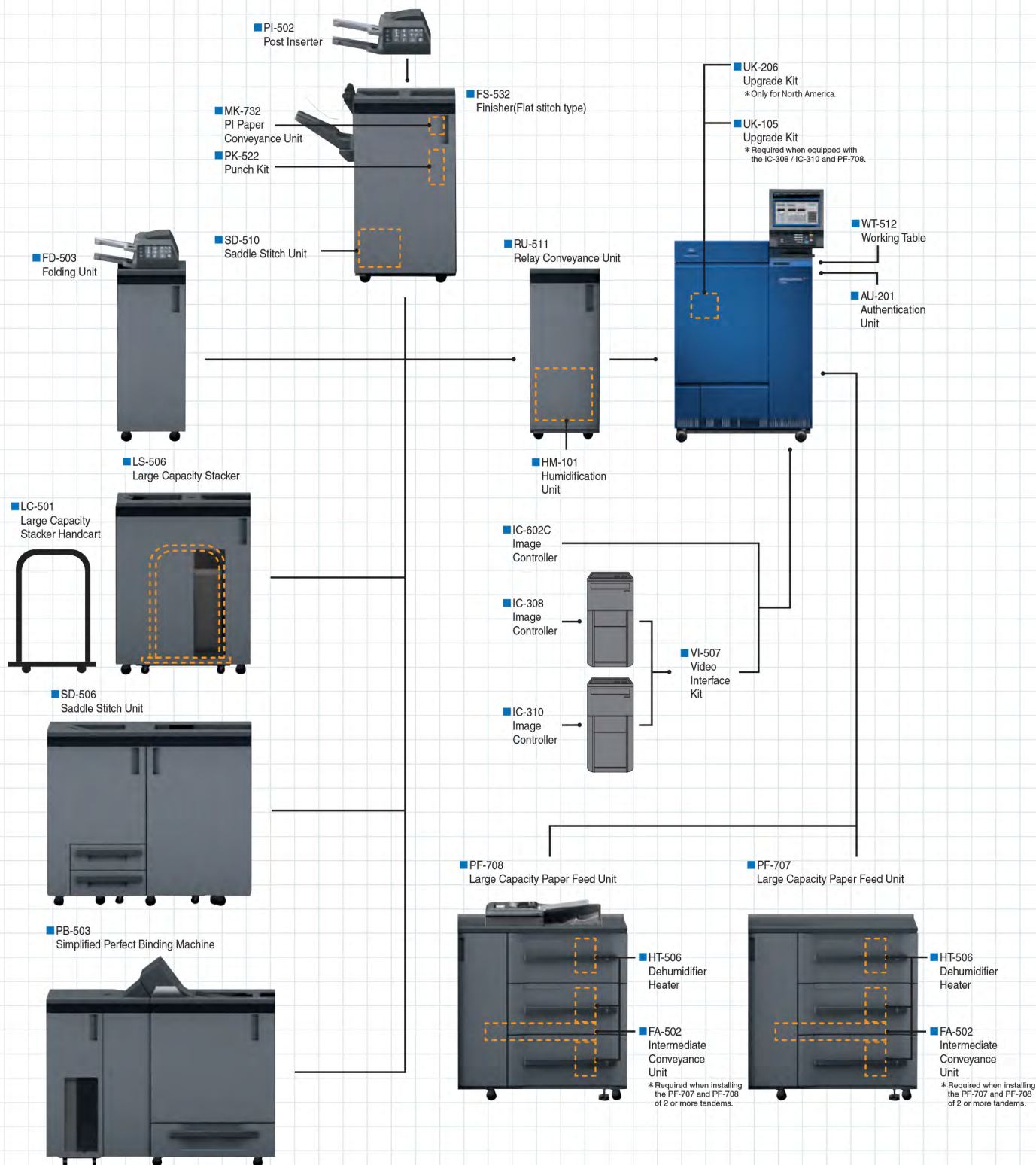

This product is not available for some countries or regions.

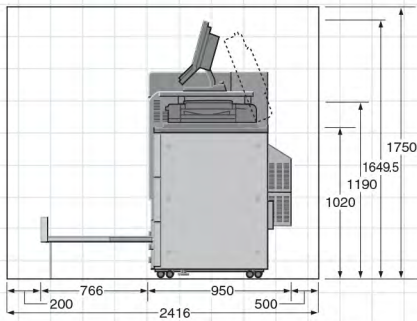

SD-506 + RU-511 + Machine + WT-512 + PF-708

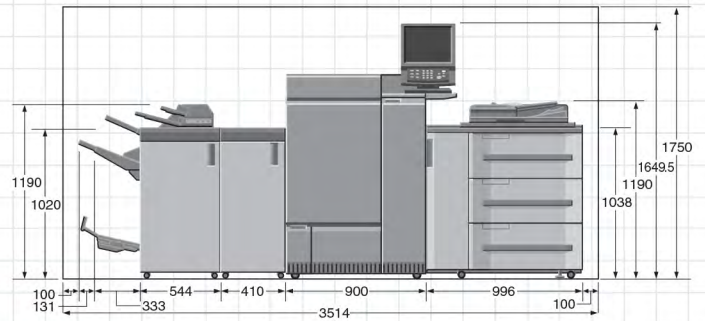

FS-532 (PI-502/MK-732/PK-522/SD-510) + RU-511 + Machine + WT-512 + PF-708

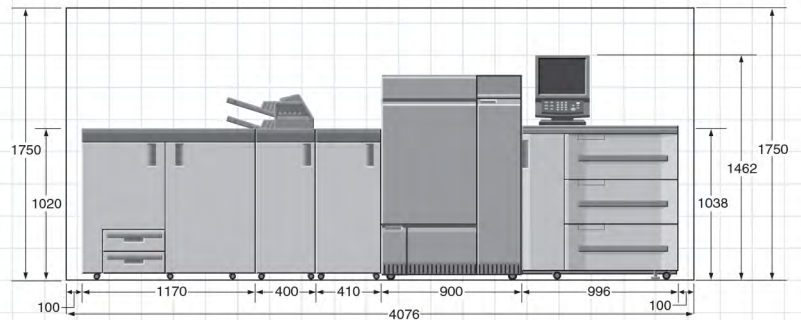

SD-506 + FD-503 + RU-511 + Machine + PF-707

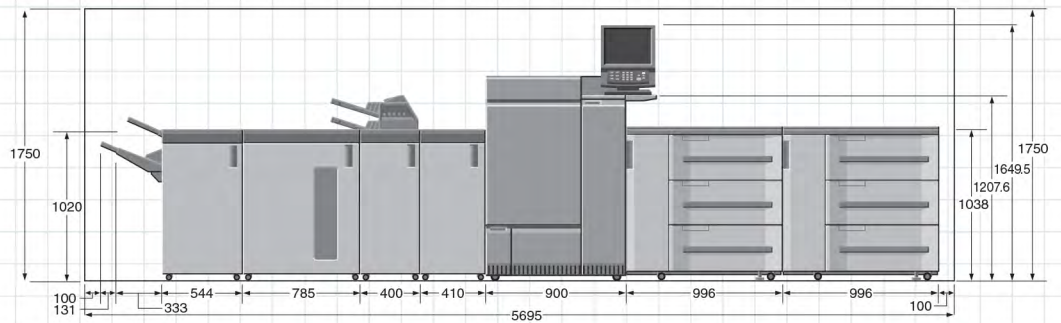

FS-532 + LS-506 + FD-503 + RU-511 + Machine + WT-512 + PF-707 + PF-707

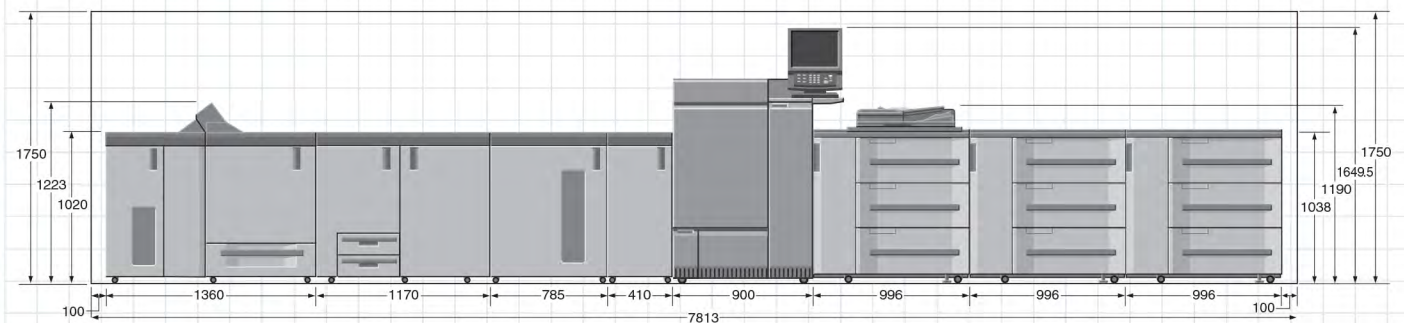

PB-503 + SD-506 + LS-506 + RU-511 + Machine + WT-512 + PF-708 + PF-707 + PF-707