



End Violence Against Women International
(EVAWI)

Laboratory Analysis of Biological Evidence and the Role of DNA in Sexual Assault Investigations

Sergeant Joanne Archambault (Ret.)
Kimberly A. Lonsway, PhD
Patrick O'Donnell, PhD
Special Agent Lauren Ware, MFS

November 2015
Updated January 2021

Table of Contents

OnLine Training Institute	5
Public Domain Notice	5
Recommended Citation.....	5
Authors.....	6
Acknowledgements	8
Objectives	9
Introduction	10
Overview of Module	13
Organizational Features	13
Part I: Essential Concepts and Historical Context - DNA Profiles and Databases	14
Serological Analysis.....	14
Advent of DNA Technology	15
Combined DNA Index System (CODIS).....	16
Offender DNA Profiles	17
Forensic DNA Profiles	19
Growth of CODIS Indices	20
Identifying a “Hit”.....	21
Three Tiers of CODIS: Local, State, and National.....	24
Local DNA Index System (LDIS)	24
State DNA Index System (SDIS)	25
National DNA Index System (NDIS)	26
Putting It All Together	26
Part II: DNA Testing and Technology	30
Step 1: Screening	31
Step 2: DNA Typing.....	31
Restriction Fragment Length Polymorphism (RFLP)	32
Polymerase Chain Reaction (PCR)	34
Transition and Resource Crisis.....	35
A New PCR Tool: Y-STR Testing	36
Selective Degradation.....	42
Mitochondrial DNA: The Other Type of DNA	43
Comparing DNA Types and Testing	45
Looking to the Future.....	46
Part III: Case Example of a Multi-State Series and the Lessons Learned.....	47



Case Example of James Allen Selby	48
The Lessons and the Goal.....	51
If the Selby Case Happened Today	53
Looking Back and Moving Forward.....	54
Part IV: Purposes and Recommended Practices	55
for DNA Evidence.....	55
Types of Biological Evidence	55
Sources of Biological Evidence	57
Which Evidence is Likely to be Most Probative?	70
Obtaining a Forensic Examination of the Suspect	73
Evaluating Evidence and Prioritizing Analysis	77
Submitting a DNA Request to the Laboratory.....	83
Reporting DNA Results and Complicated Statistics.....	88
Interpreting Conclusions	90
Evidence Consumption and Small Samples.....	91
Practical Application: Case Examples	92
Case Information for Scenario #1: Forcible Rape of 16 Year Old by 28 Year Old Soccer Coach	93
Case Information for Scenario #2: Forcible Rape, Digital Penetration and Oral Copulation by Two Suspects	100
Case Information for Scenario #3: Suspected Drug Facilitated Sexual Assault by Possible Fraternity Members	108
Case Information for Scenario #4: Forcible Rape and Sodomy by a Stranger Who Offered Victim a Ride Home	117
Case Information for Scenario #5: Attempted Sexual Assault by a Stranger in a Park.....	122
Part V: Recommendations for Policies and Practices	124
1. Expand Testing of Forensic Evidence	125
2. Test Evidence Based on the Assault History	132
3. Improve Communication with Laboratories.....	134
4. Encourage Victim Access to Medical Forensic Exams	136
5. Expand the Use of Suspect Examinations.....	137
6. Exclude Consensual Partners	139
9. Consider Establishing a Specialized Unit	145
10. Ensure that All Qualifying Profiles are in CODIS	145
11. Develop Policies and Protocols for Evidence Retention, Storage, and Destruction.....	149
12. Establish a Computerized Tracking System	154



13. Collect Data on Case Processing and Outcomes	160
14. Invest in Forensic Laboratories	163
15. Improve DNA Technologies	164
References	170
Appendix List	174



OnLine Training Institute

This module is part of EVAWI's OnLine Training Institute (OLTI), which includes review exercises, practical applications, and an end-of-course test. Participants can also download a personalized certificate of completion to use for continuing education or other purposes. For more information, please see the [EVAWI website](#).

Public Domain Notice

Unless something is excerpted directly from a copyrighted source, all the material in this document is in the public domain and may be reproduced or copied without specifically requesting permission from End Violence Against Women International (EVAWI) or the authors. Any direct quotes or excerpts should be properly cited. No one may reproduce or distribute this material *for a fee* without EVAWI's specific, written authorization.

Recommended Citation

Archambault, J., Lonsway, K.A., O'Donnell, P. & Ware, L. (2021). *Laboratory Analysis of Biological Evidence and the Role of DNA in Sexual Assault Investigations*. End Violence Against Women International.

Authors

Sgt. Joanne Archambault (Retired, San Diego Police Department) is the Founder and Chief Executive Officer for End Violence Against Women International (EVAWI). Prior to founding EVAWI, Sgt. Archambault worked for the San Diego Police Department for over 22 years, in a wide variety of assignments. During the last 10 years of her service, she supervised the Sex Crimes Unit, which investigated approximately 1,000 felony sexual assaults each year. Under her leadership, the San Diego Police Department's Sex Crimes Unit was recognized for pioneering research, groundbreaking victim-centered practices, and multidisciplinary collaboration that changed law enforcement responses to sexual assault across the nation. She also established and operated a highly successful for-profit training and consulting business for 22 years, providing expert guidance to hundreds of police departments and allied agencies, and training tens of thousands of practitioners.



In 2003, Sgt. Archambault founded EVAWI, a nonprofit organization dedicated to improving criminal justice responses to sexual assault and other forms of gender-based violence. Starting from scratch, she has grown EVAWI into the premier training organization on sexual assault investigations, providing superior training and resources, influencing national policy, and mentoring a new generation of leaders. In 2011, she achieved a dream first envisioned while working in the San Diego Police Department's Child Abuse Unit in 1985 – the launch of Start by Believing, a public awareness campaign designed to transform the way society responds to victims of sexual violence. With campaigns in all 50 US states, several US territories and protectorates, and numerous countries, this vision is now becoming a reality, changing the world for victims, one response at a time.

Dr. Kimberly A. Lonsway earned her PhD in the Department of Psychology at the University of Illinois, Urbana-Champaign. Her research career has focused on sexual violence and the criminal justice and community response systems, and she has written one book and over 100 training modules, bulletins, research articles, book chapters, and government reports on related topics. She has also trained thousands of professionals around the world, testified as an expert witness in criminal and civil court cases, and volunteered for over 15 years as a victim advocate. In 2012, she was awarded the first-ever Volunteer of the Decade Award from the Sexual Assault Recovery and Prevention (SARP) Center in San Luis Obispo, California. In 2003, Dr. Lonsway was invited to serve as a Founding Director for End Violence Against Women International (EVAWI), a fledgling nonprofit dedicated to improving criminal justice responses to sexual assault and other forms of gender-based violence. In 2004, she assumed the role as Director of Research, and she has since helped grow EVAWI into the premiere criminal justice training organization on sexual assault investigations, providing superior training and resources, influencing national policy, and mentoring a new generation of leaders.



Dr. Patrick O'Donnell received his Bachelor of Science degree in biology from Santa Clara University in 1982 and his doctoral degree in molecular biology jointly from the University of California, San Diego and San Diego State University in 1988. In November of 1990, he was hired by the San Diego Police Department (SDPD) to design and build a DNA laboratory for the agency. Over 25 years, the SDPD Forensic Biology (DNA) Unit has established a progressive reputation with the latest focus being the implementation of GlobalFiler, using software expert systems to aid in the interpretation of complex DNA mixtures. As of September 2015, the laboratory has a staff of 18 and serves a population of 1.5 million people living within the city limits of San Diego.



Lauren Ware is the Chief of the Forensics and Special Investigative Branch at the Federal Law Enforcement Training Center (FLETC) in Glynco, Georgia. In this position, Ms. Ware leads a staff of 16 forensic instructors who are responsible for researching, designing and delivering the most current, relevant, and accurate forensics and specialized investigative techniques available to federal law enforcement officers. Prior to this, Ms. Ware spent 10 years as a special agent with the Air Force Office of Special Investigations (AFOSI) and continues to serve in a reserve capacity. Her formal education includes a bachelor's degree in Physical Anthropology awarded from the University of Hawaii, and a master's degree in Forensic Sciences, with a concentration in crime scene investigation, from George Washington University.



Acknowledgements

We are extremely grateful to the following individuals (listed in alphabetical order), for their valuable contributions to the development of this training module:

- Sergeant Liz Donegan (Ret.), Austin Police Department, Sex Offender Apprehension and Registration (SOAR) Unit, Austin, TX
- Diana Faugno, Forensic Registered Nurse Consultant, Palm Desert, CA
- Christine Herrman, Attorney, Salem, OR
- Linda Ledray, RN, PhD, FAAN, Founder and Director, Sexual Assault Resource Service, Minneapolis, MN
- Detective Sergeant Jim Markey (Retired), Phoenix Police Department, Phoenix, AZ
- Misty Marra, MSFS, Forensic DNA Analyst III, DNA Laboratory Coordinator, Associate Graduate Faculty Member, Marshall University Forensic Science Center, Huntington, WV
- Mary DuFour Morrow, Assistant Prosecuting Attorney, Wayne County Prosecutor's Office, Detroit, MI
- Patti Powers, Senior Deputy Prosecuting Attorney, Yakima, WA
- Rana Sampson, Problem-Oriented Policing Consultant, San Diego, CA
- Cathy Stephenson, Assistant District Attorney, San Diego, CA



Objectives

At the end of this training module, the learner will be better able to:

- Demonstrate the importance of a competent, thorough investigation in a sexual assault case, including the use of DNA analysis.
- Describe what the Combined DNA Index System (CODIS) is and explain how local, state, and national levels of the database function.
- Explain the need for evidence collection, including a forensic examination of the victim and suspect, clothing, photographs, and other evidence from the crime scene.
- Describe how law enforcement investigators screen the evidence collected in a sexual assault case and identify what is likely to be the most important or probative, given a specific sexual assault scenario.
- Through case examples, illustrate how probative biological screening and DNA testing can assist in the development of a case.
- Prepare to submit a comprehensive request for analytic services to the laboratory, and ensure that the request contains all the essential elements.
- Explain the two-step process taken by laboratories to analyze biological evidence in a sexual assault case, which includes: (1) Screening to identify and localize potentially probative evidence, and (2) Developing a DNA profile.
- Articulate a basic understanding of the various DNA tests available.
- Describe the content of various laboratory reports (e.g., screening and DNA profiling results) and explain the purposes they serve.
- Articulate a basic understanding of the statistical frequencies associated with a DNA profile and explain what they mean.



Introduction

In September 1997, a woman named Patty – who has a severe visual impairment, and in fact is legally blind – was awakened from her sleep, and raped and sodomized at knifepoint. A forensic examiner documented two lacerations on Patty's left cheek, one on her neck, and another on her finger that required two stitches. Also documented was a bruise on Patty's thigh and an abrasion on her anus. Later when Patty was brushing her hair, a clump of hair fell out, and Patty remembered that the rapist had grabbed her head and pulled it down toward his groin during the sexual assault.

Patty reported the crime to law enforcement, and while she had good experiences with the patrol officer, health care provider, police photographer, and other professionals, it was clear from the outset that the detective assigned to her case did not believe her. He questioned her about details in her statement that he believed were missing, inconsistent, or implausible. He asked her boyfriend whether she would make up something like this. He asked the forensic examiner if the lacerations could have been self-inflicted and whether someone who was sodomized should have been injured more significantly – “ripped apart,” in his words.

The evidence kit from Patty's medical forensic examination was submitted to the crime laboratory for analysis, along with other items collected from the crime scene. No foreign DNA was identified, but some critical items remained unexamined, including: Patty's bedding, bra, and phone – which the rapist had handled. When the detective called Patty to set up a meeting to obtain additional hair samples, she believed this was good news and there was a break in the case. Not so. She was taken to a tiny room in the building's basement (actually a former jail cell), with cement block walls and no windows. The detective began the interview by saying, “I know who did this.” “You did.” “I know you made this up.”

From Interview to Interrogation

From this point, Patty was subjected to a grueling interrogation. Among other untrue statements, the detective told her that the test results for “latex residue” had come back negative, presumably from the condom she said the suspect used during the sexual assault. In reality, no such test had been conducted. After hours of this humiliating ordeal, Patty felt guilty, confused, exhausted, and frightened. Patty told the detective, “If you're going to drop this, I'll say whatever you want.” “Yeah, okay, I'm lying.”

The detective then grilled Patty about details of her supposed fabrication, and she did her best to provide answers. In the beginning, some of Patty's answers contradicted information the detective provided, but she became more compliant over time. At some point she told the detective, “I'm just saying this to get out of here.” “I wish I were dead.”

“Forty-One Reasons”

With her “confession” in hand, the detective sought charges against Patty for falsely reporting the rape. To support his effort, he compiled a list of “Forty-One Reasons” why he believed Patty was lying:

These are the Observations, Discrepancies, Inconsistencies, and Changing of the Story that lead me to have reason to believe that [the victim] was making a false allegation prior to her confession.

These “Forty-One Reasons” included the following:

- Did not appear overly concerned about the incident. Not apathetic or detached just matter of fact. I did not observe her to ever appear upset, fearful, angry, crying, bewildered, ashamed, humiliated, defiant, or upset in talking about the alleged assault.
- On more than one occasion, [the victim] laughed out loud in her recalling a portion of the assault. The laugh was not a frightened or nervous or uncomfortable laugh, it was a laugh that appeared to mock the alleged suspect, including the size of his penis.
- She did not express concern for the welfare of her daughter until I asked about it.
- My initial questions to [the victim] were to provide me with a detailed account of the assault. Her response was very abbreviated and when I asked her to be more specific, she would pause and appear to “retrieve” the answer. She had difficulty answering my questions when I asked for details. She would appear to pause and or stall and then ultimately provide an answer.
- No scratches on closet where suspect sawed on closet with the knife.
- No fingerprints.
- No pubic hairs, semen, 3 penetrations.
- No serious trauma to vagina, mouth, rectum...I know about “no trauma” in SANE language and accept their position of non-committal.
- Described suspect’s penis as “fatter than it was long.”
- When asked if the suspect ejaculated [the victim] said he did. I asked her how she knew he did and if he made a noise or groaned she said no. When asked how she knew this, she said she “could feel the rubber almost coming loose, I could feel it filling.” Several women told me not possible.¹

¹ The entire list of the Detective’s [Forty-One Reasons](#) can be found on [Bill Leuder’s website](#).

Clearly, none of these “reasons” provide actual evidence that Patty’s report was fabricated. Nonetheless, she was charged with the misdemeanor crime of obstruction of justice, which meant Patty was denied Crime Victim Compensation to cover the costs of the counseling she sought. She also had to pay attorney fees as well as court costs, although she did receive some legal services pro bono.

Out of fear for her safety, Patty moved from the apartment where she was raped. However, she had to continue paying rent for some period of time, because she couldn’t break the lease – given that her rape report was unfounded as a false report. She ended up losing her business and filing for bankruptcy.

DNA Reveals the Truth

To defend against the obstruction of justice charge, Patty was appointed an attorney who requested that the untested evidence in her case be submitted to the state crime laboratory for analysis. When the results came back with a foreign DNA profile from biological material found on her bedsheet, the charge against Patty was dropped. However, her report of sexual assault was still not investigated by the police department.

Finally in 2001 – almost four years after her rape – the DNA profile obtained from the sheet matched with a convicted sex offender named Joseph Bong. At the time of the CODIS hit, Bong was serving an 18-year sentence for armed robbery and false imprisonment. To prosecute him for Patty’s rape required jurors to overcome a mountain of conflicting testimony produced by the original investigation. Yet he was ultimately convicted and sentenced to 50 years imprisonment. With Bong’s conviction in 2004, Patty’s status finally transformed from victim to hero.

Patty’s case reveals systemic failures on many levels. The prosecutor’s office publicly apologized to Patty for some of these failures, as did the City Council, which awarded her \$35,000 in 2006 – almost 10 years after the rape. However, the police department has still refused to acknowledge any wrongdoing in the case.

Justice Denied

It would be difficult to find a more dramatic example of how biased attitudes can translate into injustice than Patty’s case, which was documented in Bill Leuders’ (2007) book, [*Cry Rape: The True Story of One Woman’s Harrowing Quest for Justice*](#). While the book provides many additional details about Patty’s ordeal, our synopsis offers an indication of how quickly an interview can turn into an interrogation when an investigator does not believe a victim of sexual assault and sets out to prove it is a false report.

Moreover, it is very clear there would have been no justice at all for Patty without the DNA hit. This leads us to question how many other victims of sexual assault are failed by the very response systems designed to help them. It is our hope that advances in DNA technology and training can prevent such failures, particularly by demonstrating how likely it is that these offenders will assault again. This module is dedicated to furthering these advances.

Overview of Module

This training module is designed to explain the modern laboratory analysis of biological evidence and explore the role of DNA evidence in a sexual assault investigation. We begin in **Part I** by defining some essential concepts and exploring the historical context of forensic DNA. For example, what is the Combined DNA Index System (CODIS)? How do the three tiers of CODIS function – on a local, state, and national level?

In **Part II**, we explain various testing procedures and technologies used for DNA analysis. This analysis is described as a two-step process, which begins with screening an item of evidence for probative biological material. The second step involves extracting and separating the DNA, and ultimately developing a DNA profile.

We then walk through a case example in **Part III** that illustrates many of the points articulated in the module. The goal is to explain how we got to the point where we are today with respect to DNA analysis – and also to point the way toward a future where the potential of DNA analysis is virtually unlimited.

In **Part IV**, we provide detailed guidance on the purposes and practices associated with DNA evidence. This includes outlining various types of biological evidence, exploring their potential utility for a sexual assault investigation, and evaluating which evidence is likely to be most probative in a particular case. We also highlight the importance of communication between law enforcement agencies and laboratories conducting analyses, and provide a number of tools to assist in improving that communication.

In **Part V**, we address problem-solving on a national level, by offering several broad-reaching recommendations to improve policies and practices in this area. The goal of such reform is ultimately to better serve victims and hold more offenders accountable.



While this module focuses on DNA and other biological evidence, the National Institute of Justice published a useful article entitled, [Sexual Assault Cases: Exploring the Importance of Non-DNA Forensic Evidence](#). Using examples, this article reassures criminal justice professionals that non-DNA evidence can be just as important in the investigation and prosecution of sexual assault, in cases where probative DNA evidence is not readily available.

Organizational Features

Throughout this module, we use a series of **case examples** to illustrate important points and provide the opportunity to apply what you have learned to a variety of scenarios. We also offer many **resources and tools** we believe will be helpful as you integrate the information into your own community's policies and practices. These tools will generally appear in resource boxes (with the icons below), but some will also be provided in the Appendix. The Appendix also includes a **Glossary** with key terms associated with DNA evidence. Supplemental information and tools are indicated with the following icons:



- 🔍 Research studies and case examples
- ★ Innovative and promising practices
- 📊 Resources and tools
- 🎥 Instructional video clips
- 📌 Information to note
- ❓ Questions for participants
- 🧠 Interactive exercises
- 💡 Policy recommendations

Part I: Essential Concepts and Historical Context - DNA Profiles and Databases

Given the enormous power of DNA analysis today, it is hard to remember that this tool has only been available to law enforcement since the early 1990's. In fact, the science of DNA as we know it only became available during the late 1980's. However, just because the technology was "available" at that point does not mean the average law enforcement agency had access to it. At the time, it was like saying we have the technology to go to the moon; this does not mean any of us will personally go to the moon in our lifetime.

Serological Analysis

Historically, laboratory analysis involved the use of serological systems such as the "A, B, O" blood typing system and protein markers including phosphoglucosyltransferase (also known as PGM). Yet this kind of serological analysis provides very limited information about suspect identity, because there are so few markers and many people share the same information at those markers. To illustrate, over one third of the American population has O+ blood type, and one-quarter to one-third have A+, depending on their ethnic group.² This means there are millions of people in the US with each blood type.



Photo credit: Berkeley Lab / Foter.com / CC BY-NC-ND

In addition, some people do not express their protein markers in some body fluids, so the victim's contribution to a sample might mask that of the suspect. Protein markers can also degrade and become unstable over time.

² The proportion of Americans with each blood type is provided on the website for the [American Red Cross](https://www.redcross.org). The percentage of Americans with O+ blood type ranges from 37% for those who identify as Caucasian, 39% for Asian-American, 47% for African-American and 53% for Hispanic. The percentages for A+ are: 24% for African-American, 27% for Asian-American, 29% for Hispanic, and 33% for Caucasian. The percentages for other blood types are quite a bit smaller (ranging from 0.1% to 18%).

As a result of these limitations, serological analysis was not used to identify an individual with any degree of statistical certainty; it was primarily used to exclude suspects.

Advent of DNA Technology

This all changed with the advent of forensic DNA analysis. Originally developed by Alec Jeffries, the first use of forensic DNA analysis is described in the book *The Bleeding* (Wambaugh, 1989), which chronicles the sexual assault and murder of two young girls in Narborough, England. The crimes took place in the early 1980's, and the book recounts how investigators were able to use DNA analysis to exclude their original suspect and identify the real killer.

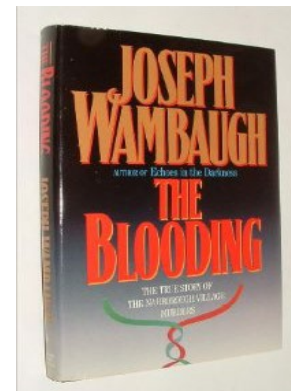

Had a serological approach been used, there would have been so little sorting information obtained from the evidence at the two crime scenes it would have been impossible to produce any meaningful identification. Semen samples were collected from the two murdered girls in Narborough, but forensic scientists at the time would only have been able to identify the blood type of the perpetrator. In contrast, Alec Jeffries' new technique, soon to be termed "DNA fingerprinting," offered the ability to sort what appeared to be an unlimited number of individuals and therefore make an identification with a much higher degree of statistical certainty.

Power of DNA Fingerprinting

The power of DNA fingerprinting stems from two primary factors. First, there are a large number of genetic markers, because DNA testing identifies characteristics at many different loci (locations) on the DNA strand. This is in contrast to prior analyses that relied on a very small number of markers (such as ABO blood typing). There are also enormous variations from person to person within these regions, so DNA typing can link evidence to a specific individual with an astonishing level of statistical certainty.

Jeffries' DNA fingerprinting technique in the Narborough case was ultimately used to identify Colin Pitchfork as the killer. This was the first time someone was convicted of homicide using DNA evidence, forever altering the contribution of biological analysis to the identification of suspects in a criminal case (Wambaugh, 1989).

Value of Comparison: DNA Databases

While the power of DNA analysis is remarkable, DNA profiles actually have limited utility in and of themselves. Their value rests primarily in the fact that they can be compared with other DNA profiles. This point is made by Dr. Rebecca Campbell and colleagues (2015), specifically within the context of a sexual assault case.

[Historically,] a DNA profile extracted from a rape kit had the potential to be helpful to investigators, but without reference samples for comparison, the likelihood of identifying an offender was low (Campbell et al., 2015, p. 74).

Within the US, DNA technology was first introduced in criminal court cases around 1988. This was the same year the Federal Bureau of Investigations (FBI) launched the national DNA database, known as the National DNA Index System (NDIS). This database was created with a software program for users to access it: the Combined DNA Index System, or CODIS. At the time NDIS and CODIS were launched, nine states participated in the program, but by 1990, this expanded to include 14 states and local laboratories. In 1994, Congress enacted the DNA Identification Act, which expressly authorized the NDIS and established the FBI's authority to maintain it for law enforcement purposes. The law also established regulations governing its use.³

Today, over 190 public law enforcement laboratories in the US meet the requirements to participate in CODIS on a national level. In addition, more than 70 laboratories in over 40 countries use CODIS, and these numbers continue to expand.⁴ This clearly demonstrates that CODIS has been established as the international standard for DNA database software. Many of these countries use CODIS software and have implemented their own national database, whereas others use the software even though they have not yet developed a national DNA database.

Expanding CODIS Core Loci

Significant change is underway, as crime laboratories in the US were required to expand the number of genetic markers they test from 13 to 20 by January 1, 2017 (Hares, 2012). This expanded set of core loci includes some of the loci from the European set, so those used by US laboratories will be more universal for comparison.⁵

This increase in the number of genetic markers is designed to serve two purposes. The first is to reduce the likelihood of a coincidental match. However, the second is to lay the foundation for a worldwide database. Due to the mobility of modern populations, it is increasingly important that crimes committed in one country can be compared to offenders or crimes in another (Hares, 2012).

Yet this change will require a considerable investment by laboratories across the country and around the globe. Not only will new kits need to be validated by US laboratories, but new equipment will also need to be purchased and analysts will need to spend time on implementing and validating the new technology. As a result, the transition may decrease the output of US crime laboratories for a time, while personnel are taken off casework to focus on validation tasks.

Combined DNA Index System (CODIS)

Although not everyone realizes it, the CODIS database actually includes DNA profiles in two different categories, based on how they are collected. Offender profiles are developed

³ Information on the history of NDIS and CODIS taken from the [FBI website](#) (accessed 03/03/15).

⁴ Information on the number of laboratories participating in CODIS and NDIS taken from the [FBI website](#), and described as current as of June 2012 (accessed 08/11/15).

⁵ In the UK, the National DNA Database (NDNAD) recently moved to enhanced technology that identifies DNA profiles at 17 target areas or loci (Home Office, 2014).

from reference standards collected directly from known individuals, while forensic profiles are developed based on biological evidence recovered from the victim, the suspect, or the crime scene.

Offender DNA Profiles

Most of the DNA profiles in CODIS are offender profiles, collected from individuals arrested or convicted for certain qualifying offenses. Biological evidence is collected from these individuals by drawing blood or using a buccal (mouth) swab. The samples are described as reference standards, and they are submitted to a forensic laboratory to develop a DNA profile. These profiles are also sometimes referred to as known offender profiles or DNA database reference samples (Nelson, Chase & DePalma, 2013). Offender profiles are then uploaded into the Convicted Offender Index or Arrestee Index, both of which are a part of the CODIS system.

Offender Index in CODIS

Each state has independent legislation that determines which offenders will have reference samples collected and analyzed, and which DNA profiles will be entered into the Offender Index in CODIS. Beginning in the late 1980's, states began to enact laws requiring the collection of DNA profiles from offenders *convicted of certain crimes*.⁶ At the time, this included only the most violent crimes as well as certain sexual assault offenses. These were described as qualifying offenses.

Then in 1988, Colorado became the first state requiring reference standards to be collected from all sex offenders (as defined in the authorizing legislation). Virginia followed suit a year later, requiring blood samples to be collected from sex offenders as well as other violent offenders. In 1990, Virginia expanded its law to include all convicted felons (Doleac, 2011). By 1999, five states had enacted laws requiring DNA reference standards to be collected from anyone convicted of a felony.

By 2003, 27 states had passed legislation authorizing the collection of DNA reference standards from individuals convicted of any felony. By 2008, that number was 42 (Hurst & Schellberg, 2013).

⁶ Information on CODIS and state legislation taken from a [statement by Dr. Christian Hassell](#), Assistant Director of the Laboratory Division of the FBI, made before the House Committee on the Judiciary, Subcommittee on Crime, Terrorism, and Homeland Security in Washington DC, on May 20, 2010 (accessed 03/03/15).

Today, all 50 states as well as the federal government have laws requiring the collection of DNA samples from individuals convicted of certain crimes.⁷ In fact, the federal government has come to view DNA collection as simply one more standard booking requirement, on par with taking a photograph and fingerprinting an individual at the point of arrest.⁸ as stated by the US Supreme Court in the case of *Maryland v. King*.⁹

Some states have even authorized the collection of DNA samples from individuals who are convicted of certain misdemeanors (Hurst & Schellberg, 2013). Congress has also authorized the collection of DNA samples from anyone arrested, facing charges, or convicted of a federal offense – and to non-US residents detained under the authority of the United States.¹⁰

When officers make an arrest supported by probable cause to hold for a serious offense and they bring the suspect to the station to be detained in custody [i.e., booked], taking and analyzing a cheek swab of the arrestee's DNA is, like fingerprinting and photographing, a legitimate police booking procedure that is reasonable under the Fourth Amendment (Maryland v. King, 2013, p. 1980).

These legislative developments have led to a dramatic increase in the number of reference standards collected from known individuals and submitted to the laboratory for testing. As a result, many laboratories have faced significant backlogs. Congress first responded to this concern in 2001 by passing the [DNA Backlog Elimination Act](#), which appropriated \$140 million for DNA testing. The Act was reauthorized in 2004 (as the Debbie Smith Act), and then reauthorized again in 2008 as well as 2014. Taken together, this series of legislative action has allocated millions of federal dollars for the collection and testing of forensic DNA evidence. Yet even more funding is likely to be available in the future. In September 2015, for example, Vice President Joe Biden and Manhattan District Attorney Cyrus Vance Jr. announced a combined \$79 million to be used for addressing untested evidence in sexual assault cases (Reilly & Jones, 2015).

Arrestee Index in CODIS

While there has been a trend with states expanding the collection of DNA from individuals convicted of any felony – and now certain misdemeanors – this trend has continued with states authorizing DNA samples to be collected at the point of arrest, rather than conviction. These profiles are entered into the Arrestee Index in CODIS.

⁷ Information on state and federal legislation taken from the website for the National Institute of Justice, on a page entitled [DNA Evidence Backlogs: Convicted Offender and Arrestee Samples](#) (accessed 03/03/15).

⁸ Under the 2006 DNA Fingerprint Act, federal law enforcement agencies are authorized to “collect DNA samples from individuals who are arrested, facing charges, or convicted” of a federal crime (28 C.F.R. 2212(b)). Collection of a DNA sample is also a mandatory condition of pretrial release under federal law (18 US C 3142(b)(c)(1)(A)), including incidents where the sample may not have been collected at the time of the initial booking. These collections are performed using a standardized kit provided by the FBI free of charge; the kits are in turn sent back to the FBI Laboratory for analysis and resulting profiles are uploaded into CODIS.

⁹ [Maryland v. King 569, US 435, 133 S. Ct. 1958 \(2013\)](#).

¹⁰ [42 US Code § 14135a](#)v - Collection and use of DNA identification information from certain Federal offenders.

In 1999 only one state had passed legislation requiring the collection of DNA samples when someone was arrested for certain crimes (Hurst & Schellberg, 2013). However, following a series of sexual assault homicides committed in Baton Rouge between 2001 and 2003, Louisiana authorized DNA collection from individuals who were arrested for any felony, as well as some misdemeanors.

As of December 2012, 28 states had passed legislation authorizing the collection of DNA from individuals at the point of arrest, for certain qualifying offenses.¹¹ For a summary of these arrestee laws (as of July 2014), please see the following image, which is drawn from a presentation by Lisa Hurst of Thomas Gordon Honeywell Governmental Affairs. The slide depicts which states collect a DNA sample from arrestees at the stage of booking versus indictment, and also provides information on the point at which the sample is analyzed as well as potentially expunged.

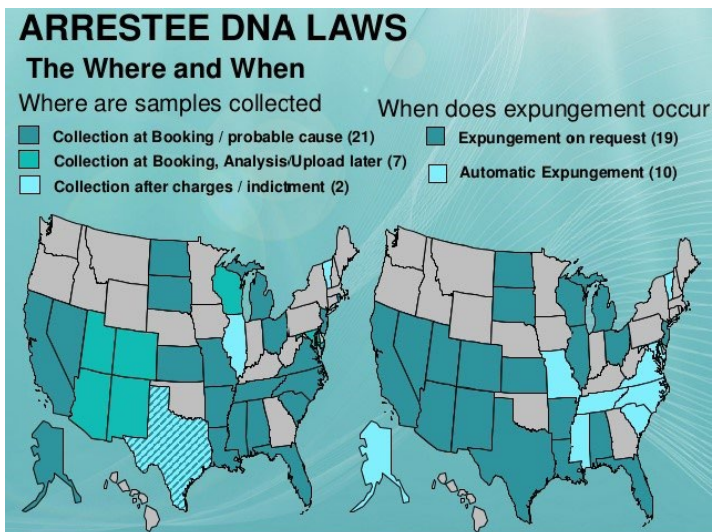

Forensic DNA Profiles

Beyond offender profiles, the second type of DNA profiles are developed from evidence collected from: the body or clothing of the victim; the body or clothing of the suspect; and/or items collected from the crime scene(s). These DNA profiles are referred to as forensic profiles, and they are uploaded to the Forensic Index, which is another part of CODIS.

The profiles are also frequently referred to as forensic unknowns, but this does not necessarily mean the suspect in the case is truly unknown. Law enforcement may know who their suspect is, based on information provided by the victim or other sources. The terminology is simply used to distinguish a DNA profile developed from forensic evidence rather than reference standards collected directly from a known individual.



Forensic Index in CODIS

Before a forensic DNA profile can be entered into the Forensic Index of CODIS, laboratories must provide assurance that the evidence is associated with a criminal offense. This is accomplished by establishing the elements of the offense, typically through the victim's initial statement. This is why evidence from a sexual assault case should not be submitted to CODIS until the victim has personally talked with law enforcement. (We will return to discuss this topic in more detail later).

¹¹ Information on state legislation on the collection of DNA from arrestees taken from the website for the National Institute of Justice, on a page entitled [DNA Sample Collection from Arrestees](#) (accessed 03/03/15).

Historically most of the forensic profiles in CODIS have been collected in cases of violent crimes against persons such as homicide, sex crimes, and felony or aggravated assaults. However, with the success of CODIS there has been a tremendous push for laboratories to enter DNA profiles from property crimes as well (Nelson, Chase & DePalma, 2013). Increased demand has therefore been one factor contributing to the backlog of DNA evidence submitted to the crime laboratory awaiting analysis.

In fact, the National Institute of Justice concluded in 2013 that the DNA backlog has only continued to increase, despite dramatic improvements in laboratory capacity and automation, as well as millions of dollars in federal funding to support this work. With advances such as “touch DNA,” which can expand testing for the most minute of biological samples, it is unclear whether the improved capacity, speed, and efficiency of DNA analysis will ever be able to catch up with the exponential increases in demand.

Growth of CODIS Indices

In sum, two types of DNA profiles are archived in three CODIS indices. DNA profiles from *known individuals* are stored in the *Convicted Offender Index or Arrestee Index*, depending on whether they were collected from the person at the point of arrest versus conviction. On the other hand, *forensic DNA profiles* are developed from evidence rather than known individuals, and they are stored in the *Forensic Index*.¹² All three indices are a part of the CODIS system.

The CODIS database thus continues to grow, as DNA profiles are submitted. As of April 2015, the entire database included over 11.7 million profiles from convicted offenders, as well as 2 million from arrestees, and 630,000 from forensic evidence.¹³

Yet the pattern of growth has not been the same across the three indices. As states expanded the collection of DNA reference standards from convicted offenders, the Offender Index was the first to dramatically increase in size. The Arrestee Index now appears to be following a similar trajectory, as states further expand the collection of DNA at the point of arrest rather than conviction. When it comes to the Forensic Index, however, the pattern of growth has lagged behind. This is due in large part to the different level of resources required to develop a forensic profile versus an offender profile.

Cost of Forensic vs. Offender Profiles

Developing a DNA profile from a known reference standard is a very straightforward process that can be automated, which is why it has been conducted with ever-increasing speed and decreasing costs over time. Current estimates range from approximately \$20-40

¹² For more information, please see the [CODIS page](#) of the FBI website (accessed 03/03/15).

¹³ Statistics on CODIS and NDIS taken from the [FBI website](#) (accessed 02/04/15).

to profile a single offender sample.¹⁴ However, the process of developing a DNA profile from forensic evidence requires painstaking work conducted manually by laboratory personnel. To illustrate, extracting a foreign DNA profile from a vaginal swab requires separating out biological material originating from the victim, to differentiate it from sperm originating from the potential suspect. Information collected from the victim will then be used to identify possible contributors of the foreign DNA and ensure that any consensual sexual partner has been excluded. This is why the estimated cost to analyze a sexual assault evidence kit is approximately \$1,000.¹⁵

For other types of forensic evidence, the process is even more labor-intensive. For example, consider the effort required of a forensic scientist to analyze possible evidence from items such as sofas, cars, clothing or bedding. If an investigator has submitted a pair of underwear that the victim wore immediately after the assault, or a comforter from the bed where the sexual assault was committed, a criminalist must examine the entire item, locate any biological samples, conduct extensive manual sample manipulations, and then conduct the final procedure to develop a DNA profile. Each of these steps requires significant time and costs.¹⁶

This is part of the reason why the Forensic Index has increased at a much slower pace than the Convicted Offender and Arrestee Indices. While this is changing as the demand for forensic DNA analysis increases, it is clear that we will only achieve the full potential of DNA in a sexual assault investigation when all the various types of forensic evidence are tested (when this is warranted based on the specific facts of the case). To highlight this point, simply recall Patty's case at the beginning of the module, where the rapist's DNA was found on a bedsheet, not on any of the items in the evidentiary kit. This was because the perpetrator used a condom during the sexual assault.

Identifying a “Hit”

As DNA profiles are submitted to all three indices within CODIS, routine comparisons are conducted. Two types of matches – often referred to as “hits” – can result.

¹⁴ Because private laboratories compete for contracts with state agencies, the cost of analyzing a reference sample from an arrestee or convicted offender is estimated to be in the range of \$20-40. This reflects the cost to process the sample and produce a DNA profile. There will be additional costs for the government laboratories to review the private laboratory's data, conduct a site visit, and upload the profile into CODIS. However, these additional costs will be shared across all of the tests conducted in a contracted batch, so the expense associated with a single sample will increase only incrementally from the estimated unit cost.

¹⁵ The National Institute of Justice has estimated that it costs an average of \$1,000 to analyze a sexual assault evidence kit (Ritter, 2012). Of course, the actual cost in any individual case will vary, as will the amount of time it takes to conduct the analysis. For example, at the San Diego Police Department's Forensic Biology (DNA) Unit, criminalists may spend about 6-7 hours of analysis time to screen a sexual assault evidence kit – yet this is for the biological samples only. If the results are negative, the laboratory will go on to analyze any clothing that has been submitted. Some laboratories have also streamlined the process by analyzing only the three swabs most likely to yield probative evidence. Any detection of male DNA will then require additional laboratory testing.

¹⁶ The process of analyzing an evidentiary kit may even require a great deal of physical movement. In one study, researchers have documented that a typical sexual assault case required criminalists to travel a total of 2.4 miles within the laboratory to complete their analyses (Richard & Kupferschmid, 2011).

The first is a *hit to offender*, where a forensic unknown profile matches to a known offender. Once the match is confirmed, the name of the offender will be provided to the laboratory that submitted the forensic unknown, as well as the investigator in the case. This type of hit can advance a case, either by revealing the identity of a suspect who was previously unknown, confirming the identity of a suspect who was already known, or excluding a suspect from consideration. It can also connect a suspect with evidence collected from other crimes.

The second type of hit is an *unknown to unknown*, where no offender is identified, but two or more cases are identified as sharing the same forensic DNA profile. This means that the same (still unknown) perpetrator is involved. While this type of hit does not specifically identify a suspect, it can yield investigative leads that may ultimately help law enforcement make an identification and possibly link a suspect to multiple crimes.

Partial Matches and Low Stringency Searches

Other possibilities also exist for DNA searches and matches. For example, when a CODIS search is conducted, the stringency level can be set at high, moderate, or low (Williamson, 2015a). High stringency searches require a perfect match at every single allele. However, searches between the Forensic Index and Convicted Offender Index are conducted at a moderate level, which requires all the compared alleles to match, but allows the profiles to have a different number of alleles.¹⁷ This is done for several reasons. First, DNA profiles developed from forensic evidence may be partially degraded and laboratory results may indicate there is DNA from more than one person. Laboratories also use different DNA typing kits for testing. By searching for matches between the Convicted Offender and Forensic Index at the moderate stringency level, this allows for all of these possibilities. As a result, the search will potentially yield hits that would have been missed if it was conducted at the level of high stringency.¹⁸

In some cases, an investigator may even request a *low stringency* search. This can be useful when a forensic DNA profile has been submitted to CODIS but no match has been identified at the local, state, or national level (at the default level of moderate stringency). This type of low stringency search will not have the ability to identify a specific individual with any degree of statistical certainty, but it could potentially help to produce investigative leads by narrowing down the list of potential suspects, or excluding one or more suspects from consideration.

To illustrate, if an investigator receives a list of partial matches from a low stringency search, the list can be narrowed down using Y-STR testing or other information in the case (such as the age and description of the suspect, geographic location, etc.). Low stringency searches can only be conducted, however, at the local or statewide level; they cannot generally be conducted in NDIS (Williamson, 2015a).

¹⁷ Please see the [Frequently Asked Questions \(FAQs\) on the CODIS Program and the National DNA Index System \(NDIS\)](#), on the FBI website (accessed 10/13/15).

¹⁸ Please see the [Frequently Asked Questions \(FAQs\) on the CODIS Program and the National DNA Index System \(NDIS\)](#), on the FBI website (accessed 10/13/15).

Familial Searches

Familial searches can also be conducted at the local, and sometimes state level, when a CODIS search reveals no matches. This process is described on the FBI website.¹⁹

Familial searching is a deliberate search of a DNA database conducted for the intended purpose of potentially identifying close biological relatives to the unknown forensic profile obtained from crime scene evidence (FBI website).

Familial searches are based on the fact that half of a person's DNA profile is inherited from the father and half from the mother. As a result, close relatives will share a significant proportion of their DNA profile (e.g., parent and child, or two siblings). A familial search can therefore be used to look for DNA profiles of close relatives, in cases where an offender has left DNA evidence at the crime scene but his/her own profile is not included in the database. The search may produce a list of possible relatives for the offender, which can then be used in combination with other intelligence information (e.g., age, geography) to narrow down the list of possible suspects for further investigation (Home Office, 2014).

At this point, familial searches cannot be conducted in NDIS. However, they can be conducted on a local level, and in SDIS in some states (such as California, Colorado, Texas, Virginia, Florida, and Wisconsin). However, certain stringent criteria must be met to conduct a familial search in SDIS. For example, they can typically only be conducted after all other investigative leads have been exhausted (Williamson, 2015a). To find out if familial searching is a tool available to law enforcement investigators in your state, please consult with your laboratory or state CODIS administrator.

Case Example

Partial matches can sometimes even be made with a family member without a familial search. This is illustrated with a case from the San Diego Police Department. In this case, a sixth grade girl who was normally cheerful at school began appearing troubled and acting out in class. She said she was not feeling well and the school nurse was summoned. The young girl then told the nurse she had been sexually assaulted by a male classmate earlier in the day. She described sexual acts constituting penile-vaginal penetration. The police were called and the male student was taken into custody. The victim was taken to the hospital for a medical forensic examination.

When the evidence from the victim's forensic evidence kit was submitted to the crime laboratory, semen was detected on the vaginal swab. A complete DNA profile was developed from the sperm, and it was compared to the male classmate's DNA, but he was excluded as the potential donor. The profile was then compared with the victim's own reference standard, and it was noted that both individuals shared a DNA type at each genetic marker. This pattern is only expected when two individuals share a parent-child relationship, meaning that the victim's biological father was actually the source of the semen. Follow-up interviews with the victim revealed that she was trying to shift the focus

¹⁹ Please see the page on [Familial Searching](#), on the FBI website (accessed 10/14/15).

from her father as the perpetrator because she “did not want to get him into trouble.” She had randomly selected the male classmate to name as the suspect.

This type of indirect disclosure is not uncommon among children and other victims with limited education, experience, or vocabulary. In fact, there are often powerful forces preventing victims of all ages from making a clear and consistent disclosure of abuse, particularly when the perpetrator is someone very close to them and/or someone upon whom they depend for essential care. Familial searches and partial matches thus provide valuable investigative tools, stemming from the enormous power of DNA.

Three Tiers of CODIS: Local, State, and National

While people often refer to CODIS as if it were a single entity, it is actually a system of databases that operate on a local, state, and national level.

Local DNA Index System (LDIS)

Most law enforcement agencies use the state crime laboratory to conduct their DNA analysis. However, some agencies contract with private laboratories or establish their own DNA laboratories (which typically operate as a semi-independent unit within the police department). Many laboratories also operate on a regional or statewide level, and/or represent part of a multi-site laboratory system. This means that most laboratories provide services for a number of law enforcement agencies.

Some law enforcement agencies even utilize the services of more than one laboratory, and sometimes different laboratories are used to meet different needs. To illustrate, in California, all offender reference samples are analyzed by the Department of Justice laboratory in Richmond, but there are also approximately 15 local laboratories across the state that analyze evidence to produce DNA profiles from forensic evidence.

In order to access the CODIS program, local laboratories must meet certain requirements, including accreditation from specific credentialing organizations. The laboratory then constitutes part of the Local DNA Index System (LDIS), storing information on DNA profiles developed from cases in that jurisdiction. This will include both offender profiles (collected at the point of arrest and/or conviction, in accordance with state law) and forensic profiles (developed from evidence collected in the case). Some local databases also include DNA profiles developed from suspect reference standards collected during the course of an investigation, before probable cause has been developed. However, this will depend on state laws, laboratory policies, and local protocols. Suspect reference standards are collected at this point as part of an investigator's casework, in the hopes of identifying, confirming, or excluding a suspect.

Searching for Matches

All local laboratories can search for matches within their own LDIS. In fact, a significant number of associations are made at the LDIS level, because most crime occurs within a limited geographic area, with little suspect movement. However, there is widespread

variation in the samples maintained in LDIS. For example, in addition to forensic and offender profiles, local databases may store DNA profiles for individuals such as crime victims, employees working in the laboratory, property clerks, and possible suspects (as described above). However, most states do not have legislation covering what can be maintained by local laboratories in the LDIS system, so limited guidance is available.

From Local to State Level

On a weekly basis, LDIS laboratories electronically send qualifying DNA profiles to the state database, which is referred to as the State DNA Index System (or SDIS). To qualify for submission to SDIS, a DNA profile must have a minimum amount of genetic information (a portion of the 13 core loci).²⁰ This is done to reduce the likelihood of coincidental matches between forensic unknowns and offender profiles in SDIS.

As a general rule, offender samples will always meet the criteria for sufficient genetic information to upload into CODIS, because they are collected using a buccal swab or blood draw directly from a known individual. However, DNA profiles developed from forensic evidence may not, particularly if the forensic sample was limited or degraded in some way. When a forensic unknown profile does not have a sufficient amount of genetic information, it simply remains at the LDIS level.

DNA profiles developed from suspect reference standards may also be eligible for submission to SDIS, depending on state law and laboratory policies. Again, these reference standards are collected from suspects during the course of an investigation (before probable cause has been developed) – in an effort to identify, confirm, or exclude a possible suspect.

While this is the general process for uploading profiles from LDIS to SDIS, it is important to note that private laboratories cannot actually upload DNA profiles themselves. Any DNA profile developed from forensic evidence by a private laboratory must first be reviewed by the government laboratory contracting their services (e.g., the local police department). Only then can it be loaded into CODIS – via the government laboratory's CODIS portal.

State DNA Index System (SDIS)

The State DNA Index System (SDIS) contains forensic unknowns submitted by each local laboratory in the state, along with offender samples analyzed either by the state laboratory or by a group of laboratories in the state. Again, we provide the example of California, where all offender samples are analyzed by the Department of Justice laboratory but 15 local laboratories also populate SDIS with forensic unknowns, from cases in their jurisdictions. As previously noted, SDIS may also store profiles from suspect reference standards, depending on state law and laboratory policies.

²⁰ Please see the [Frequently Asked Questions \(FAQs\) on the CODIS Program and the National DNA Index System \(NDIS\)](#), on the FBI website (accessed 10/13/15).

Like LDIS, each SDIS conducts a weekly comparison of DNA profiles from across the state. When there is a hit – either to an offender or a forensic unknown – the laboratory submitting each forensic unknown is notified. SDIS laboratories also upload profiles to the national level of CODIS on a weekly basis.

National DNA Index System (NDIS)

The National DNA Index System (NDIS) contains offender profiles collected under the statutory guidelines in each of the 50 states, as well as forensic unknowns submitted by SDIS laboratories across the country on a weekly basis. It does not include suspect profiles developed during the course of an investigation, before probable cause for an arrest has been developed. NDIS is administered by the FBI, and it is explicitly authorized by federal legislation.

For a forensic unknown to move from SDIS to NDIS, there is a higher standard for the minimum amount of genetic information it must contain. Any profiles not meeting this standard will remain at the SDIS level. Once again, the requirements for a minimum amount of genetic information have been established to minimize the likelihood of a coincidental match at the NDIS level.

Like SDIS, NDIS conducts comparisons on a weekly basis. When there is a hit, the laboratory submitting each profile is notified. Because NDIS is national, hits often reveal associations between offender samples and forensic unknowns from more than one state. For example, blood collected from the scene of a burglary in Illinois might match to semen from a sexual assault case in Iowa – or with a known offender convicted of homicide in Alabama.

Putting It All Together

The structure of NDIS is illustrated in the following graphic, which was contributed by Detective Sergeant Jim Markey (Retired) of the Phoenix Police Department. Using the illustration of Arizona, the graphic shows the state-level SDIS, which is operated by the Arizona Department of Public Safety, as well as several local laboratories in the LDIS system (Tucson, Phoenix, and Flagstaff).

Two states are depicted as examples of SDIS systems within the national network of NDIS (California, Illinois). However, the NDIS actually includes all 50 US states, the District of Columbia, Puerto Rico, the federal government, and the US Army Criminal Investigation Laboratory.

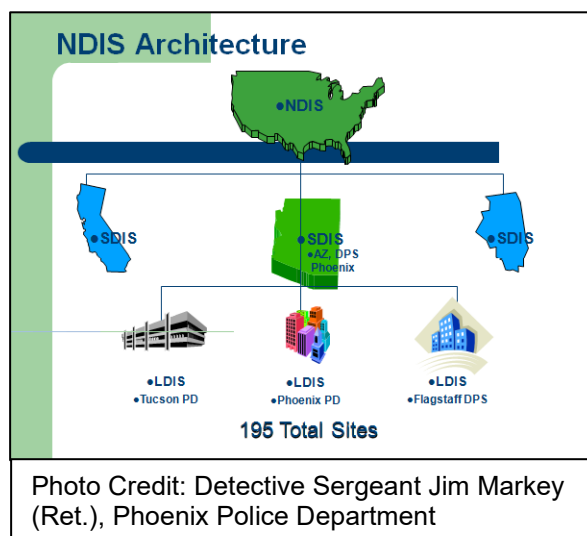

Photo Credit: Detective Sergeant Jim Markey (Ret.), Phoenix Police Department

Value in Solving Crime

As of December 2014, the three-tier CODIS system has produced over 270,000 hits and assisted in more than 258,000 investigations.²¹ This is only possible because the CODIS database has matured, with millions of DNA profiles (from offenders and evidence) submitted by laboratories across the country. CODIS may therefore be the most important tool now available to law enforcement for solving crime.

The value of DNA in solving crime is illustrated with data from the San Diego Police Department, which will be presented throughout this module based on the experiences of two of the authors. However, the examples are designed to illustrate patterns seen in law enforcement agencies and communities across the country.

In San Diego – as in many other communities – police officers often collect biological evidence at the scene of a burglary. If this evidence yields a DNA profile, data from the San Diego Police Department indicate there is a 40-50% chance it will match with a known offender when submitted to CODIS. The hit rates for sex crimes with an unknown suspect do not yet rise to this level, but this will certainly increase in time as additional profiles are submitted and the databases mature over time.

Other Benefits

Beyond solving crimes, DNA databases yield a number of critical benefits. Perhaps most important, they can help prevent future crimes, by identifying offenders as early as possible. Law enforcement agencies can also solve more crimes with less money, by targeting perpetrators who re-offend.

Equally important, DNA databases can help to exclude suspects. In some cases, an innocent suspect may not be arrested because a DNA profile provided the investigator with new information. In others, advances in DNA technology have resulted in retesting or even new testing in old cases where defendants have been serving lengthy jail sentences – including some with a potential death sentence. In the US alone, there have been 325 post-conviction DNA exonerations, according to the Innocence Project.²²

Leadership in the UK

However, the use of DNA has not just evolved in the United States. In fact, the United Kingdom has led the world in the use of DNA analysis for law enforcement. They have also compiled statistics that help increase our understanding of its use and value.

²¹ Statistics on CODIS and NDIS taken from the [FBI website](#) (accessed 02/04/15).

²² Information taken from the website for the [Innocence Project](#) (accessed 02/04/15).

For example, in the Annual Report for 2013-2014, the British Home Office reported a hit rate of 62% within their National DNA Database (NDNAD).

This rate is particularly noteworthy, because it only includes matches between an offender profile and a forensic sample, not associations between two forensic samples. If these case-to-case matches were included, the rate would increase to 65%.

This was the highest annual rate yet, and shows the success of the NDNAD in detecting crime and protecting the public (Home Office, 2014, p. 3).

A total of 17,152 crimes were then solved following a NDNAD match, including 482 rapes and 183 homicides. This translates to a detection rate of 58%, demonstrating the staggering benefits of a mature DNA database (Home Office, 2014).

The success of the NDNAD is largely attributable to the sheer number of profiles that have been uploaded since the database was established. As of March 2014, the NDNAD held over 5.7 million DNA profiles from known individuals and over 450,000 from crime scenes (Home Office, 2014). This can be compared with the figures from the US, which include 11.7 million profiles from convicted offenders, 2 million from arrestees, and over 630,000 from forensic samples.²³ This means the US has approximately twice as many DNA profiles as the UK, but the population is about *five times larger*.²⁴ The UK thus currently surpasses the US in terms of populating their national database with DNA profiles.

Crossover Offending

Yet it was pioneering work in Virginia that first demonstrated how much crossover offending there was, with a broad range of CODIS hits between violent offenses, sexual offenses, and nonviolent crimes such as burglary and drug offenses.

Virginia was the first to collect DNA from all felons, not just those convicted of violent felonies. Dr. Paul Ferrara, the Director of the Virginia Division of Forensic Science highlighted how important this distinction was for identifying crossover offending.

We have had over 500 case-to-offender hits and 85% of those hits would have been missed if Virginia only collected from violent offenders (cited in Schellberg, 2002).

This data illustrates that criminals are often involved in a wide range of illegal activity. Yet there is a tendency to view sex offenders as “different” from other types of offenders; they are frequently seen as “monsters” who can be clearly differentiated from the rest of the criminal population. Rapists and child molesters are also seen as “the lowest of the low,” and this perception is often shared by the police and public, as well as other criminals. The early work in Virginia helped to shatter this myth by demonstrating not only that sex offenders were *very much like* other offenders – they actually were the other offenders.

²³ Statistics on CODIS and the NDIS taken from the [FBI website](#) (accessed 02/04/15).

²⁴ Estimate for the US population drawn from website for the US Census Bureau, on the [Quick Facts page](#) (accessed 07/31/15). Estimate for the U.K. population drawn from the [Office for National Statistics](#) (accessed 07/31/15).

To underscore this point, the following graph shows the breakdown of CODIS hits with individuals convicted of drug possession. The 21% of hits matching with burglary cases may not be surprising, given how often burglary is used to financially support a drug addiction. However, the 13% match with sex crimes is surprising to many people.

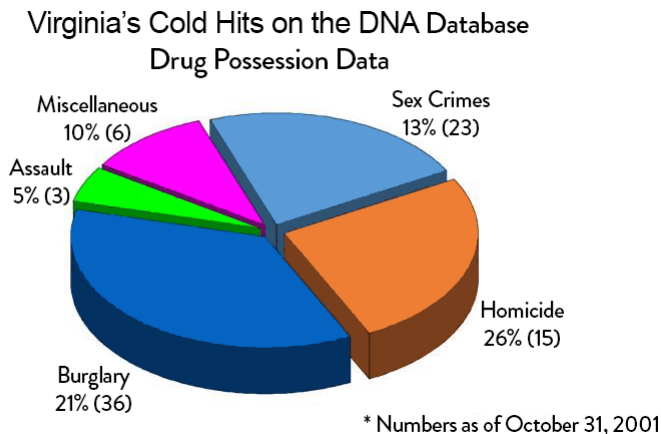

Source: Schellberg (2002)

Even more dramatic is the following chart, which shows the range of criminal offenses matching with a forgery conviction. Very few people would expect to see 55% of individuals convicted of forgery (which is often considered to be “just a financial crime” versus a crime against a person) also convicted of burglary or 9% with a homicide. Yet, most surprising may be the fact that more than one third also committed a sex crime.

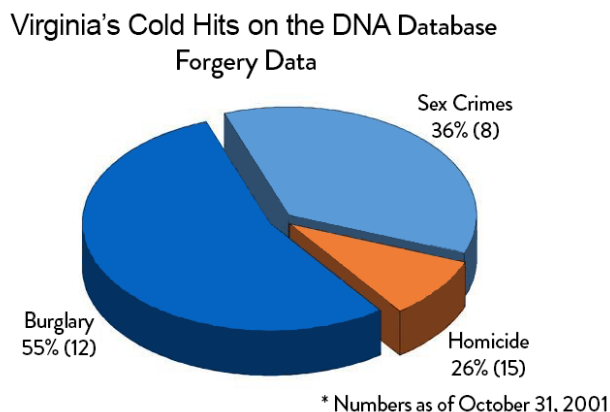

Source: Schellberg (2002)

These findings powerfully demonstrate how much crossover there is between violent, sexual, and nonviolent offending, which highlights the power of DNA to assist in the investigation, prosecution – and ultimately prevention – of crime.

Achieving the Promise

We are well on our way to achieving the full potential of DNA, in the US and around the world. In 2013, the US Supreme Court ruled that it is constitutional to collect and test DNA

samples from arrestees, and this development is expected to produce significantly higher hit rates within CODIS, as the database is populated with millions of additional profiles. This was the same year that President Obama signed the Katie Sepich Enhanced DNA Collection Act, which created grants for states to help pay for the program. Obama explained it quite simply: "It's the right thing to do" (Wolf, 2013).



For more information on the current status of DNA in a sexual assault investigation, the National Institute of Justice offers a section of their website entitled, [Sexual Assault Kits: Using Science to Find Solutions](#). The website offers features such as the definitions of key terms, instructive videos and graphics, and inspiring images and quotes.

Other countries clearly agree. As of April 2015, 50 countries have passed laws creating DNA databases which include an estimated 60 million offender samples worldwide.²⁵ It is estimated that by the year 2020, over 100 million DNA profiles are likely to be available in databases across the globe (Hurst & Schellberg, 2013).

We all want to live in safer communities – but also in a safer world. We believe this is becoming a reality, thanks to advances in DNA technology.

Part II: DNA Testing and Technology

Just as people tend to think of CODIS as a single entity, "DNA testing" is often viewed as a unidimensional process. However, the analysis of sexual assault evidence in most laboratories is actually a two-step process. The first step involves serological screening to localize and characterize biological evidence. In other words, criminalists find the biological material on a specific item and determine what type of fluid it is (e.g., semen, saliva, blood). The second step involves the individualization, through DNA analysis, of the biological material. That is, a criminalist determines who could potentially be the source of the fluid. This second step is also frequently referred to as *DNA typing* or *developing a DNA profile*.

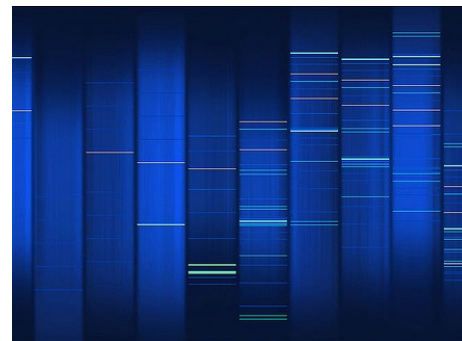

Photo credit: AndrewEick / Foter.com / CC BY

In many laboratories, these two processes will be performed by different analysts, perhaps in different sections of the same laboratory. The two steps may even be performed by different laboratories altogether.

²⁵ Information compiled by Gordon Thomas Honeywell at [DNAResource.com](#) (accessed 07/29/15). This data was specifically drawn from a PowerPoint presentation entitled, Global Offender DNA Database. Presented by Tim Schellberg at the European Network of Forensic Science Institutes (ENFSI) meeting in Copenhagen, Denmark on April 29, 2015.





To offer a sense of what can be concluded on the basis of each of these steps in the analytic process, we provide examples of two laboratory reports. One communicates the results of analysis conducted to [screen biological evidence](#) and the other reports the results of [DNA typing](#). Both are available in the Appendix of this module.

Step 1: Screening

Historically, the localization and characterization of biological material (i.e., screening) has been performed in the same way, with very few changes. For swabs collected during a medical forensic evidence examination, small samplings are taken, and characterization is performed using microscopy and a panel of body fluid tests for blood, semen, saliva, and feces.

As an illustration, acid phosphatase spot-testing might be used to indicate the possible presence of semen, which may later be confirmed by detecting the presence of sperm under a microscope. On clothing, an alternate light source might be used to detect saliva where a male suspect sucked on or bit the breast of the victim. A test for saliva amylase may then be used to indicate the presence of the fluid. This conclusion might even be reinforced by examining the fluid under a microscope, through the detection of epithelial cells originating from the suspect's mouth.

The combination of microscopy and body fluid tests has proven to be effective for evidence screening in most sexual assault cases. However, this process has two main drawbacks. First, a lack of sensitivity may mean that some evidence goes undetected. In addition, body fluid tests require a considerable amount of time by a forensic scientist, especially when microscopy is used. Modern advances in DNA technology offer much more efficient methods for screening evidence in a sexual assault case.

Step 2: DNA Typing

Separating and Extracting DNA for Analysis

Once a laboratory has identified biological material that is potentially probative in a sexual assault case, the next step is to separate the sample for analysis. The DNA typing process thus involves separating cells (whenever possible), breaking open the cells to liberate their DNA, removing the cellular debris that is not of interest, and determining how much male and total DNA is present in a sample.

To illustrate, if vaginal drainage is found on the victim's underwear following a sexual assault by a male suspect, sperm might be separated from the non-sperm cells in the sample (which will include epithelial cells from the lining of the victim's vagina). This separation is conducted using both chemical and mechanical methods. This separation process is particularly important in sexual assault cases involving multiple suspects. This is illustrated with the following example.





Case Example

A female victim is held down by male Suspect #1 while male Suspect #2 penetrates her vagina with his penis and does not use a condom. After Suspect #2 completes the assault, Suspect #1 penetrates the victim's vagina first with his mouth and then with his penis.

Only Suspect #1 is apprehended, and a forensic examination is conducted. The victim's DNA might be detected on the non-sperm fraction of his penile swab (because epithelial cells from her vagina remained on his penis).

DNA from Suspect #2 might also be detected on the sperm fraction of Suspect #1's oral swab (because Suspect #2 deposited sperm in the victim's vagina during penile penetration, and it then transferred to Suspect #1 during oral copulation).

Finally, a mixture of DNA from both suspects might be detected on the sperm fraction of Suspect #1's penile swab (because his penile penetration of the victim's vagina followed that of Suspect #2).

In cases such as these, it is critical to separate out the sperm fractions from the non-sperm fractions before extracting and analyzing the samples independently to produce DNA profiles. This is the only way to understand the DNA results within the context of the assault history provided by the victim and other evidence.

Challenge of Mixed Results

While sperm and non-sperm fractions can often be separated, the cell types of body fluids other than semen (such as blood, saliva, and sweat) are similar in structure so they cannot be separated into two fractions. To illustrate, it is possible to have blood from a female victim mixed with saliva from the male suspect, and the DNA profiling will produce a mixed result because there is no way to separate the two cell types.

Mixed results can also occur with semen stains, because the separation into sperm and non-sperm fractions is often an imperfect process, and one cell type may overwhelm the other in terms of number. In fact, DNA mixtures from three or more individuals may never be able to be separated efficiently enough to identify the donors. However, if a sample can be separated and extracted, a DNA profile may then be developed using a variety of technologies that have continued to improve over time.

Restriction Fragment Length Polymorphism (RFLP)

The first technology that was widely used by law enforcement for DNA typing was called *Restriction Fragment Length Polymorphism (RFLP)*. The process is described by Campbell et al. (2015).



Although RFLP was the primary technology originally available to law enforcement for DNA analysis, many evidence samples were too small to be tested using the procedure.

Large Samples Needed

Even when RFLP was optimized using newer probe technologies, the testing procedure required a minimum of 25 nanograms of DNA material (or 25,000 picograms). This amount of DNA would typically be seen in a sample of bodily fluid about one-fourth the size of a dime. In many scenarios, 25 nanograms is actually quite a bit of biological material. This is because the amount of DNA is only a small percentage of the biological sample.

A DNA sample is broken into pieces by restriction enzymes, resulting in restriction fragments that are separated according to their length to evaluate different patterns across persons (Campbell et al., 2015, p. 74).

How big is a picogram?

While it is relatively easy to understand the amount of biological material needed for DNA testing, it can be difficult to grasp the amount of actual DNA because the units of measurement become so small.

For example, a gram is roughly comparable to the amount of sugar in a quarter-teaspoon – approximately 4,500 individual grains of sugar.

Yet a microgram equals one millionth of a gram, or approximately 0.0045 of a single grain of sugar.

A nanogram is then 1 billionth of a gram, and a picogram is a trillionth of a gram (0.0000000045 of a grain of sugar). Needless to say, these amounts are invisible to the naked eye.

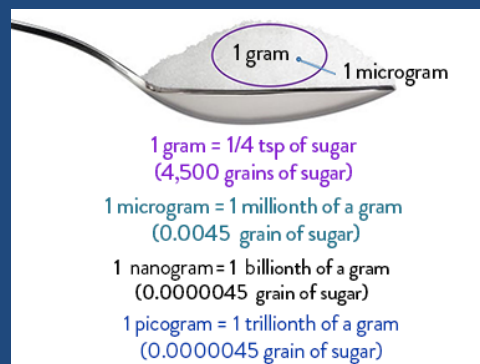

To illustrate, if a female victim is forced to orally copulate a male suspect, the forensic examiner might collect oral swabs from inside and around the victim's mouth. Depending on how much time passed between the assault and the forensic examination, these swabs might contain a small amount of the suspect's semen mixed with a much larger volume of the victim's own saliva. If the amount of semen does not correspond to one-fourth the size of a dime, however, it will be insufficient for RFLP testing to identify a foreign DNA profile.

High Quality Samples Required

Samples also had to be high quality to be tested using RFLP. This meant that no test was possible in many sexual assault cases. For example, in the San Diego Police Department crime laboratory, approximately two-thirds of the cases currently submitted for DNA analysis could not be tested using RFLP, either because they lack DNA quality or quantity.

RFLP testing also frequently consumed an entire sample, which precluded any future analysis (e.g., by defense counsel, for any future appeals, or to test the evidence again using more advanced technologies). In addition, RFLP testing was very time consuming and expensive which limited its utility for law enforcement purposes. For all of these reasons, RFLP testing is now largely obsolete.

Polymerase Chain Reaction (PCR)

All of this changed with the advent of a new technology in the 1990's: Polymerase Chain Reaction (PCR). This technique amplifies a single copy (or a few copies) of a piece of DNA and generates thousands – to millions – of additional copies of a particular DNA sequence. This new technology dramatically increased the sensitivity and efficiency of DNA testing, while reducing costs with improved automation.

Around the same time, forensic scientists began using Short Tandem Repeat (STR) methods, which utilize short, specific repetitive sequences of DNA as DNA markers. The combination of PCR and STR is now considered to be the conventional method for developing a DNA profile (Campbell et al., 2015).

The Ability to Test Small Samples

With the switch from RFLP to PCR technologies using STR methods, the entire field of DNA testing was revolutionized. This was particularly true given the power of PCR/STR testing with small samples. For the first time, DNA analysis could now be conducted with samples as small as 0.3 nanograms (or 300 picograms). To understand what that amount of biological material looks like, take a dull pencil and touch it to a piece of paper. The size of the mark indicates how much of a sample (e.g., blood or semen) is needed to conduct DNA testing using PCR technology.

In fact, PCR testing is nearly 100 times more sensitive than RFLP for developing a DNA profile. PCR can therefore be used to develop a DNA profile from a sample such as a cigarette butt or a semen stain with as few as 50-100 sperm.

Quality and Efficiency

Other advantages include the speed and quality of PCR analysis. PCR technology allows a scientist to create millions of copies of a specific DNA profile that can be easily isolated and analyzed within hours. Yet each copy is the same quality as the original; it is like molecular Xeroxing.



For a list of the PCR kits most frequently accepted by the National DNA Index System (listed by manufacturer), please see the [Frequently Asked Questions \(FAQs\) on the CODIS Program and the National DNA Index System \(NDIS\) on the FBI website](#).

Commercially available DNA typing systems can now characterize as many as 24 highly variable regions of the human genome. They can also produce a result for amelogenin, which establishes the gender of the DNA donor/contributor. The technology can therefore identify the sex of the individual in addition to yielding a DNA profile.

Transition and Resource Crisis

Because of the many advantages of PCR over RFLP, laboratories across the country transitioned from one technology to the other throughout the 1990s. This required a considerable financial investment – not only to replace RFLP technology and equipment, but also to completely re-populate the DNA databases, because the two systems were not compatible with each other. In other words, law enforcement had to start from scratch to rebuild their DNA databanks, and this contributed to the lengthy delays experienced by law enforcement agencies awaiting laboratory analysis of their submitted evidence. This is a historical fact sometimes overlooked in discussions about the DNA backlog in this country.

Competition for Resources

Another factor contributing to the DNA backlog has been a fierce competition for laboratory resources. Typically, only the largest police departments have their own DNA laboratories. Most utilize the state crime laboratory, although others use the FBI laboratory to conduct their DNA analyses. Some agencies contract with private laboratories, but these services are costly. In fact, regardless of which type of laboratory is used, forensic resources can be expensive, depending on the number of sexual assault cases examined and the amount and type of evidence submitted for analysis.

Forensic resources are thus limited, and various investigative units must compete to get their evidence analyzed (e.g., sex crimes, homicide, robbery, burglary). For agencies using state and FBI laboratories, they have faced particular challenges getting their DNA work completed, because these resources have been stretched especially thin. As a result, most of the forensic evidence collected over the last 30 years has simply remained in storage in police department property rooms, untested.

Triaging DNA Collection

Another factor contributing to the DNA backlog has been the increased demand for analysis. As previously described, states have been expanding their requirements for DNA collection from individuals convicted – or arrested for a broader range of qualifying offenses. Jurisdictions have therefore struggled with resources as they attempted to collect these DNA samples, develop DNA profiles, and submit the profiles into CODIS.

In fact, law enforcement agencies often had to triage the collection and analysis of offender samples, based on the law and available resources. Samples have typically been collected first from inmates scheduled to be released from custody, rather than those entering prison or serving especially lengthy sentences (including life or even those on death row). Unfortunately, this has historically meant that the most serious offenders were typically collected and profiled last. Throughout the process, it has often taken months or years for

offender profiles to show up in CODIS, so they could be compared with forensic unknowns submitted by investigators in their ongoing cases.

While we do not know for sure, this may be exactly what happened in Patty's case. At the time the foreign DNA profile was developed in her case, CODIS did not have a match to the offender, later identified as Joseph Bong. Bong had been arrested shortly after Patty's sexual assault and was serving an 18-year prison sentence for armed robbery and false imprisonment. Unfortunately for Patty, it would be another five years before Bong's DNA was collected, typed and entered into CODIS by the state crime laboratory.

During this period of critical shortages in laboratory resources, many detectives would have given anything to have DNA testing conducted in their sexual assault cases in a timely manner – and to have DNA profiles of all sex offenders, not just the most violent sex offenders, entered in CODIS. However, it was not a realistic possibility at the time.

A New PCR Tool: Y-STR Testing

We are now poised for another transition in the potential of DNA technology, from autosomal testing methods such as PCR (which analyze a variety of chromosomes) to Y-STR methods (which test only for the male sex chromosome). This shift in technology is based on the premise that the vast majority of sexual assaults involve a male suspect and a female victim.

Instead of screening each swab (oral, vaginal, anal) for semen / saliva / blood, the forensic analyst takes a small cutting from each swab to determine if male DNA is present ... If there is male DNA in the samples, then the kit will proceed with the rest of the testing [to develop a DNA profile for the male] ...

If there is no male DNA in the samples, then the kit does not proceed to testing (unless specific case-by-case circumstances suggest that additional testing is warranted) (Campbell et al., 2015, p. 168-169).

Increased Efficiency: Looking Only for Male DNA

Because human females possess two X chromosomes while males possess one X- and one Y-chromosome, molecular biologists have developed a method known as a Y-chromosome screen to assess for the presence of male DNA and later develop a DNA profile (often referred to as a haplotype). This method can greatly increase the efficiency of screening during the first stage of DNA analysis, because it eliminates most of the traditional serological process.

The Y-screen method can greatly increase the efficiency of screening evidence in the vast majority of sexual assault cases involving a male suspect and a female victim. At the San Diego Police Department, for example, four times the number of cases can be screened by the Forensic Biology (DNA) Unit using Y-screen technology compared to screening evidence using more traditional microscopic and serological approaches.

However, Y-screening does not differentiate the specific biological source of the DNA (e.g., whether it was developed from a sample of semen vs. saliva). Follow-up testing is needed to determine what specific body fluid was found on the item.

Alternative methods are also still needed in cases involving a male suspect and a male victim – or a female suspect and female victim. Because the Y-screen method detects the male and total DNA present in a sample, and distinguishes between the two types of DNA, it will not be meaningful for male-on-male or female-on-female assault scenarios.

With the Y-screening method, there may need to be follow-up testing to determine which specific bodily fluid (semen / saliva / blood) was found on which swab, as those details may need to be presented in court (e.g., the vaginal swab had male DNA from semen) (Campbell et al., 2015, p. 169).

The “Backlog” Question

Because Y-testing can screen some evidentiary items so efficiently, laboratories may now have little to no backlog in the sexual assault evidence kits that need to be screened. Once the evidence is screened, however, a second testing process is needed to *develop a DNA profile*, and there could very well be a significant backlog in this process. It is therefore worth clarifying what is meant by a “DNA backlog” when this term is used, because it could pertain to either the Y-screen or DNA profiling processes.

The term could also be used to refer only to the evidence kit collected during a victim’s medical forensic examination. Virtually all of the national dialogue on the rape kit backlog has focused on this one type of evidence (the “rape kit”), and not on the other types of evidence that may be collected in a sexual assault case (e.g., condoms, clothing, bedding).

Increased Sensitivity

One reason the use of Y-STR technology has increased so dramatically is because it is more sensitive than PCR analysis. In fact, Y-STR tests are capable of generating results with as little as 50 picograms of DNA. This contrasts with the 300 picograms required to conduct PCR analysis, and the 25,000 picograms needed for RFLP testing (see image below).

To visually illustrate this point, we return to our example of the dime. As previously discussed, RFLP testing required a biological sample (e.g., blood, semen) one-fourth the size of a dime. That amount of biological material contains approximately 25,000 picograms of actual DNA (the amount needed for RFLP testing). In contrast, standard PCR testing (with autosomal STRs) requires approximately 300-1,000 picograms of DNA, which would be found in a biological sample no larger than the word “TRUST.” For PCR testing using Y-STRs, the biological sample would only need to be half the size of the letter “J” at the base of Roosevelt’s neck.

As a result of this increased sensitivity, Y-STR testing may identify male DNA on a sample when body fluids have not been detected using traditional screening methods. This makes it a particularly valuable tool for scenarios where limited biological material is exchanged between

the victim and suspect (e.g., digital penetration) or where limited biological material remains on the body of the victim or suspect (e.g., after showering). Y-STR is also helpful in cases where seminal fluid has been identified but few or no sperm are present. This would include situations where the male has had a vasectomy or has no measurable level of sperm in his semen.

How much DNA is in a sample of biological material?

If a biological sample (e.g., blood, semen) is the size of a dime, the amount of DNA = 100,000 picograms (100 nanograms).

If a sample is the size of the word "TRUST," the amount of DNA = 1,000 picogram (1 nanogram). If a sample is the size of the letter "J" at the base of Eisenhower's neck, the amount of DNA = 100 picograms.



How much DNA is needed for each testing method?

RFLP testing requires 20,000-100,000 picograms of DNA.

PCR testing with autosomal STR's requires 300-1000 picograms of DNA.

PCR testing with Y-STR's requires 50 picograms of DNA.

The increased sensitivity of Y-STR also means it can be used with DNA that has been degraded. This is useful, for example, with evidence that has been stored for years, or even decades, as well as human remains or other evidence that may have been buried, burned, involved in an explosion, etc

Identifying Mixed Samples

The enhanced sensitivity of Y-STR testing can be particularly beneficial in cases where the sample is mixed. This could include mixed samples with blood from more than one individual, as well as bloodsaliva mixtures. With such samples, Y-STR "simplifies the analysis of these mixtures by removing the female contribution from the amplification profile."²⁶ Y-STR may thus be better able to differentiate profiles of multiple perpetrators in a complicated sexual assault case.

This increased sensitivity also means that Y-STR testing may be able to detect the presence of male DNA regardless of how much female DNA is in a sample. This can be particularly valuable in scenarios such as the following:

- Oral copulation of a female victim by a male suspect.

²⁶ Quote taken from the website for the DNA Diagnostics Center, on the page entitled, [The Use and Significance of Y-STR Testing](#).

- Vaginal penetration of a female victim by a male suspect with only pre-ejaculation or no ejaculation occurring.
- Licking of a female victim's breasts or another body surface by a male suspect.

In these scenarios, the laboratory might analyze swabs taken from the female victim and identify only the female contributor using conventional autosomal testing methods (PCR/STR). Yet subsequent Y-STR testing might be able to detect one or more male donors and develop a complete DNA profile for each. Similarly, a trace amount of seminal fluid without sperm might be identified on the victim's underwear, and conventional autosomal testing may only be able to yield a DNA profile for the female contribution. A Y-STR test, however, might be able to identify the male DNA profile as well.²⁷

Case Example

Another case from the San Diego Police Department illustrates the power of DNA analysis to sort out the details of a complex sexual assault case with multiple perpetrators. In this case, a high school girl with a developmental disability was sexually assaulted by several teenage boys, who wanted to force her into prostitution. Five to six boys were originally thought to be involved in the incident. Following the assault, the girl disclosed to her parents and the police were called. The victim was taken for a medical forensic examination and her clothing was collected as evidence. During her initial interview, the victim identified two of the boys involved in the assault, and they were immediately arrested.

The suspects were examined by a sexual assault forensic examiner and forensic evidence kits were collected from both boys.

Given the large number of possible suspects involved in the sexual assault, all the available evidence was analyzed by the laboratory. This included the victim's forensic evidence kit, as well as her underwear, pants, shirt, and sweater. The two forensic evidence kits collected from the suspects were also analyzed.

The laboratory reports indicated that semen was found on the victim's shirt, vaginal swabs, oral swabs, and anal swabs. Saliva was also detected on both the right and left breast swabs. In addition, semen and epithelial cells were found on the penile/scrotal swabs collected from the two suspects who were arrested.

DNA testing of the victim's vaginal and anal swabs indicated that there were at least three contributors of semen, corroborating her statement of being raped by multiple perpetrators. However, the oral swabs had a single semen source that did not match either of the two suspects who had been arrested, nor did it match the three sources found on the vaginal and anal swabs.

Continued investigation revealed the identity of several more suspects, and DNA testing of their reference standards linked one of them to the semen found on the oral swab. DNA

²⁷ These examples are taken from the website for the DNA Diagnostics Center, on the page entitled, [The Use and Significance of Y-STR Testing](#).

testing of the suspects' penile/scrotal swabs also produced sperm fractions that were a mixture of more than one individual, not including their own. These findings indicated that each of these two suspects had semen on their penile/scrotal swab that originated from other males. These findings provided further corroboration of the gang rape scenario, because this explains why one suspect would have DNA from one or more other suspects on the swabs collected from his penis/scrotum.

In addition, analysis of the non-sperm fraction of each suspect's penile/scrotal swabs produced a DNA profile consistent with the victim, which indicated that the victim's vaginal epithelial cells were present. Finally, both the left and right breast swabs taken from the victim produced a single male profile that turned out to match a fourth suspect later identified in the investigation. Without DNA, it would have been difficult if not impossible to corroborate the specific sexual acts involved in this complex scenario.

Expanding Samples, Extending Timelines

With its dramatically increased sensitivity, Y-STR testing can now be used to identify DNA profiles from samples that would have previously been unimaginable. For example, one study documented that DNA profiles could be identified from saliva evidence collected from the skin *after showering* (Williams et al., 2015). Another study found that full or nearly full Y-STR profiles could be developed from vaginal swabs collected *72 hours following digital penetration* (Sween, Quarino & Kishbaugh, 2015). In other words, *DNA from the suspect's finger was found in the victim's vagina three days after contact*.

Y-STR testing is also extending the timeline for recovering DNA profiles from evidence. For example, one study obtained usable Y-STR profiles from vaginal swabs as many as eight days following sexual penetration (Quarino & Kishbaugh, 2012). In another study, DNA was recovered from vaginal swabs using enhanced Y-STR technology up to 10 days following consensual sexual intercourse (Speck & Ballantyne, 2015).²⁸

This is a revolution in DNA technology much like the transition from RFLP to autosomal PCR. The discussion thus highlights the importance of encouraging sexual assault victims to have a medical forensic examination, regardless of whether they have showered, bathed, or engaged in other activities often viewed as limiting evidence collection (e.g., brushing teeth, douching).

Limitations of Y-STR Testing

While Y-screen methods are extremely effective at detecting the presence of male DNA – even in trace amounts and for long periods of time – the DNA profiles (haplotypes) developed using Y-STR are currently less discriminating than profiles developed using conventional autosomal STR methods (Sween et al., 2015). This is because Y-STR analysis only tests for the frequency of repeats at certain locations on one chromosome; the male Y chromosome. They are far less able to differentiate specific individuals,

²⁸ For menstruating women on hormonal birth control, the detection rates for DNA on Day 10 were over 50%. For women who were not menstruating or using hormonal birth control, the detection rates increased to more than 65% (Speck & Ballantyne, 2015).

particularly those who are paternally related (e.g., father, son, brother). In fact, Y-STR profiles are generally passed intact from one generation to another, barring any mutational event. Thus, the profile developed from one man will typically match that of his father, his brother, and other paternal relatives.

This means there is a finite number of Y chromosome profiles, and the implications of a match with Y-STR analysis – while helpful in supporting an investigation – should never be seen as identifying a suspect to the exclusion of all others. In fact, when a laboratory report is returned with Y-STR results, it will simply advise that the suspect *could not be excluded from the possibility of contributing a sample*. A laboratory report will then estimate the expected frequency of that particular Y-STR profile in a specific ethnic population. For example, a particular profile might be expected to be seen in 1 out of every 792 African American males, or 1 out of every 638 Asian American males, etc.

This table illustrates shared Y-STR profiles and their system of inheritance along paternal lines. Knowledge of how and where these profiles are inherited can help investigators identify potential reference samples. (Table provided courtesy of Lauren Ware.)

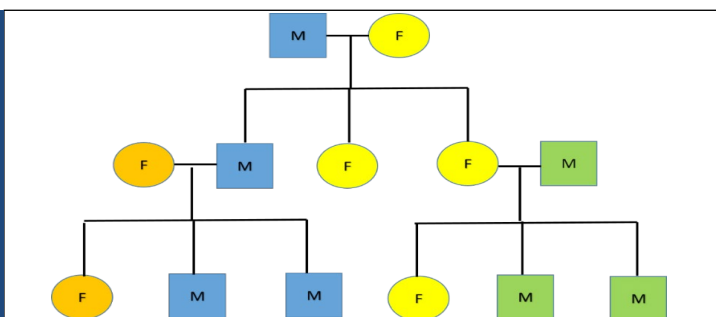

Because the profiles generated from Y-STR analysis are far less discriminating than those developed using conventional autosomal STR methods, they are not typically searched in CODIS at the present time. Conventional autosomal systems such as PCR/STR thus remain the technique of choice when sufficient male DNA is present and it is not overwhelmed by DNA coming from the female contribution. However, when very little male DNA is present, or there is substantially more female DNA than male DNA, the preferred technique is to utilize Y-STR testing.

In fact, there is currently no national database for Y-STR profiles, although some local laboratories are tracking them in their local DNA Index System (LDIS). Nonetheless, a Y-STR match in a local database might still help to advance an investigation or prosecution. For example, it might contribute to a mounting pile of evidence suggesting that law enforcement has identified the right suspect in a sexual assault case.

As an illustration, the San Diego Police Department had a violent series of sexual assaults involving a male suspect who rendered his female victims unconscious and then groped and/or digitally penetrated them. No DNA profile could be developed using PCR/STR methods with the evidence collected in the cases, but Y-STR technology was used to demonstrate that the cases were related and likely committed by the same suspect. This served to mobilize law enforcement, and ultimately the investigator assigned to the case was able to identify the perpetrator via a tip from the public.

Summary: Y-STR versus PCR

To summarize, the Y-screen can be used to measure both the amount of male DNA present in a sample originating from a male (via the Y chromosome), and the amount of DNA coming from all chromosomes. This information is then used to dictate the future analytical path for the sample. If sufficient male DNA is present in the sample, and the ratio of male to total DNA is appropriate, normal STR profiling will be used to develop a DNA profile. These profiles can be uploaded into CODIS as forensic unknowns. If low quantities of male DNA are present, or if there is an overabundance of DNA coming from a female, Y-STR analysis can be conducted.

At present, Y-STR profiles are not generally uploaded to CODIS due to a reduced ability to distinguish between individuals. However, this may change as technology improves.

Selective Degradation

Another recent development in DNA technology is referred to as selective degradation. This process is again described by Campbell et al. (2015).

For the 'selective degradation' method of DNA testing ... the forensic scientist uses a faster-acting chemical technique for isolating the sperm. After an initial removal of nonsperm DNA, chemicals are added that destroy the remaining non-sperm cells in the sample (i.e., the cells that are mixed with the sperm cells), leaving only the sperm cells (hence the term 'selective degradation').

The combined chemical-mechanical separation methods used in the "traditional" approach often leave behind traces of other cells/DNA, so that the final sample to be analyzed is a mixture of multiple DNA sources (victim and suspect[s]), which makes it more challenging and time-consuming for the analyst to interpret the findings.

With selective degradation, the sample that will be analyzed for DNA is 'cleaner' in that the method minimizes mixtures by destroying non-sperm DNA that is mixed with the sperm cells; if there are multiple male assailants, the mixture of those two DNA samples is still intact, as the method does not destroy sperm (from any source). Once the sperm cells are isolated then the testing can proceed per usual (PCR-STR methods) (Campbell et al., 2015, p. 169-170).

In sum, selective degradation eliminates non-sperm cells and their DNA, allowing for a pure fraction of sperm to be isolated. As a result, selective degradation can be conducted using an automated process, while traditional differential extraction is typically a hands-on process.

Is It a Better Method?

Campbell et al. (2015) evaluated the cost, efficiency, and accuracy of the selective degradation process as compared with standard PCR/STR methods for conducting DNA analysis. They found no significant difference in the accuracy of the results produced with the two methods, and while the materials cost was the same, the newer technology saved

an average of 1.1 hours of staff time per kit, suggesting that laboratories could potentially take advantage of the increased efficiency of the new technology (and cost savings in terms of time) without sacrificing any meaningful degree of quality (Campbell et al., 2015).

Mitochondrial DNA: The Other Type of DNA

Up to this point in the module, we have focused on nuclear DNA. As the name implies, this is the DNA molecule found in the nucleus of every cell in the body (minus non-nucleated cells like red blood cells). All nucleated cells (with the exception of egg and sperm cells) contain 46 chromosomes that provide the instructions to build every structure in the body. In this section, we will explain the “other type of DNA,” known as mitochondrial DNA (or mtDNA), but the explanation will be clearer if we first provide a more detailed description of the more conventional form of DNA – nuclear DNA (nDNA).

Understanding Nuclear DNA (nDNA)

Nuclear DNA (nDNA) is comprised of four nucleotides (adenine, guanine, thymine, and cytosine) that pair together to form a ladder-like double helix that is wound tightly together to form the structure of the chromosome. Those four nucleotides pair according to very strict rules (e.g., adenine only pairs with thymine, cytosine only pairs with guanine). Much like the code of one's and zero's used for digital data, the sequence of the 3.2 million pairs of nucleotides in the human genome is what makes us unique individuals, and therefore, what molecular biologists use to identify us.

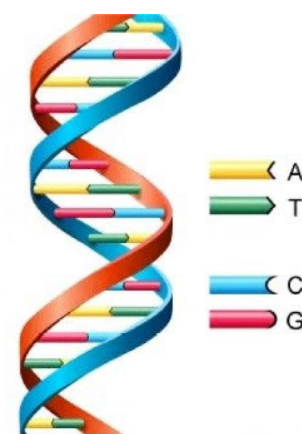

Scientists currently look at 13 different locations on a chromosome to establish the number of times a sequence of pairs repeats (for instance: AT, AT, AT, GC, AT, AT, AT, GC). Once the number of repeats is established, it is compared to the known frequency of this occurrence in the general population. This allows scientists to assign a percentage of expression, for that particular sequence, at that particular site.

The percentage could be 5%, for example, which on its own is not overly discriminating; however, when the percentages of all 13 locations are multiplied, the resulting statistical probability of another person exhibiting the exact same sequence at all 13 locations is staggering. In many cases, it can exceed the population of the planet. A match between two nDNA profiles can therefore be seen as identifying a person with virtual certainty.

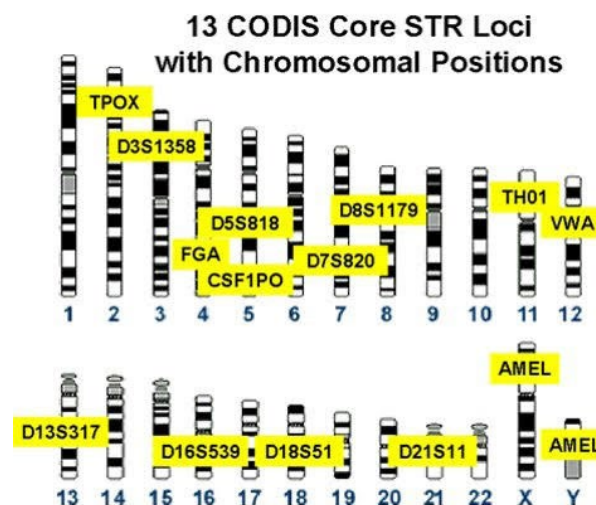

Graphic published by the
[Federal Bureau of Investigation](https://www.fbi.gov)

Mitochondrial DNA (mtDNA)

Mitochondrial DNA (mtDNA) is significantly different. It is in fact separate and exclusive of nuclear DNA. While one copy of nuclear DNA is found inside the nucleus of every cell, anywhere from 1,000 - 10,000 copies of mtDNA exist outside the nucleus in the cell's cytoplasm. Because of the number, mtDNA tends to persist longer than nuclear DNA, so it can be analyzed in cases where the nuclear DNA has been degraded or destroyed, or where the recovered tissue is comprised of mostly dead cells (such as old skeletal material or shed hair). This is important because hairs are often recovered from sexual assault scenes and medical forensic examinations. Unless the hair was forcibly pulled from the body (thereby retaining fresh cellular material on its root), nuclear DNA analysis will not be possible. Depending on the circumstances, however, mtDNA analysis might be.

Analysis Using mtDNA

A man's Y-STR profile is inherited exclusively from his father, while mtDNA is inherited entirely through maternal lines. This is because the mitochondria in the sperm cell (which ultimately delivers the father's genetic contribution to the mother's egg) is located in the tail of the sperm. When the sperm cell penetrates the egg, the tail breaks off and the father's mtDNA loses the opportunity to contribute information to the next generation. Only the mtDNA from the egg is passed on. This also means that a person's mtDNA profile will match with his/her mother and sister(s), as well as any maternal aunts and her children, etc.

The purpose of mtDNA analysis is therefore not unlike Y-STR testing. It cannot be used to identify a suspect to the exclusion of all others; it can only conclude that the suspect (and his maternal relatives) *cannot be excluded* from the possibility of contributing a sample. This may help to advance an investigation and prosecution if it contributes to a larger body of evidence.

This table illustrates shared mtDNA profiles and their system of inheritance along maternal lines. Knowledge of how and where these profiles are inherited can help investigators identify potential reference samples. (Table provided courtesy of Lauren Ware.)

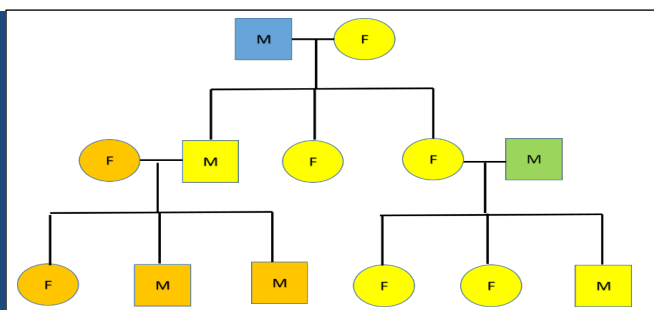

This also means that a cooperative relative can be asked to provide their DNA for mitochondrial or Y-STR analysis, in the event that a reference sample cannot be obtained from the suspect. If the profile matches with evidence from the victim or crime scene, this can help to support the probable cause needed for further investigative efforts, or – at the very least – help verify that the investigation is focusing on the right suspect.

National mtDNA Database

As with Y-STR profiles (also referred to as haplotypes), mtDNA profiles are not accepted into NDIS, at least in the Offender Index, Arrestee Index, or Forensic Index. They are, however, used to search the database of DNA profiles for unidentified human remains, missing persons, and relatives of missing persons.

At this point, there are not enough mtDNA profiles in the national database (the mtDNA Population Database) to predict their occurrence in the general population. Therefore, the results from mtDNA analysis will only report the number of times that profile has occurred within a certain ethnic population specifically contained in that database.

As of 2015, the FBI Laboratory – in partnership with other facilities including the Armed Forces DNA Laboratory – has sequenced over 2,400 mtDNA profiles. That number continues to grow, and eventually there may be a sufficient number of profiles so the laboratory results could be used to predict the rate of occurrence in the general population. Until then, investigators can expect the results to be accompanied by a statement that the profile occurs in 1 of every 726 Caucasian males, or 1 in every 816 African American males *who are included in the mtDNA Population Database*.

Comparing DNA Types and Testing

The following table can be used as a quick reference guide for the advantages and disadvantages of each type of DNA analysis.

Type of Analysis	Advantages	Disadvantages
Nuclear DNA Analysis (Conventional Autosomal Testing using PCR / STR)	<p>When a complete profile is generated, this analysis has a power of discrimination that can identify the source of the sample to the exclusion of all others.</p> <p>Even when a partial profile is produced, the statistical probability that the matching suspect is the source of the sample can still be significant enough to convince a jury of the identification.</p>	<p>When trace amounts of a mixed sample are recovered, the process of amplifying the DNA can mask the male contributor and present the female profile exclusively.</p> <p>While relatively resilient, nuclear DNA can break down due to decomposition, excessive heat, biological contamination, etc.</p>

Type of Analysis	Advantages	Disadvantages
Y-STR Analysis	<p>Can be obtained from mixed samples and from those where the male contribution to the sample is significantly smaller than the female contribution.</p> <p>The resulting profile can be compared to a cooperative paternal relative, if a reference standard cannot be obtained from the suspect.</p>	<p>Limited scope of identification; the sequence is shared among paternal family members and has an expected and frequent occurrence in the general population, rendering it incapable of identifying a suspect to the exclusion of all others. Testing can only conclude that a suspect is excluded or cannot be excluded as a possible donor.</p>
Mitochondrial DNA Analysis	<p>Can be obtained from highly degraded samples, or specimens incapable of nDNA analysis (bones and hair). Mitochondria are at least 1,000 times more plentiful in cells as nDNA.</p> <p>The resulting profile can be compared to a cooperative maternal relative, if a reference standard cannot be obtained from the suspect.</p>	<p>Limited scope of identification; the sequence is shared among maternal family members and has an expected and frequent occurrence in the general population, rendering it incapable of identifying a suspect to the exclusion of all others. Testing can only conclude that a suspect is excluded or cannot be excluded as a possible donor.</p>

Looking to the Future

Y-STR and mtDNA analysis illustrate once again the power of advancing technologies to revolutionize DNA testing for criminal justice applications. It is simply impossible to imagine what lies ahead, as DNA analyses provide more and more information from small or compromised samples. Yet this also raises important questions. For example, with increased sensitivity, DNA testing will detect more mixtures that cannot ultimately be resolved. It also means that evidence items will be easier to contaminate at every stage in the process, from collection, to packaging, to analysis.²⁹

²⁹ In the U.K., a DNA Ethics Group was established in 2007 to provide advice to federal Ministers and the National DNA Database Strategy Board. One of their key recommendations was that: "Efforts should be made to purge the NDAD of contaminant profiles (this refers, for example, to profiles from staff from firms which make the kits used in the forensic process" (Home Office, 2014, p. 6). The importance of such efforts will only increase over time, as the sensitivity of DNA testing technologies improve.

How Long to Store Evidence?

Advances in technology also raise questions regarding how long to store evidence and when to retest old evidence using new technologies.

With the transition from RFLP to PCR, some cases required new analysis, and other cases would have benefited from new analysis but RFLP testing had consumed the entire sample. The same questions will arise each time DNA technology advances, regarding whether and when to re-examine evidence from prior cases. There will also be appeals filed by defendants requesting DNA analyses using new technologies. The goal is therefore to store forensic evidence as long as possible, while working within realistic constraints on time, resources, and personnel.

Yet these issues require the careful development of policies, protocols, and priorities for resource allocation. Property managers and evidence custodians should be included in this decision making process. Law enforcement agencies and crime laboratories should also consider the possibility of identifying resources, personnel, and equipment to review unexamined or previously tested evidence with each technological leap. We will provide detailed guidance in this area of evidence retention policies in a later section.

Part III: Case Example of a Multi-State Series and the Lessons Learned

To better understand the promise of DNA technology, and the historic developments that brought us to this point, it is helpful to walk through a specific case example that unfolded over time. We will therefore describe the case of James Allen Selby who raped and sexually assaulted more than 13 women and children across five states.

This case illustrates a number of important points, including why it is so important to submit forensic evidence to laboratories for analysis, regardless of whether there is a known suspect identified. It also highlights the importance of submitting reference standards from a suspect as soon as state laws allow. Making such points, however, requires looking back in time and tracing the history of this series.

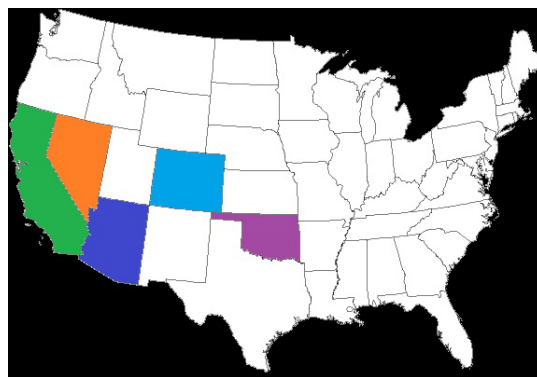

This chronology is written the way it originally unfolded, from the perspective of those working in the Sex Crimes Unit of the San Diego Police Department at the time.

Case Example of James Allen Selby

As you read this case example, keep in mind that none of the states involved in this series had legislation allowing the collection of DNA evidence from a suspect at the point of arrest.³⁰ Many states now have such legislation. As a result, the case might have resolved very differently if it were to take place today. At the end of the chronology, we will explore such differences and describe the lessons and the goal as we look to the future.



Source: Evan Caravelli,
Arizona Daily Wildcat

San Diego, California (July to September 2001)

From July to September of 2001, the San Diego Police Department Sex Crimes Unit investigated a series of four home invasions involving rape and sexual assault. All of the victims were adults, but they could not provide detailed information about the suspect because he covered their faces with different items (e.g., a towel, pillow, blanket). Investigators knew the case would most likely be solved with forensic evidence.

Fortunately, a forensic DNA profile was obtained from the vaginal swabs collected from each victim. Foreign DNA was also recovered from toilet paper collected in one of the cases. Although the profile was submitted to CODIS at the time, there was no match in the Convicted Offender Index.

Detectives Jack Knish and Dave Dolan were assigned to this series, and they worked hard to identify the suspect. The DNA profile linked all four cases together, but there were no viable leads to identify a suspect. The detectives suspected that the assailant was a transient, but the citizens of San Diego wondered if and when the suspect would ever be caught.

Tucson, Arizona (October 2001 to May 2002)

Within days of the last San Diego assault, a serial rapist began terrorizing the citizens of Tucson, Arizona. The crimes were committed between October 2001 and May 2002, yet unlike the cases in San Diego, the Tucson series involved three adult women and one 13-year old child. In the case of the 13-year old, the suspect entered her home through a sliding glass door while her parents slept in the room next door. The suspect told the victim not to scream or he would kill her, but the victim did scream and the suspect fled before the sexual assault was completed.

In this Tucson series of sexual assaults, the suspect also covered the victims' faces so the information they could provide to describe him was extremely limited. Fortunately, foreign

³⁰ In California, law enforcement could (and still can) obtain a forensic examination of a suspect incident to arrest, prior to booking in jail. This applies not only to suspects in a sexual assault case, but also to cases involving other crimes such as assault with a deadly weapon or homicide. The suspect's forensic examination is justified based on exigent circumstances, and it typically involves obtaining both blood and buccal swabs, among other evidence such as clothing, trace evidence and photographs.

DNA was again located on the vaginal swabs from three of the victims. A foreign DNA profile was also obtained from the 13-year old victim, by swabbing her fingers.

The Tucson and San Diego series were linked together with forensic DNA profiles, but CODIS still could not provide the suspect's identity. Tucson Detective Mary Gehm and the San Diego detectives compared investigative notes, in the hopes of developing a potential suspect lead. However, they were unsuccessful at the time. Recall that this was a time period when police departments had extensive DNA backlogs, so it often took months or years for DNA profiles to show up in the Convicted Offender Index.

Cleveland County, Oklahoma (September, 1999)

In August of 2002, investigators from Cleveland County, Oklahoma got a break. A DNA profile was developed from the evidence in a 1999 case that had plagued them for three years. The sexual assault occurred on September 16, 1999 in Norman, Oklahoma. The suspect reached through the bedroom window of a 9-year old victim to let himself in, gagged her with a sock, and carried her a few hundred feet to the nearby woods where he sexually assaulted her. The suspect fled when he heard the victim's mother searching for her daughter.

The young girl was unable to identify her attacker. Foreign DNA was found on both the victim's vaginal swabs and her underwear, but the profile could not be submitted to CODIS due to limitations at the time. The sample was shelved in the hopes that it would become useful in the future.

Detective Gerald Moody was assigned to the case, and he began his investigation by interviewing registered sex offenders in the area. During this process, he visited the victim's neighbor, who had a friend named James Allen Selby living with him. Investigators learned that Selby had been charged a year earlier in Pima County, Arizona on several charges of attempted sexual assault, aggravated assault with a deadly weapon, false imprisonment, and kidnapping of an adult woman. However, he was acquitted on all the charges except for simple assault by a Pima County jury.

During the Pima County trial, Selby acknowledged that the sexual acts took place, but argued that the victim consented. This consent defense was successful, despite evidence documenting significant injuries sustained by the victim – on her head, wrists, and other locations.³¹

In 2002, when the DNA profile from the evidence in Cleveland County, Oklahoma was finally developed and submitted to CODIS, it matched with both the Tucson and the San Diego series. Investigators once again began comparing notes. Oklahoma investigators advised their colleagues that the primary suspect in their case was James Allen Selby. In other words, the CODIS hit in 2002 confirmed that they had correctly identified the suspect three years earlier by checking for registered sex offenders in the area. Selby's name was run through the National Crime Information Center (NCIC) database and investigators

³¹ Some of the information on this multi-state series was drawn from the *Cold Case Files: Episode #92*, entitled, *Manhunt*. The show aired on the History Channel, Monday, October 16, 2004.

learned that a warrant had also been issued for his arrest for yet another rape committed in Sparks, Nevada.

Sparks, Nevada (April, 2001)

On April 30, 2001, just a few months before the first assault in the San Diego series, a 12-year old girl was sexually assaulted in her apartment. Again, the suspect covered the victim's face with a pillow, towel, and comforter, and then he raped her. Foreign DNA was found on the victim's vaginal swabs, but there were no matches in CODIS.

Detective Tom Miller of the Sparks Police Department conducted an investigation and identified the suspect as James Allen Selby, a maintenance worker at the victim's apartment complex. Selby failed to show up for work and appeared to have moved from his apartment in the same complex. The detective executed a search warrant on the suspect's apartment where he obtained the suspect's toothbrush and razor. A DNA profile was developed from this evidence, and it matched with the one identified from the victim's vaginal swabs. An arrest warrant was issued for Selby, but he could not be located.

As of 2002, when the case was matched with the others in San Diego, Tucson, and Oklahoma, none of the cases could be prosecuted because the suspect had not yet been located. Most important, *Selby's DNA profile was not uploaded to CODIS when the arrest warrant was issued*. His DNA profile had been developed from evidence seized from his apartment (a toothbrush and razor), rather than a known reference standard. This type of DNA profile is referred to as a *secondary standard*, and it is not eligible for submission into CODIS – either as a reference standard or as a forensic unknown. Yet even if law enforcement did have a reference standard taken directly from Selby, his DNA profile still would not have been eligible for CODIS based on state laws at the time, because he had not yet been convicted of the crime.

The Hunt Continues

In August 2002, a warrant was issued for Selby's arrest in Oklahoma. Last seen in Tucson on August 16, 2002, a massive multi-state search for Selby began. He was featured on the television program *America's Most Wanted*. Flyers were posted in residence halls, bars, and garages warning the public that Selby was considered to be very dangerous and asking for any information that would help to apprehend him.

At the time, information also emerged that led law enforcement to believe Selby was responsible for four additional sexual assaults in the Tucson campus area as well as ten other assaults in other locations. The charges issued in Arizona included not only sexual assault and aggravated assault, but also kidnapping and attempted murder (for cutting the throat of one of his victims).

Colorado Springs, Colorado (July 2002)

At long last, Selby was arrested in September 2002 at a Veterans Affairs (VA) clinic in Colorado Springs, Colorado. In addition to the charges listed in the outstanding warrants for

his arrest, the detectives who interviewed Selby also suspected that he might be responsible for an unsolved home invasion and the rape of a 55-year old woman that occurred in July 2002 in Colorado Springs. DNA from the victim's shirt linked Selby to the Colorado Springs attack.

Selby was arrested and booked for rape on these new charges. Not surprisingly, Selby asserted a consent defense, stating that he and the victim "had a budding romantic relationship" that started weeks before, after they met at a grocery store. Selby said he helped carry the woman's groceries three blocks to her house and that they saw each other at least four more times before she invited him into her bedroom on July 25, 2002 (Hethcock, 2003). As in the earlier trial in Pima County, Arizona, Selby acknowledged that the sexual acts took place but claimed that the victim consented.

This time, the jury didn't buy it. On September 15, 2003, they convicted Selby of the assault, and he was sentenced to 20 years to life.

From Colorado, Selby was transported to Tucson, Arizona where he was tried on 27 felony counts. During the Tucson trial, Selby represented himself. This placed a great deal of additional stress on his victims, because he was allowed to personally face each one and question them in court.

Selby was convicted in the Tucson trial on October 7, 2004. He was scheduled to be sentenced to life in prison the next day, but he hung himself from the window of his jell cell, just a few hours before the hearing. One of the two lawyers who prosecuted Selby, Micah Schmit, said that the act of suicide perfectly fit Selby's character.

It was an 11th hour cowardly act that deprived the community, deprived the victims (of a chance) to get their retribution ... This is entirely in keeping with the controlling and narcissistic behavior of a serial rapist (Teibel & Flick, 2004).

The Lessons and the Goal

To learn the many lessons from this case example, keep in mind that the investigators in Sparks, Nevada identified a suspect in their April 2001 case fairly quickly – based on detective work rather than DNA analysis. The suspect's DNA profile was then obtained from evidence seized during a search of his apartment (from his razor and toothbrush). This evidence was used to create a DNA profile for James Allen Selby that matched with the foreign DNA profile developed from evidence collected during the victim's medical forensic examination. However, secondary standards from toothbrushes and other such sources could not (and still cannot) be loaded into CODIS.

Investigators could not obtain a CODIS-eligible profile at the time, because Selby himself could not be located, arrested or prosecuted. The first lesson is therefore about the value of "good old fashioned police work" to identify suspects. While DNA is an incredibly powerful tool to assist in conducting a law enforcement investigation, it will never replace such techniques as interviewing victims and witnesses, searching criminal justice database, and canvassing neighbors.

Resources to Build Database

Investigators in Cleveland County, Oklahoma also identified James Allen Selby as the primary suspect in their September 1999 case. Again, this identification was based on detective work, rather than DNA analysis, and a DNA reference standard could not be obtained from Selby before he fled their jurisdiction. However, even if they had obtained a reference standard, it would only have been used to compare with the forensic DNA profile developed from evidence collected from the victim and her underwear. This comparison would have confirmed that the person they suspected of committing the crime (James Allen Selby) was in fact the one who left biological evidence on the victim's body and clothing. However, based on state law at the time, neither his identity nor his DNA profile would have been entered in CODIS until he was convicted. Depending on the state's resources, this might have taken years. Remember, states were rushing to obtain DNA samples from offenders who were scheduled to leave prison, rather than profiling individuals who had lengthy sentences ahead of them.

If this had not been the historical context for this case, it is possible that the subsequent assaults could have been prevented – not only the ones committed in the San Diego series, but also in Tucson and Colorado Springs as well. This is the goal we are striving to achieve today.

Thinking “Outside the Box”

Another lesson from this case example is the value of “thinking outside the box” when it comes to the collection and analysis of biological evidence.

Unfortunately, many law enforcement investigators – as well as medical professionals and others – tend to focus on issues of penetration, ejaculation, and semen in a sexual assault case. However, biological material (such as blood, skin cells, and saliva) can often be recovered following attempted sexual assaults, as well as other misdemeanor crimes that involve touching rather than penetration (e.g., groping or sexual battery).

Fortunately, law enforcement professionals in Tucson had the training they needed to recognize that DNA evidence could potentially be recovered from the body of the 13-year old victim. As part of her examination, swabs were taken of the victim's fingers and the suspect's DNA was recovered. This is exactly the kind of strategic evidence collection and analysis needed to solve and prosecute these complex cases.

More Than DNA Required

Despite the enormous power of DNA analysis, it is also worth keeping in mind that local authorities could not have successfully prosecuted the cases in this series with DNA

evidence alone. In the case involving the 55-year old victim, for example, Selby admitted that the sexual acts took place, but said the victim consented.³²

These crimes thus illustrate how a sexual assault case cannot proceed “from kit to court” with DNA evidence alone. Successful prosecution requires the type of evidence that can only be identified, collected, and documented with a thorough investigation.

If the Selby Case Happened Today

The lessons drawn from this example become particularly clear when we imagine how it might unfold differently today.

DNA at Arrest, Not Conviction

With the laws currently in place, investigators in Pima County, Arizona would have been able to enter Selby’s DNA profile in CODIS at the point of his arrest rather than his conviction. This is important because Selby was not convicted of that crime. He was acquitted by a Pima County jury, on the charges of attempted sexual assault, aggravated assault with a deadly weapon, false imprisonment, and kidnapping. He was only convicted for simple assault, a crime that did not make him eligible for inclusion in CODIS. As a result, his known DNA profile was not entered into CODIS, and it was not available to assist with the investigations in any of the subsequent cases.

Forensic DNA Profiles

Even at the time of the 2001 assault in Nevada, a forensic DNA profile could have been submitted to the Forensic Index of CODIS – based on evidence collected from the victim’s vaginal swabs. However, then as now, most police departments did not do this as a matter of routine practice. Because resources are limited, many police departments do not generally submit forensic DNA profiles in cases such as these, because they have already identified their suspect using traditional means (e.g., based on information gained from interviews, leads, and the list of registered sex offenders). We hope this module will help to change this practice, by encouraging law enforcement to make greater use of forensic DNA as an investigative tool.

Fortunately, the Sparks Police Department did have the foresight to submit evidence in their case for analysis, and they had a forensic DNA profile uploaded into CODIS. However, it was not available to other law enforcement agencies for over a year.

³² The consent defense is not typically available for sexual assault cases involving child victims under the age of 12, such as the 9-year old victim in the Selby case series. As a result, DNA evidence can often be more critical in successfully prosecuting these cases, because the suspect cannot argue that the victim consented if the evidence establishes that the suspect committed the sexual act(s).



In Oklahoma, investigators could not obtain a known reference standard from Selby before he fled their jurisdiction, so his DNA profile could not be entered into CODIS (then or now). Similarly, the detectives in Nevada would not be able to enter Selby's DNA profile into CODIS (then or now), because they were unable to make an arrest or develop a CODIS-eligible profile. If they could, it might have prevented the subsequent assaults in San Diego, Tucson, and Colorado Springs.

The case thus illustrates how recent the developments in DNA technology actually are, which helps us to appreciate how far we've come in such a short time. This also helps to understand why we currently face the challenges that we do.

Looking Back and Moving Forward

In this training module, we hope to provide the information needed to understand the history of DNA evidence and to recognize how it can be used to help successfully investigate and prosecute sexual assault cases. We specifically want to emphasize the fact that the problem of unanalyzed DNA evidence is not law enforcement's "dirty little secret," as so often portrayed in the media. The reality is that law enforcement investigators all over the country have been begging to have evidence analyzed from the forensic examinations of victims, clothing, and other crime scene evidence such as condoms, tissues, and bedding. Unfortunately, their efforts have often been thwarted by laws, technology, and resources – as illustrated in this example of a multi-state series.

The truth is this: If law enforcement investigators did not think forensic evidence was valuable, many of these examinations would not have been conducted in the first place. This is clear, because most medical forensic examinations were, and continue to be, facilitated by law enforcement.³³

The evidence being stored from many of these sexual assault cases could have been destroyed long ago, in accordance with laws, policies, and guidelines (such as the relevant statute of limitations). Yet law enforcement investigators and administrators have allowed rape kits to stack up by the hundreds of thousands, in evidence storage facilities across the country – and supervisors have signed off, again and again, on property room forms to authorize their continued storage. The reason is because *they hoped they would eventually*

³³ In 2005, the [Violence Against Women Act \(VAWA\)](#) was reauthorized with several landmark changes particularly affecting the response of law enforcement agencies and health care facilities to victims of sexual assault. These provisions are often referred to as "forensic compliance," and they have been upheld in subsequent reauthorizations of VAWA. They specify that states and territories may not "require a victim of sexual assault to participate in the criminal justice system or cooperate with law enforcement in order to be provided with a forensic medical exam, reimbursed for charges incurred on account of such an exam, or both." In other words, VAWA 2005 was designed to ensure that victims of sexual assault would have access to a forensic medical examination free of charge or with full reimbursement, regardless of whether they report the crime to police or otherwise cooperate with the criminal justice system. All states and territories must now certify that they are in compliance with these requirements in order to remain eligible for STOP Grant funds from the Office on Violence Against Women (OVW). For more information on VAWA forensic compliance, please see Module #14 in the [OnLine Training Institute \(OLTI\)](#) hosted on the EVAWI website, entitled, [The Earthquake in Sexual Assault Response: Implementing VAWA Forensic Compliance](#). There is also a special section of the EVAWI website dedicated to the topic of [forensic compliance](#), which includes extensive background, resources, and answers to Frequently Asked Questions.

have access to the laboratory resources they needed – to analyze the evidence and help in solving and prosecuting these cases.

Most law enforcement officers know that victims and their loved ones strive for closure, and many investigators have dedicated their lives to achieving this goal and holding offenders accountable for their crimes. In Part IV of this module, we turn our attention to more detailed guidance on the purpose and recommended practices for DNA evidence in a sexual assault investigation.

Part IV: Purposes and Recommended Practices for DNA Evidence

Because physical evidence is often limited in a sexual assault case, it has always been important for law enforcement to conduct a thorough investigation *when the identity of the perpetrator is unknown*. In contrast, DNA testing can now be used to identify an individual largely to the exclusion of all others. As a result, there can be a tendency for some investigators to hope the identity of the perpetrator will be established with a CODIS search, thereby avoiding the tedious and time-consuming process of an investigation. The attitude can be: “Let’s wait and see if we get a suspect in CODIS.” Yet there are two serious risks with this approach.

First, the perpetrator may have committed his/her first crime – or a repeat offender may have never been caught. In either scenario, the person will not be in CODIS, and a search will produce no matching offender profile.

The second risk is that an insufficient investigation will fail to support successful prosecution, despite a CODIS hit. It is therefore critical to highlight the importance of a thorough investigation in *all sexual assault cases*, regardless of whether or not there is a CODIS hit. Investigators who pin their hopes on a DNA hit potentially jeopardize the opportunity to hold an offender accountable.

With this in mind, we turn our attention to describing the alternative sources of DNA and exploring the potential purposes and impact of DNA in a sexual assault investigation.

Types of Biological Evidence

In this module we focus on DNA, so we will primarily discuss biological material that can be recovered from the victim, suspect, or crime scene.³⁴ Specifically, the following types of material may be important during the course of a sexual assault investigation:

³⁴ Latent fingerprints and trace evidence can also be collected in a sexual assault case and submitted for analysis. Trace evidence includes hairs, fibers, and other small or even microscopic evidence that could be related to the commission of a crime (e.g., dirt, grass, paint chips, explosives residue). Trace evidence also technically includes footwear and tire impressions; it is essentially any evidence transferred from contact with one person/object and another.

- **Semen** may be left by a male suspect either in or on a victim's body (whether male or female) or on other objects from the crime scene. This is the most common source of DNA evidence in a rape case.
- **Saliva** is the second most common source of DNA evidence. Saliva may be the result of kissing, licking, biting, or sucking, as well as oral copulation by either party. Saliva can also be left on objects, such as cigarette butts, cups, soda cans, and partially eaten food found at crime scenes. It is therefore important to swab any areas of the body where these acts have been described, as well as determining whether there might be saliva evidence on clothing or other objects left at the scene.
- **Blood may also be significant, and again, it may be found on the body or clothing** of the victim and/or the suspect, or on objects recovered from the crime scene. Blood can be transferred from a menstruating female to a male, or it can be the result of injury, which may corroborate the nonconsensual nature of the sexual act.³⁵
- **Fingernail scrapings or swabbings, as well as swabbings of the fingers** can often be collected from either party in a sexual assault case. In cases where a suspect has forced digital penetration on a victim, it is common for epithelial cells from the victim's vagina to accumulate on the suspect's finger, under or near the fingernails.³⁶ This can even be true if the suspect has bathed since the sexual assault. It is also possible for sperm cells to end up residing on the fingers or under the fingernails of a person who has orally copulated a male. Fingernail scrapings or finger swabbings may be of particular interest if there is evidence that the suspect or victim scratched the other party, or if the fingers of either person entered the other party's mouth, nose, or eyes. DNA from a person's sweat may even be recovered by collecting fingernail scrapings or finger swabbings, if the technology is sensitive enough.
- **Urine** contains cellular material from an individual that may be used to develop a full or partial DNA profile. However, urine has less cellular material than blood, semen, or saliva, because it is not inherent in the fluid. The source of a DNA profile is not the urine itself, but cells shed from the body during the process of urination.³⁷
- **Fecal material** may also be used to develop a full or partial DNA profile. As with urine, the source of a DNA profile is not the feces itself, but cells shed from during the process of defecation. These cells may be used to develop a full or partial DNA profile, but fecal

³⁵ Because of these two potential sources of blood, a sexual assault case may pose the question of whether the evidence collected was menstrual blood or the result of an injury. Most laboratories will not be able to differentiate between these two sources of blood evidence, but a sophisticated medical laboratory could potentially test for a hormone or other marker. This type of specialized analysis will be cost-prohibitive in many situations, but it should still be considered as a possibility for investigators and prosecutors when it is relevant given the facts of the case and the assault history.

³⁶ Epithelial cells line soft tissue surfaces, such as the vagina.

³⁷ Screening tests are readily available for laboratories to identify urine, but depending on a person's health (e.g., urinary tract infection), the number of white blood cells present in urine may vary. This may affect the likelihood of recovering a DNA profile.

material will contain the least amount of cellular material among these sources, and it will generally be compromised by the presence of bacteria.³⁸

- Other types of biological evidence include bodily fluids that are rich in cells, such as sweat or vaginal secretions. DNA can also be recovered from other bodily tissues and fluids (including mucus, ear wax, dandruff, etc.). However, they are not commonly used in the course of a sexual assault investigation or prosecution.

Both head and pubic hairs are still collected as a standard part of the victim's medical forensic examination protocol in some jurisdictions. Yet research suggests they are rarely analyzed by forensic laboratories (Peterson, Sommers, Baskin & Johnson, 2010; cited in Campbell et al., 2015), and they generally have little to no impact on the investigation and prosecution of sexual assault. It is important to recognize, however, that one reason why trace evidence such as hair is rarely examined is because biological evidence will typically be examined first. Trace evidence will generally only be examined in cases where DNA could not be identified.

Not Just Semen

As this discussion highlights, there are a number of types of biological material in addition to semen. In fact, a substantial number of sexual assault identifications are made on these other types of biological evidence. Too often an assessment of whether probative evidence exists in a sexual assault case is based solely on whether semen has been identified or sperm cells can be found under a microscope. This myopic view can limit an investigator's ability to solve a number of sexual assault scenarios that are actually quite common.

Sources of Biological Evidence

Much of the discussion of evidence in a sexual assault case focuses exclusively on the medical forensic examination of the *victim*. Yet a forensic examination should also be conducted *with the suspect*, whenever this is warranted. In addition, there are a number of other potential sources of biological evidence that should be collected during a sexual assault investigation whenever possible. These evidentiary items may include:

- Clothing worn by the suspect and/or victim – either during or immediately following the sexual assault. This includes any clothing that may have been discarded either during or after the sexual assault, but might still be available (for example, at the crime scene, in a laundry basket, or at the residence of either the victim or suspect).
- Any towel or other item that the victim describes as being related to the sexual assault (for example, items used to clean up after the assault).
- Any items that may have come into contact with biological material. This could include bedding or couch cushions, based on the location of the assault.

³⁸ There is at least one screening test available to identify feces, but it is not often used.

- Carpet, flooring, upholstery, or other surfaces where biological material may have been deposited.
- Discarded condoms or tissues, which often contain semen and/or biological material from the victim.
- Bottles or other objects that may have been used during the assault.

This list highlights the fact that probative evidence will often come from sources other than the victim's or suspect's forensic examination. It also underscores the importance of biological material other than sperm, which is often not available in a sexual assault case (e.g., Gingras et al., 2009). To illustrate, among the sexual assault cases where probative DNA is identified by the San Diego Police Department crime laboratory, as many as 25% are *not from the victim's medical forensic examination*. Instead, DNA is recovered from the victim's clothing or from evidence collected at the crime scene or during the suspect's forensic examination.

To obtain this type of evidence a search warrant will often be needed. A residential search conducted as part of a sexual assault investigation can potentially: (1) Yield evidence of the sexual act (e.g., seminal fluid from the suspect, epithelial cells from the victim, used condoms, or photographs); (2) Help to place the victim or suspect at the location; and/or (3) Provide corroborative evidence.



To provide an example what a residential search warrant might look like in a sexual assault case, a [sample affidavit and residential search warrant](#) are provided. These materials will need to be adapted based on the facts of a specific case as well as the law and resources in a particular jurisdiction. It is important to consult with a local prosecutor during this process.

Touch DNA

When it comes to the sources of DNA evidence, however, the fastest growing segment is referred to as "touch DNA." Touch DNA encompasses scenarios where a person comes into contact with another person or object for a period of time, thus leaving some biological material behind. Touch DNA is often enormously important in the analysis of guns, knives, tools, and other implements used in property crimes.

With the advent of touch DNA, the possibilities for recovering biological evidence appear to be limitless. For example, DNA profiles are now being recovered from sources such as handguns, spent casings, cell phones, tools, flashlights, steering wheels, gear shifters – even paper documents such as a demand note from a bank robbery. Touch DNA can also be recovered in some cases from articles of clothing (such as the headband of a hat, the waistband of underwear, bra clips, or buttons on pants).

One example illustrates the dramatic expansion of sources for biological material that can now be analyzed using modern technologies. Historically, criminal justice professionals



have believed that DNA could not be recovered from bullet casings, because any biological material left by the person loading the gun would be destroyed when the gun was fired. Yet emerging evidence indicates this is not true. In 2015, authorities in San Diego found a single bullet casing at the scene of a robbery and homicide. Within 24 hours, a DNA profile was developed from the casing, and a computer search revealed the suspect's name. Following a shootout with San Diego police officers, the suspect was taken into custody.³⁹ While most laboratories do not currently conduct DNA analysis on bullet casings found at crime scenes such as a homicide or a drive-by shooting, this will likely change with cases that have results like these.

Factors Affecting Touch DNA

The ability to develop a profile from touch DNA is affected by three critical components:

1. The length of time the subject was in contact with the object.
2. The amount of force applied when touching the object.
3. The number of other individuals who potentially touched the object.

An illustration can be drawn from a field that is very different from sexual assault. Due to the escalating price of copper, it is quite common for newly constructed housing projects to have copper pipe stolen and sold to recyclers. In some instances, the perpetrators have left their cutting tools behind. These are tools that have been used with a significant amount of force as well as continual contact by the perpetrator(s). As a result, DNA testing of swabs collected from these items routinely provides DNA profiles of a very high quality, although mixtures can sometimes be present.

On the other hand, laboratories are sometimes asked to test objects that have only been briefly touched by the perpetrator, such as a desk lamp that might have been moved by someone entering a home through a window. This type of momentary contact is unlikely to yield significant DNA, and success rates are therefore very low. Anecdotal evidence also suggests that low success rates have been seen in cases involving physical contact such as groping, because the contact between victim and perpetrator may be brief, and it often covers a relatively large surface area of the victim's clothing or skin.

The other factor affecting the ability to obtain a DNA profile is the number of individuals who might have come into contact with the person or object over time. With a gun or tool, there may be a limited number of individuals; however, with many other surfaces the potential number of contributors can be significant. For example, laboratories are often asked to perform DNA analysis on door handles in burglary cases, or convenience store counters in robbery cases. However, in both of these scenarios, hundreds of people may have come into contact with the surface, each contributing a very small amount of DNA. As a result, DNA testing is not likely to yield probative information and is therefore discouraged.

³⁹ Information provided by Dr. Patrick O'Donnell as well as a [press release issued by the San Diego Police Department](#) on their Twitter feed on April 18, 2015.

In cases such as these, where analysis is unlikely to yield a probative DNA profile, the question often comes down to whether any other investigative information is available. If there is no other meaningful information, but the crime is as a very serious concern for the community (perhaps because of the threat of possible escalation), the laboratory might agree to conduct the analysis despite the limited chance of success. These situations will be negotiated between investigators who are desperate for information and laboratory personnel facing their own workloads and backlogs.



The [National Forensic Academy](#) offers an intensive 10-week course on Crime Scene Management, with funding by the Bureau of Justice Assistance. The course is designed to meet the needs of law enforcement professionals in evidence identification, collection, and preservation.

Valuable guidance is also provided in the [Biological Evidence Preservation Handbook](#), which was published in 2013 by the National Institute of Standards and Technology and the National Institute of Justice. This document includes a helpful table describing a number of potential sources of biological evidence, and the likely location and source of DNA on the evidentiary item. We offer the table here, with credit to the *Biological Evidence Preservation Handbook* and the National Institute of Justice (2002).

Case Example

Yet another example from the San Diego Police Department illustrates the complex decision making often necessary in high profile sexual assault cases with limited DNA evidence. In this case, several female students reported being followed near a college campus, by a man whom they could only vaguely describe. The students were followed for a short period of time, and when they were in a relatively isolated location, the man grabbed them, groped them over their clothing, and then ran off. In addition, he bit one of the female victims on her buttocks, through the jeans she was wearing. All of the attacks were believed to be part of a series perpetrated by the same person.

Due to the nature of the assaults, the laboratory agreed to analyze the evidence collected during the course of each investigation. The facts of each case were reviewed, and a criminalist examined each victim's clothing to determine where a swab of the clothing surface might be collected. Swabs were ultimately collected in three different cases, and DNA analysis revealed a female contribution (from each victim) plus several foreign DNA types. However, the amount of foreign DNA was insufficient to compare with possible suspects or to submit to CODIS to search for known offenders or matching cases.

In this case, the bite evidence was the highest priority for testing, because saliva is a rich source of cells and human DNA. The jeans from the biting victim were examined under an alternate light source and fluorescence was noticed in a specific location on the surface. A swabbing of this area was taken, and DNA testing revealed a major male contributor. The DNA profile was of sufficient quality to be searched in CODIS, and a hit was found with an offender who had a prior history of sexual assault.



Where to Look for Biological Evidence

The identification of biological evidence can be a critical step in a successful sexual assault investigation and criminal prosecution. Specialized training is therefore needed to ensure that key evidentiary items are properly identified and collected for laboratory analysis, and that they are appropriately documented, packaged, stored, and protected from potential contamination.

Examples of Sources of Biological Evidence

Evidence	Likely Location of DNA on the Evidence	Source of DNA
Baseball bat or similar weapon	Handle, end	Sweat, skin, blood, tissue
Hat, bandanna, mask	Inside	Sweat, hair, dandruff
Eyeglasses	Nose or ear piece, lens	Sweat, skin
Facial tissue, cotton swab	Surface area	Mucus, blood, sweat, semen, ear wax
Dirty laundry	Surface area	Blood, sweat, semen
Toothpick	Tip	Saliva
Used cigarette	Cigarette butt	Saliva
Stamp or envelope	Licked area	Saliva
Tape or ligature	Inside/outside surface	Saliva, skin
Bottle, can, glass	Side, mouthpiece	Saliva, sweat
Used condom	Inside/outside surface	Semen, vaginal or rectal cells
Blanket, pillow, sheet	Surface area	Sweat, hair, semen, urine, saliva
"Through and through" bullet	Outside surface	Blood, tissue
Bite mark	Person's skin or clothing	Saliva
Fingernail, partial fingernail	Scrapings	Blood, sweat, tissue

Source: [Biological Evidence Preservation Handbook: Best Practices for Evidence Handlers](#), National Institute of Standards and Technology and the National Institute of Justice (2013).

This table is only intended to provide general guidance. The ultimate determination of whether and where a particular item might contain biological evidence will need to be made by investigators with knowledge of the specific case.

Patrol Response and Crime Scene Services

When considering potential sources of biological material, it is important to recognize that the laboratory may spend as much, if not more, time screening large quantities of seized

evidence for probative biological material – as compared with actually conducting the DNA analysis. It is therefore important for law enforcement agencies to utilize crime scene technicians with specialized training whenever possible.

Most crime laboratories offer crime scene services, and they can assist by assessing a complicated sexual assault scene for the presence of probative biological material. When they respond to the scene, crime scene technicians can examine a wide range of environments where the sexual assault may have taken place. They can even bring specialized equipment such as an alternate light source, to efficiently limit the collection of evidence to those items most likely to have important biological material.

★ Screening Evidence at Crime Scenes

Over the years, a number of strategies have been used to screen evidence at a crime scene and determine which items might have probative value and should therefore be collected for analysis. One technological innovation that can assist in this process is ambient mass spectrometry, a technique for identifying the chemical makeup of certain solids, liquids, and gases. With portable instruments now available to conduct this analysis in the field, the potential for streamlining evidence collection and analysis is greatly enhanced. For more information, please see the *report* on this topic written by Mulligan and O'Leary (2015) and published by the National Institute of Justice.

When in Doubt, Collect It

Even if all of the items collected from a crime scene will not be examined by the laboratory, it is generally considered better to collect and store any evidence that might potentially be probative, rather than not to collect at all.

To offer an illustration, semen may be deposited on a bedsheet or bedroom carpet after a victim is sexually assaulted and forced to orally copulate a suspect. Some officers may not collect the sheet or carpet, based on the presumption that the victim's mouth swab will contain the probative semen evidence needed to prosecute the case. However, this is an optimistic view that is not always supported by case outcomes. Officers are often given only a single chance to collect such critical evidence, and overlooking or ignoring it could lead to the suspect either destroying the evidence, or cleaning it up after the opportunity for collection has passed. Fortunately, research indicates that DNA samples collected by patrol officers are as likely to yield high quality evidence as those collected by forensic technicians – at least in property crime cases.⁴⁰

Pregnancy and Paternity Testing

Before we conclude this discussion of the possible sources of DNA, it is important to note that a pregnancy resulting from a sexual assault can also yield critical biological evidence.

⁴⁰ Information drawn from the website for the National Institute of Justice, on a page entitled, *Summary Findings of the DNA Field Experiment* (accessed 03/03/15).

Because 50% of a person's DNA is contributed by the mother, and 50% is contributed by the father, pregnancy can both establish the act of penile-vaginal penetration and identify the perpetrator. This evidence can then be used to pursue criminal charges, or to exclude a suspect. This can be especially helpful in cases where a consent defense is not available; for example, in cases where the sexual assault offense is based on the victim's incapacity to consent due to age, severe disability, or relationship between the parties (i.e., incest). Evidence of pregnancy can also be important in sexual assault cases where the suspect has denied sexual contact or penetration.



Because investigators will not typically handle a large number of cases involving fetal tissue, [instructions on how to collect this material](#) can be very helpful. We provide an example from the San Diego Police Department Sex Crimes Unit in the Appendix to this module, but investigators should determine which laboratory they will use for any such analysis and follow any specific instructions the laboratory might provide.

After Birth or Aborted Fetal Tissue

In addition, DNA testing can be conducted on infants after birth or on aborted fetal tissue. In the case of a live child, reference samples can be collected from the child, the mother, and the suspected father. All three samples will then be submitted to a laboratory for analysis, so the mother's contribution to the child's DNA can be isolated. This allows the remaining portion of the DNA to be compared with the reference sample collected from the suspected father. Given the power of current DNA analysis, such testing leaves little doubt as to whether a suspect is in fact the father of the child.

Analysis of aborted fetal tissue involves distinguishing biological material belonging to the aborted fetus from material contributed by the mother. Depending on the age of the pregnancy, separating aborted fetal tissue from maternal tissue can be challenging, and the laboratory may need the assistance of an embryologist to accomplish this. Once fetal material is isolated, the DNA testing process occurs much in the same manner as described for a baby that comes to term.

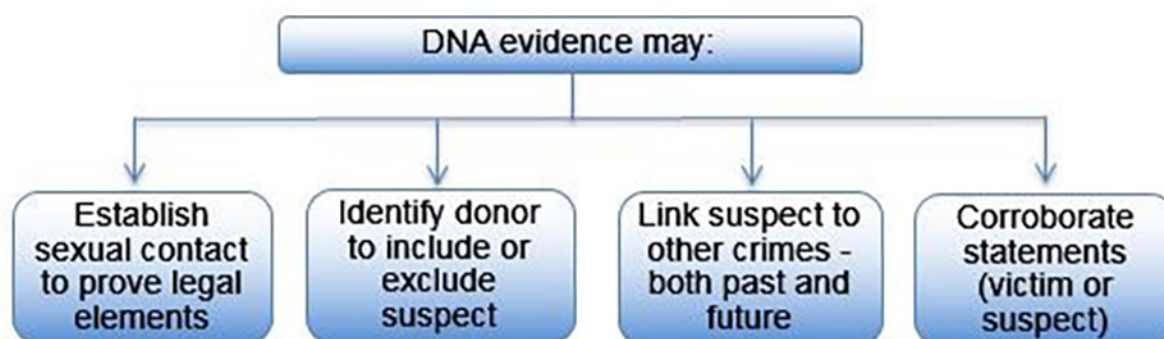

Primary Purposes of DNA Evidence

Once biological material has been collected from any of the sources described in the prior section, it may be used for a variety of purposes during the course of a sexual assault investigation. This is important to keep in mind, because the same evidence may be used for different purposes depending on the history of the assault and specific case facts.

1. Establish Sexual Contact

One primary purpose of biological evidence in a sexual assault investigation is to establish that a sexual act took place. This is important, because it may help to prove an element of the offense. For example, the suspect's semen might be found in the victim's vagina or on the victim's external genital area, thereby establishing penile-vaginal penetration. Alternatively, the victim's epithelial cells might be found on the suspect's fingers or underneath the suspect's fingernails, establishing digital penetration.

This can be particularly important when the suspect admits to certain acts (such as oral contact with the victim's breasts or penile penetration of the victim's vagina), but denies other acts (such as penile penetration of the victim's anus). Biological evidence may establish that these acts did in fact take place, which can be critical for the investigation and prosecution of the sexual assault, but also for sentencing purposes as well.

Even if the evidence does not establish that a particular sexual act took place, it may still indicate that sexual contact took place more generally. For example, the suspect's semen or saliva may be recovered from the victim's skin in a non-genital area (e.g., stomach, back, arm, leg, face).

It is worth noting, however, that both victims and professionals often place too much importance on this first purpose. While biological evidence can be used in some cases to establish that a particular sexual act was committed, the absence of such evidence does not necessarily mean it did not occur. In other words, a sexual assault case is not "doomed" just because semen is not found. The reality is that half or more of all medical forensic examinations do not yield semen evidence,⁴¹ and most sexual assault victims do not have an examination at all, so there is no forensic evidence available from the victim's body.

⁴¹ For example, in one study of 1,007 rape survivors who had a medical forensic examination, 37% of 919 vaginal specimens tested positive for sperm. A higher percentage (62%) tested positive for acid phosphatase (Tucker, Claire, Ledray & Werner, 1990), which is an enzyme that "is present in large quantities in seminal fluid and minimal concentrations in vaginal fluids" (Ledray, 2005, p. 132). When a high level of acid phosphatase is identified in evidence collected from a sexual assault victim, this indicates that sexual contact took place recently. In another study of 212 women who had consensual sex within four days of their medical forensic examination, 60% tested positive for prostatic acid phosphatase (PAP) and 84% tested positive for prostatic specific antigen (PSA) (Roach & Vladutiu, 1993, cited in Ledray, 2001). Both PAP and PSA are enzymes secreted by the prostate gland; a high concentration recovered from a victim is again indicative of sexual contact. Also see the report by Gingras et al. (2009), who analyzed the results of 1,000 sexual assault cases with evidence submitted to a laboratory. A foreign DNA profile was obtained from samples collected from the victim's body in only 32% of cases, but this figure did not include any samples collected from clothing, bedding, etc.

2. Identify or Exclude a Suspect

A second purpose is to identify or exclude the person who committed a sexual act. In many cases, a sexual assault investigation will not have a definitive suspect. This can be due to the fact that the perpetrator was a stranger to the victim, or because of the nature of the sexual assault (e.g., it was dark, the suspect wore a ski mask, the victim was unconscious at the time). In these scenarios, the investigator will begin with standard investigative techniques to gather information and identify possible suspects.

For example, if the perpetrator is a stranger, the investigator might evaluate any similar crimes or registered sex offenders in the area. Alternatively, a composite sketch might be developed to help generate investigative leads. In the case of a drug or alcohol facilitated sexual assault that was committed at a party, the investigator might interview other people who attended the party, to find out who was seen with the victim. Once these efforts lead to the identification of any possible suspects, DNA reference standards should be collected and submitted for analysis as soon as possible.

As long as the buccal swab is obtained legally, a local laboratory can develop the suspect's DNA profile, and it can be compared with evidence collected in the case. The suspect's profile can also be searched in the local DNA database – and possibly in SDIS as well – depending on state laws and policies. However, suspect reference standards obtained during the course of an investigation, prior to establishing probable cause, cannot currently be uploaded or searched in NDIS.

Another possibility is that unknown suspects can be identified based on evidence collected from the victim's body, clothing, or the crime scene. If the laboratory is able to develop a CODIS-eligible profile from the evidence, it can be uploaded as a forensic unknown and searched for a match at all three levels of the database system (LDIS, SDIS, and NDIS). If any of the searches produce a hit in the Convicted Offender or Arrestee Index, the suspect's identity can be established with virtual certainty, and the case might be prosecuted – if the suspect can be located, the investigation yields sufficient evidence, the victim is able to participate in the process, etc.

The profile might also match with other forensic unknowns in CODIS (in the Forensic Index). If so, this indicates that the same person is associated with additional crimes – whether these crimes are sexual or not. Even if the person's identity still remains unknown at this point, a link between the cases may help to identify the suspect by producing a viable lead. Investigators can compare notes in the case files and pursue standard investigative techniques to identify, locate, and arrest a suspect. In fact, it is quite common for CODIS searches to reveal a suspect that had been previously overlooked by investigators – or to exclude someone who was originally thought to be involved in the crime.

If no match is found in CODIS, the forensic DNA profile will continue to be searched. In most state databases (SDIS), and in the national database (NDIS), a new search of CODIS is conducted once a week. This means a hit could be obtained at any time, which could advance the investigation. However, there are sometimes gaps in the offender profiles indexed in CODIS. If an investigator believes that a specific offender might be responsible

for a sexual assault or another crime, it is worth confirming with the State CODIS administrator that the offender is in fact in NDIS.

Research suggests that DNA can play an important role in this process of identifying a suspect and contributing to an arrest and prosecution. One study of property crimes committed in five jurisdictions found that cases with DNA evidence were five times more likely to yield a suspect identification and nine times more likely to result in an arrest.⁴²

However, it is critical to note that DNA reference standards should always be collected from suspects, regardless of whether the person is only a possible suspect or if the investigator is confident that the suspect has been correctly identified based on investigative facts. As described above the suspect's profile can be compared with evidence collected in the case – and searched on a local, and possibly even state level, depending on laws and policies.

Forensic profiles should also be submitted to CODIS in each sexual assault case (after any consensual partner has been excluded). This way, the suspect's profile can be uploaded while the investigation is ongoing, rather than waiting for an arrest or a conviction. Beyond confirming the identity of the suspect, a hit with a forensic DNA profile could advance the investigation in a variety of other ways (to be discussed in subsequent sections). For example, DNA testing could reveal that the suspect was arrested or convicted for an offense that was previously unknown to the investigator and/or it could connect the suspect with additional crimes based on forensic evidence.

3. Identify Prior Convictions or Arrests

While many of these purposes overlap, a third use for DNA is to identify a suspect's prior convictions or arrests. Because DNA profiles of known individuals have historically been entered in CODIS at the point of conviction, a hit traditionally meant that the suspect had been convicted for at least one prior offense. Now that many states allow DNA profiles to be entered at the point of an arrest, a CODIS hit may also mean the person was arrested for at least one qualifying offense. In either situation, a CODIS hit may help in the prosecution of the present case by demonstrating a pattern of past criminal behavior. However, such evidence is only likely to be offered at trial if the past arrest or conviction was also for a sexual assault, or for some other offense with significant similarities to the present case (e.g., both crimes involved a similar pattern of burglary or home invasion). Otherwise, it may only be presented at the sentencing phase of the trial, not for a verdict.



⁴² Information drawn from the website for the National Institute of Justice, on a page entitled *Summary Findings of the DNA Field Experiment* (accessed 03/03/15).

4. Link Cases Based on Evidence

Another purpose of DNA evidence is to link cases with evidence submitted in any past cases – not just for sexual assault, but for any criminal offense included in the local, state, or national database. The frequency of such case-to-case linkages was demonstrated in the report cited earlier from the British Home Office (2014). It is also seen in cities like Detroit and Cleveland that have submitted evidence from thousands of sexual assault cases stored in police property rooms. In Detroit, for example, the National Institute of Justice funded a Sexual Assault Kit (SAK) Action Research Project, which resulted in the analysis of evidence from 1,595 stored kits. When this evidence was analyzed, it linked with cases from 32 different states (Campbell et al., 2015). In Cleveland, almost 4,000 evidence kits were tested between 2010 and 2015. As of September 2015, this process has yielded 350 grand jury indictments and 100 convictions, many for multiple rapes. What has surprised officials most, however, has been the number of rapes committed by serial perpetrators.

One stunning finding that emerged from Cleveland's investigations is that as many as a third of reported rapes were perpetrated by a serial offender, a much higher proportion than officials anticipated. 'I've been in this business for 43 years and I thought I knew I something about it,' says [Timothy McGinty, the Cuyahoga County prosecutor] who guessed about 15% would be attributable to serial offenders. 'I was astonished' (Gourarie, 2015).

With the continued expansion of CODIS, we are likely to see an increasing number of hits with a wide range of offenses, including misdemeanors such as peeping and indecent exposure. Often, cases such as these have not been prosecuted because the suspect's identity was unknown at the time of the initial investigation. However, in other cases, law enforcement may have identified the suspect, but prosecution was not pursued for other reasons (e.g., the victim was unable to participate in the criminal justice process, or the prosecutor rejected the case because of insufficient evidence).

These prior cases may therefore prove critical for a successful investigation and prosecution of a later case. They could demonstrate the same pattern of behavior seen in the current crime (e.g., a series of sexual assaults perpetrated against prostituted women), or they could reveal a more general pattern of deviant sexual behavior, not rising to the level of felony sexual assault.

Linked cases can be particularly helpful when they would not otherwise be successfully prosecuted. An example from the New York City initiative illustrates this point.

We had an assailant who raped drug addicts coming to him to buy drugs. These are women who may be particularly vulnerable to rape because of their addictions or their socioeconomic status, but whose cases are hard to get a jury to believe. But when we could connect the same guy to a number of rapes, we could get a conviction (Human Rights Watch, 2009, p. 55).

Depending on case law in a specific jurisdiction, it may be possible to introduce evidence or victim testimony from these prior cases – even if the cases did not result in an arrest or prosecution, or if the statute of limitations has already expired. In some situations, cases may even be prosecuted jointly again depending on case law in the jurisdiction, as well as the specific facts of each case, and a host of other factors.⁴³

Of course, it is also important to submit DNA profiles to CODIS, so they are available to match with evidence submitted in any future cases if the suspect re-offends. This is critically important, because research indicates that rapists commit an average of six rapes (Lisak & Miller, 2002; McWhorter et al., 2009). One failed opportunity to hold an offender accountable may therefore equate to five or more additional victims.

5. Corroborate Statements

As previously noted, a primary purpose of DNA is to establish that a sexual act took place. However, this is more likely to be crucial when the suspect denies committing the act. In most cases of nonstranger sexual assault, the suspect acknowledges that the sexual act took place but states that the victim consented.

A consent defense is even raised by many suspects who begin by denying that the sexual act took place. In fact, a defense of denial or misidentification will often switch to consent once the suspect is confronted with evidence such as DNA. In these cases, DNA can be used to corroborate – or call into question – statements made by both parties.

To illustrate, a female victim may state that the suspect licked or kissed her breasts. If a forensic examiner swabs this area and recovers saliva that is later identified as being the suspect's, this will not necessarily establish an element of the criminal offense – but it can corroborate the victim's account of events.

⁴³ While this module focuses on biological evidence, it is also worth noting that cases are frequently linked on the basis of other factors such as the suspect description, geographic location, pattern of behavior, etc. This is the domain of crime analysis, and databases have been developed for capturing and comparing data on local, regional, statewide, and national levels. For example, the FBI developed ViCAP (Victim Criminal Apprehension Program), with the goal of identifying serial offenders committing violent and sexual crimes, especially homicide. However, a very small proportion of crimes are included in ViCAP, compared with the vast number of DNA profiles currently indexed in CODIS.

Alternatively, the suspect and victim may provide different accounts of the specific acts committed, and biological evidence could help lend credibility to one version or the other. It is therefore critical for investigators to obtain a detailed account of the sexual acts from the victim and suspect (whenever possible), and focus attention on the evidence collected from areas where their statements diverge. Biological evidence such as DNA can also help to corroborate the element of force. For example, if a male victim presents with lacerations around the anus and semen is detected on the rectal swabs, this can help support the conclusion that the injury was caused by penetration with a penis. The evidence does not, however, conclusively establish whether or not the contact was consensual.

Ultimately, evidence to establish force, threat, or fear is needed to overcome the consent defense established with other forms of evidence, such as the victim's testimony or testimony by other witnesses (including forensic examiners).

Algorithm for Biological Evidence Collection

Because there are many potential purposes of DNA evidence in a sexual assault investigation – and these various purposes are complicated and overlapping – we have developed the following conceptual algorithm. It is designed to help identify questions that must be addressed at various stages of the investigation, including whether the suspect's identity is known, whether a forensic examination can be conducted with the suspect, or – at a minimum – whether reference standards can be collected from the suspect. The algorithm also addresses the question of whether a DNA profile has been submitted to CODIS and whether a CODIS hit has been obtained. While it is written as if there is only a single suspect involved in the case, the same logic would apply to cases with multiple perpetrators that is typically raised in most sexual assault cases. While biological evidence such as DNA can sometimes help to corroborate this element of force, it is worth noting that this is more frequently.

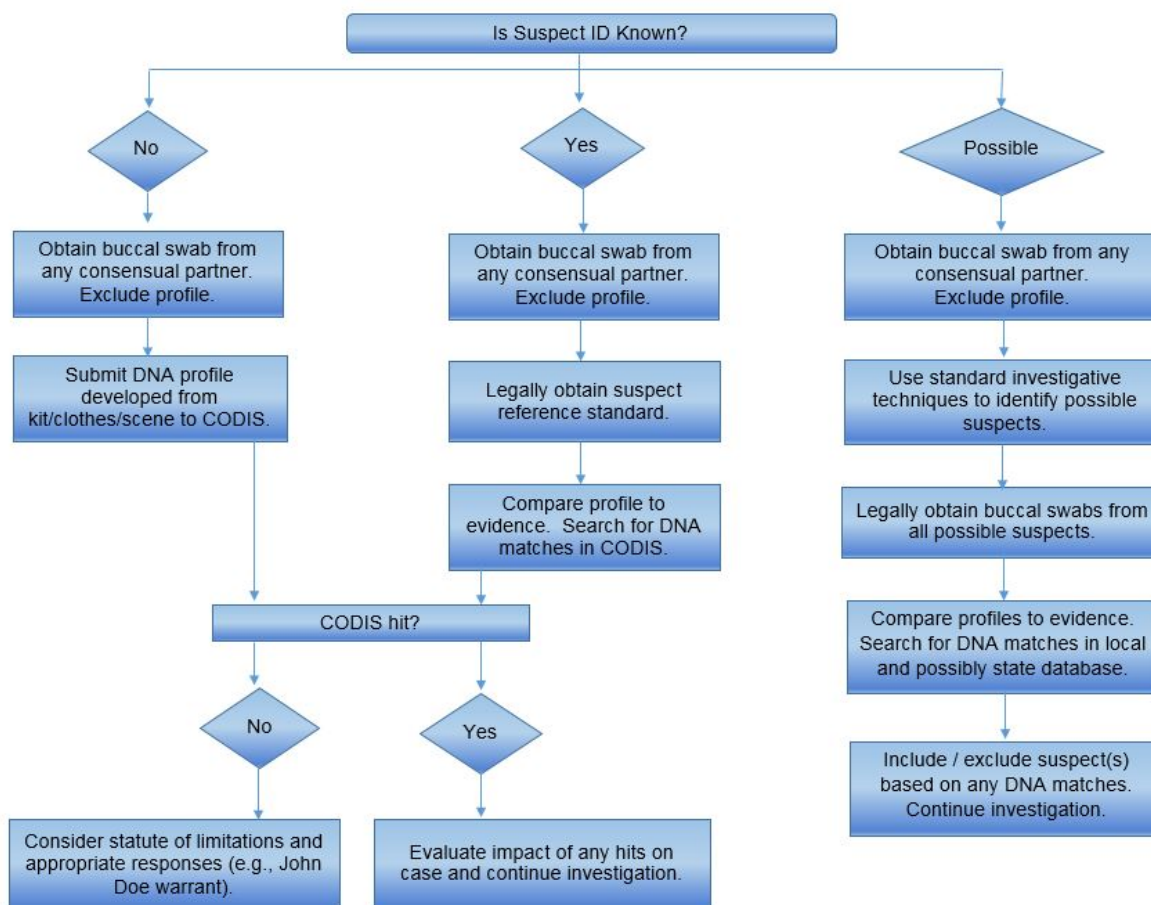

Which Evidence is Likely to be Most Probative?

After describing the various sources of biological evidence, and exploring their potential purposes in a sexual assault investigation, it is possible to begin exploring alternative scenarios where DNA evidence collected from the body or clothing of the *victim* may be absolutely critical – as well as DNA evidence collected from the body or clothing of the *suspect*.



Of course, biological evidence may also be recovered from other items (such as clothing, bedding, used condoms, couch cushions, carpet sections, or foreign objects). Particularly important are items of clothing that had contact with the victim's or suspect's body during or immediately after the assault, as well as anything used to clean up after the assault. The identification of these items will be based on observations as well as the history of the assault provided by the victim, and possibly by the suspect or other witnesses.

It is therefore critical for investigators to conduct a careful review of all the evidence collected in a sexual assault case – based on the history of the assault – to determine

which items are likely to be probative and which element(s) they might help to establish. This review can then guide decisions regarding which items to prioritize for analysis.

Evidence Collected from the Victim

For example, the following case scenarios offer examples where evidence collected from the *victim* is likely to produce a probative finding:

- A male suspect penetrates the victim's vagina, anus, or mouth with his penis, and then ejaculates. Semen may therefore be recovered from the victim's orifice.⁴⁴
- A male suspect ejaculates on any of the victim's body surfaces. Again, semen may be recovered from the victim's body surface.
- A suspect (regardless of gender) has oral contact with any of the victim's body surfaces, including orifices. This may include the act of biting, sucking or licking. In this scenario, the suspect's saliva may be recovered from the victim's body.
- The victim describes scratching the suspect. Biological material from the suspect may be found underneath the victim's fingernails or on the victim's fingers.
- The victim is forced to digitally penetrate the suspect's anus or vagina. Again, biological material from the suspect may be found on the victim's fingers or underneath the victim's fingernails. In fact, finger swabbings and fingernail scrapings/swabbings are often a better source of evidence than an orifice, because soft tissues like the vaginal lining are rich sources of DNA, while surfaces such as the durable finger skin shed very little DNA over short periods of time.
- A male victim is forced to penetrate the suspect's orifice with his penis, with or without ejaculation. Biological material from the suspect may therefore be recovered from the male victim's penis or scrotum.

⁴⁴ It is important to note that both internal and external swabs are typically taken of each orifice during a medical forensic examination. While this is often done with the vagina and anus, swabs are not always taken from both the inside of the victim's mouth as well as the external area around the victim's mouth (not including the lips). These swabs are sometimes referred to as "external peri-oral swabs," and they can often recover more foreign biological material than the standard oral swabs taken from inside the mouth. The lips should not be swabbed, however, because they will produce too much of the victim's DNA which could potentially overpower any foreign DNA that might be recovered.



In all of these scenarios, biological evidence collected from the victim may prove critical for the purposes we have previously described. For example, it may be used to establish sexual contact, identify or exclude a suspect, link the case with others, and/or corroborate either the victim's or suspect's account.⁴⁵

Evidence Collected from the Suspect

In other scenarios, probative evidence is more likely to be found on the body of the suspect, rather than the victim. For example:

- A male suspect penetrates the victim's mouth with his penis but does not ejaculate. Semen will probably not be recovered from the victim's mouth, but preejaculate might be (if the examination is conducted promptly). Biological evidence from the victim is more likely to be recovered from the suspect's penis or scrotum.
- Alternatively, the male suspect ejaculates in the victim's mouth, but the victim washes out her/his mouth or brushes her/his teeth. Again, semen is not likely to be recovered from the victim's mouth, but biological material from the victim may be found on the suspect's penis or scrotum.
- A male suspect penetrates the victim's vagina anus, or mouth with his penis, but he uses a condom – and the condom is not recovered. Because the suspect's ejaculate will typically be deposited in its entirety in the condom, the suspect's scrotal swab should be examined for biological material from the victim (e.g., vaginal secretions, epithelial cells). It is also common for female fluids and cellular material to accumulate on the penile surface not covered by the condom.
- A male suspect penetrates the victim's vagina with his penis, but he does not ejaculate. Biological material from the victim might be found on the penile or scrotal swab collected from the suspect.
- A male victim is forced to penetrate the suspect's orifice with his penis, and the male victim ejaculates in or on the suspect's body. The victim's semen may thus be recovered from the suspect's body or orifice.

⁴⁵ It is also worth noting that the *victim's* reference sample will need to be analyzed during the course of a sexual assault investigation, because it allows the laboratory to confirm the origin of the evidence from the victim's medical forensic examination. To illustrate, the non-sperm fraction of the sample analyzed from the victim's vaginal swabs should match the reference sample collected from the victim (using a blood draw or buccal swab). This confirms the accuracy of the victim's sample and also allows the laboratory to infer that any portion of the sample not attributed to the victim is likely to have been contributed by the suspect. If the two samples collected from the victim *do not match*, this may indicate a mixup of forensic evidence kits, with evidence collected from one victim possibly confused with another.

- The suspect digitally penetrates the victim's vagina or anus. In this scenario, biological material from the victim may be found on the suspect's fingers or underneath the suspect's fingernails.
- The victim is injured during the sexual assault, and blood is found on the suspect's body. Alternatively, the victim may report fighting the suspect, indicating that scratches, bite marks, or other signs of injury may be found on the suspect's body.

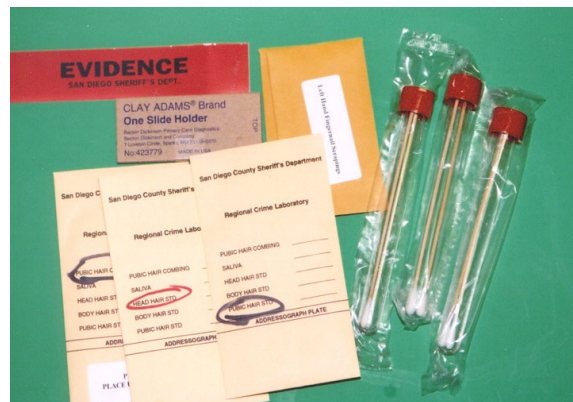

Some of these scenarios are more common than others, yet they demonstrate that probative DNA evidence will sometimes be more likely to be found on the body or clothing of the *suspect* rather than the *victim*. This evidence may be used to meet any or all of the purposes described earlier.

Obtaining a Forensic Examination of the Suspect

When evaluating potential sources of evidence, many professionals focus on anything that might have transferred *from the suspect to the victim*, but it is equally important to consider evidence that might have transferred *from the victim to the suspect*. In fact, depending on the type of contact involved in a sexual assault offense, the suspect's body may actually be a better source of probative evidence than the victim's.

To highlight this point, consider a study conducted by Isaac Cain (2002), entitled: *The Use of Physical Evidence in the Investigation and Prosecution of Sexual Assault Cases*.⁴⁶ The research was conducted while Sgt. Joanne Archambault was supervising the Sex Crimes Unit at the San Diego Police Department, and it examined the findings from 77 sexual assault cases with laboratory analysis conducted by the San Diego Police Department Forensic Biology (DNA) Unit between 1998 and 1999. The study's results revealed a number of interesting conclusions, one of which was how frequently the victim's DNA profile was recovered from evidence collected during *the suspect's forensic examination*.

As we present these findings, keep in mind that evidence in a sexual assault case is only submitted to the laboratory for analysis by the San Diego Police Department *based on the assault history*. By evaluating the specific facts of the case, investigators make decisions regarding what evidence to submit to the laboratory and which analyses to request, based on the likelihood that the analysis will yield probative information and advance the case.

- In the Cain (2002) study, for example, penile swabs were analyzed in only 5 sexual assault cases with an adolescent victim. Of these 5 cases, however, 4 swabs (80%)

⁴⁶ This study was submitted as a Master's Thesis in Forensic Sciences to National University in San Diego, California. It can be obtained by request from EVAWI.

yielded epithelial cells from the victim, and 3 of these 4 swabs (75%) produced a DNA profile for the victim.

- Similarly, penile swabs were submitted for analysis in 10 cases involving an adult victim. Epithelial cells were found in 3 (30%) of these cases – all of which (100%) yielded a DNA profile for the victim.

While these numbers are rather small, the high percentages support the practice of submitting items for analysis based on the assault history. Investigators were clearly making determinations regarding which items were likely to yield probative evidence. In fact, any time a victim's DNA is recovered from the suspect's body, this could be important in the investigation and prosecution of a sexual assault. It is therefore surprising that so few law enforcement agencies and forensic examiner programs currently have protocols or policies for collecting evidence from the suspect during a forensic examination.

Clothing of the Suspect

Equally surprising is the frequent failure to seize a suspect's clothing, which again could be a critically important source of probative evidence. In many cases, the clothing worn by the suspect during the sexual assault is still available and – depending on the specific case history and timeframe – it is often a better source of evidence than the forensic examination. This point is also illustrated with findings from the Cain (2002) study. Again, keep in mind that evidence in these cases was only submitted for analysis based on the assault history and the likelihood that it would advance the case.



Photo Credit: Diana Faugno

- Of 25 cases with an adolescent victim, a total of 8 items were analyzed in the category of suspect clothing or other crime scene evidence associated with the suspect (e.g., condoms, bottles, tissues). Of these, the victim's blood was found on 3 items, and epithelial cells were found on 1. Subsequent DNA testing then yielded a DNA profile for the victim on all of these items (100%).
- Similarly, 51 cases in the study involved adult victims. For these cases, analysis was conducted with 15 items representing clothing from the suspect or other crime scene evidence associated with the suspect (e.g., condoms, bottles, tissues). The victim's blood was found on 2 of these items, and epithelial cells were found on 1. The victim's DNA profile was then developed from all 3 items.

Clearly, important evidence can often be obtained from the body and clothing of the suspect, as well as other crime scene evidence in a sexual assault case. This is especially significant because so many people think of sexual assault cases as not having physical evidence – that they are simply a question of “he said, she said.” In many cases, however, physical evidence can be obtained if we look in the right place, based on the specific history of the assault and an evaluation of the evidence available.

Not Just About Identification

Despite the importance of identifying the victim's DNA on the suspect's body or clothing, this is not the only purpose of obtaining a suspect examination. As previously noted, the location of the victim's biological material on the suspect's body may establish the specific acts involved in the sexual assault (e.g., penile-vaginal penetration, digital penetration, anal penetration, oral copulation). Alternatively, it may indicate sexual contact more generally. Either way, this type of evidence may be particularly helpful with very young victims, victims who have severe physical or mental disabilities, or victims who are under the influence of drugs or alcohol, because they may not recall or may not be able to articulate exactly what happened to them. Evidence of the victim's DNA on the suspect's body can also be important in cases involving multiple perpetrators, or in cases where the victim knows that a suspect participated in an assault but is not sure if there was penetration.



Photo Credit: Diana Faugno

Even beyond DNA, a suspect examination can yield documentation of the suspect's clothing, appearance, physical anomalies, tattoos, piercings, and other characteristics. Any of these factors may become important later on during the course of an investigation and prosecution. If the suspect is identified and located soon after the crime, it can even corroborate information that the victim provides about sensory experiences, such as the suspect's smell (e.g., aftershave, cigarettes, body odor, bad breath).

Evidence from the suspect examination can also provide other types of information that may help to fill in what happened before, during, or after the sexual assault. For example, debris from leaves could be found on the suspect's body that came from the bushes outside the victim's home, or paint chips could remain from the suspect's work earlier in the day. This illustrates the importance of collecting evidence from the crime scene, even if it is not yet clear whether or not it will be probative.

Perhaps most important, a thorough suspect examination demonstrates diligence on the part of law enforcement and establishes a critical focus on the suspect – both of which are critical for juries considering the evidence.

One of the most important reasons for conducting a suspect examination, however, *is to document evidence of force, resistance, and injury*. Any time a victim describes a great deal of force during the sexual assault – or when victims state that they bit, kicked, or scratched the suspect – injuries to the suspect might still be identified and documented for days afterward.

Using a Specialized Forensic Examiner

This discussion is intended to “make the case” for obtaining a forensic examination of the suspect in a sexual assault case, whenever this is warranted based on the assault history and timeframe. This highlights the importance of collaboration between law enforcement agencies and forensic examiner programs, to ensure the examination is conducted by a forensic examiner with specialized training and expertise.



Value of Trained Forensic Examiners

The critical importance of having specially trained forensic examiners is highlighted in many resources, including the [National Protocol for Sexual Assault Medical Forensic Examinations](#) (2013), as well as EVAWI's OnLine Training Institute (OLTI) module entitled, [Sustaining a Coordinated Community Response: Sexual Assault Response and Resource Teams \(SARRTs.\)](#)

When to Obtain a Suspect Examination

The decision to obtain a suspect examination should not be based solely on an understanding of how long trace and biological evidence might be available on the suspect's body. In the majority of sexual assault cases where consent is going to be the primary issue, any evidence that provides corroboration of the victim's account and documents force or injury is absolutely critical. At a minimum, a forensic examination should therefore be conducted with the suspect in a sexual assault case any time:

1. The suspect is arrested shortly after the sexual assault.
2. The law enforcement investigator believes that the suspect has not bathed since the sexual assault (however, keep in mind that depending on the type of assault, an exam may still be warranted even if the suspect has bathed).
3. There is reason to believe there might still be evidence of injury to the suspect.



EVAWI offers a number of resources and tools in the Training Bulletin entitled, [Forensic Exams for the Sexual Assault Suspect](#), many which are also provided in the Appendix of this training module.

For example, we offer a template for an affidavit and search warrant to obtain [a forensic examination of a suspect](#). Also available are two examples of an affidavit and search warrant to obtain [confirmation samples](#) and other potential evidence (e.g., blood, buccal swab, fingerprints, hair) from an incarcerated person following a CODIS hit. These materials will need to be adapted based on the facts of a specific case as well as the law and resources in a particular jurisdiction. It is important to consult with a local prosecutor during this process, and also to work in partnership with specially trained forensic examiners when crafting any such policies and protocols.



Buccal Swabs

Regardless of whether or not a complete forensic examination is conducted with the sexual assault suspect, it is often advisable to obtain a buccal (mouth) swab for DNA. There are a number of factors that make buccal swabs easier and more accessible than conducting a full examination.



Photo Credit: Canadian
Blood Services (flickr)

For one thing, buccal swabs can be collected by any law enforcement professional with training in how to collect and store them. They are therefore less expensive and time consuming than a blood draw, because the procedure does not require medical personnel or laboratory technicians.

Buccal swabs are also less intrusive than a blood draw, so suspects frequently consent to providing them in the field – rather than being transported to a medical facility or police department. As a result, officers and investigators are advised to carry buccal swabs with them at all times. However, it is also critical that the identity of the suspect is confirmed at the time a reference standard is collected, because suspects may try to have another party provide a sample in lieu of their own.



Instructions on [how to obtain a buccal \(mouth\) swab](#) are provided in the Appendix of this module

Evaluating Evidence and Prioritizing Analysis

While we have described a number of different types of biological evidence, they can be grouped into three general categories. The first is most intimate and involves the collection of evidence from the body of a victim or suspect. This evidence includes vaginal, oral, and anal swabs and other biological samples collected from the body surfaces of either party during a forensic examination.

The second layer of intimacy includes clothing that the victim may have been wearing. This is typically the underwear, pants, shirt, or jacket that the victim was wearing at the time of the assault – or the clothing put on immediately following the assault. It is considered the second most intimate level of evidence, because even though the victim wore it, there is no guarantee that any body fluid identified on the clothing came from the event in question. On the other hand, there is a longer timeframe for identifying and extracting biological evidence from clothing, as compared with the victim's body. In some situations, clothing will therefore be a more likely source of probative evidence even if it is less intimate.

The third level of evidence consists of bedding or other similar sources, which are the least intimate. Because bedding is very time consuming for forensic scientists to screen, it is often not a first priority for laboratory analysis. However, depending on the case facts, it can be an important option.

Hierarchy of Biological Evidence

When determining which evidence to analyze first, the main consideration should be the history of the assault. We have made this point throughout the module, and will continue to illustrate it with specific case examples.

However, if there is no specific information about the sexual assault, laboratories will generally analyze evidence from the victim's medical forensic examination first, because it is likely to be the most closely related in time to the sexual assault. Investigators must be aware of any policy their laboratory has for the analysis of evidence from a sexual assault evidentiary kit. Such policies differ, specifying that analysis might include all of the items in the kit versus a certain number (e.g., three).



Some laboratories will only examine clothing if no probative evidence has been identified from the victim's evidence kit. This is because fluids present on clothing may come from a significantly different time/event frame than the sexual assault. Then if all other efforts to examine evidence from the body and clothing of the victim have proven unfruitful will the laboratory typically analyze other types of evidence (e.g., bedding).

Analyze the Bedding?

The decision of whether to collect and then analyze bedding will be based both on the assault history as well other factors such as the likelihood that other biological material is present on the bedding and the last time the item was washed. While laundering may not completely wash away any DNA evidence, there are particular concerns regarding some items (e.g., a comforter from a hotel or dorm room). Such items would typically be a lower priority item to analyze than bedsheets in a case where the victim had not been sexually active for some time and the sheets had been recently washed. The comforter from a hotel or dorm room might not have not been washed in some time, and it might have a variety of biological evidence on it that is unrelated to the case.

Evaluating Evidence: An Evolving Situation

Given the large number of sexual assault victims who are unable to provide a clear or coherent account of their sexual assault, and the often complex scenarios these cases present, both investigators and laboratory personnel need to take an evolving view of each case. To illustrate, the laboratory may initially choose to evaluate the evidence from the victim's evidentiary kit, but information revealed during the course of the investigation may shift the focus to a shirt that the victim was wearing. Alternatively, the results from analyzing one source of evidence may prove to be negative, which creates a need to evaluate other sources for potential analysis.

Another possibility is that a longer period of time may have elapsed before the victim's examination than was originally believed. Or no examination may have been conducted at

all, either because of the time elapsed since the sexual assault or for other reasons. It is always important to keep in mind that most sexual assaults do not result in a medical forensic examination being conducted with the victim.

In these scenarios, the focus may shift to the victim's clothing or other evidence (e.g., condoms, bedding). Similar scenarios can be imagined where samples collected from a carpet or car upholstery may take precedence in a particular case.

In other words, investigators should provide as much information as possible to the laboratory, because this serves as a starting point for the analysis. However, the analytical process will then frequently evolve based on the results of laboratory findings as well as additional information and other evidence uncovered during the course of the investigation. Anecdotal case histories can be used to teach investigators and laboratory personnel to be flexible about the possible directions a sexual assault case might take, as probative evidence is sought to either incriminate or exclude a suspect.

Was the Victim Coherent During the Sexual Assault?

As part of this ongoing process of evaluating evidence, there are a number of critical questions investigators should address. For example, one critical question is whether or not the victim is able to provide a coherent account of the sexual assault. This includes how many perpetrators might have been involved, what acts took place, and where biological material might be found.

Unfortunately, many sexual assaults involve victims who are severely incapacitated by alcohol or other drugs, or who have little or no recollection for some other reason. In these scenarios, investigators and criminalists cannot make any assumptions about the events that took place. It is therefore especially critical for officers and forensic examiners to collect any evidence that might potentially be probative.

To illustrate, if the victim does not know whether one or more perpetrators were involved, the laboratory will need to test all probative biological evidence. This may be the only way to make as many identifications as possible. Yet the approach is different when the victim makes a statement that a single perpetrator was involved, in which case the laboratory analysis might be limited to testing a single probative item or stain.

What is the Timeframe for the Sexual Assault and the Examination?

It is important to establish the timeframe between the sexual assault and the victim's medical forensic examination, because there is a continual loss of biological fluids following the sexual assault. This is why many jurisdictions have timeframes for when they will conduct a medical forensic examination of the victim – usually in the range of 72-120 hours following the sexual assault. Many communities now use 120 hours (five days) as a guideline, which was the recommendation for best practice in the 2013 edition of the [National Protocol for Sexual Assault Medical Forensic Examinations](#). With all the advances in DNA analysis, however, some states are now moving toward a guideline of seven days (168 hours), in response to the emerging research. In Illinois, for example, the seven-day

guideline was established in [statewide regulations](#) designed to guide implementation of the Sexual Assault Survivors Emergency Treatment Act. A seven-day guideline is also currently being used in several cities in California.

While any decision regarding whether or not to collect evidence must be made on the basis of unique case facts, it is generally true that the longer the timeframe between the sexual assault and the medical forensic exam, the less likely the examination will yield probative findings (e.g., Gingras et al., 2009). At this point, the victim's clothing (e.g., underwear) may prove to be more a more probative source of evidence. However, we have already cited a study that recovered foreign DNA from vaginal swabs as many as 10 days following sexual intercourse (Speck & Ballantyne, 2015). As DNA technology continues to advance, this timeline may therefore extend beyond the current framework of 72-120, or even 168 hours.

What is the Timeframe for Any Prior Consensual Sex?

When victims have had consensual sex within a matter of days before a sexual assault, there is a chance that any biological material identified could be the result of the consensual sex act and not the sexual assault. This is also true if the victim engaged in consensual sex after the assault, but before the medical forensic examination. Victims should therefore be asked whether they had consensual sex within a matter of days – and the reason for this question must be explained, so they understand that the purpose is to exclude any consensual partner from the investigation and not to undermine the victim's credibility. This question will typically be asked by the forensic examiner, when a medical forensic examination is conducted with the victim, but it is also frequently asked or at least confirmed by the law enforcement investigator as well.

The closer the consensual sex is to the timeframe of the assault (and thus the medical forensic examination), the more likely it is to play an important role in the laboratory analysis of the case. This means the laboratory may have to analyze and extract multiple sources of biological material identified from the evidence. It is therefore important to obtain reference standards from any consensual sexual partner *as early as possible* during the investigation, so their DNA profile can be excluded. Depending on the nature of the relationship and any changes over time, a consensual partner might be less inclined to provide a reference standard at a later point.

If consensual sex occurred more than a few days before the medical forensic examination, there is less reason for the laboratory to be concerned about biological material from the consensual act still being present at the time of assault. However, given that biological evidence may remain available far longer than previously believed, this will affect the timelines for recovering evidence of consensual sex as well as the sexual assault. Common sense suggests that any cutoff used for recovering biological evidence from the sexual assault should be considered the same for consensual sex.

Did the Victim Urinate, Defecate, Bathe, Brush Teeth, or Shower after the Sexual Assault?

It is not uncommon for victims of sexual assault to thoroughly bathe or shower after being sexually assaulted. While research suggests that evidence is less likely to be submitted for analysis by law enforcement in this scenario (Patterson & Campbell, 2012), biological evidence can be recovered from some victims even after showering or bathing. We have already noted that one research study found DNA profiles from saliva evidence on the skin even after showering (Williams et al., 2015). This highlights the importance of encouraging victims to have a medical forensic examination even if they have showered, bathed, douched, etc.

Nonetheless, such activities may alter which evidence the investigator and laboratory view as the most likely to be probative. For example, if a female victim reports that the suspect orally copulated her, licked her breasts and neck, but she showered afterward, the showering may or may not have destroyed the saliva evidence from the victim's body. However, it may still be intact on her underwear or bra, which may be seen as the most significant source of biological evidence given these particular circumstances.

Similarly, if a male victim reports that he was forced to orally copulate the suspect, and he brushes his teeth afterward, this is likely to eliminate evidence from the victim's mouth. However, semen may be present on the victim's shirt because fluid may have dripped on the shirt after the suspect withdrew his penis from the victim's mouth, or the victim may have spit out the suspect's ejaculate after the assault. The fluid could also be found on the suspect's clothing. In either scenario, the shirt is now likely to be the most probative evidence. Even if the shirt has been washed, it still might be possible to identify probative evidence and should be collected.

What Clothing was the Victim Wearing at the Time of, and After the Sexual Assault?

In general, the most probative clothing evidence will be whatever the victim wore during as well as immediately after the assault. This conclusion is supported by research as well as practical experience. For example, one study with child victims (over 10 years old), found that 40% of the cases with DNA evidence had been obtained from the victim's clothing rather than body (Thackeray, Hornor, Benzinger & Scribano, 2011). In another study of 165 patients who had a medical forensic examination, 37% had a bra considered "relevant" to the case by the forensic examiner (Bennett, 2015).



Example: Riverside County, California

As an excellent example of problem solving by a Sexual Assault Response and Resource Team (SARRT), the Riverside County Sexual Assault Multi-Disciplinary Team (MDT) conducted a community drive to collect bras for patients who have a sexual assault medical forensic examination and are asked to give up their bra as evidence. The program was reportedly extremely successful and can serve as a model for other communities. For more information, see the article by Bennett (2015) in the references.

Yet the clothing worn during or after an assault may not be what the victim wears to the medical forensic examination. Too often, investigators are unsure of what specific clothing was worn during or immediately after the assault, or where this critical evidence might be located. Investigators should therefore work with victims to identify this clothing and take steps to collect it as soon as possible. It is also important to determine whether the victim left any items of clothing at the suspect's home, or other location where the assault took place. Depending on the circumstances, law enforcement may need to obtain a warrant to locate and seize such clothing or other evidence.

Even if clothing was removed during the course of the sexual assault, it might still contain preejaculate fluids, saliva, or trace evidence (even touch DNA). Clothing might also have been used to clean up after the assault (e.g., wiping the genitals). Clearly, impounding everything in the victim's dirty clothes hamper will never be a substitute for proper investigation and evidence collection procedures, including an effort to identify the clothing that is most likely to yield probative evidence based on the assault history.

It is important to keep in mind, however, that victims may be reluctant to relinquish some or all of their clothing. Some items are expensive, while others are particularly special or valuable to victims and cannot be easily replaced. In one study, for example, only 38 of 61 patients consented to giving their bra to the forensic examiner. The remaining patients declined to provide their bra, often because it was their only one and they were not sure when they would be able to replace it (Bennett, 2015).

Certain items of clothing are also unlikely to have significant evidentiary value, so there is little to be gained and much to be lost by impounding them. For example, a winter coat or pair of shoes will not typically be worn during a sexual assault. As a result, they will not have come into direct contact with the genital structures or other relevant body parts. Similarly, any clothing that was removed by the victim prior to the assault, and never put back on, will not likely have probative value. It could therefore represent a waste of valuable resources to ask the laboratory to analyze it.

The bottom line is this: Investigators and forensic examiners can work with victims to balance the two objectives of (1) maximizing evidence collection while (2) minimizing the degree of grief and loss experienced by the victim.

Were any Protective Measures Taken During the Sexual Assault?

Another critical question is whether measures were taken by the suspect or victim to protect against pregnancy as well as sexually transmitted diseases – or simply to avoid leaving any biological evidence. For example, if a condom was used by the suspect, the likelihood of probative evidence being found on an internal vaginal swab is minimal. If semen is found in or on the body of the victim, an investigator may be dealing with evidence that originated from an unrelated consensual act.

However, investigators need to treat a victim's statements about condom use with caution, because many victims are unable to accurately provide this information. This is true for a number of reasons, including the traumatic nature of the assault as well as the victim's level

of prior sexual experience (e.g., young victims who have not been sexually active or have limited experiences with sexual activity). Victims may not know whether a condom was used, and even if one was used, they may not know whether or not it remained intact. The information a victim provides should therefore be documented and considered as part of the investigation, but evidence collection and analysis should address the possibility that it might not be entirely accurate.

Did the Suspect Ejaculate During the Sexual Assault?

Because the majority of sexual assaults involve a male perpetrator – regardless of whether the victim is female or male – another important consideration is whether ejaculation occurred, and if so, where.

As with condom use, however, the victim's statement regarding ejaculation should be treated with caution. If the victim states that the suspect ejaculated, this information should be documented, because it can decrease the time it takes for the laboratory to locate probative evidence. For example, a female victim might report that the perpetrator penetrated her vagina with his penis, but he then "pulled out" and ejaculated on her blouse. In this particular scenario, the laboratory would focus on the blouse first. However, evidence collection and analysis should also take into account the possibility that the information provided by the victim in this area might not be entirely accurate.

Did the Suspect Ejaculate During the Sexual Assault?

Because the majority of sexual assaults involve a male perpetrator – regardless of whether the victim is female or male – another important consideration is whether ejaculation occurred, and if so, where. As with condom use, however, the victim's statement regarding ejaculation should be treated with caution. If the victim states that the suspect ejaculated, this information should be documented, because it can decrease the time it takes for the laboratory to locate probative evidence. For example, a female victim might report that the perpetrator penetrated her vagina with his penis, but he then "pulled out" and ejaculated on her blouse. In this particular scenario, the laboratory would focus on the blouse first. However, evidence collection and analysis should also take into account the possibility that the information provided by the victim in this area might not be entirely accurate.

Submitting a DNA Request to the Laboratory

Once evidence has been collected during the course of a sexual assault investigation, it will need to be evaluated to determine whether it will be submitted to the laboratory for analysis. Yet challenges can arise if there is poor communication between law enforcement investigators and laboratory personnel. For example, investigators might not understand why the laboratory makes certain choices about evidence examination. At the same time, laboratory personnel often get frustrated with requests from detectives that are incomplete or inaccurate, as well as requests for everything to be analyzed without prioritizing the analysis on a critical evaluation of case facts. Fortunately, with proper training, clear expectations, and proper documentation, these issues are easily resolved.



Two Sample Laboratory Service Request Forms

Two versions of a Laboratory Service Request Form have been created by the San Diego Police Department and are available in the Appendix of this module. One is an [Excel spreadsheet](#) and the other is in [Word format](#). The forms can be used to streamline and improve communication between law enforcement investigators and laboratory personnel. The [Excel spreadsheet](#) is the version of the Laboratory Service Request Form currently in use, which asks investigators to write a brief narrative of the assault history, so criminalists can prioritize the items to be analyzed and identify the locations on those items where probative evidence is most likely to be found.

The [Word version of the form](#) requires investigators to review the case history themselves and fill out the form to communicate with criminalists the order of priority for items to be analyzed and the locations on those items where probative evidence is most likely to be found. Both versions have advantages and can be easily adapted for use in other communities.

Required Information

While there might be differences across agencies and communities, Laboratory Service Requests submitted by law enforcement should have enough commonalities that the required information can be divided into a number of basic categories.

To begin, any Laboratory Service Request should include basic information in a heading. This includes information regarding the:

- Victim
- Suspect
- Case number
- Criminal offense(s)
- Date of crime occurrence
- Unit handling the case
- Investigator assigned to the case
- Investigator's phone number, email, and mail station
- Date of the request

This type of information is critical for two reasons. First, it is needed for laboratory personnel to generate an accurate report. It also helps to contact the investigator assigned to the case, if the laboratory needs additional information.



Case History

The most critical portion of any Laboratory Service Request is the case history. In this section, investigators communicate what the most significant aspects of the sexual assault are in terms of evidence collection and analysis. The following information should be provided to laboratory personnel, if it is available:

- Whether force was used to commit the sexual assault
- Whether the victim was incapacitated during the sexual assault
- What sexual acts were committed
- Whether one or more suspects might be involved
- Whether consent or identity is the issue
- Whether a condom is believed to have been used
- Whether the victim described ejaculation, and if so where
- Whether a forensic examination was conducted with the victim and/or suspect(s)
- Whether the victim showered, bathed, or douched after the assault



The [Sexual Assault Case History and Analysis Form](#) (provided in the Appendix) can be adapted by law enforcement agencies to help investigators evaluate a specific case history and the evidentiary items collected, to determine which laboratory analyses are most likely to be probative and therefore most likely to advance the investigation.

Investigators can augment this case history by providing a copy of the crime scene report, which might include photographs and crime scene diagrams. It is also important to include any reports by health care providers who conducted a forensic examination of either the victim or suspect(s). Other information should be provided specifically about the evidence, including:

- What evidence was collected, and from where
- Who else might have had contact with the evidence
- What environmental conditions the evidence might have been exposed to (e.g., sitting in the sun for a period of time)
- Which specific clothing items collected from the victim were worn during and/or immediately after the assault
- Whether the evidence (e.g., clothing, bedding) was washed or cleaned after the assault



- Whether the victim had consensual sex within a matter of days, and if a reference standard has been obtained from the consensual partner
- Whether reference standards have been collected from the suspect

To encourage the type of analytic thinking needed to compile an effective case history, a standardized form can be useful. Such a tool can help investigators carefully review the assault history and determine which items are most likely to yield probative evidence – and identify the specific location on each item where it is likely to be found.

Number of Items for Analysis

There is one important difference between the two versions of the Laboratory Service Request Form provided in this module: the number of items listed for analysis. The version currently used by the San Diego Police Department does not limit the number of items that can be listed. However, for many years the Sex Crimes Unit included space to list up to five specific items of evidence. They were to be prioritized in terms of:

1. Where DNA evidence is most likely to be found, and
2. What the potential impact on the case would be (if DNA was found).

The older version of the form also requires investigators to choose a specific description for each item (such as “victim’s underwear” or “vaginal swab”) rather than providing a vague or general description (e.g., “victim’s clothing,” or “rape kit”). Although it includes space to list up to five items of evidence to be evaluated by the laboratory, Sex Crimes detectives working in the San Diego Police Department typically only requested two or three items of evidence to be evaluated by the laboratory.⁴⁷

This is very different from the typical request that was historically made by detectives in agencies across the country, asking the laboratory to: “Analyze all evidence for trace and semen.” Neither detectives nor their supervisors often understood the process set in motion as a result of such an overgeneralized – and therefore meaningless – request.

With an assessment of the case history, it often quickly becomes clear which specific analyses of what items are most likely to advance the case. It also helps to take into account other factors that might influence the interpretation of test results.

⁴⁷ Some laboratories are establishing policies limiting the number of analyses that can be requested per case, typically between five and ten. This is done in an effort to use the limited resources available most efficiently, by identifying items that will most likely yield probative evidence. If probative evidence is not located on the first set of items, additional analyses can be requested. In North Carolina, for example, the State Crime Laboratory issued new [Evidence Submission Guidelines](#) effective October 15, 2018. For sexual assault cases, the first submission is restricted to: (1) the sexual assault evidence kit, (2) one pair of underwear (if not in the kit), and (3) a condom if applicable. Subsequent submissions can then include up to three items of clothing and/or bed linens. See Kovner, 2012 in the Forensic Resources Blog (2013, September 9), entitled [New State Crime Laboratory Limits on Items of Evidence to be Tested](#), North Carolina Office of Indigent Defense Services.

Documentation of Clothing Evidence

Another tool that can greatly improve communication between law enforcement agencies, forensic examiners, and laboratory personnel is a Clothing Documentation Form. This form should be used to document answers to the following questions:



- What clothing was the victim wearing prior to and during the assault?
- Was clothing used to wipe the genitals following a sex act?
- What clothing did the victim put on after the assault?



The critical importance of clothing is often overlooked, so a Clothing Documentation Form has been developed for [law enforcement investigators and forensic examiners](#) to evaluate the significance of such evidence. The form is provided as a [Word document](#) so it can be easily adapted.

Most officers are not taught to identify specific items of clothing separately in their documentation. However, it is critical for the criminalist screening a large amount of evidence to know the relevance of the items they are analyzing, what they are looking for and where (specifically) they are most likely to find it. There should also be space on the Clothing Documentation Form to record observations by the law enforcement investigator, forensic examiner, and even the victim, regarding any visible signs of foreign material as well as the general condition of the item (e.g., whether there are any tears, stretched out material, missing buttons, wet stains). When items of clothing have such signs of wear and tear, all items should be photographed and documented with the Clothing Documentation Form.

Reference Standard from the Suspect

Along with the request for laboratory services, investigators should submit reference standards from the suspect(s) whenever possible. Many investigators question whether this is necessary if the suspect's identity is known, but as previously discussed, there are a variety of reasons for collecting a suspect's reference standard beyond simply establishing or confirming identity. At some point, the suspect's profile might need to be compared with evidence collected during the investigation, to confirm the match. In addition, the profile can be searched within the local and possibly state databases, to reveal any prior arrests, convictions, or connections with other cases based on evidence. If the investigator submits the suspect's reference standard during the course of the investigation, the results might be returned in time to assist in the investigation. This is especially true in jurisdictions where the analysis is conducted by a local laboratory, because testing can generally be conducted more quickly than a state laboratory might be able to.

Some investigators also question whether reference standards are needed if the suspect is already in CODIS for a prior offense (i.e., in the Arrestee Index or Convicted Offender Index). Again, the answer is yes. By analyzing the suspect's DNA on a local level, it can be



compared with evidence collected in the case and compared with other offender profiles and forensic unknowns on a local, and possibly a state level. However, there are other reasons as well. If the profile is uploaded to CODIS and there is a hit within SDIS or NDIS, the match will need to be confirmed at the local level, so a local scientist can testify in the case.

Some laboratories will not analyze evidence in a case where the suspect is known, if no reference sample has been collected from that suspect. Investigators should discuss this issue with their laboratory, to determine what their current policy is and to develop a protocol for addressing it. Laboratories may also need to be flexible, because the attempt to collect a reference sample from a suspect prior to arrest may result in the suspect fleeing the jurisdiction. This is a particular concern for authorities working in border communities, where it is easy for a suspect to flee into Mexico or Canada.

Requests Must Be Complete

In sum, laboratories cannot efficiently proceed with testing until they have all the evidence and information needed for the analysis. This includes information concerning the forensic evidence and clothing collected from the victim, forensic evidence and clothing collected from the suspect(s), any consensual sex within a matter of days of the victims' examination, and details regarding the necessary reference samples (from the suspect as well as any consensual partners if possible). Incomplete requests – for example, those lacking all required reference samples – will often result in significant delays in the laboratory analysis of evidence.

Reporting DNA Results and Complicated Statistics

Once the laboratory has completed their analysis of the evidence, a report will be sent to the law enforcement agency that submitted the request.



To provide a sense of the information typically included in a laboratory report, and what can be concluded on its basis, two sample reports are provided in the Appendix. One report communicates the [results of analysis conducted to screen biological evidence](#) and the other reports the [results of DNA typing](#).

While there is significant variation among the format of laboratory reports, they typically include information in the following categories, which are dictated by Quality Assurance Standards set forth by the FBI for accredited laboratories.

Report Header

In the header section of the laboratory report, basic information will typically be provided pertaining to the victim, suspect(s), case number, offense(s), the investigating unit, and the name of the investigator assigned to the case.

Evidence Analyzed

This section will typically follow a summary of the sexual assault evidence analyzed.

Analytical Procedures

Next is a summary of the specific techniques used to conduct testing in the case.

Test Results

Finally, the DNA findings are often displayed in the form of a complex table. As genetic analysis systems become ever more complex, there is a trend among laboratories for this information to be included in the laboratory's analytical file and not in the report. This is because investigators and prosecutors will typically need assistance from the forensic scientist to understand and interpret the information.

Conclusions

The final section is likely to be the most critical, because it summarizes the conclusions. This typically includes:

- Whether a DNA profile was obtained
- Whether the profile is from a single individual or a mix of two or more individuals
- Whether the victim is a possible contributor to the DNA typing result
- Whether a suspect is a possible contributor to the DNA typing result

If the suspect is identified as a possible contributor to a sample, the conclusion will state the statistical likelihood that a randomly selected individual would also be included as a possible contributor. If no suspect is identified, however, the conclusion will specify whether there was sufficient DNA information to submit a profile into CODIS.

Law enforcement investigators often focus on the conclusions in a DNA laboratory report, but the other information can also be extremely significant, depending on the audience. For example, a defense attorney or expert may find some of the other information to be critically important.



Resource: Expert Interview

In this [video](#) interview, Dr. Marc LeBeau summarizes what law enforcement investigators should understand about laboratory reports.

Interpreting Conclusions

In a sexual assault case with a known reference standard from the suspect, there are two key elements to a report's conclusions. The first is whether the laboratory was able to include or exclude the suspect as a contributor to a probative piece of evidence. Most investigators have little problem comprehending this type of conclusion. A more difficult concept to grasp is the statistical calculation associated with the conclusion.

To understand this calculation, it is important to recognize that the level of association between an individual person and a piece of evidence only gathers meaning based on how distinctive that evidence is. Genetic information is no different. It is the number of markers – with their associated statistical likelihoods – that makes it possible to match a sample of unknown origin with a specific individual, to a high degree of certainty.

For example, imagine that 20% of the population has blue eyes, and the suspect also has blue eyes. Is this strong evidence that the suspect committed the crime? The answer of course is no. However, imagine that the suspect has blue eyes (20% of the population), is described as 6'4" (3% of the population), weighs 300 pounds (2% of the population) and drives a Corvette (1% of the population). With that information, there is much less chance that a randomly selected individual will match this suspect profile.

Yet certain factors reduce the level of certainty associated with a statistical association. For example, incomplete DNA profiles are sometimes obtained from an evidence sample, as are *mixtures from multiple contributors*. The statistical result thus offers a means of expressing how significant the association is, and law enforcement



investigators can discuss the meaning of this statistical association with laboratory personnel. Some courts allow forensic scientists to provide expert testimony about what the statistical value means in terms of uniqueness. However, ultimately it is the reader of the report – and eventually, the jury – who is left to interpret what the statistical value means in terms of distinctiveness.

Communicating Difficult Laboratory Findings for Prosecution

In some cases, laboratory results can be extremely complicated to explain. As a result, investigators are sometimes intimidated by the prospect of trying to communicate the significance of the findings to the prosecutor's office. Yet one function of a forensic scientist is to ensure that testing conducted in the laboratory is understood both by the investigator assigned to the case as well as the prosecutor and defense counsel. Thus, investigators should discuss their case with the criminalist, either in person or over the phone during the early stages of an investigation. They may also need to utilize the criminalist's expertise at later stages as well.

Investigators may even want to invite the criminalist to assist in the presentation of the findings to the prosecutor. This is especially true in complicated cases with DNA results that are difficult to interpret, because there can be a significant risk that a non-scientist may inadvertently communicate an erroneous interpretation. Forensic scientists can be utilized by investigators as a valuable resource in these situations.

Evidence Consumption and Small Samples

Before we move on to explore larger policy issues, a final topic worth addressing is the laboratory consumption of evidence samples during DNA testing. This is particularly important because the issue has evolved over time, and it can play a critical role in the investigation and potential prosecution of a sexual assault case.

As previously noted, PCR technology consumes a smaller amount of an evidence sample during testing than RFLP testing. However, this does not mean that PCR completely eliminates the need to consume evidence in the hopes of obtaining a DNA result. It has simply placed DNA laboratories in a position to routinely type small samples – for example, when victims delay reporting, shower, or wash their clothing following the sexual assault. Each of these scenarios can create small forensic samples that challenge the sensitivity of PCR tests, and they may even consume the entire sample for the analysis. New analytic methods, often characterized as touch DNA, allow the testing of very small samples, such as skin cells left on an object after it has been touched or handled (for example, on a gun, tool, or flashlight). Yet such analyses often work from the premise that the entire biological sample will be consumed in the process.

General Guidelines on Evidence Consumption

While evidence consumption guidelines vary across laboratories and jurisdictions, some general guidance can be offered whenever there is limited biological material to test.

In cases where no suspect exists and DNA testing is needed to generate a lead, investigators and criminalists will generally be more willing to consume limited samples, in the hope of obtaining a profile to identify a suspect. The criminalist may communicate this intention via phone or email to the investigator who submitted the Laboratory Service Request. Before the sample is consumed, however, the investigator should review all of the available evidence. Consideration must be given to the possibility that other items could yield DNA results before committing to consuming any sample in its entirety.

In other cases where a suspect has been identified and charged with a crime, evidence consumption can be a more complicated issue. In essence, the prosecutor takes responsibility for the evidence being intact and available, which includes the defense attorney's right to testing at an independent laboratory. In cases where a defendant has been charged, permission via email or court order is often needed for a laboratory to proceed with testing that may consume an entire sample.

Responding to Defense Objections

On some occasions, the defense may object to consumption of the sample and demand their own test. In this situation, three outcomes are possible.

First, the court may listen to arguments made by the prosecution and defense, and order that the very limited sample be split, so two tests can be conducted. However, this may result in each of the laboratories ending up with an insufficient sample to complete the test. This is particularly unfortunate, because success may have been achieved if the sample had remained intact for a single test. Fortunately this scenario is quite rare.

A second scenario is seen when the prosecution and defense engage in discussions and decide to allow the government laboratory to proceed with a single test that will consume the entire sample. In some jurisdictions, an expert for the defense can be present when the laboratory conducts the test. However, the presence of a defense expert can be disruptive, particularly when DNA laboratories have hundreds of cases in progress at any given time.

A third possibility is for the prosecution and defense to come to an agreement that the limited evidence will be sent to an independent laboratory chosen by both parties – with the understanding that the results will be shared with both parties. However, even when this option is pursued, the government laboratory may still be utilized, because not all private laboratories are accredited or have proven track records with sophisticated DNA analysis. In addition, the local laboratory will need to take ownership of the profile and become the portal for CODIS entry, because private laboratories are forbidden by law from directly entering data into CODIS.

With this, we conclude our discussion of the purposes and practices of DNA. In the next section, we focus recommendations for policies and practices in this area. However, we will first provide you with a series of case examples, offering an opportunity to apply what you have learned so far. The scenarios are based on real case facts, although they have been adapted somewhat for this purpose.

Practical Application: Case Examples

For each of the case examples, we offer a synopsis with basic information, followed by more detailed information regarding the investigative steps taken and the evidence and information gathered. We also provide supplementary materials, such as the following:

- SANE report from the victim's medical forensic examination
- Report from the suspect's forensic examination
- Clothing Documentation Form
- Sexual Assault Case History and Analysis Form
- Laboratory Service Request
- Request for toxicology analysis

Based on this information and evidence, you will conduct an assessment of the case from the perspective of a law enforcement investigator. You will also answer a series of questions to help evaluate the assault history and other case facts, and ultimately make determinations regarding which evidence is most likely to be probative. Eventually we will ask you to complete a Sexual Assault Case History and Analysis and a Laboratory Service Request.

In this document, we do not provide answers to these questions or any of the supplementary materials. They are only available in the online version of this module in the [OnLine Training Institute](#). Because the process of working through these case examples is so beneficial for applying the training content to real-world scenarios, we encourage you to register for this OLT module. Then you can work through the case examples and other interactive exercises.

As you work through the case examples, you will notice that they build on each other, so you can apply what is learned in scenarios that gradually increase in complexity.

Case Information for Scenario #1: Forcible Rape of 16 Year Old by 28 Year Old Soccer Coach

Synopsis

The victim, a 16 year-old girl named Jackie Thomas, told her parents she was sexually assaulted Friday night at approximately 2100 hours by a 28-year old man she knows as Jim. Jim lives in the neighborhood and he coaches soccer. Thomas said at first they were just talking and watching a movie but then the suspect sexually assaulted her on his living room couch. Thomas said she told the suspect to stop but he didn't. The suspect told Thomas not to tell anyone or she would get in trouble. The victim said she had never been to the suspect's home before but he invited her over to talk about how she could improve her soccer game.

Thomas believes Jim is married but no one else was home at the time of the sexual assault. She said Jim had never been inappropriate before and she had never been sexually active with anyone. Thomas had trouble sleeping and eating following the sexual assault so she decided to tell her parents late Tuesday morning. The victim's parents called the police at 1430 hours.

Communications dispatched Officer Davis to meet the victim and her parents at their home to evaluate a report of rape. With the victim and her parents' consent, Officer Davis interviewed the victim in private to obtain a preliminary statement. The victim described how the suspect forced his penis into her vagina after she told him to stop. The victim believes the suspect ejaculated and she thought he might have used a condom.

When the victim returned home later that night, she immediately showered "for a very long time" before putting on her sweats and going to bed. She also showered at least three more times before talking to her parents.

After concluding the preliminary interview, Officer Davis facilitated a medical forensic examination at Eisenhower Valley Institute.

Medical Forensic Examination of the Victim

Officer Davis, the victim and her parents arrived at the medical facility at 1530 hours. The officer briefed the SANE with the information he obtained during the preliminary interview (the synopsis above).

As the SANE began the examination, she collected the underwear the victim was wearing. Then, following standard protocol, the SANE collected a variety of swabs from in and on the victim's body. This included both external genital and internal vaginal and cervical swabs.

The SANE also collected swabs from inside the victim's mouth as well as the external area around the victim's mouth. These external swabs can often recover more foreign biological material from the skin surrounding the mouth than the oral swabs taken from inside the mouth. When swabbing the area around the victim's mouth, however, the lips are not swabbed. This is because they will produce too much of the victim's DNA, which could potentially mask the smaller quantity of foreign DNA that might be recovered.

Fingernail scrapings/swabbings were also collected from the victim, as well as body surface swabs of the victim's neck, breasts, and thighs. Particular care was taken to swab the area of the victim's left upper chest where a suck mark was documented. Blood and urine samples were also collected, in case toxicology testing is needed at a later time depending on the course of the investigation.

Examination Findings

The SANE stated that the visible findings were consistent with the victim's history that she had not been sexually active as well as the time frame she described. These findings included the following:

1. Laceration from 5-6 o'clock on the Posterior Fourchette, positive dye uptake, with complaint of soreness at that location. Pulls away when touched here.
2. Abrasion at 5-7 o'clock on the Fossa Navicularis, with positive dye uptake, complains of soreness when touched here.
3. Purple/blue bruise at 9 o'clock on the Hymen. Hymen is swollen.
4. Purple/blue bruise/suck mark on left upper chest.

As indicated in the picture, the Posterior Fourchette, Fossa Navicularis, and Hymen are all external genital structures. Positive dye uptake is consistent with an injury after Toluidine blue dye is applied to the area of the suspected injury.

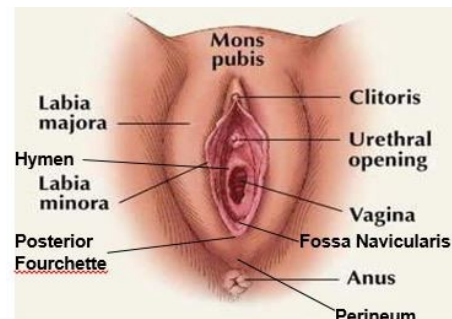

SANE Report

The [SANE Report for Case Example #1](#) demonstrates how a SANE might document the findings from a medical forensic examination with this victim, including observable physical findings, statements made by the patient, and the examiner's conclusions.

Post-Examination Briefing

Following the examination, the SANE briefed the officer, comparing what the officer told her prior to the examination and what she learned during the examination. The SANE said the victim told her that the suspect was drinking beer when she arrived and he offered her a beer, which she took. The victim said she didn't even finish the whole beer. She did not feel intoxicated or incapacitated in any way. She said she hadn't mentioned the beer to her parents or Officer Davis because she didn't think it was a big deal.

The SANE advised Officer Davis that the clothing the victim was wearing at the time of the sexual assault was still in her laundry basket in her bedroom. Also in the laundry basket was a pair of sweat pants the victim put on immediately after showering (no underwear).

The victim said she wasn't sure if the suspect wore a condom during the sexual assault, but she heard what she thought was a wrapper being opened. She never actually saw a condom, new or used, at any time. The victim said that she used a Kleenex to clean herself afterwards because she was bleeding. She said she discarded the Kleenex in the suspect's bathroom waste basket.

Next Investigative Steps

Following the SANE exam, the responding Officer called to consult with the Sex Crimes duty detective. Detective Hershman and Officer Davis spoke about the next steps to be taken.



Please describe 3 investigative steps the officer and detective should consider taking immediately, based on the information gathered so far in this case.

- 1.
- 2.
- 3.

Collecting Victim Clothing

Hopefully you mentioned one critical step for the reporting officer, which is to return with the victim to her home and obtain the critical clothing items from her laundry basket. This is exactly what the reporting officer did in this case example. He then impounded each item of clothing in a separate paper bag, clearly indicating the items that were worn at the time of the assault (and put back on immediately after the sexual assault to wear home) – versus the sweat pants and t-shirt the victim put on after showering.

This example highlights the importance of communication between the forensic examiner, the reporting officer, and any responding detectives. Victims often wear clothing to the examination that is not likely to yield probative biological material – for example, if they changed clothing several times since the sexual assault. Therefore, it is important to find out whether any clothing or other crime scene evidence needs to be collected from other locations. When asked, the victim might indicate that the clothing worn at the time of the assault is now on a bedroom floor, in a laundry basket, etc. Victims also frequently dress quickly after being sexually assaulted, and perhaps leave an item of clothing (or other item) at the location of the sexual assault. These items are important to collect, both for potential biological evidence but also to place the victim at the location.

Suspect Contact

After evaluating all of the information in this case example, the detective decided to contact the suspect, Jim Flowers, at his home as soon as possible. When he first made contact, the detective advised the suspect that he was not under arrest and that he could tell the detective to leave his home at any time. Flowers invited the detective in and agreed to talk to him. The detective then asked the suspect to tell him what happened on Friday evening.

The suspect said the victim came to his house on Friday evening, but the two did not have any sexual contact – at that time or any other time. He said he only invited her to come over because she had asked him to help her with her soccer game.

Following the suspect's statement that he did not have any sexual contact with the victim, the detective obtained a telephonic search warrant to search the suspect's home and to obtain a DNA reference standard from the suspect. This was conducted in accordance with state laws, as well as Police Department policies and procedures.

When the search warrant was executed, the investigator learned that the suspect's bathroom waste basket had been emptied and the weekly trash had already removed by the sanitation company. No condoms or condom wrappers were found.

A crime scene technician responded to assist the detective with the search warrant. The technician screened the living room couch and the surrounding carpet with an alternate light source to determine whether any of the victim's biological material could be located (e.g., epithelial cells, blood) but the results were inconclusive. As a result, the detective had the three cushions from the couch removed and impounded.

Investigator Assessment

With this information, we now offer a series of questions designed to guide your assessment of the evidence from the perspective of a law enforcement investigator.



Is the victim able to provide a narrative account of events?

No Yes Unknown

Is there a starting point for the investigation regarding the number of suspects, the identity of the suspect(s), and the specific sexual acts committed?

No Yes Unknown

Could the victim's age or the lack of sexual experience impact the victim's account?

No Yes Unknown

How much time elapsed between the sexual assault and the victim's examination?

Less than 1 day (up to 24 hours) 1-2 days (25-48 hours)
 3-5 days (49-120 hours) More than 5 days (beyond 120 hours)

Is there any indication (so far) that toxicology analysis will be needed in this case?

No Yes Unknown

Is there any indication (so far) that reference samples need to be collected from a prior consensual sexual partner?

No Yes Unknown

Requesting Laboratory Services

Based on the information provided so far, an investigator can evaluate the case facts, assault history, and available evidence, to prepare a request for laboratory services. However, the policies and procedures for laboratory analysis vary across jurisdictions.

In some jurisdictions, all the items in the evidence kit will be tested as a matter of routine practice in a sexual assault case. This may even include some key articles of clothing (e.g., underwear). However many jurisdictions fail to look at anything other than the sexual assault evidence kit (such as clothing or crime scene evidence).

On the other hand, investigators in some jurisdictions are limited to a certain number of evidentiary items for their Laboratory Service Request (often 3 or 5). In that situation, it will be critical to evaluate the information and evidence available and determine which items might be the most likely to yield probative biological evidence.



So at this point, we would like you to tell us about the situation in your jurisdiction. Are all of the items in a sexual assault evidence kit typically analyzed by the laboratory? Or does the laboratory only analyze specific items that are requested? Is clothing typically analyzed? Does the request need to be limited to a certain number of items?



Please mark all of the following that apply, to describe the situation in your jurisdiction:

- All the swabs in the evidence kit are typically analyzed.
- All the swabs in the evidence kit can be analyzed, if this is requested
- If collected, the victim's underwear is usually screened and/or tested.
- Other evidentiary items can be screened/tested, if this is requested (e.g., clothing, condoms, tissues)
- Only a certain number of evidentiary items can be submitted for analysis (e.g., 3 or 5). Please describe: _____
- If screening/testing of the first set of items does not yield findings, a second set of items can be submitted for analysis. Please describe: _____

Use the space below to describe the policy or protocol for laboratory analysis:

Prioritizing Items for Analysis

Because of the increasing demand for DNA laboratory services, it is important for law enforcement personnel to work as efficiently as possible. This can be accomplished by prioritizing laboratory requests based on all the information and evidence available in a case. This will help investigators and criminalists to determine which items are most likely to yield probative evidence, which in turn will significantly improve case outcomes.

To practice this type of decision making, we would like you to evaluate the evidence collected in this case to determine their priority for laboratory analysis. Please keep in mind that there is no single "right answer" to this task! However, we have provided the type of information you will want to consider as you make these determinations.



Please select up to 5 of the items from the following lists and rank them from highest (1) to lowest (5) order of priority. Use the space below to describe the items and their ranking. Not all items will be included in the ranking.

Victim Clothing

_____ Shirt (worn at the time of the assault)

_____ Shorts (worn at the time of the assault)

<input type="checkbox"/>	Bra (worn at the time of the assault)
<input type="checkbox"/>	Underwear (worn at the time of the assault)
<input type="checkbox"/>	Sweat pants (put on after showering)
<input type="checkbox"/>	T-shirt (put on after showering)
<input type="checkbox"/>	Underwear (worn to the examination)
Medical Forensic Examination	
<input type="checkbox"/>	External peri-oral swabs taken from around the mouth (not the lips)
<input type="checkbox"/>	Oral swabs from inside the mouth
<input type="checkbox"/>	Fingernail scrapings/swabbings
<input type="checkbox"/>	Body surface swabs (such as neck, breasts, thighs)
<input type="checkbox"/>	External genital swabs
<input type="checkbox"/>	Internal vaginal/cervical swabs
<input type="checkbox"/>	External anal swabs
<input type="checkbox"/>	Internal rectal swabs
Crime Scene Evidence	
<input type="checkbox"/>	Couch cushions

In some instances, you might group together a limited number of items (e.g., the internal vaginal and anal swabs, penile and scrotal swabs). However, we recommend that you consider each item individually, because your task is to critically evaluate and prioritize all of the available evidence in terms of its potential for probative biological evidence to advance the investigation. (For example, internal vaginal and anal swabs corroborate penetration as well as possible identification of the suspect. They might therefore be grouped together). In addition, you will need to consider each item of clothing based on the victim's statement and the medical forensic examination to help prioritize which evidence should be screened and typed by a criminalist.

Preparing a Laboratory Service Request

To see an example of how the tools provided with this module can be used to assist in this process of prioritizing evidence and preparing a request for laboratory services, we provide two sample forms prepared with the information from this case scenario:

- [Sexual Assault Case History and Analysis](#)
- [Laboratory Service Request](#)

Because tools such as these are not always used, we offer them as samples of recommended practice.

Laboratory Findings

When the investigator received the report from the laboratory, one of the results indicated that semen was found on the underwear the victim wore at the time of the sexual assault. DNA testing then matched the profile to the suspect's DNA reference standard. This result could serve a variety of purposes in terms of this investigation.



Below we provide a variety of purposes that could potentially be met with this laboratory result. Please mark the purposes that can be met, based on the information provided so far.

- Establish sexual contact
- Establish vaginal penetration
- Include suspect
- Exclude suspect
- Link local cases based on any DNA profiles developed
- Corroborate the victim's statements
- Challenge the victim's statements
- Corroborate the suspect's statements
- Corroborate the victim's statements

Testing Process

Analysis should generally proceed in a step-by-step fashion with each item prioritized based on the victim's statement, any forensic examinations of the victim and/or suspect(s), and other information developed during the course of the investigation. If the results from the first item establish the suspect's identification and the element(s) that need to be proven in a particular case, analysis might very well stop at that point.

Case Information for Scenario #2: Forcible Rape, Digital Penetration and Oral Copulation by Two Suspects

Synopsis

Cassi Jackson, the 19-year old victim, called 911 to report that she was just raped. She said she went to visit her boyfriend at around 1800 hours, but he wasn't home. Instead, two of his friends, Tyrone Crosby and Max Verduzco were there, and they invited her in to watch TV. They watched TV for a while, but then the two suspects demanded sex from the victim. When she refused, they carried her into the bedroom where they took turns raping her vaginally on top of the bed. Jackson said she believes both suspects wore a condom during the sexual assault, and she believes they both ejaculated.

Jackson estimated that the assault took place between 1930 and 2000 hours. Afterward, she said she "threw on her clothes," and went home as fast as she could. The victim called



911 around 2030 hours, and Deputy Cathy Garcia responded. Garcia conducted a preliminary interview with the victim, clothing she had on at the time of the assault.

The victim and Deputy Garcia tried to call the victim's boyfriend, Jerald Ferguson, but he didn't answer his cell phone. Jackson gave Deputy Garcia Ferguson's cell phone number and his address. Deputy Garcia then spoke to her sergeant who dispatched another Deputy to the victim's boyfriend's home but no one answered the door.

Deputy Garcia transported the victim to Eisenhower Valley Institute at 2100 hours for a medical forensic examination. Deputy Garcia briefed Diana Faugno, the Sexual Assault Nurse Examiner (SANE) with the information she had obtained so far.

Medical Forensic Examination of the Victim

Following standard protocol, the SANE collected a variety of swabs from in and on the victim's body:

- External peri-oral swabs taken from around the mouth (not the lips)
- Oral swabs from inside the mouth
- Fingernail scrapings/swabbings
- Body surface swabs (such as neck, breasts, thighs)
- External genital swabs
- Internal vaginal/cervical swabs
- External anal swabs
- Internal rectal swabs

Examination Findings

The [SANE Report for Case Example #2](#) is provided to review the examination findings. In it, Faugno summarized the following visible physical findings:

1. 4-8 o'clock on the Fossa Navicularis is reddened and abraded. There is positive dye uptake and she complains of tenderness when touched here and pulls away.
2. Hymen has a red bruise at 3 o'clock.
3. Suck mark to middle of neck.
4. Positive ALS/Woods to left groin with 5x6 cm blue/black bruise. Pulls away when touched there.
5. Redness around wrists. C/O pain there.

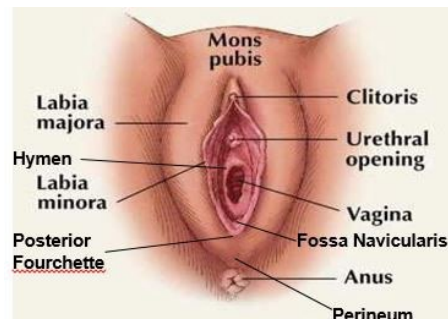

The Fossa Navicularis and Hymen are both external genital structures. Positive dye uptake is consistent with an injury to a certain area of tissue/skin that has been exposed.

The SANE also described the subjective indicators of injury or pain. When the victim was asked whether she was experiencing any anal-genital pain or injury, she responded: "I am sore down there." When asked about non-genital pain or injury, she said, "My stomach hurts." Then later when Faugno noted redness to the victim's wrists, the victim said, "It hurts there now." Faugno concluded that the examination findings were consistent with the history provided by the victim. Faugno also took a number of photographs, including the bruise on the victim's thigh.

Clothing Collected by the SANE

The SANE collected the victim's clothing that she was wearing at the time of the assault and wore to the hospital (pants, shirt, bra, and underwear). Prior to packaging the clothing, Faugno examined the clothing for signs of force (e.g., stretching, tearing, missing buttons). A [Clothing Documentation Form for Forensic Examiners](#) was used to record this information. Because this type of form is not



Photo Credit: Diana Faugno

always used, we offer it as a sample of recommended practice.

The victim also wore sandals to the examination, but these were not collected because the SANE determined (based on the assault history) that they were not likely to contain probative evidence and the victim didn't want to give them up.

Post-Examination Briefing

Following the medical forensic examination, the SANE summarized her findings and advised Deputy Garcia that in addition to penile-vaginal rape, the black male suspect identified as Tyrone also forced the victim to orally copulate his penis. The Hispanic male suspect identified as Max also forced his fingers in the victim's vagina.

Deputy Garcia asked Faugno whether the victim had any recent consensual sex, to determine whether any DNA reference standards might be needed. The SANE relayed that the victim said she and her boyfriend had sex two days before the assault, and her boyfriend did not use a condom.

Continuing Investigation

Detective Debbie Deloach, the on-call detective, responded to assist Deputy Garcia. The victim contacted her boyfriend, Jerald Ferguson, by phone and he agreed to meet with Deputy Garcia and Detective Deloach at approximately 0130 hours. Ferguson advised Deputy Garcia that Tyrone's last name is Crosby and Max's last name is Verduzco, but he wasn't sure of either individual's home address. Ferguson said he didn't understand why

his two friends would sexually assault his girlfriend. He then gave his consent to search his house.

Deputy Garcia completed a crime scene diagram and took photographs of the bedroom where the sexual assault took place. Deputy Garcia didn't see any visible signs of evidence on the bed or in the bedroom. No condoms or packaging were found. The comforter from the top of the bed where the assault occurred was collected and impounded.

After explaining the importance of a reference standard to exclude his DNA profile, the victim's boyfriend voluntarily agreed to provide Detective Deloach with a buccal swab. Detective Deloach thanked Ferguson for his cooperation and advised the victim of her next investigative steps. She explained that she would contact the victim within the next couple of days to schedule a follow-up interview, after the victim had a chance to rest.

Detective Deloach then returned to the station to conduct computer research to identify both suspects as well as their last known home addresses. Once identified, a criminal history check revealed that Max Verduzco had a number of prior drug-related arrests and Tyrone Crosby had a previous arrest for sexual assault. Detective Deloach also obtained search warrants for complete forensic examinations of both suspects.



To offer an example of what this might look like, a [sample affidavit and search warrant for a suspect examination](#) is provided.

Suspect Examinations

Later that morning, Detective Deloach, with assistance from patrol, arrested both suspects at their homes. Deloach advised both suspects of their Miranda rights. Verduzco said Cassi came to the house knowing they were there and that her boyfriend was gone because she wanted to "score some heroin." He said all three "got high" together and then they had consensual sex (a "threesome"). Verduzco said he and Tyrone both wore condoms. Crosby did not make a statement, stating that he wanted a lawyer.

The two suspects were transported in separate patrol cars to Eisenhower Valley Institute for complete forensic examinations, conducted by different SANEs. In this jurisdiction, forensic examinations are routinely conducted with sexual assault suspects who are arrested within a few days of the assault. In a scenario like this, there is a good chance a suspect examination will yield probative biological evidence.



What is the situation in your community, regarding suspect forensic exams?

FOR LAW ENFORCEMENT PERSONNEL, does your agency have a protocol in place for suspect examinations? Or, even if there is no specific policy, are you able to obtain a forensic examination of a suspect who is arrested within days of the sexual assault? If so, who collects evidence from the suspect? Is it an officer, a specialized forensic examiner, a criminalist, or a crime scene technician?



Please describe.

FOR OTHER COMMUNITY PROFESSIONALS, are you aware of the policies and practices of the law enforcement agencies in your area regarding suspect examinations? Please explain. It is worth finding out how you can support them in implementing this practice.

Unfortunately, the majority of the jurisdictions we work with have no protocols in place for conducting high-quality and thorough forensic examinations of suspects. The expectation is that this evidence will be collected by investigators, crime scene technicians, or crime laboratory personnel. In addition to concerns about whether law enforcement professionals should be conducting such an intimate examination of any individual, we recommend that suspects are examined by health care professionals with specialized training and clinical experience to obtain the best documentation and forensic evidence possible.



For more detailed discussion of these issues, please see our article and associated resources on [Forensic Exams for the Sexual Assault Suspect](#).

To understand why it is often critical to obtain a suspect examination in a sexual assault case, it is helpful to first consider the type of samples that should be collected and documented.



Please list 3-5 types of samples that should be collected and documented during the forensic examination of a sexual assault suspect:

- 1.
- 2.
- 3.
- 4.
- 5.

Now we would like you to think specifically about this scenario. How might the evidence collected and documented during the suspect examinations advance the investigation in this case example?

Suspect Statements

When he was advised of his Miranda rights by Detective Deloach, Tyrone Crosby invoked his right to remain silent. However, any spontaneous statements made to the SANE during his forensic examination should be documented on the examination form.





Did Crosby make any spontaneous statements to the SANE? If so, what were they?

Follow-Up Interview with Victim

Detective Deloach scheduled a follow-up interview with the victim two days later. During the interview, she asked the victim whether she bought any drugs from either suspect or if any of them took any drugs at the time of the assault. Deloach clarified that she was asking this because one of the suspects raised the issue, and she wanted to make sure she had all the correct information. The detective assured the victim she was not concerned about any illegal drug use on the victim's part, and she was not interested in making an arrest for any such issues. The investigator said her primary concern is investigating the sexual assault, and that it is critical that Jackson is truthful about everything that happened.

The victim said she did not take any drugs at the time of the assault; she said they were lying about her coming to the house to buy or do drugs. She said nobody even had any alcohol. She said she absolutely did not want to have sex with either suspect and became very upset in the interview. Detective Deloach asked Jackson if she wanted to take a break or talk in private with the advocate who was accompanying her, but the victim said she just wanted to finish the interview. Following the interview Detective Deloach took photographs of the evolving bruises on the victim's wrists and thigh.

Investigator Assessment

With this information, we now offer a series of questions designed to guide your assessment of the evidence from the perspective of a law enforcement investigator.



Is the victim able to provide a narrative account of events?

- No Yes Unknown

Is there a starting point for the investigation regarding the number of suspects, the identity of the suspect(s), and the specific sexual acts committed?

- No Yes Unknown

How much time elapsed between the sexual assault and the victim's examination?

- Less than 5 hours 5-24 hours (1 day)
 1-2 days (25-48 hours) 3-5 days (49-120 hours)
 More than 5 days (beyond 120 hours)

Did the SANE document any non-genital injuries to the victim's body? If so, please describe them.



Is there any indication (so far) that toxicology analysis will be needed in this case?

No Yes Unknown

Requesting Laboratory Services

Based on the information provided so far, the Detective can evaluate the case facts, assault history, and available evidence to prepare a request for laboratory services for DNA analysis. As discussed in the previous example, some jurisdictions test all the items in an evidence kit whereas others limit investigators to a certain number of items for analysis (often 3 or 5). Regardless, it is important to evaluate the information and evidence available to determine which items might be the most likely to yield probative evidence.

Once again, we would like you to evaluate the evidentiary items collected in this case to determine their priority for laboratory analysis. Remember, there is no single “right answer,” but we have provided the type of information you will want to consider as you make these determinations.

The evidentiary items have been grouped in four categories: (1) Medical forensic examination of the victim, (2) Victim clothing, (3) Tyrone Crosby’s forensic examination, and (4) Max Verduzco’s forensic examination.



Please select up to 5 of the items from the following lists and rank them from highest (1) to lowest (5) order of priority. Use the space below to describe the items and their ranking. Not all items will be included in the ranking.

Medical Forensic Examination of the Victim

- _____ External peri-oral swabs taken from around the mouth (not the lips)
- _____ Oral swabs from inside the mouth
- _____ Fingernail scrapings/swabbings
- _____ Body surface swabs (such as neck, breasts, thighs)
- _____ External genital swabs
- _____ Internal vaginal/cervical swabs
- _____ External anal swabs
- _____ Internal rectal swabs

Victim Clothing (worn at the time of the assault, and to the examination)

- _____ Shirt
- _____ Shorts
- _____ Bra
- _____ Underwear



Forensic Examination of Tyrone Crosby

- _____ External peri-oral swabs taken from around the mouth (not the lips)
- _____ Oral swabs from inside the mouth
- _____ Buccal swabs
- _____ Fingernail scrapings/swabbings
- _____ Body surface swabs (as indicated by history)
- _____ Swabs from the penile shaft
- _____ Swabs from the scrotum
- _____ Swabs from the perineum
- _____ Foreign material
- _____ Dried secretions
- _____ External anal swabs
- _____ Internal rectal swabs

Forensic Examination of Max Verduzco

- _____ External peri-oral swabs taken from around the mouth (not the lips)
- _____ Oral swabs from inside the mouth
- _____ Buccal swabs
- _____ Fingernail scrapings/swabbings
- _____ Body surface swabs (as indicated by history)
- _____ Swabs from the penile shaft
- _____ Swabs from the scrotum
- _____ Swabs from the perineum
- _____ Foreign material
- _____ Dried secretions
- _____ External anal swabs
- _____ Internal rectal swabs

Laboratory Findings

In this jurisdiction, the laboratory routinely analyzes all of the swabs in the evidence kit from the victim's examination. However, no foreign biological material was detected.

On the other hand, the penile/scrotal swabs from both suspects showed the presence of semen as well as epithelial cells, indicating recent sexual activity. DNA analysis of the semen indicated that each suspect had his own semen on his penile/scrotal swab. More important, DNA analysis of the non-sperm fraction (the epithelial cells) from the penile/scrotal swabs of both suspects indicated that they came from the victim.

The fingernail swabs taken from Verduzco also showed the presence of the victim's epithelial cells.



Below we provide a variety of purposes that could potentially be met with these laboratory results. Please mark the purposes that can already be met, based on the information provided so far.

- Establish sexual contract
- Establish digital penetration
- Corroborate vaginal penetration
- Include suspect(s)
- Exclude suspect(s)
- Link local cases based on DNA developed from forensic evidence
- Corroborate the victim's statements
- Challenge the victim's statements
- Corroborate the suspect's statements
- Challenge the suspect's statements

Case Information for Scenario #3: Suspected Drug Facilitated Sexual Assault by Possible Fraternity Members

Synopsis

Isabella Sandoval, a 20 year-old college student attended a fraternity party where she consumed so much alcohol that she passed out in one of the bedrooms. The following morning, at about 1100 hours, she woke up in her own bed, nude, experiencing vaginal discomfort. She found her clothes on the floor at the foot of her bed. She has no recollection of the events of the night before, beyond a certain point when she became extremely intoxicated. Although she went to the party with friends, she has no idea what happened to her friends or how she got from the bedroom at the fraternity party to her own bedroom. The victim got dressed and then called her friends who said they left the party at midnight. The victim wanted to stay at the party because she was having a good time. The victim believed she might have been sexually assaulted so she decided to call the police at approximately 1130 hours.

Deputy Hafner responded to the victim's home at approximately 1330 hours. Sandoval said she smokes marijuana on occasion but she did not voluntarily ingest any drugs at the fraternity party. Based on the limited information available, it was determined that the victim might have been assaulted between midnight and 0100 hours.

After obtaining Sandoval's preliminary statement, Deputy Hafner examined the victim's bedding but didn't see any obvious signs of a sexual assault (e.g., blood or stains). Deputy Hafner collected the bedding as well as the victim's clothing at the foot of the bed that Sandoval had worn to the fraternity party: a pair of underwear, a skirt, and a blouse.



Photo Credit: Diana Faugno



Prior to impounding this evidence, Deputy Hafner used a [Clothing Documentation Form for Law Enforcement](#) to indicate that he photographed and examined the condition of the clothing. In particular, he photographed the victim's underwear that she wore to the party and noted that there was an unknown stain on the blouse, which was possibly vomit.

Deputy Hafner also checked the victim's room and bathroom for any items that might have been used to clean up following sexual activity as well as any condoms or wrappers but did not find anything. Deputy Hafner then drove Jackson to Eisenhower Valley Institute for a medical forensic examination. At the time of the examination, the victim's friends had not yet been identified or interviewed.

Medical Forensic Examination of the Victim

Diana Faugno, the SANE conducting the medical forensic examination in this case, collected a variety of swabs from in and on the victim's body, following standard protocol. Given the suspected drug facilitated sexual assault, Faugno collected blood and urine toxicology samples as soon as possible. She documented her findings in the [SANE Report for Case Example #3](#). Using this report, please review the information to determine when and how the blood and urine samples for toxicology were collected.



What time was the blood sample for toxicology collected from the victim?

- | | |
|-------------------------------|-------------------------------|
| <input type="checkbox"/> 1600 | <input type="checkbox"/> 1615 |
| <input type="checkbox"/> 1640 | <input type="checkbox"/> 1915 |

Which tube was used to collect blood for toxicology purposes?

- | | |
|--|--|
| <input type="checkbox"/> Lavender top tube | <input type="checkbox"/> Yellow top tube |
| <input type="checkbox"/> Grey top tube | <input type="checkbox"/> Black top tube |

What time was the urine sample collected for toxicology analysis?

- | | |
|-------------------------------|-------------------------------|
| <input type="checkbox"/> 1600 | <input type="checkbox"/> 1615 |
| <input type="checkbox"/> 1640 | <input type="checkbox"/> 1915 |

Clothing Collected by the SANE

As part of the medical forensic examination, Faugno collected the bra and underwear the victim wore to the examination. The bra was the same one the victim wore the night before (at the time of the assault), but the underwear was a second pair she put on in the morning before calling the police and heading out to the examination. Faugno examined these items and documented her observations using a [Clothing Documentation Form for Forensic Examiners](#). She also photographed them.



Examination Findings

Faugno summarized the visible physical findings from her examination of the victim:

1. Multiple Lacerations at 6 o'clock on the Posterior Fourchette that goes down to the Perineum. Positive dye uptake.
2. Abrasion from 4-7 o'clock on the Fossa Navicularis. Positive dye uptake. Pulls away when touched here.
3. Multiple bruises on arms and legs.
4. Laceration at 6 o'clock on the Anal Verge, positive dye uptake.

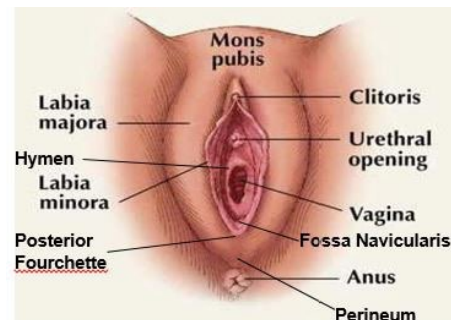

The Posterior Fourchette and Fossa Navicularis are both vaginal structures. The Anal Verge is near the opening to the anus. Positive dye uptake is consistent with an injury to a certain area of skin.

While taking a patient history, the SANE also documented the subjective indicators of pain and injury described by the victim. Specifically, Faugno marked “YES” for the following items on the examination form, and then documented the victim’s responses:

Non-genital injury, pain, and/or bleeding: YES

“I feel really sore, my back hurts really bad, my shoulders and legs are sore.”

Anal-genital injury, pain and/or bleeding: YES

“It is just sore down there.”

For more information, please see the sample [SANE Report for Case Example #3](#).

Interpretation of Examination Findings

The SANE does not offer any conclusion or interpretation of the findings in this report, because the victim is unable to provide any history. However, the investigator will use the findings to inform the course of the investigation. For example, examination findings (combined with DNA testing) can often help to establish – or at least provide information about – any sexual acts that may have been committed. Is this true in this case?



Do the examination findings in this case corroborate any sexual acts that may have been committed? If so, which ones? (mark all that apply)

- Oral copulation
- Vaginal penetration
- Anal penetration

Post-Examination Briefing

Following the examination, the SANE briefed the reporting officer on the findings. Faugno noted that the victim used the bathroom when she woke up, but she had not showered, bathed or douched. The victim also told the SANE she had not had consensual sex for several months, and Faugno relayed this to Deputy Hafner.

Finally, Faugno informed Deputy Hafner that the photographs of the victim's anogenital areas would be retained at the examination facility, but a digital card with photographs of the non-genital injuries were provided to Deputy Hafner. These photographs can often be used to support the investigation and possible prosecution (e.g., search warrants, arrest warrants, charging decisions).

Interviews and Evidence Collection

While the examination was being conducted at the request of Deputy Hafner, a second Deputy and the shift Sergeant coordinated with the Campus Police Department to respond to the fraternity house, where they identified a number of fraternity members who were with the victim at the party at different times throughout the evening. Several agreed to provide buccal swabs for DNA testing, but all denied having any sexual contact with the victim.

Investigator Assessment

At this point, the case was assigned to Detective Eisenga for follow-up. Using the information provided so far, please conduct an evaluation of the assault history, as Detective Eisenga would before making a determination about next investigative steps.



Is the victim able to provide a narrative account of events?

- No Yes Unknown

Is there a starting point for the investigation regarding the number of suspects or the location of the suspected sexual assault?

- No Yes Unknown

How much time elapsed between the possible sexual assault and the victim's medical forensic examination?

- 1-4 hours 5-16 hours
 17-24 hours More than 24 hours

Where did the SANE document visible, physical injuries on the victim's body?
(mark all that apply)

- External genital structures External anal structures
 Other body parts (not anogenital)



Which items of the victim's clothing were collected in this case? (mark all that apply)

- | | |
|--|--|
| <input type="checkbox"/> Underwear (worn to the party) | <input type="checkbox"/> Skirt (worn to the party) |
| <input type="checkbox"/> Blouse (worn to the party) | <input type="checkbox"/> Underwear (worn to the examination) |
| <input type="checkbox"/> Shirt (worn to the examination) | <input type="checkbox"/> Pants (worn to the examination) |
| <input type="checkbox"/> Bra (worn to the party and the examination) | |

Do reference samples need to be collected from any prior consensual sexual partner?

- No Yes Unknown

Toxicology Analysis

Because this case is a suspected drug or alcohol facilitated sexual assault (DFSA), the victim's blood and/or urine sample should be screened for drugs and possibly, blood alcohol content (BAC). According to the information provided by the victim, the medical forensic examination took place less than 24 hours following the suspected ingestion of drugs or alcohol. This will have implications for the type of sample that is preferred for toxicology analysis.



In this scenario, which of the following is the sample of choice for toxicology testing?

- Blood Urine

Laboratory Request for Toxicology Analysis

To see what a Toxicology Analysis Request might look like in a case of drug or alcohol facilitated sexual assault (DFSA), we provide two sample versions, which look similar but serve different purposes.

One is a [Drug Facilitated Sexual Assault 120 Hour History](#) addendum that will be filled out by the forensic examiner who conducts a medical forensic examination of a patient in a suspected drug or alcohol facilitated sexual assault.

The second version is a [Law Enforcement Toxicology Request Form](#) that is completed to help investigators determine which specific tests to request, based on the history of the assault provided by the victim, the symptoms that are either described by the victim and/or observed by witnesses, and other information and evidence revealed during the course of the investigation. For example, based on crime scene evidence such as drug paraphernalia, prescriptions, evidence of drug-related computer searches, or even activities the suspect engages in (e.g., body building), the investigator might have an idea regarding the drug that might have been ingested. This second form will be submitted by law enforcement to the toxicology laboratory along with the victim's blood or urine sample, to



indicate what drugs should be tested for and to provide the toxicologist with as much information as possible prior to testing.

From a law enforcement perspective, the critical elements on the forensic examiner's form are: the documentation of how much urine was collected, the number of samples obtained, and whether the sample was a first or second void. These factors are critical because in most jurisdictions, specialized drug panels (for drugs like GHB, Ketamine, Rohypnol, Soma, Scopolamine and Barbituates) need to be sent to a specialized private laboratory. Tests for common "street drugs" (such as Amphetamines, Marijuana, Opiates, and Phencyclidine) can typically be conducted in a laboratory using a general drug/prescription screen. Investigators must therefore make a strategic choice about which laboratory to choose, if the amount of urine is limited.

This decision will need to be based on the specific facts of the case. To illustrate, an investigator might need to evaluate whether the facts of the case indicate that the victim was given (or voluntarily ingested) an unknown drug such as GHB, Rohypnol, Clonazepam, etc. If this is the case, and the amount of urine collected is limited, the investigator should not send the sample to a laboratory for general drug testing; this is likely to consume the entire sample, thereby eliminating any chance to request a specialized drug panel screen later.

Alternatively, the investigator may determine that the history (i.e., the quantity of drugs or alcohol ingested by the victim) sufficiently explains the level of incapacitation, loss of memory, blackout, illness, etc. If so, the investigator would probably not request an expensive specialized drug panel without first evaluating the victim's blood alcohol level and the results of a general drug screen. If there is more than enough alcohol or drugs in the victim's system to establish the level of incapacitation observed (helplessness or lack of consciousness), then the elements needed to make the case have already been established and the rest is legally irrelevant. An exception would be if investigators and prosecutors are trying to prove that the suspect surreptitiously gave the victim one of these specialized drugs; they could then enhance the charges with crimes such as poisoning or committing a felony in the act of another felony. However, in the majority of cases involving suspected drug facilitated sexual assault, the drugs are not administered by the suspect(s) covertly.



Resource: Expert Interview

In this [video interview](#), Dr. Marc LeBeau responds to a frequently asked question about whether urine can be collected from a victim prior to arriving at the exam facility. In this [video interview](#), he offers three tips for investigators on how to identify a laboratory that conducts toxicology testing in cases of suspected drug-facilitated sexual assault.



Requesting Laboratory Services

In this scenario, there is no assault history to guide the evaluation of various evidentiary items – to make a determination regarding which may be most likely to yield probative biological material. Therefore, it is best to test all the items in the evidentiary kit, as well as some key articles of clothing. This would include the bra and underwear the victim wore to the examination (the bra was also worn the night before to the party).

However, if the investigator is limited to a certain number of evidentiary items in a laboratory service request, it will be critical to evaluate the evidence available and determine which items might be the most likely to yield probative biological material.

Even when the victim cannot provide a history of the assault, some information and evidence will be available from other sources to help guide this determination. For example, in this scenario there are visible physical findings documented by the SANE. As the investigation continues, additional information and evidence might emerge from suspect or witness statements, photographs, digital evidence, etc.



Resource: Expert Interview

In this [video interview](#), Dr. Marc LeBeau summarizes the key questions that a law enforcement investigator should ask, to determine whether a laboratory is able to test for a specific drug.

Preparing a Laboratory Service Request

At this point, we would like you to evaluate the evidentiary items collected in this case and determine their priority for laboratory analysis. The evidentiary items have been grouped in two categories: (1) Medical forensic examination of the victim and (2) Victim clothing.

Please select up to 5 of the items from the following lists and rank them from highest (1) to lowest (5) order of priority. Use the space below to describe the items and their ranking. Not all items will be included in the ranking.



Medical Forensic Examination of the Victim

- External peri-oral swabs taken from around the mouth (not the lips)
- Oral swabs from inside the mouth
- Fingernail scrapings/swabbings
- Body surface swabs (such as neck, breasts, thighs)
- External genital swabs
- Internal vaginal/cervical swabs
- External anal swabs
- Internal rectal swabs



Medical Forensic Examination of the Victim

- _____ Underwear (worn at the time of the assault)
- _____ Skirt (worn at the time of the assault)
- _____ Blouse (worn at the time of the assault)
- _____ Bra (worn at the time of the assault, and to the examination)
- _____ Underwear (put on after the assault and worn to the examination)

Again, you might group together a limited number of items in some instances (e.g., the internal vaginal and anal swabs, penile and scrotal swabs). However, we recommend that you consider each item individually, because your task is to critically evaluate and prioritize all of the available evidence in terms of its potential for probative biological evidence to advance the investigation. (For example, internal vaginal and anal swabs corroborate penetration as well as possible identification of the suspect. They might therefore be grouped together). In addition, you will need to consider each item of clothing based on the victim's statement and the medical forensic examination to help prioritize which evidence should be screened and typed by a criminalist.

Laboratory Findings

When the laboratory report was returned, the results indicated that semen was found on the victim's internal vaginal and internal anal swabs. DNA testing matched the profile found on these items to one member of the fraternity, Richard Allen. These results could therefore serve a variety of purposes in terms of this investigation.



Please mark the purposes that can be met with the information provided so far.

- Establish sexual contact
- Establish vaginal penetration
- Establish anal penetration
- Include suspect(s)
- Exclude suspect(s)
- Link local cases based on DNA developed from forensic evidence
- Corroborate the victim's statements
- Challenge the victim's statements
- Corroborate the suspect's statements
- Challenge the suspect's statements

Laboratory Findings (con't)

The laboratory report also indicated that semen was found on a swab collected from the victim's mouth, and saliva was detected on the victim's right breast swab. DNA analysis matched both to a second member of the fraternity, John Kelly. Again, this evidence could serve a variety of purposes in terms of the investigation of this suspected sexual assault.





Please mark which of the following purposes are met with this evidence.

- Establish sexual contact
- Establish oral copulation (penetration of the victim's mouth with a penis)
- Include suspect(s)
- Exclude suspect(s)
- Link local cases based on DNA developed from forensic evidence
- Corroborate the victim's statements
- Challenge the victim's statements
- Corroborate the suspect's statements
- Challenge the suspect's statements

Evolving Defense: Denial to Consent

When confronted with these DNA results, both suspects switched from denial to a consent defense. When confronted with the victim's non-genital injuries, they both said the victim "liked it rough." In other words, both said they had sex with the victim, but the victim consented to the acts. In this case, the SANEs photo documentation and the diagrams of the victim's injuries are important evidence that will help to support additional investigative steps such as search warrants, arrest warrants, and charging by the county prosecutor.

When questioned, both denied engaging in anal intercourse, but John Kelly admitted to consensual oral sex. They said they lied earlier because they were concerned about being sanctioned by the University.



Please describe the types of evidence and information that might be used to overcome a consent defense in this particular case.

Real World Examples

To further explore what the investigation and documentation might look like in a case of suspected DFSA, we provide two examples from cases investigated by the San Diego Police Department. (Names and other identifying information have been changed to protect identities). These examples demonstrate how officers and investigators would conduct a thorough investigation in this type of complex case.

In the [first example of a DFSA case](#), the suspect provided the victim with a cup of green liquid, which she drank and then passed out on the couch. After making her way to her bedroom alone, she awoke to find the suspect sexually penetrating her. The report details the course of the ensuing investigation.



In the [second example of a DFSA case](#), the victim attended a party where she became extremely intoxicated and passed out in a bedroom. When several witnesses came in to check on her welfare, they saw the suspect sexually penetrating her. Once again, the report details the investigative steps that were taken as well as the findings and conclusions.

Case Information for Scenario #4: Forcible Rape and Sodomy by a Stranger Who Offered Victim a Ride Home

Synopsis

The victim, 20-year old Madison Riggan, went to a party with friends on a Friday evening, where she talked for quite a while with a man introduced as "Robert." Robert is described as a white male, approximately 28 years old. Riggan had three beers while she was at the party. The victim said she drank the beers over several hours and she did not feel that she was intoxicated or incapacitated. She said that she does not engage in recreational drug abuse and she is not taking any prescription medications.

At approximately 0100 hours, Robert offered Riggan a ride home, but instead he took her to a deserted parking lot where he raped her vaginally and anally with his penis and at least one finger while in the front seat of his car. Riggan said that Robert was on top of her so fast she didn't know what to think. She tried to stop him but he wouldn't listen to her. Riggan is unclear if the suspect wore a condom but she believes he ejaculated while inside her vagina.

After the rape, the suspect drove the victim home. Riggan immediately took a shower and changed into her pajamas, and then went to sleep. Later that day, she met with her boyfriend, and although she was upset, she did not tell him what happened. She was afraid he would get angry. They had consensual sexual intercourse at around noon, and he did not wear a condom. Afterward, she became even more upset and decided to report the rape to police.

Riggan called the police at approximately 1300 hours, and Officer Wilson was dispatched to her home at 1330 hours. Wilson conducted a preliminary interview and worked to facilitate a medical forensic examination as soon as possible. Riggan told the officer that the clothing she was wearing at the time of the assault was on the floor in her bedroom. Officer Wilson collected the clothing, including a pair of pants, a bra, underwear and a blouse. The officer also determined that Riggan put on pajamas after showering and those were also collected. He then transported the victim to Eisenhower Valley Institute for a medical forensic examination.

When Officer Wilson and the victim arrived at the hospital at 1600 hours, the officer briefed the SANE, Diana Faugno, with the information he had obtained so far, including the fact that he had collected the clothing the victim wore at the time of the sexual assault and those she put on after showering and before going to bed. When the examination was concluded, Faugno briefed the officer and turned over the evidence kit, including the underwear the victim wore to the examination. Since the victim was

wearing her third change of clothing since the sexual assault, no other clothing was collected by the SANE at this time.

Medical Forensic Examination of the Victim

This time, instead of providing you the summary of findings from the medical forensic examination, we would like you to review the [SANE Report for Case Example #4](#) – to determine what visible physical findings were documented.



Based on the SANE report, which of the following findings were documented during the genital examination?

- Abrasion from 5-7 o'clock of the Posterior Fourchette going up to the Fossa Navicularis with positive dye uptake with positive dye uptake
- Pulls away when touched in the area of the Posterior Fourchette
- Multiple lacerations on the Posterior Fourchette, extending down to the Perineum
- Multiple bruises, redness, swelling to the Hymen
- Superficial lacerations to the Perineum and Anal Verge
- Complaint of pain from the Perineum to the Anus when touched
- Establish sexual contact
- Laceration at 12 o'clock on the Anus

Remember, the Posterior Fourchette and the Fossa Navicularis are both vaginal structures, and they are the most common sites of injury in a sexual assault.

Evidence Collection

We would also like you to review all the items of clothing collected in this case. This is important to conduct an evidence assessment and ultimately request laboratory analysis.



Please list the items of clothing collected in this case. Make sure to include clothing collected by the reporting officer as well as the SANE. Describe each item with the information needed to complete the property tag and impound the evidence in the property room.

When the officer and forensic examiner collect clothing items, do they need to visually examine them? Or should they simply collect and impound them?

- Clothing should simply be collected and impounded
- Clothing should be visually examined by the officer / forensic examiner

Describe some of the things an officer or forensic examiner might be looking for when examining the victim's (or suspect's) clothing?

What tool did we offer in this module specifically for the purpose of documenting these observations?

- SANE Exam Report Form
- Sexual Assault Case History and Analysis
- Laboratory Service Request
- Clothing Documentation Form

Interviews and Investigation

When Detective Archambault was assigned to the case, she interviewed the host of the party, as well as the victim's friends who were with the victim at the party. However, no one could identify "Robert," and they could not think of a person they knew who matched the description the victim provided of the suspect.

At the time, the victim's boyfriend was unwilling to provide a reference standard, so the laboratory will not be able to exclude him as the source if DNA evidence is identified.

Investigator Assessment

It is again time to review the information provided so far, as an investigator assessment.



As you evaluate the facts of this case, please mark all the following that apply:

- The victim is able to provide a narrative account of events.
- The victim's statement provides a starting point for the investigation regarding the specific acts committed and the identity of the suspect.
- The victim believes the suspect used a condom.
- The victim believes the suspect ejaculated.
- A reference standard is needed to exclude the boyfriend's DNA profile.

How much time elapsed between the sexual assault and the victim's examination?

- Less than 1 day (up to 24 hours)
- 1-2 days (25-48 hours)
- 3-5 days (49-120 hours)
- More than 5 days (beyond 120 hours)

Is there any indication (so far) that toxicology analysis will be needed in this case?

- No
- Yes
- Unknown



Were reference samples collected from the consensual sexual partner?

No Yes Unknown

Case History and Analysis

We would now like you to evaluate the evidentiary items collected in this case to determine their priority for laboratory analysis. However, this time we are going to have you use the actual tools developed to assist in this process. First is the [Sexual Assault Case History and Analysis Form](#). You might not have all the information you need to complete the form, however you do have enough of the key case facts to complete the most important sections.

Please print out the [Sexual Assault Case History and Analysis Form](#), and take a few minutes to complete it using the information we have provided about Case Example #4.

Preparing a Laboratory Service Request

Next, we would like to use the information from the Sexual Assault Case History and Analysis to prepare a sample Laboratory Service Request. Please print out the [PDF Version of the Laboratory Service Request](#) and complete it using information from Case Example #4.

As with the Sexual Assault Case History and Analysis, you will not have all the information needed to complete the Laboratory Service Request Form (e.g., names, dates, phone numbers). Just complete the form with the information available to you.

In some cases, however, we have provided you information in the supplemental materials, rather than the synopsis or case information. One example is the victim's reference standard. You have information about this in the materials provided.



Was a reference standard collected from the victim in this case?

No Yes Unknown

On the Laboratory Service Request Form, you can provide information about the evidentiary items selected as the top priorities for laboratory analysis. These items should be ranked in order from the highest to lowest priority. To assist in this process, we will list the evidentiary items available in this case.



Please select up to 5 of the items from the following lists and rank them from highest (1) to lowest (5) order of priority. Use the space below to describe the items and their ranking. Not all items will be included in the ranking.



Medical Forensic Examination

- _____ External peri-oral swabs taken from around the mouth (not the lips)
- _____ Oral swabs from inside the mouth
- _____ Fingernail scrapings/swabbings
- _____ Body surface swabs (such as neck, breasts, thighs)
- _____ External genital swabs
- _____ Internal vaginal/cervical swabs
- _____ External anal swabs
- _____ Internal rectal swabs

Victim Clothing

- _____ Blouse (worn at the time of the assault)
- _____ Pants (worn at the time of the assault)
- _____ Underwear (worn at the time of the assault)
- _____ Bra (worn at the time of the assault)
- _____ Pajamas (put on after showering)
- _____ Underwear (worn to the examination)

For each item listed on the Laboratory Service Request, please begin by providing a detailed description, rather than a general one. For example, please list “underwear worn at the time of the assault” rather than “victim clothing” or even “underwear,” since two pairs of underwear were collected in this case. Similarly, please list “internal vaginal swabs” or “external anal swab,” rather than simply “swabs” or “evidence kit,” etc.

In addition, please indicate whether you would like each item screened for biological evidence, and if so which specific type (e.g., blood, semen, saliva). Then indicate whether you would like DNA analysis to be conducted if the screening test for biological evidence is positive.

Finally, please offer a brief description of the assault history, for criminalists to understand the context of the request for analysis of this particular item. When the victim has provided a statement about what happened, this information can be used to describe the transfer of biological material that might have taken place and the location where it might be expected (e.g., the suspect ejaculated in the victim’s vagina and/or on her stomach, the suspect licked and kissed the victim’s breasts).

Laboratory Findings

Based on the type of sexual assault and the history provided by the victim, the laboratory analyzed all the swabs in the evidence kit. The laboratory also analyzed the underwear the victim was wearing at the time of the sexual assault.

Results indicated that sperm was identified on the victim’s internal vaginal swab. DNA testing produced a DNA profile from an unknown male. No sperm was found on the victim’s underwear or on the anal swabs.



At this point do we know whose DNA is on the victim's vaginal swab?

Yes

No

In response to these laboratory results, the detective re-contacted the victim's boyfriend to explain that he needed to be excluded as the possible source of the semen found. The boyfriend agreed to provide a buccal swab, and his DNA profile matched the profile developed from the vaginal swab. Therefore, no suspect could be identified through DNA testing.

The detective continued the investigation until all viable leads were exhausted. The investigation was then inactivated, pending any new information or investigative leads.

Case Information for Scenario #5: Attempted Sexual Assault by a Stranger in a Park

Synopsis

The 37-year old victim, Estela Camacho, was walking through Riverview Park on a popular hiking trail. At about 0600 hours, she was assaulted from behind by a stranger who placed both his hands under her clothing near her abdominal area. Camacho was unable to get a good look at the suspect's face but she believes he may be homeless because he smelled as though he hadn't bathed. The suspect reached up and placed his hands over Camacho's mouth in an attempt to keep her from yelling for help.

The victim and suspect briefly struggled and Camacho was able to free herself long enough to scream, which drew the attention of two individuals who witnessed the attack. The suspect then fled on foot, and the two witnesses came to the aid of the victim, who immediately called 911.

The witnesses described the suspect as a white male in his 40's. A number of officers responded to the area to start searching the park for possible suspects. Officer Jones contacted the victim at 0610 hours. After obtaining the victim and witness statements, Officer Jones called the Major Crimes Unit to talk to a detective. Detective Bradley asked Officer Jones to transport the victim to Eisenhower Valley Institute for an abbreviated forensic examination, specifically making sure to have the medical forensic examiner swab the outside area of the victim's mouth.

Medical Forensic Examination of the Victim



Below you will find a list of the biological evidence that could potentially be collected in a medical forensic examination. Please mark which of the following items you believe should be collected in this case example.

External peri-oral swabs taken from around the mouth (not the lips)



- Oral swabs from inside the mouth
- Fingernail scrapings/swabbings
- Swabbings of the fingers
- Body surface swabs (such as neck, breasts, thighs)
- External genital swabs
- Internal vaginal/cervical swabs
- External anal swabs
- Internal rectal swabs

Interviews and Investigation

The Sex Crimes detective assigned to this case re-interviewed both witnesses who were able to provide a good physical description of the suspect. A composite sketch was created and distributed throughout the park and the surrounding neighborhood.

Investigators believed the suspect intended to complete a sexual assault, but he fled when the victim screamed.

Laboratory Screening Methods

Because the struggle between the victim and suspect was brief, it is likely that minimal amounts of DNA were exchanged between the two. This will have implications for the specific laboratory analysis conducted.



When there is very limited contact between a male suspect and a female victim (or vice versa), which DNA screening method can be used? What specifically does the method screen for?

Investigative Steps

In this case, Detective Bradley requested laboratory analysis of the swabs taken from the victim's abdomen, fingers and mouth area, and the laboratory used Y-screening methods to test for the presence of male DNA. This has implications for the next investigative steps, including whether or not the detective will collect any DNA reference standards from other males.



Should the investigator obtain a DNA reference standard from the victim's husband or any other male who might have had consensual contact with the victim's abdomen, fingers or mouth?

- Yes No

Why is it important to obtain a reference standard from any males who came into recent contact with the victim's abdomen, fingers or mouth?

Laboratory Findings

When the laboratory results were reported, the swab from the victim's abdomen indicated the presence of female DNA only. However, the swabs from outside the victim's mouth detected the presence of male DNA, even though the vast majority of the DNA originated from a female (in this case, the victim). Using Y-STR technology, the laboratory was then able to produce a DNA profile (called a Y haplotype).



At this point do we know that the Y-profile belongs to the suspect?

Yes

No

Conclusion

Within a few days, a transient in the park was recognized from the composite sketch. Detective Bradley was able to use the information obtained from the concerned citizen to identify and locate the suspect. When contacted, the suspect voluntarily agreed to provide a DNA reference standard. If he had been located promptly after the assault, it would have been important to swab the suspect's fingers for any biological material originating from the victim (e.g., saliva, epithelial cells). However, this was not done in this case, given the length of time that elapsed since the sexual assault.

During the course of the investigation, several other possible suspects provided reference standards as well. However, Y-testing revealed that the Y-profile from the victim's mouth matched the transient suspect and he ultimately confessed to the attack.

Part V: Recommendations for Policies and Practices

We hope the case examples provided an opportunity to apply the training material in realistic and increasingly complex sexual assault scenarios. At this point, we turn our attention to recommendations for policies and practices in this area.

The following recommendations are designed to promote best practices – not only for law enforcement and prosecutors – but also for the other professionals involved in responding to sexual assault victims. Many of these recommendations have already been offered throughout the module, but we draw them out here to help guide policymaking and reforms. Implementing these recommendations will clearly require collaboration across disciplinary boundaries, with an appreciation of each profession's perspective and recognition of their differing roles and responsibilities.



1. Expand Testing of Forensic Evidence

Our first recommendation is simply to expand the use of forensic evidence in a sexual assault investigation – and submit the DNA profiles that are developed from this evidence into the Forensic Index in CODIS whenever possible. Historically, forensic evidence has been under-utilized in sexual assault cases, and this is partly due to resource shortages. However, it is also because many investigators do not understand the many uses for DNA evidence during the course of a sexual assault investigation.



Resource Challenges

In many communities, there is a traditional hierarchy among law enforcement agencies and prosecutor's offices whereby homicides are given higher priority in resources over other crimes, and cases pending trial are given higher priority over ongoing investigations. As a result, laboratory resources have often been largely devoted to trial work, despite the fact that there must be significant evidence of guilt to support the arrest and charging of the defendant, so DNA evidence may not really be needed at that point. Meanwhile, sexual assault cases that are unsolved, and in critical need of an investigative lead that DNA might offer, may remain untested.

Hopefully this challenge will diminish as DNA testing becomes faster, less expensive, and more accessible to support law enforcement investigations. Under ideal circumstances, case priorities for DNA analysis should be based on a balanced assessment of the seriousness of the crime, the quality of the evidence submitted, and the likelihood that a testing outcome will change the course of the investigation.

“Test All Kits” Legislation

The national landscape for DNA testing is also likely to change as a result of new state laws requiring evidence to be submitted in all sexual assault cases within a specified timeframe. A number of states have passed such laws, but it remains to be seen whether this practice will be applied only to the biological evidence collected during the victim's medical forensic examination, or if it will be applied more broadly with other types of evidence as well (e.g., clothing, bedding, condoms, suspect examinations).

Some of the laws are broadly worded to pertain to “sexual assault evidence,” or “physical evidence of a sexual assault case.” However public discussion of the issue almost inevitably focuses on the “rape kit” (i.e., the biological samples collected during the victim's medical forensic examination). Some of the laws also reflect this narrower focus, and refer to the requirement as pertaining to “forensic medical evidence.”



For information and links to the state laws requiring law enforcement to submit evidence in a sexual assault case, please see EndTheBacklog.org, a program of the Joyful Heart Foundation.

These new laws also specify a timeframe for the submission of sexual assault evidence. In Colorado, for example, law enforcement agencies are required to submit the evidence kit to the laboratory within 21 days of collection. The timeframe in Illinois and Michigan is only 10 days, but law enforcement in

Louisiana have 30 days.⁴⁸ In Texas, law enforcement agencies also have a 30-day timeline, but they are only required to submit paperwork associated with the evidence rather than the evidence itself.

Just as prior legislation greatly expanded the number of DNA profiles uploaded into CODIS – first in the Convicted Offender Index and then the Arrestee Index – these new laws are likely to create a dramatic increase in the number of DNA profiles submitted to the Forensic Index, which will ultimately increase the power of DNA to solve crimes.

Not Just for Prosecution

Implementing this recommendation will require a change in the mindset of police and prosecutors, who often view DNA testing as a means of confirming what they already know – rather than advancing an investigation by producing identifications, leads, and potential corroboration. This explains why evidence has so often been tested only when a case is headed to court – or only when a suspect has already been identified.

This point is illustrated in a national study of 2,250 law enforcement agencies, where participants were asked to provide reasons why they might not submit forensic evidence for analysis in an open case. As many as 44% said they would not submit evidence in a case if a suspect had not been identified. An additional 15% said they would not test evidence unless it was requested by a prosecutor, and 12% said they would not submit evidence if the suspect was identified but not formally charged (Strom et al, 2009). The researchers concluded that some agencies continue to have “a limited understanding of the full benefits of forensic evidence with a mindset that forensic evidence is only beneficial for prosecuting crimes, not for developing new leads in investigations” (Strom et al., 2009, p. vii).⁴⁹

⁴⁸ Some of these statutes also include a timeframe for analysis to be completed by the laboratory. In Illinois, for example, the law requires evidence to be analyzed by the laboratory within 6 months but only “if sufficient staffing and resources are available.” Almost identical language is included in the Texas law. In Illinois, considerable effort has been taken to secure these resources. As of June, 2012, Chicago media reported that 2,049 of the 4,008 cases expected to be submitted to the Illinois State Police Crime laboratory system had already been processed, resulting in 445 CODIS hits. This represents a “hit rate” of about 22%, although this will likely increase over time as additional profiles are added and searched.

⁴⁹ Two of the most common reasons law enforcement agencies gave for not submitting evidence to the laboratory was because the case had already been dismissed or adjudicated without it. These reasons were given by 24% and 19% of respondents, respectively. However, it is impossible to interpret the meaning of these findings without detailed information about the case and available resources, so it remains unknown whether the analysis of forensic evidence *could have* affected the outcome otherwise.



In fact, one detective described how he only came to appreciate the value of DNA as an investigative tool after Los Angeles enacted a policy of testing all kits.

Not Just for Strangers

While some investigators have viewed DNA as a tool for confirming what is already known, others have seen it as a means of identifying an unknown suspect.

In many agencies, forensic evidence has thus been tested only in cases of stranger sexual assault. One police official explained this logic.

Having the DNA from every rape kit I book has given me investigative leads I never would have expected. I take second looks at cases I would have dismissed, and I pass along more cases to the prosecutors. I used to think I didn't need DNA to develop a case, but it has helped me solve more cases (Human Rights Watch, 2009, p. 18).

We don't need the DNA test when we know who the suspect is already without it. It would be a waste of everyone's time and money (Human Rights Watch, 2010, p. 32).

This perspective fails to recognize the many purposes of DNA in the majority of sexual assault cases where the victim and suspect know each other. As highlighted throughout this module, the purpose is not just to identify the suspect but also to link cases together and corroborate the victim's and/or suspect's statements. Our recommendation is therefore to expand the use of DNA *regardless of whether the victim and suspect know each other – and even when the defense is likely to be consent.*

A prosecutor highlighted this point, by describing a situation where this type of evidence was needed but not available, because the physician conducting the medical forensic examination did not swab all of the locations on the victim's body where she said the suspect had ejaculated.

This anecdote also illustrates the need for feedback to forensic examiners, because otherwise they have no way to know when they might need to modify their practices.

The victim claimed that the suspect had ejaculated in her belly button [but] the suspect ... denied ejaculating in the victim's belly button. I had hoped to test a swab taken from the victim's belly button in order to back up the victim's version of events and discredit the suspect at trial... [However,] the laboratory informed me that the doctor had not swabbed the victim's belly button ... it was incredibly frustrating to move forward without crucial evidence (Human Rights Watch, 2010, p. 29).

Need for Quality Assurance

Many agencies have developed procedures that allow laboratory personnel to conduct quality assurance – to identify improvements that are needed in the evidence collection and

documentation process during a medical forensic examination. This is often accomplished with a form that is included within the evidentiary kit. When evidence is submitted to the laboratory, forensic scientists can record information on the form for quality control purposes and return it to the forensic examiner program to continuously improve the quality of their examinations and evidence collection. For example, if the instructions state that the forensic examiner should collect four vaginal swabs– but only collects two vaginal swabs – this information can be noted as feedback.



Three examples of quality assurance forms designed to meet this purpose are included in the Appendix of this module. They include sample forms from: (1) the [San Diego Police Department](#), (2) [Eisenhower Medical Center](#) in Rancho Mirage, California, and (3) the [State of Oregon](#). This type of form should be included in the evidentiary kit completed by the forensic examiner, so the laboratory can provide feedback during the initial evaluation of the kit which occurs at the time of laboratory analysis.

Not Just for “Winnable” Cases

A change in mindset is also needed so evidence is tested even in cases that may be perceived as difficult, if not “unwinnable.” Often this is based on an attitude of skepticism toward the victim or case, as illustrated with this officer’s explanation.

This attitude of skepticism deserves particular attention, because it often means that evidence will remain untested – and indeed, cases remain uninvestigated – simply because the investigator did not believe the report. This point is painfully illustrated in the following case, in which Sgt. Joanne Archambault served as an expert witness.

I am not going to submit a kit when we know who the alleged perpetrator is. I am also not going to submit a kit when I don't think the case is founded, where something about the victim's story just doesn't add up. As you know, some people report a rape to get back at their boyfriend, or to hide from their parents that they were having sex with their boyfriend, or all sorts of reasons. So, you don't just test every rape kit that comes to you (Human Rights Watch, 2009, p. 54).

Among the many troubling aspects of this case is the fact that the evidence collected from the victim and her clothing could have been tested, and a DNA profile might have identified the perpetrator before he assaulted numerous other women. The facts of this particular case will thus be presented in more detail in the following section, because they perfectly illustrate many of the key points made in this module.



In July 2004, a 19-year old woman was working at a convenience store, where she was robbed and sexually assaulted at gunpoint. The victim ran to a neighboring business and an employee called 911. The victim submitted to a medical forensic examination even though she didn't think it was necessary since she didn't believe she'd been 'raped' (the assault involved forced oral copulation and digital penetration, not penilevaginal penetration). Her clothing was also collected as evidence.

From the outset, both the responding officers and the investigator assigned to the case believed the victim stole the cash herself and fabricated the sexual assault and robbery to cover it up. As a result, the detective did not pursue the investigation, even when he was assigned another case with a very similar fact pattern three months later. These two assaults were the only two rapes reported in that jurisdiction that year. Rather than investigating the sexual assault and robbery, the victim was charged with theft, receiving stolen property, and filing a false police report (all misdemeanors). Although the victim was five months pregnant, she spent five days in jail.

Investigative Failures, Repeated Perpetration

In this case, the suspect fondled the victim's breasts, and she was forced to orally copulate his penis as well as digitally penetrate his anus. Therefore, biological evidence from the suspect very well might have been recovered by swabbing the victim's fingers or collecting fingernail scrapings along with internal and external peri-oral swabs. This is true even though the victim stated she had washed out her mouth. Ejaculate or saliva might also have been recovered from her clothing. Yet none of these items were submitted to a forensic laboratory for analysis.

Similarly, no effort was made to collect any items the victim used to clean up after the assault, although she told one of the responding officers she had done so in a restroom. In fact, the only evidence tested in this case were the blood and urine samples taken from the victim during the medical forensic examination, which indicated the presence of THC and Diazepam. These toxicology findings were then used to discredit the victim.

If the victim's evidence had been analyzed, and a foreign DNA profile was able to be developed, it would have linked the suspect to at least one other sexual assault. This is because the same suspect committed two prior sexual assaults that had been reported to police: one in September of 2002 and another in September 2003. The pattern of behavior was strikingly similar in all three cases.

When the detective was assigned his second case three months after the first one described here, his response was very different. Unlike the first case in the convenience store, the detective believed the victim in the second case. The victim's clothing was therefore submitted for analysis and a foreign DNA profile was developed from her shirt. The profile matched the evidence from at least one of the two prior cases, but there was no match for a suspect in CODIS at the time, so the suspect's identity remained unknown.

The Manhunt Begins

A statewide task force was formed to launch a coordinated investigation. However, they did not include the assault in the convenience store in their review, because the investigating detective had advised them that the victim fabricated the report to cover up a theft from her employer. Through the work of the task force, a number of sexual assaults were linked through the investigations and evidence, including DNA. A detailed composite sketch was widely publicized, along with a cash reward and public pleas for help. Yet the suspect continued to elude the authorities.

Finally, in August 2005, Wilbur Cyrus Brown was arrested when he attacked another convenience store clerk. This assault took place just a little more than a year after the first case example. In this 2005 case, the victim managed to sound an alarm during the sexual assault. Brown had tied her up, doused her with lighter fluid, and threatened to set her on fire before police arrived and took him into custody.⁵⁰

Police later transmitted details of the attack and the suspect's description across the state. The assault was then connected to the others identified in the series and the manhunt was finally over. After his arrest, Brown confessed to 11 attacks across the state, including the assault of the victim in the first convenience store case. It was only at this point that the charges against her were dropped.

Lessons Learned from Injustice

In this tragic case, the victim successfully sued the detective, resulting in a 1.5 million dollar settlement. It therefore highlights the need to submit forensic evidence even in cases that might be perceived as difficult or "unwinnable," based on characteristics of the victim, suspect, or case. In this case, there was very likely physical evidence that could have proved the crime if only it had only been tested. Although Brown was not in CODIS at the time, his DNA profile would have matched with forensic evidence in at least one other case and the facts in all of the linked cases may have revealed new leads and helped to strategize investigative steps. We hope the lessons learned from cases such as these can lead the way toward preventing similar injustices in the future.

Value for Prosecutorial Strategy

Beyond the many advantages of forensic DNA during the course of a sexual assault investigation, it can also be extremely valuable for prosecution, even in cases with a consent defense. To highlight this point, Assistant County Attorney Jeff Noble characterizes the argument that

Look, you admitted you did it. The DNA shows you did it. The victim says you did it. You can say consent, but if they don't believe you on that one issue, we lose.

- Assistant County Attorney Jeff Noble, 2014

⁵⁰ [Serial rapist gets jail and chilling lecture](#). *Lancaster Online*. Posted April 27, 2007. Updated September 11, 2013.

can be made by defense counsel, to persuade defendants to plead guilty without a trial when there is DNA evidence.⁵¹

Noble noted that such cases do not often go to trial, but he attributes that in no small part to the DNA results themselves. In some cases, he argued that it is the DNA that “gets” the admission of consent.

Having the DNA in these cases can also provide the investigator with a strategy for conducting the suspect interview. Without revealing information about the forensic evidence to the suspect, the investigator may provide the opportunity for the suspect to deny any sexual contact with the victim. At that point, the suspect is locked into a statement, which will be difficult to defend later.

Noble also pointed out that DNA evidence is often used by prosecutors to force the suspect into testifying. He illustrated this point by noting that a defendant does not have to take the stand and face cross-examination. However, if the prosecutor introduces only the victim’s testimony and the DNA results, the defendant will need to take the stand to assert the consent defense. This opens the defendant to cross-examination by the prosecutor.

A third reason is simply to convey that investigators and prosecutors have taken all possible steps to overcome the reasonable doubt that may stem from such an omission. Noble articulates the argument that can be made by the defense if DNA analysis is not conducted. DNA results can be used to preclude such an argument and focus on the critical question of consent.

With the obligation to present this case beyond a reasonable doubt, what did the state do? They took this victim at her word! They didn't even test the DNA! ... They want to label this poor young man a sex offender for the rest of his life and they didn't even test the swabs!

- Assistant County Attorney Jeff Noble, 2014

Beyond the Statute of Limitations

Before concluding this first recommendation, we want to highlight the importance of testing evidence and submitting profiles into CODIS even in cases where the statute of limitations has expired. In Texas, for example, a law was passed in 2009 that allows law enforcement to enter DNA profiles in cases where the statute of limitations has expired.⁵² While these cases cannot be prosecuted, the database can be searched by law enforcement across the state, as a means of gathering intelligence. This legislation was the result of advocacy by progressive jurisdictions such as Dallas, where professionals argued to test kits beyond the statute of limitations – both to solve cases and also to provide some sense of closure for victims.

⁵¹ These points were made in a post made by Polk County (Iowa) Assistant County Attorney Jeffrey Noble on the National SART Listserv hosted by the National Sexual Violence Resource Center on May 27, 2014. We would like to thank Mr. Noble for providing permission to excerpt this post here.

⁵² [411 Texas Government Code, Subchapter D-1](#), beginning at 411.0601.



For more information on the Texas law and database, please see the website for the Texas Department of Public Safety, in the section providing information about the [Statewide CODIS DNA Database Program](#).

Evidence of prior crimes can often be introduced during the prosecution and sentencing phases for a crime that is currently being prosecuted, as evidence of prior criminal acts. This is true in Texas as well as Alaska, where victims of a prior sexual assault can testify in person at the sentencing hearing for another sexual assault committed by the same offender – even if their own sexual assault was never prosecuted.⁵³ Tools such as these can be extremely valuable – not only for law enforcement and prosecution, but also for victims and communities as a whole.

2. Test Evidence Based on the Assault History

Our second recommendation is for law enforcement to test evidence based on the facts of each case, an evaluation of the assault history, and a determination regarding which evidence is most likely to be probative. We have made this point repeatedly, but it is best illustrated with case examples such as the following.

Based on the facts of this case, it is possible to prioritize items for analysis, based on the likelihood that they will yield probative biological evidence.

A San Diego transit bus driver was kidnapped and sexually assaulted by her last passenger of the night. The suspect clearly intended to rape the victim, but he could not obtain an erection and therefore did not attempt to penetrate her. The suspect sucked on the victim's neck and breasts and then he forced her to orally copulate his penis.

The victim was able to escape and a medical forensic examination was conducted within a short period of time. Unfortunately, the forensic examiner did not obtain swabs from either the victim's neck or breasts. This could have been due to a lack of specialized training or simply by mistake. It could also be because many forensic examiners during this time period only swabbed areas that fluoresced using a Wood's Lamp.

It would have been ideal to conduct a suspect examination to obtain swabs of the suspect's penis and scrotum, but he fled the scene and was not taken into custody for some time.



We have already provided a sample [Sexual Assault Case History and Analysis Form](#) (in the Appendix), to help guide investigators in determining which laboratory analyses are most likely to be probative – and therefore most likely to advance the investigation of the case. The goal is to streamline the process of

⁵³ [Alaska Stat. 12.55.155](#).



laboratory analysis, and even to reduce backlogs and wait times. Improved communication can also go a long way toward helping analysts and investigators understand what the results may mean.

First, the investigator should request that the laboratory examine the victim's bra since it was pushed up while the suspect was sucking on her breasts and then later brought back down over the moist area. The second priority might be the victim's shirt collar, because it is the location on the clothing worn closest to the area where the suspect sucked the victim's neck. The third item that might offer probative evidence would be the swabs taken from the victim's mouth if the suspect ejaculated. However, this is perhaps the least promising option of the three. Any vaginal swabs would not be considered a viable option for analysis, because they will not yield probative evidence based on the sexual assault history.

Forensic Evidence Kit Not Always Probative

This particular case example highlights the fact that the victim's evidence kit may not be the most important source of potential evidence in a particular case. In fact, depending on the assault history, items in the kit (such as the vaginal swabs) may actually have *no potential for biological evidence*. This determination can only be made based on the specific history of the assault. In this case, for example, the vaginal swabs will not likely have any biological material from the suspect because penetration was attempted but not completed. This can also be true if penetration was completed but the suspect wore a condom or did not ejaculate.

Particularly with young victims, biological evidence is often not recovered from the medical forensic examination, because so many of these cases involve contact rather than penetration. Even in cases that do involve penetration, the examination is often conducted after a significant period of time following the last assault. This is why the primary purpose of an exam with a young victim is typically not to collect biological evidence from a recent assault – but rather to document the assault, including evidence of old injuries. Even more important is treating the child for sexually transmitted infections (STI's), connecting the family with resources, and providing follow-up care if necessary.

Interpreting “Negative Results”

In fact, it is important to keep in mind that many sexual assault evidence kits submitted for analysis will have “negative results.” Research suggests that approximately half will (e.g., Campbell et al., 2015; Peterson et al., 2012). However, as illustrated in the examples above, this “negative result” only means that a foreign DNA profile was not developed from the evidence submitted for analysis. We must be careful not to conclude – and certainly not to communicate to victims – that this means there is “no evidence” in these cases.

Negative results simply mean that a foreign DNA profile was not identified on whatever evidence happened to be tested, and even that can change depending on what screening method was used (e.g., microscopy, acid phosphatase, Y-STR analysis). This

highlights the need for caution when interpreting DNA results without any consideration of the assault history.

Other Evidence Not Likely to be Probative

A careful analysis of case facts will also help reveal other sources of evidence that are *not* likely to be probative. For example, if the victim reports being sexually assaulted by her boyfriend in the bed they share, it would not make sense to request an analysis of the bedding for evidence of the suspect's semen or victim's epithelial cells. Such evidence would not advance the investigation, because it is just as likely to be the result of consensual sex as sexual assault (assuming the couple has had consensual sex in the bed, and the bedding was not washed afterward). However, a request to examine the bedding *for blood* may have probative value, if the victim or suspect was injured during the sexual assault.

Similarly, if the sexual assault occurred in the suspect's bed, the presence of his own seminal fluid is irrelevant – regardless of whether he has a relationship with the victim or not. There is simply no probative value to finding a man's semen in his own bed. However, if the *victim's epithelial cells* are found in the suspect's bed, this may have probative value by placing her in that location, in case the suspect denies that fact. Laboratory analysis for the victim's blood may also corroborate any injuries that were described by the victim and/or documented by the forensic examiner. Again, the bottom line is that investigators should conduct a careful analysis of the assault history and other case facts, to determine where probative evidence is – and is not – likely to be found.

3. Improve Communication with Laboratories

This recommendation overlaps with the previous one, which is to improve communication between law enforcement investigators and laboratory personnel. In too many agencies, evidence is sent to criminalists without any communication regarding where DNA might be found on a specific piece of evidence – and how to prioritize the analyses requested.

For some types of evidence, a lack of communication will not create a significant problem; for example, a vaginal swab will simply be analyzed to develop any foreign DNA profiles (hopefully any consensual partner has been excluded). The meaning of any resulting DNA profiles will then be interpreted within the context of case facts, but the actual testing of a vaginal swab will generally be the same from one case to another.

For other types of evidence, however, communication may be able to improve the efficiency of analysis rather significantly. We have previously mentioned the example where a sexual assault is committed on the victim's bed, and a comforter is submitted to the laboratory for analysis. In that scenario, there may be a number of stains and biological samples on it, and a great deal of time can be wasted if criminalists are provided no information as to where specifically they might look for biological evidence.

Guidance for Laboratory Personnel

It is much more efficient if criminalists are given information that the sexual assault took place – for example – on the top, left-hand corner of the bed and the comforter is marked to identify the top and bottom, versus the right and left-hand side. Alternatively, the crime scene investigator could simply use a marker or a piece of masking tape to indicate the spot where the act took place or the area that was still wet or stained when the comforter was collected at the scene. While this stain may be clearly visible at the time of the initial report, by the time the comforter is analyzed in a laboratory, it will typically be more difficult to identify as the probative stain.



Photo Credit: Joanne Archambault

To implement this recommendation, appropriate training is needed, so crime scene investigators do not mark the actual stain and introduce inks that may inhibit the testing process. Trained investigators or crime scene technicians might also collect a swab from the wet stain while at the scene, to submit directly for analysis.

For many agencies, this goes against the traditional thinking that officers and crime scene investigators should never handle or mark evidence for fear of contamination or outright destruction. These concerns are well-grounded, but they can be balanced with common sense and the reality that DNA evidence is simply not that fragile. The advantage of marking the area surrounding a wet stain on a comforter – or swabbing the area for direct analysis – may outweigh concerns over contamination, as long as appropriate precautions are taken.

As with any other piece of evidence, such handling will need to be documented in the crime scene report and accompanied by photographs. By consulting with a prosecutor as early as possible during the course of an investigation, investigators can ensure that their efforts to improve communication and efficiency with the laboratory are easily explainable in court and not counterproductive to holding offenders accountable.



Implementing this recommendation requires a number of documentation tools that have already been mentioned and are provided in the Appendix of this module. First, there are the two versions of the Laboratory Service Request Form – one in [Excel format](#) and one in a [Word document](#). Both can be used to improve communication regarding the priority of requested analyses and the specific locations where evidence might be found. Another tool is a [Clothing Documentation Form](#), which could be filled out either by the law enforcement investigator and/or the forensic examiner, depending on who is collecting the clothing (and where and when). This form serves as an addendum to other standard reporting forms for the investigation and medical forensic examination. Again, this form can potentially help improve communication between law enforcement and the laboratory by documenting exactly what items were collected, indicating whether they were worn during or immediately after the

assault and describing specifically where evidence might be found on each item based on the sexual assault history provided by the victim and/or suspect.

Strategies for Improving Communication

Yet documentation tools and service request forms are only one way to communicate information between investigators and forensic scientists. Comprehensive policies can also require that the investigator personally talk with the analyst working on a case, either on the telephone or in person. This can be one of the most effective ways to prioritize analyses to make the most efficient use of valuable laboratory resources. Direct communication can also help to reduce confusion and provide better direction for the analysis of evidence submitted to the laboratory.

In some cases, investigators may even consider consulting with a prosecutor prior to submitting their requests for laboratory services. This can be especially helpful if the laboratory analysis can establish more than one element of the offense, such as sexual penetration as well as force.

4. Encourage Victim Access to Medical Forensic Exams

Our fourth recommendation is to encourage victims' access to the medical forensic examination. Some have questioned whether an examination should be conducted when the victim and suspect know each other and the defense is likely to be consent. This argument is typically based on two premises:

1. The process of collecting evidence from the victim is traumatic, and
2. Any evidence that is collected will be irrelevant because the suspect will most likely admit to the sexual acts but argue that the victim consented.

We have already responded to the second issue at length, by outlining the many other purposes that can be met with a medical forensic examination in a consent defense case. By linking cases together, corroborating the victim's (or suspect's) account of events, and documenting evidence of force, a medical forensic examination can be extremely valuable in advancing a non-stranger sexual assault investigation and potential prosecution. A trained forensic examiner will also collect and document critically important information and evidence beyond biological samples.

With respect to the first point, some have argued that it is not our place as professionals to decide what is “too traumatic” for victims. Professionals working in this field certainly strive to be compassionate and reduce unnecessary trauma experienced by victims. However, many victims are not only able to withstand the process of a medical forensic examination – they are highly motivated to do so in the hopes of holding the offender accountable. Many victims also want to believe that they “did something” to address the injustice that was done to them and to prevent future assaults on others – even if their own case does not result in a successful prosecution. These points were eloquently articulated by Amy Pollpeter of the Iowa Division of Criminal Investigation.⁵⁴

It should always be a victim's choice of whether having the kit collected is too traumatic for them – if so, then they have the right to refuse the kit and just get a medical exam, or just seek advocacy services. We should never be in the business of deciding what a victim 'can handle.'

- Amy Pollpeter, Iowa Division of Criminal Investigation

More important, victims benefit in a variety of other ways from participating in the examination, by having their physical health checked and medical needs met (e.g., prophylaxis for sexually transmitted infections, emergency contraception), as well as connecting them with other resources. It is therefore incumbent upon communities to ensure that victims have the information and support (e.g., victim advocacy) they need to access a medical forensic examination by a specially trained health care provider.

5. Expand the Use of Suspect Examinations

We also recommend expanding the use of forensic examinations with suspects. As previously noted, a forensic examination should be considered any time the suspect in a sexual assault case is arrested promptly, when investigators believe the suspect has not bathed since the assault, and/or there is reason to believe there might be evidence of injury to the suspect.

Obtaining a Suspect Examination

In general, there are three ways this can be accomplished:

1. The suspect may consent to a forensic examination;
2. A warrant or court order may be obtained; or
3. In a few states, a forensic examination may be conducted with a suspect incident to an arrest.

⁵⁴ These points were made in a post made by Amy Pollpeter of the Iowa Division of Criminal Investigation on the National SART Listserv hosted by the National Sexual Violence Resource Center on May 27, 2014. We would like to thank Ms. Pollpeter for providing permission to excerpt this post here.



Each of these scenarios will be discussed in turn. First, it is clear that law enforcement can legally obtain a forensic examination of a suspect if he/she consents to it. However, we have heard of a few agencies with policies prohibiting this practice. Therefore, law enforcement professionals must check with their own agency, as well as the prosecuting attorney's office, to learn about any relevant policies.



In our training bulletin on [Forensic Exams for the Sexual Assault Suspect](#) we include a [sample consent form](#) for a suspect forensic examination, as well as guidelines for various precautions that can be taken to document that a suspect's consent to forensic evidence collection was voluntary and not coerced.

Another way that a suspect examination can be obtained in some jurisdictions is *incident to an arrest* (but prior to booking in jail). In some jurisdictions, the courts have expressly authorized law enforcement to obtain a complete forensic examination of the suspect at the point of arrest. This applies to suspects in a sexual assault case, or a case involving other crimes such as assault with a deadly weapon or homicide. The examination is justified based on exigent circumstances, and it typically involves obtaining both blood and buccal swabs, among other evidence such as clothing, trace evidence and photographs. In many jurisdictions, however, law enforcement personnel are required to obtain a *search warrant or court order* to conduct a suspect exam. This clearly adds another step to the investigation, but it does not need to stand in the way given the potential value of this evidence. In these jurisdictions, officers and investigators should have templates stored on their computers for easy access, to quickly craft an affidavit and search warrant to obtain a forensic examination of a sexual assault suspect.



As previously noted, we offer a template for an affidavit and search warrant to obtain [a forensic examination of a suspect](#), as well as two examples of an affidavit and search warrant to obtain [confirmation samples](#) and other potential evidence (e.g., blood, buccal swab, fingerprints, hair) from an incarcerated person following a CODIS hit. These materials are provided with the training bulletin on [Forensic Exams for the Sexual Assault Suspect](#), but they will need to be adapted for use based on the specific facts of each case and the laws in your jurisdiction.

Buccal Swabs

Regardless of whether a complete forensic examination is conducted with the sexual assault suspect, we also recommend obtaining a buccal (mouth) swab for the suspect's DNA whenever possible. The collection of a buccal swab is governed by the same requirements and exceptions described above. However, there are also a few other specific situations where consent is not needed before collecting DNA evidence from

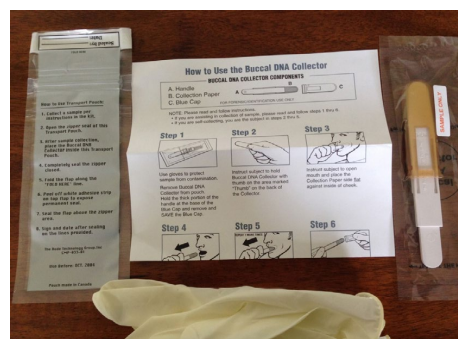

Photo Credit: Joanne Archambault

an individual, which can either be accomplished using a buccal swab or a blood draw. This includes situations where:

1. A suspect is arrested on a charge that is explicitly covered in the state law allowing the collection of DNA.
2. A court order authorizes the DNA collection.
3. A suspect is subject to a “fourth waiver” (meaning the person is on probation or parole, and a condition of release is a waiver of the Fourth Amendment right prohibiting unreasonable search and seizure).

As previously noted, some states explicitly authorize a complete forensic examination at the point of arrest, which typically includes buccal swabs as well as a blood draw. Investigators must be familiar with the laws in their state, as well as the policies and protocols in their jurisdiction with respect to these issues.

6. Exclude Consensual Partners

Our next recommendation is to ensure that investigators obtain reference standards from any consensual sexual partner identified by a victim, so their DNA profile is not submitted to CODIS as a forensic unknown. This is necessary not only in cases where the victim has a medical forensic exam, but any time the consensual partner’s DNA may be found on evidentiary items (e.g., the victim’s bed or clothing). As previously noted, it is best to obtain these reference standards from any consensual partner as soon as possible during an investigation, because it may become more difficult over time.



To understand the significance of this recommendation, it is helpful to consider what would happen if the DNA profile from a consensual partner *is* mistakenly entered into CODIS during the course of a sexual assault investigation. First, there might be no match in CODIS, leading investigators to believe the suspect’s profile is not yet in the database. In this scenario, it is the consensual partner’s DNA profile that is not in the database; the suspect’s might very well be. However, this development could potentially deter investigators from using more traditional law enforcement techniques designed to identify the correct suspect (e.g., researching registered sex offenders in the area, conducting witness interviews, obtaining phone records and search warrants).

Second, the consensual partner's DNA profile could yield a hit with a forensic or offender profile already in the database, as a result of the consensual partner having committed a prior crime. This could potentially derail the course of the investigation if the victim is distressed over the discovery that her/his partner may have an undisclosed criminal history. This is exactly what happened in a case in Detroit.

The victim had had consensual sex within 72 hours (or so) of the assault, and the resulting 'offender hit' was to the victim's boyfriend, not to the man who had sexually assaulted her (Campbell et al., 2015, p. 176).

To avoid outcomes like this, recommended practice is to identify and exclude the DNA profile from any consensual partner identified by the victim in a sexual assault case. In fact, federal policy requires laboratories make every attempt to ensure that only DNA profiles from legitimate case evidence are uploaded into CODIS. This requires asking victims sensitive questions about any consensual sex they might have had in the past few days, either before the assault or even during the timeframe between the assault and the medical forensic examination. Asking such questions can be difficult, but this process can be facilitated by explaining their very important purpose. This is another reason why it can be helpful to involve the prosecutor as early as possible during an investigation. Prosecutors can help to answer questions the victim may have about what will happen as a result of submitting the consensual partner's DNA – specifically, whether this means that a victim's sexual past will be introduced at trial. Rape shield laws can sometimes be used to exclude a discussion of prior consensual sexual activity at trial, unless this can potentially explain injuries that the prosecution wants to introduce. However, the specific answers to such questions will of course vary by jurisdiction; prosecutors will be able to answer these questions with a jurisdiction-specific response.

7. Do Not Submit Evidence if the Victim Has Not Talked With Law Enforcement

While we have repeatedly recommended that evidence be submitted for analysis in all sexual assault cases where appropriate, we need to be very clear that this does not apply when victims have a medical forensic examination but have not yet personally reported to law enforcement. In other words, when the victim has not yet talked with an officer, which provides the opportunity for law enforcement to complete a crime report. Remember that it is outside the role of a medical forensic examiner to determine whether a crime has occurred.

Victims often need some time to make a decision regarding whether they are able to participate in the criminal justice process. As a result of trauma – and possibly negative reactions from friends, family members, or even health care providers – many victims are unsure about this decision at the time of their medical forensic examination. While they may later decide that they are able to participate in an investigation, the evidence from their medical forensic examination should not be submitted for analysis until then.

The reasons for this are outlined in an EVAWI Training Bulletin entitled, [Should We 'Test Anonymous Kits?'](#) They can be summarized as follows:

1. Victims have not consented to having their evidence analyzed.
2. The elements of a criminal offense have not been established.
3. No crime report has been documented by law enforcement.
4. Consensual partners have not been excluded.

However the most straightforward reason is *because it violates CODIS policies*. As previously noted, the FBI requires that law enforcement establish the elements of a criminal offense before uploading a DNA profile to CODIS. This is typically accomplished with the victim's statement provided to law enforcement. Therefore, this recommendation is actually a statement of CODIS policy: No DNA profile should be uploaded to NDIS unless the victim has personally talked with law enforcement and a crime report is completed with the elements of a criminal offense established. Otherwise, evidence should simply be stored in accordance with established standards for the length of time established by policy.

All of this needs to be very clearly explained to victims, so they understand what will and will not happen. This is a source of considerable misunderstanding, for victims and professionals alike, and victims must understand the implications of their decision and the different outcomes that are likely with a report that is made sooner versus later.



For more information on the issues involved when a victim has a medical forensic examination without personally talking with law enforcement, please see Module #14 in our OnLine Training Institute (OLTI), entitled, [The Earthquake in Sexual Assault Response: Implementing VAWA Forensic Compliance](#).

Need for Policies and Procedures

Law enforcement policies will also need to spell out what procedures will be followed for the collection, documentation, transfer, storage, and potential destruction of evidence in situations where the victim has had a medical forensic examination but not yet decided whether to participate in the criminal justice process. This is particularly relevant for jurisdictions enacting laws or policies to "test all kits," especially those with a deadline for evidence submission. What will happen to evidence collected from a victim who has not personally reported to law enforcement, to ensure that it is not submitted for analysis as a matter of routine procedure? Without establishing explicit policies and procedures, it will be easy for such kits to be accidentally submitted before victims have consented or reported to law enforcement.

Some professionals even believe that these evidence kits should be analyzed, in the interest of protecting public safety or perhaps in the hopes that a victim will participate if there is a CODIS match. A few states and local jurisdictions are therefore establishing policies, protocols, or practices that submit all evidence kits for analysis, regardless of whether or not the victim has decided to participate in the criminal justice process. As noted



above, this constitutes a violation of FBI policies regarding which profiles can be uploaded in CODIS. It also goes against a victim-centered philosophy. If victims have not yet personally engaged with law enforcement or consented to have their evidence analyzed, it is difficult to justify this practice.



To see an example of how devastating it can be for victims to be subpoenaed to testify against their will, and then jailed, please watch this video of a judge sentencing a domestic violence victim to jail for contempt of court, while she literally begs for mercy. The video was posted by ABC News, in a story entitled, [Tough Words from Judge as She Sends Abuse Victim to Jail](#) (dated October 7, 2015).

This practice can also potentially place victims in a very difficult position if the DNA profile results in a CODIS hit. It is easy to imagine a scenario where investigators and prosecutors are eager to pursue a hit, and victims are pressured to participate in the law enforcement investigation or even subpoenaed to testify against their will. Worse, victims could be arrested and jailed for failing to appear in response to a subpoena.

We hope this discussion highlights the very serious concerns with this position of analyzing evidence when the victim has not yet personally talked with law enforcement. Careful discussions are required among law enforcement, forensic examiners, prosecutors, victim advocates, and other stakeholders to craft policies to appropriately address this complex and challenging issue.



Example: New Jersey Forensic Nurses

In June 2015, the [New Jersey Forensic Nurse Coordinators' Association](#) issued a position statement on the *Testing of Sexual Assault Forensic Evidence Kits and Patient Consent*. In it, the Association outlines their position that evidence should not be submitted for testing “without the express written consent of the patient,” when a victim has a medical forensic examination but has not yet made a decision regarding whether or not to participate in the criminal justice process. Such evidence will be stored for a period of at least five years, and only analyzed “when the patient determines that he/she is prepared to move forward with law enforcement.”

8. Provide Specialized Training on DNA

Our next recommendation is for specialized training, not only for police and prosecutors, but also for others involved in the criminal justice response to sexual assault. This is because many professionals do not fully understand the role and impact of forensic evidence in a sexual assault case, particularly as an investigative tool.

Results from the previously cited survey of law enforcement agencies certainly support this recommendation. As many as 17% of respondents said one reason why forensic evidence



would not be submitted would be an uncertainty regarding the usefulness of forensic evidence, and 2% said they were uncertain where to send it for analysis (Strom et al., 2009).

Yet training must also go beyond a basic understanding of DNA evidence to address fundamental misunderstandings about the nature and dynamics of sexual assault. This is illustrated with a quote from a police officer in a report by Human Rights Watch (2010).

Clearly, specialized training must also address the common myth that false reporting is rampant for this particular crime, and explore the implications of this misconception.

The Need for Cross-Training

In fact, specialized training is one of the most common recommendations made to improve the use of DNA evidence in sexual assault cases (OVW, 2010; Strom et al., 2009; Human Rights Watch, 2009, 2010). This is true for officers and investigators responding to sexual assault cases, but also for professionals in other disciplines (e.g., victim advocates, health care providers, prosecutors). Such cross-training can better equip these professionals to provide more accurate information to victims and improve the support they provide for victims throughout the criminal justice process.

This point was emphasized by a number of Sexual Assault Nurse Examiners (SANEs) at a meeting hosted by the Office on Violence Against Women at the US Department of Justice.

Clearly, police officers and prosecutors who are working a case are in the best position to answer the victim's questions regarding any developments in the ongoing investigation and prosecution. This includes questions about the submission of evidence to a laboratory and any resulting analysis. This information will most likely not be known by professionals outside the criminal justice system, such as community based victim advocates and forensic examiners.

SANEs noted that it would be helpful if law enforcement could inform the SANE [and advocates] of the current turnaround times and potential next steps so the SANE can convey this information to the victim. Victims may have questions about the process before, during or after the exam, and SANEs may be unsure of how to answer such questions (OVW, 2010, p. 14).

However, with the victim's consent, community based advocates can be extremely beneficial in helping to maintain communication with investigators and prosecutors, and ensuring that the victim is informed and kept apprised on the status of the case.



The National Center for Victims of Crime has posted responses to several [Frequently Asked Questions](#) for victim service providers regarding DNA. Basic information is provided about the nature of DNA evidence, its role in a sexual assault investigation, and how victim service providers can help to provide information, support, and advocacy for victims in the process. It can be found in the section of their website described as the DNA Resource Center.

Addressing Misconceptions

Both advocates and forensic examiners also provide information for victims on a wide variety of topics, including a general explanation of criminal justice procedures. They should therefore be prepared to explain both the importance – as well as the limitations – of DNA evidence. Victims will need this information while they weigh their options for how to proceed.

For example, victims often have an exaggerated sense of what DNA can accomplish, and this can affect their decision making when it comes to the medical forensic examination and law enforcement investigation. In fact, many people believe DNA testing can solve sexual assault crimes and lead directly to perpetrators being arrested, charged, and convicted. This explains why so many people are outraged at the problem of the “rape kit backlog,” as it is so often described in the media.

As we have highlighted throughout this module, DNA will rarely be sufficient to overcome the consent defense raised in the vast majority of sexual assault cases. It is certainly valuable evidence, and it can often help to advance the investigation and prosecution of sexual assault. However, DNA will never be a “magic bullet” that somehow guarantees a successful investigation and prosecution. This point can be explained to victims by forensic examiners and advocates, as well as officers and investigators.

Another common misconception is that evidence is tested directly by the forensic examiner – or submitted to the laboratory by the forensic examiner, rather than by law enforcement. Responding professionals can explain that the forensic examiner typically provides the evidence to law enforcement, and it is the investigator who determines the next steps in the criminal justice process. The investigator will thus evaluate the available evidence and submit any requests for laboratory analyses based on the assault history.⁵⁵ Responding professionals can also help victims to understand that prosecution is not realistic without active victim participation in the process of the investigation and court procedures.

Collaboration with the SARRT

Cross-training is a particularly valuable activity for any Sexual Assault Response and Resource Team (SARRT). In fact, this highlights the importance of ensuring that any SARRT includes at least one representative from the forensic laboratory. All too often, laboratories operate without meaningful interaction with the other professionals who respond to sexual assault within the community.

⁵⁵ While this is typically how the process unfolds, there is at least one exception. In some states like Texas, the forensic examiner may send the sexual assault kit directly to the Department of Public Safety for storage when a sexual assault victim has had a medical forensic examination but not yet made the decision regarding criminal justice participation. Regardless of how the protocol unfolds, however, forensic examiners are not responsible for analyzing evidence or making conclusions as to whether there is or is not probative evidence. This will need to be explained to victims because it is a common source of misunderstanding. For more information, please see Module #14 in our [OnLine Training Institute \(OLTI\)](#) entitled, [The Earthquake in Sexual Assault Response: Implementing VAWA Forensic Compliance](#).





For more information on these issues, please see Module #8 in EVAWI's OnLine Training Institute (OLTI) entitled, [Sustaining a Coordinated Community Response: Sexual Assault Response and Resource Teams](#).

9. Consider Establishing a Specialized Unit

Given the complex challenges of investigating and prosecuting sexual assault, many have called for more than just specialized training – but the creation of specialized units to handle these cases within police departments and prosecutor's offices (e.g., Human Rights Watch, 2009, 2010). It is reasonable to believe that such specialized units can help investigators and prosecutors build their expertise in this area. However, it must be clear that no specialized training or unit will be sufficient to create meaningful change unless it is supported with an entire infrastructure of strong leadership, clear policies, vigilant oversight, and accountability by supervisors. Only then will the unit have what it needs to successfully investigate and prosecute these challenging cases.

10. Ensure that All Qualifying Profiles are in CODIS

While DNA offers unprecedented capacity to help solve crimes, it will inevitably be limited by any gaps in the CODIS database. Some of these gaps were described by Dr. Angela Williamson of the Bureau of Justice Assistance (2015). First, many states have not retroactively applied their DNA collection laws to convicted offenders, which means that samples may not have been collected from felons who are currently incarcerated or on parole, or who died in prison. State laws also frequently fail to include offenders who are deemed incompetent to stand trial, found not guilty by reason of insanity, or hospitalized through civil commitment proceedings. DNA is typically only collected from hospitalized individuals at the point of release, which may never happen for many of these offenders (Williamson, 2015a). In other words, DNA is often collected only from those offenders who are deemed fit to stand trial and are ultimately convicted. This leaves out thousands of dangerous and unstable individuals whose DNA could potentially match to an unknown number of previously unsolved crimes.



Source: FBI.gov

Even in cases where a biological sample has been collected from an offender, it might never have been submitted to the laboratory for analysis, or the profile might never have been uploaded into CODIS.

Also missing from CODIS are profiles originally developed using outdated technology. As described earlier, DNA profiles produced from RFLP testing methods are not eligible for CODIS. In many cases, these samples could be retested using the PCR/STR method, but this is not typically done unless specifically requested by law enforcement (Williamson, 2015).



These factors limit the potential for DNA to solve cases that have been unsolved for years if not decades. To illustrate, the serial rapist/murderer known as the Night Stalker was believed to be responsible for 46 rapes and 10 home invasion-murders in California between 1976 and 1986. His DNA from crime scene evidence was uploaded into CODIS, but it did not hit to any suspects for years.⁵⁶

What if this serial killer/rapist had been arrested for another crime and was either paroled or died in prison without his DNA ever being taken? (Williamson, 2015a, p. 5).

Another example is the serial rapist Daniel Mark Rief who is believed to be responsible for as many as 18-22 armed home invasion/rapes in Tacoma, Washington. He is thought to have returned to rape some of his victims a second time. Yet he died in prison in 1994 without any DNA sample ever being collected (Williamson, 2015a).

It is therefore unknown how many cases could have potentially been solved if his DNA profile had been uploaded into CODIS and searched for matching cases.

California's Dead Inmate Project

As part of the solution to this problem, California passed a law to ensure that DNA profiles are submitted to CODIS for any eligible inmate who died in custody since January 1, 1983. (This was the first date certain inmates were required to provide DNA samples under California law). Known as the Dead Inmate Project, it was specifically authorized by the California Attorney General, who published an opinion stating that it is lawful for a Coroner or Medical Examiner to transfer biological samples from a deceased inmate to the DNA databank.⁵⁷

The first step in the process is reviewing state prison records, to develop a comprehensive list of offenders who should have their DNA in CODIS (Williamson, 2015b). The information then needs to be cross-referenced with state laws, to ensure that it was legal at the time of the inmate's death to upload his/her DNA profile into CODIS – based on the specific offense(s) for which the inmate was convicted (Williamson, 2015a).

As of 2008, it was determined that 18,792 inmates died in the custody of the California Department of Corrections and Rehabilitation (CDCR) before providing a DNA sample. Most of those convicted of murder, rape, and other violent offenses – who died after 1984 –

⁵⁶ Update: On April 24th, 2018, Joseph James DeAngelo was finally arrested after detectives matched a discarded DNA sample from his home to evidence from the 40 year-long investigation. The so-called Night Stalker, also known as the Golden State Killer and the East Area Rapist, is now believed to have committed at least 12 murders and over 50 rapes throughout the state of California. [After searching for more than 40 years, authorities say an ex-cop is the Golden State Killer](#). By Ray Sanchez, Elizabeth I. Johnson, Steve Almasy & Alanne Orjoux, CNN, April 27, 2018.

⁵⁷ California's Dead Inmate Project is described in detail by Anne Marie Schubert and Stephanie Hofer (2014) of the Sacramento District Attorney's Office, in an article written for the International Homicide Investigators Association. Additional information is provided in materials developed by Dr. Angela Williamson, Senior Policy Advisor with the Bureau of Justice Assistance, US Department of Justice.

are eligible for inclusion in CODIS if their biological material can be located. Generally, those inmates who died before 1984 are not eligible for inclusion in CODIS.

The second step is to locate the inmate's biological material. Sometimes it is available from an autopsy (e.g., blood card, tissue sample), or it may be stored as evidence in a case where the inmate was either named as a suspect or was a victim (e.g., while incarcerated). In some instances, the inmate's body may need to be exhumed.

The collection of DNA from dead inmates then needs to be prioritized, to make the best use of existing resources. In California, this prioritization is based on the type of sentence, with DNA collection being conducted with dead inmates in the following order:

1. Death row inmates
2. Inmates sentenced to life without parole
3. Inmates serving life sentences
4. Violent offenders
5. Sex offender registrants (Schubert & Hofer, 2014).

The benefits of this type of project can be illustrated with several case examples. In 2012, for example, investigators discovered that a blood sample had been stored from the autopsy of serial killer Juan Chavez. Chavez was serving time for robbing and strangling five men when he committed suicide in Folsom Prison in 1999 (Schubert & Hofer, 2014). When his DNA profile was developed and uploaded into CODIS, it matched with evidence from a crime scene where 60-year old Lynn Penn had been found strangled in his apartment.

Penn's homicide had gone unsolved for 22 years and would have remained so if it weren't for this initiative (Williamson, 2015a, p. 11).

In another case, DNA was finally collected from convicted rapist Rodney Halbower after nearly 37 years in prison. His profile immediately hit to crime scene evidence in several unsolved murders, including one where a mentally ill woman had falsely confessed to the crime and served 30 years in prison (Williamson, 2015a).

Based on cases such as these, Schubert and Hofer (2014) summarize the challenges and benefits of the California Dead Inmate Project.

As unlikely as it may seem on the surface, it is possible to find biological samples after a suspect has died. Often it is due to pure luck, but you will never know the satisfaction of finding that elusive sample unless you dedicate time and resources to the project. Instituting similar projects across the nation and across the world will give detectives more options for solving cold cases. Do not let the perpetrator go free just because the trail has gone cold. DNA evidence can provide answers as well as justice to victims and their families in the process (Schubert & Hofer, 2014).

Retroactive DNA Collection and Other Solutions

Another approach to this problem is the retroactive collection of DNA from prisoners. In 2011, for example, Michigan passed a law requiring DNA samples to be collected from all state prisoners by January 1, 2012. By 2011, samples were collected from almost 5,000 prisoners, and the resulting CODIS hits linked 61 prisoners to 74 crimes, including: murder, armed robbery, breaking and entering, and other offenses (Williamson, 2015a). One of these was the case of Jessica Lynn Keen, a high school student who was abducted, sexually assaulted, and beaten to death in 1991. Michigan prisoner Marvin Lee Smith was only linked with the case in 2009, when his DNA was finally collected retroactively and submitted to CODIS. He had never been a suspect in the case. With his conviction for Keen's murder, he was sentenced to an additional 30 years (Williamson, 2015a).



In addition to laws such as Michigan's to collect DNA from all prisoners in state custody, states may need to enact provisions to ensure that DNA is collected from offenders who are hospitalized through civil commitment procedures, deemed incompetent to stand trial, or found not guilty by reason of insanity. In addition, investigators can work with their laboratories to determine whether old samples that were originally tested using RFLP can be re-tested using modern technology, so they are eligible for CODIS entry. Otherwise, we are simply "throwing away available evidence that could solve rapes, murders, and other crimes" (Williamson, 2015a, p. 29).

States can also review their records to determine whether DNA has been collected from especially prolific serial offenders (Williamson, 2015b). Two high profile cases can be used to illustrate this point. First, serial killer and rapist John Wayne Gacy was sentenced to death in 1980 and executed by lethal injection in 1994. Yet his DNA was not entered in CODIS until 2011. Similarly, Ted Bundy was executed in 1989 for a series of homicides and other crimes, yet his DNA was only entered into CODIS in 2011. Offenders such as these could potentially link to numerous unsolved cases. However, this may require creative approaches if their crimes were committed before the passage of DNA collection

laws. For example, execution by the state technically constitutes justifiable homicide, so DNA profiles of executed inmates may be eligible for CODIS on that basis. The same type of logic can be applied to inmates killed in jail or prison; as victims of homicide, their DNA profiles may be eligible for CODIS even if they would not otherwise be eligible on the basis of the crimes they committed.

Additional steps can be taken to verify that DNA is collected from all qualifying offenders, and to ensure that their profiles are being uploaded to CODIS. For example, law enforcement leaders could work with the FBI to modify the National Crime Information Center (NCIC) database, so it can be updated with information on the status of DNA collection and CODIS upload. For example, criminal histories could include information about whether a suspect reference standard was collected in connection with an arrest and whether a DNA profile has been uploaded to CODIS and at what level (LDIS, SDIS, and NDIS). This could provide the structure for a centralized tracking system, so investigators across the country could have the information in one place.

The full promise of DNA to solve crime will only be achieved when the number of offender profiles available in CODIS is utilized to its full potential. Each time CODIS produces a hit in a cold case, there is an opportunity for the prosecution of additional crimes, as well as significant cost savings for law enforcement agencies investigating them. Perhaps most important, it offers a chance at desperately needed closure for victims and their families – all for the cost of about \$20-40 per offender profile (Williamson, 2015a).

11. Develop Policies and Protocols for Evidence Retention, Storage, and Destruction

At this point, we are moving beyond recommendations specifically focused on the role of DNA in a sexual assault investigation, to consider more general issues with far-reaching implications for the entire law enforcement agency and beyond. However, such broadscale reforms will be needed in addition to more focused efforts, to truly change the way in which the criminal justice system responds to sexual assault.



For example, implementing the recommendations offered here will require a number of policies and protocols regarding evidence retention, storage, and potential destruction. Decisions will need to be made regarding evidence that is analyzed versus unanalyzed, as well as cases that have been adjudicated or remain open. Many agencies are currently lacking written policies in some of these areas. This was illustrated by Strom et al. (2009), who found in their national survey of over 2,000 law enforcement agencies that fewer than half had “a policy in place for preserving biological evidence for cases in which the defendant is found guilty.” In addition, “about one in five agencies reported they were unsure if their agency had such a policy or not” (Strom et al., 2009, p. xvi).

Creating Policies and Protocols

To begin, a policy or protocol on evidence retention should provide definitions for a number of essential concepts and then offer detailed guidance for procedures such as the following:

- Property tracking
- Inspections
- Inventories
- Storage
- Chain of custody
- Special handling and packaging requirements
- Bio-hazardous material
- Refrigeration and freezing
- Sexual assault forensic evidence kits
- Drug and alcohol facilitated sexual assaults
- Laboratory analysis
- Case status and evidence disposition
- Court ordered release
- Evidence property disposal guidelines
- Misdemeanor evidence
- Requests for evidence disposition
- Evidence and property release guidelines



Policy development must also take into account any existing state laws governing evidence retention laws, as well as the statute of limitations for various crimes and time limits for challenging a conviction. Policies should also address the many benefits of retaining the evidence beyond prosecuting the case, which include the potential for re-testing in the future, providing answers for victims, and identifying offenders even when the case cannot be prosecuted (e.g., because the statute of limitations has expired).

Storage Guidelines in Various Circumstances

Law enforcement agencies will need to carefully specify how long evidence will be stored under various circumstances. General policies will already be in place for evidence retention in all criminal cases, in accordance with state laws and other guidance. However, for sexual assault cases, there are a number of specific considerations based on the unique dynamics of these cases, including victims who at some point after their initial report decline to participate in the investigative process.

Specific considerations include situations where the crime constitutes a misdemeanor versus a felony, when the prosecutor has charged versus rejected the case, and when the victim has declined to participate in the investigation, either before or after the suspect has been identified. For example, some cases are initially rejected for prosecution, but later revisited if new information develops or when the perpetrator re-offends and criminal charges are filed in the series of cases. Evidence retention guidelines will also need to address situations where there is an active warrant or the report has been unfounded – either because it is false or baseless (i.e., lacking the elements of the crime).

These issues are best discussed with multidisciplinary partners involved in sexual assault response, to ensure that evidence retention policies are consistent with state law and other relevant guidance – as well as the unique dynamics and considerations of sexual assault cases. Any community response protocols will also need to reflect these policies and practices. For example, victims must be provided accurate information about how long evidence is stored, when it will be destroyed, and whether or how they will be notified as the timelines for destruction approach.



Model Policy Materials on Evidence Retention

As part of the development of this module, we have created [Model Policy Materials for Evidence Retention and Disposition and/or Removal](#) for law enforcement agencies to adapt for their own use. It is provided in its entirety in the Appendix of this module. The document provides sample language for an agency policy, as well as instructional commentary and supplemental materials. It can therefore be used as an educational tool as well as a resource to assist in the development of policies, protocols, and training materials in the area of evidence retention.

One particular innovation is seen in the fact that the model policy addresses questions of evidence retention in cases where the report is unfounded, where the victim has declined to participate in the investigation or where the prosecuting attorney has rejected the case due to insufficient evidence or other reasons. Current evidence policies rarely address these issues and the unique dynamics involved in sexual assault investigations. The model policy can also be helpful for forensic examiner programs to evaluate whether any evidence stored at the medical facility is meeting recommended practices.

Also included with the model policy is a summary of evidence retention laws in the US. Other resources include two sample [Evidence Retention Grids](#), and two sample [Evidence Disposition Forms](#), as well as a glossary of terms related to DNA testing and evidence retention. These are all available in the Appendix of this module.

Collaborative work will be needed to establish and improve such evidence retention policies, to ensure that evidence in sexual assault cases is being stored as long as possible – at least for the statute of limitations and – ideally – indefinitely for those sexual assault



cases that remain unsolved. This is also critical for associated evidence such as clothing and bedding in a sexual assault case, because this evidence will be needed if the results of the evidence kit are negative. This may mean that law enforcement agencies will need to expand their storage capacity and evaluate ways to maximize storage. For example, blood and urine can be refrigerated separately, thereby allowing other items from the evidence kit, along with the clothing, to be stored in a controlled environment that is not refrigerated.

It is also critical that the Records Division maintains the relevant reports for the same period of time, because evidence has little to no value without an accompanying report. All of these issues should be reflected in agency policies for evidence retention, in accordance with state law and the statute of limitations for various criminal offenses.

Destruction of Evidence

Evidence retention policies also need to address the question of how long to store evidence after it has been screened and/or analyzed. This is an issue that is often overlooked or misunderstood, because some of the evidentiary kits stored in police property rooms do not actually constitute a “DNA kit backlog” or even unanalyzed evidence; they may have been submitted to the laboratory for analysis and then returned to the property room for long term storage after the preliminary analysis was completed.



The [Biological Evidence Preservation Handbook](#) also offers detailed guidance for crafting evidence retention policies and procedures. Again, it is available from both author organizations (the National Institute of Standards and Technology and the National Institute of Justice) and also archived in the EVAWI Resource Library.

The scenario often unfolds like this: First, one or more items of evidence are submitted to the laboratory for analysis. However, only a portion of the evidence may actually be screened and analyzed (e.g., a section of clothing is cut out, or a few swabs are tested). If additional evidence or material is needed, the laboratory will request it from the investigator or property room. Following the analysis, the evidence is generally returned to the property room to be stored – or it is destroyed, in accordance with state laws and the agency’s policies and procedures.

In this type of scenario, investigators will often experience significant pressure from their supervisors and the property room custodian to sign off on the destruction of evidence, in order to clean up property tags and free up storage space. In fact, this may even be an aspect of their performance evaluation. Detectives are sometimes explicitly evaluated on whether or not they have purged a certain number of items of evidence, rather than a more general assessment of whether they manage cases appropriately by evaluating the retention and destruction of evidence in a timely manner.

The path of least resistance is often to simply go along with these requests, because it takes time and effort to justify continued storage of evidence. This is particularly true when the investigator originally assigned to the case is no longer serving in that role (because of

retirement, transfer, etc.). The new investigator will typically not be as personally invested in the case, and this increases the likelihood that she/he will go along with the request and sign off on evidence destruction.

Investigators may also misunderstand how CODIS functions, thinking that if an initial search of CODIS yielded no match to an offender, then the evidence can be disposed of. Yet CODIS searches are not one-time searches; they occur once a week for an indefinite period of time, with each new search containing all the offender profiles added to the database since the last search. Thus, searches in some cases may be fruitless for several years and then eventually produce a match.

Of course, the risk is this: Once the evidence is destroyed, you can never get it back. Destruction eliminates the possibility of conducting additional analyses, if confirmation testing is needed, or if the investigation reveals alternative strategies that could yield probative findings, or if advancing technology creates new possibilities for testing.

Sample Scenarios

To illustrate the potential risks involved, imagine a scenario where an item of clothing is submitted to the laboratory, and a stain is cut out for screening and analysis. A foreign DNA profile is developed and entered into CODIS, but no match is found at the time. There may be biological evidence elsewhere on the clothing, or information uncovered during the follow-up investigation may suggest that additional analysis of the clothing could potentially be valuable. New technologies and methods such as Y-STR analysis may also offer the potential to conduct additional testing, because it can be used in scenarios where traditional DNA typing technologies could not.

It is also possible that a CODIS match will be made later, but further investigation might reveal that the donor was actually a consensual partner rather than the suspect. This might happen when the consensual partner's DNA profile was not excluded at the time of the original investigation, and this scenario becomes increasingly likely as the sensitivity of DNA testing continues to improve.

As these scenarios illustrate, there are many possibilities and challenges that arise in cases months and years later – that do not come up during the initial investigation. These issues can only be best addressed if the evidence from the original investigation remains in storage. Yet all too often, clothing and other associated evidence has already been destroyed. For all of these reasons, we recommend that evidence is stored as long as possible – at least until the statute of limitations has expired, any litigation is complete, and any potential appeals have been exhausted. We certainly discourage the practice of evaluating detectives based on whether they purged a certain number of evidentiary items.

“John Doe” Warrants

Even in states that still have a statute of limitations for felony sexual assault, the evidence in a sexual assault case may still be used to issue a “John Doe” warrant or indictment. This is a valuable tool, because CODIS hits are in fact quite common for cases outside the

statute of limitations.⁵⁸ John Doe warrants use DNA profiles instead of names to specifically identify an individual and file a case within the statute of limitations. Once the warrant is issued, the statute of limitations is typically suspended until the suspect is arrested. However, prosecutors might also be able to have the statute of limitations extended if they can show that the suspect fled prosecution by leaving the state. These exceptions allow for the possibility of prosecuting a sexual assault offense when the suspect's identity is definitively established and linked with the DNA profile developed on the basis of evidence in the case, and the suspect is arrested. This is an issue that will continue to evolve over time as technology, case law, and law enforcement practices advance.



The [National Center for Victims of Crime \(NCVC\)](#) offers a variety of information about the statute of limitations for sexual assault crimes in each US. state and territory. In a series of *charts* offered in their [DNA Resource Center](#), information is provided not only on the statute of limitations for sexual assault offenses, but also for any DNA exceptions (e.g., if a warrant can be issued on the basis of the suspect's DNA rather than a name or other identifying information).

NCVC also offers two reports on this topic, among their other [DNA Resources](#). One is entitled, [Increasing Victim's Access to Justice: The Statute of Limitations and the Prosecution of Sexual Assault Cases](#). A second paper seeks to address the question: [Why Test Rape Kits After the Statute of Limitations has Expired?](#)

While the practice of issuing a warrant based on a DNA profile may sound unusual to some professionals, the reality is that the DNA profile used for a John Doe warrant is more specific than a traditional name. Individuals involved in criminal activity often operate under a number of different aliases. In other words, they may change their name to conceal their identity, but they can't change their DNA.⁵⁹ All of this means that the trend is to store evidence for longer periods of time, because it may need to be analyzed or re-analyzed at some point in the future, as circumstances warrant.

12. Establish a Computerized Tracking System

As part of the larger effort to improve tracking of evidence by law enforcement agencies and laboratories, there is a particular need for computerized information management systems designed to record the status, progress, and outcomes of all reported sexual assaults and their associated evidence. Many sex crimes investigators currently rely on their agency's records management system which is unlikely to be sufficient for this purpose. This is problematic, particularly given the high level of turnover so often seen among sex crimes investigators. When new investigators are assigned to a case, they frequently have little or no idea what steps might have already been taken.

⁵⁸ To illustrate, as part of the Detroit SAK project, 173 DNA profiles were entered into CODIS from cases that were presumed to be outside the statute of limitations, and 90 (52%) resulted in a CODIS hit (Campbell et al., 2015).

⁵⁹ This argument was made in the majority opinion of the US. Supreme Court in [Maryland v. King 569 US, 133 S. Ct. 1958 \(2013\)](#).



In fact, improved tracking is one of the most common recommendations for the problems associated with forensic evidence in police departments, forensic laboratories, and other criminal justice agencies (McEwan, 2011; OVW, 2010; Peterson et al., 2012; Human Rights Watch, 2009, 2010).

Law enforcement desperately needs information management systems that will allow them to better track evidence from sexual assault cases that are stored in property rooms and warehouses (OVW. 2010. p. 21-22).

This need extends beyond sexual assault cases, but it has been particularly challenging in this area given the number of unanalyzed evidence kits as well as the need to store a wide variety of associated evidence. The issue was therefore highlighted in the previously described survey of 2,250 law enforcement agencies, which found that over 60% had no computerized system for tracking evidence (Strom et al., 2009). The authors concluded that this needed to be remedied, by enhancing law enforcement information systems so they can “systematically track and monitor forensic evidence associated with criminal cases” (p. xv-xvi).

Whether commercially purchased or developed in-house, a comprehensive tracking system can allow members of the police department, prosecutor’s office, and laboratory to share information. This helps to ensure that there is accountability when the case elements and information justify taking appropriate action – for example, when a cold case hit is revealed. In fact, there is no other way to achieve technical accountability for CODIS hits and follow-up without a robust information management system.

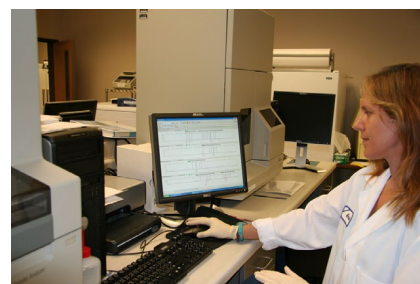

Photo credit: CaliforniaDFW /Foter.com / CC BY

One particularly innovative effort has been seen in Detroit, as part of their Sexual Assault Kit (SAK) Action Research Project (ARP). As part of a project funded by the National Institute of Justice, the multidisciplinary collaborative team in Detroit worked to develop a partnership with UPS in order to track their evidence using bar codes.

A recurring challenge in the Detroit SAK ARP was the lack of information management and tracking of SAKs from the point at which they were collected by a health care provider and released by the victim for retrieval by law enforcement, to when they were submitted for testing, to when the testing had been completed. Whereas building new IT infrastructure is a key long-term goal of many organizations involved in this project, a more immediate action step was taken by the prosecutor’s office to secure funding for a pilot SAK tracking project.

All Michigan SAKs now have a bar code on the outside of the box, but to date, no municipalities or law enforcement jurisdictions in Michigan have the infrastructure for tracking kits (and no state-wide tracking system exists either). The prosecutor’s office formed a partnership with United Parcel Service (UPS) to develop and implement a pilot tracking project for Detroit SAKs (Campbell et al., 2015, p. 346).

Such a system could be used by law enforcement agencies as well as laboratory personnel and prosecutors, to track the physical location of evidence and its testing status. However, it could also be used to record the outcomes of cases, in terms of investigations, arrests, charges, prosecutions, dismissals, convictions, and exonerations (Human Rights Watch, 2009, 2010). This could potentially help all of the relevant stakeholders to understand what happens to cases as well as analyzing what factors are associated with one path versus another. For example, data could be captured to understand why a decision is made in a particular case not to submit evidence to the laboratory for analysis (Ritter, 2012).



As part of the [Biological Evidence Preservation Handbook](#), the Appendix provides detailed information on evidence tracking and management systems (pages 46-50). Specifically, Appendix A outlines the functions, capabilities, and reports to be considered when acquiring a new system. The table was adapted from *Property and Evidence by the Book* (Latta & Bowers, 2011).

To ensure that these goals are met, all of the relevant stakeholders should be involved in the process of determining what information is recorded in the database. This can be accomplished using a multidisciplinary advisory committee, which increases the transparency of the decision-making process and facilitates evaluation of the quality of investigative and forensic services (McEwan, 2011; Ritter, 2012).

Database Systems: Phoenix Example

Some agencies have already developed a database to track information on sexual assault cases. One example is the Phoenix Police Department. Their system is referred to as Sex Crimes Analysis and Tracking (SCAT), and it functions primarily as an information management system for investigators. It was designed for use by a large police agency with the need to track a high volume of cases – not only rape and sexual assault but also other sexually motivated crimes including kidnapping, indecent exposure, voyeurism, trespassing, burglary, etc. The system is based on Microsoft Access software, and it includes a number of critical data fields.

The following screenshot shows the Home Screen for the SCAT database system. The orange buttons on the right show the various categories of information that can be captured in data fields on additional screens. This data must be entered by hand; the fields are not populated automatically.

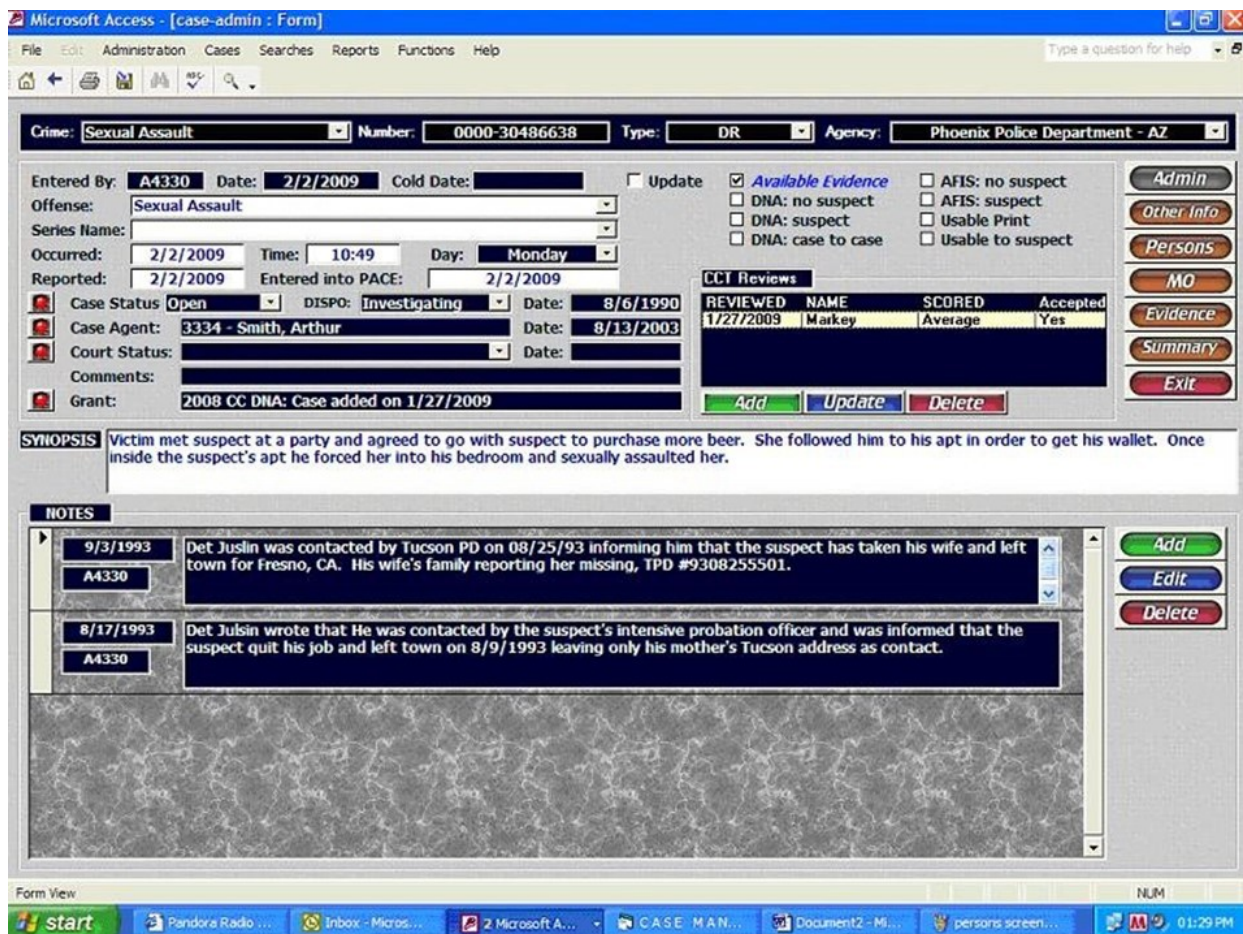

SCAT Software System: Home Screen
Courtesy of Detective Sergeant Jim Markey (Retired, Phoenix Police Department)

The next screenshot captures more detailed information about the evidence, which allows investigators and supervisors to track the status of the sexual assault kit and other evidentiary items. This type of database system can go a long way toward helping agencies improve their tracking and record keeping.

The screenshot displays the SCAT Software System interface. At the top, the title bar reads "SCAT - [Evidence Data]". Below it is a menu bar with options: File, Edit, Administration, Cases, Searches, Reports, Functions, Help. A search bar contains the text "Type a question for help".

The main interface shows a case summary: Crime: Sexual Assault, Number: 2007-72124423, Type: DR, Agency: Phoenix Police Department - AZ. Below this are buttons for "EVIDENCE" (Add, Edit, Delete) and "TESTS" (Add, Edit, Delete).

EVIDENCE Table:

ITEM	TYPE	DESCRIPTION	COMMENTS	S	C	T	L
1	Sex Kit	Sex kit		X	X	X	
2	Clothing	Clothing					
3	Misc	Electrical cord		X			

TESTS Table:

TEST	STATUS	DATE	REQUEST / RESULTS
Screening	Submitted	11/19/2007	process for biological evidence.
Screening	Completed	1/28/2008	DNA located on breasts.
CODIS	Completed	1/28/2008	entered into codis.
CODIS	Update	5/1/2008	DNA match to two Mesa PD Homicides and 1 Mesa Sex Assault
Toxicology	Submitted	11/19/2007	process for BAC/Drugs.
Toxicology	Update	11/28/2007	no ethyl alcohol detected, acetone indentified

SCAT Software System: Home Screen
Courtesy of Detective Sergeant Jim Markey (Retired, Phoenix Police Department)

Database Systems: San Diego Example

Another system was created in San Diego County. The San Diego Police Department and the San Diego Sheriff's Department (each of which has a similarly-sized DNA laboratory) produced 800 - 1,000 cold hit identifications where a forensic unknown has been linked to an offender in the CODIS database. However, evaluation revealed that a significant number of hits (including some from sexual assault cases) were never followed up – even though a name had been provided to law enforcement. This is a problem that has been seen in other law enforcement agencies across the country.

To remedy the situation in San Diego County, the Police Department and Sheriff's Department worked with the District Attorney's Office to construct a database populated with each cold hit identification. The system is designed to track each hit and then record any action on the part of an investigator or prosecutor, culminating either in a prosecution or case closure for a valid reason. The database now offers a means of ensuring that action is taken on each of the hits produced by the laboratories.



Originally created by the Information Technology Division, the existing Case Management System (CMS) was modified to electronically track information on all CODIS hits directly from the two crime laboratories. This information is uploaded on a bi-weekly basis, and as of March 2015 it included over 5,200 CODIS hits. Each CODIS hit then shows up as a separate line item in the Case Management System (known as CODIS Integration) offering the ability to effectively manage, mine, and track this voluminous data. For example, the system can generate various reports for supervising prosecutors to track and manage the CODIS hits.

The CODIS Integration project sends automated email notifications to prosecutors who may be prosecuting a defendant on other cases (or have prosecuted that defendant in the past) to alert them of any new or open CODIS hits. The program also emails detectives to check on the status of open hits to ensure that there is follow-up by law enforcement.

In addition, if a suspect is charged with a serious new crime (or even a minor crime, such as petty theft or DUI), the CODIS Integration Project will automatically notify the prosecutor issuing that case that the defendant has at least one open CODIS hit on another case. The project even offers the potential to discover a possible wrongful conviction, because it will notify prosecutors if the person named in the DNA hit is different from the person who was prosecuted in the case.



Example: CODIS Hit Outcome Project (CHOP)

Another example of a computerized tracking system is the CODIS Hit Outcome Project (CHOP) originally developed by the California Department of Justice. For example, the Louisiana State Police Crime Laboratory installed CHOP on their servers, with connections to both the New Orleans Police Department and New Orleans District Attorney's Office. While CHOP is not as comprehensive or integrated as the San Diego system described above, it is available in two versions. "A stand-alone version (such as the one used in the New Orleans project) can be purchased from a software vendor. Another version – upgraded from the California Department of Justice, which developed the original software – is available to state laboratories at no charge" (Ritter, 2012).

Implementation of the database has led to significant improvement in the level of follow up for cold hit identifications. It also guarantees that prosecutors make charging decisions based on all cases associated with a particular defendant through DNA. The current plan is to add latent print identifications to the database for similar reasons.

Although we have described this database in terms of CODIS offender hits, a similarly designed program could gather and track a broad range of information on every sexual assault case and have far-reaching impacts on how they are handled. In fact, this impact could extend beyond sexual assault to any type of case included in the system.



13. Collect Data on Case Processing and Outcomes

With improved case management and tracking, it may be possible to better understand the decision making process used by investigators to determine whether evidence will be submitted to the laboratory in a sexual assault case – as well as the specific analyses that will be requested (OVW, 2010).

This will help document the progress and outcomes of individual cases, including the location and status of evidence. However, it also has the potential to inform the field about the probative value of various types of evidence and their impact on sexual assault cases:

The effects of forensic DNA testing on sexual assaults cannot be accurately estimated until there are better data maintained by all the various agencies in the criminal justice system handling sexual assault cases ...

A range of quantitative and qualitative data are needed from investigators and prosecutors, in particular, to determine the value of scientific evidence in securing arrests, filings, convictions, and sentencing. The quantitative data would collect basic discrete factors on every sexual assault case, its investigation, prosecution, adjudication and sentencing.

Qualitative data would include the persuasiveness of various factors that influenced arrest, charging, plea bargaining, trial verdict (including interviews with jurors after verdict), and sentencing (Peterson et al., 2012, p. 106).

On an individual level, investigators could use such data to guide their review of specific case facts and to request laboratory services that would be more likely to advance the investigation, either by excluding a suspect or prosecuting an offender. In other words, they can help investigators and prosecutors to “work smarter” by prioritizing the evidence they submit to a laboratory for analysis.

To provide a sense of what this might look like, we return to an example of research that has already been mentioned, in the study conducted by Cain (2002) with the San Diego Police Department.

Example of Data Analysis

Cain’s research was conducted with 77 sexual assault cases with evidence analyzed between 1998 and 1999. Data was recorded on the individual pieces of evidence examined, including evidence collected during the forensic examination of the victim and/or suspect – such as swabs taken from various parts of the body, vaginal aspirate, finger swabbings, fingernail scrapings, hair cuttings, and other items (e.g., tampon, sanitary pad, penis ring). Other types of evidence were associated with either the victim and/or suspect, such as clothing, bedding, and condoms, as well as other objects (e.g., carpet, sofa, rug, wall sample, sleeping bag, car interior, bottle, tissue).

For each individual piece of evidence examined by a forensic scientist, Cain tracked the results. This included recording whether semen was found when the particular evidence item was screened, whether DNA work was performed, and whether the suspect was included as a result of the DNA profile developed. Similarly, data tracked whether blood or epithelial cells were found, whether DNA work was performed, and whether the victim and/or suspect was included as the source of the blood or epithelial cells. Two of Cain's original data tables are provided below, to illustrate how the information might be presented:

1998 AND 1999 SDPD CRIME LABORATORY WORK - 51 FEMALE ADULT SEXUAL ASSAULT CASES (AGES 18+)											
Crime Scene Evidence Associated with the Victim	Individual Pieces of Evidence Examined	Total #	Semen Found	DNA Work Performed	Suspect Included	Blood Found	DNA Work Performed	Suspect Included	Epithelial Cells Found	DNA Work Performed	Suspect Included
Victim's Clothing:	-Women's Underwear	25	10	3	1	6	1		1		
	-Pants/Jean/Shorts/Skirt	14	4	4	1	2					
	-Shirt/Blouse/Sweatshirt	7	1			1					
	-Bra	4									
	-Men's Underwear (i.e. Briefs, Boxers)	1									
	-Dress	1	1	1							
	-Swimsuit	1	1	1							
	-Jacket	1	1	1							
	-Hospital Gown	1									
	-Shoes	1									
Combined Total:		56	18	10	2	9	1	0	1	0	0

Suspect Included=The known suspect is included as a possible contributor of the semen, blood, or epithelial cells found on the individual pieces of evidence that received DNA analysis.

1998 AND 1999 SDPD CRIME LABORATORY WORK - 51 FEMALE ADULT SEXUAL ASSAULT CASES (AGES 18+)											
Evidence Associated with the Suspect	Individual Pieces of Evidence Examined	Total #	Semen Found	DNA Work Performed	Suspect Included	Blood Found	DNA Work Performed	Victim Included	Epithelial Cells Found	DNA Work Performed	Victim Included
Forensic Examination: (Conducted at SDPD)	-Penile Swab	10	5	8	7	1	1	1	3	3	3
	-External Body Swab	6				2	2	2			
	-Fingernail Scrapings	7		4	1						
	-Penis Ring	1	1	1	1						
	-Pubic Swab	1		1							
Combined Total:		25	6	14	9	3	3	3	3	3	3

Suspect Included=The suspect is included as a possible contributor of the semen found on the suspect's evidence. This is done to show that the semen does match the known suspect.

Victim Included=The victim is included as a possible contributor of the blood or epithelial cells found on the individual pieces of suspect evidence that received DNA analysis.

For agencies seeking to record and analyze such data, a number of recommendations are offered. First, it is important to keep in mind the importance of specific case facts in evaluating both analyses and results. Cain separated out the results for adolescent and adult victims, because this assessment might reveal important differences. It is easy to imagine how additional characteristics of the victim, suspect, and assault history could be used to evaluate whether there were meaningful patterns in the type of evidence analyzed and the results produced.

One variable that would be particularly important to track is the type of sexual assault reported and then recorded in the crime report. There is a very significant difference, for



example, in the analyses and results that might be expected in a case involving sexual contact versus penetration. If the case involves only contact, it might not make sense based on the history of the assault to screen the evidence using a microscope or acid phosphatase. These screening methods will likely produce a negative result, because even if there was biological material present, they would not likely be able to detect it. With trace amounts of biological material, other screening methods such as Y-screen might be more productive.

Similarly, there would be a different assessment of the evidence in a case where the sexual assault was reported immediately versus after a significant period of time, or in a case involving an attempted versus a completed sexual assault. These are only a few examples of the type of assessment we have described throughout this module, where an evaluation of evidence should be based on the specific facts of the case and the unique assault history.

Defining Success

This type of data analysis can be used to help “work smarter” in individual cases, by helping investigators know what evidence they might be looking for and where they are most likely to find it. On a larger level, a cost-benefit assessment could be conducted to compare the outcomes of various strategies such as “test all kits” versus prioritizing the analysis of cases based on certain specific criteria. While conducting such an analysis, however, it is important to remember that criminal justice outcomes – e.g., convictions – are not the only ones that matter.



The [Final Report](#) for the Detroit SAK project contains helpful guidance for multidisciplinary professionals undertaking evaluation research in the area of sexual assault response. All of the data collection instruments are provided in the Appendix, including the interview protocols, coding sheets, focus group protocols, and other materials. Also provided are the following resources to help convey the “lessons learned.”

Lessons Learned: Conducting an Action Research Project (p. 328-330)

Moving Forward: Changing SAK Policy and Practice (p. 347-348)

The report can be accessed from the [National Criminal Justice Reference Service](#).



In other words, convictions should never be seen as the only measure of success. There are also other goals for submitting forensic evidence for analysis, such as populating our DNA databases, linking cases together, and assisting in the investigation and prosecution of other cases – as well as exonerating the innocent. Extending our lens even wider, there are also broader goals of treating victims and their loved ones with respect and fairness. At the end of the day, criminal justice professionals cannot always be held accountable for the specific outcome in a particular case – but they are always responsible for the way they respond to victims and their support people.

Researchers and policymakers should be cautioned against relying exclusively on imperfect performance measures, such as successful convictions, given the numerous ways cases can be resolved in the legal system (OVW, 2010, p. 26).

14. Invest in Forensic Laboratories

Returning to longer-term strategies for improving practices in this area, one fundamental recommendation is to invest in forensic laboratories, to expand our nation's capacity to analyze DNA evidence. This is perhaps best illustrated in Detroit, where a desperate shortage of laboratory resources crippled that community's ability to analyze evidence in sexual assault cases (Campbell et al., 2015).

This need was also echoed in the national survey of law enforcement agencies that was previously discussed (Strom et al., 2009). When respondents were asked to provide reasons why forensic evidence might not be submitted for analysis in an open case, 11% cited the concern that they would not get a timely result, 9% referred to insufficient funding, and 6% said the laboratory was not accepting new evidence because of a backlog at their facility. All of these factors point to a need for continued investment in forensic laboratories across the country.

Rationing Laboratory Resources

Any imbalance in the supply and demand for laboratory resources will limit their potential for meaningful impact on the investigation and prosecution of criminal cases, including sexual assault. This creates a situation where investigators and prosecutors strategically ration their requests for services from the laboratory. This process is poignantly described by a detective in the Human Rights Watch (2010) report.

If the evidence is absolutely crucial to making the case, I will beg the crime laboratory to test the kit, and put it closer to the top of the pile. But if I am not sure the rape kit test will add anything to the case, I will save up my favors with the crime laboratory for another case (Human Rights Watch, 2010, p. 33).

Many people have echoed the call for increased capacity, personnel, and training for the nation's forensic laboratories (e.g., Strom et al., 2009). Yet one challenge is retaining high quality personnel, because the state crime laboratories often cannot compete with the

private laboratories in terms of pay and other benefits. Fortunately, funding has been increasingly dedicated to this task over the past decade. As one illustration, Illinois has invested considerable resources in their state crime laboratory system in the wake of legislation requiring that all sexual assault evidence kits be submitted for analysis. Since the law passed, Illinois has seen an average of 60 more evidence kits submitted per month. This translates to 720 more evidence kits per year than was submitted on average before the legislation. Illinois has also reduced the time required to complete the analysis, from an average of 6-9 months to 3-4 months (Reiss, 2012).

Standardized Evidence Kits

Another investment could be the development of a standardized evidentiary kit for medical forensic examinations on a statewide, or even national level. This has the potential to standardize and improve evidence collection, but also facilitate communication with the laboratories. Of course, the development of any such evidentiary kit will require input from the range of multidisciplinary professionals involved in sexual assault response, including representatives from law enforcement, prosecution, health care, victim advocacy, and forensic laboratories.

15. Improve DNA Technologies

There have been a number of innovations in technology that have greatly aided forensic laboratories in seeking to become more efficient all largely designed around “doing things faster” and “removing the human from repetitive tasks.” These include the use of robotics for tasks such as sampling, DNA extraction, and human pipetting – all of which occur at a number of junctures during DNA testing.⁶⁰

In addition to performing these tasks faster, robots are more consistent and limit the possibility of human error, and they free the analyst to perform more complex tasks such as screening crime scene evidence and interpreting DNA testing results. DNA interpretation can be quite complex, and software is now available from commercial vendors that can help speed up the interpretation process.

⁶⁰ Although local and state funding is critical to the operation of DNA laboratories throughout the country, their funding contributions are sometimes limited to carrying the burden of salaries and basic laboratory operating costs. In contrast, formula and competitive federal grants administered through programs from the National Institute of Justice have fostered much of the innovation among laboratories. These competitive grants have been awarded to laboratories seeking new methods for improving testing, with the goal of sharing these novel procedures with other DNA laboratories. Formula grants have also been designed to seek improvements in productivity to yield reduced backlogs, and an increase in the number of forensic unknown and offender profiles in CODIS. In other words, a competitive grant might be awarded to a research laboratory working on a DNA extraction technology designed to replace the 2-hour process of phenol-chloroform purification with magnetic bead purification which takes 30 minutes. A formula grant, however, might allow a government DNA laboratory to seek the expertise of a consultant to process-map the entire DNA testing process, to seek the means of eliminating poor workflow strategies. This was the type of analysis undertaken by the Louisiana Crime Laboratory using a Lean Six Sigma approach (Richard & Kupferschmid, 2011).



Better, Faster, Cheaper

The evolution of technology has also allowed laboratory personnel to conduct DNA testing at exponentially faster speeds. To illustrate, capillary electrophoresis instruments serve as the platform for producing a final DNA profile. The Model 310 is a first-generation instrument still in use in some DNA laboratories. It has the ability to analyze approximately 48 samples in a 24-hour period. The Model 3130 Avant is a newer version that is common in many laboratories; it can analyze 192 samples in a 24-hour time period. However, the Model 3500 is the latest version of a capillary electrophoresis instrument, and one variant has the ability to analyze nearly 800 samples in 24 hours. This pace would have been unthinkable when the technology for DNA testing was originally developed.

Innovation and an emphasis on productivity have enabled DNA laboratories to analyze a dramatically greater number of cases while maintaining a similar number of employees. This success has resulted in two important trends. The first is that DNA testing has become less expensive.

Where the earlier technique of RFLP testing might have cost \$1,500 a sample, a more automated, PCR-based test might be completed for \$350. The dramatic reductions in cost have also had a second effect, which is to make DNA testing more widely available to law enforcement agencies and used in a broader scope of criminal cases. The example of the San Diego Police Department is instructive on this count.

In 1990, DNA testing would have been outsourced by the San Diego Police Department to a commercial DNA laboratory at great expense. As a result, only the highest profile sexual assault and homicide cases received consideration for DNA analysis. In contrast, the agency is now able to conduct all of its own testing on nearly 2,000 cases a year. Remarkably, 60% of the cases now analyzed are routine burglaries and robberies. This has proven to be important in solving sexual assault cases, because offenders frequently re-perpetrate across a broad range of crime types.

Rapid DNA Testing

One particularly exciting innovation is Rapid DNA Testing. The technology has been developed by multiple companies including [GE Healthcare Life Sciences](#) and [IntegenX](#). As described on the website for GE Healthcare Life Sciences.

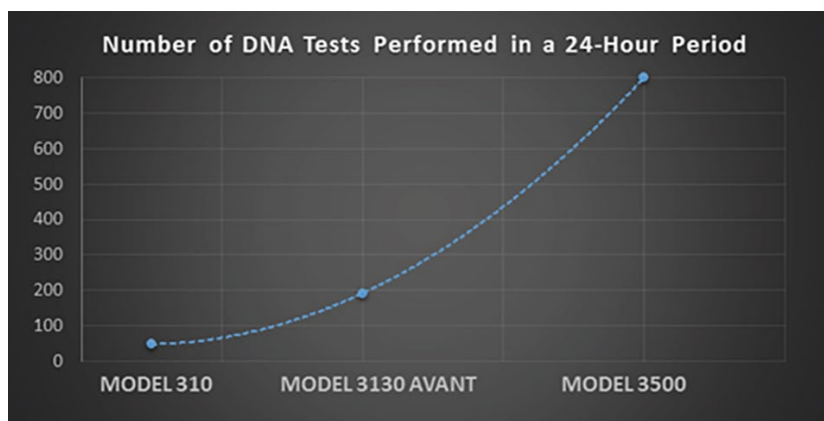

Rapid DNA Analysis System is a tabletop system that provides CODISquality DNA types. It produces DNA types in less than 85 minutes by combining and automating four laboratory processes: DNA purification, amplification, separation/detection, and allele calling using an Expert System. The system features a single-use, self-contained cassette called DNAscan BioChipSet Cassette which contains all the reagents and materials needed to perform each reaction.

DNA typing of known arrestee/offender reference samples allows searching and comparison of these known reference samples to DNA databases that contain forensic samples; helping law enforcement solve crimes, convict offenders, and exonerate the innocent. Traditional DNA typing processes require several pieces of laboratory equipment that need specialized laboratory space, highly trained personnel, and can take hours, weeks or months to test samples. Rapid DNA technology reduces time-to-results and is designed for both technical and non-technical personnel.⁶¹



Photo Credit:
Joanne Archambault

To illustrate how this technology might be utilized by law enforcement, the Arizona Department of Public Safety purchased the equipment (at a price tag of approximately \$250,000 per unit). Rapid DNA units were placed in LDIS laboratories in Phoenix and Tucson, and law enforcement agencies were given the option to send their personnel for training to be qualified to use the equipment. Once they have trained personnel, participating agencies are charged a total of \$1,800 per test. There is also a smaller handheld unit that can be purchased by agencies for use in the field, illustrating how DNA testing will likely become faster and immediately accessible for law enforcement.

The US. Congress has stated their support for the development of Rapid DNA technology, in a report by the House Appropriations Committee:

The FBI established the Rapid DNA Program Office in 2010 to develop and integrate instruments for law enforcement use, and provided guidelines for use of Rapid DNA instruments in accredited laboratories. The Committee is also aware that such technology is currently limited to use at accredited laboratories, where results can be uploaded to the FBI Combined DNA Index System database. The committee urges the FBI to explore ways to develop this capability for application to intake, processing, booking, detention, and incarceration stages, and to recommend to Congress any legislation that may be required to facilitate such implementation.⁶²

It is anticipated that efforts such as these will encourage the expanded use of Rapid DNA technology, specifically for law enforcement purposes in the US.

⁶¹ Information drawn from the website for the [GE Healthcare Life Sciences](#).

⁶² Report by the [Committee on Appropriations](#) on the bill specifically making appropriations for Commerce, Justice, Science and related agencies for the fiscal year ending September 30, 2015.

Forensic DNA Phenotyping

Some of the other innovations in DNA technology would have been even more unthinkable in the past. For example, phenotyping technology (such as [Snapshot](#)), can be used to estimate the physical appearance and ethnic origin of a suspect based only on genetic information. In a process referred to as forensic DNA phenotyping, DNA is essentially used to generate a composite sketch.

While this technology is not currently precise enough to identify a suspect with any degree of certainty, it can be extremely helpful for excluding suspects. As of 2013, however, Texas was the only state that has expressly authorized the use of forensic DNA phenotyping (Murphy, 2013).

For a description of the first DNA-phenotyped image of a “person of interest” in a double homicide case, please see the article published in [Forensic Magazine](#). The article included the following images and text.

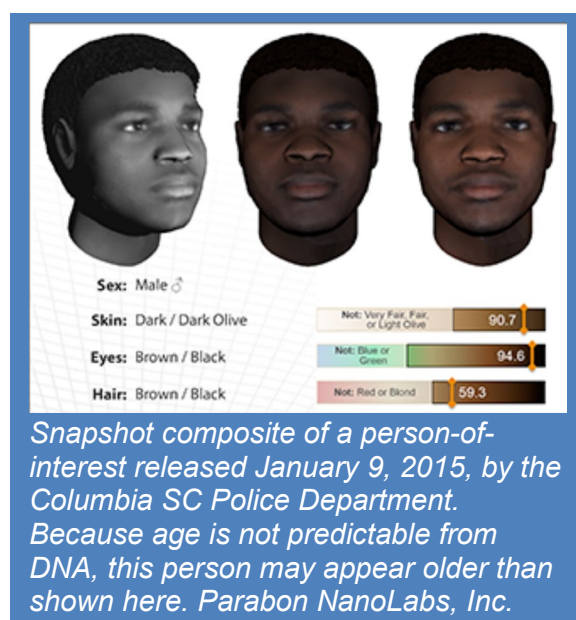
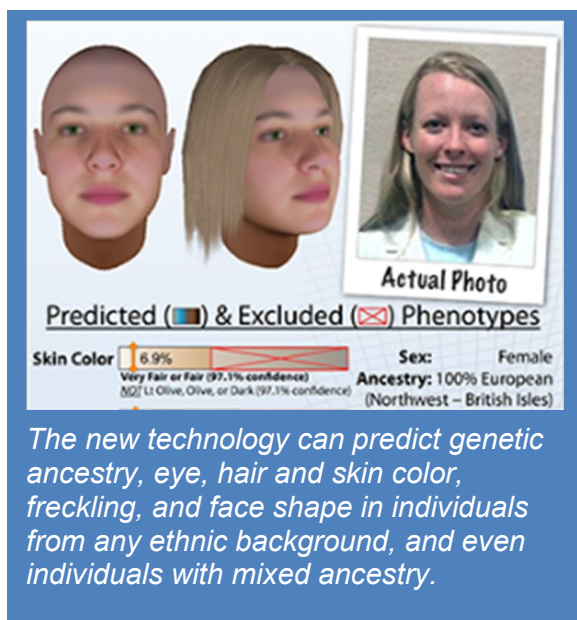

Source: First DNA-Phenotyped Image of 'Person of Interest' in Double Homicide, *Forensic Magazine*, July 15, 2015. Sean Allocca, Editor.

Conclusion

To conclude this module, we go back to where we started, with another example of a case where DNA evidence was not analyzed because the victim was not believed.

In 2008, a woman ran to police, bleeding and screaming for help after she escaped from Anthony Sowell's Imperial Avenue home (in Cleveland, Ohio). Her injuries required more than a dozen stitches.

Responding officers interviewed the woman, collected her clothing, and took pictures of her injuries. Hospital personnel conducted a medical forensic examination documenting that the victim had also been strangled. At Sowell's home, police found signs of a struggle and blood. They interviewed Sowell and took pictures of injuries on his shoulder and legs.

Despite the fact that Sowell was a registered sex offender who had previously served 15 years in prison for rape that also involved strangulation, no follow-up investigation of Sowell was documented by the assigned detective, and the forensic evidence was not submitted to a laboratory for analysis.

The next year, the decomposing bodies of 11 women were discovered on Sowell's property, and he was ultimately convicted and sentenced to death for their murders. Five of these women went missing after the 2008 assault that was reported and closed by the investigator as unfounded.⁶³

In Patty's case at the beginning of the module, the detective failed to investigate the case because he believed she was lying, and instead spent his time and effort pursuing prosecution of her for filing a false report. That decision came with a very heavy price for Patty: she suffered physically and emotionally, it damaged her relationships and stability, and ultimately led her into financial ruin. In Cleveland, it cost at least five women their lives.

One of the many factors leading to such injustice is the failure to conduct a fair and impartial investigation. A thorough investigation includes an evaluation of all the evidence available and a request for laboratory analysis of specific items based on the history of the sexual assault. However, the much more significant problem, as illustrated in these cases, is that these victims were not believed when they reported their assaults.

With collaborative efforts by professionals inside and outside the criminal justice system, we can work together to create real change and eliminate these injustices. Our goal is to achieve a world where every report of sexual assault is taken seriously and investigated to the extent possible. Only then will we be able to hold offenders

⁶³ Information drawn from Dissell (2009).



accountable for their criminal behavior, and provide victims with the compassion, support, and justice they deserve.



Where to Begin: Start by Believing

One way to achieve this goal is to embrace a Start by Believing philosophy. Start by Believing is the global campaign designed to encourage loved ones as well as responding professionals to start from an orientation of believing when someone discloses sexual assault victimization, as opposed to starting with the assumption that the victim is lying. But Start by Believing is more than a campaign. It is a philosophical stance that should guide personal and professional responses to sexual assault. To truly implement the philosophy, this message should carry over into policies, daily practices, and multidisciplinary protocols of all the agencies that serve the needs of victims. For more information, please visit the [Start by Believing website](#).



References

- Bennett, Y. (2015). The 'It's No Secret' bra drive: An example of collaborative practice. *Journal of Forensic Nursing*, 11 (1), 59-61.
- Cain, I. (2002). *The Use of Physical Evidence in the Investigation and Prosecution of Sexual Assault Cases*. Study submitted as a Master's Thesis in Forensic Sciences to National University in San Diego, California. Available upon request from End Violence Against Women International.
- Campbell, R., Fehler-Cabral, G., Pierce, S.J., Sharma, D.B., Bybee, D., Shaw, J., Horsford, S. & Feeney, H. (2015). *The Detroit Sexual Assault Kit (SAK) Action Research Project (ARP), Final Report*. Washington, DC: National Institute of Justice, Office of Justice Programs, US. Department of Justice (NCJ 248680).
- Dissell, R. (2009, November 16). [Cleveland woman says she fought, fled Anthony Sowell in 2008 attack but authorities didn't believe her](#). *The Plain Dealer*, Cleveland, OH.
- Doleac, J.L. (2011, November). [The Effects of DNA Databases on Crime](#). Stanford Institute for Economic Policy Research.
- Gingras, F., Paquet, C., Bazinet, M., Granger, D., Marcoux-Legault, K., Fiorillo, M., Séguin, D., Balzer, F., Chamberland, C. & Jolicoeur, C. (2009). Biological and DNA evidence in 1000 sexual assault cases. *Forensic Science International: Genetics Supplement Series*, 2, 138-140.
- Gourarie, C. (2015, September 2). [How an Ohio reporter helped convict more than 100 rapists](#). *Columbia Journalism Review*.
- Hares, D.R. (2015) [Selection and implementation of expanded CODIS core loci in the United States](#). *Forensic Science International Genetics*, 17, 33-34.
- Hethcock, B. (2003, July 26). [Bag story trips up rapist: Suspect convicted after jury decides tale](#). *The Gazette*, Colorado Springs, CO.
- Human Rights Watch (2009). [Testing Justice: The Rape Kit Backlog in Los Angeles City and County](#). New York, NY: Human Rights Watch.
- Human Rights Watch (2010). ["I Used to Think the Law Would Protect Me:" Illinois' Failure to Test Rape Kits](#). New York, NY: Human Rights Watch.
- Human Rights Watch (2013). [Capitol Offense: Police Mishandling of Sexual Assault Cases in the District of Columbia](#). New York, NY: Human Rights Watch.
- Hurst, L. (2014, July 9). [Legislative Update: State and Federal Developments](#). Gordon Thomas Honeywell Governmental Affairs.



Hurst, L. & Schellberg, T. (2013, October 10). [DNA Policy and Funding: The US. and Abroad](#). Gordon Thomas Honeywell Governmental Affairs.

Kovner, J. (2012, January 9). [At embattled state crime laboratory, limits on evidence set](#). *The Hartford Courant*, Hartford, CT.

Latta, J.T. & Bowers, G.A. (2011). [Property and Evidence by the Book \(2nd Ed.\)](#). Hot Springs, SD: International Association for Property and Evidence.

Ledray, L. (2001). Sexual assault nurse examiners. In M. LeBeau & A. Mozayani (Eds.), *Drug-Facilitated Sexual Assault: A Forensic Handbook (Chapter 11, p. 231-252)*. London: Academic Press.

Ledray, L.E. (2005). Forensic medical evidence: The contributions of the sexual assault nurse examiner (SANE). In J.O. Savino & B.E. Turvey (Eds.), *Rape Investigation Handbook (Chapter 6, p. 119-146)*. Burlington, MA: Elsevier.

Leuders, B. (2007). *Cry Rape: The True Story of One Woman's Harrowing Quest for Justice*. Madison, WI: Terrace Books.

Lisak, D. & Miller, P.M. (2002). Repeat rape and multiple offending among undetected rapists. *Violence and Victims*, 17, 73-84.

McEwan, T. (2011). *The Role and Impact of Forensic Evidence in the Criminal Justice Process*. Washington, DC: National Institute of Justice, Office of Justice Programs, US. Department of Justice (NCJ 236474).

McWhorter, S.K., Stander, V.A., Merrill, L.L., Thomsen, C.J. & Milner, J.S. (2009). Reports of rape reperpetration by newly enlisted male Navy personnel. *Violence and Victims*, 24, 204-218.

Mulligan, C.C. & O'Leary, A.E. (2015). [Accessing the Probative Value of Physical Evidence at Crime Scenes with Ambient Mass Spectrometry and Portable Instrumentation](#). Washington, DC: National Institute of Justice, Office of Justice Programs, US. Department of Justice (NCJ 248884).

Murphy, E. (2013, July). [Legal and Ethical Issues in Forensic DNA Phenotyping](#), Public Law & Legal Theory Research Paper No. 13-46. New York University School of Law.

National Center for Victims of Crime (no date). [Evidence Retention; Achieving Justice, Serving Victims](#). Washington, DC: National Center for Victims of Crime, Office of Justice Programs, US. Department of Justice.

National Institute of Justice (2002). *Using DNA to Solve Cold Cases*. Washington, DC: US. Department of Justice, Office of Justice Programs, National Institute of Justice, National Commission on the future of DNA Evidence Crime Scene Investigation Working Group, (NCJ 194197).

Nelson, M., Chase, R. & DePalma, L. (2013). *Making Sense of DNA Backlogs, 2012 – Myths vs. Reality*. Washington, DC: National Institute of Justice, Office of Justice Programs, US. Department of Justice (NCJ 232197).

Office on Violence Against Women (2010). [Eliminating the Rape Kit Backlog: A Roundtable to Explore a Victim-Centered Approach](#). Summary of the Proceedings. Washington, DC: US. Department of Justice.

Patterson, D. & Campbell, R. (2012). The problem of untested sexual assault kits: Why are some kits never submitted to a crime laboratory? *Journal of Interpersonal Violence*, 27, 2259-2275.

Peterson, J., Johnson, D., Herz, D., Graziano, L. & Oehler, T. (2012). *Sexual Assault Kit Backlog Study: Final Report*. Washington, DC: National Institute of Justice, Office of Justice Programs, US. Department of Justice (NCJ 238500).

Peterson, J., Sommers, I., Baskin, D. & Johnson, D. (2010). *The Role and Impact of Forensic Evidence in the Criminal Justice Process*. National Institute of Justice, Office of Justice Programs, US. Department of Justice (NCJ 231977).

Quarino, L. & Kishbaugh, J. (2012). The utility of Y-STR profiling in four-, six- and eight-day postcoital vaginal swabs. *Medicine, Science, and the Law*, 52 (2), 81-88.

Reilly, S. & Jones, C. (2015, September 11). [More than 40 police agencies to get \\$79M to test rape kits](#). *USA Today*.

Reiss, D. (2012, June 29). Update: Testing backlogged rape kits in Illinois. *Today's Chicago Woman*.

Richard, M. & Kupferschmid, T.D. (2011). *Increasing Efficiency of forensic DNA Casework Using Lean Six Sigma Tools*. Washington, DC: National Institute of Justice, Office of Justice Programs, US. Department of Justice (NCJ 235190).

Ritter, N. (2012, June). Solving sexual assault: Finding answers through research. *NIJ Journal*. National Institute of Justice, Office of Justice Programs, US. Department of Justice (NCJ 233279).

Roach, B.A. & Vladutiu, A.O. (1993). Letter to the Editor: Prostatic specific antigen and prostatic acid phosphatase measured by radioimmunoassay in vaginal washings from cases of suspected sexual assault. *Clinica Chimica Acta*, 276 (1-2), 199-201.

Schellberg, T. (2002). [Forensic DNA Legislative Update](#). Presentation by Smith Alling Lane to the American Academy of Forensic Sciences, Atlanta, Georgia, February 13.

Speck, P. & Ballantype, J. (2015). *Post-Coital DNA Recovery Study: Final Report*. Washington, DC: National institute of Justice, Office of Justice Programs, US. Department of Justice (NCJ 248682).

Strom, K.J., Roper-Miller, J., Jones, S., Sikes, N., Pope, M. & Horstmann, N. (2009). *The 2007 Survey of Law Enforcement Forensic Evidence Processing: Final Report*. Triangle Park, NC: RTI International.

Sween, K.R., Quarino, L.A. & Kishbaugh, J.M. (2015). Detection of male DNA in the vaginal cavity after digital penetration using Y-chromosome short tandem repeats. *Journal of Forensic Nursing*, 11 (1), 33-40.

Technical Working Group on Biological Evidence Preservation (2013). [*Biological Evidence Preservation Handbook: Best Practices for Evidence Handlers*](#). Published by the National Institute of Standards and Technology, US. Department of Commerce and the National Institute of Justice, Office of Justice Programs, US. Department of Justice (NISTIR 7928).

Teibel, D.L. & Flick, A.J. (2004, November 23). Rapist's "cowardly" last act, he hangs himself in jail cell hours before sentencing. *Tucson Citizen*, Tucson, AZ.

Thackeray, J., Hornor, G., Benzinger, E. & Scribano, P. (2011). Forensic evidence collection and DNA identification in acute child sexual assault. *Pediatrics*, 128 (2), 227-232.

Tucker, S., Claire, E., Ledray, L.E. & Werner, J. (1990). Sexual assault evidence collection. *Wisconsin Medical Journal*, 89 (7), 407-411.

Wambaugh, J. (1989). *The Blooding: The True Story of the Narborough Village Murders*. New York: Bantam.

Williams, S., Panacek, E., Green, W., Kanthaswamy, S., Hopkins, C. & Caloway, C. (2015). Recovery of salivary DNA from the skin after showering. *Forensic Science, Medicine, and Pathology*, 11, 29-34.

Williamson, A. (2015a). *DNA Collection Policies Pertaining to Violent and Serial Offenders*. Presentation to the International Homicide Investigators Association, August 19, Washington, DC.

Williamson, A. (2015b). *Summary of Issues with CODIS/DNA Collection Policies Pertaining to Violent and Serial Offenders*. Working paper available from the author. Wolf, R. (2013, June 3). [Supreme Court Oks DNA swab of people under arrest](#). *USA Today*.



Appendix List

- Appendix A: [List of Evidence Retention Laws](#)
- Appendix B: [Sample Chain-of-Custody Report](#)
- Appendix C: [Two Sample Evidence Retention Grids](#)
- Appendix D: [Fact Sheet on Drug-Facilitated Sexual Assaults \(Society of Forensic Toxicologists\)](#)
- Appendix E: [Sexual Assault Case History and Analysis](#) and two Sample Laboratory Request Forms to be Completed by Investigators: [Excel](#) and [Word](#).
- Appendix F: [Sample Screening Report Completed by Forensic Scientist](#)
- Appendix G: [Sample DNA Analysis Report Completed by Forensic Scientist](#)
- Appendix H: [Two Sample Evidence Disposition Forms](#)
- Appendix I: [Evidence Section Notice of Imminent Evidence Disposal](#)
- Appendix J: [Sample Guidelines for Conducting a Suspect Examination from Palmetto Health Richland](#)
- Appendix K: Sample Suspect Forensic Exam Forms:
- Sample 1: [North Dakota](#)
 - Sample 2: [California Form for Documenting Findings From a Suspect Examination](#)
- Appendix L: [Eisenhower Medical Center Addendum for Documenting Anal Findings](#)
- Appendix M: [Eisenhower Medical Center Clothing Documentation Form](#)
- Appendix M2: [Officer Completed Clothing Documentation Form](#)
- Appendix N: [San Diego Police Department Instructions for Obtaining Buccal \(Mouth\) Swabs](#)
- Appendix O: [Consent Form for Conducting a Suspect Examination From COVERSA](#)
- Appendix P: [Consent Form for Obtaining a DNA Reference Standard](#)
- Appendix Q: [Forensic Paternity Testing](#)
- Appendix R: [Template Affidavit and Search Warrant Suspect Exam](#)
- Appendix S: [Sample CODIS Confirmation Affidavit Search Warrant](#)



Appendix T: [San Diego Police Department Crime Laboratory Feedback Form](#)

Appendix U: [Oregon SANE Feedback Form](#)

Appendix V: [Eisenhower Crime Laboratory Survey](#)

Appendix W: [Drug-Facilitated Sexual Assault History Form](#)

Appendix X: [Residential Search Warrant](#)

Appendix Y: [Law Enforcement Toxicology Request](#)

