

A Look at the 450-43LE (Asian Seki), Part I



by Lance Wiggins

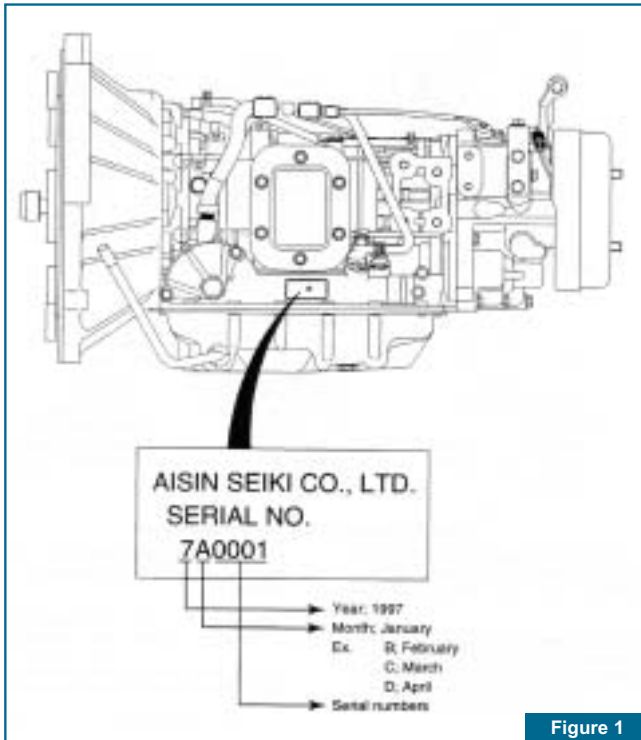

Figure 1

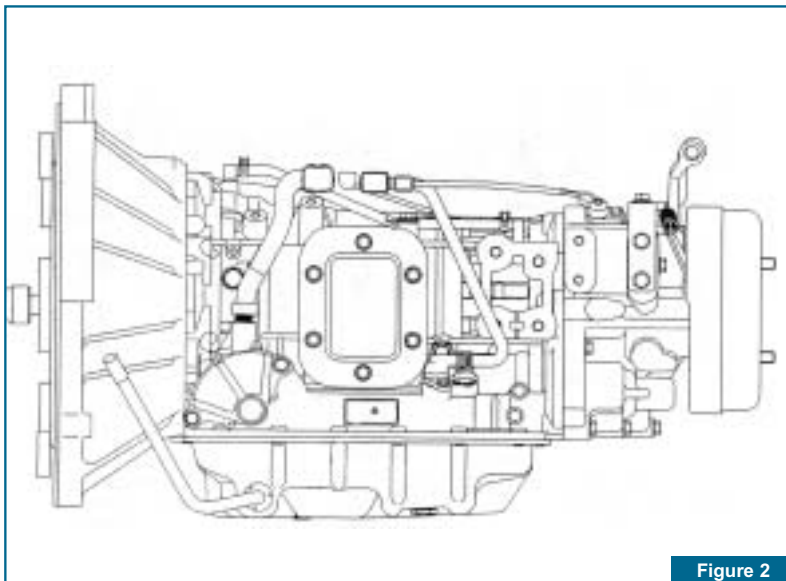

Figure 2

What is it about the 450-43LE that's so intriguing? Well, let's see: There are no checkball locations to be found in any shop manual, no disassembly procedures, no valve body exploded views, and no definite identifying hydraulics. Need I say more? After numerous calls to the ATRA HelpLine on this unit, it was apparent we needed to get one here and dissect it to the core, and thanks to Dalyn and the guys at WIT (WHAT-EVER IT TAKES) we got one.

In this first of a two-part series of *Let's Play Ball*, we'll identify the transmission case, valve body, and wiring. We'll start with the application of the transmission.

Identifying the Transmission

The 450-43LE transmission is very similar to some Toyota transmissions with one exception: It seems to be on steroids. Found in the Isuzu NPR cab-over truck series, the 450-43LE can be identified in a couple of ways; one way is from the tag on the driver's side of the transmission (figure 1). Another easy determining factor is the PTO cover, which is also on the driver's side of the transmission (figure 2).

The 450-43LE is a large unit — not as big as the E4OD but just as heavy — this transmission was made for pure torque. The clutch and band application is also very similar to other

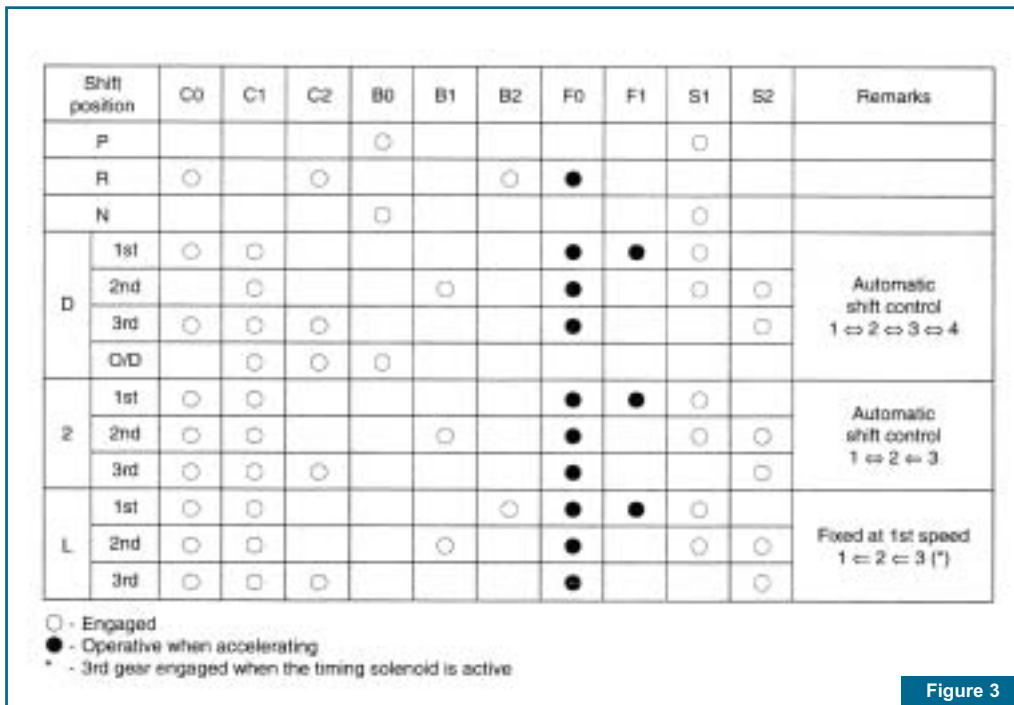

Figure 3

Component name	Symbol	Function
O/D direct clutch	C0	Connects O/D sun gear and O/D carrier.
Front clutch	C1	Transmit the engine torque from the input shaft to the intermediate shaft.
Rear clutch	C2	Transmit the engine torque from the front clutch hub to the front and rear planetary sun gear.
O/D brake	B0	Locks the O/D planetary sun gear.
2nd brake	B1	Locks the front and rear planetary sun gear.
1st & Rev. brake	B2	Locks the front planetary carrier.
O/D one-way clutch	F0	Locks the O/D sun gear and O/D planetary carrier during acceleration in 1st, 2nd or 3rd gear.
One-way clutch No.2	F1	Locks the front planetary carrier during acceleration in 1st gear.
No.1 shift solenoid	S1	The ON/OFF combinations of the two solenoids are used to control the gear position.
No.2 shift solenoid	S2	

Figure 3A

Toyota applications, even using the same names for the clutches and bands (figure 3 and 3a).

Valve Body

The 450-43LE valve body can be identified by its size alone. The upper valve body has nine checkballs and one filter (figure 4). The lower valve body has two checkballs that are used for the cooler and one check valve cup used for pressure

Are you really saving money when it takes them several attempts to ship you what you ordered?

Experience...

the Whatever It Takes Difference!



WHATEVER IT TAKES

TRANSMISSION PARTS, INC.

800-940-0197

relief (figure 5).

Be very careful removing the plugs from the valve bores during disassembly. Not only do the clips like to pop out on their own but the plugs can be installed backwards and will cause all kinds of problems, from no gear to slipping concerns.

The 450-43LE valve body uses five solenoids: one pressure control solenoid, two shift solenoids, one torque converter clutch solenoid,

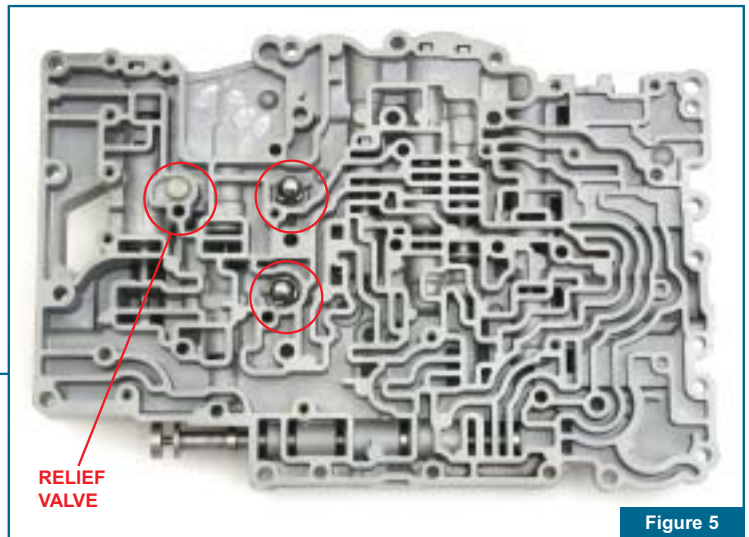
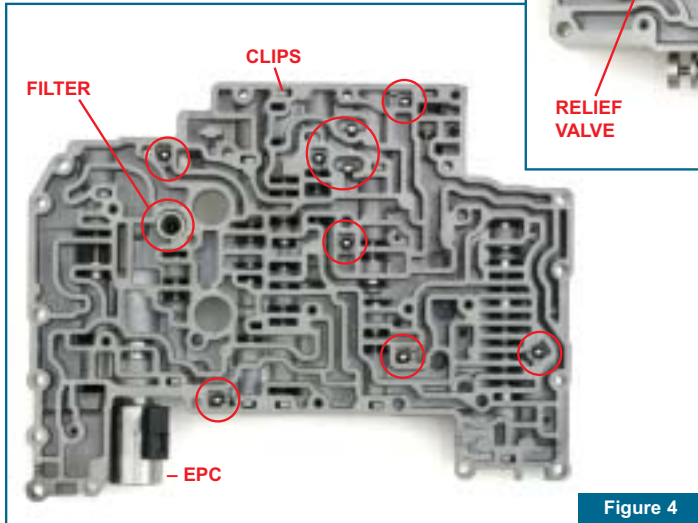

Figure 5



The lower valve body has two checkballs that are used for the cooler and one check valve cup used for pressure relief (figure 5).

The Key to Reducing Costly Come Backs...

...Is Muscle MT-10 "The Original" Metal Treatment™



Muscle Products Corp.
"The Strength in Lubrication™"
112 Fennell Drive
Butler, PA 16002
Phone: (800) 227-7049 or (724) 283-0567
Fax: (724) 283-8310
<http://www.mpc-home.com>



VALVE NEW BODY NEW CLEANER



- 2 HP SEAL-LESS PUMP
- INSULATED
- 20 GALLON RESEVOIR
- COMPACT DESIGN

The VB-15 uses high pressure and a special lubricating cleaner to quickly clean valve bodies. Lost clips, valves, and check balls are captured in the easy access pre-screen. Cleaning solution is filtered through a 100-micron filter system. The VB-15 is compact and portable.

WWW.INSTACLEAN.COM

800-331-6405



Solenoid Resistance	
SS #1	10-20 ohms
SS #2	10-20 ohms
Lock-up	10-20 ohms
Timing solenoid	10-20 ohms
Line Pressure	3.5-5.5 ohms

Figure 6

Operating solenoid		
Gear	S1	S2
1st	ON	OFF
2nd	ON	ON
3rd	OFF	ON
4th	OFF	OFF

Figure 7



Figure 8

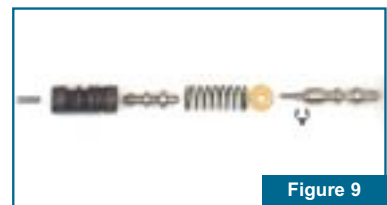

Figure 9



Figure 10

and one timing solenoid. Measure the solenoid resistance between the solenoid tab and ground (figure 6).

Use the solenoid firing order during diagnosis (figure 7).

The EPC solenoid is easy to identify by its large size and you can disassemble it for cleaning (figure 8).

Failsafe on this unit is fourth gear in drive and first in manual second.

Pay close attention to the checkball locations during valve body disassembly. There are a number of other locations that look like they could take a checkball; putting one in these locations could damage the transmission.

The problem valves to look for are some of the most common: the pressure regulator (figure 9) and the throttle valve (figure 10). Yes, I said the throttle valve: this valve is located in the EPC. As mentioned earlier, the EPC can be completely disassembled for servicing.

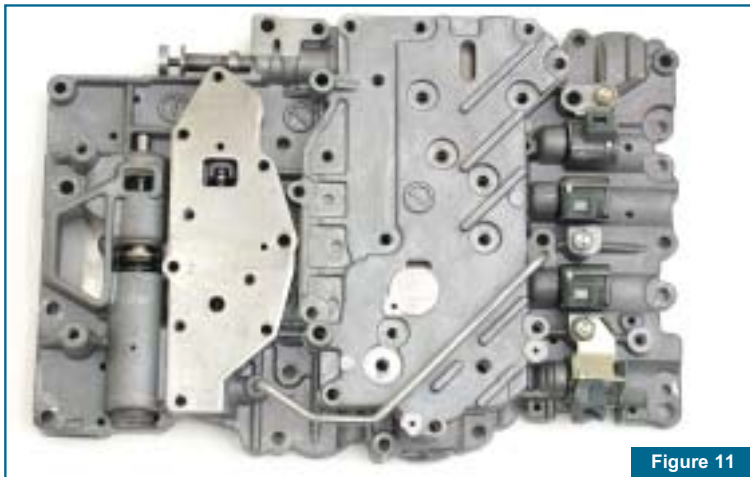

Figure 11

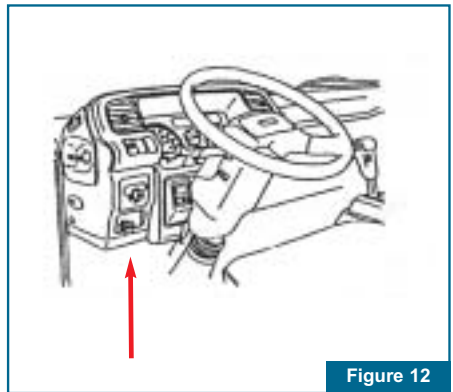

Figure 12

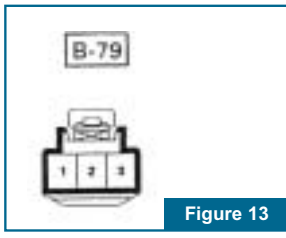

Figure 13

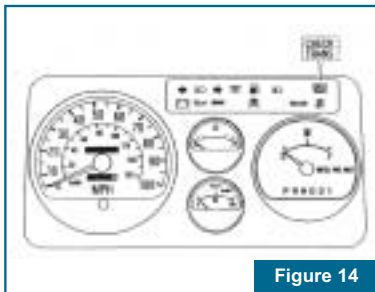



Figure 14

There are a couple of tubes you're going to need to pay attention to (figure 11), these tubes are used for transferring oil from the cutback valve to the 2-3 timing valve and lube.

Wiring Harness and Connector

Even though this transmission isn't new, we get plenty of calls on wiring specifications, code retrieval and testing. To retrieve codes on the 450-43LE, locate the Data Link Connector (DLC) under the dash (figure 12), tied to the support bracket under the brake and clutch fluid tank on the driver's side. This is a three-wire connector that can be accessed by most scan tools, but you can also check for codes simply by jumping the wires (figure 13) and watching the "Check Transmission" light (figure 14).



Southeast

Worldwide Manufacturers
A Division of  NORTH OIL

Application Guide & Catalogs
Are Available From Your Distributor
To Find A Distributor Near You
Call or Fax Us

PRODUCTS



FLYWHEELS
& FLEXPLATES



MOUNTS



Specialty Parts &
Plastic Components



CABLES



22V
SUPER
SPARKPLUGS

OEM QUALITY PARTS



Grommets
etc.

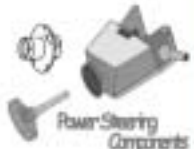

Power Steering
Components



OEM QUALITY AT YOUR FINGERTIPS



Speedo-Gears



Specialty
Tools



ISOM Quality



RTSD



AERA

7575 N.W. 74 Avenue - Miami, Florida, 33188 - USA - eMail: info@seautos.com
305-885-8889 - 800-888-5489 - Fax: 305-888-8215 - 1-305-489-0673 - www.seautos.com

2003

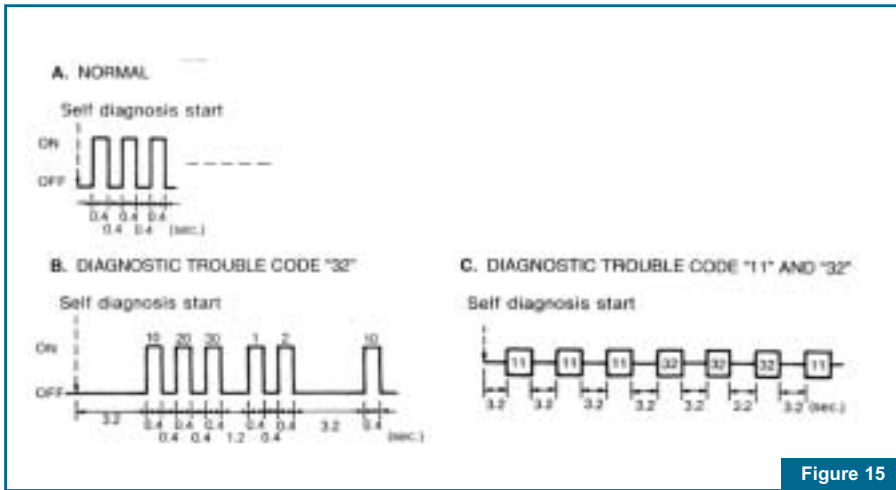

Figure 15

The TCM (Transmission Control Module) has a self-diagnosis function. If any trouble occurs in the system, the Check Transmission light turns on to indicate possible troubles related to one or more of these components:

1. VSS#1 (Vehicle Speed Sensor #1 — Installed on the transmission)
2. RPM (Engine Speed Sensor)
3. TFT (Transmission Fluid Temperature sensor)

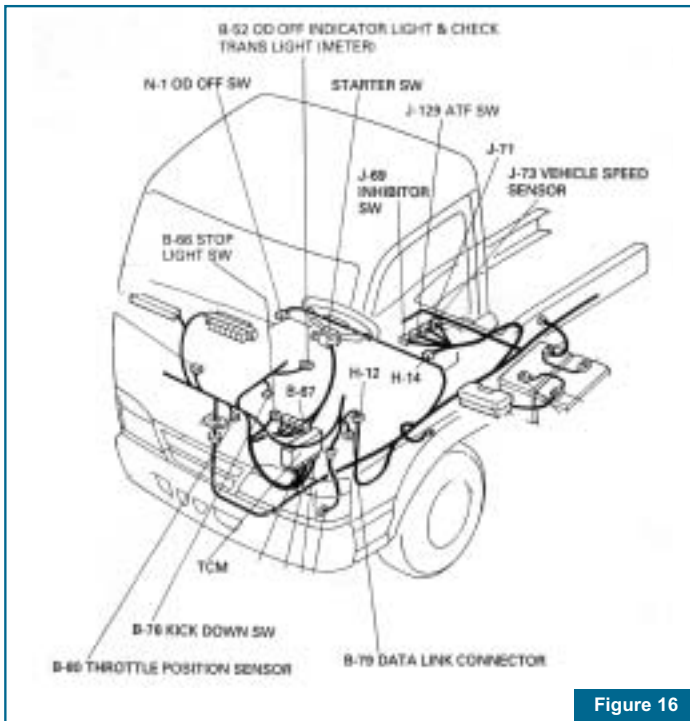

Figure 16

4. Inhibitor Switch
5. TPS (Throttle Position Sensor)
6. VSS#2 (Vehicle Speed Sensor #2 — Fitted on the speedometer driven gear)
7. SS#1 (Shift Solenoid #1)
8. SS#2 (Shift Solenoid #2)
9. Timing Solenoid
10. Lockup Solenoid
11. Line Pressure Solenoid
12. Exhaust Brake Cut
13. Engine Warmup Cut

All of these inputs and outputs are directly related to the transmission and all of these sensors and switches can be checked at the computer or the sensor itself.

When retrieving codes manually by jumping the DLC, jump the wires between pins one and two (figure 13). If there's a problem in the system, the Check Transmission light will start to flash: Count the flashes to identify the code (figure 15).

When diagnosing the solenoids externally, the transmission connector pin locations are key elements to have in your arsenal. The manufacturer lists the connector as J-71, (figure 16). This connector is located at the transmission on the driver's side.

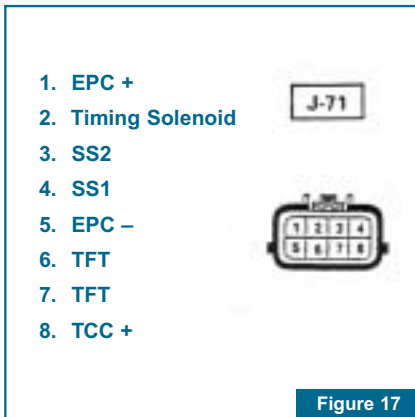

Figure 17

To monitor the signal from the TCM, install your signal monitor to the correct wires (figure 17). You can test the solenoid firing order, lockup, timing solenoid and exhaust brake operation during your test drive; but the timing and exhaust brake solenoid are PWM solenoids, so you'll have to check them using a digital meter.

As you can see, this steroid-induced Toyota isn't all that tough to get to know, but it can produce plenty of problems if you don't have the right information. In the next issue of **GEARS** we'll get into the nitty-gritty of diagnosing the internals and externals of the 450-43LE... and that's the game!

