

LCP Proximal Femoral Plate 4.5/5.0.

Part of the LCP Periarticular Plating System.

Technique Guide

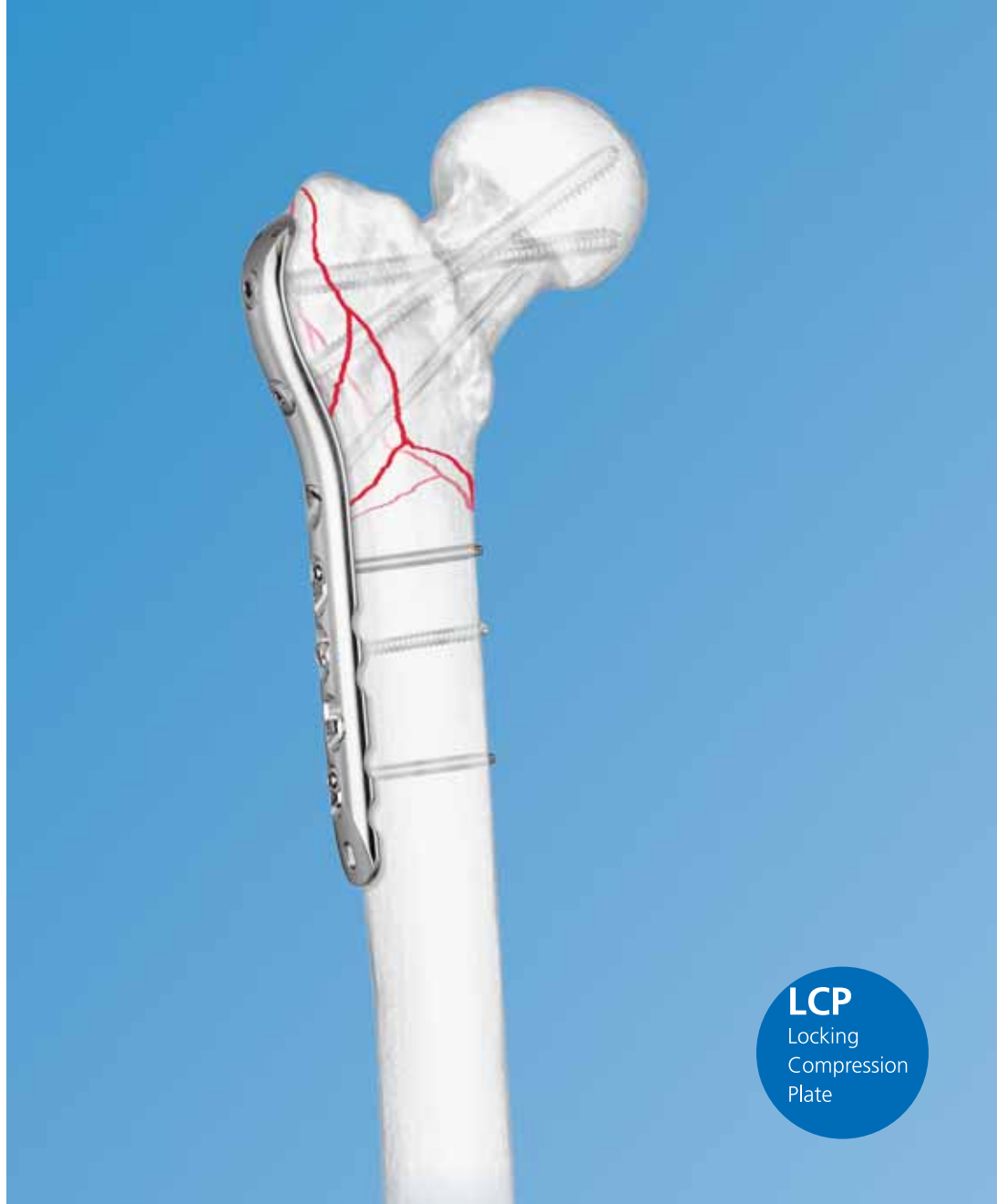

LCP
Locking
Compression
Plate

Table of Contents

Introduction	Features and Benefits	2
	AO ASIF Principles	4
	Indications	6

Surgical Technique	Implantation	7
	Tips	20

Product Information	Plates	21
	Screws	22
	Drill and Wire Guides	24
	Sets	26

 Image intensifier control

Warning

This description is not sufficient for immediate application of the instrumentation. Instruction by a surgeon experienced in handling this instrumentation is highly recommended.

Features and Benefits

The Synthes LCP Proximal Femoral Plate 4.5/5.0 is part of the LCP Periarticular Plating System, which merges locking screw technology with conventional plating techniques.

LCP Periarticular Plating System

The LCP Periarticular Plating System is capable of addressing:

- complex fractures of the proximal femur with the LCP Proximal Femoral Plate 4.5/5.0 or the Proximal Femoral Hook Plate 4.5/5.0.
- complex fractures of the distal femur with the LCP Condylar Plate 4.5/5.0.
- complex fractures of the proximal tibia with the LCP Proximal Tibia Plate 4.5/5.0 or the Medial Proximal Tibia Plate 4.5/5.0.

Locking Compression Plate

The Locking Compression Plate (LCP) has combi-holes in the plate shaft that combine a dynamic compression unit (DCU) hole with a threaded locking hole. The combi-hole provides the flexibility of cortex screw or locking screw fixation.

Note: More detailed information on conventional and locked plating principles can be found in the Synthes Locking Compression Plate (LCP) Technique Guide (Art. No. 036.000.019).



LCP Proximal Femoral Plate

The LCP Proximal Femoral Plate is a limited-contact stainless steel plate. The proximal portion of the plate is precontoured for the proximal femur. The two proximal screw holes are designed for 7.3 mm cannulated locking screws and the third locking hole is designed for 5.0 mm cannulated locking screws. The hole for 5.0 mm locking screws is angled so the screw trajectory converges with the proximal 7.3 mm screw. Improved proximal femoral fixation in osteopenic bone is achieved by the screw angulation and the locking interface with the plate. The remaining screw holes in the plate shaft are combi-holes. This provides the surgeon with the flexibility to achieve plate-to-bone apposition as well as axial compression or angular stability.

- Anatomically contoured to approximate the lateral aspect of the proximal femur
- Plates specifically designed for left or right femur to accommodate average femoral neck anteversion
- Plate lengths allow spanning of the entire diaphysis in segmental fracture patterns
- Use of locking screws provides the option of an angular stable construct independent of bone quality
- Plate can be tensioned to create a load-sharing construct
- Manufactured of implant quality 316L stainless steel
- The three proximal screw holes are at the following angles to the plate shaft:
 - First proximal hole (7.3 mm): 95°
 - Second proximal hole (7.3 mm): 120°
 - Third proximal hole (5.0 mm): 135°

The two proximal plate holes are threaded and accept 7.3 mm cannulated screws (locking, conical fully threaded, or conical partially threaded).

The third locking hole is threaded to accept 5.0 mm cannulated locking screws. (Necessity of this screw is fracture configuration dependent and should be identified during preoperative planning.)

The holes in the shaft of the plate are combi-holes that accept 5.0 mm locking screws in the threaded portion of the hole and 4.5 mm cortex screws in the DCU portion.

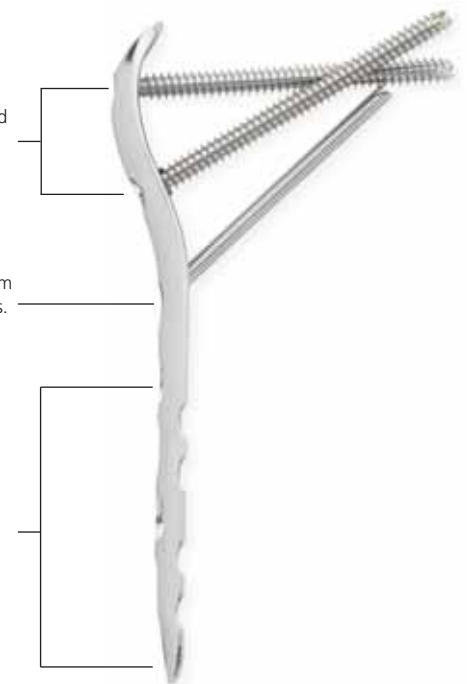

AO ASIF Principles

In 1958, the AO ASIF (Association for the Study of Internal Fixation) formulated four basic principles¹ which have become the guidelines for internal fixation. Those principles as applied to the LCP Proximal Femoral Plate 4.5/5.0 are:

Anatomic reduction

Anatomic plate profile assists reduction of metaphysis to diaphysis and facilitates restoration of the neck-shaft angle by proper screw placement.



Stable fixation

The combination of conventional and locking plate fixation offers optimum fixation irrespective of bone density.



Preservation of blood supply

A limited-contact design reduces plate-to-bone contact and helps to preserve the periosteal blood supply.



¹ M.E. Müller, M. Allgöwer, R. Schneider, and H. Willenegger. AO Manual of Internal Fixation, 3rd Edition. Berlin: Springer-Verlag. 1991.

Early mobilization

Plate features combined with AO technique create an environment for bone healing, expediting return to function.



Indications

The LCP Proximal Femoral Plate 4.5/5.0 is intended for fractures of the femur including:

- Fractures of the trochanteric region, trochanteric simple, cervicotrochanteric, trochanterodiaphyseal, multifragmentary pertrochanteric, intertrochanteric, trochanteric reversed or transverse or with additional fracture of the medial cortex
- Fractures of the proximal end of the femur combined with ipsilateral shaft fractures
- Metastatic fracture of the proximal femur
- Osteotomies of the proximal femur
- Also for use in fixation of osteopenic bone and fixation of nonunions or malunions



Preoperative AP



Follow-up lateral



Follow-up AP

1

Preparation

Required sets

LCP Proximal Femoral Plate Set 4.5/5.0 (stainless steel)

Periarticular LCP Plating System Instrument Set

Cannulated Locking and Cannulated Conical Screw
 Ø 5.0 and 7.3 mm Set

LCP Large Fragment Instrument Set

LCP Large Fragment Screw Set

Complete the preoperative radiographic assessment and prepare the preoperative plan. AP and lateral radiographs of the entire femur are necessary for complete evaluation. Traction radiographs and views of the contralateral femur are useful adjuncts in the planning process.

When considering use of the LCP Proximal Femoral Plate, identify proper placement of the three proximal screws.

Use the x-ray templates to aid in planning the procedure. Determine plate length and approximate screw lengths and instruments to be used. Position the patient supine on a radiolucent operating table, or a fracture extension table for lower energy fracture settings. Fluoroscopic visualization of the femur in both AP and lateral views must be verified prior to patient draping.

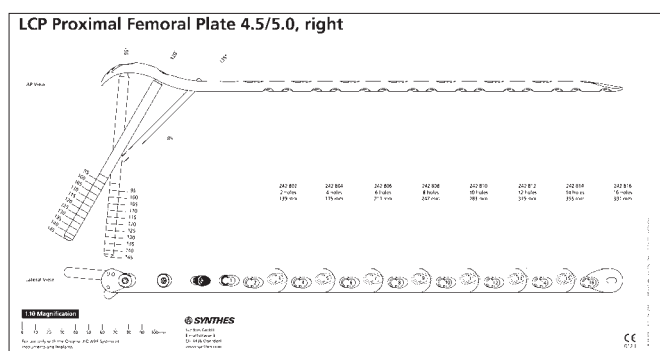
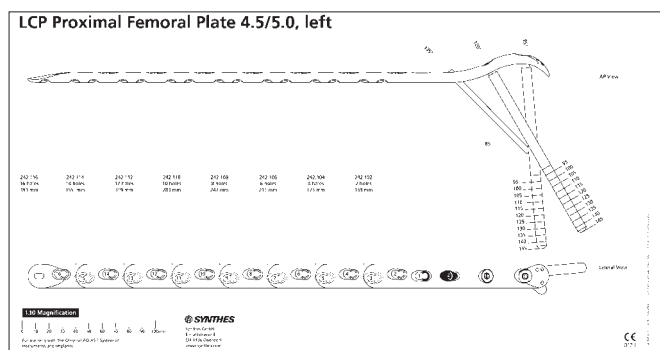

X-ray templates for LCP Proximal Femoral Plates 4.5/5.0 (Art. No. 034.000.476 for left femur, Art. No. 034.000.478 for right femur)

2

Reduce fracture

Reduce the fracture using a fracture table, clamps, Schanz screws, or other conventional reduction techniques. Alternatively, provisional indirect fracture reduction may be facilitated by attaching the LCP Proximal Femoral Plate to the proximal segment with appropriately oriented screws, and then to the diaphysis with plate holding forceps.

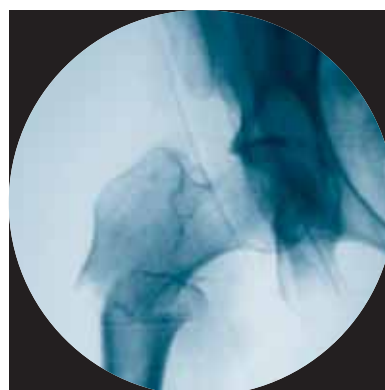

3

Insert guide wires and establish screw trajectories

Instruments

324.175	Wire Guide 7.3, for Guide Wire Ø 2.5 mm
324.174	Wire Guide 5.0, for Guide Wire Ø 2.5 mm
310.243	Guide Wire Ø 2.5 mm with threaded tip with trocar

Prior to placing the plate on the bone, thread the wire guides into the plate holes for each of the three proximal locking screws. Use the wire guide 7.3 in the two proximal screw holes, and a wire guide 5.0 in the third locking screw hole. The wire guides can also be used as a manipulation aid for positioning the plate on the proximal femur.

- Using fluoroscopic image control (AP and lateral), insert a guide wire through the wire guide in each of the three proximal locking holes. For proper screw measurement, guide wires should reach but not penetrate subchondral bone.

Note: It is more important to properly place guide wires in the proximal femur (considering the desired screw positions) than it is to precisely match the contour of the plate to the anatomy of the femur. The ability to lock the screws to the plate obviates the need for precise plate contouring and compressing the plate to the bone.



A. Placement of the proximal guide wire in the AP view is into the midportion of the inferomedial quadrant of the femoral head along a path subtending a 50° angle relative to the calcar femoralis. Guide wire placement in this manner will facilitate placement of the proximal locking screw at a 95° angle to the femoral shaft.

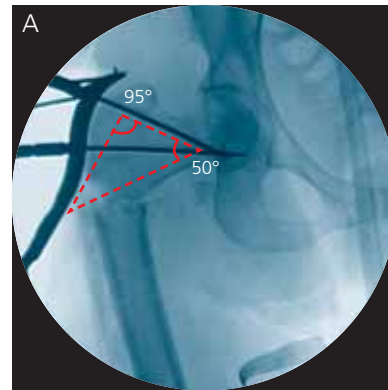

B. The proximal wire is ideally placed slightly posterior to central in the lateral view. This accommodates an anteverted position for the second guide wire and screw. Accurate positioning of the proximal guide wire (and ultimately the locking screw) assures frontal plane alignment.

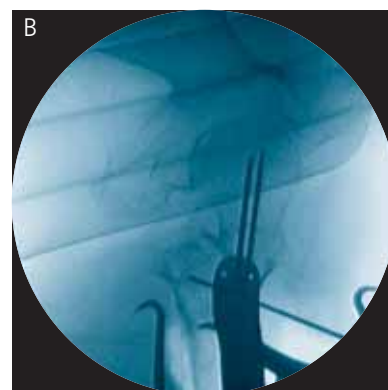
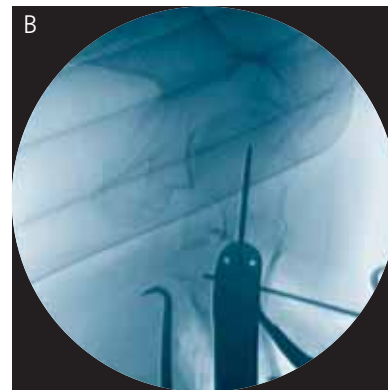

Before a guide wire is inserted into the second wire guide, verify correct sagittal plane alignment of the plate on the proximal femur. This usually requires both visual and fluoroscopic assessment and prevents an extension (apex anterior) deformity when the plate is attached to the diaphysis.

When this alignment is satisfactory, insert the guide wires through the next two (distal) wire guides, maintaining bi-planar fluoroscopic control. In some patterns, insertion of the third guide wire may have to be deferred until final reduction (and compression, where possible) has been achieved.

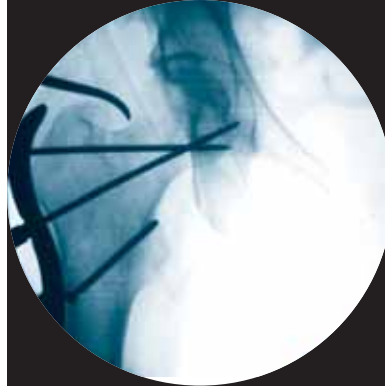

4

Insert proximal 7.3 mm screw

Instruments

319.701	Measuring Device
314.050	Screwdriver, hexagonal, cannulated

For predrilling dense bone

310.632	Drill Bit Ø 5.0 mm, cannulated
310.634	Drill Bit Ø 4.3 mm, cannulated

Using the measuring device measure for screw length over the guide wire. Select the appropriate length 7.3 mm cannulated locking screw. Use the screwdriver to remove the wire guide.

Technique tip: The self-drilling, self-tapping flutes of the 7.3 mm and 5.0 mm screws make predrilling and pretapping unnecessary in most cases. In dense bone, the lateral cortex can be predrilled, if necessary.

- Use the drill bit Ø 5.0 mm for 7.3 mm screws.
 - Use the drill bit Ø 4.3 mm for 5.0 mm screws.
-

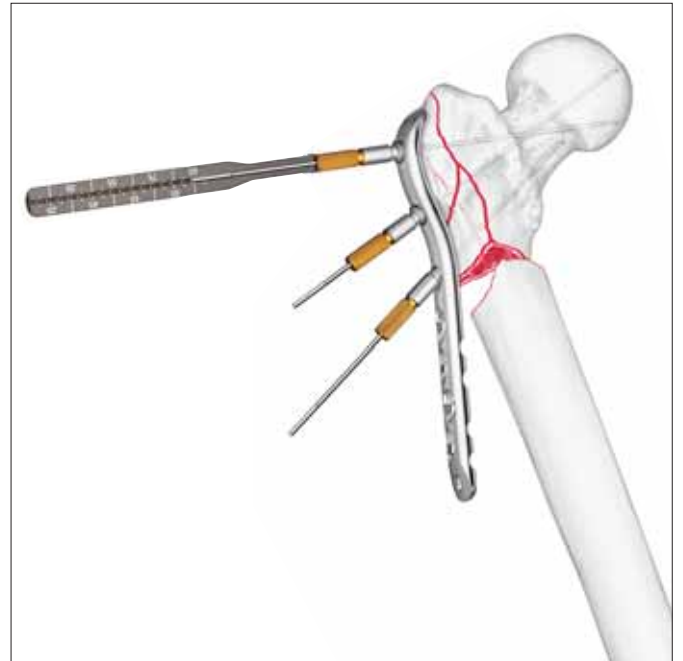

- ① Insert the screw, using fluoroscopy, with the screwdriver. This screw, as with all locking screws not protected by a torque limiting attachment, may be inserted using power. However, final seating and tightening must be done manually. Once the screw has been locked to the plate, the guide wire may be removed.

Note: Recheck each locking screw prior to closing to verify that the screws are securely locked to the plate. Screw heads must be flush with the plate in the locked position before they can be considered fully seated.

In some cases it may be necessary to pull the plate to the bone; if so, use a fully threaded 7.3 mm cannulated conical screw in the proximal screw hole. However, use caution, to avoid changing the alignment of the guide wire with the conical screw. If malalignment occurs, it may preclude final exchange of the conical screw for a locking screw, and thereby weaken the overall strength of the plate construct.

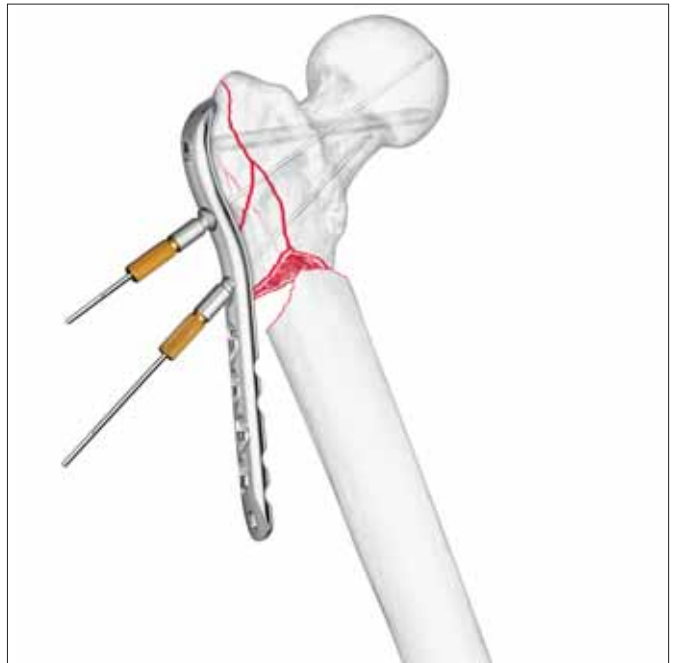

5

Insert second 7.3 mm screw

Insert the second 7.3 mm screw using the same technique as described in step 4.

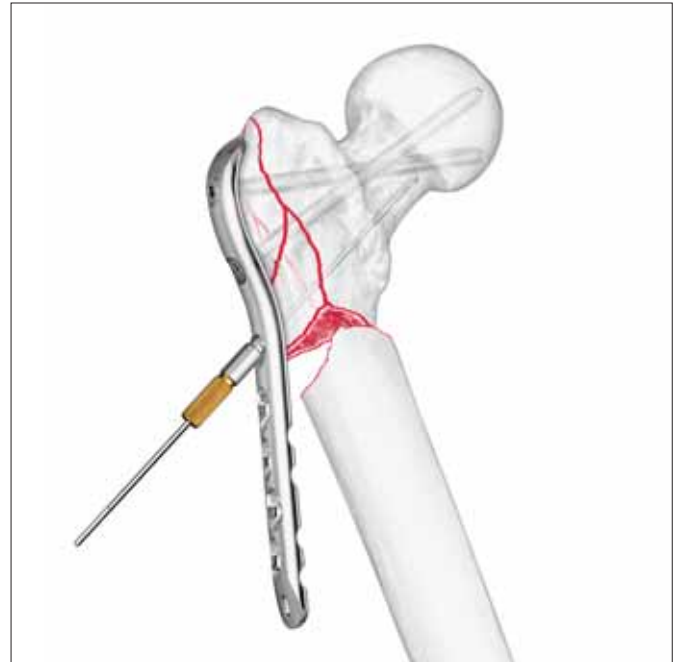

6

Approximate the plate to the femoral diaphysis

Instrument

321.120 Tension Device, articulated, span 20 mm

Secure the plate to the lateral femoral shaft with bone holding forceps, adjusting horizontal plane alignment (rotation) as appropriate. Length restoration and fracture reduction can be facilitated by a number of indirect means, including a fracture table, the Articulated Tension Device (ATD), the large distractor, the large distractor/compressor, or a large external fixator. Judicious, soft tissue preserving, direct reduction techniques with clamps may also be appropriate in some cases.

When the fracture pattern permits, a tensioning device should be applied to the end of the plate to tension the plate and compress the fracture.

Note: Using the ATD to realign the fragments, tension the plate, and compress the fracture creates a load-sharing construct. Alternatively, although less desirable, the plate can be used as a bridging construct in patterns with segmental comminution where plate tensioning cannot be accomplished.



7

Insert 4.5 mm cortex screws

Instruments

310.310	Drill Bit Ø 3.2 mm
323.460	Universal Drill Guide 4.5/3.2
319.100	Depth Gauge
314.270	Screwdriver, hexagonal, large

Use the drill bit through the drill guide to predrill the bone. For the neutral position, press the drill guide down in the non-threaded hole. To obtain compression, place the drill guide at the end of the non-threaded hole away from the fracture (do not apply downward pressure on the spring-loaded tip.)

Notes

- All 4.5 mm cortex screws must be inserted into the plate shaft before insertion of any locking screws in the plate shaft.
 - For detailed instructions please consult the Synthes Locking Compression Plate (LCP) Technique Guide (Art. No. 036.000.019).
-



Measure for screw length using the depth gauge.



Select and insert the appropriate length 4.5 mm cortex screw using the screwdriver. Insert as many standard 4.5 mm cortex screws as necessary.



8

Insert 5.0 mm locking screws

Instruments

323.042	LCP Drill Sleeve
310.430	LCP Drill Bit Ø 4.3 mm
319.100	Depth Gauge
511.771	Torque Limiter, 4.0 Nm
● 314.119	Screwdriver Shaft Stardrive, T25, self-holding
● 314.150	Screwdriver Shaft, hexagonal or
314.152	Screwdriver Shaft, hexagonal, self-holding or
324.052	Torque-indicating Screwdriver, 4.0 Nm
397.705	Handle for Torque Limiter Nos. 511.770 and 511.771
311.431	Handle with Quick Coupling

Attach the drill sleeve to the threaded portion of a hole in the plate shaft.

Carefully drill the screw hole using the drill bit. Read the drilled depth directly from the laser mark on the drill bit or determine the screw length with the depth gauge.

Insert the appropriate length 5.0 mm locking screw with a power tool and the torque limiter or manually with a handle and the torque limiter. The screw has to be tightened manually. After one click, the optimum torque is reached.

Notes

- Use of the drill guide is required. It centers the drill bit in the threaded portion of the combi-hole and thus creates a screw trajectory that ensures that the screw engages properly in the plate.
 - Holes for locking screws may be drilled unicortically or bicortically, depending on bone quality.
 - For detailed instructions please consult the Synthes Locking Compression Plate (LCP) Technique Guide (Art. No. 036.000.019).
-



Repeat as necessary to insert additional locking screws.

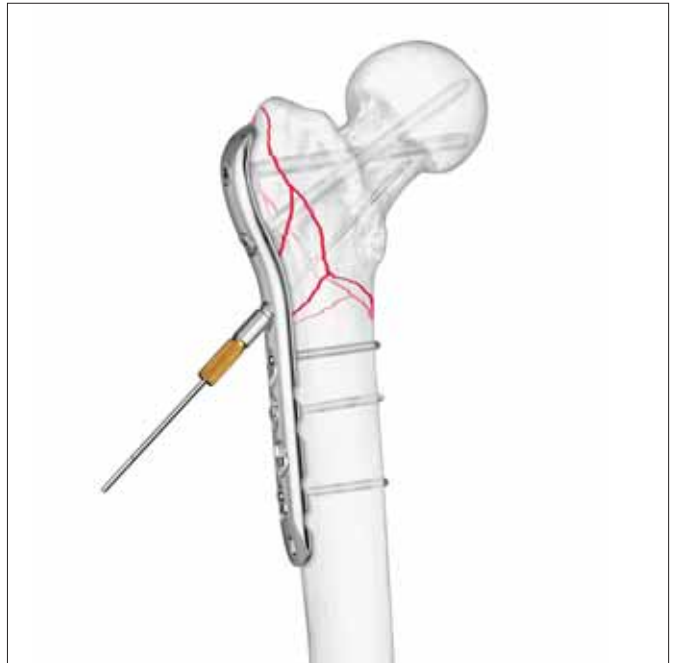

9

Insert oblique 5.0 mm cannulated locking screw

Instruments

319.701	Measuring Device
314.050	Screwdriver, hexagonal, cannulated

Using the wire guide and guide wire previously inserted at this hole location, measure for the screw length with the measuring device. The correct length measurement will place the screw at the tip of the guide wire.

Screw length considerations: The angled 5.0 mm cannulated locking screw in the plate shaft is intended to converge with the 95°, 7.3 mm screw to create a buttress which will provide additional stability. This convergence should occur when using a 5.0 mm cannulated locking screw that is 85 mm in length.

Remove the wire guide and insert the appropriate length screw over the guide wire and into the bone using the screwdriver. Locking screws may be inserted using power equipment. However, final seating and tightening must be done manually.

Notes

- The need for this screw is fracture configuration dependent and should be determined during preoperative planning.
 - Securely tighten all locking screws again prior to closing.
-

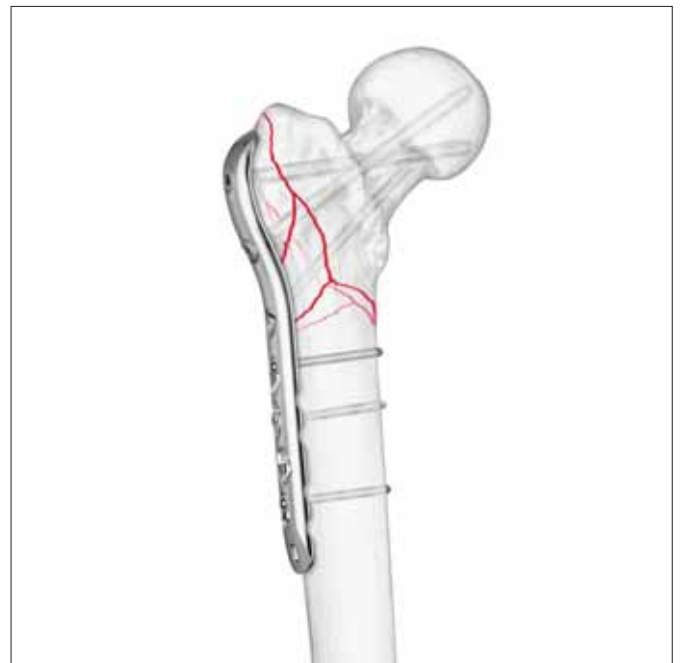

Cleaning

Instruments

319.461	Cleaning Stylet Ø 2.5 mm, for Cannulated Instruments
319.240	Cleaning Brush Ø 2.9 mm, for Cannulated Instruments

Cleaning the cannulation in each instrument is imperative for proper function. Instruments should be cleared intraoperatively using the cleaning stylet to prevent accumulation of debris in the cannulation and potential binding of the instruments about the guide wire. Instruments should be cleaned postoperatively using the stylet and cleaning brush.

Preliminary plate shaft attachment

The Tension Device Ø 4.0 mm (324.033) can be used to approximate the plate shaft to the diaphysis and counteract medial diaphyseal displacement.

Reduction and fixation

- If an extension table is used, careful traction should be applied to prevent the gastrocnemius muscle from pulling the distal fragment posteriorly or into hyperflexion. Posterior support of the distal fragment can assist reduction.
- Sagittal plane reduction may be facilitated using a Schanz screw as a “joystick” in the anterior cortex of the distal fragment. Insertion of a Schanz screw into the proximal fragment may also be helpful. Should it still be impossible to achieve fracture reduction, extend the incision to improve access.
- When using a radiolucent table, towel bumps can be used under the diaphyseal segment to help reduce the fracture in the lateral plane.
- Limb axis can be checked using the C-Arm and a cautery cord from the femoral head to the center of the ankle joint on an AP view. Use the C-Arm at the knee to check that the cord passes 10 mm medially to the center of the knee joint. Adjustment to varus-valgus reduction should be performed before locking screw placement in the malaligned fragment.
- Fractures not treated acutely should be placed in skeletal traction to maintain length until plate fixation can be performed.

Plates

LCP Proximal Femoral Plates 4.5/5.0

Stainless steel	Holes	Length (mm)	
242.802	2	139	right
242.804	4	175	right
242.806	6	211	right
242.808	8	247	right
242.810	10	283	right
242.812	12	319	right
242.814	14	355	right
242.816	16	391	right
<hr/>			
242.102	2	139	left
242.104	4	175	left
242.106	6	211	left
242.108	8	247	left
242.110	10	283	left
242.112	12	319	left
242.114	14	355	left
242.116	16	391	left



All plates are available sterile packed. For sterile implants add suffix S to article number.

Screws

Cannulated Locking Screw \varnothing 7.3 mm
(02.207.020–02.207.145)

- Creates a locked, fixed-angle screw-plate construct
- Threaded conical head
 - Fully threaded shaft
 - Self-drilling, self-tapping tip

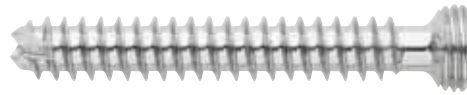

Cannulated Conical Screw \varnothing 7.3 mm
(02.207.250–02.207.295)

- Compresses the plate to the bone
- Smooth conical head
 - Fully threaded shaft
 - Self-drilling, self-tapping tip



Cannulated Conical Screw \varnothing 7.3 mm
(02.207.450–02.207.545)

- Compresses the plate to the bone and provides interfragmentary compression
- Smooth conical head
 - Partially threaded shaft
 - Self-drilling, self-tapping tip



Cannulated Locking Screw \varnothing 5.0 mm
(02.205.025–02.205.145)

- Creates a locked, fixed-angle screw-plate construct
- Threaded conical head
 - Fully threaded shaft
 - Self-drilling, self-tapping tip



Cannulated Conical Screw \varnothing 5.0 mm
(02.205.240–02.205.295)

Compresses the plate to the bone and provides interfrag-
mentary compression

- Smooth conical head
- Partially threaded shaft
- Self-drilling, self-tapping tip



Locking Screw \varnothing 5.0 mm (● 213.314–213.390/
● 212.201–212.227)

Creates a locked, fixed-angle screw-plate construct

- Threaded conical head
- Fully threaded shaft
- Self-tapping tip



Cortex Screw \varnothing 4.5 mm (214.814–214.940)

- May be used in the DCU portion of the combi-holes in the
plate shaft
- Compresses the plate to the bone or creates axial
compression



Drill and Wire Guides

Drill guides for self-tapping screws

323.042 LCP Drill Sleeve 5.0,
for Drill Bits \varnothing 4.3 mm



324.203* Drill Guide \varnothing 4.3 mm, percutaneous,
with thread



Wire guides for cannulated screws

324.174 Wire Guide 5.0, for Guide Wire \varnothing 2.5 mm



324.175 Wire Guide 7.3, for Guide Wire \varnothing 2.5 mm



324.215* Wire Guide 5.0, percutaneous,
for Guide Wire \varnothing 2.5 mm



* Found in the Percutaneous Instrument Set

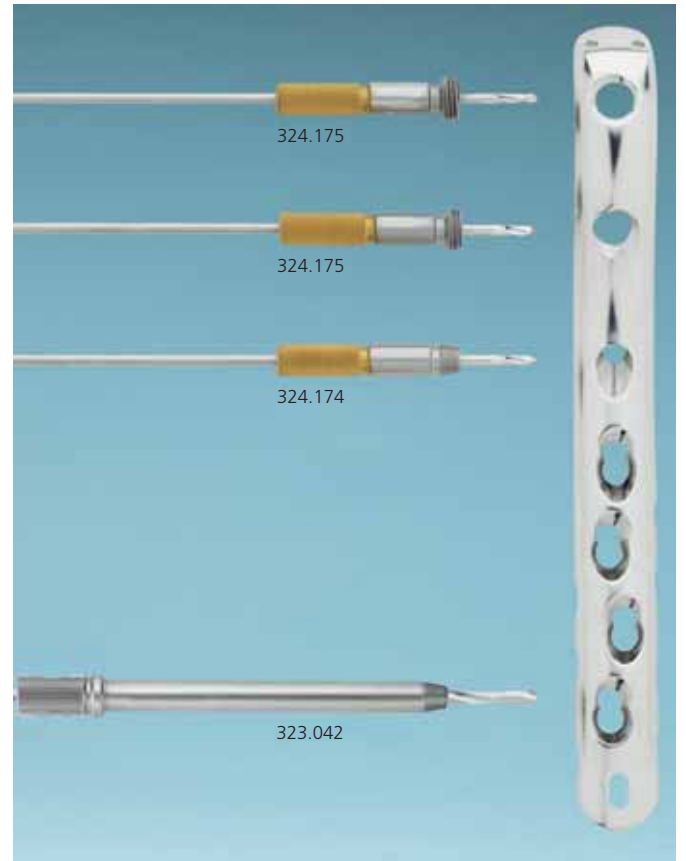

The hexagonal Screwdriver (313.930) and the cannulated hexagonal Screwdriver (314.050) for Cannulated Screws \varnothing 6.5 and 7.3 mm can be used to facilitate insertion and removal of wire and drill guides.

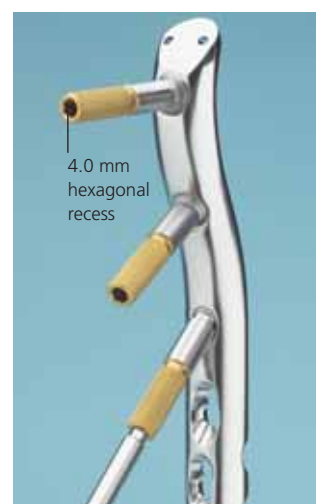

Sets

01.120.021 Periarticular Instruments

68.120.447 Vario Case

68.120.445 Insert

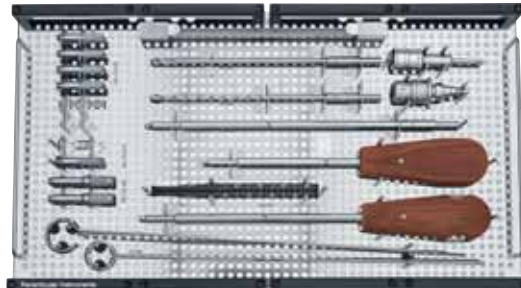

01.120.022 Cannulated Conical and Cannulated Locking Screws \varnothing 7.3 and 5.0 mm (stainless steel)

68.120.450 Sterilizing Tray

Additionally required

- LCP Large Fragment Instrument Set
- LCP Large Fragment Screw Set

01.120.325 **LCP Proximal Femoral Plates 4.5/5.0**

68.120.332 Insert

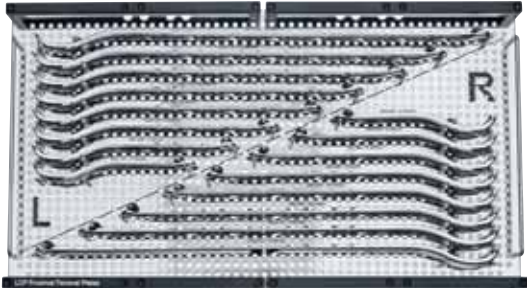



Synthes GmbH
Eimattstrasse 3
CH-4436 Oberdorf
www.synthes.com

Presented by:

