

# Lecture Notes Chem 524 – IR spectra (Part 16)- 2013

For HTML of 2005 notes, [click here](#)

## XII. Infrared Spectroscopy — focus on vibrational transitions (Read Chap 14)

**A. Regions:** -- near IR (800-2500 nm — quartz optics/W-I lamp, diode or thermal detect)

anharmonic vib, overtone and combination bands. Return to this later, specific use

-- mid IR (2500-25000 nm, 2.5-25 $\mu$ , 4000-400  $\text{cm}^{-1}$ ) – (lower limit arb., due to KBr b/s in FTIR)

(glowers, MCT or TGS detect, FTIR best for routine spectra, optics spec. salts-materials)

Access fundamental vibrations, qual. anal. via fingerprint pattern in vibrational modes.

-- far IR (25 $\mu$   $\rightarrow$  ? , 400  $\text{cm}^{-1}$   $\rightarrow$  ? )

(difficult: source, detector, S/N) access torsions, lattice vibration, large amplitude mode

new approach uses THz lasers, excite diode with fs laser, re-emit pulse – FT for spectra

**B. Dispersive IR** (still around, rarely made new – unless homemade from components) – exception  $\downarrow$

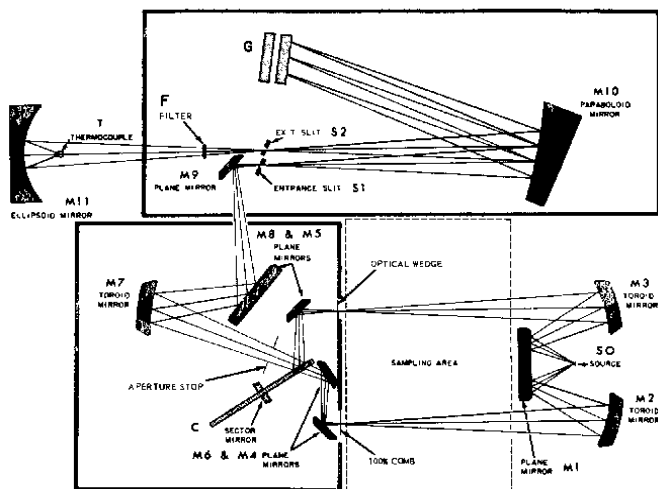

**New Developments in Planar Array Infrared Spectroscopy!**  
I. Pelletier, C. Pellerin, D. Bruce Chase, John F. Rabolt  
APPLIED SPECTROSCOPY 59, 156, 2005

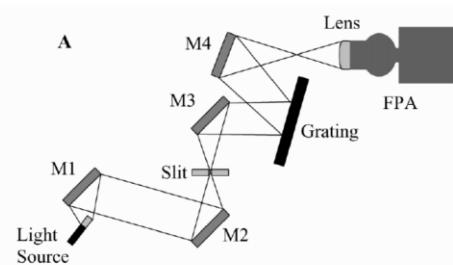

This approach opens up new ways to get either spatial or time dependent information

Dispersive revival

-- same principle as uv/vis double beam

-- chop between ref and sample, meas. Difference

--sample sees source direct

-- multiple gratings/filters to cover range

- scale sometimes change, near to mid-IR

--  $I/I_0$  determined by varying transmission in reference beam with a variable attenuator often a comb or wedge translate at slit coupled to readout, chart recorder

--same idea as diode array uv-vis spectrom.

--detector 2-D can do ref and sample simult.

by putting one above other, sum separate

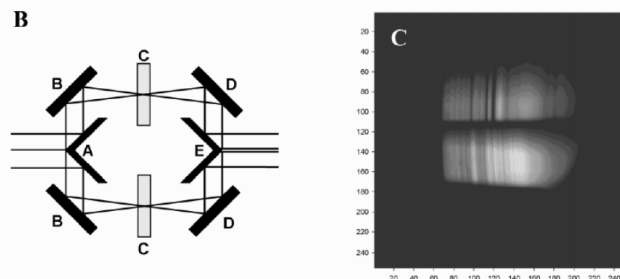

10. 1. (A) Scheme of the PA-IR spectrograph. (B) Scheme of the dual-beam accessory. (C) Spectral image recorded with a polystyrene laced in the top portion of this accessory and air in the bottom portion. On this image, bright areas represent high single beam intensity re

-- [homemade for special](#) purposes ([TAK group](#)) - modulation or kinetics measurement, single beam

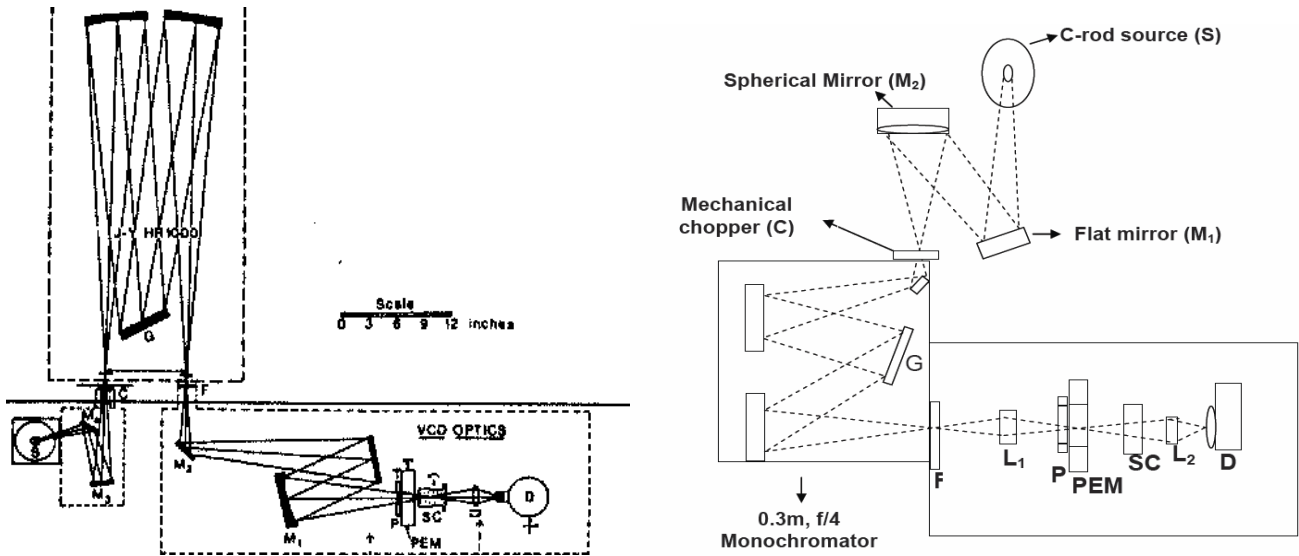

-- also [laser based spectrometers](#) use dispersive element for mode separation

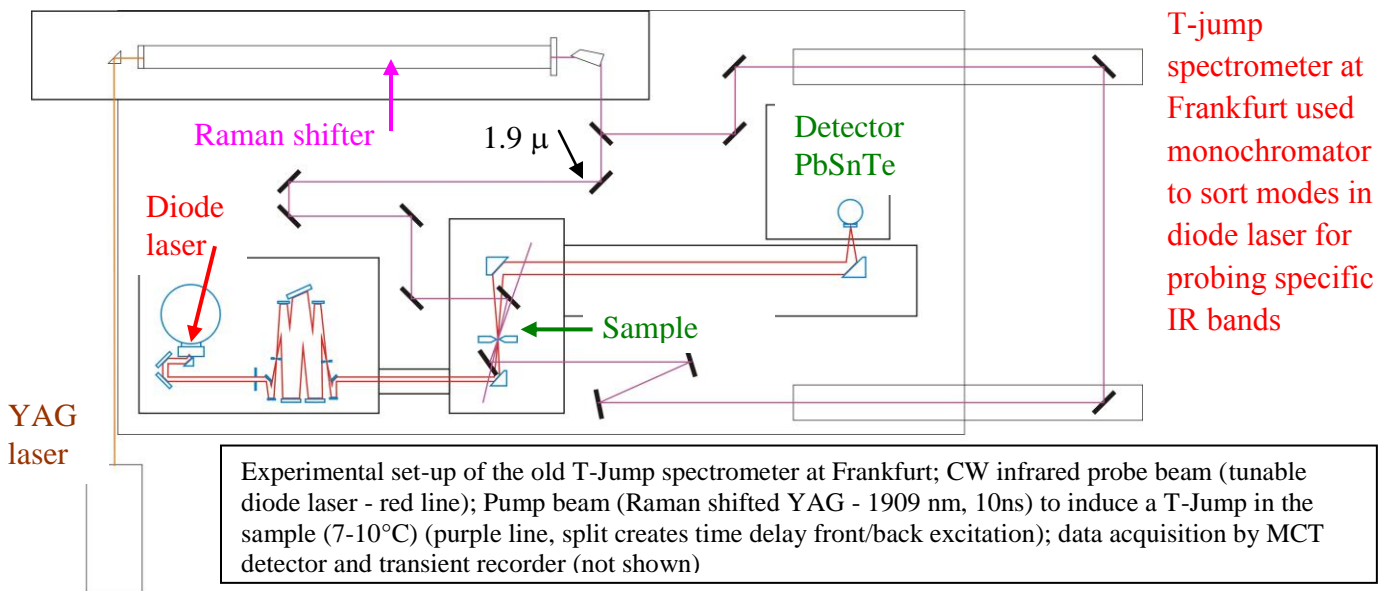

**FIGURE 1.** Schematic of the ultrafast 2D vibrational echo spectrometer showing the wave vectors ( $k_i$ ) and the vibrational echo pulse sequence. These use dispersive IR with multi-detector array (MCT) to get spectrum

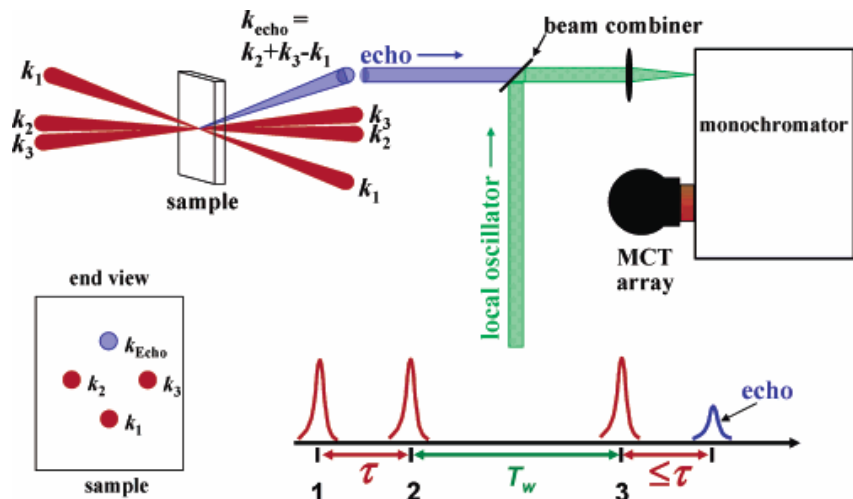

**C. Fourier Transform** — FTIR dominate usage now and commercial market, single beam) - **REVIEW**  
 -- **High end** — air bearing for moving mirror, cooled SiC source, multiple detector (TGS, MCT),  
 high resolution  $<1\text{ cm}^{-1} \rightarrow 0.001\text{ cm}^{-1}$  (rare), multiple beam splitter, purged  
 --(old design used white light fiducial mark, current methods count laser fringes)

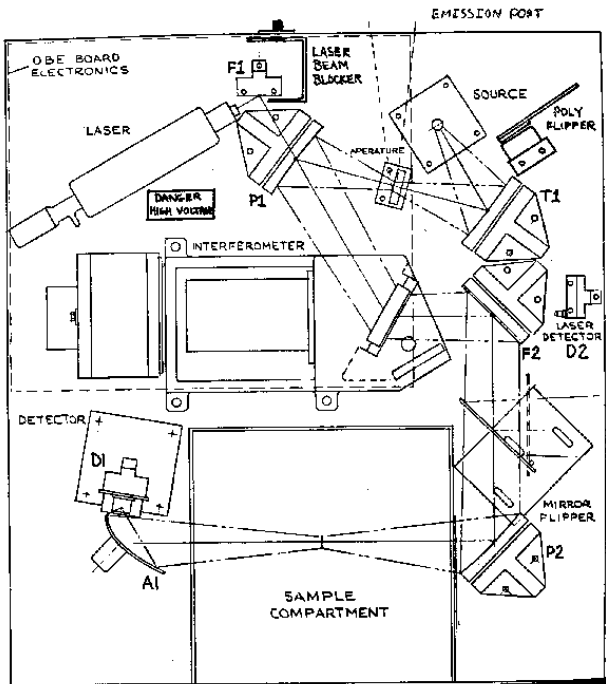

--**external bench**—used for emission/ Raman/ reflection/ modulation / etc.

-- computer control enables multiple tasks (vary mirror scan speed, number scans, averaging, data processing, deconvolution, subtraction, searches)

--**Low end** — mechanical bearing, corner cube mirrors, restricted speed and lower resolution,  $>1\text{ cm}^{-1}$ , uncooled source (lower T), unpurged (dessicant), software--more limited processing/automated

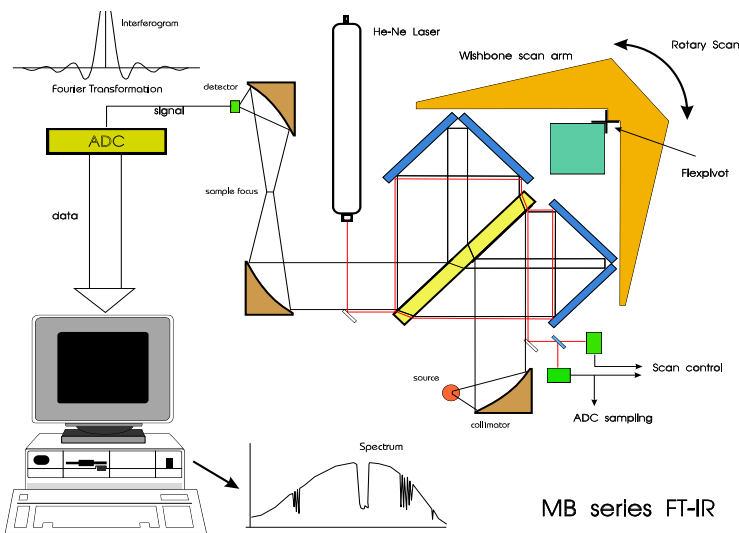

Bomem design, corner cubes keep beam parallel, even tilting mirror

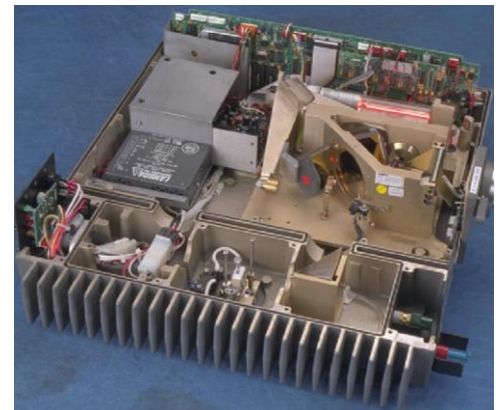

Research level FTIR instruments, all work very well (some examples, also Jasco, Thermo-Nicolet):



Varian (ne. Digilab) 660 Bruker Tensor, Vertex High Resolution Thermo-Nicolet iS-50R  
Typically have multiple ports, dual or more sources and detectors, many sampling options

- **unusual designs** — swing, PE 1700 (pivot), Genzel, 1800 (double B/S), Bomem DA (vertical drop), Bomem Michelson (pivot), sliding wedge – Review of previous interferometer section

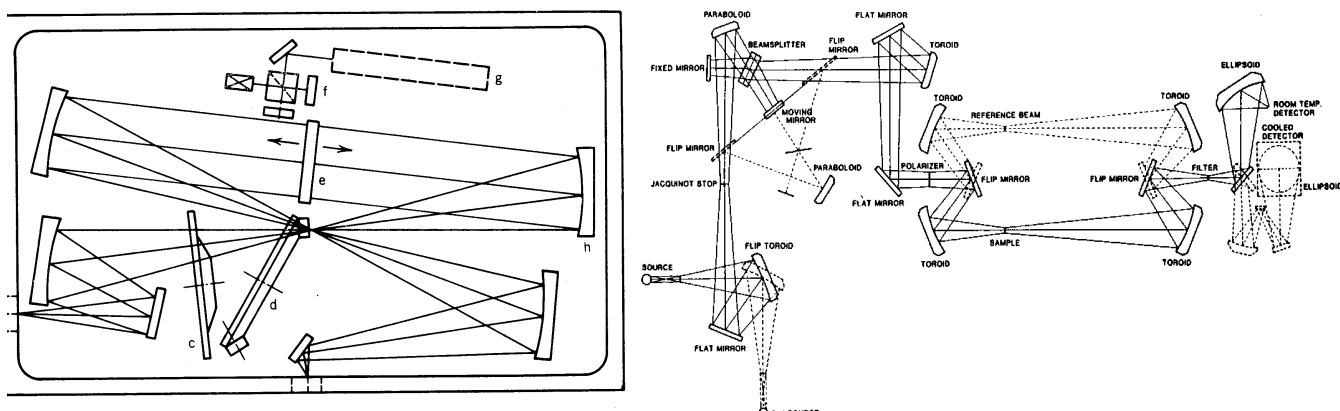

**RECALL:** mini spectrometers now a big market issue:



Bruker Alpha, small footprint: 30 x 22 cm, Thermo (Nicolet) S-10, showing 2 of variable sample chambers - JASCO 4000 and Perkin-Elmer 400 similar ideas  
BOMEM - bigger yet compact, see notes 7

**Handheld also available, seen Notes 7 for examples**



(left) Thermo Ahura  
TruDefender  
(right) Agilent Exoscan



## D. Beam Splitter — Heart of FTIR — (typical: KBr/Ge for mid IR)

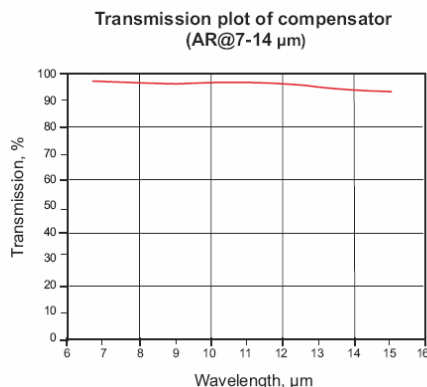

1. **Modulation efficiency**: varies as  $(2RT)I$  — max for  $R = 0.5$  where  $(R+T) = 1$

ideal:  $I(\delta) = 0.5 I(\nu) \cos(2\pi\nu\delta)$

-- typical mid IR uses KBr coated with Ge to partially reflect IR ( $> 1.8 \mu$ )

-- note: alternately B/S can be polarized reflection.

[Polarizing B/S — Martin Puplett](#) --  $I_p(\delta) = 0.5 (I) [1 + \cos 2\pi\nu\delta]$

2. Other regions: coated quartz -- **near IR** -- change source  
mylar (must not acoustical couple to BS)-- **far IR** -- change detector

### ASIDE:

[Near IR variations: Wiki: Near infrared spectroscopy is based on molecular overtone and combination vibrations. Such transitions are forbidden so the molar absorptivity in the near IR region is typically quite small. One advantage is that NIR can typically penetrate much farther into a sample than mid infrared radiation. Near infrared spectroscopy is therefore not a particularly sensitive technique, but it can be very useful in probing bulk material with little or no sample preparation. The molecular overtone and combination bands seen in the near IR are typically very broad, leading to complex spectra. Multivariate (multiple wavelength) calibration techniques (e.g., principal components analysis or partial least squares) are often employed to extract the desired chemical information. Calibration samples and application of multivariate calibration techniques is essential for near infrared.]

Buchi uses birefringent quartz wedges for interferometer, no beam splitter, polarizing the light in and out at  $45^\circ$  makes the intensity modulate for each wavelength as wedge moves



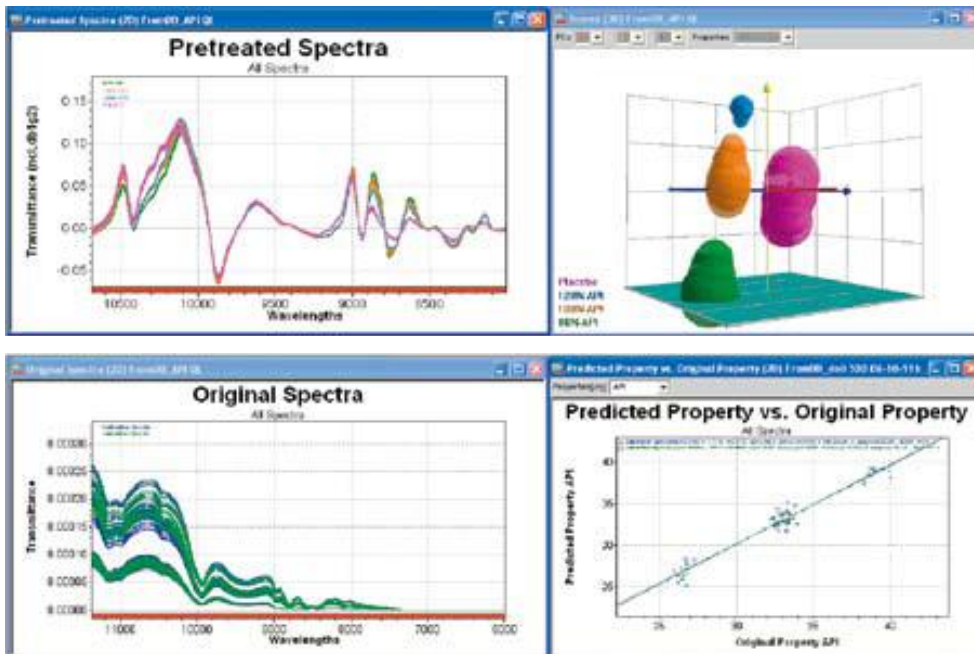

Brimrose goes for portable design, uses AOTF to create spectrum



Zeltex makes portables, each targeted at an application

E. **Sampling** is big issue in IR -- solvent interference -- need for short path – [UK slides, link](#)

1. Gas -- [multipass cell](#) (better with tune laser)



Gas cell heated



demountable



demount liquid



refillable



vary path



ATR long crystal



Flow cells

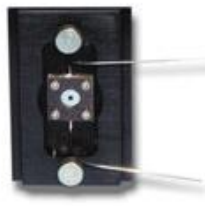

minature



Cards salt substrates



PE substrate

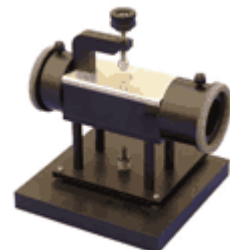

ATR single bounce



3mm Die Set



13mm Die Set



KBr Pellet press



Harrick and



PIKE DRIFTS setup

2. **Liquid** — short path/salt — KBr/CaF<sub>2</sub>/ZnSe ... [window & spacer](#)

-- solvent must not dissolve cell / restrict region

-- **path** from interference fringes  $b = n/2(\Delta\nu)$  → (Fig 14-15)

3. **Small sample** — [beam condenser](#)

-- microscope big appl now/autovials/bio

-- [solids reflection](#) — diffuse — powder — specular — IRAS surface and interface study

4. Can also be used with **GC and HPLC** as detector, not very sensitive, need long path or trick

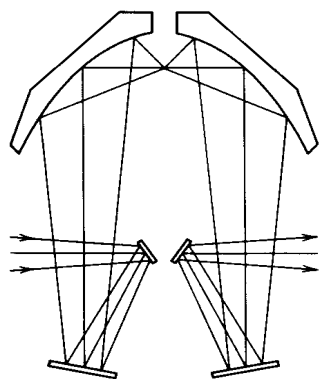

micro IR, shrink beam focus

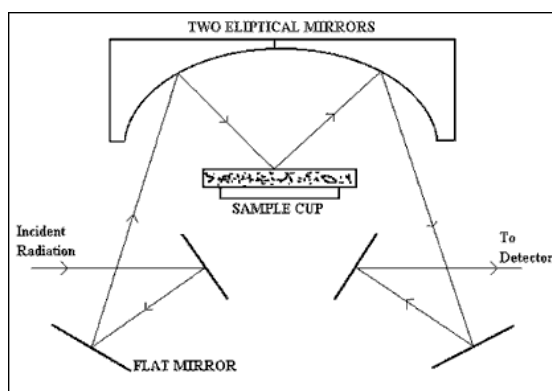

DRIFTS (diffuse reflectance) idea, collect diffuse light, big mirror

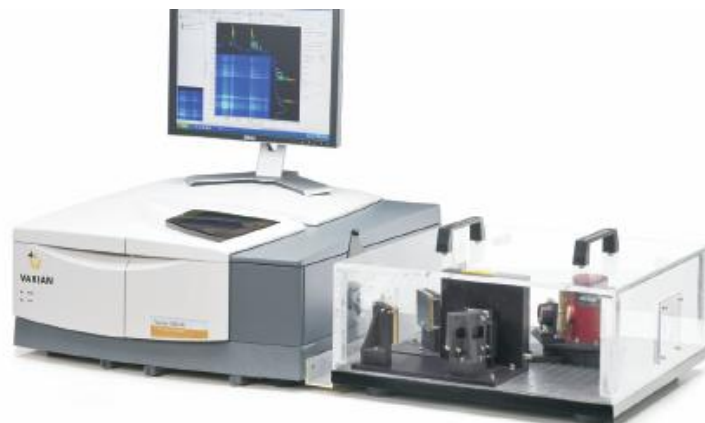
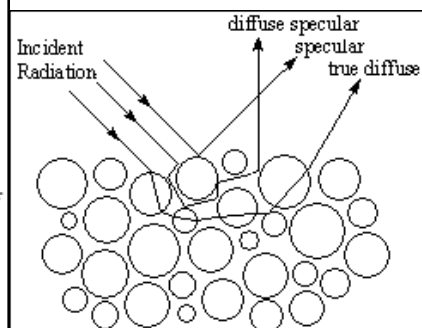

IRRAS setup often in separate compartment, control angle.

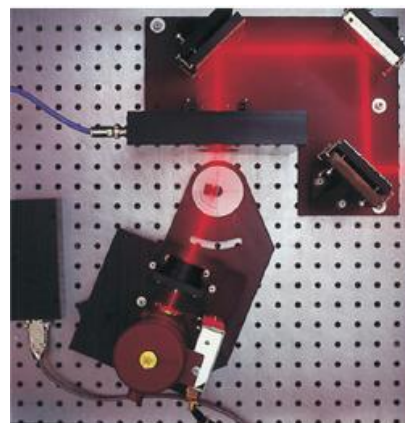

With metal substrate, grazing reflect best

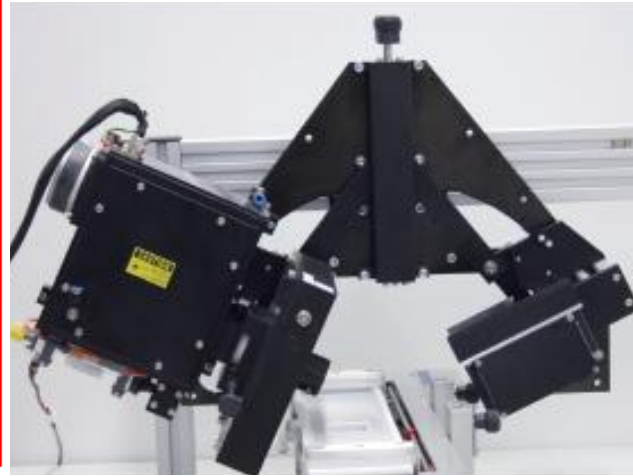
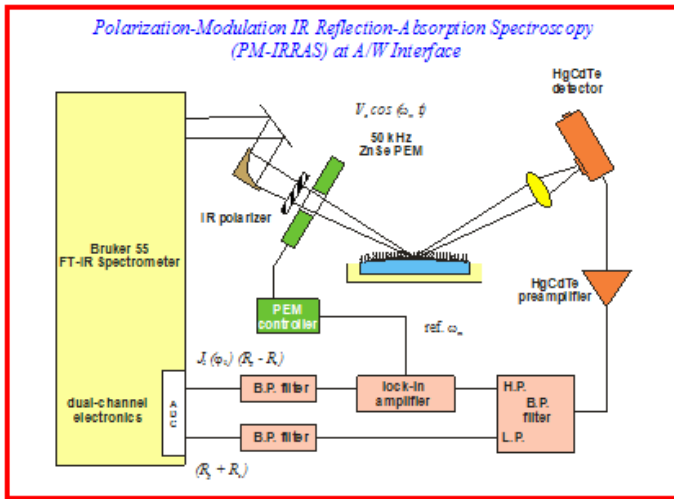

IRAS on an L-B water trough, can look at surface species, like proteins or lipids, separate from solvent

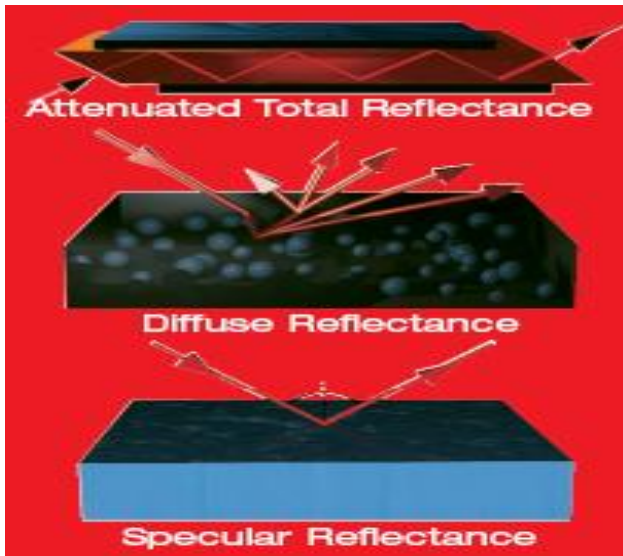

### ATR Polarization Measurements

IR beam multiply reflects inside crystal – penetrates surface  
keeps polarizations:  $E_{perp}$  in surface,  $E_{para}$  partially out

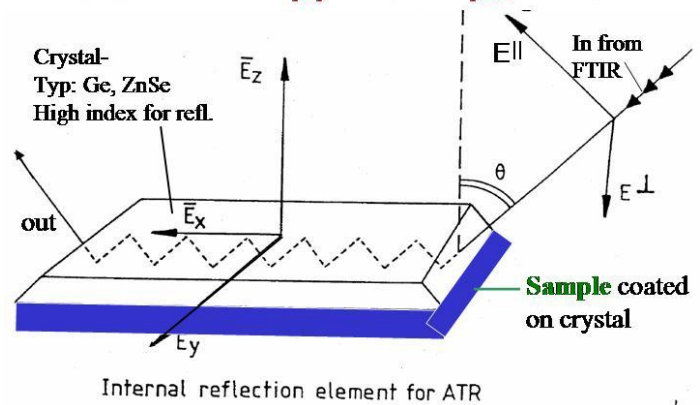

### Insertion of $\beta$ -Lactoglobulin

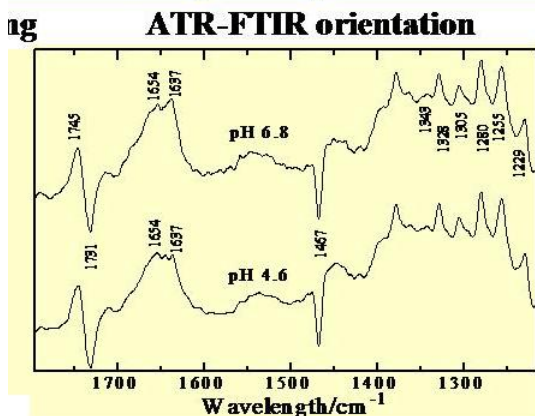

Differential polarization measurement can yield orientation of an oscillator (dipole transition) and from that can derive orientation of molecule on a surface, using ATR, some specular reflection experiment, or oriented sample transmission, also can increase sensitivity  $\rightarrow$  polarization modulation (Linear Dichroism)

Example, protein insert in lipid bilayer, determine helix orientation by comparison to lipid vibration polarization

### $\alpha$ -helix | Membrane surface

Zhang & Keiderling, Biochemistry 2006



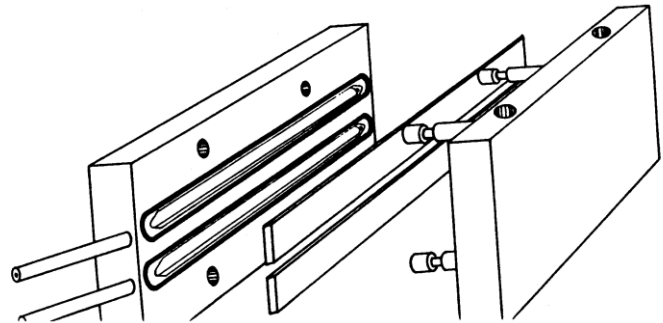
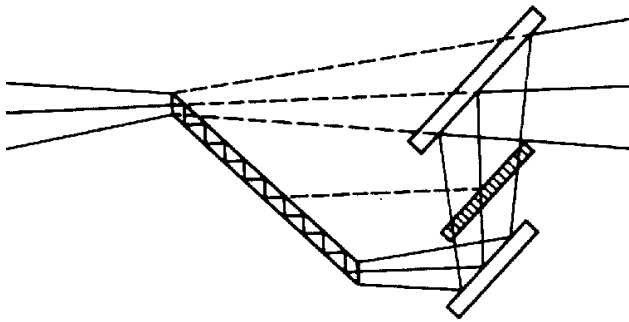

ATR – couple light into crystal, in sample compartment      Flow ATR compare dynamics/equilibrium

5. Big use now days is **microscopy**, chemical and spatial identification

### Microscopy/imaging



Single point data, aperture limit  
Image is spot-to-spot sequential



Imaging system uses focal plane array detectors

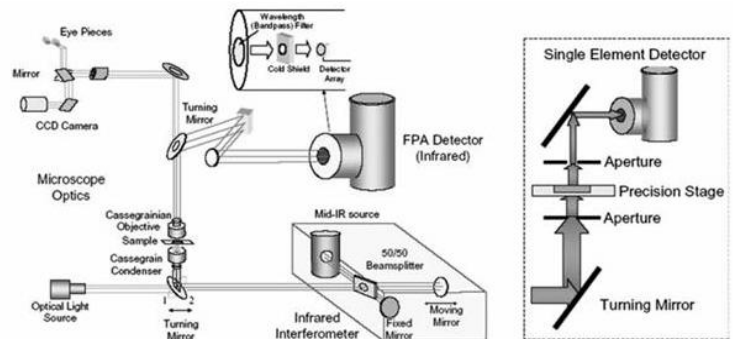
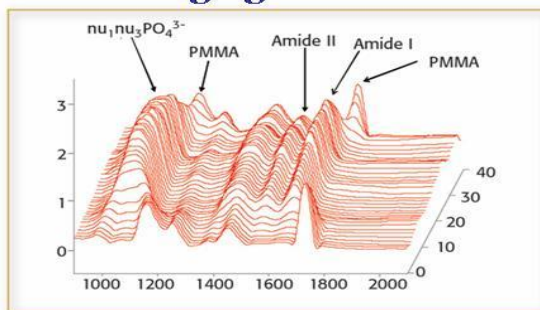

**Figure 1** The configuration of a Fourier transform infrared (FTIR) spectroscopic imaging device consists of an interferometer coupled to a microscope and IR-sensitive focal plane array detector. When a conventional, single-element detector is employed (*right*), the microscope is necessarily equipped with apertures and a precision stage. For multichannel detection (*left*), no apertures are required.

Point is to chemically distinguish analyte with spatial resolution  
Concept old, now wide spread. Problem - **resolution** limit, favor Raman  
**Array detectors** permit very fast images with spatial resolved spectra

**FOURIER TRANSFORM INFRARED VIBRATIONAL SPECTROSCOPIC IMAGING: Integrating Microscopy and Molecular Recognition** *Levin and Rohit Bhargava*  
*Annu. Rev. Phys. Chem. 2005. 56:429–74*

### Bone imaging



IR fingerprints change at each location in the tissue. Key: PMMA: polymethyl-methacrylate; amide I and amide II bands.

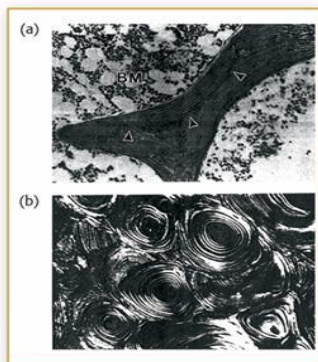

Images of (a) trabecular and (b) cortical bone.

### PerkinElmer Spotlight (microscope)



image by scanning a linear array of detectors – like raster scan)

Paschalis, . . . Mendelsohn, *J. Bone Mineral Res.* **19**, 2000–(2004)  
A. L. Boskey, . . . R. Mendelsohn, *Osteoporosis Int.* (in press).

## F. Applications

1. **Qualitative Analyses** — major use
  - group frequencies characterize band pattern
  - library searches identify compounds
2. **Quantitative** — problem low  $\epsilon$ , short path (due to solvent)
3. **Noise limit** — typically Johnson:  $\sigma_A/A \sim \sigma_{0t}/E_r (-1/T \ln T)$

## G. FTIR can get great S/N, $>10^3$ for $A > 0.1$

1. Baseline correction (single beam) precise subtraction (incl.  $H_2O$ ,  $CO_2$  vapor)
2. Resolution enhance — 2nd derivative
  - Fourier self-deconvolution (emphasize high res part)
  - Component fitting

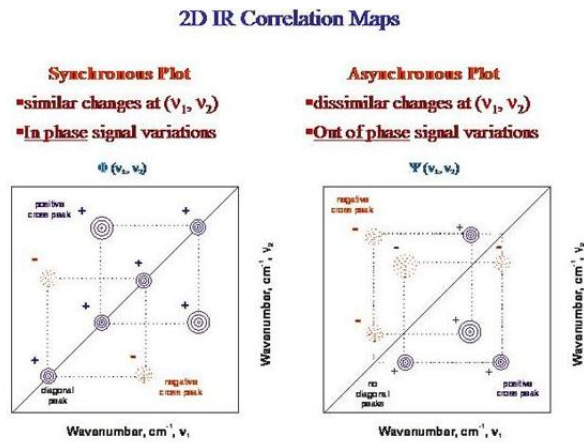
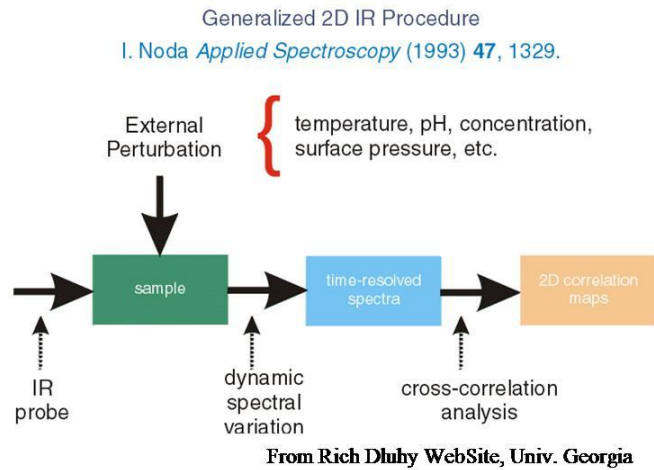

## Kinetics

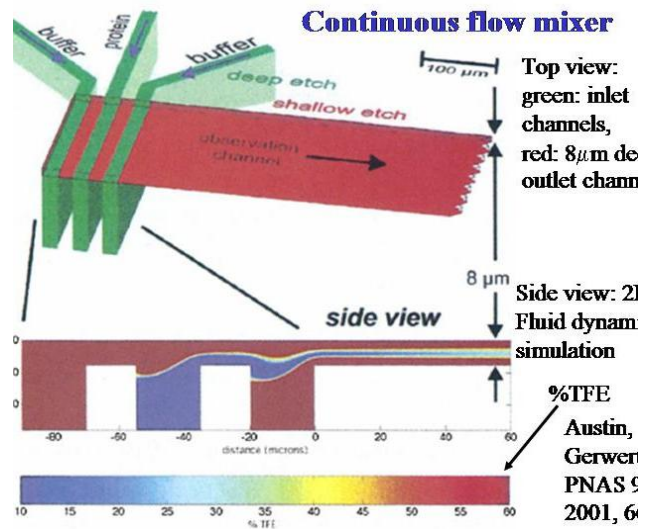
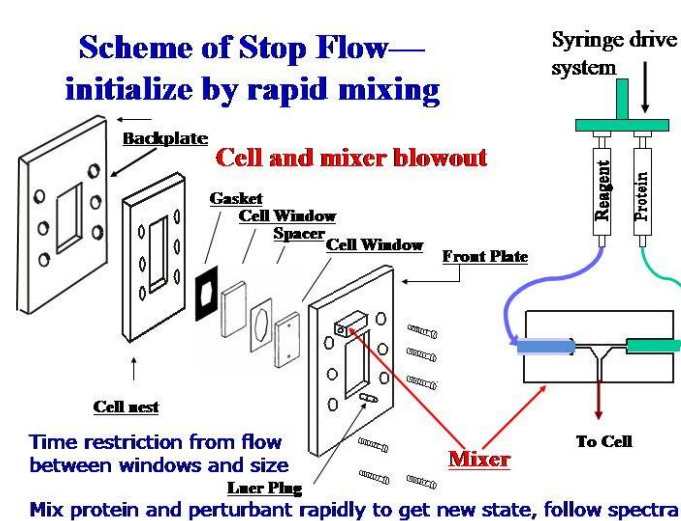

# Step-Scan FTIR based Time-resolved Experiments

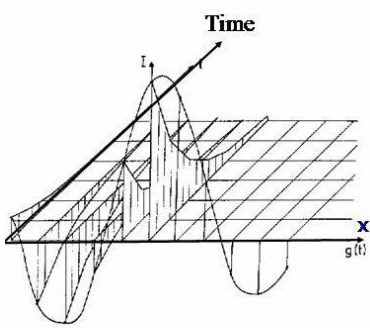

At each mirror position, pulse the sample, then collect signal vs. time (nsec resolution). Move to the next step, repeat. When complete, data from same time delay following the pulse at each step can be combined to form an interferogram for that time. FT gives the spectrum. Requires sample to be cyclic, must reversibly relax.

Step-scan is slow, but at each step can measure very fast decay

# Bacteriorhodopsin - flash photolysis time resolved step-scan

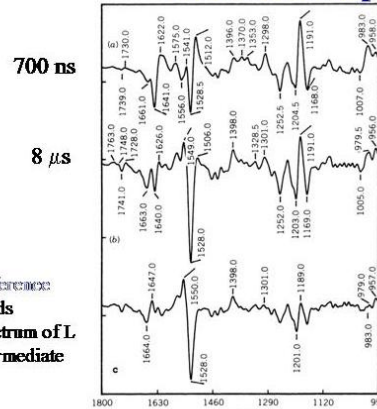

Terrific sensitivity from measuring the baseline for each pulse by recording the signal just before the strobe—no drift

Systems that can be photo initiated to new state (like BR) and relax back reversibly offer possibility of fast kinetics, specific sites

Weidlich, Siebert, Appl. Spect. 1993

## H. Accessories

1. [ATR](#) — sample absorbance close to surface of all through reflectance/evanescent wave penetration, can study films, [liquids \(solutions\) or flow](#)
2. GC/LC detection — 2D idea -- spectrum for each chromatographic peak — qualitative analysis of components--identification
3. [Microscope](#) — multichannel detector (MCT array detector) -- 3D ideal spectrum for each image pixel -- qualitative analysis
4. 2-D correlation spectra — perturb sample observe changes in phase with perturbation
5. 2D-IR coherence spectra are more like COSY in NMR, register anharmonic coupling

## 2D IR Coherence Spectra—like NMR COSY

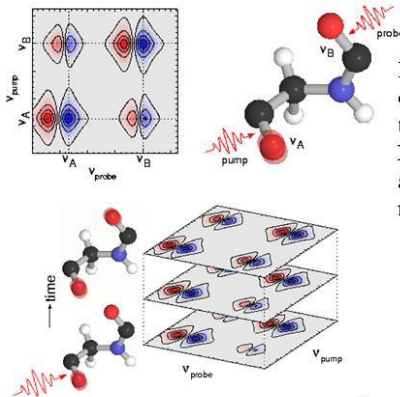

Pump one mode, see effect on other mode through time evolution. Modes must be anharmonic and best if resolved

Figure from Woutersen web site

## Experimental 2D IR setup

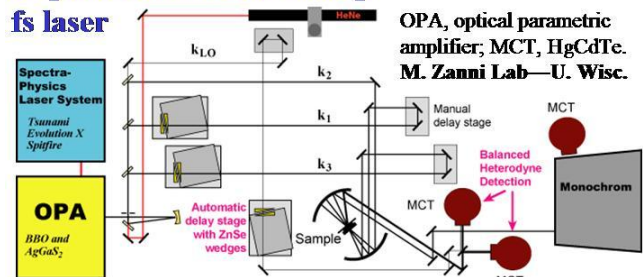

2D IR uses 3 fs pulses, so 2nd excited states are measured. After heterodyning the response signal with a local oscillator pulse, 2D data set is collected and a FT along two time axes gives the 2D IR spectrum. Because overtone and combination bands are measured, 2D IR spectra exhibit cross peaks between coupled vibrational modes.

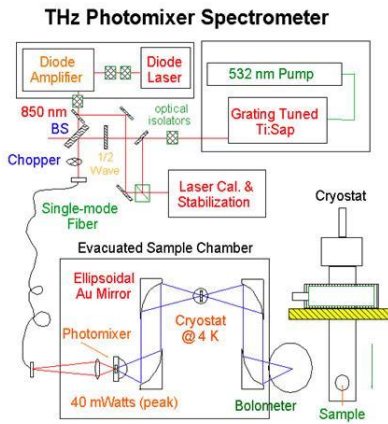

T.M. Korter and D.F. Plusquellic, Chem. Phys. Lett. 385 45-51 (2004)

**NIST cw THz spectrometer.** The system consists of a low-temperature-grown GaAs photomixer driven at the difference frequency of two near-infrared lasers. The two lasers include a fixed frequency diode laser operating near 850 nm and a standing-wave Ti:Sapphire (Ti:Sapp) laser having a resolution of  $(\Delta\nu_{FWHM} \sim 0.0001 \text{ cm}^{-1})$  and a standing-wave Ti:Sapphire (Ti:Sapp) laser having a resolution of  $(\Delta\nu_{FWHM} 0.04 \text{ cm}^{-1})$ . The laser is seeded by feedback from an external grating-tuned cavity for absolute frequency stability.

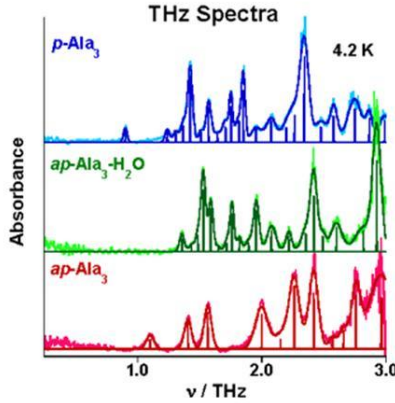

THz spectra of three crystalline forms of Ala3. All three are unique and illustrate the sensitivity in this region to changes in the  $\beta$ -sheet form and the co-crystallized water weakly bound in the lattice.

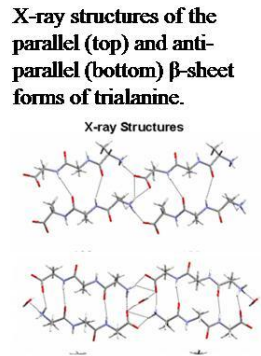

THz spectra in region below  $100\text{cm}^{-1}$ , sense lattice fluctuations, large amplitude motions

Polarization modulation—get chirality/conformation with circular dichroism (VCD) (LD  $\rightarrow$  orientation)

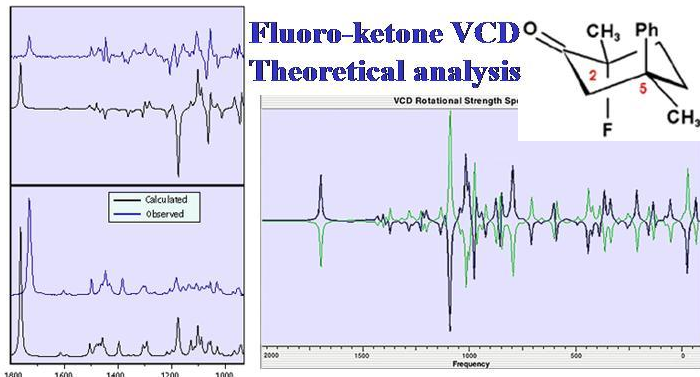
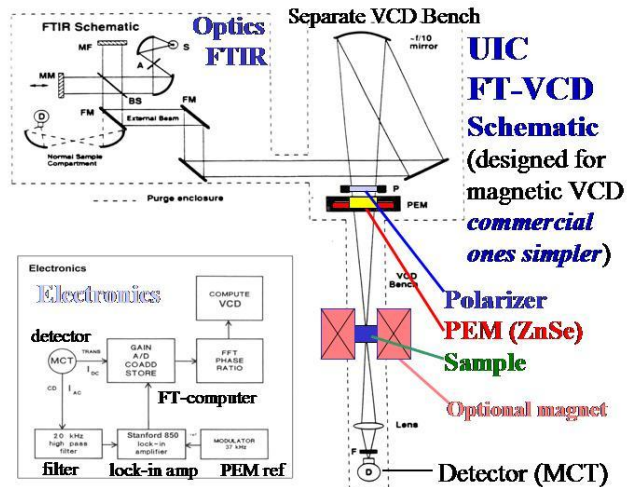
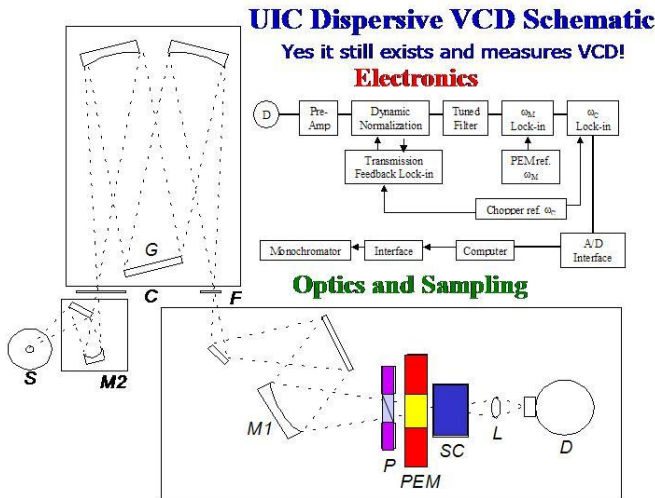

Comparison of the observed and calculated IR (bottom) and VCD (top) spectra for the (R,R) enantiomer. Predicted VCD spectra for the (R,R) and (S,S) enantiomers (blue and green, respectively). P. J. Stephens, Gaussian Web Site

**The VCD success example:  $3_{10}$ -helix vs.  $\alpha$ -helix**

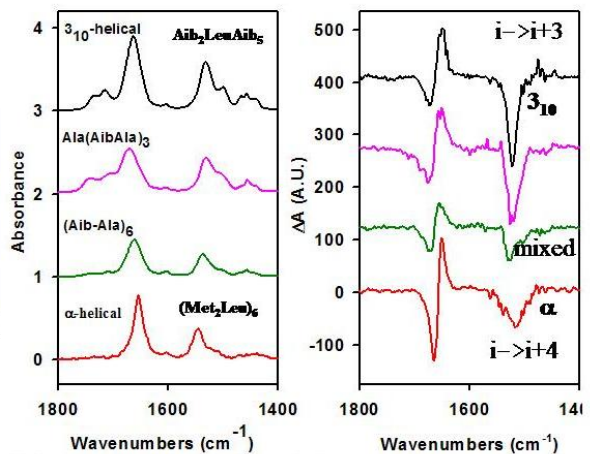

Relative shapes of multiple bands distinguish these similar helices Silva et al. Biopolym

VCD introduces polarization modulation, senses chiral aspects of molecules, drug configuration analysis