

Lecture Notes on
Production Planning and Control

IV B. Tech II semester (JNTUH-R15)

Prepared by

Mr. V. Mahidhar Reddy, Assistant Professor, ME

Mr. M V Aditya Nag, Assistant Professor, ME



DEPARTMENT OF MECHANICAL ENGINEERING
INSTITUTE OF AERONAUTICAL ENGINEERING
(Autonomous)
Dundigal, Hyderabad, Telangana 500043

PRODUCTION PLANNING AND CONTROL

UNIT-I

INTRODUCTION : Definition – Objectives of production Planning and Control – Functions of production planning and control – Elements of production control – Types of production – Organization of production planning and control department – Internal organization of department – Product design factors – Process Planning sheet.

UNIT-II

FORECASTING – Importance of forecasting – Types of forecasting, their uses – General principles of forecasting – Forecasting techniques – qualitative methods and quantitative methods.

UNIT-III

INVENTORY MANAGEMENT : Functions of inventories – relevant inventory costs – ABC analysis – VED analysis – EOQ model – Inventory control systems – P-Systems and Q-Systems.

Introduction to MRP & ERP, LOB (Line of Balance), JIT inventory, and Japanese concepts, Introduction to supply chain management.

UNIT-IV

ROUTING : Definition – Routing procedure – Route sheets – Bill of material – Factors affecting routing procedure. Scheduling – definition – Difference with loading.

SCHEDULING POLICIES : Techniques, Standard scheduling methods. Line Balancing, Aggregate planning, Chase planning, Expediting, controlling aspects.

UNIT-V

DISPATCHING : Activities of dispatcher – Dispatching procedure – follow up – definition – Reason for existence of functions – types of follow up, applications of computer in production planning and control.

TEXT BOOKS:

1. Samuel Eilon, “Elements of Production Planning and Control”, 1st Edition, Universal Publishing Corp., 1999.
2. Baffa & Rakesh Sarin, “Modern Production / Operations Management”, 8th Edition, John Wiley & Sons, 2002.

UNIT 1
INTRODUCTION TO PRODUCTION PLANNING AND CONTROL

Introduction

Production function is that part of an organization, which is concerned with the transformation of a range of inputs into the required outputs (products) having the requisite quality level. Production may be understood as “the step-by-step conversion of one form of material into another form through chemical or mechanical process to create or enhance the utility of the product to the user. Thus production is a value addition process.

In any manufacturing enterprise, the main objective of production department is to produce the things in desired quantity at desired time so that they may be made available to end users when they demand it. Production, being a very complex process is very difficult to manage for the people. This includes a large number of activities and operations which need to be planned appropriately and in turn controlled for the effective production of the output. The main purpose of production planning and control (PPC) is to establish routes and schedules for the work that will ensure the optimum utilization of materials, workers, and machines and to provide the means for ensuring the operation of the plant in accordance with these plans.

There are different types of production systems. The choice of production system depends upon the nature of products, variety of products and volume of products. These production systems have been discussed in this chapter in detail. Entrepreneurs, after finalizing the production system to be used are required to go for the production planning and control (PPC) which essentially depends upon the type of production system.

Production planning and control is necessarily concerned with implementing the plans, i.e. the detailed scheduling of jobs, assigning of workloads to machines (and people), the actual flow of work through the system. Production is an organized activity of converting raw materials into useful products. Production system requires the optimal utilization of natural resources like men, money, machine, materials and time. Production planning and control coordinate with different departments: such as production,

marketing, logistics, warehouse and other departments depending upon the nature of organization. Production planning and control receives data related to orders from marketing departments. Production plan based on marketing and production data is prepared in production planning and control. This production plan provides clear idea about utilization of manufacturing resources for production. Prepared production plan is delivered to production department. Production department manufacture products according to that plan.

The ultimate objective of production planning and control, like that of all other manufacturing controls, is to contribute to the profits of the enterprise. As with inventory management and control, this is accomplished by keeping the customers satisfied through the meeting of delivery schedules.

The main objectives of PPC may be summarized as followings:-

- a) It is used to establish target and check the deviations by comparing on some performance measures.
- b) Decides the nature and magnitude of different input factors to produce the output.
- c) Coordinates different resources of production system in the most effective and economic manner and to coordinate among different departments.
- d) Elimination of bottleneck
- e) Utilization of inventory in the optimal way
- f) Smooth flow of material
- g) To produce in right quantity and quality at right time
- h) Scheduling production activities to meet delivery schedule
- i) Expediting the system under production
- j) To ensure flexibility in production system to accommodate changes and uncertainty
- k) Optimizes the use of resources for minimum overall production cost
- l) To ensure the production of right product at right time in right quantity with specification rightly suited to customers
- m) Stable production system, with least chaos, confusion and undue hurry.

This chapter deals in detail with the concept of production planning and control. This will help the students to understand the PPC to be used for the different types of production

systems along with their merits and demerits. This will also make them familiar with various constraints in PPC.

Meaning of Production

As discussed earlier, production refers to the transformation of inputs into finished goods/ or creation of services in order to satisfy the customer needs. This uses different inputs mainly including 6M's namely, man, material, machine, money, method and management. Production involves application of processes by which the inputs can be transformed into desired product (output) of potential utility while improving properties and adding economic values through the best method without compromising on quality.

Different forms of production based on the processes used:

1. Production by extraction or separation: like petrol, kerosene, sugar etc
2. Production by assembly: car, television, furniture

Edwood Buffa defines production as “a process by which goods and services are created” Some examples of production are: manufacturing custom-made products like, boilers with a specific capacity, constructing flats, some structural fabrication works for selected customers etc. At each stage of processing, there will be value addition. It is easy to understand a production system from the figure 1.1. There are various inputs which essentially pass through a transformation/ conversion process and finally converted into some outputs which have a value for the end users.

The outputs may be in the form of tangible products or services. In nutshell, production system of an organization is that part, which produces products of an organization. It is that activity whereby resources, flowing within a defined system, are combined and transformed in a controlled manner to add value in accordance with the policies communicated by management. A simplified production system is shown above.

etc., and manufacturing standardized products like, car, bus, motor cycle, radio, television, etc.

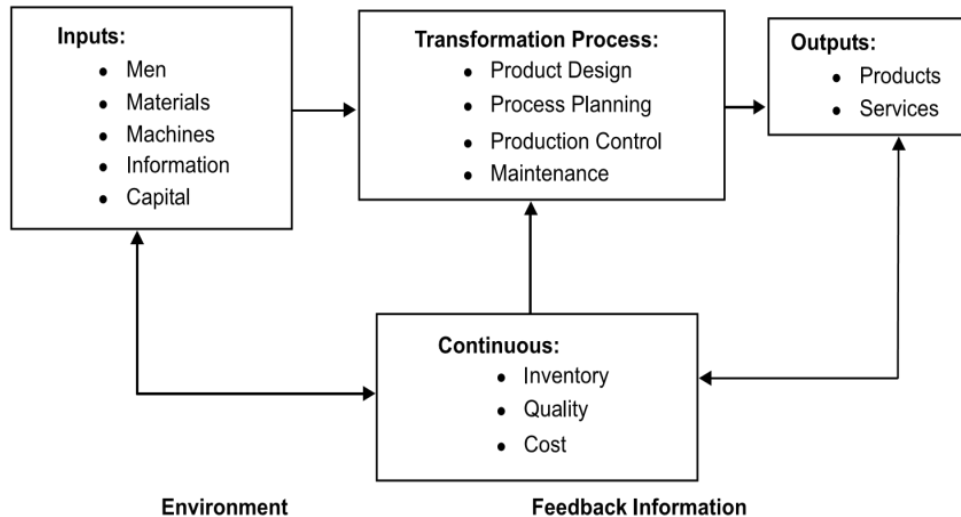

Fig. 1.1 Schematic production system

Production management involves the managerial decisions regarding design of the product and design of the production system i.e. determination of production processes and production planning and control.

Blueprint of Production system

An enterprise in the beginning needs to define its production system that is considered as the framework within which all production related activities and operations take place. Manufacturing process is the transformation process through which inputs are converted into outputs. An appropriate designing of production system ensures the coordination of various production activities and operations. There is no single pattern of production system which is universally applicable in all kinds of enterprises. This varies from one enterprise to another depending upon many parameters.

Types of Production systems

There are mainly three types of production systems mentioned as below:

- (1) Continuous/Mass production
- (2) Job or unit production
- (3) Intermittent/Batch production

- (1) **Continuous/Mass production:** It is used when we need to produce standardized products with a standard set of process and operation sequence in anticipation of demand. This ensures continuous production of output. It is also termed as mass flow production or assembly line production. This system results in less work in process (*wip*) inventory and high product quality but involves high capital investment in machinery and equipment. This ensures very high rate of production as we need not to intervene once the production has begun. The system is appropriate in plants where large volume of small variety of output is produced. e.g. oil refineries, cement manufacturing and sugar factory etc.

Characteristics of Continuous/Mass production:

- a) As same product is manufactured for sufficiently long time, machines can be laid down in order of processing sequence.
 - b) Standard methods and machines are used during part manufacture.
 - c) Most of the equipment's are semi automatic or automatic in nature.
 - d) Material handling is also automatic (such as conveyors).
 - e) Semi-skilled workers are normally employed as most of the facilities are automatic.
 - f) As product flows along a pre-defined line, planning and control of the system is much easier.
 - g) Cost of production per unit is very low owing to the high rate of production.
 - h) In process inventories are low as production scheduling is simple and can be implemented with ease.
- (2) **Job or Unit production:** It involves production as per customer's specifications. This ensures the simultaneous production of large number of batches/orders. Each batch or order comprises of a small lot of identical products and is different from other batches. It requires comparatively smaller investment in machines and equipment. It is flexible and can be adapted to changes in product design and order size without much inconvenience. This system is most suitable where heterogeneous products are produced against specific orders. In this system products are made to satisfy a specific order.

However that order may be produced- only once or at irregular time intervals as and when new order arrives or at regular time intervals to satisfy a continuous demand.

Characteristics of Job or Unit Production:

- a) Machines and methods employed should be general purpose as product changes are quite frequent.
- b) Man power should be skilled enough to deal with changing work conditions.
- c) Schedules are actually nonexistent in this system as no definite data is available on the product. In process inventory will usually be high as accurate plans and schedules do not exist.
- d) Product cost is normally high because of high material and labor costs.
- e) Grouping of machines is done on functional basis (i.e. as lathe section, milling section etc.) This system is very flexible as management has to manufacture varying product types. Material handling systems are also flexible to meet changing product requirements.

- (3) **Intermittent/Batch Production:** This is concerned with the production of different types of products in small quantities usually termed as batches. A batch contains the similar products but in small quantity. This is used to meet a specific order or to meet a continuous demand. Batch can be manufactured either- only once or repeatedly at irregular time intervals as and when demand arise or repeatedly at regular time intervals to satisfy a continuous demand. Under this system the goods may be produced partly for inventory and partly for customer's orders. For example, components are made for inventory but they are combined differently for different customers. e.g. automobile plants, printing presses, electrical goods plant are examples of this type of manufacturing.

Characteristics of Intermittent/ Batch Production:

- a) As final product is somewhat standard and manufactured in batches, economy of scale can be availed to some extent.
- b) Machines are grouped on functional basis similar to the job shop manufacturing.

- c) Semi-automatic, special purpose automatic machines are generally used to take advantage of the similarity among the products.
- d) Labor should be skilled enough to work upon different product batches.
- e) In process inventory is usually high owing to the type of layout and material handling policies adopted.
- f) Semi-automatic material handling systems are most appropriate in conjunction with the semi-automatic machines.

In addition to the above, a large number of manufacturing plants include both intermittent and continuous processes and are classified as *composite or combination operations*. Such a plant may have sub assembly departments making parts in a continuous operation, while the final assembly department works on an intermittent basis.(as in the furniture and custom packaging industries)

Types of Manufacturing Processes

The above mentioned production systems require different types of manufacturing process and require different conditions for their working. Selection of manufacturing process is a strategic decision as any change in the same is very costly and time consuming affair. Therefore the manufacturing process is selected at the stage of planning a business venture. This must be selected keeping in view two important parameters (1) meeting the specification of the final product and (2) to be cost effective.

The manufacturing process is classified into four types.

- (i) Jobbing manufacturing process
- (ii) Batch manufacturing process
- (iii) Mass or flow manufacturing process
- (iv) Process type manufacturing process

- (i) **Jobbing manufacturing process:** This is used to produce one or few units of the products as per the requirement and specification of the customer. Production is to meet the delivery schedule and costs are fixed prior to the contract made with the customer.

- (ii) **Batch manufacturing process:** This is used to produce limited quantities of each of the different types of products in the form of batches. These batches of different products are manufactured on same set of machines. Different batches/products are produced separately one after the other.
- (iii) **Mass or flow manufacturing process:** This is used to produce a large quantity of same product at a time that is stocked for sale. All machines and required equipments are arranged according to the sequence of operations; termed as line arrangement/flow. This ensures very high rate of production. One line arrangement can produce only one type of product, therefore, a different line arrangement is needed for a different product.
- (iv) **Process type manufacturing process:** This is used to produce the products which need a particular process/definite sequence of operations. E.g. petroleum. In this, production run is conducted for an indefinite period.

Factors affecting the Choice of Manufacturing Process

Following factors need to be considered before making a choice of manufacturing process.

a) **Effect of volume/variety:** This is one of the major considerations in selection of manufacturing process. When the volume is low and variety is high, intermittent process is most suitable and with increase in volume and reduction in variety continuous process become suitable. The following figure indicates the choice of manufacturing process as a function of volume and variety.

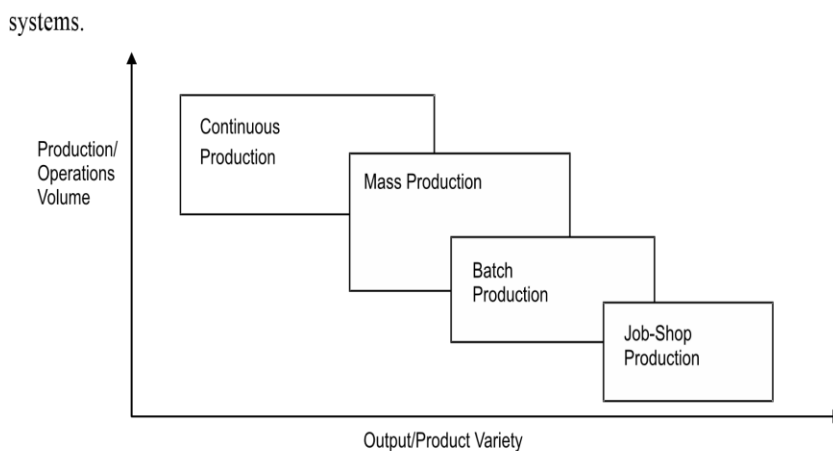

Fig. 1.2 *Classification of production systems*

b) **Capacity of the plant:** Predicted sales volume is the key factor to make a choice between batch and line process. In case of line process, fixed costs are substantially higher than variable costs. The reverse is true for batch process thus at low volume it would be cheaper to install and maintain a batch process and line process becomes economical at higher volumes.

c) **Lead time:** The continuous process normally results faster deliveries as compared to batch process. Therefore lead-time and level of competition certainly influence the choice of production process.

d) **Flexibility and Efficiency:** The manufacturing process needs to be flexible enough to adapt contemplated changes and volume of production should be large enough to lower costs.

Hence it is very important for entrepreneur to consider all above mentioned factors before taking a decision pertaining to the type of manufacturing process to be adopted. As far as Small Scale Enterprises are concerned, they usually adopt batch processes due to less volume of production and low investment.

Once the entrepreneur has made a final choice pertaining to the product design, production system and process, his next critical decision is the production and planning control (PPC) decision.

Meaning of Production Planning and Control:

PPC is a very critical decision which is necessarily required to ensure an efficient and economical production. Planned production is an important feature of any manufacturing industry. Production planning and control (PPC) is a tool to coordinate and integrate the entire manufacturing activities in a production system. This essentially comprises of planning production before actual production activities start and then exercising control over those activities to ensure that the planned production is realized in terms of quantity, quality, delivery schedule and cost of production.

According to Gordon and Carson, PPC usually involve the organization and planning of manufacturing process. Principally, it includes entire organization. The various activities involved in production planning are designing the product, determining the equipment

and capacity requirement, designing the layout of physical facilities and material and material handling system, determining the sequence of operations and the nature of the operations to be performed along with time requirements and specifying certain production and quantity and quality levels.

Production planning also includes the plans of routing, scheduling, dispatching inspection, and coordination, control of materials, methods machines, tools and operating times. Its ultimate objective is the to plan and control the supply and movement of materials and labour, machines utilization and related activities, in order to bring about the desired manufacturing results in terms of quality, quantity, time and place. This provides a physical system together with a set of operating guidelines for efficient conversion of raw materials, human skills and other inputs to finished product.

Procedure of Production Planning and Control

The PPC is entirely based on the pre-design format. It attempts to execute and implement all activities/operations according to the set plan. All operations should be executed in a proper manner with a close vigil on all facts ensuring that the time period and the stipulated costs should not go beyond the reach and it should be done under the excepted/agreed policies. These costs are including the cost of assets, capital cost of the facility, and labour. The PPC consists of the following steps.

- a) Forecasting the demands of the customers for the products and services.
- b) In advance preparing the production budget.
- c) Design the facility layout.
- d) Specify the types of machines and equipment.
- e) Appropriate production requirements of the raw materials, labour, and machinery.
- f) Drawing the apt schedule of the production.
- g) Confirming the shortage or any excess of the end product.
- h) Future plans are drawn for any sudden surge in the demand for the product.
- i) The rate and scale of production is setup. Which needs to be broken into realistic time periods and scheduling. The specified job needs to be done in the amount of time provided so that the production can move to next step.

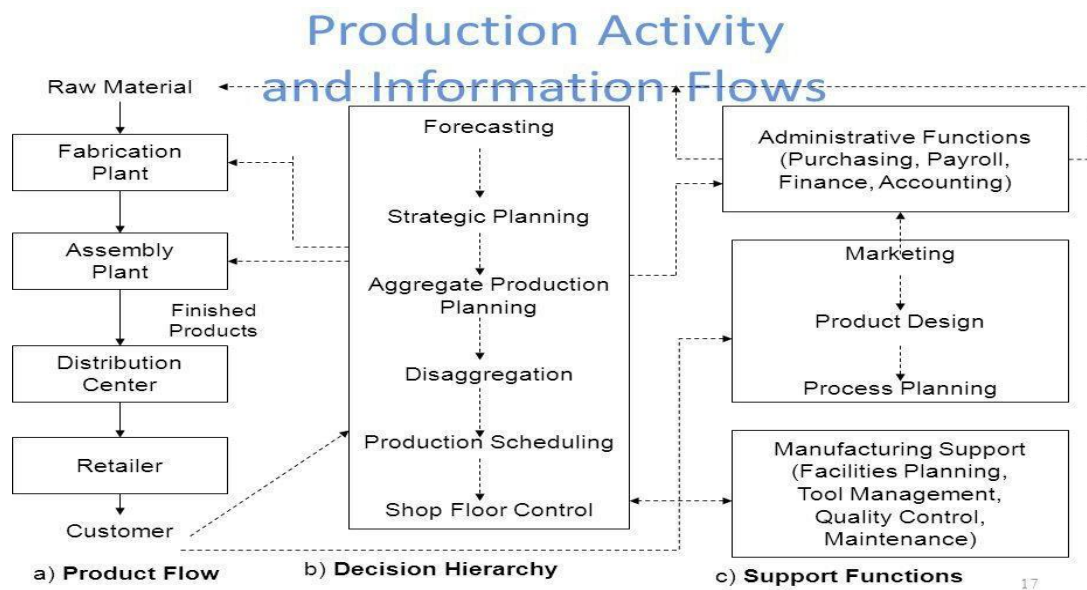

PPC essentially consists of three Stages:

- a) Planning stage
- b) Action stage
- c) Monitoring stage

All these three stages are very important from the point of view to production because without planning no production work can take off at all. The foremost thing which is required for any production is a proper planning.

Elements of Production Planning and Control

This is important to note that production plan is the first and the foremost element of PPC. Planning refers to deciding in advance what is to be done in future. A separate planning department is established in the organization which is responsible for the preparation of policies and plans with regard to production to be undertaken in due course. The planning department prepares various charts, manuals production budgets etc., on the basis of information received from management. These plans and charts or production budgets are given practical shape by carrying various elements under production control. If production planning is defective, production control is bound to be

adversely affected. For achieving the production targets, production planning provides sound basis for production control.

One needs to remember that production plans are prepared in advance at top level whereas, production control is exercised at machine shop floor (bottom level) where actual production is taking place. Some important elements of PPC have been depicted in the figure as below:

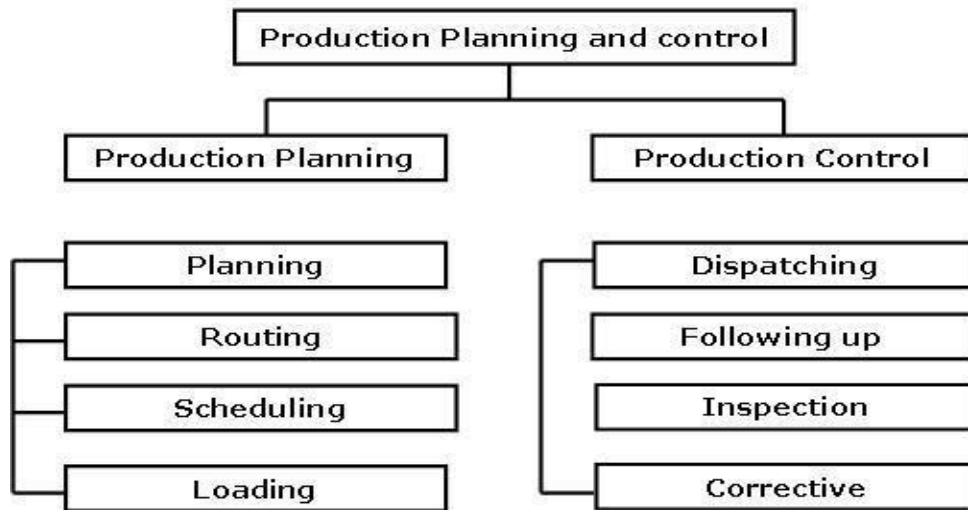

The important elements may be listed as following:

1. **Materials:** planning for procurement of raw material, component and spare parts in the right quantities and specifications at the right time from the right source at the right place. Purchasing, storage, inventory control, standardization, variety reduction, value analysis and inspection are the other activities associated with material.
2. **Method:** choosing the best method of processing form several alternatives. It also includes determining the best sequence of operations (process plan) and planning for tooling, jigs and fixtures etc.

3. **Machines and equipment:** manufacturing methods are related to production facilities available in production systems. It involves facilities planning, capacity planning, allocations, and utilization of plant and equipment, machines etc.
4. **Manpower:** planning for manpower (labour and managerial levels) having appropriate skills and expertise.
5. **Routing;** determining the flow of work material handling in the plant, and sequence of operations or processing steps. This is related to consideration of appropriate shop layout plant layout, temporary storage location for raw materials, component and semi-finished goods, and of materials handling system.

Route Sheet: a route sheet is a document providing information and instructions for converting the raw material in finished part or product. It defines each step of the production operations and lay down the precise path or route through which the product will flow during the conversion process. Route sheet contains following information:

- a) The operation required at their desired sequence
 - b) Machines or equipment to be used for each operations
 - c) Estimated set-up time and operation time per piece
 - d) Tools, jigs, and fixtures required for operations
 - e) Detailed drawings of the part, sub-assemblies and final assemblies
 - f) Specification, dimensions, tolerances, surface finishes and quality standard to be achieved
 - g) Specification of raw material to be used
 - h) Speed, feed etc. to be used in machines tools for operations to be carried on.
 - i) Inspection procedure and metrology tools required for inspection
 - j) Packing and handling instructions during movement of parts and subassemblies through the operation stages.
6. **Estimating:** Establishing operation times leading to fixations of performance standards both for worker and machines. Estimating involves deciding the quantity of the product which needs to be produced and cost involved in it on the basis of sale forecast.

Estimating manpower, machine capacity and material required meeting the planned production targets are like the key activities before budgeting for resources.

7. **Loading:** machine loading is the process of converting operation schedule into practices in conjunctions with routing. Machine loading is the process assigning specific jobs to machines, men, or work centers based on relative priorities and capacity utilization. Loading ensures maximum possible utilization of productive facilities and avoid bottleneck in production. It's important to either overloading or under loading the facilities, work centers or machines to ensure maximum utilization of resources.
8. **Scheduling:** scheduling ensure that parts and sub-assemblies and finished goods are completed as per required delivery dates. It provides a timetable for manufacturing activities.

Purpose of scheduling:

- a) To prevent unbalance use of time among work and centers and department.
 - b) To utilize labour such a way that output is produced within established lead time or cycle time so as to deliver the products on time and complete production in minimum total cost.
9. **Dispatching:** This is concerned with the execution of the planning functions. It gives necessary authority to start a particular work which has already planned under routing and scheduling functions. Dispatching is release of orders and instructions for starting of production in accordance with routing sheet and scheduling charts.
 10. **Inspection:** This function is related to maintenance of quality in production and of evaluating the efficiency of the processes, methods and labours so that improvement can be made to achieve the quality standard set by product design.
 11. **Evaluating:** The objective of evaluating is to improve performance. Performance of machines, processes and labour is evaluated to improve the same.
 12. **Cost control:** Manufacturing cost is controlled by wastage reduction, value analysis, inventory control and efficient utilization of all resources.

Requirements for an effective Production Planning and Control

In an organization, PPC system can be effective only if the following aspects are given due considerations before implementation:

- a) Appropriate organization structure with sufficient delegation of authority and responsibility at various levels of manpower.
- b) Right person should be deputed at right place for right job.
- c) Maximum level of standardization of inventory, tooling, manpower, job, workmanship, equipment, etc.
- d) Appropriate management decision for production schedule, materials controls, inventory and manpower turnover and product mix.
- e) Flexible production system to adjust any changes in demand, any problem in production or availability of materials maintenance requirements, etc
- f) Estimation of accurate leads times for both manufacturing and purchase.
- g) Management information system should be reliable, efficient and supporting.
- h) Capacity to produce should be sufficient to meet the demand.
- i) The facility should be responsive enough to produce new products change of products mix and be able to change the production rates.

The above elements are very important and necessary to make the production planning system effective and efficient.

Utility of PPC Productions

The implementation of PPC based production system yields various advantages to any organization for various functional activities, which include the following:

- a) **Last hour rush is avoided:** Production is well planned and controlled as per the given time schedules. Therefore, production control reduces the number of emergency order and overtime works on plant and thus reduces the overheads.
- b) **Problems areas of bottleneck get reduced:** The incomplete work or work-in-transit does not get piled up because production control balances the line and flow of work.
- c) **Cost reduction:** An appropriate production control increases the men-machines utilization, which maintains in process inventories at a satisfactory level, leads to a better control on raw material inventories, reduces costs of storage and materials

handling, helps in maintaining quality and limits rejections and thus ultimately reduces the unit cost of production.

- d) **Optimum utilization of resources:** It reduces the time loss of the workers waiting for materials and makes most effective use of equipment.
- e) **Better coordination of plants activities:** PPC coordinates the activities of the plant that leads to control concerted effort by workforce.
- f) **Benefits to workers:** PPC results into better efficiency and productivity, which leads to adequate wages stable employment, job security, improved working conditions increased job satisfaction and ultimately high morale.
- g) **Improved services to customers:** PPC leads to better services to the customers as it ensures production in accordance with the time schedules and therefore, deliveries are made as per the committed schedules.

Scope of Production Planning and Control

a) Nature of Inputs

To manufacture a product, different types of inputs are used. The quality of the product depends upon the nature of the inputs are used. Hence the planning is done to determine the nature of various types of inputs which is a complicated process.

b) Quantity of Inputs

To achieve a level of production, determination of quantity of the inputs and their composition is very important. A product can be prepared only when there is an estimate of the required composition of inputs.

c) Proper Coordination

It ensures the proper coordination among the workforce, machines and equipment. This leads to avoidance of wastages and smooth flow of production.

d) Better Control

Production planning is the method of control. For a better control, planning is a precondition. Only then, one can compare the performance and calculate the deviations which lead control of the production.

e) Ensure Uninterrupted Production

The planning of materials ensures the regular supply of raw materials and other components. The regular flow of materials and supplies are helpful in the uninterrupted production.

f) Capacity Utilization

There is a need to use the available resources effectively. It is helpful in bringing down various costs of production.

g) Timely Delivered

If there is good production planning and control, there will be timely production and the finished product will be rushed to the market in time. This also ensures the better relationship with the customers.

Factors affecting Production Planning and control

- a) Use of Computers: Modern factories are using office automation equipment like PC, punch cards etc. It helps accurate computation of required of men and machine.
- b) Seasonal Variations: Demand of certain products is affected by seasons, for instance umbrellas and raincoats during the monsoons and outputs. Production planning and control must take such changes into consideration while planning and control activities of inputs and outputs.
- c) Test Marketing: In an aggressive marketing strategy new products are to be test marketed in order to know the trends. This is a short- cycle operation, intermittent in nature and often upsets regular production.
- d) After Sales Service: This has become an important parameter for success. In after sales services, many items are returned for repair. These are unscheduled Work and also overload the production line.

- e) Losses due to Unpredictable Factors: Losses occur due to accidents, fire and theft of production inputs, mainly materials and Components. These are unpredictable. Shortage of input due to such factors upset the planned production schedule in time and quantity.
- f) Losses due to Predictable Factors: There are losses of inputs, due to natural engineering phenomena like production losses and changes in consumption of materials and occurrence of defectives.

Summary

Production function in a manufacturing organization is concerned with the transformation of some inputs into some outputs that have some value for the end users. There are many types of production systems namely mass, process, batch and job production systems. The selection of system depends upon mainly two things: i) nature of the product, ii) type of manufacturing process.

Production planning and control can be viewed as nervous system of the production operation. This function aims at efficient utilization of material resources, people and facilities in any undertaking through planning, coordinating and controlling the production activities that transform the raw material into finished products or components as a most optimal manner. All the activities in manufacturing or production cycle must be planned, coordinated, organized and controlling to its objectives. Production planning and control as a department plays a vital role in manufacturing organizations. It is clear from name that it is something about planning. Planning is defined as setting goals. Production planning and control provides different kinds of information to different departments. It provides information about available manufacturing resources to marketing department. Marketing department receives orders according to that information. Similarly, it coordinates with other departments and provides relevant information.

Production planning being a managerial function is mainly concerned with the following important issues:

- a) What production facilities are required?
- b) How these production facilities should be laid down in the space available for production?

- c) How they should be used to produce the desired products at the desired rate of production?

Broadly speaking, production planning is concerned with two main aspects: (i) routing or planning work tasks (ii) layout or spatial relationship between the resources. Production planning is dynamic in nature and always remains in fluid state as plans may have to be changed according to the changes in circumstances.

Production control is a mechanism to monitor the execution of the plans. It has several important functions:

- a) Making sure that production operations are started at planned places and planned times.
- b) Observing progress of the operations and recording it properly.
- c) Analyzing the recorded data with the plans and measuring the deviations.
- d) Taking immediate corrective actions to minimize the negative impact of deviations from the plans.
- e) Feeding back the recorded information to the planning section in order to improve future plans.

Self assessment Question

- a) Discuss the different types of production systems.
- b) Explain the parameters that must be considered before finalizing the production system.
- c) “Effective PPC guarantees better utilization of resources”. Comment on the statement with justification.
- d) What do you mean by production planning? Discuss its elements.
- e) Explain the utility of PPC based production.

2.0 Key Words

- a) **Scheduling:** is the timetable for manufacturing activities.
- b) **Estimating:** is a process of setting operation times after fixing standards both for worker and machines
- c) **Loading:** is the process of converting operation schedule into practices

- d) **Routing:** is the process of determining the flow of work material handling in the plant, and sequence of operations

2.1 References

- a) Rama Murthy, P., *Production and Operations Management*, New Age International Publishers, 2005
- b) Chase, R.B., Aquilano, N.J., and Jacobs, F.R., *Production and Operations Management: Manufacturing and Services*, Richard D. Irwin, Inc., 1998.
- c) Narshimha, S.L., *Production Planning and Inventory Control*, PHI, 2002
- d) Garg, A.K., *Production and Operations Management*, Mc GrawHill, 2012
- e) Chary, S.N., *Operations Management*, TMH, 1996
- f) Baffa and Sarin, R., *Modern Production/ Operations Management*, John wiley and Sons,2002

Material Requirements Planning is primarily related to the inventory of raw materials and components which are required to produce the products in a facility. Their demand is usually termed as secondary demand that totally depends upon the demand of finished product. The demand for the finished products is known as primary demand. This primary demand is ascertained mainly by aggregating the demand from sales orders and forecasted demand. Then, keeping in view the product structure, secondary demand that is the demand for the various components and raw materials is ascertained. There are various techniques which may be used to determine the order lot size for components and raw materials. MRP is a time phased priority-planning technique that estimates material requirements and schedules supply to meet demand across all products and parts in one or more plants. Now- a- days, information technology plays a major role in designing and implementing Material Requirements Planning systems and processes as it provides information about manufacturing needs (linked with customer demand) as well as information about inventory levels. MRP techniques focus on optimizing inventory.

Concept of Material Requirement Planning

Material Requirements Planning is basically concerned with the inventory of raw materials and components which are required to produce the products in a facility. The demand for raw materials and components is termed as secondary demand which is essentially depending upon the demand for the finished products. At current, globalization of the economy and the liberalization of the trade markets have created new conditions in the market place which are characterized by turbulence and intensive competition in the business environment. Competition is continuously growing with respect to price, quality and selection, service and promptness of delivery. Removal of barriers, international cooperation, technological innovations naturally cause competition to Intensify. In terms of manufacturing emphasis is placed on reducing cost while improving quality. In addition, other factors such as timely delivery of the product become critical (*this is captured by emphasis in Just in Time or JIT in short*) techniques.

It is a time phased priority-planning technique that estimates material requirements and schedules supply to meet demand across all products and parts in one or more plants. MRP

techniques are used to explode bills of material, to compute net material requirements and plan future production.

Information Technology plays a major role in designing and implementing Material Requirements Planning systems and processes as it provides information about manufacturing needs (linked with customer demand) as well as information about inventory levels. MRP techniques focus on optimizing inventory.

MRP systems mainly use following information to determine what material should be ordered and when:-

- The master production schedule, which describes when each product is scheduled to be manufactured;
- Bill of materials, which lists exactly the parts or materials required to make each product;
- Production cycle times and material needs at each stage of the production cycle time;
- Supplier lead -times.

In figure 1, you can see the overall view of the Inputs to a Standard Material Requirements system and the various reports generated by the system which are of immense importance for the production managers.

The master schedule and bill of materials indicate what materials should be ordered; the master schedule, production cycle times and supplier lead times then jointly determine when orders need to be placed.

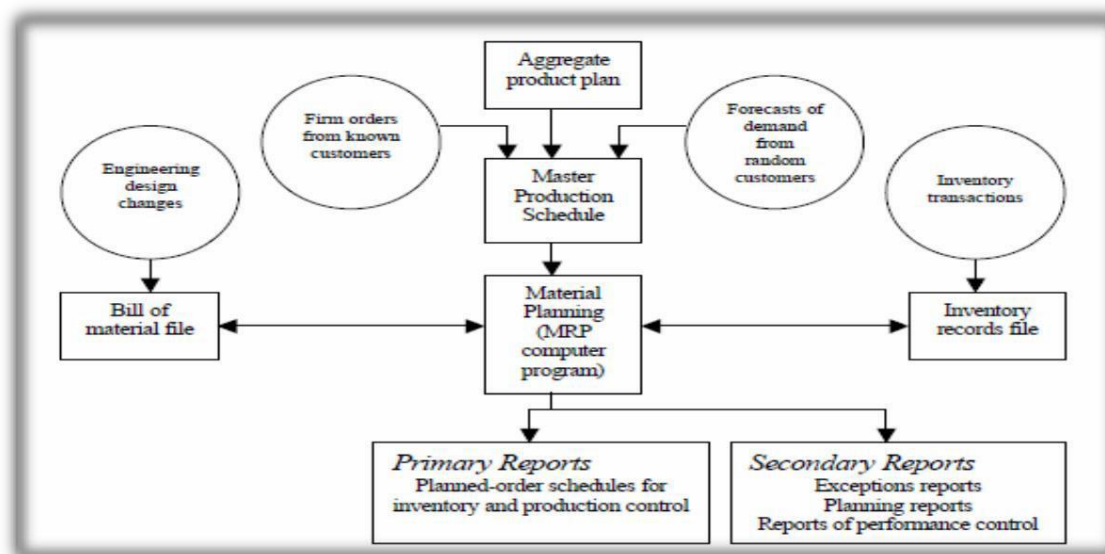

Figure 1: MRP System

The Master Production Schedule includes quantities of products to be produced at a given time period. Quantities are included both at aggregate and detailed levels. Aggregate may refer to monthly production and detailed may refer to weekly or daily production. The master production schedule is a tabular form in which rows represent products and columns represent time components.

Bill of Materials gives information about the product structure, i.e., parts and raw material units necessary to manufacture one unit of the product of interest (*discussed in next section of this chapter*). MRP was pioneered in the 1970's with the work of Orlicky. Later evolved or became part of integrated to Manufacturing Resource Planning systems (or MRPII). MRPII is a computer based planning and scheduling system designed to improve management's control of manufacturing and its support functions.

Classes of MRP User/ Companies:

MRP systems fall into four categories, often identified as ABCD, in terms of use and organizational implementation.

- I. **Class A** represents full implementation of MRP. MRP system is tied up with company "financial system and includes capacity planning, shop floor dispatching, and vendor scheduling as well as links with human resource planning. There exists continuous monitoring of performance and inventory records and master production schedules are accurate;
- II. **Class B** represents a little less than full implementation. MRP system is confined in the manufacturing area; however, it includes master production scheduling;
- III. **Class C** represents a classical MRP approach in which the system is confined to management of inventories;
- IV. **Class D** represents a data processing application of MRP. System is used for keeping track of data rather than as decision making tool.

Conditions for the successful implementation of MRP:

MRP is most valuable to companies involved in assembly operations and least valuable to those in fabrication. For the success of MRP in an organization, some conditions need to be fulfilled as followings:

- ❖ Availability of a computer based manufacturing system is a must. Although it is possible to obtain material requirements plan manually, it would be impossible to keep it up to date because of the highly dynamic nature of manufacturing environments;
- ❖ A feasible master production schedule must be drawn up, or else the accumulated planned orders of components might “bump” into the resource restrictions and become infeasible;
- ❖ The bills of material should be accurate. It is essential to update them promptly to reflect any engineering changes brought to the product. If a component part is omitted from the bill of material it will never be ordered by the system;
- ❖ Inventory records should be a precise representation of reality, or else the netting process and the generation of planned orders become meaningless;
- ❖ Lead times for all inventory items should be known and given to the MRP system;
- ❖ Shop floor discipline is necessary to ensure that orders are processed in conformity with the established priorities. Otherwise, the lead times passed to MRP will not materialize.

Inputs and outputs in MRP System

Inputs to MRP Programme:

Product Demand- Product demand for end items stems from two main reasons. The first is known customers who have placed specific orders, such as those generated by sales personnel, or from interdepartmental transactions. The second source is forecast demand. Demand from known customers and demand forecast are combined and become the input to the master production schedule.

Bill of Materials (BOM) File- BOM file is a document which tells us about an items product structure and also it tells us about the sequence in which components are assembled and their required number. It also tells us about the workstations in which it is assembled. Bill of Materials gives information about the product structure, i.e., parts and raw material units necessary to manufacture one unit of the product of interest

Product structure

Product structure shows a product build up. It shows diagrammatically the components required to assemble it, their numbers, and the sequence of assembly. Example: A sub assembly A is made by joining one unit of components B and two units of components C (shown below). Therefore, if 100 units of sub assembly A are to be manufactured 100 units of component B and 200 units of components of C are required.

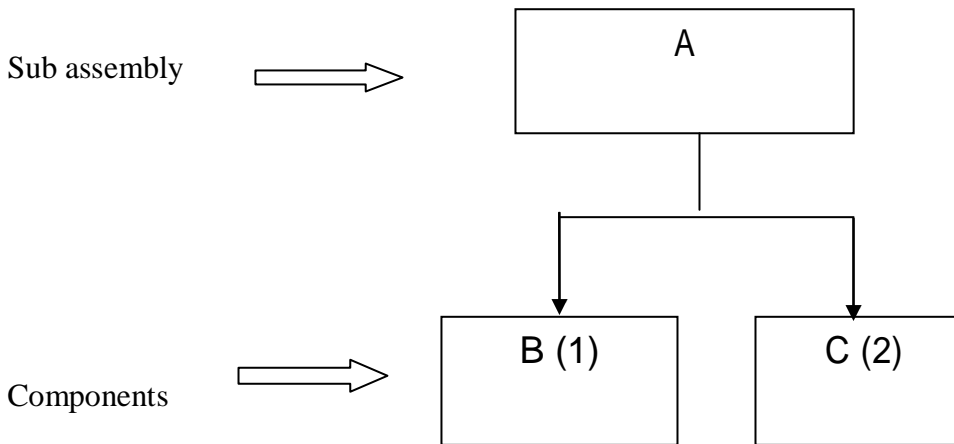

Product structure of sub-assembly A

From the above figure, we see that the requirement of components B and C depends on the requirements of sub assembly A. The requirement of sub assembly A, in turn may depend on the requirement of the finished products X.

Product Structure of Product X

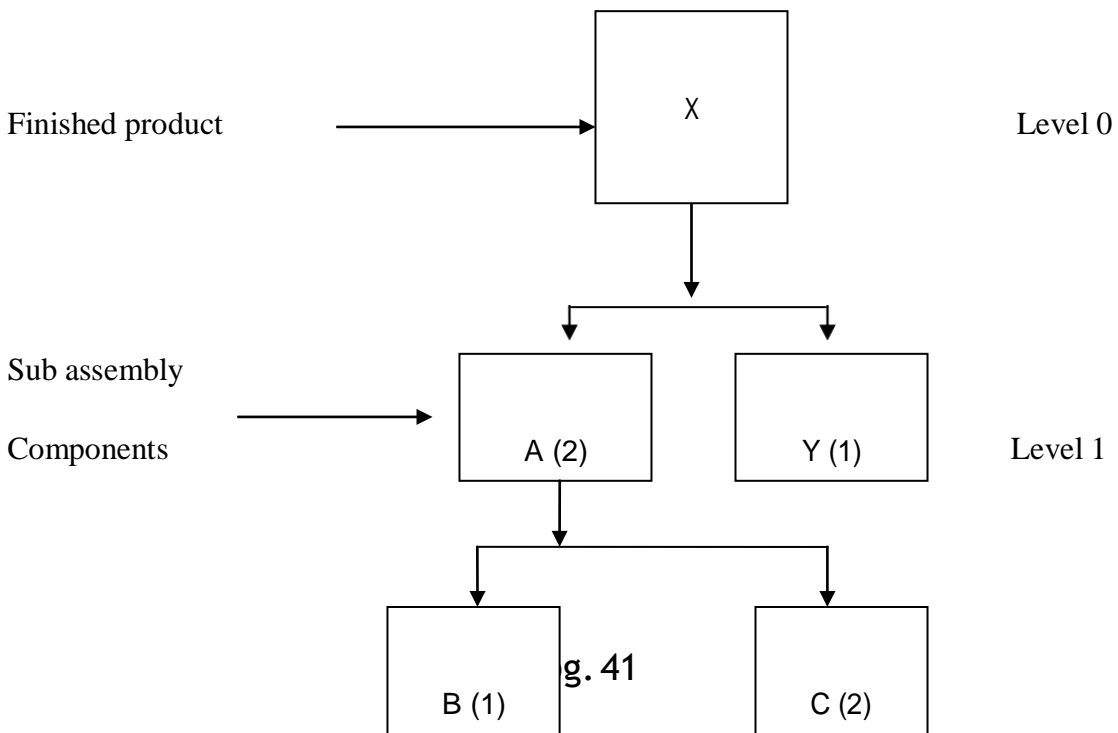

Now if 100 units of products X are to be manufactured, the following would be required

<i>Sub assemblies/components</i>	<i>Number of units</i>
Y	1 x no. of units of X = 1x100=100
A	2x no. of units of X = 2x100 =200
B	1x no. of units of A = 1x200 =200
C	2x no. of units of A = 2x200=400

The BOM file is often called the product structure file or product tree because it shows how a product is put together. It contains the information to identify each item and the quantity used per unit of the item of which it is a part.

For example, the product structure of product M has been shown below. The sub assembly N appears at level 1 as well as level 2 of the product structure .when a computer program reads a bill of material of a product, it starts from the top level which is level 0 as it moves downward, it counts down the product structure tree .If an item appears in more than one level, its number of units cannot be determined unless the computer scan reaches the lowest level. This results in inefficiency of the program.

Product structure of product M

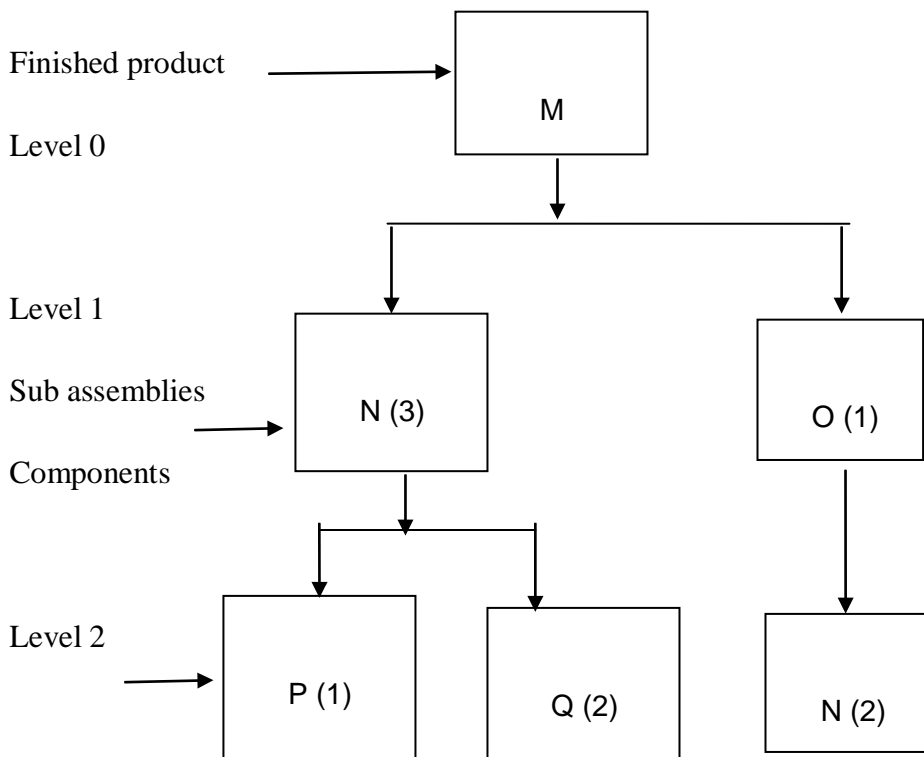

Components

Master Production Schedule- The master schedule and bill of materials indicate what materials should be ordered; the master schedule, production cycle times and supplier lead times then jointly determine when orders need to be placed. The Master Production Schedule includes quantities of products to be produced at a given time period. Quantities are included both at aggregate and detailed levels. Aggregate may refer to monthly production and detailed may refer to weekly or daily production. The master production schedule takes the form of a table in which rows represent products and columns represent time components.

Let me explain it with the help of example:

Numbers of cars to be produced by Nissan India in upcoming months:

Months	Number of Cars
Jan	10000
Feb	12000
Mar	8000
Apr	11000
May	7000
June	12000

The above table reveals the production plan of Nissan India. Master Production Schedule (MPS) tell us that how much amount of a particular model is to be manufactured in a given period of time, if the aggregate plan is given in months, MPS may be divided further into weeks. Let's take an example: Master production schedule of month January is shown below:

Weeks of	1 st	2 nd	3 rd	4 th	Total
January					
Model-A	1200	2000	2700	750	6650
Model-B	700	950	1100	200	2950
Model-C	100	50	200	50	400
Total	2000	3000	4000	1000	10000

Further, the above MPS can also contain information on sub models of a model, e.g., in a given week how many Model-1 will be produced with power steering and how many with power windows and so on.

Inventory Records File- Inventory record file contains the status of all the items in the inventory; it includes scheduled receipts of units of item in that interval of time as a result of orders placed in the recent past to suppliers. This necessarily contains 1) details of the suppliers of the items, 2) time taken by him to supply the item and 3) size of each order to be placed to him.

Inventory records file under a computerized system can be quite lengthy. Each item in inventory is carried as a separate file and the range of details carried about an item is almost limitless. The MRP program accesses the status segment of the file according to specific time periods. These files are accessed as needed during the program run.

Working of MRP program:

- A list of end items needed by time periods is specified by the master production schedule.
- A description of the materials and parts needed to make each item is specified in the bill of materials file.
- The number of units of each item and material currently on hand and on order are contained in the inventory file
- The MRP program “works “on the inventory file in addition, it continuously refers to the bill of materials file to compute quantities of each item needed.
- The number of units of each item required is then corrected for on hand amounts, and the net requirement is “offset” to allow for the lead time needed to obtain the material.

Outputs in materials requirement planning

MRP programme generates different reports as the output which is very important for the production managers for taking different decisions. The various outputs of MRP programme have been summarized as hereunder:

- (1) **Primary Reports** - Primary reports are the main or normal reports used for the inventory and production control. These reports consist of
- (a) Planned orders to be released at a future time;
 - (b) Order release notices to execute the planned orders;
 - (c) Changes in due dates of open orders due to rescheduling;
 - (d) Cancellations or suspensions of open orders due to cancellation or suspension of orders on the master production schedule;
 - (e) Inventory status data.

(2) **Secondary Reports** - Additional reports, which are optional under the MRP system, fall into three main categories:

- (a) **Planned Order Report**- Planned order report tells us about the planned orders that would be released in future date or during a given interval of time. This report helps in preparing the funds required for payments to the suppliers in the future according to the dates and order sizes.

For instance, April is the current month and the finance manager wants to see what quantities of raw material have to be made available in the month of May. This report helps him very much in preparing report that what amount of fund is required in May for making payments to the suppliers.

- (b) **Order Release Report**- Order release report is that which gives information about planned orders which would be released on the present date. It helps the purchase managers to release purchase orders to the suppliers.

This report helps the purchase manager to keep track of the purchase order that have to be sent on a particular day. The material requirement planning logic makers use of the lead time of items in determining the release date of orders, so that goods are supplied by the time the items are required for production.

- (c) **Order Changes Report**- These refer to the orders which have been placed in the past and the supplier of these items is preparing for these supplies to be made to the company. During the lead time the material requirement planning may fluctuate because some customers cancel their orders leading to revision of the MRP because of this change in demand open orders have to revise.

In this case: Suppliers are told either to cancel the orders placed earlier by the company or to postpone them for some time or to reduce the order size to suit the current requirement. The order change report provides information to purchase manager about all such changes to be made in the open orders with the suppliers.

Calculation of Order Size in MRP

There are 4 methods of calculating the order size in MRP

- Lot for lot method
- Economic Order Quantity (EOQ) method
- Least total cost method
- Least unit cost method

Let us take an example to understand all these methods. For an item the following information is given:

Ordering cost (OC) = Rs 50 per order

Carrying cost (CC) per unit per week = 0.5% of unit cost price

Unit cost price = Rs 20

CC per week = $20 \times 0.5\% = \text{Rs } 0.1$

Week	Net requirement
1	80
2	100
3	90
4	60
5	110
6	50
Total	490

Let us calculate order size using four methods as follows

Lot for Lot Method:

In this the order size or the lot size is the same as the requirements at a point of time. In the above example, at the beginning of every week the planned order receipts (order size) exactly match the requirements of the item in that week. As shown in the excel sheet 1 below, the ending inventory as well as the CC of inventory is zero. There is no accumulation of inventory at any point of time, every week an order is placed, leading to an OC of Rs 50. The total cost is Rs 300 for this method.

This implies that an order of 286 units only must be placed every time. In above figure the first planned order receipt of 286 units is in week 1. the net requirements in week 1 is only 80 units .Hence, the excess of 206 units forms the closing inventory, for which the CC will be Rs 20.6(206 X .1). The OC in week 1 is Rs 50 .The inventory keeps on decreasing and in week 3 it reduces to just 16 units .Thus , at the beginning of week 4, an order of 286 units is again placed to receive these immediately (assuming zero lead time).

The total cost in this method is Rs 178.4.

Least Total Cost Method:

In this method, the lot size is determined by extending the time horizon from the smallest unit of time to the largest. In excel sheet 2, the upper table shows that for the time horizon of week 1, the lot size of 80 units will suffice to meet the requirements with zero CC and OC of Rs 50, resulting in the total cost also of Rs 50. When the time horizon is extended from week 1 to week 2, a total of 180 units are required .The lot size to satisfy the requirements of this time horizon is, thus, 180 units .Therefore there is a single order of size 180 units resulting an OC of Rs 50 .The CC for this time horizon is equal to the CC of 100 units to be stored for one week .Thus, the CC is $100 \times 0.1 = \text{Rs}10$.

Similarly, for the time horizon of weeks 1-3, the CC = cost of carrying 100 units for one week + cost of carrying 90 units for two weeks

$$= 100 \times 0.1 + 90 \times 0.1 \times 2 = 10 + 18 = \text{Rs} 28$$

The calculations of the total cost in the time horizon of weeks 1-6 are shown in excel sheet 2. Note that the CC and OC are most close to each other in value for the time horizon of weeks 1-4 .Thus, this time horizon has the least total cost .Therefore, lot size for this interval from week 1 to 4 will be taken as 330 units .For the remaining duration, i.e., weeks 5 and 6, we will perform the calculations in a way similar to what has been done earlier.

weeks	lot size	carrying cost	order cost	total cost				
1	60	0	50	50				
1 to 2	180	10	50	60				
1 to 3	270	29	50	78				
1 to 4	330	46	50	96	least total cost			
1 to 5	440	90	50	140				
1 to 6	490	115	50	165				
5	110	0	50	50				
5 to 6	160	5	50	55	least total cost			
week	net req.	lot size	encoding inventory	carrying cost	order cost	total cost		
1	80	330	250	25	50	75		
2	100	0	150	15	0	15		
3	90	0	60	6	0	6		
4	60	0	0	0	0	0		
5	110	160	50	5	50	55		
6	90	0	0	0	0	0		
					total	151		
			last total cost method					

Excel Sheet 2

First, consider only weeks 5-6, for which the CC and OC are Rs 5 and Rs 50, respectively. Clearly for weeks 5-6, the CC and OC values are nearer to each other compared to week 5 alone. Therefore, the least cost lot size is 160.

In excel sheet 2, the second table shows the usual total cost calculations, when the second order of 160 units is placed at the beginning of week 1, while the second order of 160 units is placed at the beginning of week 5, the total cost of this method is Rs 151.

Least Unit Cost Method:

This method is just an extension of the least cost method, as shown in excel sheet 3 below, the only difference is that after calculating the total cost for each time horizon, it is divided by the lot size to get the unit cost. Note that the unit cost is lowest for the time horizon of week 1-3. Thus, the first lot size will be 270 units. We now do the calculations for time horizons beyond week 3 i.e., week 3, week 4, week 4-5, and week 4-6. The least unit cost is for week 4-6.

Thus the next size is 220 units. The total cost for this method has been calculated as Rs 149. The lot for lot and EOQ methods is called *fixed period methods*, while the least total cost and least unit cost methods are called *part period methods*, as various parts of the duration are considered for minimizing the cost. The least total cost and least unit cost

methods are based on dynamic lot sizing techniques. Both these methods result in lower values of total cost compared to the lot for lot and EOQ methods. At the same time, they are more complicated to the lot for lot and EOQ methods.

weeks	lot size	carrying cost	order cost	total cost	unit cost			
1	80	0	50	50	0.625			
1 to 2	180	10	50	60	0.3333333			
1 to 3	270	28	50	78	0.2888889		least unit cost	
1 to 4	330	46	50	96	0.2909091			
1 to 5	440	90	50	140	0.3181818			
1 to 6	490	115	50	165	0.3367347			
4	60	0	50	50	0.8333333			
4 to 5	170	11	50	61	0.3588235			
4 to 6	220	21	50	71	0.3227273		least unit cost	
weeks	net requirements	lots size	Ending inventory	carrying cost	order cost	total cost		
1	80	270	190	19	50	69		
2	100	0	90	9	0	9		
3	90	0	0	0	0	0		
4	60	220	160	16	50	66		
5	110	0	50	5	0	5		
6	50	0	0	0	0	0		
					total	149		
			least unit cost method					

Excel sheet 3

Just- in-Time Manufacturing System

According to Schonberger, “Just-in-Time (JIT) is a system to produce and deliver finished goods just in time to be sold, sub assemblies just-in-time to be assembled into finished goods, and purchase materials just in time to be transformed into fabricated parts.”

The idea of just in time was originally developed by the Toyota motor company in Japan .The idea was formalized into a management system when Toyota sought to meet the precise demand of customers for different models and colors of cars with minimum delays. JIT is being used in wide variety of industries such as automobiles, consumer electronics, office equipments etc.

JIT may be understood as the continuous improvement of material flow in either factory or a combination of factories.

There are four techniques in JIT for improving material flow which are as follows

- ❖ Factory layout revision
- ❖ Set up time reduction
- ❖ Pull system implementation
- ❖ Better coordination with suppliers

Factory Layout Revision

The layout of factories can be revised to introduce assembly lines and manufacturing cells .sometimes called continuous flow manufacturing, the purpose of these layout modifications is to minimize material handling activities and their associated transactions and to provide faster quality feedback .Assembly lines are typically dedicated to a particular product type, although they may be able to produce multiple models. Manufacturing cells produce a variety of completed parts and the cells are developed using group technology .often in order to have the capability to handle certain surges in demand, excess capacity is built into the system.

Set-up Time Reduction

Factories can reduce set up times in order to reduce lot sizes and smooth production. Reduced set up times enables a factory to produce smaller lot sizes economically. Smaller lot sizes enable a factory to produce a broader variety of products, assemblies and parts each day .However, preventive maintenance and lowering defects rates are also needed to achieve these lower safety stock sizes.

Pull System Implementation

In a pull system, final assembly lines only produce actual orders and kanban cards are used to signal sub assembly and part deliveries, and production.MRP may be used and smooth production facilitates the use of a pull system.

Better coordination with suppliers

Factories can work with suppliers to reduce raw material inventories and solve quality problems. The first three techniques are applicable to the suppliers as well, for improving the material flow between a firm and its supplier's. The goal is to make the supplier an extension of the internal material flows, to avoid the problems associated with shifting of inventories from customers to suppliers.

Kanban Visual Systems

Kanban is a Japanese word that means flag or signal, and is a visual aid to convey the message that action is required. The kanban inventory control system was originally introduced by the Toyota motor company in Japan. On a visit to the USA, Toyota's Vice President Taiichi Ohno noticed the technique, adapted by American supermarkets for replenishing empty shelves in racks. Whenever a shelf was found drained of a product, it triggered the replenishment of the product to the shelf. It was so simple because an empty shelf was easily visible among the other shelves full of products. Ohno thought of implementing the same idea for replenishment at his assembly lines. He adapted this simple but effective method by using a trigger or kanban, to alert the manufacturing area that the assembly area was running low on components. Every component must have its own kanban to signal when it needs to be replenished.

The kanban system can be explained in the following stages:

Stage 1

When a worker needs components, he goes to the racks placed opposite his workstation. These racks contain bins of components required by a workstation, which form the work in process inventory. Every bin has the requisition kanban card affixed on it, which is removable. This card contains the component name, its identification number, and the rack number and shelf on the rack in the store where more bins of the component are stored.

The workers from the assembly line remove the kanban card from the bin, hang it on a hook on the rack, and take away the bin to their workstation for using the components in assembly operations. These hanging kanban cards are thus clearly visible from everywhere, signaling replenishment of components from the store.

Stage 2

A supply worker called "*Mizosomashi*" in Japanese keeps on moving in the aisle or the passage way across the racks with his trolley. When he reaches the racks opposite the assembly line, he removes all the hanging requisition kanban cards and the empty bins from the racks. He then takes these along with him through the aisle to the racks in the store opposite the manufacturing cells.

Stage 3

Mizosomashi looks at the information on each requisition kanban card and locates the position of the rack and the shelf on the rack containing the bins full of a particular component. Every bin in the store has the production kanban card affixed on it, which is

removable. The production kanban card contains the name and identification number of the component to be manufactured in the cell. Mizosomashi takes off the bins from the racks corresponding to the requisition kanban card he had bought with him, and removes the production kanban card from these. He hangs these on the hooks on the corresponding racks in the store, attaches the requisition kanban cards on the bins, and puts the bins in the trolley to the racks opposite the assembly line and places the bins in the appropriate racks. Thus, the replenishment of the bins at the assembly line has taken place. Mizosomashi repeats this process at regular intervals of time.

Stage 4

One worker from each of the manufacturing cells goes to the rack placed opposite his cell with his trolley. He removes the hanging production kanban cards and places the empty bins from the rack in his trolley. He takes these to his manufacturing cell, where the different components mentioned on the production kanban cards are manufactured in exact quantities so as to fill the empty bins completely. The filled in bins with the production kanban cards attached to them are then taken from the manufacturing cell to the rack opposite the cell and placed on the appropriate shelf mentioned in the production kanban card.

JIT is a pull system, as opposed to the western norm of making bulk components and storing them just in case they are needed. The obvious benefits of using the kanban system are reduced inventory and less storage space required; however, the hidden benefit is the high quality of components. Production of components in small batches makes it easier to immediately detect defects in them. Thus reduced inventory acts as a buffer against bad quality.

Benefits of MRP System

MRP system is of immense importance in manufacturing organizations. The key benefits have been summarized as below:

- Reduced inventories without reduced customer service
- Ability to track material requirements
- Ability to evaluate capacity requirements
- Means of allocating production time

- Increased customer satisfaction due to meeting delivery schedules
- Faster response to market changes
- Improved labor and equipment utilization
- Better inventory planning and scheduling

In addition to above, the key outputs of MRP system are very helpful in:

- Calculating demand for component items
- Determining requirements for subassemblies, components, and raw material
- Determining when they are needed
- Generating work orders and purchase order
- Considering lead time

Summary

Material requirement planning is a system for determining order quantities and the time intervals for placing orders of dependent demand items e.f. components and raw materials etc. It requires three inputs, namely, master production schedule, bill of materials and inventory status. It generates three output reports – planned order reports, order release report, and order change report. Just in time is a manufacturing system in which work in process inventories are reduced to minimum levels. Small quantities of materials are supplied by the suppliers to the assembly line directly with the aid of visual kanban cards. In MRP, order size can be determined using four techniques namely, 1) Lot for lot method, 2) Economic Order Quantity (EOQ) method, 3) Least total cost method and 4) Least unit cost method.

MRP and JIT can be used together simultaneously as a hybrid MRP –JIT system, where MRP is used for planning materials requirement only, and the purchase orders sent to the suppliers act only as an indication of the probable requirements of the buyer company. The supplier supplies the goods only according to the JIT system of kanban cards.

Keywords

Bill of materials: is a document which tells us about the structure of a product, showing the sequence in which components sub assemblies are assembled and their required numbers. It also contains details about the workstations at which the item is assembled.

Just in time system: is defined as produce and deliver finished goods just in time to be sold, subassemblies just in time to be assembled into finished goods and purchased materials just in time to be transformed into fabricated parts.

Kanban: is a Japanese word meaning flag or signal, and is a visual aid to convey the message that action is required.

Master production schedule: is an extension of the aggregate production plan. It tells us the number of units of different models of a product to be manufactured on a weekly or monthly basis in the coming 6-18 months.

Material requirement planning: is a system for planning the future requirements of dependent demand items.

Product structure: shows a product build up. It shows diagrammatically the components required to assemble it, their numbers, and the sequence of assembly.

Purchasing: refers to the actual buying materials and the activities associated with it.

Self assessment questions

1. What is materials requirement planning? What are the inputs and outputs required by the MRP processing logic?
2. What is product structure?
3. What is a bill of materials?
4. Give the general format of an MRP report using a hypothetical example.
5. Explain the various methods of determining the order size in MRP.
6. Define the Just in time system and explain the basic concept of JIT manufacturing?
7. What is kanban visual system? Explain the various steps followed in operating the kanban system in a plant.

References

Karlsson, C. and Norr, C. (1994). *Total effectiveness in a just in time system*, International Journal of Operations and Production Management, vol. 10, no.3

Lee choong, Y. (1993). *A recent development of the integrated manufacturing systems, a hybrid of MRP and JIT*, International Journal of Operations and Production Management, vol.13, no.4, pp.3-17

McMillan, Charles J. (1985). *The Japanese Industrial System*, Walter de Gruyter, New York, pp. 61

Schonberger, R.J. (1982). *Japanese Manufacturing Techniques; Nine Hidden Lessons in Simplicity*, Free press, New York.

Monden, Y. (1981). *Adaptable Kanban System helps Toyota maintain just in time production*, Industrial Engineering, vol. 13, no. 5, pp.29-46

Westbrook, R. (1988), *Time to forgot "just in time"? Observations on a visit to Japan*, International Journal of Operations and Production Management, vol. 8, no. 4, pp.5

INVENTORY MANAGEMENT;

Introduction:

Inventory is basically working capital and that is why control of inventories is very important as part of operations management. Inventories are crucial for proper functioning of manufacturing and retailing organizations. There are many types of inventories like raw material, spare parts or consumables, work-in-progress and finished goods. It is not necessary that every organization needs these resources but should work according to the needs and requirements of the resources depending upon what type of production is taking place.

Various departments within the same organization have a contradictory approach towards these kinds of resources. This is because the functions that are performed in various departments influence the motivation in them. For example, the sales department might need large amount of stocks of materials so that the production systems run very smoothly with any hesitation. On the other hand, the finance department would need a minimum investment in stocks so that the funds could be used elsewhere for even better purposes to enhance the performance of the organization.

There are different inventory systems that determine the when to order and how much to order. In this chapter, we will discuss all of them in detail.

Types of Inventory:

Inventories are used for many different purposes and by various departments for their respective needs and requirements, but there are generally five types of inventories that every production organization should emphasis on:

- 1) Movement inventories
- 2) Buffer inventories
- 3) Anticipation inventories
- 4) Decoupling inventories
- 5) Cycle inventories

1) Movement Inventories:

Everyday resources are being transported to the industries and putting them to use by production organization through various modes of transportation. Movement inventories are also called transit or pipeline inventories. This is basically dealt with transporting the resources from source to destination. For example, coal is transported from coalfields to an industrial township by trains, then the coal, while being transported will not be able to provide any service to the customers for power generation or for burning furnaces etc.

2) Buffer Inventories:

These inventories are basically kept for future needs for the organization in stock because there may be a case when more inventories would be needed and therefore every organization keeps an average amount of inventories in stock so that the organization can utilize those resources efficiently and effectively without any delay. This mainly calls for uncertainty in demand, as every organization would need the required amount of stock but what would happen when the stock runs out? Everything would stop mainly the production so it is very important that excess amount of resources should be kept in stock. Similarly, the average time for delivery that is (the time between placing the order of resources and receiving those orders and getting them ready for use in stock, technically known as lead-time).

The idea of keeping buffer stocks is to enhance the level of providing customer service and gradually reducing the number of stock outs and back-orders. Stock out is something when the stock runs out and the needs of customers are not being able to be fulfilled but in some situations back ordering is possible that is (the order for goods demanded is fulfilled as soon as the next shipment of stock arrives.) while in others it is not as it looks because the demand might be lost forever which leads to temporary or permanent loss of customer goodwill.

So it is very important to keep buffer stocks as demand may arise at any point of time.

3) Anticipation Inventories:

Anticipation inventories are put under scrutiny for future demands so that when the time arrives, the supply of products flows rapidly. Like producing rain coats before the rainy season, creating crackers before Diwali etc. The idea under this is to smoothen the flow of production process for longer time on an iterative scale instead of operating with excess overtime in a particular period and then keeping the system idle for long or even shut

down the system because of unnecessary demand for another period.

4) Decoupling Inventories:

This type of inventory deals with the work rate of different machines and people because normally machines work at different rates- some slower and some faster. For example, a machine might be producing half the output of the machine on which the item being handled is to be processed the next. Inventories in between the various machines are held in order to disengage the processing on those machines. In absence of those inventories, different machines and people cannot work on a continuous basis. Clearly, therefore the decoupling inventories act as shock absorbers and have a cushioning effect in the face of varying work rates, and machine breakdowns and failures and so on.

5) Cycle Inventories:

Cycle inventories are those when purchases in lots instead in exact amount of stock need in a specific point of time. But yes if all purchases are made as per the exact requirement of stock there would have been no cycle inventories. But then the cost in getting these stocks would be much higher as per the customer needs and requirements. They are also called lot-size inventories and larger the lot-size inventory the greater would be the level of cycle inventory.

Inventory Decisions:

It is very important and is the top most priority of deciding about the inventories in a production organization as this would decide the future and present performance of the company. In any production organization deciding the inventories according the needs and requirements of it is very important. This can enhance the performance or bring down the efficiency.

So there are specific things any production manager should keep in mind before making decisions. They are:

- ❖ How much to order? – This is decided by the manager as to how much quantity to order for optimal performance and effective utilization of resources.
- ❖ When to order? – This is the most important aspect the manager should emphasize on because this would decide when should the products be ordered.

- ❖ How much stock should be kept in safety? – This indicates how much quantity should be taken under consideration so that the stock can be used safely in the future without any hesitation.

Inventory Costs:

For deciding the best suitable inventory policy, the top most criteria used is the cost function. This inventory analysis has four major components:

1) Purchase Cost:

This is basically the nominal cost of an inventory. It is the cost incurred in buying from the outside sources, and it would be known as production cost if the items are produced within the organization. The cost is constant for a unit but may vary according to the quantity purchased increases or decreases. For example, the unit price is Rs.20 for up to 100 units and Rs.19.50 for more than 100 units. If a unit cost is constant, the control decisions would not have any affect because whether all the requirements are produced just once or made in installments the total amount of money involved would be the same.

2) Ordering Cost/Set-up Cost:

This occurs whenever the stock replenishes. It associates with the processing and chasing the purchased order, transportation, and inspection for quality. It is also called procurement cost. The parallel of ordering cost when the units are produced within the organization is the set-up cost. It refers to cost incurred in relation to developing production schedules. The ordering cost and set-up cost are taken to be independent to the order size. So the unit ordering/set-up cost decreases as the purchase order increases.

3) Carrying Cost:

Carrying cost is also known as holding cost and it refers to the cost that is associated with storing an item in the inventory. It is proportional to the amount of inventory and the time taken to hold that inventory. The elements of carrying cost include opportunity cost, obsolescence cost, deterioration cost. The carrying cost is expressed in terms of rate per unit or as a percentage of the inventory value.

4) Stockout Cost:

Stock out cost is the cost, which incurs when customers are not being served. These costs imply shortages. If stock out is internal, that means that some production is lost internally

also resulting in idle time for man and machines. If stock out were external, it would result in potential sales or loss of customer goodwill. When the new shipment arrives, a customer who was denied earlier would be immediately supplied the goods. But it would involve costs like packaging costs and shipment costs.

Inventory Management Systems:

There are basically two types of management systems:

- ***Fixed order quantity system:*** Also known as re-order point, when a specific level is reached called the re-order level and the stock level reached this point, an order for a particular number of units is placed;
- ***Periodic Review System:*** This is a system where the stock is replenished over a fixed period of time. In this system, the time after which the order is placed, is fixed, but not the quantity.

Fixed Order Quantity System:

This system also called the Q-System. In this, a re-order point is established and as soon as the stock level reaches this level, new set of orders are placed. This system is taken under consideration of certainty. A couple of models based on different conditions shall be developed to study various operations of the system under deterministic conditions.

Model 1: The Classical EOQ Model

EOQ stands for Economic Order Quantity also known as the Wilson Formulation. It is the most elementary of all the inventory models. For this, a fixed cost model is made and then it is manipulated to form an inventory model.

This model is based on the following assumptions:

- 1) The demand for the item is continuous, constant and certain over time.
- 2) The purchase price is constant, and no discount is available on the large lots.
- 3) The inventory is replenished immediately as the stock level reaches level equal to zero. So there is no shortage or overage.
- 4) The lead is always known and fixed. When the lead-time is zero, the delivery of item is instantaneous.
- 5) Within the range of quantities ordered, per unit holding cost and the ordering cost are constant and thus independent of the quantity ordered.

With these assumptions, the inventory level would vary over time as shown in the graph 1 as below:

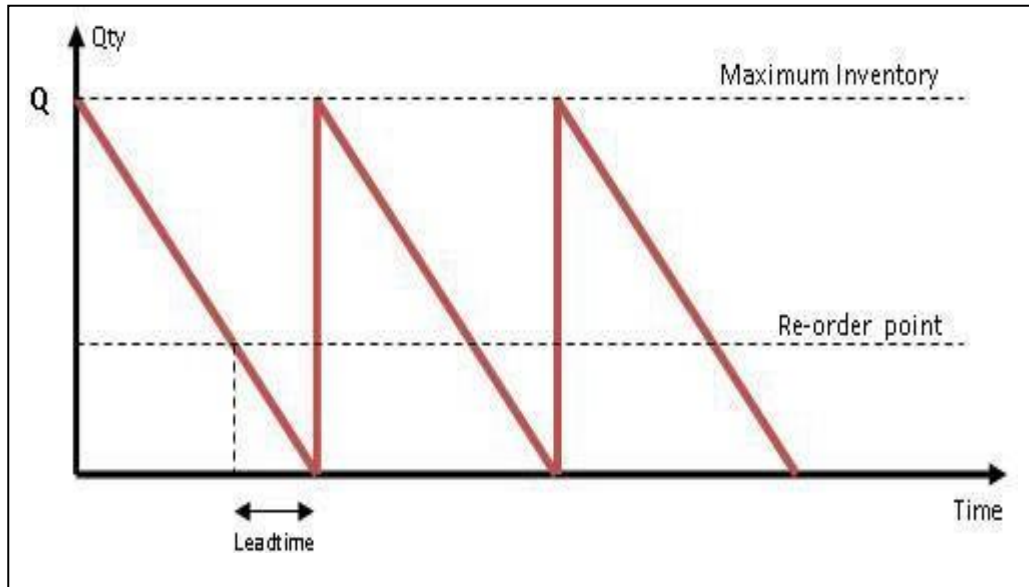

Graph 1

Now, we begin with a stock of Q on the time zero. This will be consumed at the rate of some units per day. If the stock can be replenished instantaneously (that means lead time is zero), then a new set of orders is made and the inventory is obtained. When this stock is consumed, an order would be made at another time.

The interval between two different points when orders are placed, or the time elapsed in consuming the entire lot of items, is called the inventory cycle. The maximum inventory held would be Q while the minimum be zero, and hence the average inventory level would be equal.

There is no need for maintaining a safety stock because of the first two assumptions. For determining the optimum order quantity, we shall take two types of cost: ordering cost and the holding cost. Since the purchase price is uniform in nature, it does not affect the decision as to the quantity of the item to be ordered for purchase and, hence, is irrelevant for the purpose.

The cost model assuming for a period of one year is:

$$T(Q) = O(Q) + H(Q)$$

Where,

Q = the ordering quantity

$T(Q)$ = total annual inventory cost

$O(Q)$ = total annual ordering cost

$H(Q)$ = total annual holding cost

Example 1:

Samsung Electronics Co produces 2000 TV sets in a year for which it needs an equal number of picture tubes of a certain type. Each tube costs Rs10 and the cost to hold a tube in stock for a year is Rs 2.40. Besides, the cost of placing the order is Rs 150, which is not related to its size.

Now, if an order for 2000 tubes is placed, only one order per annum is required. When 1000 units are ordered, 2 orders in a year are needed, while 500 units are ordered to be supplied, then a total of 4 orders per annum are required. Naturally, as the number of orders placed increases the ordering cost goes up. More orders, however, would also imply smaller order quantity and therefore decreasing holding costs. Thus, we have a trade-off between the ordering and the holding cost. What we attempt in our EOQ model is, then, to find the order size that minimizes the cost function $T(Q)$.

A) Total Annual Ordering Cost: This is given by the number of times an order is placed, N , multiplied by ordering cost per order, A .

$$O(Q) = N \times A$$

The value of N itself is independent on the order quantity Q , and the annual demand, D . Here N would be equal to D/Q . Accordingly:

$$O(Q) = D/Q \times A$$

So, When:

$$N=1, Q=2000 \text{ and } O(Q) = 1 \times 150 = \text{Rs}150$$

$$N=2, Q=1000 \text{ and } O(Q) = 2 \times 150 = \text{Rs}300$$

$$N=4, Q=500 \text{ and } O(Q) = 4 \times 150 = \text{Rs}600$$

$$N=5, Q=400 \text{ and } O(Q) = 5 \times 150 = \text{Rs}750$$

B) Total Annual Holding Cost: The annual holding cost is obtained by multiplying the unit holding cost, h , by the average number of units held in the inventory. As been pointed out earlier, the average inventory held equals $Q/2$. Consequently, the total cost of holding inventory, per annum would be:

$$H(Q) = Q/2 \times h$$

So, When:

$$Q=2000, H(Q) = 2000/2 \times 2.40 = \text{Rs } 2400$$

$$Q=1000, H(Q) = 1000/2 \times 2.40 = \text{Rs } 1200$$

$$Q=500, H(Q) = 500/2 \times 2.40 = \text{Rs } 600$$

$$Q=400, H(Q) = 400/2 \times 2.40 = \text{Rs } 480$$

This may be pointed out that although the cost of holding a unit in an inventory is given in this question, more often the holding cost is expressed as a proportion, or percentage of the value of inventory. It may be stated for example: that the inventory holding costs are 15% per annum of the value of an item. It implies that if an item costs Rs 40, then the holding cost would be 15% of 40 = Rs 6 per unit per year.

C) Total Annual Inventory Cost: Both the cost components can now be added up and we can obtain the total cost of inventory.

The total cost curve is obtained by adding two components $O(Q)$ and $H(Q)$. The minimum point on this curve determines the optimal quantity, for which each order is placed each time. This ensures the minimization of total cost.

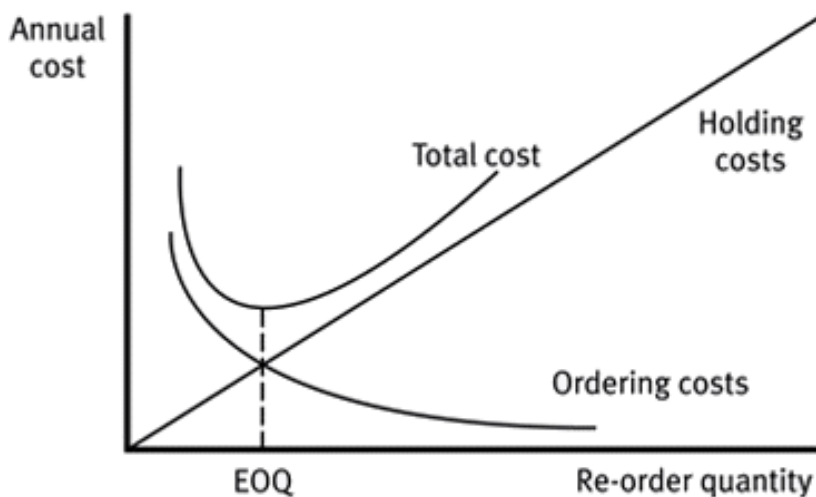

Graphic Determination Of EOQ

The graphic and tabulation methods of determining the EOQ are cumbersome.

We can obtain this value using the following formulae:

$$Q = \sqrt{2A/h}$$

—

$$\text{Or, } Q = \sqrt{2AD/hc}$$

For example: We have A = Rs 150 per order, h = Rs 2.40 per unit per annum. D = 2000 units. Thus,

$$Q = \sqrt{2 \times 150 \times 2000 / 2.40}$$

$$= \sqrt{2,50,000} = 500 \text{ units}$$

Determination of the Re-order Level:

The re-order level would be known at a point such as: The data below,

No. of working days = 250

Lead time = 15 working days

With this info, the daily demand = $2000/250 = 8$ tubes

Demand during lead time = $15 \times 8 = 120$ tubes

Re-order level = 120 tubes

A) Annual Total Variable Inventory Cost: The minimum annual inventory cost can be determined by substituting Q^* for Q .

$$T(Q^*) = D/Q^* \times A + Q^*/2 \times h$$

It may be noted that when the holding cost is expressed in the proportion form, we

$$\text{have: } T(Q^*) = \sqrt{2Ad/c}$$

B) Inventory Cycle: With a uniform and constant demand D , and the economic order quantity Q^* , the problem of the optimal interval between the successive orders can be answered easily. If T^* represents the optimal interval between any consecutive orders, we have,

$$T^* = Q^*/D$$

T^* is also called the inventory cycle time.

C) Number of Orders: The optimal number of orders placed per year, N^* , can also be obtained. It equals the reciprocal of T^* . Thus, $N^* = 1/T^*$. Thus, when $T^* = 0.25 = 1/4$, $N^* = 4$ orders per year.

D) Rupee value: The monetary value of optimal order quantity and average inventory held can also be determined:

$$\begin{aligned}\text{Rupee value of EOQ} &= Q^* \times C \text{ (where } c \text{ is the unit price)} \\ &= 500 \times 10 = 5000\end{aligned}$$

$$\begin{aligned}\text{Rupee value of the average inventory} &= Q^* \times C/2 \\ &= 500 \times 10/2 = \text{Rs } 2500\end{aligned}$$

In most cases, demand is expressed in money terms instead of units. So in this case, if the unit price is known, the demand may be converted into units by dividing rupee demand by the unit cost price.

Where ever, the cost is not given and then we can determine the economic order quantity in rupee terms. When the demand is given in monetary terms, the holding cost must be expressed as a proportion.

D_m = the annual demand in rupee terms

A = the acquisition cost

I = the holding rate

Example:

Using the following data, obtain the EOQ and the total variable cost associated with the policy if ordering quantities of that size.

$$\text{Annual Demand} = \text{Rs. } 20000$$

$$\text{Ordering Cost} = \text{Rs } 150 \text{ per order}$$

$$\text{Inventory carrying cost} = 24\% \text{ of average inventory value}$$

Here,

$$D_m = \text{Rs}20000$$

$$A = \text{Rs } 150/\text{order}$$

$$I = 24\% = 0.24$$

$$\begin{aligned}\text{EOQ (in rupees)} &= \frac{\sqrt{2 \times 150 \times 20000}}{0.24} \\ &= \text{Rs } 5000\end{aligned}$$

$$\begin{aligned}\text{Total Cost, } T(Q^*) &= \sqrt{2} \times 150 \times 20000 \times 0.24 \\ &= \text{Rs } 1200\end{aligned}$$

Violation of Assumptions of EOQ Model:

- In the EOQ model, we assumed that demand of an item is certain, continuous and constant. But however, the demand is more likely to be uncertain, discontinuous and variable.
- Demand is always supplied immediately and there is no availability of shortage. However, even when the demand and lead-time are known and constant, stockouts may be permitted.
- The unit price is the same. The analysis can be extended to cover situations when quantity discounts are available.
- The implicit assumption that the entire quantity ordered for would be received in a single lot may not hold true sometimes. If the supply of goods is gradual, the model needs adjustments.

Model 2: EOQ with Price Breaks

The previously discussed, the classical EOQ model is based on the assumption that the cost of an item under consideration is uniform. But in real life, it is very common to find cost discounts on quantities for which the order is placed. Lower rates are highlighted if the quantity of goods is high. So in cases like these, the quantity ordered should be carefully examined taking into consideration the price levels of different quantity ranges.

When the unit cost price is uniform, the purchasing cost is inadequate to determine the order size. But under the conditions of price break, the item cost, being a function of order quantity, is the incremental cost and must be included in the cost model. As such, the cost model would include the holding cost, ordering cost and the purchasing cost of items.

$$T(Q) = \frac{D}{Q} \times A + \frac{Q}{2} \times h + cQ$$

This cost model is a step function, and not a continuous like the one given earlier. To understand how optimal order quantity can be determined in such a case, we would take an example:

$$D = 2000 \text{ units per annum}$$

A = Rs 150 per order

h = 2.40 per unit per annum

Suppose now that the supplier informs that if the order size is at least 800 units, he is prepared to supply it at a discounted rate of Rs 9.80 per tube.

With the EOQ = 500 units

$$T(Q) = \frac{2000}{500} \times 150 + \frac{500}{2} \times 2.40 + 10 \times 2000$$
$$= \text{Rs } 20935$$

With the EOQ = 800 units

$$T(Q) = \frac{2000}{800} \times 150 + \frac{800}{2} \times 2.40 + 9.80 \times 2000$$
$$= 750/2 + 960 + 19600 = \text{Rs } 20935$$

EOQ Model: Curves

- The EOQ will be the quantity that minimizes the overall annual cost.

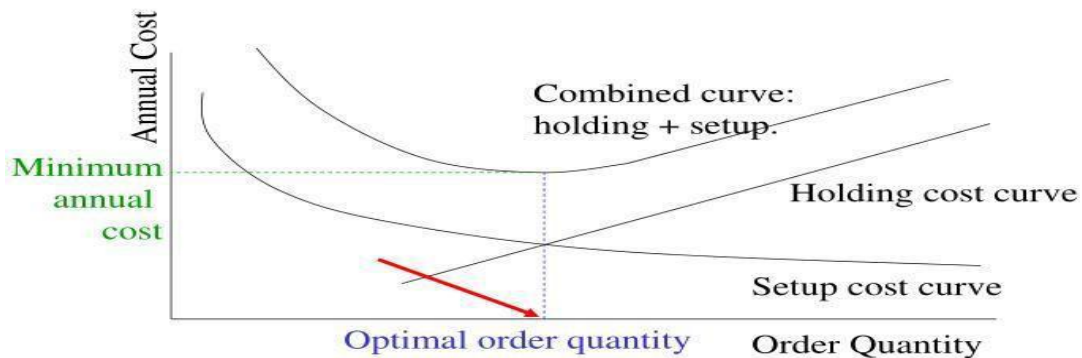

Cost Curve For the Price-Break Model

Clearly, the curve shows a sizeable drop in the cost due to the price discount at a quantity of 800 units. At this level, the total cost is lower than the total cost corresponding to 500 units.

Model 3: Inventory Model with Planned Shortages

In general inventory situations, a shortage is mainly undesirable and should be avoided because shortages can result in loss of customer goodwill, reduction in future orders, it may result in unfavorable changes in the market share etc. and in some situations, customers tend to move from a source to another for different requirements, and also customers may not withdraw the orders and wait until the next shipment arrives. This situation is also called the *back-ordering situation*. The EOQ model assumes that the inventory is replenished precisely when the inventory level falls off to zero. With the assumption of back ordering, Shortages, and therefore, the cost of shortage is not considered in that model. It may be advisable on economic considerations, specially, when the value of the item in question of setting off the cost of shortages against the saving in the holding cost.

Graph below shows negative inventory (zero level) i.e. number of units backordered. As soon as the lot of Q items is received, the customers whose orders are pending would be supplied their needs immediately and as such the maximum inventory level would be $Q-S$.

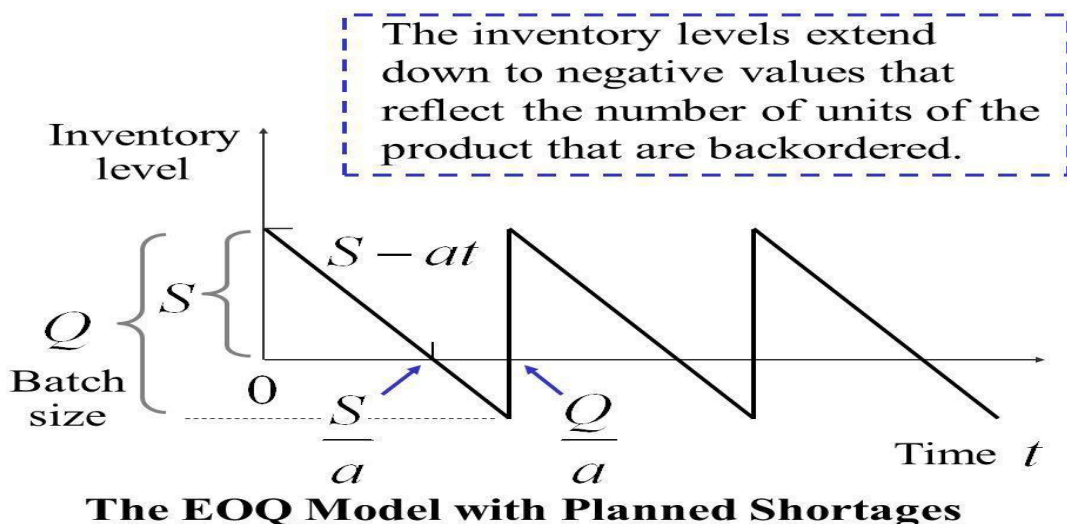

In developing the cost function, we would consider cost of shortages in addition to the holding and the ordering costs. Cost of shortages or the backordering cost is incurred in terms of the labour and special delivery expenses and the loss of customer goodwill.

$$\text{Total Cost} = \text{Ordering Cost} + \text{Holding Cost} + \text{Shortage Cost}$$

Ordering Cost: As seen before, if the cost of placing an order be A , and the total demand be D , we have,

$$\text{Annual ordering Cost} = D/Q \times A$$

Holding Cost: It is the period in a given inventory cycle when positive inventory is held. Since the maximum inventory, M, is Q-S, the average inventory level equals (Q-S)/2. Thus,

$$\text{Holding cost during a given cycle } T = (Q-S)/2 \times ht$$

From the above formulae, we observe that the quantity (Q-S) is sufficient to last a period.

Shortage Cost: We shall now develop expressions for the average number of shortages and the shortage cost with the help of which we shall determine the annual shortage cost. Since S represents the maximum level of shortages, the average level of shortages, during the period when there is a shortage shall be S/2.

From the analysis, the total cost expression would be:

$$T(Q) = \frac{D}{Q}A + \left(\frac{Q-S}{2}\right)h + b\frac{S^2}{2Q}$$

Derived from the expression, Q* would be:

$$Q^* = \frac{\sqrt{2AE}}{h} \times \left(h + \frac{b}{h}\right)$$

$$= \sqrt{2Ah} + \sqrt{\frac{b}{h}} + B$$

Determination of the re-order level: The optimal shortage being 474 units and the consumption during the lead-time being equal to 8x15=120 units, the re-order level would be established at a point where the shortage reaches 474-120=354 units.

Therefore: Re-order level = -354 units (shortage level of 354 units).

Economic Manufacturing Batch Size:

The EOQ concept can be further extended to the determination of optimal manufacturing batch size for semi-finished and finished goods. If the batch size is large, then the average level of inventory is also large therefore the carrying costs for the inventory are high. But

a few cases like, large batches of would suffice for the annual requirements, the number of set-ups would be low. On the other hand, when batch size is small, the order cost is higher, but at the same time, the average inventory level is smaller thus making the carrying cost lower. Thus, there is clear trade-off between costs involved.

Cost of Setup:

The set-up cost mainly includes the following:

- 1) Cost of time spent in setting up the equipments and organizing the labour for a manufacturing batch. This is the cost of the idle time of labour and the machinery, which would have otherwise produced goods. This is the opportunity cost of the time lost due to a set-up.
- 2) Cost due to rejects, scrap, rework generated during a set-up.
- 3) Variable cost of administrative paper work for a set-up.

Calculation of Economic Batch Quantity:

The Economic Batch Quantity (EBQ) Formula for a single product is:

This expression is similar to that derived for the classical inventory model except for the fact that it takes into consideration production and consumption rates of the product.

Example:

Compute the EBQ for manufacture given the following data:

Monthly demand = 500 units

Daily production rate = 25 units

Days in a month = 25 days

Cost of set-up = Rs. 1,500

Cost of holding inventory = Rs.10 per unit per year

Solution:

Annual Demand $A = 500 \times 12 = 6000$ units per year

$$\begin{aligned} \text{The daily consumption rate } r &= \frac{\text{Monthly Consumption}}{\text{No.of days in a month}} = \frac{500}{25} \\ &= 20 \text{ units per days} \end{aligned}$$

The above problem of optimal manufacturing batch size is confined to a case where only one product is being manufactured. In practice, a number of different products may be

manufactured on the same plant facility. One might argue that the formula for the single product can be used to determine individually the optimal batch quantities for different products. Although this individual determination of the manufacturing batch sizes would produce most economical results as far as individual products are concerned, it might present some difficulties in a few cases.

When multiple products share the same plant facility, there are chances of interferences and therefore, stock-outs occur. Such interference between different products is experienced sometimes, when the products share the same equipment but the batch quantities are calculated independently. To avoid this kind of problem, it is suggested that the economic batch size of the products using the same plant facility be determined jointly. Therefore, there will be joint cycles of manufacture and in each joint cycle all the products will be manufactured in appropriate quantities. The determination of the economic batch sizes of the different products then amounts to the determination of the optimal number of joint cycles in a year; annual demand for a product divided by the optimal number of joint cycles gives the economic batch quantity for the product.

Since all the products, using the same plant facility, are manufactured, one after another in each optimal joint cycle, there is no question of shortage of any product at any time. The principle to be followed in joint cycle determination is similar to that for the determination of the optimal batch quantity for individual products. Numerical based on joint cycles are beyond the scope of this chapter.

Safety Stock

The inventory models discussed so far are based on the common assumption of constant and known demand for the item and the lead-time. Therefore, these models are called deterministic models. The models that consider the situation in which the demand and demand and/or lead-time are not known with certainty and they need not be constant is beyond the scope of this chapter. In these models, demand and lead time are taken as random variables, capable of assuming varying values whose probability distribution may be known.

In the models, the stock is replenished as soon as the stock reaches the point of exhaustion, due to the assumption underlying them. Under such idealistic situation, there is no need to maintain any extra stock because the supplies would reach the moments the stock level

reduce to zero and there would be no stock outs (unless they are intentionally allowed to occur). However when the demand is varying and so is the lead time, there is a need to provide for the safety or buffer stock in order to meet either or both the lead time, there is a need to provide for the safety or buffer stocks in order to meet either or both the contingencies, viz. that demand rate during the lead time is in excess of what was expected/forecasted and that the delivery of good is delayed. The safety stock, then acts as a cushion against stock-outs caused by random deviations of nature.

The safety stock is an important constituent of the re-order level that is determined as the expected demand of the item during lead time plus the safety stock. If the demand varies about the mean daily demand equal to d with the expected lead time equal to L days, and we set the re-order level R at L units, then we should expect a shortage to occur in about half the lead time periods. To reduce this 50% probability of being out of stock, the safety stock SS would be required to be kept. Thus,

Re-order level, $R = L \cdot d + S.S.$

We know that in this system, an order is placed as soon as it reaches the re-order level. Therefore, how high or low is the rate of demand before the re-order level reaches is of little consequence. What is significant is the level of demand during the lead-time. Here fresh supplies are received as soon as the stock level reaches the safety level. In this kind of a situation, the average stock held would be exactly equal to $SS + Q/2$.

The idea of keeping the safety stock is clearly to prevent stock out and it is the amount of stock that the organization would always like preserve for meeting extraordinary situation. In general higher safety stock would be called for in situation where costs of stock out are larger; higher levels of service (i.e. meeting greater proportion of demand) are sought; significant variation are observed in the lead time and/or time demand; and where holding costs are smaller. Naturally, the higher the level of safety stock the greater the service level and therefore to strike a balance between the two, The optimal safety stock level is determined where successively declining stock out costs and successively rising holding costs, caused by the successive units added to the safety stock, would balance.

There is no rigid formulation for determining the optimum level of safety. The different approaches available for the purpose are based on the demand, the lead time and the stock

out costs. The complexity of the situation is determined by the extent and nature of information available about these factors.

Inventory Model with Purchase Discounts:

The classical model for inventory does not take into account, amongst other things, the quantity discounts given by the supplier if material is purchased in bulk. As the discount might be relevant in the inventory analysis, this could be included in the total relevant cost and therefore in this case, the total cost function becomes:

Where p is the supply price per unit of the inventory item and f is the carrying cost of the inventory expressed as a fraction of the inventory value. (Other nomenclature remains the same.)

Differentiating the total costs with respect to Q and equating the result to zero, we get the optimal procurement quantity.

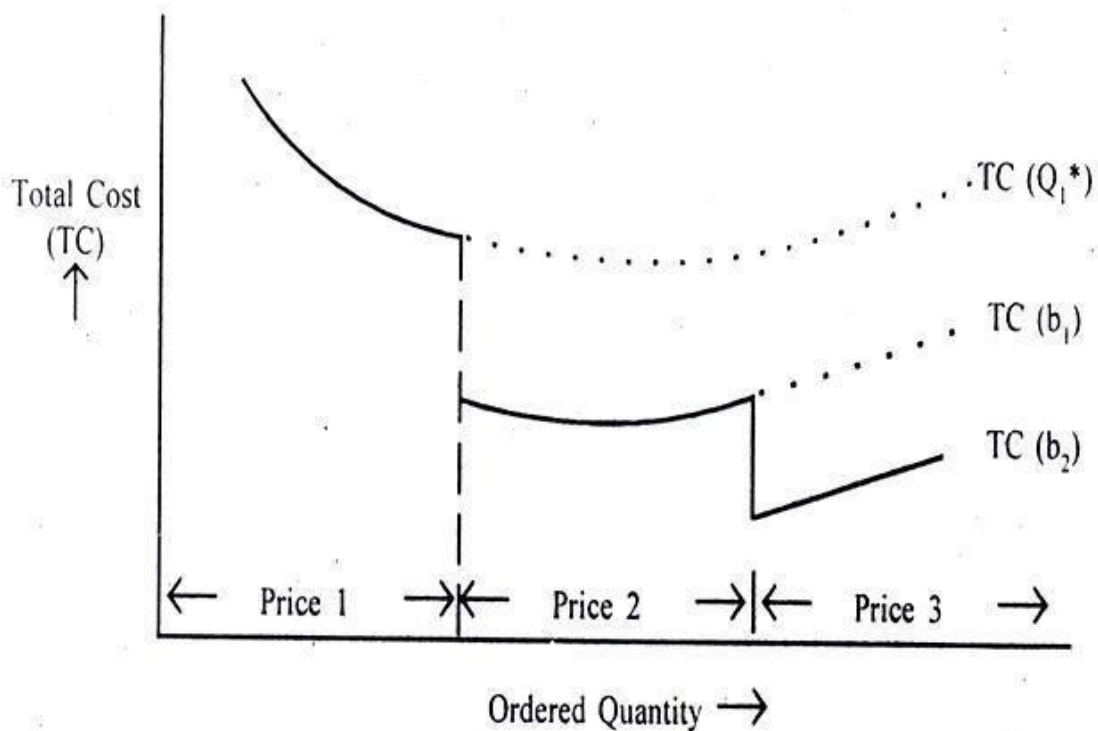

At the two different prices (1 and 2) the Q_{optimal} values are different. Which one shall we choose Q_{optimal} for price 1 or Q_{optimal} for price 2 the answer is not straightforward. We shall have to plot the total cost (relevant) with respect to the procurement lot size. For lot sizes less than b price 1 is operative and we get a total cost curve corresponding to it. For lot sizes equal to or greater than b we get another total cost curve. These curves need not exhibit minima within their zone. Price 1 total cost curve can have a minimum in the zone where price 2 is operating. Conversely, Price 2 total cost curve can have a minimum in zone where price 1 is operating.

It should be noted that due to the earlier given equations, the total cost curve for the second price will always be lower than the total cost curve for the first price, the minimum total cost for the second price will be lower than the minimum total cost for price 1, and the Q_{optimal} for price 2 will always be higher than Q_{optimal} for price 1. In spite of this, the three possibilities arise.

Here again, it is obvious that we choose Q_{optimal} in fact Q_{optimal} does not exist. The lowest of the total cost at price 1 is at price 1 is lot size 'b' and this total cost will have to be higher than the total cost for Q_{optimal} .

Here price 2 curve shows a minimum in the price 1 zone and the minimum is therefore imaginary. Hence, the only choice is between Q_{optimal} and the price break quantity (at which the real part of the price 2 curve begins). This can be decided by comparing the total costs corresponding to the two choices.

The determination of the optimal quantity in the case of purchase discounts, therefore, follows the procedure given below:

1. Calculate Q_{optimal} the optimal lot size corresponding to price 2.
2. Find out if the Q_{optimal} falls in its own range. If so, desired optimal order quantity is Q_{optimal} if not, carry out the following procedure.
3. Compare the total cost at Q_{optimal} with the total cost corresponding to the lot size 'b' (price break quantity) at the second price. If the former is less than the latter,

Choose Q_{optimal} Otherwise, the optimal order quantity is equal to the price-break point.

Example: The supply of a special component has the following price schedule.

0 to 99 item: Rs 1000 per unit

100 items and above: Rs 950 per unit

The inventory holding costs are estimated to be 25% of the value of the inventory. The procurement ordering costs are estimated to be Rs. 2,000 per order. If the annual requirement of the special component is 300, compute the economic order for the procurement of these items.

Steps 2 and 3:

Therefore, we have to determine the optimal total cost for the first price and total cost at the price-break point corresponding to the second price, and compare the two.

The total cost (optimal for the first price)

$$\begin{aligned} &= \sqrt{2 \times 2000 \times 1000 \times 0.25} \times 300 + 1000 \times 300 \\ &= 17,320 + 300,000 = \text{Rs. } 3,17,320 \end{aligned}$$

The total cost for the price-break point (corresponding to the second price):

$$\begin{aligned} \text{TC} &= 200 \times \frac{300}{100} + \frac{100}{2} \times 950 \times 0.25 + 950 \times 300 \\ &= 6,000 + 11,875 + 285,000 \\ &= 3,02,875 \end{aligned}$$

This is lower than the total cost corresponding to Q_{optimal} .

Therefore, the economic quantity for a procurement lot is 100 units (price-break point).

Consideration of Uncertainties:

In the above given models for the determination of 'normal' inventory consumption rates were assumed to be constant. In actual practice, there are always uncertainties stemming from two basic reasons:

1. Variability in sales, hence variability in the demand for the materials or the consumption of the materials
2. Delay in the supplies of raw materials.

Summary:

- ❖ Inventory serves a useful purpose in the manufacturing organizations. Firms can help minimize the need for inventory by carefully managing those factors that drive inventory levels up
- ❖ Inventory items can be divided into two main types: Independent demand and dependent demand items. The systems for managing these two types of demand, inventories differ significantly
- ❖ The two classic systems for managing independent demand inventory are periodic review and perpetual review systems
- ❖ The economic order quantity (EOQ) is the order quantity that minimizes total holding and ordering costs for the year. Even if all the assumptions don't hold exactly, the EOQ gives us a good indication of whether or not current order quantities are reasonable

- ❖ The reorder point formula allows us to determine the safety stock (SS) needed to achieve a certain cycle service level. In general, the longer the lead times are, and the greater the variability of demand and lead times, the more SS we will need
- ❖ Inventories are vital to the successful functioning of manufacturing and retailing organizations
- ❖ The basic questions to keep in mind before getting any inventory:
 - a) How much inventory to keep
 - b) When to keep the inventory in the warehouse
- ❖ Buffer stock is kept for review period + lead-time
- ❖ Maximum inventory on hand is (Normal consumption + Buffer Stock) both for review period plus on order.

Keywords:

- **Inventory:** is working capital and therefore the control of inventories is an important aspect of operations management
- **Lead Time:** The time elapsing between placing an order and having goods in stock
- **Procurement costs:** associated with processing and chasing of an order, transportation, inspection for quality, expediting overdue orders and so on

Self-assessment Questions:

1. Define inventory. Discuss various types of inventory costs.
2. Discuss various types of inventories.
3. What are the basic assumptions underlying the classical EOQ model? Also discuss its limitations.
4. What is the set-up cost of manufacture?
5. Discuss economic batch quantity with suitable example.

References:

R.G. Schroeder, Operation Management- Decision Making in the Operations Function, McGraw-Hill, International Student Edu, 1985

J.K Sharma, Operations Management – Text and Cases, Trinity Press, 5th Edition

Ajay K Garg, Production and Operations Management, McGraw Hill

Charry, Production and Operations Management, McGraw Hill, 5th

Edition Kanishka Bedi, Production and Operations Management,

Oxford, 2nd Edition

UNIT II FORECASTING

Structure

- Introduction
- Demand Forecasting
- Types of Forecasting
- Forecasting Techniques
- Utility of Forecasting
- Forecasting Models
- Criteria of a Good Forecasting Method
- Techniques of Inventory Control System
- Key Terms
- Self assessment questions
- References

Introduction

Inventory means stock. It is essential in an organization for production activities and maintenance of plant and machinery and for other operational requirements. The normal tendency is to have more inventories so that most of the items are available when required.

Production control means controlling the production by using various methods of demand forecasting. Production control is the task of predicting, planning and scheduling work, taking into account manpower, materials availability and other capacity restrictions, and cost so as to achieve proper quality and quantity at the time it is needed

and then following up the schedule to see that the plan is carried out, using whatever systems have proven satisfactory for the purpose.

Demand forecasting is the art and science of forecasting customer demand to drive holistic execution of such demand by corporate supply chain and business management. Demand forecasting involves techniques including both informal methods, such as educated guesses, and quantitative methods, such as the use of historical sales data and statistical techniques or current data from test markets. Demand forecasting may be used in production planning, inventory management, and at times in assessing future capacity requirements, or in making decisions on whether to enter a new market

Demand forecasting is predicting future demand for the product. In other words it refers to the prediction of probable demand for a product or a service on the basis of the past events and prevailing trends in the present.

Need of Inventory

Adequate inventory ensures uninterrupted supply of finished goods and continuous production. The most significant aspect of inventory is that it should all be known and quantified. For example, we have working stock because we can't make or buy just one every time we sell or use one. We have safety stock because of lead times, forecast errors, service requirements, etc., and our customers are unwilling to wait. We may have extra stock to buffer against supply variability, for example because of poor vendor performance, manufacturing problems, or seasonal product availability. Lastly we could require hedge stock because we may know of a future price increase. Of course the above could occur at any level of the bill of materials, i.e., finished goods, work in process, or raw materials. For this discussion, we will concentrate just on the first two reasons for maintaining the inventories: working stock and safety stock, and just at the finished goods level. When we started in business, we concentrated at first on just the finished goods. Eventually, however, we did the research and development necessary to expand the science to address inventory at all levels

Forecasts are becoming the lifetime of business in a world, where the tidal waves of change are sweeping the most established of structures, inherited by human society.

Commerce just happens to the one of the first casualties. Survival in this age of economic predators requires the tact, talent and technique of predicting the future.

Forecast is becoming the sign of survival and the language of business. All requirements of the business sector need the technique of accurate and practical reading into the future. Forecasts are, therefore, very essential requirement for the survival of business. Management requires forecasting information when making a wide range of decisions.

Demand forecasting is predicting future *demand* for the product. In other words it refers to the prediction of probable *demand* for a product or a service on the basis of the past events and prevailing trends in the present.

Meaning of demand forecast

A demand forecast is the prediction of what will happen to your company's existing product sales. It would be best to determine the demand forecast using a multi-functional approach. The inputs from sales and marketing, finance, and production should be considered. The final demand forecast is the consensus of all participating managers. You may also want to put up a Sales and Operations Planning group composed of representatives from the different departments that will be tasked to prepare the demand forecast

The sales forecast is particularly important as it is the foundation upon which all company plans are built in terms of markets and revenue. Management would be a simple matter if business was not in a continual state of change, the pace of which has quickened in recent years.

It is becoming increasingly important and necessary for business to predict their future prospects in terms of sales, cost and profits. The value of future sales is crucial as it affects costs profits, so the prediction of future sales is the logical starting point of all business planning.

A forecast is a prediction or estimation of future situation. It is an objective assessment of future course of action. Since future is uncertain, no forecast can be percent correct. Forecasts can be both physical as well as financial in nature. The more realistic the forecasts, the more effective decisions can be taken for tomorrow.

In the words of Cundiff and Still, “Demand forecasting is an estimate of sales during a specified future period which is tied to a proposed marketing plan and which assumes a particular set of uncontrollable and competitive forces”. Therefore, demand forecasting is a projection of firm’s expected level of sales based on a chosen marketing plan and environment.

Procedure to Prepare Sales Forecast:

Companies commonly use a three-stage procedure to prepare a sales forecast. They make an environmental forecast, followed by an industry forecast, and followed by a company’s sales forecast, the environmental forecast calls for projecting inflation, unemployment, interest rate, consumer spending, and saving, business investment, government expenditure, net exports and other environmental magnitudes and events of importance to the company.

The industry forecast is based on surveys of consumers’ intention and analysis of statistical trends is made available by trade associations or chamber of commerce. It can give indication to a firm regarding the direction in which the whole industry will be moving. The company derives its sales forecast by assuming that it will win a certain market share.

All forecasts are built on one of the three information bases:

What people say?

What people do?

What people have done?

Types of Forecasting:

There are different basis to differentiate the forecasts.

Forecasts can be broadly classified into:

- (1) *Passive Forecast:* Under passive forecast prediction about future is based on the assumption that the firm does not change the course of its action.
- (2) *Active Forecast:* Under active forecast, prediction is done under the condition of likely future changes in the actions by the firms.

On the basis of 'time span', forecasting may be classified into two categories:

- (1) Short term demand forecasting: In a short run forecast, seasonal patterns are of much importance. It may cover a period of three months, six months or one year. It is one which provides information for tactical decisions. Which period is chosen depends upon the nature of business. Such a forecast helps in preparing suitable sales policy.
- (2) Long term demand forecasting: Long term forecasts are helpful in suitable capital planning. It is one which provides information for major strategic decisions. It helps in saving the wastages in material, man hours, machine time and capacity. Planning of a new unit must start with an analysis of the long term demand potential of the products of the firm.

Timescale	Type of decision	Examples
Short-term Up to 3-6 months	Operating	Inventory control Production planning, distribution
Medium-term 3-6 months - 2 years	Tactical	Leasing of plant and equipment Employment changes
Long-term Above 2 years	Strategic	Research and development, Acquisitions and mergers, Product changes

Forecasts may further be divided into two categories as below:

- *External or national group of forecast:* External forecast deals with trends in general business. It is usually prepared by a company's research wing or by outside consultants.
- *Internal or company group forecast:* Internal forecast includes all those that are related to the operation of a particular enterprise such as sales group, production group, and financial group. The structure of internal forecast includes forecast of annual sales, forecasts of products cost, forecast of operating profit, forecast of taxable income, forecast of cash resources, forecast of the number of employees, etc.

Forecasting may be classified as below at different levels:

- Macro-level forecasting
- Industry- level forecasting
- Firm- level forecasting
- Product-line forecasting

Macro-level forecasting is concerned with business conditions over the whole economy. It is measured by an appropriate index of industrial production, national income or expenditure. Industry-level forecasting is prepared by different trade associations. This is based on survey of consumers' intention and analysis of statistical trends. Firm-level forecasting is related to an individual firm. It is most important from managerial view point. Product-line forecasting helps the firm to decide which of the product or products should have priority in the allocation of firm's limited resources.

Forecast may be general or specific in nature. The general forecast may generally be useful to the firm. Many firms require separate forecasts for specific products and specific areas, for this general forecast is fragmented further into specific forecasts.

There are different forecasts for different types of products like:

- ❖ Forecasting demand for nondurable consumer goods
- ❖ Forecasting demand for durable consumer goods
- ❖ Forecasting demand for capital goods

❖ Forecasting demand for new-products

Non-Durable Consumer Goods:

These are also known as 'single-use consumer goods' or perishable consumer goods. These vanish after a single act of consumption. These include goods like food, milk, medicine, fruits, etc. Demand for these goods depends upon household disposable income, price of the commodity and the related goods and population and characteristics. Symbolically,

$$D_c = f(y, s, p, p_r)$$

Where;

D_c = the demand for commodity c

y = the household disposable income

s = population

p = price of the commodity c

p_r = price of its related goods

Disposable income expressed as $D_c = f(y)$ i.e. other things being equal, the demand for commodity c depends upon the disposable income of the household. Disposable income of the household is estimated after the deduction of personal taxes from the personal income. Disposable income gives an idea about the purchasing power of the household.

Price, expressed as $D_c = f(p, p_r)$ i.e. other things being equal, demand for commodity c depends upon its own price and the price of related goods. While the demand for a commodity is inversely related to its own price of its complements. It is positively related to its substitutes. Price elasticity and cross-elasticity of non-durable consumer goods help in their demand forecasting

Population, expressed as $D_c = f(s)$ i.e. other things being equal, demand for commodity c depends upon the size of population and its composition. Besides, population can also be classified on the basis of sex, income, literacy and social status. Demand for non-durable consumer goods is influenced by all these factors. For the general demand forecasting

population as a whole is considered, but for specific demand forecasting division of population according to different characteristics proves to be more useful.

The various steps involved in forecasting the demand for non-durable consumer goods are the following:

- (i) First identify the variables affecting the demand for the product and express them in appropriate forms,
- (ii) Gather relevant data or approximation to relevant data to represent the variables, and
- (iii) Use methods of statistical analysis to determine the most probable relationship between the dependent and independent variables.

Durable Consumer Goods:

These goods can be consumed a number of times or repeatedly used without much loss to their utility. These include goods like car, T.V., air-conditioners, furniture etc. After their long use, consumers have a choice either these could be consumed in future or could be disposed of.

The choice depends upon the following factors:

- Whether a consumer will go for the replacement of a durable good or keep on using it after necessary repairs depends upon his social status, level of money income, taste and fashion, etc. Replacement demand tends to grow with increase in the stock of the commodity with the consumers. The firm can estimate the average replacement cost with the help of life expectancy table.
- Most consumer durables are consumed in common by the members of a family. For instance, T.V., refrigerator, etc. are used in common by households. Demand forecasts for goods commonly used should take into account the number of households rather than the total size of population. While estimating the number of

households, the income of the household, the number of children and sex-composition, etc. should be taken into account.

- Demand for consumer durables depends upon the availability of allied facilities. For example, the use of T.V., refrigerator needs regular supply of power, the use of car needs availability of fuel, etc. While forecasting demand for consumer durables, the provision of allied services and their cost should also be taken into account.
- Demand for consumer durables is very much influenced by their prices and their credit facilities. Consumer durables are very much sensitive to price changes. A small fall in their price may bring large increase in demand.

Forecasting Demand for Capital Goods:

Capital goods are used for further production. The demand for capital good is a derived one. It will depend upon the profitability of industries. The demand for capital goods is a case of derived demand. In the case of particular capital goods, demand will depend on the specific markets they serve and the end uses for which they are bought.

The demand for textile machinery will, for instance, be determined by the expansion of textile industry in terms of new units and replacement of existing machinery. Estimation of new demand as well as replacement demand is thus necessary.

Three types of data are required in estimating the demand for capital goods:

- a) The growth prospects of the user industries must be known,
- b) The norm of consumption of the capital goods per unit of each end-use product must be known, and
- c) The velocity of their use.

Forecasting Demand for New Products:

The methods of forecasting demand for new products are in many ways different from those for established products. Since the product is new to the consumers, an intensive study of the product and its likely impact upon other products of the same group provides a key to an intelligent projection of demand.

Joel Dean has classified a number of possible approaches as follows:

- *Evolutionary Approach:* It consists of projecting the demand for a new product as an outgrowth and evolution of an existing old product.
- *Substitute Approach:* According to this approach the new product is treated as a substitute for the existing product or service.
- *Growth Curve Approach:* It estimates the rate of growth and potential demand for the new product as the basis of some growth pattern of an established product.
- *Opinion-Poll Approach:* Under this approach the demand is estimated by direct enquiries from the ultimate consumers.

- *Sales Experience Approach:* According to this method the demand for the new product is estimated by offering the new product for sale in a sample market.

- *Vicarious Approach:* By this method, the consumers' reactions for a new product are found out indirectly through the specialized dealers who are able to judge the consumers' needs, tastes and preferences.

Forecasting Techniques:

Demand forecasting is a difficult exercise. Making estimates for future under the changing conditions is a Herculean task. Consumers' behaviour is the most unpredictable one because it is motivated and influenced by a multiplicity of forces. There is no easy method or a simple formula which enables the manager to predict the future.

Economists and statisticians have developed several methods of demand forecasting. Each of these methods has its relative advantages and disadvantages. Selection of the right method is essential to make demand forecasting accurate. In demand forecasting, a judicious combination of statistical skill and rational judgment is needed.

Mathematical and statistical techniques are essential in classifying relationships and providing techniques of analysis, but they are in no way an alternative for sound judgment. Sound judgment is a prime requisite for good forecast.

The judgment should be based upon facts and the personal bias of the forecaster should not prevail upon the facts. Therefore, a mid way should be followed between mathematical techniques and sound judgment or pure guess work.

The various methods of demand forecasting can be as below:

Qualitative Methods/ Techniques:

(1) **Opinion Polling Method:** In this method, the opinion of the buyers, sales force and experts could be gathered to determine the emerging trend in the market. The opinion polling methods of demand forecasting are of three kinds:

- ✓ **Consumer's Survey Method or Survey of Buyer's Intentions:** In this method, the consumers are directly approached to disclose their future purchase plans. This is done by interviewing all consumers or a selected group of consumers out of the relevant population. This is the direct method of estimating demand in the short run. Here the burden of forecasting is shifted to the buyer. The firm may go in for complete enumeration or for sample surveys. If the commodity under consideration is an intermediate product then the industries using it as an end product are surveyed.
- ✓ **Complete Enumeration Survey:** Under the Complete Enumeration Survey, the firm has to go for a door to door survey for the forecast period by contacting all the households in the area. This method has an advantage of first hand, unbiased information, yet it has its share of disadvantages also. The major limitation of this method is that it requires lot of resources, manpower and time. In this method,

consumers may be reluctant to reveal their purchase plans due to personal privacy or commercial secrecy. Moreover, at times the consumers may not express their opinion properly or may deliberately misguide the investigators.

- ✓ **Sample Survey and Test Marketing:** Under this method some representative households are selected on random basis as samples and their opinion is taken as the generalized opinion. This method is based on the basic assumption that the sample truly represents the population. If the sample is the true representative, there is likely to be no significant difference in the results obtained by the survey. Apart from that, this method is less tedious and less costly. A variant of sample survey technique is test marketing. Product testing essentially involves placing the product with a number of users for a set period. Their reactions to the product are noted after a period of time and an estimate of likely demand is made from the result. These are suitable for new products or for radically modified old products for which no prior data exists. It is a more scientific method of estimating likely demand because it stimulates a national launch in a closely defined geographical area.

- (2) **End Use Method or Input-Output Method:** This method is quite useful for industries which are mainly producer's goods. In this method, the sale of the product under consideration is projected as the basis of demand survey of the industries using this product as an intermediate product, that is, the demand for the final product is the end user demand of the intermediate product used in the production of this final product.

The end user demand estimation of an intermediate product may involve many final good industries using this product at home and abroad. It helps us to understand the relationship among various industries. In input-output accounting two matrices used are the transaction matrix and the input co-efficient matrix. The major efforts required by this type are not in its operation but in the collection and presentation of data.

- (3) **Sales Force Opinion Method:** This is also known as collective opinion method. In this method, instead of consumers, the opinion of the salesmen is sought. It is sometimes referred as the "grass roots approach" as it is a bottom-up method that

requires each sales person in the company to make an individual forecast for his or her particular sales territory.

These individual forecasts are discussed and agreed with the sales manager. The composite of all forecasts then constitutes the sales forecast for the organization. The advantages of this method are that it is easy and cheap. It does not involve any elaborate statistical treatment. The main merit of this method lies in the collective wisdom of salesmen. This method is more useful in forecasting sales of new products.

- (4) **Experts Opinion Method:** This method is also known as “*Delphi Technique*” of investigation. The Delphi method requires a panel of experts, who are interrogated through a sequence of questionnaires in which the responses to one questionnaire are used to produce the next questionnaire. Thus any information available to some experts and not to others is passed on, enabling all the experts to have access to all the information for forecasting.

The method is used for long term forecasting to estimate potential sales for new products. This method presumes two conditions: Firstly, the panelists must be rich in their expertise, possess wide range of knowledge and experience. Secondly, its conductors are objective in their job. This method has some exclusive advantages of saving time and other resources.

Statistical Methods/ Techniques:

Statistical methods have proved to be immensely useful in demand forecasting. In order to maintain objectivity, that is, by consideration of all implications and viewing the problem from an external point of view, the statistical methods are used.

The important statistical methods are discussed as below:

- (1) **Trend Projection Method:** A firm existing for a long time will have its own data regarding sales for past years. Such data when arranged chronologically yield what is referred to as ‘time series’. Time series shows the past sales with effective demand for a particular product under normal conditions. Such data can be given in a tabular

or graphic form for further analysis. This is the most popular method among business firms, partly because it is simple and inexpensive and partly because time series data often exhibit a persistent growth trend.

Time series has got four types of components namely, Secular Trend (T), Secular Variation (S), Cyclical Element (C), and an Irregular or Random Variation (I). These elements are expressed by the equation $O = TSCI$. Secular trend refers to the long run changes that occur as a result of general tendency. Seasonal variations refer to changes in the short run weather pattern or social habits. Cyclical variations refer to the changes that occur in industry during depression and boom. Random variation refers to the factors which are generally able such as wars, strikes, flood, and food shortage and so on.

When a forecast is made the seasonal, cyclical and random variations are removed from the observed data. Thus only the secular trend is left. This trend is then projected. Trend projection fits a trend line to a mathematical equation.

The trend can be estimated by using any one of the following methods:

- a) ***The Graphical Method:*** This is the most commonly used simple technique to determine the trend. All values of output or sale for different years are plotted on a graph and a smooth free hand curve is drawn passing through as many points as possible. The direction of this free hand curve—upward or downward— shows the trend. This may be easily understood from the following table:

Sales of Firm

Year	Sales (Rs.Crore)
1995	40
1996	50
1997	44
1998	60

1999	54
2000	62

b) **Least Square Method:** Under the least square method, a trend line can be fitted to the time series data with the help of statistical techniques such as least square regression. When the trend in sales over time is given by straight line, the equation of this line is of the form: $y = a + b x$. Where, 'a' is the intercept and 'b' shows the impact of the independent variable. We have two variables:- the independent variable x and the dependent variable y. The line of best fit establishes a kind of mathematical relationship between the two variables .v and y. This is expressed by the regression y on x.

In order to solve the equation $y = a + b x$, we have to make use of the following normal equations:

$$\Sigma y = n a + b \Sigma x$$

$$\Sigma x y = a \Sigma x + b \Sigma x^2$$

(2) **Barometric Technique:** A barometer is an instrument to measure changes. This method is based on the notion that “the future can be predicted from certain happenings in the present.” In other words, barometric techniques are based on the idea that certain events of the present can be used to predict the directions of change in the future. This is accomplished by the use of economic and statistical indicators which serve as barometers of economic change.

Generally forecasters correlate a firm's sales with three series: Leading Series, Coincident or Concurrent Series and Lagging Series:

(a) **The Leading Series:** The leading series comprise those factors which move up or down before the recession or recovery starts. They tend to reflect future market changes. For example, baby powder sales can be forecasted by examining the birth rate pattern five years earlier, because there is a correlation between the baby

powder sales and children of five years of age and since baby powder sales today are correlated with birth rate five years earlier, it is called lagged correlation. Thus we can say that births lead to baby soaps sales.

- (b) **Coincident or Concurrent Series:** The coincident or concurrent series are those which move up or down simultaneously with the level of the economy. They are used in confirming or refuting the validity of the leading indicator used a few months afterwards. Common examples of coinciding indicators are G.N.P itself, industrial production, trading and the retail sector.
- (c) **The Lagging Series:** The lagging series are those which take place after some time lag with respect to the business cycle. Examples of lagging series are, labour cost per unit of the manufacturing output, loans outstanding, leading rate of short term loans, etc.
- (3) **Regression Analysis:** It attempts to assess the relationship between at least two variables (one or more independent and one dependent), the purpose being to predict the value of the dependent variable from the specific value of the independent variable. The basis of this prediction generally is historical data. This method starts from the assumption that a basic relationship exists between two variables. An interactive statistical analysis computer package is used to formulate the mathematical relationship which exists.

For example, one may build up the sales model as:

Magnitude of Sales = a (price) + b (advertising) + c (price of the competing product) + d (personal disposable income) + u

Where a, b, c, d are the constants which show the effect of corresponding variables as sales. The constant u represents the effect of all the variables which have been left out in the equation but having effect on sales. In the above equation, magnitude of sales is the dependent variable and the variables on the right hand side of the equation are independent variables. If the expected values of the independent variables are substituted

The regression equation can also be written in a multiplicative form as given below:

$$\text{Magnitude of Sales} = (\text{Price})^a + (\text{Advertising})^b + (\text{Price of the rival products})^c + (\text{Personal disposable income})^e + u$$

In the above case, the exponent of each variable indicates the elasticity of the corresponding variable. Stating the independent variables in terms of notation, the equation form is $MS = P^{0.8} \times A^{0.42} \times R^{0.83} \times Y_2^{0.68} \times 40$

Then we can say that 1 per cent increase in price leads to 0.8 per cent change in quantum of sales and so on.

We can also take the logarithmic form of this multiple equation, and then we can write the equation in an additive form as follows:

$$\text{Log MS} = a \log P + b \log A + c \log R + d \log Y_d + \log u$$

In the above equation, the coefficients a, b, c, and d represent the elasticity of variables P, A, R and Y_d respectively.

The co-efficient in the logarithmic regression equation are very useful in policy decision making by the management.

(4) Econometric Models:

Econometric models are an extension of the regression technique whereby a system of independent regression equation is solved. The requirement for satisfactory use of the econometric model in forecasting is under three heads: variables, equations and data.

The appropriate procedure in forecasting by econometric methods is model building. Econometrics attempts to express economic theories in mathematical terms in such a way that they can be verified by statistical methods and to measure the impact of one economic variable upon another so as to be able to predict future events.

Utility of Forecasting:

Forecasting cuts the risk associated with business fluctuations which generally produce harmful effects in business, create unemployment, induce speculation, discourage capital formation and reduce the profit margin. Forecasting is indispensable and it plays a very important part in the determination of various policies. In modern times forecasting has been put on scientific footing so that the risks associated with it have been considerably minimized and the chances of precision increased.

Forecasts in India:

In most of the advanced countries there are specialized agencies. In India businessmen are not at all interested in making scientific forecasts. They depend more on chance, luck and astrology. They are highly superstitious and hence their forecasts are not correct. Sufficient data are not available to make reliable forecasts. However, statistics alone do not forecast future conditions. Judgment, experience and knowledge of the particular trade are also necessary to make proper analysis and interpretation and to arrive at sound conclusions.

Conclusion:

Decision support systems consist of three elements: decision, prediction and control. It is, of course, with prediction that marketing forecasting is concerned. The forecasting of sales can be regarded as a system, having inputs appraises and an output.

This simplistic view serves as a useful measure for the analysis of the true worth of sales forecasting as an aid to management. In spite of all these no one can predict future economic activity with certainty. Forecasts are estimates about which no one can be sure.

Forecasting Models

One can classify the various models available for forecasting into three categories:

- *Extrapolative models:* They make use of past data and essentially prepare future estimates by some methods of extrapolating the past data. For example, the demand

for soft drinks in a city or a locality could be estimated as 110 percent of the average sales during the last three months. Similarly, the sale of new garments during the festive season could be estimated to be a percentage of the festive season sales during the previous year.

- *Casual models:* It analyses data from the point view of cause-effect relationship. For instance, to the process of estimating the demand for the new houses, the model will identify the factors that could influence the demand for the new houses and establish the relationship between these factors. The factors, for example, may include real estate prices, housing finance options, disposable income of families, and cost of construction and benefits derived from tax laws. Once a relationship between these variables and the demand is established, it is possible to use it for estimating the demand for new houses.
- *Subjective judgments:* Another set of models consist of subjective judgment using qualitative data. In some cases, it could be based on quantitative and qualitative data. In several of these methods special mechanisms incorporated to draw substantially from the expertise of group of senior managers using some collective decision making framework.

Selection of a forecasting technique:

The selection of a forecasting technique depends on the following three factors:

- (a) The characteristics of the decision making situation,
- (b) The characteristics of the forecasting methods,
- (c) Present situation

Criteria of a Good Forecasting Method:

There are thus, a good many ways to make a guess about future sales. They show contrast in cost, flexibility and the adequate skills and sophistication. Therefore, there is a problem of choosing the best method for a particular demand situation. There are certain economic criteria of broader applicability which have been discussed as follows:

(i) Accuracy:

The forecast obtained must be accurate. How is an accurate forecast possible? To obtain an accurate forecast, it is essential to check the accuracy of past forecasts against present performance and of present forecasts against future performance. Accuracy cannot be tested by precise measurement but by judgment.

(ii) Plausibility:

The executive should have good understanding of the technique chosen and they should have confidence in the techniques used. Understanding is also needed for a proper interpretation of results. Plausibility requirements can often improve the accuracy of results.

(iii) Durability:

Unfortunately, a demand function fitted to past experience may back cost very greatly and still fall apart in a short time as a forecaster. The durability of the forecasting power of a demand function depends partly on the reasonableness and simplicity of functions fitted, but primarily on the stability of the understanding relationships measured in the past. Of course, the importance of durability determines the allowable cost of the forecast.

(iv) Flexibility:

Flexibility can be viewed as an alternative to generality. A long lasting function could be set up in terms of basic natural forces and human motives. Even though fundamental, it would nevertheless be hard to measure and thus not very useful. A set of variables whose co-efficient could be adjusted from time to time to meet changing conditions in more practical way to maintain intact the routine procedure of forecasting.

(v) Availability:

Immediate availability of data is a vital requirement and the search for reasonable approximations to relevance in late data is a constant strain on the forecasters patience. The techniques employed should be able to produce meaningful results quickly. Delay in result will adversely affect the managerial decisions.

(vi) Economy:

Cost is a primary consideration which should be weighted against the importance of the forecasts to the business operations. A question may arise: How much money and managerial effort should be allocated to obtain a high level of forecasting accuracy? The criterion here is the economic consideration.

(vii) Simplicity:

Statistical and econometric models are certainly useful but they are intolerably complex. To those executives who have a fear of mathematics, these methods would appear to be Latin or Greek. The procedure should, therefore, be simple and easy so that the management may appreciate and understand why it has been adopted by the forecaster.

(viii) Consistency:

The forecaster has to deal with various components which are independent. If he does not make an adjustment in one component to bring it in line with a forecast of another, he would achieve a whole which would appear consistent.

In nutshell, an ideal forecasting method is one that yields returns over cost with accuracy, seems reasonable, can be formalized for reasonably long periods, can meet new circumstances adeptly and can give up-to-date results. The method of forecasting is not the same for all products.

There is no unique method for forecasting the sale of any commodity. The forecaster may try one or the other method depending upon his objective, data availability, the urgency with which forecasts are needed, resources he intends to devote to this work and type of commodity whose demand he wants to forecast.

Techniques of Inventory Control System

1. Setting up of various stock levels:

To avoid over-stocking and under stocking of materials, the management has to decide about the maximum level, minimum level, re-order level, danger level and average level of materials to be kept in the store. These terms are explained below:

a) Re-ordering level:

It is also known as 'ordering level' or 'ordering point' or 'ordering limit'. It is a point at which order for supply of material should be made.

This level is fixed somewhere between the maximum level and the minimum level in such a way that the quantity of materials represented by the difference between the re-ordering level and the minimum level will be sufficient to meet the demands of production till such time as the materials are replenished. Reorder level depends mainly on the maximum rate of consumption and order lead time. When this level is reached, the store keeper will initiate the purchase requisition.

Reordering level is calculated with the following formula:

Re-order level = Maximum Rate of consumption x max. lead time

(b) Maximum Level:

Maximum level is the level above which stock should never reach. It is also known as 'maximum limit' or 'maximum stock'. The function of maximum level is essential to avoid unnecessary blocking up of capital in inventories, losses on account of deterioration and obsolescence of materials, extra overheads and temptation to thefts etc. This level can be determined with the following formula. Maximum Stock level = Reordering level + Reordering quantity — (Minimum Consumption x Minimum re-ordering period)

(c) Minimum Level:

It represents the lowest quantity of a particular material below which stock should not be allowed to fall. This level must be maintained at every time so that production is not held up due to shortage of any material.

It is that level of inventories of which a fresh order must be placed to replenish the stock.

This level is usually determined through the following formula:

Minimum Level = Re-ordering level — (Normal rate of consumption x Normal delivery period)

(d) Average Stock Level:

Average stock level is determined by averaging the minimum and maximum level of stock.

The formula for determination of the level is as follows:

Average level = $1/2$ (Minimum stock level + Maximum stock level)

This may also be expressed by minimum level + $1/2$ of Re-ordering Quantity.

(e) Danger Level:

Danger level is that level below which the stock should under no circumstances be allowed to fall. Danger level is slightly below the minimum level and therefore the purchases manager should make special efforts to acquire required materials and stores.

This level can be calculated with the help of following formula:

Danger Level = Average rate of consumption x Emergency supply time.

(f) Economic Order Quantity (E.O.Q.):

One of the most important problems faced by the purchasing department is how much to order at a time. Purchasing in large quantities involve lesser purchasing cost. But cost of carrying them tends to be higher. Likewise if purchases are made in smaller quantities, holding costs are lower while purchasing costs tend to be higher.

Hence, the most economic buying quantity or the optimum quantity should be determined by the purchase department by considering the factors such as cost of ordering, holding or carrying.

This can be calculated by the following formula:

$$Q = \sqrt{2AS/I}$$

Where Q stands for quantity per order;

A stands for annual requirements of an item in terms of rupees;

S stands for cost of placement of an order in rupees; and

I stand for inventory carrying cost per unit per year in rupees.

2. Preparation of Inventory Budgets:

Organizations having huge material requirement normally prepare purchase budgets. The purchase budget should be prepared well in advance. The budget for production and consumable material and for capital and maintenance material should be separately prepared.

Sales budget generally provide the basis for preparation of production plans. Therefore, the first step in the preparation of a purchase budget is the establishment of sales budget.

As per the production plan, material schedule is prepared depending upon the amount and return contained in the plan. To determine the net quantities to be procured, necessary adjustments for the stock already held is to be made.

They are valued as standard rate or current market. In this way, material procurement budget is prepared. The budget so prepared should be communicated to all departments concerned so that the actual purchase commitments can be regulated as per budgets.

At periodical intervals actuals are compared with the budgeted figures and reported to management which provide a suitable basis for controlling the purchase of materials,

3. Maintaining Perpetual Inventory System:

This is another technique to exercise control over inventory. It is also known as automatic inventory system. The basic objective of this system is to make available details about the quantity and value of stock of each item at all times. Thus, this system provides a rigid control over stock of materials as physical stock can be regularly verified with the stock records kept in the stores and the cost office.

4. Establishing Proper Purchase Procedures:

A proper purchase procedure has to be established and adopted to ensure necessary inventory control. The following steps are involved.

(a) Purchase Requisition:

It is the requisition made by the various departmental heads or storekeeper for their various material requirements. The initiation of purchase begins with the receipts of a purchase requisition by the purchase department.

(b) Inviting Quotations:

The purchase department will invite quotations for supply of goods on the receipt of purchase requisition.

(c) Schedule of Quotations:

The schedule of quotations will be prepared by the purchase department on the basis of quotations received.

(d) Approving the supplier:

The schedule of quotations is put before the purchase committee who selects the supplier by considering factors like price, quality of materials, terms of payment, delivery schedule etc.

(e) Purchase Order:

It is the last step and the purchase order is prepared by the purchase department. It is a written authorization to the supplier to supply a specified quality and quantity of material at the specified time and place mentioned at the stipulated terms.

5. Inventory Turnover Ratio:

These are calculated to minimize the inventory by the use of the following formula:

Inventory Turnover Ratio = $\frac{\text{Cost of goods consumed/sold during the period}}{\text{Average inventory held during the period}}$

The ratio indicates how quickly the inventory is used for production. Higher the ratio, shorter will be the duration of inventory at the factory. It is the index of efficiency of material management.

The comparison of various inventory turnover ratios at different items with those of previous years may reveal the following four types of inventories:

(a) Slow moving Inventories:

These inventories have a very low turnover ratio. Management should take all possible steps to keep such inventories at the lowest levels.

(b) Dormant Inventories:

These inventories have no demand. The finance manager has to take a decision whether such inventories should be retained or scrapped based upon the current market price, conditions etc.

(c) Obsolete Inventories:

These inventories are no longer in demand due to their becoming out of demand. Such inventories should be immediately scrapped.

(d) Fast moving inventories:

These inventories are in hot demand. Proper and special care should be taken in respect of these inventories so that the manufacturing process does not suffer due to shortage of such inventories.

Perpetual inventory control system:

In a large business essential to have information about continuous availability of different types of materials and stores purchased, issued and their balance in hand. The perpetual inventory control system enables the manufacturer to know about the availability of these materials and stores without undergoing the cumbersome process of physical stock taking.

Under this method, proper information relating to receipt, issue and materials in hand is kept. The main objective of this system is to have accurate information about the stock level of every item at any time.

Perpetual inventory control system cannot be successful unless and until it is accompanied by a system of continuous stock taking i.e., checking the total stock of the concern 3/4 times a year by picking 10/15 items daily (as against physical stock taking which takes place once a year).

The items are taken in rotation. In order to have more effective control, the process of continuous stock taking is usually undertaken by a person other than the storekeeper. This will check the functioning of storekeeper also. The items may be selected at random to have a surprise check. The success of the system of perpetual inventory control depends upon the proper implementation of the system of continuous stock taking.

6. ABC analysis:

In order to exercise effective control over materials, A.B.C. (Always Better Control) method is of immense use. Under this method materials are classified into three categories in accordance with their respective values. Group 'A' constitutes costly items which may be only 10 to 20% of the total items but account for about 50% of the total value of the stores.

A greater degree of control is exercised to preserve these items. Group 'B' consists of items which constitutes 20 to 30% of the store items and represent about 30% of the total value of stores.

A reasonable degree of care may be taken in order to control these items. In the last category i.e. group 'Q' about 70 to 80% of the items is covered costing about 20% of the total value. This can be referred to as residuary category. A routine type of care may be taken in the case of third category.

This method is also known as 'stock control according to value method', 'selective value approach' and 'proportional parts value approach'.

If this method is applied with care, it ensures considerable reduction in the storage expenses and it is also greatly helpful in preserving costly items.

Key Terms

ABC Classification: Classification of inventory in three groups: an A group comprising items with a less volume and large rupee value, a B group comprising items with moderate volume and moderate rupee value, and C group comprising items with a large volume and small volume.

Inventory refers to the materials in stock. It is also called the idle resource of an enterprise. Inventories represent those items which are either stocked for sale or they are in the process of manufacturing or they are in the form of materials which are yet to be utilized.

Inventory control is a planned approach of determining what to order, when to order and how much to order and how much to stock so that costs associated with buying and storing are optimal without interrupting production and sales

Forecasting The process of analyzing and understanding current and past information to understand the future patterns through a scientific and systemic approach is called forecasting. And the process of estimating the future demand of product in terms of a unit or monetary value is referred to as demand forecasting.

Inventory Control System is a system the encompasses all aspects of managing a company's inventories; purchasing, shipping, receiving, tracking, warehousing and storage, turnover, and reordering

Self-Assessment Question

1. Define the term “forecasting” What is its purpose? Describe the uses and limitations of weighted moving average method of forecasting.
2. Discuss critically the different models of forecasting.
3. What are the possible consequences if a large-scale firm places its product in the market without having estimated the demand for its product?
4. Explain the regression method of demand forecasting.
5. Why is demand forecasting essential? Is demand forecasting equally important for small and big; old or new business ventures.
6. What do you mean by ‘Inventory Control’?

References

1. Everette E. Adam, Jr. Ronald J. Ebert, Production and Operations Management, Prentice Hall of India

2. Nair N.G., Production and Operations Management, Tata Mc. Graw Hill
3. Panneerselvam R, Production and Operations Management, Prentice Hall of India
4. Shafer Scott M., Operations Management, John Wiley

UNIT III

SCHEDULING

INTRODUCTION

Aggregate Planning is an intermediate planning method used to determine the necessary resource capacity a firm will need in order to meet its expected demand. It is an intermediate range capacity planning, usually covering 2/3 to 12/18 months. In other words, it is the matching of capacity and the demand in such a way that cost are minimized.

Definition

The term Aggregate Planning is defined as, “An operational activity which does an aggregate plan for the production process, in advance of 2 to 18 month, to give an idea to management as to what quantity of materials and other resources are to be procured and when, so that the total cost of operations of the organization is kept at minimum over that period”.

Aggregate planning is the process of developing, analyzing, and maintaining a preliminary, approximate schedule of the overall operations of an organization. The aggregate plan generally contains targeted sales forecasts, production levels, inventory levels, and customer backlogs. This schedule is intended to satisfy the demand forecast at a minimum cost. Properly done, aggregate planning should minimize the effects of shortsighted, day-to-day scheduling, in which small amounts of material may be ordered one week, with an accompanying layoff of workers, followed by ordering larger amounts and rehiring workers the next week. This longer-term perspective on resource use can help minimize short-term requirements changes with a resulting cost savings.

The main objectives of aggregate planning are summarized as hereunder:

- Maximize customer service.
- Minimize inventory investment.
- Minimize changes in workforce levels.
- Minimize changes in production rates.
- Maximize utilization of plant and equipment.

In simple terms, aggregate planning is an attempt to balance capacity and demand in such a way that costs are minimized. The term "aggregate" is used because planning at this

level includes all resources "in the aggregate;" for example, as a product line or family. Aggregate resources could be total number of workers, hours of machine time, or tons of

raw materials. Aggregate units of output could include gallons, feet, pounds of output, as well as aggregate units appearing in service industries such as hours of service delivered, number of patients seen, etc.

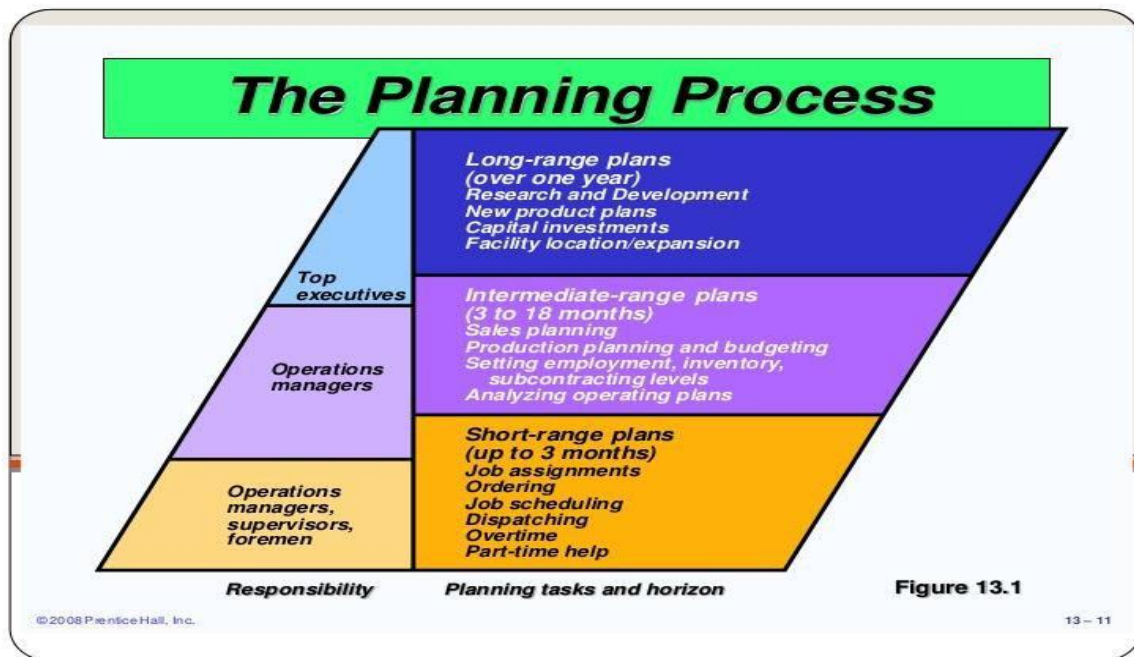

Aggregate planning does not distinguish among sizes, colors, features, and so forth. For example, with automobile manufacturing, aggregate planning would consider the total number of cars planned for not the individual models, colors, or options. When units of aggregation are difficult to determine (for example, when the variation in output is extreme) equivalent units are usually determined. These equivalent units could be based on value, cost, worker hours, or some similar measure.

Aggregate planning is considered to be intermediate-term (as opposed to long- or short-term) in nature. Hence, most aggregate plans cover a period of three to 18 months. Aggregate plans serve as a foundation for future short-range type planning, such as production scheduling, sequencing, and loading. The master production schedule (MPS) used in material requirements planning (MRP) has been described as the aggregate plan "disaggregated."

Steps taken to produce an aggregate plan begin with the determination of demand and the determination of current capacity. Capacity is expressed as total number of units per time period that can be produced (this requires that an average number of units be computed since the total may include a product mix utilizing distinctly different production times). Demand is expressed as total number of units needed. If the two are not in balance (equal),

the firm must decide whether to increase or decrease capacity to meet demand or increase or decrease demand to meet capacity. In order to accomplish this, a number of options are available.

Options for situations in which demand needs to be increased in order to match capacity include:

1. **Pricing.** Varying pricing to increase demand in periods when demand is less than peak. For example, matinee prices for movie theaters, off-season rates for hotels, weekend rates for telephone service, and pricing for items that experience seasonal demand.
2. **Promotion.** Advertising, direct marketing, and other forms of promotion are used to shift demand.
3. **Back ordering.** By postponing delivery on current orders demand is shifted to period when capacity is not fully utilized. This is really just a form of smoothing demand. Service industries are able to smooth demand by taking reservations or by making appointments in an attempt to avoid walk-in customers. Some refer to this as "partitioning" demand.
4. **New demand creation.** A new, but complementary demand is created for a product or service. When restaurant customers have to wait, they are frequently diverted into a complementary (but not complimentary) service, the bar. Other examples include the addition of video arcades within movie theaters, and the expansion of services at convenience stores.
5. Options which can be used to increase or decrease capacity to match current demand include:
 - a) **Hire/lay off.** By hiring additional workers as needed or by laying off workers not currently required to meet demand, firms can maintain a balance between capacity and demand.
 - b) **Overtime.** By asking or requiring workers to work extra hours a day or an extra day per week, firms can create a temporary increase in capacity without the added expense of hiring additional workers.
 - c) **Part-time or casual labor.** By utilizing temporary workers or casual labor (workers who are considered permanent but only work when needed, on an on-call basis, and typically without the benefits given to full-time workers).
 - d) **Inventory.** Finished-goods inventory can be built up in periods of slack demand and then used to fill demand during periods of high demand. In this way no new

- workers have to be hired, no temporary or casual labor is needed, and no overtime is incurred.
- e) **Subcontracting.** Frequently firms choose to allow another manufacturer or service provider to provide the product or service to the subcontracting firm's customers. By subcontracting work to an alternative source, additional capacity is temporarily obtained.
 - f) **Cross-training.** Cross-trained employees may be able to perform tasks in several operations, creating some flexibility when scheduling capacity.
 - g) **Other methods.** While varying workforce size and utilization, inventory buildup/backlogging, and subcontracting are well-known alternatives, there are other, more novel ways that find use in industry. Among these options are sharing employees with counter-cyclical companies and attempting to find interesting and meaningful projects for employees to do during slack times.

Aggregate Planning Inputs and Outputs:

In the figure as below, one can see all the necessary inputs required in aggregate planning. The important ones are including availability of resources, cost of equipments, cost of inventories etc.

The output generated mainly includes the total cost of plan and estimated levels of inventory, employment etc. These outputs are very significant in the decision making.

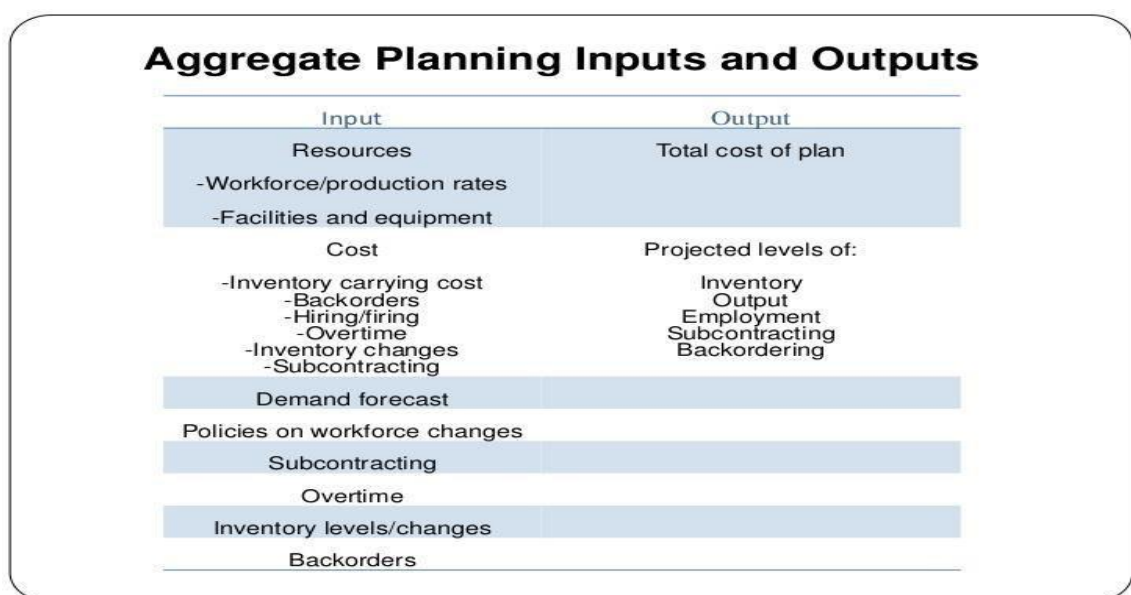

The main benefits are as follows:

- ❖ Determine demand for each period.
- ❖ Determine capacities for each period.
- ❖ Determine pertinent company policies.
- ❖ Determine unit cost based on all relevant sources.
- ❖ Develop alternative plans and calculate the cost for each.
- ❖ Choose the best overall plan based on company objectives and cost.

Aggregate Planning Strategies

There are two pure planning strategies available to the aggregate planner: a level strategy and a chase strategy. Firms may choose to utilize one of the pure strategies in isolation, or they may opt for a strategy that combines the two.

LEVEL STRATEGY

A level strategy seeks to produce an aggregate plan that maintains a steady production rate and/or a steady employment level. In order to satisfy changes in customer demand, the firm must raise or lower inventory levels in anticipation of increased or decreased levels of forecast demand. The firm maintains a level workforce and a steady rate of output when demand is somewhat low. This allows the firm to establish higher inventory levels than are currently needed. As demand increases, the firm is able to continue a steady production rate/steady employment level, while allowing the inventory surplus to absorb the increased demand.

A second alternative would be to use a backlog or backorder. A backorder is simply a promise to deliver the product at a later date when it is more readily available, usually when capacity begins to catch up with diminishing demand. In essence, the backorder is a device for moving demand from one period to another, preferably one in which demand is lower, thereby smoothing demand requirements over time.

A level strategy allows a firm to maintain a constant level of output and still meet demand. This is desirable from an employee relations standpoint. Negative results of the level strategy would include the cost of excess inventory, subcontracting or overtime costs, and

backorder costs, which typically are the cost of expediting orders and the loss of customer goodwill.

CHASE STRATEGY

A chase strategy implies matching demand and capacity period by period. This could result in a considerable amount of hiring, firing or laying off of employees; insecure and unhappy employees; increased inventory carrying costs; problems with labor unions; and erratic utilization of plant and equipment. It also implies a great deal of flexibility on the firm's part. The major advantage of a chase strategy is that it allows inventory to be held to the lowest level possible, and for some firms this is a considerable savings. Most firms embracing the just-in-time production concept utilize a chase strategy approach to aggregate planning.

Most firms find it advantageous to utilize a combination of the level and chase strategy. A combination strategy (sometimes called a hybrid or mixed strategy) can be found to better meet organizational goals and policies and achieve lower costs than either of the pure strategies used independently.

Techniques for Aggregate Planning

Techniques for aggregate planning range from informal trial-and-error approaches, which usually utilize simple tables or graphs, to more formalized and advanced mathematical techniques. William Stevenson's textbook *Production/Operations Management* contains an informal but useful trial-and-error process for aggregate planning presented in outline form. This general procedure consists of the following steps:

1. Determine demand for each period.
2. Determine capacity for each period. This capacity should match demand, which means it may require the inclusion of overtime or subcontracting.
3. Identify company, departmental, or union policies that are pertinent. For example, maintaining a certain safety stock level, maintaining a reasonably stable workforce, backorder policies, overtime policies, inventory level policies, and other less explicit rules such as the nature of employment with the individual industry, the possibility of a bad image, and the loss of goodwill.

4. Determine unit costs for units produced. These costs typically include the basic production costs (fixed and variable costs as well as direct and indirect labor costs). Also included are the costs associated with making changes in capacity. Inventory holding costs must also be considered, as should storage, insurance, taxes, spoilage, and obsolescence costs. Finally, backorder costs must be computed. While difficult to measure, this generally includes expediting costs, loss of customer goodwill, and revenue loss from cancelled orders.
5. Develop alternative plans and compute the cost for each.
6. If satisfactory plans emerge, select the one that best satisfies objectives. Frequently, this is the plan with the least cost. Otherwise, return to step 5.

Passive (reactive) Strategies in Aggregate Planning:

There are mainly two types of approaches in aggregate planning that have been discussed as below:

Chase approach

The chase method helps the firms to match production and demand by hiring and firing workers as necessary to control output. The Capacities (workforce levels, production schedules, output rates, etc.) are adjusted to match demand requirements over the planning horizon.

Merits:

- Anticipation inventory is not required, and investment in inventory is low
- Labor utilization is kept high

Demerits:

- Expense of adjusting output rates and/or workforce levels
- Alienation of workforce

Level Approach

The Level method allows for a constant rate of production and uses inventory levels to absorb fluctuations in demand. The Capacities (workforce levels, production schedules, output rates, etc.) are kept constant over the planning horizon

Merits:

- Stable output rates and workforce levels

Demerits:

- Greater inventory investment is required
- Increased overtime and idle time

- Resource utilizations vary over time

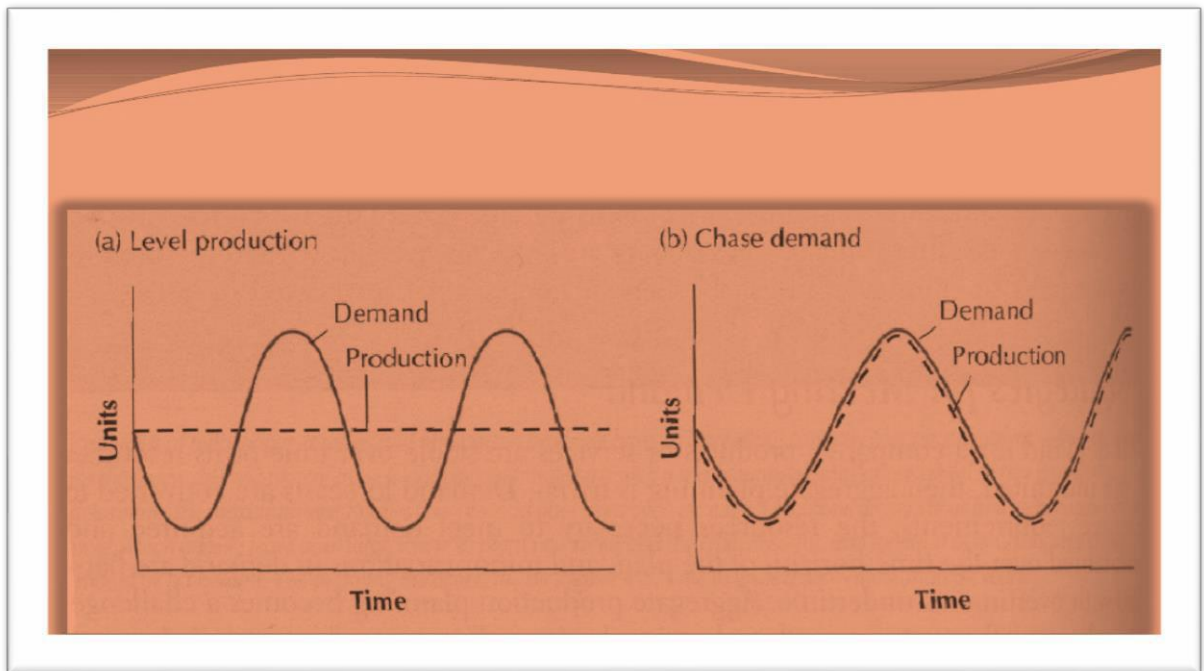

Aggregate Planning Methods/ Techniques

Techniques for aggregate planning range from informal trial-and-error approaches, which usually utilize simple tables or graphs, to more formalized and advanced mathematical techniques. Some Common Techniques are followings:

- Graphical/ Charting Method
- Linear Programming
- Simulation

Aggregate Planning Strategies

Active strategy:

- Attempts to handle fluctuations in demand by focusing on demand management

- Use pricing strategies and/or advertising and promotion
- Develop counter-cyclical products
- Request customers to backorder or advance-order
- Do not meet demand

Passive strategy (reactive strategy):

- Attempts to handle fluctuations in demand by focusing on supply and capacity management
- Vary size work force size by hiring or layoffs
- Vary utilization of labor and equipment through overtime or idle time
- Build or draw from inventory
- Subcontract production
- Negotiate cooperative arrangements with other firms
- Allow backlogs, back orders, and/or stock outs

Mixed strategy:

- Combines elements of both an active strategy and a passive (reactive) strategy
- Firms will usually use some combination of the two

Aggregate Planning Methods: Intuitive Methods

Intuitive methods use management intuition, experience, and rules-of-thumb, frequently accompanied by graphical and/or spreadsheet analysis. Its main benefit is that it is easy to use. But it gives many solutions most of which are not optimal.

Aggregate Planning Example:

Suppose you have the following forecasts for demand to meet:

Month	1	2	3	4	5	6
Demand	1000	1200	1500	1900	1800	1600

Relevant Costs:

Regular production cost	\$35/unit
Lost sales	\$100/unit

Inventory carrying costs	\$10/unit/month
Subcontracting costs	\$60/unit
Hiring costs	\$1500/worker
Firing costs	\$3000/worker
Beginning workforce level	20 workers
Capacity per worker	50 units/month
Initial inventory level	700 units
Closing inventory level	100 units

LEVEL PRODUCTION STRATEGY

Find the requirements for the period of the plan and produce the average amount needed per month to meet the plan.

First determine the average requirements per month:

Avg. requirements = total requirements - opening inv. + closing inv.

Number of periods

Avg. requirements = $(9000 - 700 + 100)/6 = 1400$ units/period

Steps:

1. Enter the production data
2. Determine hire/fire to get to production level desired
3. Update inventory levels
4. Does the inventory run out - If it does recalculate average production needed and go to step 1
5. Calculate totals for each category
6. Calculate costs

LEVEL STRATEGY

Period	1	2	3	4	5	6	Total
--------	---	---	---	---	---	---	-------

Req.	1000	1200	1500	1900	1800	1600	9000
Prod.							
Inv.(700)							
Hire							
Fire							
Sub.							

Costs:

1. Regular production costs:
2. Inventory carrying costs:
3. Hiring Costs:

CHASE STRATEGY

- Produce exactly what is required every period.
- Hire and fire to adjust monthly production to monthly requirements.
- The first and last period production levels are adjusted to account for opening inventory and closing inventory requirements.

Period	1	2	3	4	5	6	Total
Req.	1000	1200	1500	1900	1800	1600	9000
Prod.							
Inv.(700)							
Hire							
Fire							
Sub.							

Costs:

1. Regular production costs:
2. Inventory carrying costs:
3. Hiring Costs:
4. Firing Costs:

TOTAL COSTS: _____

Limitations of Aggregate Planning

Planners use economic models and forecasting research to organize a firm's life to respond to the inevitable changes of the broader economy. Production planning does this in response to changes in demand. Changing a company's production schedule on a moment's notice can be expensive and lead to insecurity and uncertainty. Planning for changes in demand months in advance ensures that the change of production schedules can occur with little effort. Aggregate production planning is a general approach to altering a company's production schedule to respond to forecasted changes in demand.

Resource Allocation

Aggregate production planning is really about the allocation of resources. Assuming that a plan is basically accurate, a production plan, usually stretching no more than a year into the future, will ensure the smooth transition of production capacity as demand changes over time. The significance of this is that once employees are habituated to these changes, they will alter their own schedules and work habits to reflect changes in demand. This means that costs of changing work schedules will be minimized, increasing efficiency.

Overproduction Risk

This kind of planning reduces the risk of overproduction. During periods of demand slump, overproduction can waste resources, depress prices and over saturate the market. It might also tax the ability of a firm to store and maintain the productions that have been produced with nowhere to go. Aggregate production planning reduces production at times of weak demand. This means that money will be saved when production is curtailed, since the firm will not have to pay for labor that, because of weak demand, has no purpose.

Data and Bias

Like with all plans, they are only as good as the people who make them. Planners often have biases, prejudices and habituation that derive from their experience and education. These, if unchecked, can lead to a plan that misreads economic indicators or relies on faulty data like economic forecasting models. A production plan cannot take shocks into consideration, such as a spike in oil prices, Federal Reserve policies, interest rate hikes or changes in consumer confidence. As the name suggests, these plans can only deal with "aggregates" or averages that are only a partially successful tool to predict fluctuations in demand.

Labor and Uncertainty

Labor remains one of the most serious problems of aggregate production planning. For example, a company plans to increase overtime hours and hire part-time workers for peak demand seasons. It will then cut hours and give unpaid furloughs during poor demand seasons. This implies that workers, especially long-term ones, will become increasingly dissatisfied and cynical about company policy and will not work up to capacity. Even more, well-qualified workers will choose other companies because of the constant insecurity of such a production policy. As most aggregate models forecast alternations in labor conditions, this can cause problems among full-time workers. It introduces insecurities and uncertainty into the workplace.

Summary

Aggregate planning is an "intermediate-range capacity planning technique, usually covering a time frame of 2-12 months for a production process, in order to keep the costs of operations at a minimum." Companies use aggregate planning to help make decisions about their capacity because seasonal variations in demand are difficult to predict accurately. The main goal of the company is to match resources with the expected demand. This goal is achieved by taking into account a diverse amount of factors such as: decisions on output rates, overtime, employment levels and changes, inventory levels and changes, back orders, and subcontracting work.

A more extensive form of aggregate planning is sales and operations planning. *Sales and operations planning* are "intermediate-range decisions to balance supply and demand, integrating financial and operations planning". Sales and operations planning decisions are made using demand forecasts, financial limits, and organization's capacity constraints. The sales and operations plan carries information that impacts the supply chain.

Self-Assessment Questions

- 1) Which of the following is a computerized model that can be tested under different scenarios to identify acceptable solutions?
 - a. test model
 - b. difference model
 - c. simulation model

- d. changing model
- e. growth model

The answer is C.

2) Which of the following is **not** included in a planning sequence for aggregate planning?

- A. business plan
- b. aggregate plan
- c. master schedule
- d. master plan
- e. the entire above are included

The answer is E.

3) What are the three most significant factors an organization has to consider when choosing a start:

- a. labor, demand, and time
- b. company policy, flexibility, and costs
- c. labor, time, and costs
- d. company policy, flexibility, and demand
- e. flexibility, time, and costs

The answer is B.

4) What are the key issue(s) in aggregate planning?

- a. how to handle variations in demand
- b. how to handle changes
- c. how to manage cost**
- d. both a & b
- e. none of the above

the answer is C.

5) what are the three types of aggregate planning?

- a. long-range plans, intermediate plans, and short-range plans.
- b. Long term demand, short term demand, economies of scale
- c. minimization curves, inflections points in cost schedules, profit maximization
- d. pricing models, statistical evaluation, tax shelter
- e. freight costs, J-I-T delivery, logistics

The answer is A.

- 6) Which of the following are examples of service organizations that use aggregate planning?
- a. airlines
 - b. hospitals
 - c. restaurants
 - d. A & B
 - e. all of the above

ANSWER: E

- 7) What are the three duties of master scheduling?
- a) Provide delivery dates for orders, deal with problems, and schedule aggregate plans
 - b) Evaluate the impact of new orders, provide delivery dates for orders, and deal with problems
 - c) Schedule aggregate plans evaluate impact of new orders; deal with problems of previous orders
 - d) Evaluate the impact of old orders, provide delivery dates for new orders, and disaggregate plans
 - e) Deal with new and old problems, evaluate the impact of production, and provide delivery dates for new orders.

Answer: B

- 8) What are the differences between manufacturing and services for aggregate planning?
- a. Demand for service can be difficult to predict
 - b. Capacity availability
 - c. Labor flexibility
 - d. Services occur when they are rendered
 - e. All of above

Answer is E.

- 9) Which of the following are Demand Options?
- a) Pricing
 - b) Promotion
 - c) Using back orders
 - d) Creating new demand

e) all of the above

Answer: E

10) Which of the following is NOT a supply option?

a) Hire and lay off workers

b) Overtime/slack time

c) Subcontractors

d) Promotion

e) All of the above ARE supply options

Answer: D

Key Terms

Smoothing: refers to costs that result from changing production and workforce levels from one period to the next.

Bottleneck Problems: It is the inability of the system to respond to sudden changes in demand as a result of capacity restrictions.

Planning Horizon: The number of periods for which the demand is to be forecasted, and hence the number of periods for which workforce and inventory levels are to be determined, must be specified in advance.

Treatment of Demand: Aggregate planning methodology requires the assumption that demand is known with certainty. This is simultaneously a weakness and a strength of the approach.

References

Chopra, Sunil and Peter Meindl. *Supply Chain Management: Strategy, Planning, and Operation*. Upper Saddle River, NJ: Pearson Prentice Hall, 2004.

Dejonckheere, J., S.M. Disney, M. Lambrecht, and D.R. Towill. "The Dynamics of Aggregate Planning". *Production Planning & Control* 14, no. 6, (2003): 497–516.

Finch, Byron J. *Operations Now*. Boston: McGraw-Hill Irwin, 2004.

Hung, Rudy. "Annualized Hours and Aggregate Planning." *Production and Inventory Management Journal* 38, no. 4 (1997)

Iyer, Ananth V., Vinayak Deshpande, and Zhengping Wu. "A Postponement Model for Demand Management." *Management Science* 49, no. 8, (2003): 983–1002.

Stevenson, William J. *Production Operations Management*. Boston: McGraw-Hill Irwin, 2004.

Nahmias, Steven , "Production and Operation Analysis". New York, New York: McGraw-Hill Irwin, 2009

Schroeder, R.G, *Operations Management*. New York, New York: McGraw-Hill Irwin, 2007

UNIT IV SCHEDULING AND ROUTING

Structure

- Objectives
- Introduction
- Concept of Scheduling
- Scheduling Decisions
- Elements of Shop Floor Scheduling
- Operations Controlling
- Elements of Operations Control
- Summary
- Key Terms
- Self-Assessment question
- References

7.0 Objectives:

This chapter will help the students to understand the:

1. The use of scheduling in operations
2. Principles of scheduling
3. Various elements of shop floor scheduling
4. Operation control mechanism
5. Elements of operations control

Introduction

Operations (or production) are the process and activities for transforming resources into finished services and goods for customers. The operations function creates four kinds of

utility – time utility, place utility; possess utility, and form utility – to meet customer needs.

Performing a service is different from manufacturing a good in several key ways: the raw material for service production includes the people who are seeking the service. In addition, most services are intangible, customized, and cannot be stored. Because of these characteristics, service providers generally focus on the customer service, often acknowledging the customer as part of the operations process.

Operations planning for both goods and services involve the analysis of five key factors: *Capacity planning* requires determining how much of a product a firm must be able to produce. *Location planning* involves choosing among potential facility sites. *Layout planning* entails designing an effective, efficient facility. *Quality planning* ensures that products meet a firm's quality standards. *Methods planning* involve identifying specific production steps and methods for performing them.

What is an operation scheduling?

Scheduling is actually concerned with establishing both the timing and the use of resources within a firm. First, keeping in view the estimated future demand of the final product, aggregate planning is done for long time horizon usually for 1-3 years. In turn, this long term plan is broken down in master production schedules for shorter time period. Master production schedule is a document that comprises of the complete information about the quantity and time of different products to be produced. On the basis of this, demand for the raw material, components etc (known as secondary demand) are estimated under the material requirement planning system. Finally, very short term schedules are prepared which establish both the timing and the use of resources within a firm.

In fact, schedules are the operations plans which are executed at lowest (shop floor) level.

Thus, schedules ensure timely production and delivery of products and the availability of required quantity of resources when they are actually required without interrupting the production.

Similarly, operations control is also a mechanism which is exercised to ensure the continuous production as per the planned one. In case of any discrepancy, taking an immediate remedial action in order to produce defect free products on scheduled time

Concept of Scheduling:

As discussed above, the main purpose of preparing the operations schedule is to exercise the better control over the entire process. Schedules are of immense importance as far as timing and availability of adequate resources is concerned.

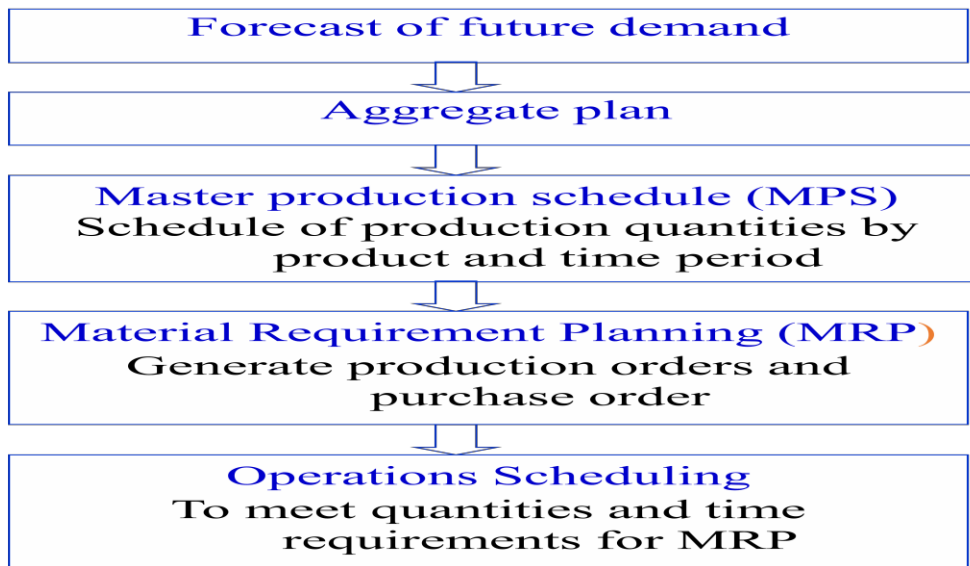

In the figure above, it is easy to understand the way aggregate plans are finally broken down into operations schedules at shop floor level. Some of the objectives of operations schedules have been summarized as below:

- Meet due date;
- Minimize *Work in Progress (WIP)* inventory;
- Minimize the average flow time through the systems;
- Provide for high machine/worker (time) utilization (minimize idle time);
- Reduce setup cost;
- Minimize production and worker costs;
- Consideration of due dates and avoiding delayed completion of job;
- Taking care of throughput time; to minimize the time a job spends in the system

Principles of Scheduling

Most of the time, scheduling is done in view of the principles:

- ✓ Schedule jobs in continuation;
- ✓ After starting a job, finish it;
- ✓ Focus on bottleneck;
- ✓ Real time feedback, real time adjustments;
- ✓ Knowledge of capacity of machines and workers;

- ✓ Continuous enhancement of product and process;

Approaches to Scheduling:

There are mainly two types of approaches which are commonly used:

1. *Forward scheduling:* in forward scheduling, the scheduler schedules all activities forward in time.
 - (a) Jobs are given earliest available time slot in operation;
 - (b) Usually excessive WIP results.
2. *Backward scheduling:* In backward scheduling, the scheduler begins with a planned date and moves backward in time.
 - (a) Start with due date and work backward through operations reviewing lead times;
 - (b) Less WIP but must have accurate lead time.

Scheduling Decisions:

Whenever, different types of products are produced using the same facility, complete changeover of the system is required. Changeover is the cost of changing a processing step in a production system from one job to another. Such cost corresponds to changing machine settings, getting job instructions, changing material and changing tools.

In case of changeover, one has to be very cautious in changing the schedules also. When there is any changeover in the organization, in addition to operations schedules, the components of production system that need to be changed are as followings:

- ❖ **INPUTS:** When there is a change over in a organization production system inputs are changed according to the production. Inputs include raw materials, components etc;
- ❖ **OUTPUT:** When inputs are changed so automatically outputs are also changed in the production system;
- ❖ **LOGISTICS:** logistics are also will be changed in the changeover of production system;
- ❖ **COST:** Cost is the main factor in change over. As cost may increase or decrease in the changeover of production system in the organization;
- ❖ **LABOUR:** Labour is also important factor as which labour will do which it has to be assigned;

- ❖ **TIME:** In changeover production system in an organization time factor matters the most. As it is not be same that first production done in a given time will be done as of same time in other production. The time may vary now.

Elements of Shop Floor Scheduling

As we know by the discussion so far, schedules are the operations plans which are executed at the lowest (shop floor) level. The classic approaches to shop floor scheduling focuses on the following elements:

- **Job arrival patterns: static or dynamic**
 - ◆ **Static:** jobs arrive in batch;
 - ◆ **Dynamic:** jobs arrive over time interval according to some statistical distribution.
 - **Numbers and variety of machines in the shop floor**
 - ◆ If there is only one machine or if a group of machines can be treated as one machine, the scheduling problem is much more simplified;
 - ◆ As number of variety of machines increase, the more complex the scheduling problems is likely to become.
 - **Ratio of workers to machines**
 - ◆ **Machine limited system:** more workers than machine or equal number workers and machines;
 - ◆ **Labor-limited system:** more machines than worker.
 - **Flow pattern of jobs: flow shop or job shop**
 - ◆ **Flow shop:** all jobs follow the same paths from one machine to the next;
 - ◆ **Job shop:** no similar pattern of movement of jobs from one machine to the next
- Job sequencing**
- ◆ **Sequencing or priority sequencing:** the process of determining which job is started first on some machines or work center by priority rule;
 - ◆ **Priority rule:** the rule used for obtaining a job sequencing;

- Priority rule evaluation criteria
 - ◆ To meet corresponding objectives of scheduling;
 - ◆ Common standard measures:
 - ◆ Meeting due date of customers or downstream operations;
 - ◆ Minimizing flow time (the time a job spends in the shop flow);
- Minimizing WIP;
- Minimizing idle time of machines and workers (Maximizing utilization).

Loading:

- Loading is concerned with assigning jobs to work centers and corresponding to various machines in the work centers.
- Approaches to Loading work centers
 - a) Infinite Loading: In infinite loading jobs are assigned to work centers without considering the capacity of the work centers
 - b) Finite Loading: Finite Loading estimates the actual start and stop time of each job at each work centers.

Sequencing:

Sequencing means determining the order in which jobs are processed. The order is also require for work processed at individual workstation. If work centers are heavily loaded and jobs are lengthy, the situation can become complicated. The order of processing is vital when it comes to the cost of waiting to be processed and the cost of ideal time at work centers.

Rules for Sequencing:

1. FCFS (*first come-first served*)

1. Jobs are processed in the sequence in which they entered the shop;
2. The simplest and nature way of sequencing as in queuing of a bank

2. SPT (*shortest processing time*)

1. Jobs are sequenced in increasing order of their processing time;
2. The job with shortest processing time is first, the one with the next shortest processing time is second, and so on;

3. EDD (*earliest due date*)

1. Jobs are sequenced in increasing order of their due dates;
2. The job with earliest due date is first, the one with the next earliest due date is second, and so on;

4. CR (*Critical ratio*)

1. Critical ratio is the remaining time until due date divided by processing time;
2. Scheduling the job with the smallest CR next;
3. CR provides the balance between SPT and EDD, such that the task with shorter remaining time and longer processing time takes higher priority;
4. CR will become smaller as the current time approaches due date, and more priority will be given to one with longer processing time;
5. For a job, if the numerator of its CR is negative (the job has been already later), it is naturally scheduled next;
6. If more than one jobs are later, higher priority is given to one that has shorter processing time (SPT).

5. Least work remaining (LWR)

It is an extension of SPT. It indicates that work be scheduled according to the processing time remaining before the job is considered to be complete.

6. Fewest operations remaining (FOR)

It is another form of SPT. It sequences jobs based on the number of successive operations remaining until the job is considered.

7. Slack time (ST)

Slack is determined by subtracting the sum of set-up and processing times from the time remaining until the job due date. Jobs are processed in order of the smallest amount of slack.

8. Slack time per operation (ST/O)

The slack time is divided by the number of operations remaining until the job is complete with the smallest values being scheduled first.

9. Next queue (NQ)

It depends on the machine utilization. It considers queues at each of the succeeding work centers at which the jobs will go.

10. Least set –up (LSU)

It maximizes utilization. Least set-up selects first the job minimizes changeover time on given machine.

Functions of Schedules:

The following functions must be performed in scheduling and controlling a shop floor:

- Allocating orders, equipment's, and personnel to work centers or other specified location-Short term capacity planning;
- Determining the sequence of orders (i. e. job priorities);
- Initializing performance of the scheduled work, commonly termed the dispatching of jobs;
- Shop-floor control, involving
 - Reviewing the status and controlling the progress of orders as they are being worked on;
 - Expediting the late and critical orders;
- Revising the schedules in light of changes in order status.

Operations Controlling

Operational controlling is used to regulate the internal processes necessary to monitor and direct of the company in the short term. It allows making decisions related to ongoing business operations. The main tasks of operational controlling include:

- Controlling of the results,
- Liquidity planning,

- Monitoring of profitability,
- Improving effectiveness of use of existing resources.

The process of operational controlling allows converting strategic plans in the operational plans. These plans must be tailored to specific units that make up the whole company. The whole process takes often place in the so-called "budgeting process".

Operational control normally takes the form of budgetary control, and is performed by comparing the short-term performance of organizational units with those established in the budget. Then managers analyze the deviations of actual values from the values set in goals for specific unit and the whole company.

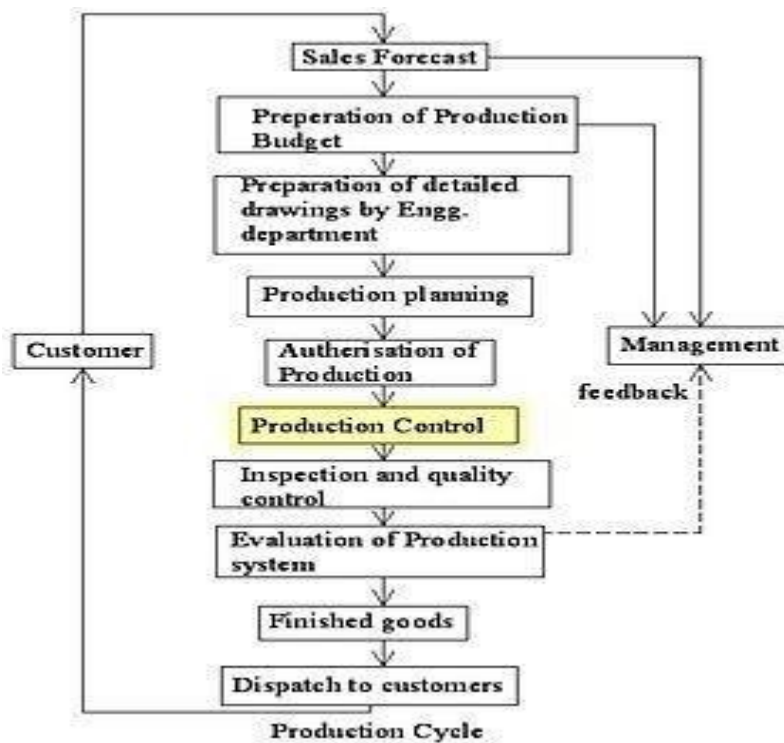

In the figure as above, production/ operation control mechanism is self explanatory. The whole system is mainly divided into three elements:

- Internal reporting system;
- Budgetary control;
- Operational planning (budgeting).

It is easy to see in the figure that there are three stages in production control function:

- PLANNING STAGE:** This stage deals with the activities such as product planning, forecasting of the demand on the basis of past trends;

- b) **ACTION STAGE:** It is concerned with the real implementation of the plan. It begins with the dispatching function, which deals with the progress of the work or job;
- c) **MONITORING STAGE:** In this stage, the planned activities are controlled and monitored by using various techniques such as inventory control, tool control, cost control, quality control. Reporting helps in controlling the whole process.

Characteristics of Control System:

Some important characteristics of control system may be mentioned as hereunder:

- Control is a continuous process
- Control is a management process
- Control is embedded in each level of organizational hierarchy
- Control is forward looking
- Control is closely linked with planning
- Control is a tool for achieving organizational activities
- Control is an end process
- Control compares actual performance with planned performance*
- Control point out the error in the execution process
- Control helps in minimizing cost
- Control helps in achieving standard
- Control saves the time

Elements of Operations Control

As we have already discussed in chapter one that production plans are prepared in advance at top level whereas, production control is exercised at machine shop floor (bottom level) where actual production is taking place. Some important elements of PPC have been depicted in the figure as below:

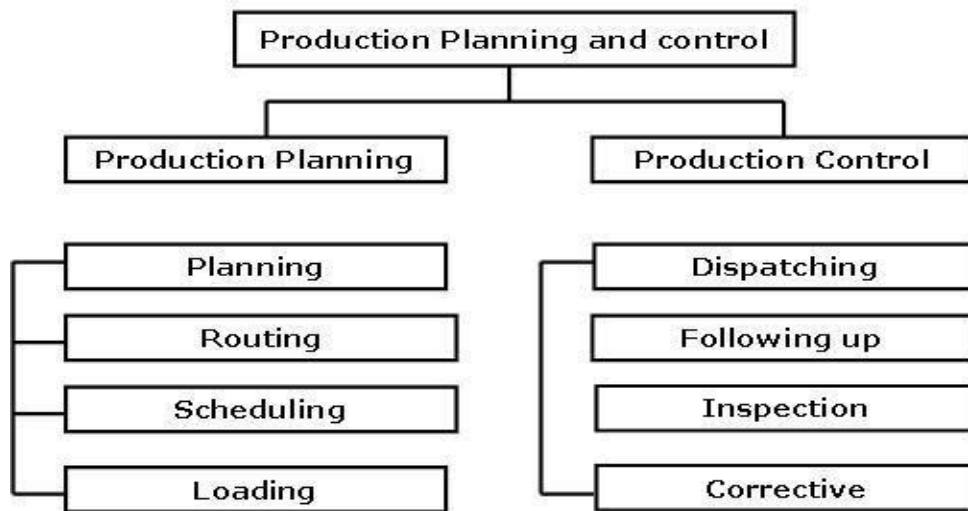

The important elements may be listed as following:

1. **Materials:** planning for procurement of raw material, component and spare parts in the right quantities and specifications at the right time from the right source at the right place. Purchasing, storage, inventory control, standardization, variety reduction, value analysis and inspection are the other activities associated with material.
2. **Method:** choosing the best method of processing form several alternatives. It also includes determining the best sequence of operations (process plan) and planning for tooling, jigs and fixtures etc.
3. **Machines and equipment:** manufacturing methods are related to production facilities available in production systems. It involves facilities planning, capacity planning, allocations, and utilization of plant and equipment, machines etc.
4. **Manpower:** planning for manpower (labour and managerial levels) having appropriate skills and expertise.
5. **Routing;** determining the flow of work material handling in the plant, and sequence of operations or processing steps. This is related to consideration of appropriate shop layout plant layout, temporary storage location for raw materials, component and semi-finished goods, and of materials handling system.

Route Sheet: a route sheet is a document providing information and instructions for converting the raw material in finished part or product. It defines each step of the production operations and lay down the precise path or route through which the product will flow during the conversion process. Route sheet contains following information:

- a) The operation required at their desired sequence
- b) Machines or equipment to be used for each operations
- c) Estimated set-up time and operation time per piece
- d) Tools, jigs, and fixtures required for operations
- e) Detailed drawings of the part, sub-assemblies and final assemblies
- f) Specification, dimensions, tolerances, surface finishes and quality standard to be achieved
- g) Specification of raw material to be used
- h) Speed, feed etc. to be used in machines tools for operations to be carried on.
- i) Inspection procedure and metrology tools required for inspection
- j) Packing and handling instructions during movement of parts and subassemblies through the operation stages.

6. **Estimating:** Establishing operation times leading to fixations of performance standards both for worker and machines. Estimating involves deciding the quantity of the product which needs to be produced and cost involved in it on the basis of sale forecast.

Estimating manpower, machine capacity and material required meeting the planned production targets are like the key activities before budgeting for resources.

7. **Loading:** machine loading is the process of converting operation schedule into practices in conjunctions with routing. Machine loading is the process assigning specific jobs to machines, men, or work centers based on relative priorities and capacity utilization. Loading ensures maximum possible utilization of productive facilities and avoid bottleneck in production. It's important to either overloading or under loading the facilities, work centers or machines to ensure maximum utilization of resources.

8. **Scheduling:** scheduling ensure that parts and sub-assemblies and finished goods are completed as per required delivery dates. It provides a timetable for manufacturing activities.

Purpose of scheduling:

- a) To prevent unbalance use of time among work and centers and department.

- b) To utilize labour such a way that output is produced within established lead time or cycle time so as to deliver the products on time and complete production in minimum total cost.
9. **Dispatching:** This is concerned with the execution of the planning functions. It gives necessary authority to start a particular work which has already planned under routing and scheduling functions. Dispatching is release of orders and instructions for starting of production in accordance with routing sheet and scheduling charts.
 10. **Inspection:** This function is related to maintenance of quality in production and of evaluating the efficiency of the processes, methods and labours so that improvement can be made to achieve the quality standard set by product design.
 11. **Evaluating:** The objective of evaluating is to improve performance. Performance of machines, processes and labour is evaluated to improve the same.
 12. **Cost control:** Manufacturing cost is controlled by wastage reduction, value analysis, inventory control and efficient utilization of all resources.

Requirements for an effective Operations Control System:

In an organization, control based operations system can be effective only if the following aspects are given due considerations before implementation:

- a) Appropriate organization structure with sufficient delegation of authority and responsibility at various levels of manpower.
- b) Right person should be deputed at right place for right job.
- c) Maximum level of standardization of inventory, tooling, manpower, job, workmanship, equipment, etc.
- d) Appropriate management decision for production schedule, materials controls, inventory and manpower turnover and product mix.
- e) Flexible production system to adjust any changes in demand, any problem in production or availability of materials maintenance requirements, etc
- f) Estimation of accurate leads times for both manufacturing and purchase.
- g) Management information system should be reliable, efficient and supporting.
- h) Capacity to produce should be sufficient to meet the demand.

- i) The facility should be responsive enough to produce new products change of products mix and be able to change the production rates.

The above elements are very important and necessary to make the production planning system effective and efficient.

Utility of Operational Controlling System:

The implementation of control based operation system yields various advantages to any organization for various functional activities, which include the following:

- a) **Last hour rush is avoided:** Production is well planned and controlled as per the given time schedules. Therefore, production control reduces the number of emergency order and overtime works on plant and thus reduces the overheads.
- b) **Problems areas of bottleneck get reduced:** The incomplete work or work-in-transit does not get piled up because production control balances the line and flow of work.
- c) **Cost reduction:** An appropriate production control increases the men-machines utilization, which maintains in process inventories at a satisfactory level, leads to a better control on raw material inventories, reduces costs of storage and materials handling, helps in maintaining quality and limits rejections and thus ultimately reduces the unit cost of production.
- d) **Optimum utilization of resources:** It reduces the time loss of the workers waiting for materials and makes most effective use of equipment.
- e) **Better coordination of plants activities:** PPC coordinates the activities of the plant that leads to control concerted effort by workforce.
- f) **Benefits to workers:** PPC results into better efficiency and productivity, which leads to adequate wages stable employment, job security, improved working conditions increased job satisfaction and ultimately high morale.
- g) **Improved services to customers:** PPC leads to better services to the customers as it ensures production in accordance with the time schedules and therefore, deliveries are made as per the committed schedules.

Scope of Operational Controlling System:

- a) *Nature of Inputs:* To manufacture a product, different types of inputs are used. The quality of the product depends upon the nature of the inputs are used. Hence the

planning is done to determine the nature of various types of inputs which is a complicated process.

- b) *Quantity of Inputs:* To achieve a level of production, determination of quantity of the inputs and their composition is very important. A product can be prepared only when there is an estimate of the required composition of inputs.
- c) *Proper Coordination:* It ensures the proper coordination among the workforce, machines and equipment. This leads to avoidance of wastages and smooth flow of production.
- d) *Better Control:* Production planning is the method of control. For a better control, planning is a precondition. Only then, one can compare the performance and calculate the deviations which lead control of the production.
- e) *Ensure Uninterrupted Production:* The planning of materials ensures the regular supply of raw materials and other components. The regular flow of materials and supplies are helpful in the uninterrupted production.
- f) *Capacity Utilization:* There is a need to use the available resources effectively. It is helpful in bringing down various costs of production.
- g) *Timely Delivered:* If there is good production planning and control, there will be timely production and the finished product will be rushed to the market in time. This also ensures the better relationship with the customers.

Design of Operational controlling system:

The complete design process has been explained in brief as follows:

- ◆ Determination of the time, scope and field of controlling;
- ◆ Preparation - setting goals and plans;
- ◆ Selection of parameters, measures and indicators;
- ◆ Providing proper information sources across organization;
- ◆ Determining the procedure for monitoring deviations;
- ◆ Establishing rules for decision-making process;
- ◆ A decision on the implementation of the system;
- ◆ Determination of the detailed time schedule and financial resources needed for implementation;

Operational controlling provides broad source of the information necessary to control main economic processes. This information pertains primarily of present business, performance and resource utilization. Operational controlling is closely linked and integrated with strategic controlling.

Summary

Operations function in a manufacturing or service organization is concerned with the transformation of some inputs into some outputs that have some value for the end users. In manufacturing organizations, there are many types of production systems namely mass, process, batch and job production systems. The selection of system depends upon mainly two things: i) nature of the product, ii) type of manufacturing process.

Scheduling is the final planning that occurs before the actual execution of the plan. Production planners track the performance of operations in meeting the planned schedule. This is critical because the master scheduler evaluates production planners on the level of customer service achieved for their product responsibilities.

- ✓ Schedules are essential to shop floor supervisors. The amount of time to complete a job is often determined by a time standard. If the time standards are inaccurate (either too stringent or too loose), the worker's morale may be affected.
- ✓ Customers often need to know when the service will be provided (cable installers) so that the customer is available. Customers often link quality of service with adherence to the schedule (if the company delivers on time, everything is fine).
- ✓ Scheduling executes a company's strategic business plan and affects functional areas throughout the company
- ✓ Accounting relies on schedule information and completion of customer orders to develop revenue projections
- ✓ Marketing uses schedule effectiveness measurement to determine whether the company is using lead times for competitive advantage
- ✓ Information systems maintains the scheduling database
- ✓ Operations uses the schedule to maintain its priorities and to provide customer service by finishing jobs on time

Different kinds of environments need different scheduling techniques. Scheduling in the high-volume environment is typically done through line design and balancing. Scheduling in a low-volume environment typically involves the use of priority rules.

- Shop loading techniques included infinite or finite loading. Finite loading loads jobs up to a predetermined capacity level. Loading can be done using forward or backward scheduling
- Priority rules are used to make scheduling decisions. SPT always minimizes mean job flow times, mean job lateness, and average number of jobs in system. Rules related to due dates tend to minimize the maximum tardiness of the jobs.

Operations control is a mechanism to monitor the execution of the plans. It has several important functions:

- a) Making sure that all activities are started at planned places and planned times.
- b) Observing progress of the operations and recording it properly.
- c) Analyzing the recorded data with the plans and measuring the deviations.
- d) Taking immediate corrective actions to minimize the negative impact of deviations from the plans.
- e) Feeding back the recorded information to the planning section in order to improve future plans.

Key Terms:

- **Scheduling:** is the timetable for various activities;
- **Estimating:** is a process of setting operation times after fixing standards both for worker and machines;
- **Loading:** is the process of converting operation schedule into practices;
- **Routing:** is the process of determining the flow of work material handling in the plant, and sequence of operations

Self-assessment Questions:

- a) Define scheduling. Discuss the objectives and principles of scheduling.
- b) Explain in detail the scheduling decisions.

- c) Discuss the elements of shop floor scheduling.
- d) Define operation control. Discuss the elements of operations control.
- e) Explain in detail the characteristics of an operational control mechanism.

References:

- a) Rama Murthy, P., *Production and Operations Management*, New Age International Publishers, 2005
- b) Chase, R.B., Aquilano, N.J., and Jacobs, F.R., *Production and Operations Management: Manufacturing and Services*, Richard D. Irwin, Inc., 1998.
- c) Narshimha, S.L., *Production Planning and Inventory Control*, PHI, 2002
- d) Garg, A.K., *Production and Operations Management*, Mc GrawHill, 2012
- e) Chary, S.N., *Operations Management*, TMH, 1996
- f) Baffa and Sarin, R., *Modern Production/ Operations Management*, John wiley and Sons, 2002

Just-in Time (JIT):

Just-in Time (JIT) production attempts to smooth the flow of materials from the suppliers to the customers, thereby, enhancing the speed of the manufacturing process. The main objective of JIT is to change the manufacturing system gradually rather than drastically.

Just-in-time (JIT) manufacturing/production is a production model in which items are created to meet demand, not created in surplus or in advance of need. The purpose of JIT production is to avoid the waste associated with overproduction, waiting and excess inventory, three of the seven categories defined in the Toyota Production System (known in North America as the lean production model). The JIT concept was described by Henry Ford in his 1923 book, *My Life and Work*.

The key principle of **lean operations** is relatively straightforward to understand: it means moving towards the elimination of all waste in order to develop an operation that is faster and more dependable, produces higher quality products and services and, above all, operates at low cost.’ The synonymous of lean operations may be viewed in the figure as below.

Synonyms

- continuous flow manufacture
- high value-added manufacture
- stockless production
- low-inventory production
- fast-throughput manufacturing
- lean manufacturing
- Toyota production system
- short cycle time manufacturing

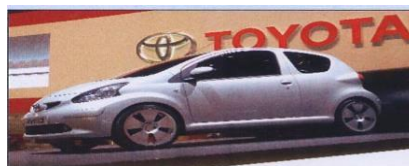

Source: Corbis/Denis Ballhouse



We also observe that in buying materials that it is not worthwhile to buy for other than immediate needs. We buy only enough to fit into the plan of production, taking into consideration the state of transportation at the time. If transportation were perfect and an even flow of materials could be assured, it would not be necessary to carry any stock

whatsoever. The carloads of raw materials would arrive on schedule and in the planned order and amounts, and go from the railway cars into production. That would save a great deal of money, for it would give a very rapid turnover and thus decrease the amount of money tied up in materials.

According to fuller, “JIT is a disciplined approach to improving overall productivity and eliminating waste. It provides for the cost –effective production and delivery of only the necessary quantity of parts at the right quality, at the right time and place, while using a minimum amount of facilities equipment, materials and human resources”. JIT is dependent on the balance between the supplier’s flexibility and the user’s flexibility. It is accomplished through the application of elements which require total employees involvement and teamwork. A key philosophy of JIT is simplification.

It is worthy to note here, that the first definition is a statement of aims. JIT will not achieve these aims immediately. Rather, it describes a state that a JIT approach helps to work towards. No definition of JIT fully conveys its full implications for operations practice, however. This is why so many different phrases and terms exist to describe JIT-type approaches? For example:

- Lean operations.
- Continuous flow manufacture.
- High value-added manufacture.
- Stock less production.
- War on waste.
- Fast- throughput manufacturing.
- Short cycle time manufacturing.

In this chapter, we will try to examine JIT both as a philosophy and as method of operations planning and control. This means that, for much of the chapter, we will take a relatively focused view of JIT, concentrating on its planning and control aspects although in practice it has much wider implications for improving operations performance. The JIT principles, which were a radical departure from traditional operations practice, have now they become the accepted wisdom in operations management. In effect, the chapter addresses the question:

‘What is JIT, and how does it impact on operations planning and control?’

‘What are the implication of arranging for the delivery of goods (and sometimes services), literally, ‘just in time’ for them to be used by their internal or external customer?’

Concept of JIT

Just in time (JIT) is an inventory strategy companies employ to increase efficiency and decrease waste by receiving goods only as they are needed in the production process, thereby reducing inventory costs. This method requires that producers are able to accurately forecast demand.

Cost-effective production and delivery of only the necessary quantity of parts of the right quality, at the right time and place, while, using a minimum amount of facilities, equipment, materials and human resources. It is easy to understand from the figure as below that in JIT system, orders and deliveries take place simultaneously. There is no need to maintain the buffer inventories at any stage.

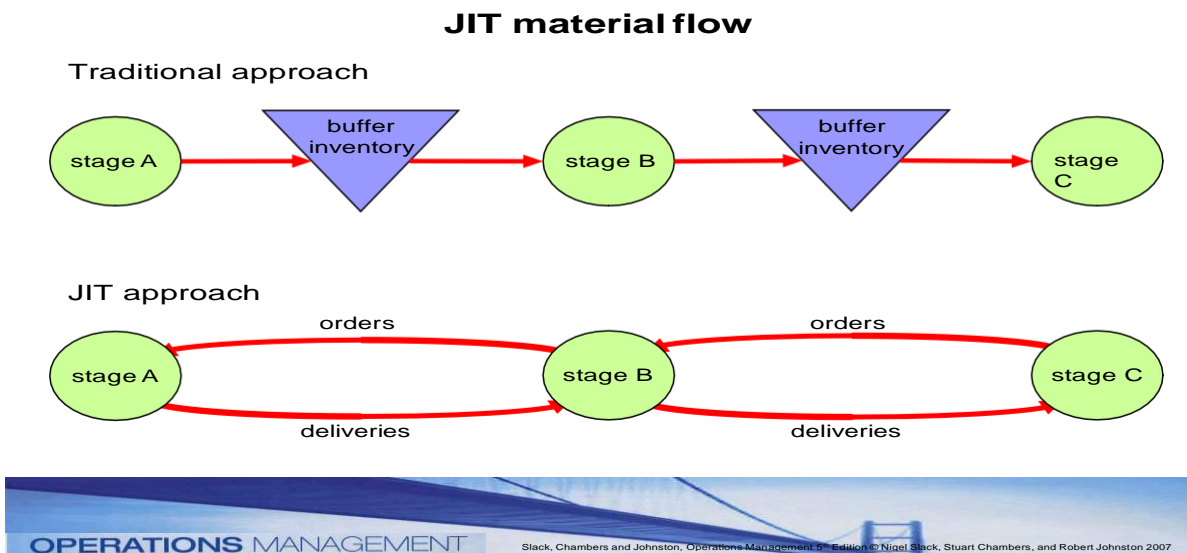

A good example would be a car manufacturer that operates with very low inventory levels, relying on their supply chain to deliver the parts they need to build cars. The parts needed to manufacture the cars do not arrive before nor after they are needed, rather, do they

arrive just as they are needed. This inventory supply system represents a shift away from the older "just in case" strategy where producers carried large inventories in case higher demand had to be met.

The operations planning and control system is an information system running throughout the manufacturing environment. Although there is a common system framework, systems run in different ways in different environments. For example, dedicated special facilities are used in make-to-stock environments; general purpose machines are used in make-to-order environments. Dedicated production lines can be designed in a balanced way with minimal setups in order to maximize the flow rate of the materials, while a general purpose machine must be set up before producing a specific item. In setup operations, the material flow is interrupted.

Manufacturing environments can be changed to make planning and control systems simpler and more effective. For example, products are designed to have high similarity in processing and are mixed in a dedicated production line with negligible setups. Since lead-times are shortened, this turns a make-to-stock product into a make-to-order product. Just-in-Time (JIT) is not only a control technique, but also a way to improve the manufacturing environment. JIT control systems are only effective in JIT environments. Introducing Kanban systems into a non-JIT environment means nothing to a company.

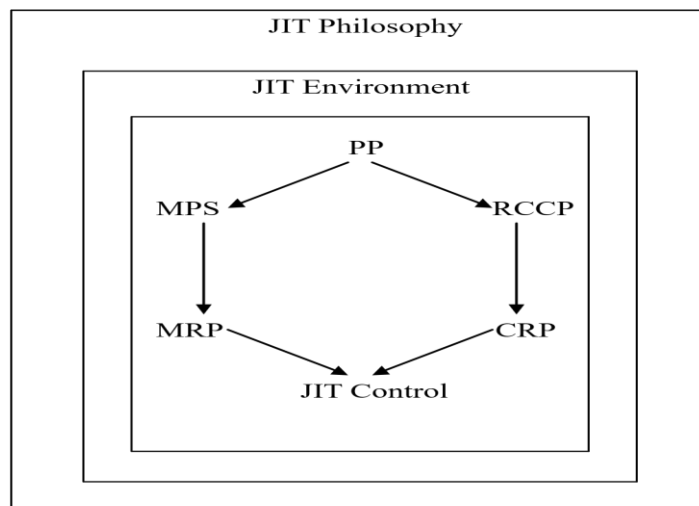

Figure 1: JIT Concept

JIT Control can be incorporated into an ERP system as a control part with a condition that the system has to be in a JIT environment. The JIT philosophy guides the development of the JIT environment. The JIT environment provides the foundation for implementing the JIT control techniques. The JIT philosophy, JIT environment, and the JIT technique can be expressed in Figure 1 as above.

JIT as a Philosophy and Environment

JIT as a Philosophy

a) **Elimination of waste:** Any activity that does not add value to the product or service in the eyes of the customer is a waste. Poor product design such as the inclusion of fancy functions not required by the customer is a waste. A product design causing difficulty in manufacturing is a waste. Standardization reduces the planning and control efforts, the number of parts, and the inventory required. A poor product design without enough standardization leads to waste. In addition to waste resulting from poor design, Toyota identifies seven examples of waste resulting from poor manufacturing methods.

b) **Waste of overproduction:** Overproduction is the production of goods more than what are immediately needed. Overproduction causes extra material handling, quality problems, and unnecessary inventories.

Consuming materials for unnecessary products may cause a shortage of material for other products that are needed. Never overproduce products to keep men and machines busy. If the required loading is less than the capacity, leave it alone. The labor can be switched to other departments, cleaning or maintaining machines, accepting training and education, etc.

c) **Waste of waiting:** A material waiting in queue is a waste. An operator waiting for material or instruction and having no productive work to do is a waste.

d) **Waste of movement:** Poor plant layout results in materials having to be moved extra distances and cause unnecessary material handling costs. Work centers should be close to each other in order to reduce the move distance. Someone may say that close

work centers provide no room for WIP inventories. That is fine! No room for WIP inventory forces the WIP to decrease.

- e) **Waste of inventories:** Inventory causes costs of interest, space, record keeping, and obsolescence. Moreover, inventory can mask problems which could cause more inventory buildup. For example, WIP inventory between work centers can hide the symptoms of an unbalanced production rate. Finished goods inventory can mask poor forecasting, poor quality, and poor production control. Inventory is not an asset; it is a waste!
- f) **Waste of motion:** Improper methods of performing tasks by the operators cause wasted motions. Reaching far for materials or machine buttons is a waste of motion. Searching for tools is a waste of motion. Any activity that does not add value to the products should be eliminated. Bad layout or training causes waste of motion.
- g) **Waste of making defects:** The cost of scraps is a waste. But it is the least important compared with other wastes caused by making defects. Defects interrupt the smooth flow of materials in the production line. If the scrap is not identified, next workstation will try using it to produce more wastes, or waste time waiting for good materials.
- h) **Waste of process itself:** Bad process design is a waste. For example, wrong type or size of machines, wrong tools, and wrong fixtures are wastes.

The principle of eliminating the wastes includes:

- a. All waste should be eliminated.
- b. Waste can gradually be eliminated by removing small amounts of inventory from the system, correcting the problems that ensue, and then, removing more inventory.
- c. The customers' definitions of quality should drive product design and manufacturing system.
- d. Manufacturing flexibility is essential to maintain high quality and low cost with an increasingly differentiated product line.
- e. Mutual respect and support should exist among an organization, its employees, its suppliers, and its customers.
- f. A team effort is required to achieve world class manufacturing capability.

- g. The employee who performs a task is the best source of suggested improvements.

Continuous improvement/One Less at a Time

As it has been mentioned earlier, JIT improves the manufacturing system gradually rather than drastically, as in business process re-engineering (BPR). This gradual continuous improvement is defined by APICS Dictionary as “one less at a time”: a process of gradually reducing the lot size of the number of items in the manufacturing pipeline to expose, prioritize, and eliminate waste. “One less at a time” is a constant, step-by-step methodology for making JIT work in any manufacturing environment. JIT is a never-ending series of small, controlled steps, not one great leap forward. In the JIT philosophy, not the same product is produced over and over again; instead, the same process is used repeatedly to produce different products.

The procedure of “one less at a time” is as follows:

- a) If the inventory is equal to zero then stop, else
- b) Select the most prioritized process to be improved.
- c) Improve the process
- d) Is the process economical? If no, go to step 3
- e) Reduce the inventory by a small amount
- f) Go to step 1.

The third step “Improve the process” in the above procedure can be broken down into following steps:

- ✓ Observe the existing method and collect related data on the selected process.
- ✓ Investigate and analyze the data to generate alternatives to improve the process.
- ✓ Evaluate the alternatives to determine the new method for the process.
- ✓ Install the new method and educate the operator.
- ✓ Maintain the new method.

The effects of “One inventory less” can be expressed as in the figure below. Reducing inventory forces the setup times to decrease for more frequently the products have to be produced to maintain lower inventory level. In order to have shorter setup times, processes must be designed to be more flexible and workers must be trained to do multiple jobs.

The need for shorter setup times also demands that the number of items be fewer. The number of items can be reduced through a design of more common parts and modules in different products. Shorter setup times lead to smaller lot sizes and shorter lead times. Shorter lead times result in more frequent product delivery and decrease the need for accurate forecasting and planning which increase the schedule stability.

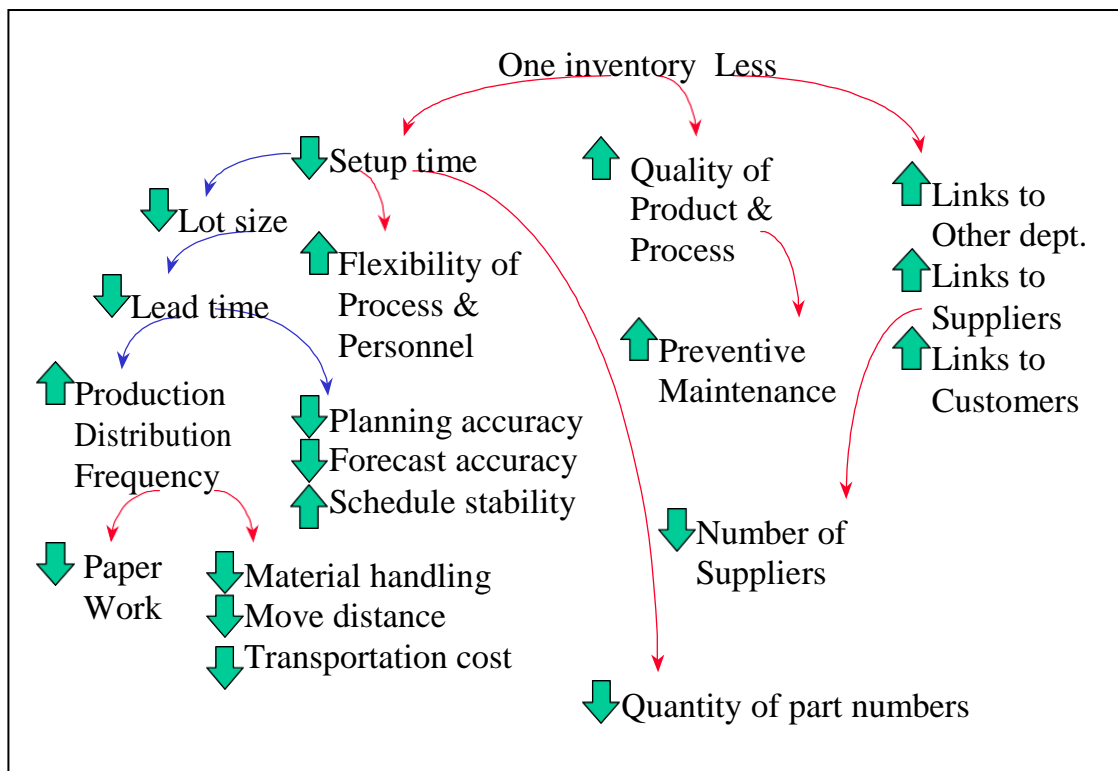

More frequent distribution forces people to reduce paper work and material move distance, and to develop more efficient material handling and transportation systems. Less inventory demands a higher quality level, zero defect process, and better preventive maintenance.

Fewer inventories also require better communication between departments, customers, and suppliers, and hence require a smaller number of suppliers.

(1) Problem as an opportunity:

JIT philosophy sees the problems as the opportunities. A problem is an opportunity to improve. JIT exposes problems rather than covering them.

(2) Quality at the source:

Defects may occur at the design stage, any workstation in the production line, or the suppliers' plants. Quality does not come from inspection. It does not come from manufacturing either. Quality comes from good design. The quality of a product is determined at the design stage, including product design and process design. A poor design will never result in good quality. In a production line, it is not adequate to inspect the products at the end the line. Inspections should be executed by the operators themselves at each step of the line before the parts are passed on to the following process. The operator in the next workstation has no obligation to inspect an incoming part. A defect must be screened out immediately after it occurs. For purchased parts, the inspection should be completed before delivery. Incoming inspection is not required.

(3) Simplification:

Simplicity is a key to successful manufacturing. Products should be designed to be easy to manufacture, install, and repair. Only 2 or 3 levels should exist in the bill of material. Suppliers deliver the materials regularly and purchase orders are not required. Materials are stored at the point of use (POU), and picking orders are not required. Work centers produce the items when they are consumed and shop orders are not required. Material inventory records are not updated until the finished goods are reported complete. Simplifying the system is central to the philosophy of JIT.

(4) Visual Control:

Visible control tools are used wherever possible. Cards attached to the materials, containers at sight, tags in stock indicating order points, etc. are examples of visual control tools. These signals are processed by human intelligence at the speed of light,

and are superior to any computer in the world. JIT philosophy reminds us that natural human senses are effective tools but are frequently ignored.

(5) Focus on customer needs:

In JIT philosophy, only values in customers' eyes are real values. Values perceived by engineers but not accepted by customers are wastes. All activities from production design, material procurement, fabrication, assembly, distribution to after sale service; focus on customer needs. Any motion of the operator on the shop floor not adding value to customer needs is a waste.

(6) Production to customer demand:

In JIT philosophy, only immediate customer demands are produced. Extra items not required immediately by the customers are not put into production. Without customer demand, there should be no production.

(7) Respect for individuals:

Each individual in a company is an important asset. Education and training are frequently conducted to enhance the capability of the employees. Employee involvement and empowerment are part of JIT philosophies. Employee involvement is the concept of using the experience, creativity, and intelligence of all employees by treating them with respect, keeping them informed, and including them and their ideas in decision making processes (Apices, 1995). Employee empowerment is the practice of giving non-managerial employees the responsibility and power to make decisions that can affect their jobs or tasks. It allows employee to take responsibility for tasks normally associated with staff specialists, such as scheduling, inspection, etc. (Apices, 1995).

JIT as an Environment

In addition to philosophical concepts, JIT also provides an environment in which products are manufactured in a simpler way.

❖ **Repetitive manufacturing:**

Repetitive manufacturing is the production of discrete items in a production line with fixed routing. The items can be a product or a family of products. The product is

standard or made from standard modules. The manufacturing environment is make-to-order (MTO) or assemble-to-order (ATO). The production line consists of workstations located close together and in sequence. Materials flow from a workstation to the next at a relatively constant rate. Material handling systems are normally used to move the materials from process to process in the production line. Normally, the capacity of the production line is kept sufficient. The repetitive manufacturing is based on an uninterrupted flow of materials.

❖ **Total Quality Management:**

Total quality management is a management approach used to achieve quality improvement and long-term success through customer satisfaction. TQM involves all members of the organization, and is meant to improve the quality of all processes, products, services, operations, and corporate culture.



TQM activities follow a plan-do-check-action (PDCA) cycle to improve the quality.

In the “plan” step, the problem is defined, the symptoms are explained, and the key performance measures are determined. In the “do” step, the cause of the symptoms is identified. The causes of the causes are also investigated until the root cause is uncovered. Then, an approach to solve the problem is developed and implemented.

The performance measures can be changed in this step. In the “check” step, the effectiveness of the proposed approach is observed by using the performance measures. In the “action” step, the results are studied to determine what was learned and what can be predicted. The improvement process is standardized to apply to similar problems. In the PDCA cycle, the steps are not necessarily followed strictly

sequentially. For example, if we find a proposed approach is not affirmative in “check” step, we may jump to the “do” stage to revise the approach.

❖ **Total Productive Maintenance (TPM):**

“Preventive maintenance” is a restrictive term which mentally prohibits us from thinking more broadly. TPM means preventive maintenance *and* continuing efforts to adapt, modify, and refine equipment in order to increase flexibility, reduce material handling, and promote continuous flows. It is operator-oriented maintenance involving all qualified employees in all maintenance activities. (Apices, 1995)

❖ **Total employee Involvement (TEI):**

Elimination of waste and continuous improvement are the central ideas of the JIT philosophy. They can be accomplished only when employees are cooperative. A successful JIT environment should have the cooperation and involvement of everyone in the organization. Traditionally, operators take orders from management and do what they are asked to do, while management is in charge of planning, supervising, inspecting, etc. In a JIT environment, operators take responsibility for controlling the equipment, inspecting for quality, correcting the deviations, maintaining the machines, and improving the processes. Many of the tasks traditionally done by the management become the duties of the line workers under JIT. Managers are not playing the game; they are coaches and the line workers are the players. The mission of a coach is to train the players.

❖ **Supplier Partnership:**

In order to establish a smooth flow of materials into the factory, a close and reliable relationship with the suppliers is very important. Supplier partnership is the establishment of a working relationship with a supplier whereby the two organizations act as one. Relationships with the suppliers should be based on mutual trust, cooperation, and long-term commitment.

JIT as a Control Technique:

After taking JIT as a philosophy and environment, now we will try to understand JIT as a control measure. In daily operations, JIT provides useful control methods. The

characteristics of a JIT control technique include uniform loading, repetitive processes, pull system, using production cards, and synchronized production.

➤ **Pull System:**

JIT control pulls materials from the previous workstation. The workstation replenishes any materials consumed by its following workstation. Since only the consumed materials are produced, the inventories between workstations never accumulate. For the first workstation of the factory, the supplier is its preceding workstation. For the last workstation in a factory, the customer is its following workstation. Customers pull the products from the factory, and factory pulls the materials from the suppliers.

➤ **Uniform Loading:**

The loads for jobs in every workstation are equal. This makes the pull system possible. If uneven loading exists, the following workstation may have to wait for the materials from the preceding workstation. Uniform loading allows the materials to flow through the production line smoothly. Every workstation runs at a constant rate. If the demand increases, the production rates in all workstation increase together. If the demand drops, all workstations may have the same level of idleness.

➤ **Production Card:**

JIT control uses various cards to transmit production signals. During the production, these cards are attached to and detached from the materials. Production signals are transmitted from the following workstation back to the preceding workstation. The cards have various shapes and colors to indicate different purposes. Sometimes material containers or the material itself are themselves the signals.

➤ **Synchronized Production:**

Synchronized production is a manufacturing practice in which production activities in each workstation are synchronized with certain control signals. The production rates of workstations are related to each other, and the work-in-process inventories are limited to a predetermined level. Synchronized production can be seen in JIT environments or theory-of-constraints (TOC) environments. The control signals are carried by Kanban's in a JIT environment. In the TOC environment, drum-buffer-(DBR) is used to synchronize the workstations.

Characteristics of JIT:

Some important characteristics of JIT have been summarized as follows:

- *Production organized into manufacturing work cells:* Each work cell produces a product or product type. Each worker in each cell knows how to operate all the machines in that cell and can perform supporting tasks within that cell. This reduces the downtime resulting from breakdowns employee absences.
- *Multi skilled workers:* Cross-functional training of workers so they can perform a variety of operations and tasks on an as-needed basis to maintain smooth production flow.
- *Reduced setup times:* Reduction of the time required to get tools, equipment, and materials ready for a production run.
- *Reduced manufacturing lead times:* Reduction of the time from when an order is initiated to when a finished good is produced.
- *Reliable suppliers:* Careful screening of suppliers to ensure on-time deliveries of high-quality goods for just-in-time use possibly within a day or less. Supplier's dependability is crucial in JIT system because inventory levels are kept low in a JIT system, the company must have a very close relationship with its suppliers to make certain that the supplier makes frequent deliveries of smaller amounts of Inventory thus long-term contracts are typically negotiated to reduce order costs.

Buyer-supplier relationships are further facilitated by electronic data interchange (EDI), a technology that allows the supplier access to the buyer's online inventory management system. Thus, electronic messages replace paper documents (purchase orders and sales invoices), and the production schedules and deliveries of the parties can be more readily coordinated.

Merits and Demerits of JIT:

Merits:

Companies like to use JIT as it is seen as a more cost efficient method of holding stock. Its purpose is to minimize the amount of goods you hold at any one time, and this has numerous advantages:

- **Less space needed:** With a faster turnaround of stock, you don't need as much warehouse or storage space to store goods. This reduces the amount of storage an organization needs to rent or buy, freeing up funds for other parts of the business.
- **Waste reduction:** A faster turnaround of stock prevents goods becoming damaged or obsolete while sitting in storage, reducing waste. This again saves money by preventing investment in unnecessary stock, and reducing the need to replace old stock.
- **Smaller investments:** JIT inventory management is ideal for smaller companies that don't have the funds available to purchase huge amounts of stock at once. Ordering stock as and when it's needed helps to maintain a healthy cash flow.

All of above advantages will save the company money.

Demerits:

JIT unfortunately comes with a number of potential disadvantages, which can have a significant impact on the company if they occur.

- **Risk of running out of stock:** By not carrying much stock, it is imperative you have the correct procedures in place to ensure stock can become readily available, and quickly. To do this, you need to have a good relationship with your supplier(s). You may need to form an exclusive agreement with suppliers that specifies supplying goods within a certain time frame, prioritizing your company. JIT means that you become extremely reliant on the consistency of your supply chain. What if your supplier struggles with your requirements, or goes out of business? Can you get the products quickly from somewhere else?
- **Lack of control over time frame:** Having to rely on the timeliness of suppliers for each order puts you at risk of delaying your customers' receipt of goods. If you don't

meet your customers' expectations, they could take their business elsewhere, which would have a huge impact on your business if this occurs often.

- **More planning required:** With JIT inventory management, it's imperative that companies understand their sales trends and variances in close detail. Most companies have seasonal sales periods, meaning a number of products will need a higher stock level at certain times of the year due to higher demand. Therefore, you need to factor that into planning for inventory levels, ensuring suppliers are able to meet different volume requirements at different times.

If run properly, JIT inventory management is seen as one of (if not the) best ways of managing inventory. While it is not without risks, it has significant rewards, and is ideal for those who are able to plan carefully in advance, and build strong relationships with suppliers.

The advantages and disadvantages are also shown in the table as below:

Advantages	Disadvantages
• can tie in customers/increase switching costs	• can be expensive to implement
• can improve customer loyalty and retention	• as a differentiation strategy it is easily copied
• can increase market visibility	• it relies on suppliers willingness to adapt to customer needs (often needs corresponding upstream management)
• provides better information on customer needs, tastes etc.	• the organisation might become reactive rather than proactive to customer needs
• product failure rates can be reduced	• forward integration can increase business risk and exit barriers
• can facilitate pull supply chain management	• must ensure that forum/website users are representative of all users
• more regular and better communication with customers (e.g. can provide software/product updates etc.)	• requires skills and experience for the benefits to be fully realised
• gives users a voice	• there is a risk of loss of focus on core competences and activities

Summary:

The nature and meaning of just-in-time (JIT), in any other setting may be reduced to four somewhat differently stated views.

- Many have suggested that JIT revolves around wastes: it is taken as a *waste-elimination* philosophy. It's all about 7 wastes, the wastes of: over-production, waiting, transportation, processing itself, stocks [inventories], motion, and making defective products.
- Others have equated JIT production with *kanban*.
- Some argue that JIT's main aim is *elimination of inventories*, although JIT is defined as 'NOT an inventory control system—but a way of thinking, working and

such inventory buffers by continually attacking causes of disruptions. Zero inventories are posed only as an unattainable ideal, one that is easy to see and count.

- The last view is that JIT is mainly about *quick response*. According to Blackburn, Quick response is one of the major benefits of JIT. Time or speed is the key of this manufacturing philosophy. Inventory, on the other hand, is an ancillary benefit. Quick response refers alternatively to reduction of cycle times; flow times, throughput times, and, all the way to the customer lead times. JIT has the provocative goal of producing instantaneously, with perfect quality and minimum waste. The ideal way to produce the end product is literally just in time to meet the market demand for it. Thus, JIT is primarily a lead-time reduction programme.

The four JIT views—referring to wastes, kanban, inventory, and quick response/lead-time reduction—do not suggest opposing views, but rather appear to be complementary points of emphasis, collectively serving to describe the essence of JIT.

Aside from the four viewpoints, Just in time has often been paired with total quality control, forming the acronym, JIT/TQC. The rationale is that TQC avoids stoppages and slowdowns disruptive to the quick-flow aims of JIT; and JIT exposes quality issues and their causes soon after they occur, thus facilitating their elimination.

Review Questions:

- Define the "Just-In-Time" concept.
- Is "Just-In-Time" a philosophy or just a collection of techniques? Explain your answer.
- Discuss the advantages and disadvantages of JIT approach.
- List and discuss some of the characteristics of JIT approach.
- ✓ What is JIT? How does it impact on operations planning and control?

Keywords

- ***Just-in-Time (JIT)***: denoting a manufacturing system in which materials or components are delivered immediately before they are required in order to minimize storage costs.

- **Material Requirements Planning (MRP):** is a computer-based production planning and inventory control system. MRP is concerned with both production scheduling and inventory control. It is a material control system that attempts to keep adequate inventory levels to assure that required materials are available when needed
- **Manufacturing resource planning (MRP II):** Manufacturing resource planning (MRP II) is defined as a method for the effective planning of all resources of a manufacturing company. Ideally, it addresses operational planning in units, financial planning, and has a simulation capability to answer "what-if" questions and extension of closed-loop MRP
- **Lean production:** Lean production is an assembly-line methodology developed originally for Toyota and the manufacturing of automobiles. It is also known as the Toyota Production System or just-in-time production.

References

- Ansari, A. and B. Modarress. 1990. *Just in Time Purchasing*. New York: Free Press.
- Ashburn, A., 1977. Toyota's "famous Ohno system." *American Machinist*, July, 120–123.
- Galsworth, G. 2005. *Visual Workplace: Visual Thinking*. Portland, Ore.: Visual-Lean Enterprise Press.
- Hirano, H. 1994. *Five Pillars of the Visual Workplace*. Cambridge, Mass.: Productivity Inc.
- Jordon, S., “Analysis and approximation of a JIT production line”, *Decision and science*, Summer 1988.
- Karatsu, H., *TQC Wisdom of Japan*, Productivity Press, Cambridge, MA, 1988.
- Lu, D. J., *Kanban Just In Time at Toyota*, Productivity Press, Cambridge, MA, 1988.
- Miltenburg, J., “Level schedules for mixed-model assembly lines in Just-In-Time production systems”, *Management Science*, February 1989

Plenert, G. 2007. *Reinventing Lean: Introducing Lean Management into the Supply Chain*.
Oxford, U.K.: Butterworth-Heinemann. pp 41–42.

Plenert, G. J., “Three different concepts of JIT”, *Production and Inventory Management*,
31(2), 1990

UNIT V

LINE BALANCING AND DISPATCHING

Introduction

By the time, we all have understood the meaning of production. Production may be understood as the step-by-step conversion of one form of material into another form through chemical and mechanical process to create or enhance the utility of the product to the user. Some examples of production are: manufacturing standardized products like cars, bus, motorcycle, radio, TV etc.

Production system is actually a combination of various methods, procedures, arrangements and different functions that are required to accumulate (gather) the inputs, process or reprocess the inputs and deliver the marketable output (goods). Production system utilizes materials, funds, infrastructure and labour to produce the required output inform of goods.

There are different types of production processes. The selection of production process mainly depends upon the variety of the products to be produced, volume of production and degree of flexibility required.

Process Selection



In the figure as above, one can see different types of production processes. These processes may be mentioned as hereunder:

- a) Job shop
 - For small scale production
- b) Batch
 - For moderate volume
- c) Repetitive/assembly line
 - For high volumes of standardized goods or services
- d) Continuous
 - For very high volumes of non-discrete goods

In this chapter, the main focus is on the production of high volumes of standardized goods. For such types of goods, mainly mass/ continuous production system is used.

This chapter also deals with production planning and control aspects for the mass/continuous production system in detail. The most important aspect of continuous (which is also known as assembly line production) production is the balancing of assembly line. This will be discussed in much detail with suitable examples.

An Overview of Different Types of Production Systems:

Once the process decision is taken, next is type of production system. Depending upon the process, production systems may be categorized as shown in the diagramme below.

Types of Manufacturing/Production Systems:

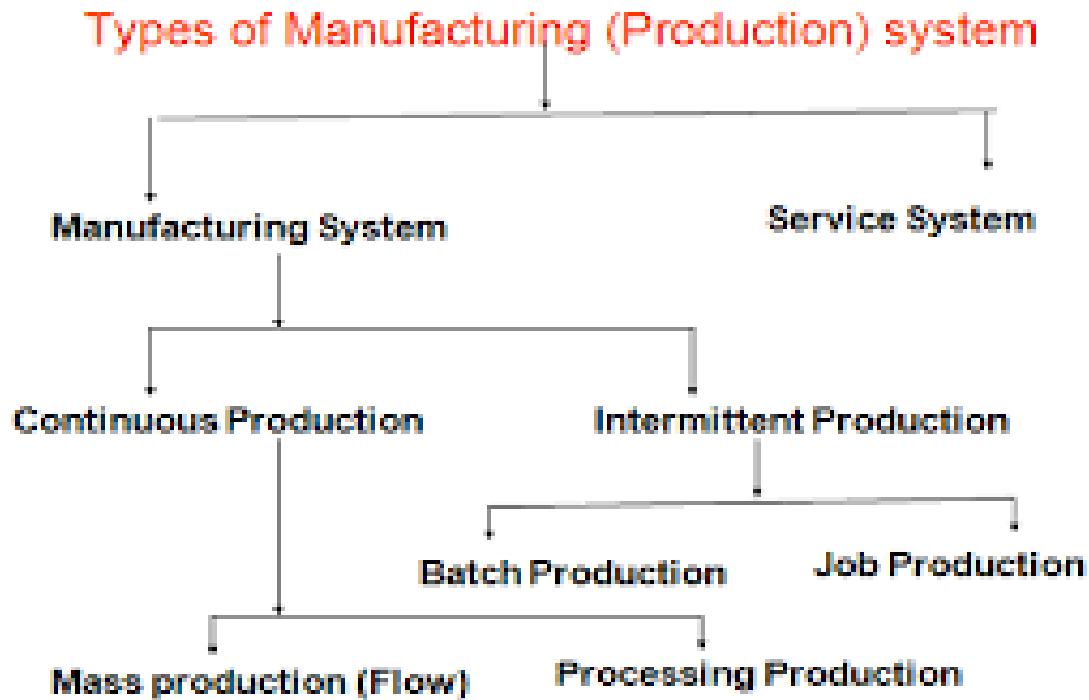

In order to develop a better understanding, each type of production system has been discussed along with its characteristics, merits and limitations.

Job Shop Production:

- Job shop production are characterized by manufacturing of one or few quantity of products designed and produced as per the specification of customers within prefixed time and cost.
- The distinguishing feature of this is low volume and high variety of products.
- A job shop comprises of general purpose machines arranged into different departments.
- Each job demands unique technological requirements, demands processing on machines in a certain sequence.

Characteristics

The Job-shop production system is followed when there is:

- High variety of products and low volume.
- Use of general purpose machines and facilities.
- Highly skilled operators who can take up each job as a challenge because of uniqueness.
- Large inventory of materials, tools, parts.

- Detailed planning is essential for sequencing the requirements of each product, capacities for each work centre and order priorities.

Advantages

Following are the advantages of job shop production:

- Because of general purpose machines and facilities variety of products can be produced.
- Operators will become more skilled and competent, as each job gives them learning opportunities.
- Full potential of operators can be utilised.
- Opportunity exists for creative methods and innovative ideas.

Limitations

Following are the limitations of job shop production:

- Higher cost due to frequent set up changes.
- Higher level of inventory at all levels and hence higher inventory cost.
- Production planning is complicated.
- Larger space requirements.

Batch Production:

Batch production is defined by American Production and Inventory Control Society (APICS) “*as a form of manufacturing in which the job passes through the functional departments in lots or batches and each lot may have a different routing.*” It is characterized by the manufacture of limited number of products produced at regular intervals and stocked awaiting sales.

Characteristics

Batch production system is used under the following circumstances:

- When there is shorter production runs.
- When plant and machinery are flexible.
- When plant and machinery set up is used for the production of item in a batch and change of set up is required for processing the next batch.
- When manufacturing lead time and cost are lower as compared to job order production.

Advantages

Following are the advantages of batch production:

- Better utilization of plant and machinery.
- Promotes functional specialization.
- Cost per unit is lower as compared to job order production.
- Lower investment in plant and machinery.
- Flexibility to accommodate and process number of products.
- Job satisfaction exists for operators.

Limitations

Following are the limitations of batch production:

- Material handling is complex because of irregular and longer flows.
- Production planning and control is complex.
- Work in process inventory is higher compared to continuous production.
- Higher set up costs due to frequent changes in set up.

Continuous Production:

Production facilities are arranged as per the sequence of production operations from the first operations to the finished product. The items are made to flow through the sequence of operations through material handling devices such as conveyors, transfer devices, etc.

Characteristics

Continuous production is used under the following circumstances:

- Dedicated plant and equipment with zero flexibility.
- Material handling is fully automated.
- Process follows a predetermined sequence of operations.
- Component materials cannot be readily identified with final product.
- Planning and scheduling is a routine action.

Advantages

Following are the advantages of continuous production:

- Standardization of product and process sequence.
- Higher rate of production with reduced cycle time.
- Higher capacity utilization due to line balancing.
- Manpower is not required for material handling as it is completely automatic.
- Person with limited skills can be used on the production line.
- Unit cost is lower due to high volume of production.

Limitations

Following are the limitations of continuous production:

- Flexibility to accommodate and process number of products does not exist.
- Very high investment for setting flow lines.
- Product differentiation is limited

Mass Production:

Henry ford designed his first moving assembly line. In 1913, and revolutionized the manufacturing processes. It was Henry's intention to produce largest no. of cars, to the simplest design, for the lowest possible cost. The assembly line became the benchmark for mass production methods around the world.

Mass Production is the name given to the method of producing goods in large quantities at low cost per unit. But mass production, although allowing lower prices, does not have to mean low quality production. Instead mass produced goods are standardized by means of precision manufactured, interchangeable parts.

Machine tools and interchangeable parts the material basis for mass production was laid by the development of the machine tool industry that is, the making of machines to make machines.

The assembly line is an arrangement of machines, tools and workers in which a product is assembled by having each perform a specific, successive operation on an incomplete unit as it passes by in a series of stages organized in a direct line.

Example of Mass Production systems:

Production of biscuits in a factory can be taken as an example of mass production. At every stage a particular operation is performed using a specific machine. As is shown below, packs of identical biscuits are produced in an industrial unit

Stage: 1: MIXING: Flour + fat + sugar + bicarbonate + additives

Stage: 2: MOULDING: Dough is laminated in a laminator

Stage: 3: GAUZE ROLLS: Laminated dough is cut as per size and shape

Stage: 4: BAKING: Biscuits cut into shapes are baked in the oven

Stage: 5: COOLING: Biscuits are cooled in conveyors once they are baked

Stage: 6: PACKAGING: The final product is then packed into pouches and cartons

Characteristics

- Achieve economies of scale by producing in very large quantity
- Standardizing products
- Developing efficient processes
- Producing more of each product at one time
- Selling at lower price

Advantages

- Higher rate of production with reduced cycle time.
- Higher capacity utilization due to line balancing.
- Less skilled operators are required.
- Low process inventory.
- Manufacturing cost per unit is low.
- Reducing direct labour cost
- Accuracy in product design and quality

Limitations

- Breakdown of one machine will stop an entire production line.
- Line layout needs major change with the changes in the product design.
- High investment in production facilities.
- The cycle time is determined by the slowest operation.

Concept of Standardization

Standardization means producing maximum variety of products from the minimum variety of materials, parts, tools and processes. It is the process of establishing standards or units of measure by which extent, quality, quantity, value, performance etc., may be compared and measured.

Factors encouraging standardization are:

- ✓ Economies of scale in production and marketing
- ✓ Consumer mobility - the more consumers travel the more is the demand
- ✓ Technology
- ✓ Image, for example "Japanese", "made in".

Advantages of Standardization to various departments in the company:

Benefits to Manufacturing Department:

- Lower unit cost.
- Better quality products.
- Better methods and tooling.

- Increased interchangeability of parts.
- Better utilization of manpower and equipment.
- Accurate delivery dates.
- Better services of production control, stock control, purchasing, etc.
- More effective training.

Benefits to Production Planning Department:

- Scope for improved methods, processes and layouts.
- Opportunities for more efficient tool design.
- Better resource allocation.
- Reduction in pre-production activities.

Benefits to Production Control Department:

- Well proven design and methods improve planning and control.
- Accurate delivery promises.
- Fewer delays arise from waiting for materials, tools, etc.
- Follow-up of small batches consumes less time.

Benefits to Purchase and Stock Control Department:

- Holding of stock of standard items leads to less paper work and fewer requisitions and orders.
- Storage and part location can be improved.
- Newer techniques can be used for better control of stocks.
- Because of large purchase quantities involved, favorable purchase contracts can be made.

Benefits to Quality Control Department:

- Better inspection and quality control is possible.
- Quality standards can be defined more clearly.
- Operators become familiar with the work and produce jobs of consistent quality.

Other Benefits:

- Work study section is benefited with efficient break down of operations and effective work measurement.
- Costing can obtain better control by installing standard costing.

- More time is available to the supervisors to make useful records and preserve statistics.
- Reduced reductions and scrap.
- Helps supervisors to run his department efficiently and effectively.

Line Balancing Rules in Mass/ Assembly Line Production:

In mass production system that is also known as assembly line production, since the product is standardized and volume of production is very high, therefore, all man power, equipments and machines need to be arranged in a definite sequence as per the requirement of the product to be produced. In mass production, production takes place in a line as shown in the figure below. *The assembly line is a production line where material moves continuously through a series of workstations where assembly work are performed.*

Product Layout

Used for Repetitive or Continuous Processing

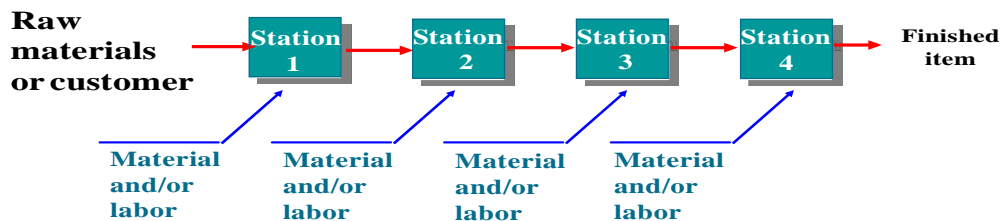

Advantages of Assembly Line Production:

- High rate of output
- Low unit cost
- Labor specialization
- Low material handling cost
- High utilization of labor and equipment
- Established routing and scheduling
- Routine accounting, purchasing and inventory control

Line Balancing Problem in Assembly Line Production:

Since in assembly line production, all man power, machines, equipments and workstations are arranged in a line as per the product process requirements, it is necessary that this line should be balanced. This means that time taken at each work station must be equal and preferably equal to cycle time, otherwise continuous production may be hampered.

Therefore, there is a pressing need to arrange the individual processing and assembly tasks at the workstations so that the total time required at each workstation is approximately the same. It is almost impossible to reach perfect balance.

Things to Consider in Line Balancing:

- Sequence of tasks is restricted, there is a required order, called precedence constraints
- There is a production rate needed, i.e. how many products needed per time period
- Design the line to meet demand and within constraints

Terminology and Definitions:

- Minimum Work Element
- Total Work Content
- Workstation Process time
- Cycle Time
- Precedence Constraints
- Balance Delay

Minimum Work Element:

Dividing the job into tasks of a rational and smallest size

Example: Drill a hole, can't be divided

Symbol – Time for element j: T_{ej}

T_{ej} is a constant

Total Work Content:

Aggregate of work elements

$$T_{wc} = \sum_{j=1}^n T_{ej}$$

Work Station Process Time:

- The amount of time for an individual workstation, after individual tasks have been combined into stations
- Sum of task times = sum of workstation times

Cycle Time:

- Time between parts coming off the line
- Ideally, the production rate, but may need to be adjusted for efficiency and down time
- Established by the bottleneck station, that is station with largest time

Precedence Constraints:

- Generally given, determined by the required order of operations
- Draw in a network style for understanding
- Cannot violate these, an element must be complete before the next one is started

Balance Delay:

Measure of line inefficiency due to imbalances in station times

$$d = \frac{nT_c - T_{wc}}{nT_c}$$

Method- Largest candidate Rule:

- List elements in descending order of T
- Assign elements to first station, from top to bottom of list, minding constraints, and not causing sum to exceed cycle time
- Continue assigning elements to stations where each station < cycle time, largest assigned first, until all assigned

Example of Line Balancing in Continuous/ Mass Production:

The above discussed rule and complete process of line balancing may be understood better with the help of following example:

IFFCO Fertilizer Limited plant manager on the basis of forecast made by sales department; wants its production line to be designed to make 2,400 spreaders per week. The plant will operate 40 hours per week.

(Q1.) What should be the line's cycle time or throughput rate per hour be?

Throughput rate/hr = $2400 / 40 = 60$ spreaders/hr

Cycle Time = $1/\text{Throughput rate} = 1/60 = 1 \text{ minute} = 60 \text{ seconds}$

Assume that in order to produce the new fertilizer spreader on the assembly line requires doing the following steps in the order specified:

Work Element	Description	Time (sec)	Immediate Predecessor(s)
A	Bolt leg frame to hopper	40	None
B	Insert impeller shaft	30	A
C	Attach axle	50	A
D	Attach agitator	40	B
E	Attach drive wheel	6	B
F	Attach free wheel	25	C
G	Mount lower post	15	C
H	Attach controls	20	D, E
I	Mount nameplate	18	F, G
		<hr style="width: 10%; margin: 0 auto;"/> Total 244	

(Q2.) What is the total number of stations or machines required?

TM (Total machines) = total production time / cycle time = $244/60 = 4.067$ or ≈ 5

(Q3.) Drawing Precedence Diagramme:

The figure shows the complete diagram. We begin with work element A, which has no immediate predecessors. Next, we add elements B and C, for which element A is the only immediate predecessor. After entering time standards and arrows showing precedence, we add elements D and E, and so on. The diagram simplifies interpretation. Work element F, for example, can be done anywhere on the line after element C is completed. However, element I must await completion of elements F and G.

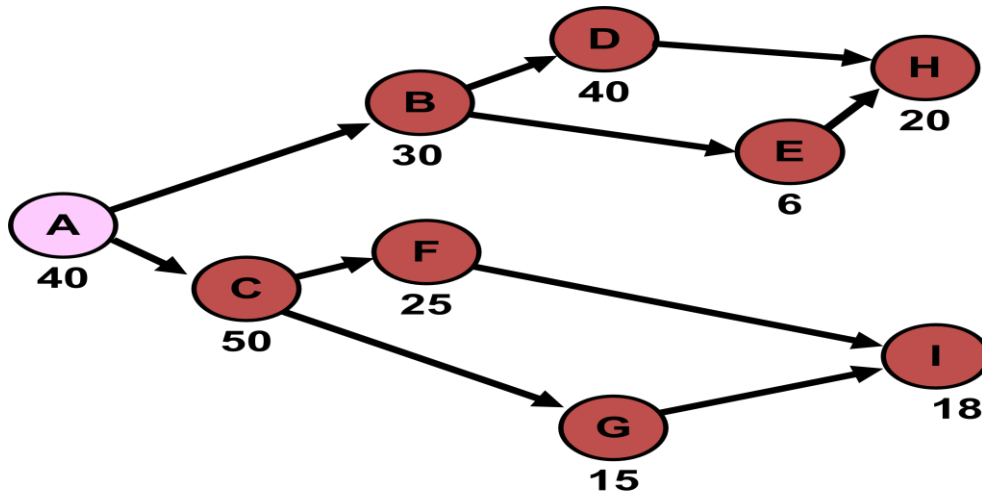

(Q4.) Allocating work or activities to stations or machine

- The goal is to cluster the work elements into workstations so that
 1. The number of workstations required is minimized
 2. The precedence and cycle-time requirements are not violated
- The work content for each station is equal (or nearly so, but less than) the cycle time for the line
- Trial-and-error can be used but commercial software packages are also available

Solution:

The theoretical minimum number of stations $(TM) = \sum t / c$

Where,

$\sum t =$ total time required to assemble each unit

The minimum number of workstations is 5 and the cycle time is 60 seconds, so figure below represents an optimal solution to the problem.

Work station 1 includes machine A, station 2 machine C, station 3 machine B & F, station 4 machine D & G, station 5 machine E,H & I respectively.

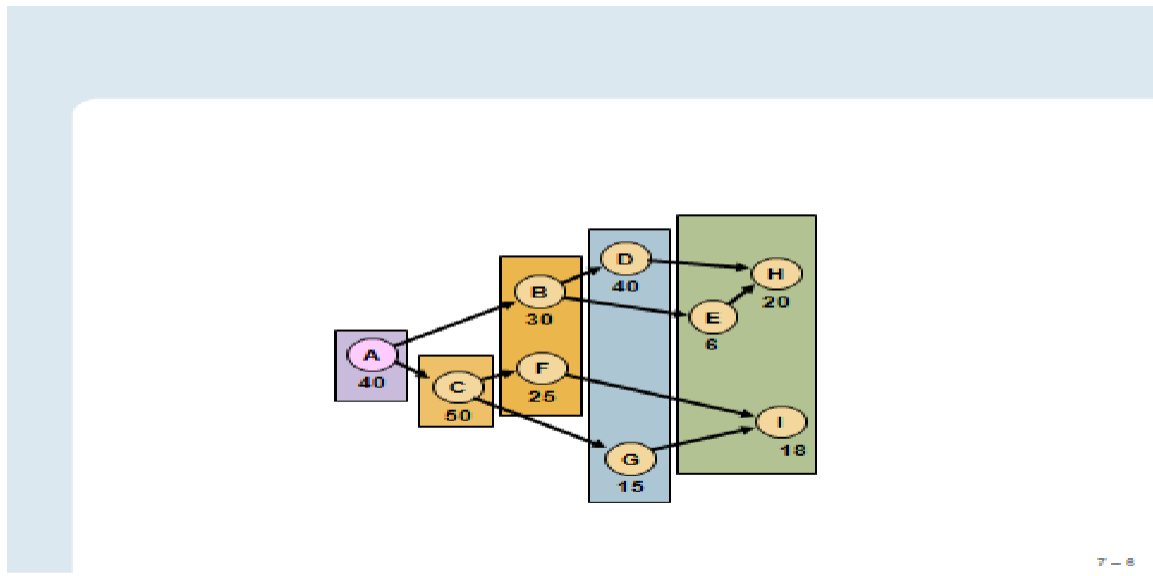

(Q 5.) Calculating Line Efficiency:

Now calculate the efficiency measures of a five-station solution:

$$\text{Efficiency} = \frac{\sum t}{nc} * (100) = \frac{244}{5 \times 60} = 81.3\%$$

$$\text{Balance delay (\%)} = 100 - \text{Efficiency} = 100\% - 81.3\% = 18.7\%$$

$$\text{Idle time} = nc - \sum t = 5(60) - 244 = 56 \text{ seconds}$$

Design of an Assembly Line:

The assembly line balancing aims to minimize the idle time of machines. It means the reduction in the number of operators to perform a task. The entire assembly is divided into parts. An assembly line may follow any of the following models:

- **Modular Production:** Such a model is followed to introduce variety in the mass production system. In such a system, a minimum number of parts or processes are developed and produced. These are called modules. They can be combined in a different ways to offer variety.

- **Group Technology:** In a group technology plant layout, parts required in a particular operation are put under different groups. Machines are arranged in such a way that each machine is assigned to the production of one group.
- **Automation:** Machines, material and control are integrated in such a system.

A Simple Production Line for Assembly of a Clock Face:

It is convenient for the readers to have an idea from the flow chart as shown below that how all facilities are arranged in line form in an assembly line production.

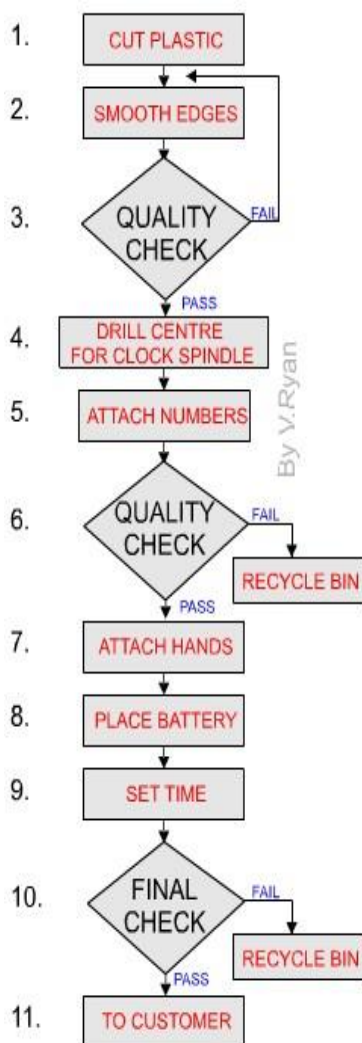

1. The plastic face is cut to shape on a band saw or jig saw. Waste plastic placed in recycle bin - one person required, time - four minutes.
2. The edges of the face are smoothed first on a sanding disc and then on a polishing machine - two people required, overall time - ten minutes.
3. The shape is checked for quality/accuracy - by a quality inspector. If the product fails at this point it is sent back for more accurate shaping and smoothing.
4. The centre of the plastic is drilled so that the spindle of the clock mechanism fits - one person - five minutes.
5. The numbers are set up accurately on the face using a jig to align numbers precisely - one person required, time - 8 minutes.
6. The quality inspector again checks the product of accuracy. If it fails it is placed in the recycle bin.
7. The mechanism is set up and hands are attached and fixed in position - one person, time - 2 minutes.
8. Battery placed in position and tested - same person as for stage 5, time - 1 minute.
9. Time set - one person - same as for previous two stages, time 1 minute.
10. Quality control check. Each clock checked rigorously for quality of finish and working order - one person, time - 3 minutes.

Parameters of Production Planning in Assembly Line Production:

Production planning is related to making the plans i.e. the detailed scheduling of jobs, assigning of workloads to machines (and people), routing, and the actual flow of work through the system. As production is an organized activity of converting raw materials into useful products, plans are made in coordination with different departments: such as production, marketing, logistics, warehouse and other departments depending upon the nature of organization. Planning is always done on the basis of the aim and objective of the production process while keeping in mind the available resources.

Production control is concerned with the effective implementation of the plans. Planning and control are the two most basic, integral and interdependent functions. The plan for an activity is drawn before executing the design or the process. The planning part is always pre operation. Control is done after execution or implementation of the planned layout and procedure. Production planning and control can be viewed as nervous system of the production operation.

A proper control system has to be in place for the best utilization of resources and information before production and analyzing and appraising the performance of labor and equipment after the production is complete. A critical assessment is possible only by setting up a control mechanism.

The basic objectives of production planning and control are:

- To evaluate and appraise the resources at input stage, like the raw materials, labor, data, information and methods required for a production process and to estimate their quantity and quality
- To implement the preplanned process in such a way that optimum production is achieved with maximum efficiency and minimum wastage.

Benefits of Production Planning and Control:

- Systematic planning of production activities to achieve the highest efficiency in production of goods/services
- To organize the production facilities like machines, men, etc., to achieve stated production Objectives with respect to quantity and quality time and cost
- Optimum scheduling of resources

- Coordinate with other departments relating to production to achieve regular balanced and uninterrupted production flow
- To conform to delivery commitments
- Materials planning and control
- To be able to make adjustments due to changes in demand and rush orders.

Parameters of Production Planning:

The various parameters of production planning may be explained as hereunder:

- **Materials:** Raw materials, finished parts and bought out components should be made available in required quantities and at required time to ensure the correct start and end for each operation resulting in uninterrupted production. The function includes the specification of materials (quality and quantity) delivery dates, variety reduction (standardization) procurement and make or buy decisions. In assembly line production material planning becomes very easy as there is no any frequent change in process and production takes place continuously.
- **Machines and equipment:** This function is related with the detailed analysis of available production facilities, equipment down time, maintenance policy procedure and schedules. Concerned with economy of jigs and fixtures and equipment availability. Thus, the duties include the analysis of facilities and making their availability with minimum down time because of breakdowns
- **Methods:** This function is concerned with the analysis of alternatives and selection of the best method with due consideration to constraints imposed. Developing specifications for processes is an important aspect of production planning and determination of sequence of operations. In assembly line all machines, equipments and man power are arranged in a line in the form of work station, therefore, it is the simplest in it.
- **Routing:** Routing means determination of most advantageous path to be followed from department to department and machine, till the raw material gets its final shape. Routing is related to considerations of layout, temporary storage of in process inventory and material handling.

Routing in continuous production industries does not present any problem because of the product type of layout, where the machines are arranged according to the sequence of operations required to be performed on the components. As the production is made of standardized products, the number of operations and sequence of operations arc

standardized. The machines are arranged in sequence with automatic material handling systems. As the production is continuous and constant, routing becomes a routine and mechanical function. In automation routing is still simple and is governed automatically.

Advantages of Routing:

- Reduction in manufacturing costs;
 - Improvement in quantity and quality of the output;
 - Provides a basis for scheduling and loading.
- **Estimating:** Once the overall method and sequence of operations is fixed and process sheet for each operation is available, then the operations times are estimated. This function is carried out using extensive analysis of operations along with methods and routing and a standard time for operation are established using work measurement techniques.
- **Loading and scheduling:** Scheduling is concerned with preparation of machine loads and fixation of starting and completion dates for each of the operations. Machines have to be loaded according to their capability of performing the given task and according to their capacity. Thus the duties include:
- (a) Loading, the machines as per their capability and capacity.
 - (b) Determining the start and completion times for each operation.
 - (c) To coordinate with sales department regarding delivery schedules.
- **Dispatching:** This is the execution phase of planning. It is the process of setting production activities in motion through release of orders and instructions. It authorizes the start of production activities by releasing materials, components, tools, fixtures and instruction sheets to the operator.

The activities involved are:

- To assign definite work to definite machines, work centers and men
- To issue required materials from stores
- To issue jigs, fixtures and make them available at correct point of use

- Release necessary work orders, time tickets, etc., to authorize timely start of operations
- To record start and finish time of each job on each machine or by each man.

Procedure for Production Planning

The process of production planning and control is based on a preset formulation. The plans are made for a specified time period keeping in view the stipulated costs and agreed policies. It is necessary to ensure that the plans are implemented properly. In planning, costs include the capital cost of the facility, assets and labor. The procedure followed in production planning is as follows:

- 1) **Demand predictions:** The production planning process begins with estimating or forecasting the demand among the consumers for the product or the service which is being offered.
 - Preparation of production budget: to compute the total cost of production.
 - Design the facility layout
 - Prescribe the types of machines and equipments to be used
 - Appropriation of production requirements: At the planning stage itself the appropriation of raw materials, men and machinery required is done. Specifics regarding their quality and quantity are decided.
- 2) **Schedules:** The schedules of production are drawn. Date by which a particular operation or production step should be completed is stipulated and reasonable allowances are made for any possible delays or errors.
 - The shortage or excess of the end product is ascertained in relation to efficiency of labor and equipment. According to the fluctuation in the demand for the product, necessary adjustments are made in capacity of machines and the number of labor.
 - Plans are drawn in case of a sudden surge in demand as in seasonal advantages of certain products. Cost of surplus inventory and stocks are taken account of.
- 3) **Rate of Production:** The rate and scale of production is set up. It is broken into realistic time periods and schedules. The stipulated or specified job needs to be finished by a particular date to start the next step.
 - In assembly line production, it is a great challenge to equalize the rate of production for each and every workstation. It is done through line balancing as

explained earlier in this chapter. The main purpose is to reduce the line idle time so that line efficiency is the maximum.

Factors Affecting Production Planning:

Production planning particularly in assembly line production is affected by following factors:

- ✓ **Use of Computers:** Modern factories are using office automation equipment like PC, punch cards etc. It helps accurate computation of required of men and machine.
- ✓ **Seasonal Variations:** Demand of certain products is affected by seasons, for instance umbrellas and raincoats during the monsoons and outputs. Production planning and control must take such changes into consideration while planning and control activities of inputs and outputs.
- ✓ **Test Marketing:** In an aggressive marketing strategy new products are to be test marketed in order to know the trends. This is a short- cycle operation, intermittent in nature and often upsets regular production.
- ✓ **After Sales Service:** This has become an important parameter for success. In after sales services, many items are returned for repair. These are unscheduled work and also overload the production line.
- ✓ **Losses due to Unpredictable Factors:** Losses occur due to accidents, fire and theft of production inputs, mainly materials and components. These are unpredictable. Shortage of input due to such factors upset the planned production schedule in time and quantity.
- ✓ **Losses due to Predictable Factors:** There are losses of inputs, due to natural engineering phenomena like production losses and changes in consumption of materials and occurrence of defectives.
- ✓ **Production of Order:** There are occasions when last minute prioritization of existing orders due to external pressure takes place. These changes in priority are often decided by sufficiently high level of management.
- ✓ **Design Changes:** Design changes are issued by R & D and the engineering department. This will necessarily force production planning control change the input materials and process.
- ✓ **Rejection and Replacement:** There are occasions when sub-assemblies or finished goods are rejected during stage or final inspection. Production planning and control

must cater for contingent plans to take care of rework without affecting scheduled quality.

Summary:

In this chapter, we have discussed the meaning of production that is step-by-step conversion of one form of material into another form through chemical and mechanical process to create or enhance the utility of the product to the user. Some examples of production are: manufacturing standardized products like cars, bus, motorcycle, radio, TV etc.

A production system is actually a combination of various methods, procedures, arrangements and different functions that are required to accumulate (gather) the inputs, process or reprocess the inputs and deliver the marketable output (goods). Production system utilizes materials, funds, infrastructure and labour to produce the required output. There are different types of production systems. These processes may be mentioned as hereunder:

- Job shop: For small scale production
- Batch: For moderate volume
- Repetitive/assembly line: For high volumes of standardized goods or services
- Continuous: For very high volumes of non-discrete goods

The selection of production system mainly depends upon the variety of the products to be produced, volume of production and degree of flexibility required.

In the chapter, our main focus is on the production of high volumes of standardized goods. For such types of goods, mainly mass/ continuous production system is used. It is also known as assembly line production. In assembly line production system, since the product is standardized and volume of production is very high, therefore, all man power, equipments and machines need to be arranged in a definite sequence as per the requirement of the product to be produced. In this, production takes place in a line. *The assembly line is a production line where material moves continuously through a series of workstations where assembly work are performed.*

Production planning parameters and procedure for assembly line has been discussed in detail. The main problem in assembly line production is to equalize the rate of production

for every work station and make it equal to cycle time. It is done under line balancing. The complete process has been explained with the help of suitable example. Adequate emphasis has also been given on the factors affecting planning procedure in assembly line production.

Self-assessment Questions:

- 1) What do you understand by production and production process? Discuss various production processes.
- 2) Explain in detail various types of production System.
- 3) Why Standardization is required in Mass Production?
- 4) Discuss in detail the merits and limitations of mass production.
- 5) Discuss the various parameters of production planning in assembly line production.
- 6) Explain the complete procedure of production planning in assembly line production.
- 7) Explain the concept of line balancing with the help of suitable example. Calculate all of its necessary parameters.

Keywords:

Production System: Manufacturing subsystem that includes all functions required to design, produce, distribute, and service a manufactured product.

Mass Production: Mass production or flow production is the production of large amounts of standardized products, including and especially on assembly lines.

Standardization: Standardization is a framework of agreements to which all relevant parties in an industry or organization must adhere to ensure that all processes associated with the creation of a good or performance of a service are performed within set guidelines.

Production Planning and Control: Production planning and control address a fundamental problem of low productivity, inventory management and resource utilization.

Capacity Planning: Capacity is defined as the ability to achieve, store or produce. For an organization, capacity would be the ability of a given system to produce output within the specific time period. Capacity planning is essential to be determining optimum utilization of resource and plays an important role decision-making process, for example, extension of existing operations, modification to product lines, starting new products, etc.

Routing: Selecting the minimum cost, distance, and/or time path from several alternatives for a good or message to reach its destination.

Scheduling: Scheduling is the process of arranging, controlling, optimizing work and workloads in a production process or manufacturing process.

References:

Ravi, A., Chopra, S., Sudhakar, D., Deshmukh, J. A., Mieghem, V. and Zemel, E. *Managing Business Process Flows: Principles of Operations Management*. Upper Saddle River, NJ: Pearson Prentice Hall, 2006.

Production/Operations Management by William J. Stevenson, Irwin/McGraw-Hill

Production Planning and Control by K. Shridhara Bhat and K. Aswathappa

Production Systems: Planning, Analysis & Control: By —Riggs, J.L.(4th Edn.) John Wiley & Sons

Procedure and Documentation in Production Planning and Control (PPC)

As we have already discussed the concept of production planning and control in detail in previous chapters, now our focus would be on the various types of information, reports and documents required in production planning and control exercise. Production plans are prepared for the future production, in which the facilities needed are determined and arranged. A production planning is made periodically for a specific time period, called the planning horizon.

Production Planning may be said to be a technique of forecasting ahead every step in the long process of production, taking them at right time and in the right degree and trying to complete operations at the maximum efficiency

In the words of Kimball and Kimball Jr –

“The planning of industrial operations involves four considerations, namely, what work shall be done, how the work shall be done and lastly, when the work shall be done.”

Production control is the process that keeps a watchful eye on the production flow and size of resources along with the location, of any deviation from the present action and to arrange for the prompt adjustment so that the production may run according to the original or revised schedule

In the words of Henry Fayol –

“Production control refers to ensuring that all which occurs is in accordance with the rules established and instructions issued.”

Production planning and control essentially consists of planning production in a manufacturing organization before actual production activities start and exercising control activities to ensure that the planned production is realized in terms of quantity, quality, delivery schedule and cost of production. Production planning involves the organization of an overall manufacturing / operating system to produce a product.

The various activities involved in production planning are designing the product, determining the equipment and capacity requirement, designing the layout of physical facilities and material and material handling system, determining the sequence of operations and the nature of the operations to be performed along with time requirements and specifying certain production quantity and quality levels. The main objective of production planning is to provide a physical system together with a set of operating

guidelines for efficient conversion of raw materials, human skills and other inputs into finished products.

An Overview of Production Planning and Control:

Modern production planning methods and tools have been developed since late 19th century. Under Scientific Management, the work for each man or each machine is mapped out in advance. The origin of production planning goes back another century. Kaplan (1986) summarized that "the demand for information for internal planning and control apparently arose in the first half of the 19th century when firms, such as textile mills and railroads, had to devise internal administrative procedures to coordinate the multiple processes involved in the performance of the basic activity (the conversion of raw materials into finished goods by textile mills, the transportation of passengers and freight by the railroads)."

Herrmann (1996) further describes the circumstances in which new methods for internal planning and control evolved: "The first factories were quite simple and relatively small. They produced a small number of products in large batches. Productivity gains came from using interchangeable parts to eliminate time-consuming fitting operations. Through the late 1800s, manufacturing firms were concerned with maximizing the productivity of the expensive equipment in the factory. Keeping utilization high was an important objective. Foremen ruled their shops, coordinating all of the activities needed for the limited number of products for which they were responsible. They hired operators, purchased materials, managed production, and delivered the product. They were experts with superior technical skills, and they (not a separate staff of clerks) planned production. Even as factories grew, they were just bigger, not more complex.

About production planning Herrmann (1996) recounts that "production scheduling started simply also. Schedules, when used at all, listed only when work on an order should begin or when the order is due. They didn't provide any information about how long the total order should take or about the time required for individual operations".

In 1923 *Industrial Management* cited a Mr. Owens who had observed: "Production planning is rapidly becoming one of the most vital necessities of management. It is true that every establishment, no matter how large or how small has production planning in some form ; but a large percentage of these do not have planning that makes for an even flow of material, and a minimum amount of money tied up in inventories."

Characteristics of Production Planning & Control:

- Inputs like materials, men and machines are efficiently used
- Factors of production are integrated to use them economically
- Division of work is undertaken carefully so that every available element is properly utilized
- Work is regulated from the first stage of procuring raw materials to the stage of finished goods
- Questions like what, when and how to be manufactured are decided

Aims & Objectives:

- Determining sequence of operations for continuous production
 - Planning plant capacity for future production programmes
 - Issuing coordinated work schedules to concerned persons
 - Maintaining sufficient inventories to support continuous flow of production
 - Evaluating performance of workshops
 - Maintaining production schedules to ensure delivery at proper time.
-

Importance of Production planning and Control:

Production planning and control is important for the following reasons:

- ❖ **For Increasing Production:** Main purpose of production planning is to arrange inputs. Production control programme minimizes idleness of men and machines. It thus helps in raising industrial output.
- ❖ **For Coordinating Plant Activity:** In planning production is carried out in a number of processes and thus activities are synchronized for smooth working.
- ❖ **For Cost Control:** A properly planned system of production will help in controlling costs by not only making full utilization of various inputs but also by increasing output and lowering overhead expenses per unit.
- ❖ **For Rationalization of Production Activities:** In production planning, the process of entering of raw materials and converting them into finished goods is planned in such

a way that everything is done in sequence or routine. It regulates flow of inputs to run production system smoothly.

Benefits of Production Planning and Control:

- It ensures that optimum utilization of production capacity is achieved, by proper scheduling of the machine items which reduces the idle time as well as over use.
- It ensures that inventory levels are maintained at optimum levels at all time, i.e. there is no over-stocking or under-stocking.
- It also ensures that production time is kept at optimum level and thereby increasing the turnover time.

Since it takes care of all aspects of production, quality of final product is always maintained.

Limitations of Production Planning and Control:

Following are the limitations faced by production planning and control –

- **Based on Assumptions** – Production planning and control is based on certain assumptions. In case the assumptions prove correct, the planning and control will go smoothly. But if they go wrong, process of planning and control will go weak.
- **Rigidity** – Under production planning and control, there is rigidity in the behaviour of employees and it may not help in smoothening flow of work.
- **Difficult for Small Firms** – This process is time consuming and therefore not affordable for small firms
- **Costly** – It is a costly device as its implementation requires separate persons to perform functions of planning, expediting, dispatching etc.
- **Dependence on External Factors** – External factors like natural calamities, change in technology, government controls etc reduce effectiveness of production planning.

Procedure of Production Planning and Control:

Procedure of Production Planning:

Planning in a manufacturing organization is done before actual production activities start. Production planning involves the organization of an overall manufacturing / operating

system to produce a product. The main purpose of planning is to provide a physical system together with a set of operating guidelines for effective transformation of raw materials, human skills and other inputs into finished products. The main activities covered in planning are as follows:

- ✓ **Materials:** Planning for procurement of raw materials, components, and spare parts in the right quantities and specifications at the right time from the right source at the right price. Purchasing, storage, inventory control, standardization, variety reduction, value analysis, and inspection are the other activities associated with material.

**Materials & Resource Planning is explained in details later.*

- ✓ **Methods:** Choosing the best method of processing from several alternatives. It also including determining the best sequence of operations (process plans) and planning for tooling, jigs and fixtures etc.
- ✓ **Machines and Equipments:** Manufacturing methods are related to production facilities available in the production systems. It involves facilities planning, capacity planning, allocation, and utilization of plant and equipments, machines etc.
- ✓ **Manpower:** Planning for manpower (labour and managerial levels) having appropriate skills and expertise.

Procedure of Production Control:

Planning and control in production go side by side. Production control is the process that keeps a close vigil on the production flow and size of resources along with the location, of any deviation from the present action and to arrange for the prompt adjustment so that the production may run according to the original or revised schedule. In short, production control refers to ensuring that all which occurs is in accordance with the rules established and instructions issued in the plans. Control encompasses following procedures:

- ✓ **Routing:** Determining the flow of work, material handling in the plant and sequence of operations or processing steps. It is related to consideration of appropriate shop layout and plant layout, temporary storage locations for raw materials, components and semi-finished goods, and of materials handling systems. The information pertaining to all above is contained in a document termed as “route sheet”.

Route sheet: This is a document providing information and instruction for converting the raw materials into finished parts or products. It defines each step of the production operation and lays down the precise path or route through which the product will flow

during the conversion process. It is the blueprint of the production process in a production unit. It provides the exact location of the various processes of the unit. A route sheet determines the sequence or order of arrangement of various departments in a facility. Thus, a route sheet is a document which has information and data inputs and a step wise listing of all the processes or transactions performed. It also contains details such as date and time, remarks, log in/out, point of contact etc. Route sheet contains the following information:

- The operations required and their desired sequence
- Machine or equipment to be used for each operation
- Estimated set-up time and operation time per piece
- Tools, jigs and fixtures required for the operation
- Detailed drawing of parts, sub-assemblies and final assemblies
- Specification, dimensions, tolerances, surface finishes and quality standards to be achieved
- Specification of raw material to be used
- Speed, feed etc. to be used on machine tools for the operations to be carried on
- Inspection procedure and metrology tools required for inspection
- Packing and handling instructions during movement of parts and subassemblies through the operation stages.

To understand the process of routing better, an example of a route sheet is given of a pencil manufacturing unit.

Product Name	Production begins (Tentative)	Production ends (Tentative)	Date of preparing the route sheet
Pencil Number of sets(6 each)= to be filled in	2-01-2010	01-03-2010	10-11-2009

Raw materials required: graphite, clay, wax, cedar, ferrule, pumice, rubber, metal, prongs, dyes, pigments and gum

Symbols used in the manufacturing process:

O = Operation

T = Transportation

S = Storage

D = Delay

Task Number	Symbols	Description of task	Time Taken	Machinery Required
	O I T S D		(Record the exact running time of the machine)	
1	O	Making the graphite core		Die makers
2	O	Processing the graphite by extrusion method and billet press method		Billet press, extrusion press, oven
3	O	Making the wood casings		Cutter head, Hydraulic press, Shaping machines, Conveyor belt
4	O	Smoothing and Varnishing		Felt disk, Dryer
5	O	Attaching ferrule and eraser		Metal prongs
6	O	Stamping the company logo		Steel dye.

Given above is a rough route sheet of a pencil manufacturing unit. At each stage the inspection of the labour and machinery is done and delays are accounted for. Log book is maintained to record the time taken by machines to complete the work and by employees to enter in/out time. After the manufacturing is complete, the product is run through quality control.

- ✓ **Estimating:** Establishing operation times leading to fixation of performance standards both for workers and machines. Estimating involves deciding the quantity of products to be produced and cost involved in it on the basis of sales forecast. Estimating manpower, machine capacity and materials required meeting the planned production targets are the key activities before assigning funds for resources.
- ✓ **Loading:** Machine loading is the process of assigning specific jobs to machines, men, or work centers based on relative priorities and capacity utilization. Loading ensures maximum possible utilization of productive facilities and avoids bottlenecks

in production. It is important to avoid either overloading or under loading the facilities, work centers or machines to ensure maximum utilization of resources.

- ✓ **Scheduling:** This ensures that parts, sub-assemblies, and finished products are completed as per required delivery dates. It provides a timetable of manufacturing activities. The main objectives of scheduling are as follows:
 - To prevent unbalance use of time among work centers and departments
 - To utilize labour such that the output is produced within established lead time or cycle time so as to deliver the products in time and complete production at minimum total cost.

- ✓ **Dispatching:** This is concerned with the execution of the planning functions. It gives necessary authority to start a particular work which has already been planned under routing and scheduling functions. Dispatching is release of orders and instructions for the starting of production in accordance with the route sheets and schedule charts.

- ✓ **Inspection:** This function is related to maintenance of quality in production and of evaluating the efficiency of the processes, methods and labour so that improvements can be made to achieve the quality standards set by product design.

- ✓ **Evaluating:** The objective of evaluation is to improve performance. Performance of machines, processes and labour is evaluated to improve the same.

- ✓ **Cost Control:** Manufacturing cost is controlled by wastage reduction, value analysis, inventory control and efficient utilization of all resources.

Measuring the Effectiveness of Planning and Control:

The planning and control functions mainly have three phases:

1) Planning phase:

- (a) **Pre-planning phase:** involves activities like product planning and development, demand forecasting, resource planning, facilities planning, plan planning, plant location and plant layout.

(b) **Active planning phase:** involves planning for quality, determination of product-mix, routing, scheduling, material planning, process planning, facility planning, capacity planning and tool planning.

- 2) **Action phase:** Execution or implementation phase includes dispatching and progressing function.
- 3) **Control phase:** Includes status reporting, material control, tool control, inventory control, quality control, labour output control and cost control.

Measuring Effectiveness:

The main task of production planning and control department is to coordinate the activities of various departments, which supports production department viz., purchase, stores, industrial engineering, quality control, design, maintenance etc. Hence the effectiveness of planning and control functions can be generally measured by the company's success in meeting the demand and its ability to produce quality products and deliver them in the delivery schedules desired by the customers at a reasonable price that is acceptable to customers and thereby achieve maximum customer satisfaction.

There are four specific areas in which effectiveness of planning and control function can be measured:

- ❖ *Delivery:* This can be measured by finding out the number of deliveries effected on time and those got delayed over a period of time
- ❖ *Inventory levels:* The value of average inventory held annually value of obsolete inventory, value of non-moving and surplus inventories and the inventories and the inventory turnover ratio are indicators of efficiency in inventory management
- ❖ *Comparison of planned and actual:* Production indicates the performance of planning and control function. Number of overtime hours worked, machine utilization ratio etc is also indicator of effectiveness of this function
- ❖ *Revenues and expenditures:* The expenditures incurred for carrying out the various function of planning and control vis-à-vis the production values and sales revenue realized.

Materials & Resource Requirement Planning:

As we have discussed in earlier chapters per se, success of production/ operation department in any organization depends upon an efficient production plan. One of the key essential of a production plan is material and resource requirement planning system. This plays a pivotal role in assembly-line production. Material requirement planning is a system based approach, which organizes all required production material. Material requirement planning is an information system for production planners based on inventory management. It generates various types of reports as its outputs that are of immense significance for the production planners. The basic components of material planning are as follows:

- Material planning provides information that all the required raw material and products are available for production.
- Material planning ensures that inventory levels are maintained at its minimum levels. Moreover, it ensures that material and product are available whenever production is scheduled, therefore, helping in matching demand and supply.
- Material planning provides information of production planning and scheduling but also provides information around dispatch and stocking.

Objective of Material Requirement Planning

Material requirement planning is processed which production planning and inventory control system, and its three objectives are as follows:

- Primary objective is to ensure that material and components are available for production, and final products are ready for dispatch.
- Another primary objective is not only to maintain minimum inventory but also ensure right quantity of material is available at the right time to produce right quantity of final products.
- Another primary objective is to ensure planning of all manufacturing processes, this scheduling of different job works as to minimize or remove any kind of idle time for machine and workers.

Material Requirement Planning - Inter dependency of Business Function

Material planning not only benefits operation department but is also beneficial to the other department of organization. They are as follows:

- Material planning is useful in determining cash flow requirement based on material requirements and final dispatch schedules.
- It helps procurement team in scheduling purchase of necessary material.
- It helps the sales team in determining delivery dates for final products.

Implementation of Material Requirement Planning

Implementation and success of material resource planning dependent on following factors:

- Acceptability of by top management about advantages and benefits
- Proper training and participation of all workers and personnel
- Precision and accuracy of input data for accurate and reliable results

Advantages of Material Requirement Planning

- It helps in maintain minimum inventory levels.
- With minimum inventory levels, material planning also reduces associated costs.
- Material tracking becomes easy and ensures that economic order quantity is achieved for all lot orders.
- Material planning smoothens, capacity utilization and allocates correct time to products as per demand forecast.

Disadvantages of Material Requirement Planning

- Material planning is highly dependent on inputs it receives from other systems or department. If input information is not correct than output for material planning will also be incorrect.
- Material planning requires maintenance of robust database with all information pertaining inventory records, production schedule, etc. without which output again would be incorrect.
- Material planning system requires proper training for end users in order to get maximum out of the system.
- Material resource planning system requires substantial investment of time and capital.

Inventory Management in Planning and Control:

Inventory records are very important sources of information for the production planners. As we know that inventory management plays a central role within supply-chain management. They play a pivotal role in ensuring goods, and services are delivered on time to customers. At the same time, inventory involves various cost, investment, space management, etc. Also there are chances that stored inventory may get damaged or get stolen adding to extra cost to the company. Therefore, it is important to have a robust inventory management for an organization.

Inventory Holding:

For an organization, it becomes important to hold inventory for the following reason:

- Inventory holding ensures that operation delay do not impact delivery to customers.
- It also ensures that company can meet spikes or fluctuation in product demand.
- It ensures that there is flexibility in production.
- It ensures that any delay by suppliers do not affect working of the company.

Considering the above inventory holding objectives, next step for the company is to make inventory related decision. Inventory decision involves two major considerations, first is the order quantity of the raw material and second is timing for placing those orders.

Inventory Models:

Inventory management is based upon two basic models namely, independent demand inventory model and dependent demand inventory model.

- **Independent Demand Inventory Model:** talks about finished goods or raw material demand which is dependent upon prevailing market conditions and is not correlated to any raw material currently used by the organization. A finished good is an appropriate example for independent demand inventory model.
- **Dependent Demand Inventory Model** talks about raw material demand which are integral parts of production and form important part of material resource planning. For example, demand for raw material can be established as the basis of demand of finished products.

Inventory Costs:

There are three broad categories of cost associated with inventory; holding cost, ordering cost and set up cost.

- **Holding cost:** is carrying cost associated with inventory over a period of time. They include insurance, warehousing, interest, extra head-count, etc.
- **Ordering cost:** is cost associated with purchasing of raw material and receiving raw materials. They include forms, order processing, office maintenance supplies and staff associated with ordering.
- **Set- up Cost:** is cost associated with installation of machine for production. They include clean- up cost, re-tooling cost and adjustment cost.

In nutshell, inventory management ensures that organizations are able to minimize cost and maximize profit.

Summary:

For efficient, effective and economical operation in a manufacturing unit of an organization, it is essential to integrate the production planning and control system. Production planning and subsequent production control follow adaption of product design and finalization of a production process.

Production planning and control address a fundamental problem of low productivity, inventory management and resource utilization. Production planning is required for scheduling, dispatch, inspection, quality management, inventory management, supply management and equipment management. Production control ensures that production team can achieve required production target, optimum utilization of resources, quality management and cost savings. Planning and control is an essential ingredient for success of an operation unit.

Keywords

- **Estimating:** is a process of setting operation times after fixing standards both for worker and machines

- **Loading:** is the process of converting operation schedule into practices
- **Routing:** is the process of determining the flow of work material handling in the plant, and sequence of operations
- **Expediting:** To speed up the work/inspection
- **Production control:** Monitoring the plans and taking corrective actions in case of deviations;
- **Batch Scheduling:** Scheduling of different lots

Self-Assessment Questions

- Discuss in detail the planning and control functions.
- Explain the procedure followed in production planning and control.
- Define route. Discuss the route sheet.
- Discuss the characteristics, merits and limitations of material requirement planning.
- Define inventory management. Discuss the various costs associated with an inventory.

References

- Chase, Jacob, Aquilano, Agarwal (2008), Operations Management for Competitive Advantage, Tata McGraw-Hill
- Krajewski, Ritzman, Malhotra (2007), Operations Management: Processes and Value Chains, Prentice Hall
- Heizer, Render, Jagadeesh (2009), Operations Management, Pearson Education, India
- <http://www.managementstudyguide.com/production-planning-and-control.htm>
- <http://www.managementstudyguide.com/materials-and-resource-requirement-planning.htm>

Concept of Enterprise Resource Planning (ERP)

An Enterprise resource planning system is a fully integrated business management system covering functional areas of an enterprise like Logistics, Production, Finance, Accounting and Human Resources. It organizes and integrates operation processes and information flows to make optimum use of resources such as men, material, money and machine.

Enterprise resource planning promises

- a) one database
- b) one application
- c) one user interface

ERP software for a manufacturing company typically processes the data from and tracks the status of sales, inventory, shipping, and invoicing, as well as forecast raw material and human resource requirements. Figure as below presents the major application components of an ERP system. This also illustrates some of the key cross-functional business processes flows supported by ERP system.

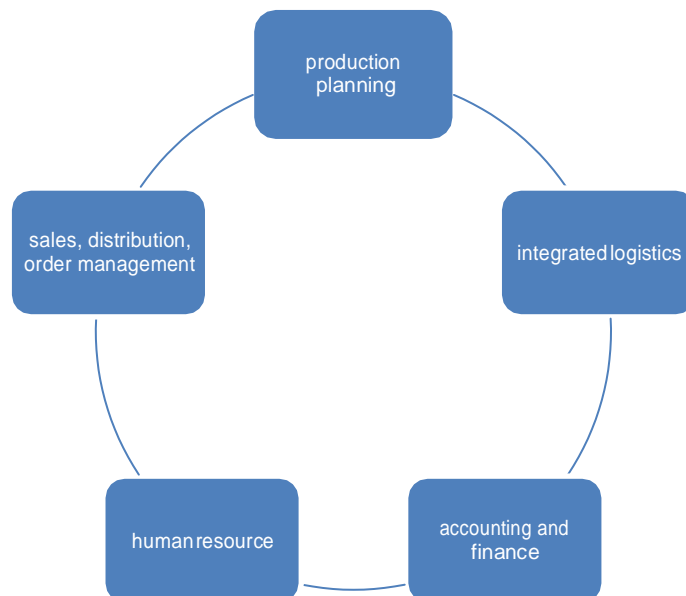

The major components of ERP demonstrate the cross functional approach of ERP systems.

ERP gives a company an integrated real time view of its core business processes, such as

production, order processing, and inventory management, tied together by the ERP application software and a common database maintained by a database management system. ERP system tracks business resources (such as cash, raw material, and production capacity), and the status of commitments made by the business (such as customer orders, purchasing orders, and employee payroll), no matter which department (manufacturing, purchasing, sales, accounting, and so on) has entered the data into system.

ERP software suites typically consists of integrated modules of manufacturing, distribution, sales, accounting, and human resource applications. Examples of manufacturing processes supported are material requirement planning, production planning, and capacity planning. Some of the sales and marketing processes supported by ERP are sales analysis, sales planning, and pricing analysis, while typical distribution applications include order management, purchasing, and logistics planning. ERP systems support many vital human resource processes, from personnel requirements planning to salary and benefits administration, and accomplish most required financial record-keeping and managerial accounting applications.

Evolution of ERP:

In the ever-growing business environment, the following demands are placed on the industry:

- Aggressive cost control initiatives
- Need to analyse costs/revenues on a product or customer basis
- Flexibility to respond to changing business requirements
- More informed management decision making
- Changes in ways of doing business.

One or more applications and planning systems have been introduced into the business world for crossing some of hurdles and achieving growth. They are as follows:

- Management Information Systems (MIS)
- Integrated Information Systems (IIS)
- Executive Information Systems (EIS)
- Corporate Information Systems (CIS)

- Enterprise Wide Systems (EWS)
- Material Resource Planning (MRP)
- Manufacturing Resource Planning (MRP II)
- Money Resource Planning (MRP III)

ERP has evolved from the system known as MRP II (Manufacturing Resource Planning) system with the integration of information between Vendor, Customer and Manufacturer using networks such as LAN, WAN and INTERNET etc.

MRP II system again evolved from MRP (Material Requirement Planning) system. MRP is a technique that explodes the end product demands obtained from Master Production Schedule (MPS) for the given product structure which is taken from Bill of Material (BOM) into a schedule of planned orders considering the inventory in hand.

MRP II has a number of drawbacks as listed below:

- The main problem is that it has not been able to effectively integrate the different functional areas to share the resources effectively.
- The traditional application systems, which the organizations generally employ, treat each transaction separately.
- They are built around the strong boundaries of specific functions that a specific application is meant to cater.

For an ERP, it stops treating these transactions separately as stand-alone activities and considers them to be the part of the inter-linked processes that make up the business.

Enabling Technologies:

- It is not possible to think of an ERP system without sophisticated information technology infrastructure.
- It is said that, the earlier ERP systems were built only to work with huge mainframe computers.
- The new era of PC, advent of client server technology and scalable Relational Database Management Systems (RDBMS)
- Most of the ERP systems exploit the power of Three Tier Client Server Architecture.
- The other important enabling technologies for ERP systems are Workflow, Work

group, Group Ware, Electronic Data Interchange (EDI), Internet, Intranet, Data warehousing, etc.

ERP Characteristics:

Any system has to possess few key characteristics to qualify for a true ERP solution.

These features are as follows:

- 1) **Flexibility:** An ERP system should be flexible to respond to the changing needs of an enterprise. The client server technology enables ERP to run across various database back ends through Open Database Connectivity (ODBC).
- 2) **Modular & Open:** ERP system has to have open system architecture. This means that any module can be interfaced or detached whenever required without affecting the other modules. It should support multiple hardware platforms for the companies having heterogeneous collection of systems. It must support some third party add-ons also.
- 3) **Comprehensive:** It should be able to support variety of organizational functions and must be suitable for a wide range of business organizations.
- 4) **Beyond the Company:** It should not be confined to the organizational boundaries, rather support the on-line connectivity to the other business entities of the organization.
- 5) **Best Business Practices:** It must have a collection of the best business processes applicable worldwide. An ERP package imposes its own logic on a company's strategy, culture and organization.

Features of ERP:

- ❖ ERP provides multi-platform, multi-facility, multi-mode manufacturing, multi-currency, multi-lingual facilities.
- ❖ It supports strategic and business planning activities, operational planning and execution activities, creation of Materials and Resources.
- ❖ ERP covering all functional areas like manufacturing, selling and distribution, payables, receivables, inventory, accounts, human resources, purchases etc.
- ❖ ERP performs core activities and increases customer service, thereby augmenting the corporate image.

- ❖ ERP bridges the information gap across organisations.
- ❖ ERP provides complete integration of systems not only across departments but also across companies under the same management.
- ❖ ERP is the solution for better project management.
- ❖ ERP allows automatic introduction of the latest technologies like Electronic Fund Transfer (EFT), Electronic Data Interchange (EDI), Internet, Intranet, Video conferencing, E-Commerce etc.
- ❖ ERP eliminates most business problems like material shortages, productivity enhancements, customer service, cash management, inventory problems, quality problems, prompt delivery etc.
- ❖ ERP provides intelligent business tools like decision support system, Executive information system, Data mining and easy working systems to enable better decisions.

Need to Undertake ERP

In present era, each and every organization needs to undertake ERP system because of the following reasons:

- a) **Integrate financial information:** As the CEO tries to understand the company's overall performance; he may find many different versions of the truth. ERP creates a single version of the truth that cannot be questioned because everyone is using the same system.
- b) **Integrate customer order information:** ERP systems can become the place where the customer order lives from the time a customer service representative receives it until the loading dock ships the merchandise and finance sends an invoice. By having this information in one software system companies can keep track of orders more easily, and coordinate manufacturing, inventory and shipping among many different locations simultaneously.
- c) **Standardise and speed up manufacturing processes:** Manufacturing companies - especially those with an appetite for mergers and acquisitions—often find that multiple business units across the company make the same transaction / recording / report using different methods and computer systems. ERP systems come with standard methods for automating some of the steps of a manufacturing process.
- d) **Reduce inventory:** ERP helps the manufacturing process flow more smoothly, and it

improves visibility of the order fulfilment process inside the company. That can lead to reduced inventories of the materials used to make products (work-in-progress inventory), and it can help users better plan deliveries to customers, reducing the finished good inventory at the warehouses and shipping docks.

- e) **Standardise HR information:** Especially in companies with multiple business units, HR may not have a unified, simple method for tracking employees' time and communicating with them about benefits and services. ERP can fix that.

Benefits of ERP:

Following are some of the benefits they achieved by implementing the ERP packages:

- Gives Accounts Payable personnel increased control of invoicing and payment processing and thereby boosting their productivity and eliminating their reliance on computer personnel for these operations.
- Reduce paper documents by providing on-line formats for quickly entering and retrieving information.
- Improves timeliness of information by permitting posting daily instead of monthly.
- Greater accuracy of information with detailed content, better presentation, satisfactory for the auditors.
- Improved cost control.
- Faster response and follow-up on customers.
- More efficient cash collection, say, material reduction in delay in payments by customers.
- Better monitoring and quicker resolution of queries.
- Enables quick response to change in business operations and market conditions.
- Helps to achieve competitive advantage by improving its business process.
- Improves supply-demand linkage with remote locations and branches in different countries.
- Provides a unified customer database usable by all applications.
- Improves International operations by supporting a variety of tax structures, invoicing schemes, multiple currencies, multiple period accounting and languages.
- Improves information access and management throughout the enterprise.
- Provides solution for problems like Y2K and Single Monetary Unit (SMU) or Euro Currency.

BUSINESS PROCESS REENGINEERING (BPR)

ERP is a result of a modern enterprise's concept of how the information system is to be configured to the challenging environments of new business opportunities. However merely putting in place an information system is not enough. Every company that intends to implement ERP has to reengineer its processes in one form or the other. This process is known as Business Process Reengineering (BPR).

Some typical processes with descriptions

PROCESS	DESCRIPTION
✓ Forecasting	Shows sales, Fund Flows etc over a long period of time say next two years.
✓ Fund management	The necessity of funds and the way to raise these funds.
✓ Price planning	Uncertainty and Risk factors to be considered. Simulation with "What if" type analysis Determines the price at which products are offered. Involves application of technology to pricing support such as commercial database services. Also feedback and sensitivity analysis
✓ Budget allocation	Using computerised algorithms to estimate desirable mix of funds allocated to various functions.
✓ Material requirement planning	Process of making new products from raw materials and include production scheduling, requirement planning. Also activities for monitoring and planning of actual production.
✓ Quality control	Takes care of activities to ensure that the products are of desired quality.

BPR is the fundamental rethinking and radical redesign of processes to achieve dramatic improvement, in critical, contemporary measures of performance such as cost, quality,

service and speed.”

- **Dramatic achievement** means to achieve 80% or 90% reduction (in say, delivery time, work in progress or rejection rate) and not just 5%, 10% reduction.
- ✓ **Radical redesign** means BPR is reinventing and not enhancing or improving. In a nutshell, a “cleanslate approach” of BPR says that “Whatever you were doing in the past is all wrong”, do not get biased by it or reassemble your new system to redesign it afresh.
- ✓ **Fundamental rethinking** means asking the question “why do you do what you do”, thereby eliminating business process altogether if it does not add any value to the customer.

Business Engineering:

Business Engineering has come out of merging of two concepts:

- 1) **Information Technology:** Information technology helps to develop business models, which assist in redesigning of business processes.
- 2) **Business Process Reengineering:**
 - ❖ Business Engineering is the rethinking of Business Processes to improve speed, quality and output of materials or services
 - ❖ The main point in business engineering is the efficient redesigning of company’s value added chains
 - ❖ Value added chains are a series of connected steps running through a business which when efficiently completed add value to enterprise and customers

Business Engineering is the method of development of business processes according to changing requirements.

Business Management:

- ERP merges very well with common business management issues like Business Process Reengineering, total quality management, mass customisation, service orientation, and virtual corporation etc.
- The basic objective of implementing an ERP program is to put in place the

applications and infrastructure architecture that effectively and completely support the Enterprise's business plan and business processes.

- When an enterprise does not have optimized business processes, the ERP implementation needs a process reengineering which enable to capture knowledge of the experts into the system thus gaining considerable benefits in productivity.
- The first step in implementation of ERP is the development of a business process model showing business process as one large system and the interconnection and sequence of business subsystems or processes that drive it.

First of all, a model consisting of core business processes or activities of the business is to be developed. This is the diagrammatic representation of business as a large system with interconnection of subsystems or processes that it comprises of. The Data model consists of two elements:

- A diagram describing various Business processes and their interactions.
- An underlying Data Model.

Business modelling in practice:

- Most of the ERP packages available today enable flow charting business processes using standard flow chart symbols.
- By connecting symbols used for users, events, tasks/functions, and other organizational information, complex business information can be analysed.
- For example SAP which is a popular ERP package uses event driven process chain (EPC) methodology to model Business Process.
- Business Modeling is the basis by which one can select and implement a suitable ERP package.

ERP IMPLEMENTATION:

- ✓ The success of an implementation mainly depends on how closely the implementation consultants, users and vendors work together to achieve the overall objectives of the organisation.
- ✓ The implementation consultants have to understand the needs of the users, understand the prevailing business realities and design the business solutions keeping in mind It is

the users who will be driving the implementation and therefore their all these factors active involvement at all stages of implementation is vital for the overall success of implementation.

- ✓ It is worthwhile to remember that ERP is an enabling tool, which makes one do his work better, which naturally needs additional efforts.
- ✓ During the course of implementation the standard package may undergo changes which may be a simple one or a major 'functionality' change. Implementing such changes is known as Customization.
- ✓ The contents of the package are known as modules and the modules are further divided into Components.
- ✓ The roles and responsibilities of the employees have to be clearly identified, understood and the employees will have to accept new processes and procedures configured in the system laid down in the ERP system.
- ✓ At the same time these processes and procedures have to be simple and user friendly.
- ✓ A well-managed and implemented ERP package can give a 200 percent return on investment where as a poorly implemented one can yield a return on investment as low as 25 percent.

Key planning and implementation decisions: a number of the key decisions that need to be made when this discussion looks at considering an enterprise integration effort. The decision to implement an ERP should be based on a business case rational:

- Technology justifications include the need to address the Y2K problem (in most cases, this is no longer applicable), integrate the functions of disparate systems; merge acquisitions with new capabilities such as web accessibility into the business environment.
- Process improvements address actions that result in personal and IT cost reductions.
- Productivity improvements include the need to close the financial cycle and increase the overall production from an enterprise standpoint.
- Strategic considerations to implement new strategies not supported by the current software improve customer service and satisfaction, respond to competitive responsiveness.

Follow Software's Processes or Customize?

- This key decision may determine the success or failure of the ERP effort.
- If the organization decides to follow the process of the software, this will result in the organization following Best practices within its sector, thereby giving it a chance to improve and standardize their processes.
- However, this processes approach can create significant turmoil by requiring employees to change their ways of doing business.
- If the organization decides to stick with its current processes and customize the software to fit these processes, the organization obviously will not have to experience the pain and stress
- However, it will be very costly to customize and maintained the software over time.

In-house or Outsource?

Outsourcing

- IT has the advantage of allowing the organization to continue to focus on its core the mission,
- Avoid a relative substantial financial commitment (in some cases) and minimize impact on the MIS department.
- On the downside, providing opportunities to those external to the organization may poorly impact employee morale and may give rise to security issues.

In-house

- Implementation include: a better match between the software and the business, applications optimized for the organization and better maintained security.
- However, an in-house approach cannot be accomplished if there is a lack of internal expertise and personnel to support such an effort.

“Big Bang” or Phased Implementation

- ❖ A “big bang” implementation involves having all modules at all location implemented at the same time. Characteristics of this approach include no need for temporary interfaces, limited requirement to maintain legacy software, cross-module functionality and overall cost if no contingencies arise.

- ❖ Phased implementation one or a group at a time, often a single location at a time. Benefits of approach include: a smoothing of resource requirements, an ability to focus on a particular module, availability of existing legacy systems, as fall-back, reduced risk, the knowledge gained with each phase and the usefulness of demonstrable working system.
- ❖ The wave approach: This approach involves the application of different waves of change to different business units or regions.
- ❖ Parallel implementation: This approach involves both ERP and an existing system running together for a period of time.
- ❖ Instant cutovers (flip-the-switch): This approach is lower in cost motivates users to convert to the new system and reduces the need for redundant systems, however it tends to be risky, stressful to users and requires a high level of contingency planning.

ERP Implementation Methodology:

Several steps are involved in the implementation of a typical ERP package:

1. Identifying the Needs: Some of the basic questions, which are to be answered, are

- Why should an ERP package be implemented?
- Will it improve profitability?
- Can the delivery times of products be reduced?
- How does it improve customer satisfaction in terms of quality, cost, delivery time and service?
- Will it help to reduce cost of products?
- How can it help to increase business turnover and at the same time reduce manpower?
- Will it be possible to reengineer the business processes?

2. Evaluating the “AS IS” situation of the business:

To understand the present situation of the business, the various functions should first be listed.

- Total time taken by the business processes.
- Number of decision points existing in the present scenario.
- Number of Departments/Locations of businesses process.

- The flow of information and its routing.
- The number of reporting points currently available.

3. 'Would Be' situation:

Deciding the desired 'Would Be' situation: The concept of 'Benchmarking' is used to see that processes achieved are the best in industry. Benchmarking is done on various factors like cost, quality, service etc. This concept enables to optimise the processes to gain overall benefits.

4. Reengineering the business process: Reengineering of business processes is done to

- Reduce the business process cycle time.
- To reduce the number of decision points to a minimum.
- Streamlining the flow of information and eliminating the unwanted flow of information.

5. Evaluation of various ERP packages: Evaluation of ERP packages are done based on the following criteria:-

Flexibility: It should enable organizations to respond quickly by leveraging changes to their advantage, letting them concentrate on strategically expanding to address new products and markets.

Comprehensive: It should be applicable across all sizes, functions and industries. It should have in-depth features in accounting and controlling, production and materials management, quality management and plant maintenance, sales and distribution, human resources management and plant maintenance, sales and distribution, human resources management, and project management.

Beyond the company: It should support and enable inter-enterprise business processes with customers, suppliers, banks, government and business partners and create complete logistical chains covering the entire route from supply to delivery, across multiple geographies, currencies and country specific business rules.

Best business practices: The software should enable integration of all business operation in an overall system for planning, controlling and monitoring and offer a choice of multiple ready-made business processes including best business practices that reflect the experiences, suggestions and requirements of leading companies across industries. In other words, it should intrinsically have a rich wealth of business and organisational knowledge base.

New technologies: It should incorporate cutting-edge and future-proof technologies such as object orientation into product development and ensure inter-operability with the Internet and other emerging technologies. It should be Y2K and Euro compliant, group up. Other factors to be considered are:

- Global presence of package.
- Local presence.
- Market Targeted by the package.
- Price of the package.
- Obsolescence of package.
- Ease of implementation of package.
- Cost of implementation.
- Post-implementation support availability.

6. Finalisation of the ERP package: Finalisation of the ERP package can be done by making a comparison of critical factors through a matrix analysis.

7. Installation of Hardware and Networks: This work is carried out in phased manner depending on the schedule of implementation and need of the hardware components.

8. Finalising the Implementation Consultants: The factors of selection for consultants:

- skill set
- industry specific experience
- cost of hiring consultants

9. Implementation of ERP package

- formation of team
- preparation of plan
- mapping of business process to package
- gap analysis
- customization
- development of user specific reports and transaction
- uploading of data from existing system
- test run
- user training

- Parallel run.
- Concurrence from user
- Migration to the new system
- User documentation.
- Post-implementation support.
- System monitoring and fine tuning

Implementation Guidelines for ERP:

There are certain general guidelines, which are to be followed before starting the implementation of an ERP package:

- Understanding the corporate needs and culture of the organisation and then adopt the implementation technique to match these factors.
- Doing a business process redesign exercise prior to starting the implementation.
- Establishing a good communication network across the organisation.
- Providing a strong and effective leadership so that people down the line are well motivated.
- Finding an efficient and capable project manager
- Creating a balanced team of implementation consultants who can work together as a team.
- Selecting a good implementation methodology with minimum customisation.
- Training of end users.
- Adapting the new system and making the required changes in the working environment to make effective use of the system in future.

POST- IMPLEMENTATION:

To start at the beginning, many post implementation problems can be traced to wrong expectations and fears. The expectations and fear that corporate management have from an ERP have been greatly published. Of course, some of the blame for this is on the ERP vendors and their pre-implementation sales hype. A few of the popular expectations are:

- An improvement in processes
- Increased productivity on all fronts.
- Total automation and disbanding of all manual processes.

- Improvement of all key performance indicators.
- Elimination of all manual record keeping.
- Real time information systems available to concerned people on a need basis.
- Total integration of all operations.

ERP implementation also causes a host of fears. Some of them are:

- Job redundancy.
- Loss of importance as information is no longer an individual prerogative.
- Change in job profile.
- An organizational fear of loss of proper control and authorization.
- Increased stress caused by greater transparency.
- Individual fear of loss of authority.

Balancing the expectations and fears is a very necessary part of the implementation process.

RISK AND GOVERNANCE ISSUES IN AN ERP:

Organizations face several new business risks when they migrate to real-time, integrated ERP systems. Those risks include:

- a) **Single point of failure:** Since all the organization's data and transaction processing is within one application system and transaction processing is within one application

system. Structural changes significant personnel and organizational structures changes associates with reengineering or redesigning business processes.

- b) **Job role changes:** transition of traditional user's roles to empowered-based roles with much greater access to enterprises information in real time.
- c) **Online, real-time:** An online real-time system environment requires a continuous business environment capable of utilizing the new capabilities of the ERP application and responding quickly to any problem requiring of re-entry of information.
- d) **Change management:** It is challenging to embrace a tightly integrated environment when different business processes have existed among business units for so long. The level of user acceptance of the system has a significant influence on its success. Users must understand that their actions or inaction have a direct impact upon other users and, therefore, must learn to be more diligent and efficient in the performance of their Day to day duties. Considerable training is therefore required for what is typically a large number of users.
- e) **Distributed computing experience:** Inexperience with implementing and managing distributed computing technology may pose significant challenges.
- f) **Broad system access:** Increased remote access by users and outsiders and high integration among application functions allow increased access to application and data.
- g) **Dependency on external assistance:** Organization accustomed to in-house legacy systems may find they have to rely on external help. Unless such external assistance is properly managed, it could introduce an element of security and resource management risk that may expose the organizations to greater risk.
- h) **Program interfaces and data conversions:** Extensive interfaces and data conversions from legacy systems and other commercial software are often necessary. The exposures of data integrity, security and capacity requirements for ERP are therefore often much higher.
- i) **Audit expertise:** Specialist expertise is required to effectively audit and control an ERP environment. The relative complexity of ERP systems has created specialisation such that each specialist may know only a relatively small fraction of the entire ERP's functionality in a particular core module,

More recently, some of the additional risks and good governance issues introduced by the enabled ERP environments concern:

1. **Single sign on:** It reduces the security administration effort associated with administrating web-based access to multiple systems, but simultaneously introduces

additional risk in that an incorrect assignment of access may result in inappropriate access to multiple systems.

2. **Data content quality:** As enterprise applications are opened to external suppliers and customers, the need for integrity in enterprise data becomes paramount.
3. **Privacy and confidentiality:** Regularity and governance issues surrounding the increased capture and visibility of personal information, i.e. spending habits.

Summary:

Enterprise Resource Planning (ERP) Systems are coherent and integrated software applications that can support a large variety of operational processes and business functions and a focal monitoring, control and coordination tool for all operations that take place in the headquarters and the distinct remote locations of modern enterprises. Via advanced database and communication technologies and sound coverage of diverse business functions, ERP systems achieve data centralization, integration of business software applications and business process redesign, all in the quest for process optimization, productivity enhancements and gaining of competitive advantage through innovative information technology. For the successful enterprises and organizations within the Information and Knowledge Society, ERP Systems are the backbone transactional information platforms that allow quick response to the challenges emanating from the continuously evolving business landscape

Self-assessment Questions:

1. What is ERP?
2. Why implement ERP system in business firms?
3. What are the benefits of ERP?
4. What are the reasons of ERP failure?
5. What is ERP implementation strategy?
6. Discuss various risks and governance issues in implementation of ERP?

Keywords:

- ❖ **ERP:** ERP has evolved from the system known as MRP II systems with the integration of information between vendor, customer and manufacturer using network such as LAN, WAN, and INTERNET etc.

- ❖ **MRP II:** This again evolved from MRP system. MRP is a technique that explodes the end product demands obtained from master production schedule of planned orders considering the inventory in hand.
- ❖ **MRP:** system provides reports such as MRP reports, planned order releases for purchase orders, work orders, reschedules open orders report, firm planned reports, shortage reports etc. MRP is considered as an important planning and manufacturing control activity for materials.
- ❖ **RDBMS:** It stands for scalable Relational Data Base management System that contributes for the ease of deployment of ERP.

References:

1. Rouse, Margaret. *"ERP (enterprise resource planning)". Tech Target. Retrieved July 14, 2015.*
2. Bidgoli, Hossein, (2004). *The Internet Encyclopaedia, Volume 1, John Wiley & Sons, Inc. p. 707.*
3. Shaul, L. and Tauber, D. 2012. CSFs along ERP life-cycle in SMEs: a field study. *Industrial Management & Data Systems, 112(3), 360-384.*
4. Khosrow–Puor, Mehdi. (2006). *Emerging Trends and Challenges in Information Technology Management. Idea Group, Inc. p. 865.*
5. "A Vision of Next Generation MRP II", Scenario S-300-339, Gartner Group, April 12, 1990
6. Anderegg, Travis. *"MRP/MRP II/ERP/ERM — Confusing Terms and Definitions for a Murky Alphabet Soup". Retrieved September 23, 2013.*
7. Shields, Murell G. (2005). *E-Business and ERP: Rapid Implementation and Project Planning. John Wiley and Sons, Inc. p. 9.*

Production Planning and Control Function

Introduction

In the previous chapter, an attempt has been made to give you an indepth understanding of various types of production systems and the concept of production planning and control. Fundamentally, production planning and control is viewed as a managerial function which in turn becomes the nervous system of the production system. Its main objective is efficient utilization of required material resources, people and facilities in any enterprise. This is done through planning, coordinating and controlling all production activities which convert the raw material resources into finished products or components in the most optimal manner.

Broadly speaking, production Planning is a dynamic function which is largely concerned with the issues like required production facilities, laying down these facilities and the methods to utilize them in such a way that the desired output may be produced at the desired rate and desired cost. Production plans need to be changed according to the changes in circumstances.

On the other hand, production control is a mechanism to monitor the execution of the production plans. It ensures that all production operations/activities take place strictly as per the set plans. In case of any deviations, taking immediate corrective measures and informing the planning section so that they may improve the future plans accordingly. Production planning and control as a department plays a vital role in manufacturing organizations. It coordinates with other departments and provides relevant information.

The stages in production planning and controls are:

1. Planning – choosing the best course of action among several alternatives.
2. Operation – execution as per plan.
3. Control – maintaining the performance by comparing the actual result with performance standard set and taking appropriate corrections action if necessary to reduce variance.

In this chapter, a detailed discussion has been made pertaining to role of production planning and control in manufacturing organization, changes in production planning and

control techniques on the basis of production system, its significance and benefits for the organization, fundamental differences between production planning and production control per the its benefits, constraints of production planning and control etc

Factors Determining Production Planning Procedures:

Production planning keeps varying from company to company. This begins with a product idea, plan for design of the product and entire production/operating system to manufacture that product. It also includes the task of planning for the manufacturing of modified version of an existing product using the existing facilities. The main difference between the planning procedures is one company and another is principally due to the difference in the economic and technological conditions under which the companies operate. The main factors affecting production planning procedures are summarized as below:

i) Production Volume

The purview of production planning in any organization mainly depends upon the quantity/volume of output to be produced. Its main objective is to cut the manufacturing cost. For instance, in case of custom order job shop, where volume of production is generally less, the planning of production is limited to only purchase of the raw material/component and determination of work centers, which have the capacity of manufacturing the product.

ii) Nature of Production Process

Nature of manufacturing process is also an important factor that determines the intensity of production planning in any organization. For example, in case of custom job shop, the production planning may be informal and development of the work methods is left to individual workman who is highly skilled. Whereas, in the high volume production, many product engineers are involved who put enormous amount of effort in the designing the product and manufacturing processes.

iii) Nature of operations

Nature of required operations is again very significant parameter that determines the scope of production planning in any organization. For example, continuous production of any single standardized that is characterized by repetitive operations, detailed production planning is required.

There are mainly two types of manufacturing approach:

- **Manufacture to order:** In this, a product is manufactured when its demand arises. Therefore, product is not produced repeatedly at regular intervals. (no repetition of operations)
- **Manufacture to stock and sell:** Product is produced continuously as there is a regular demand from the market or it is produced for stocking purpose. (repetition of operations)

Role of Production Planning and Control in Production Management

Production planning and control in operations has got great significance due to its interactive role and interdependency on all the sections of the production department. This is evident from the figure as below.

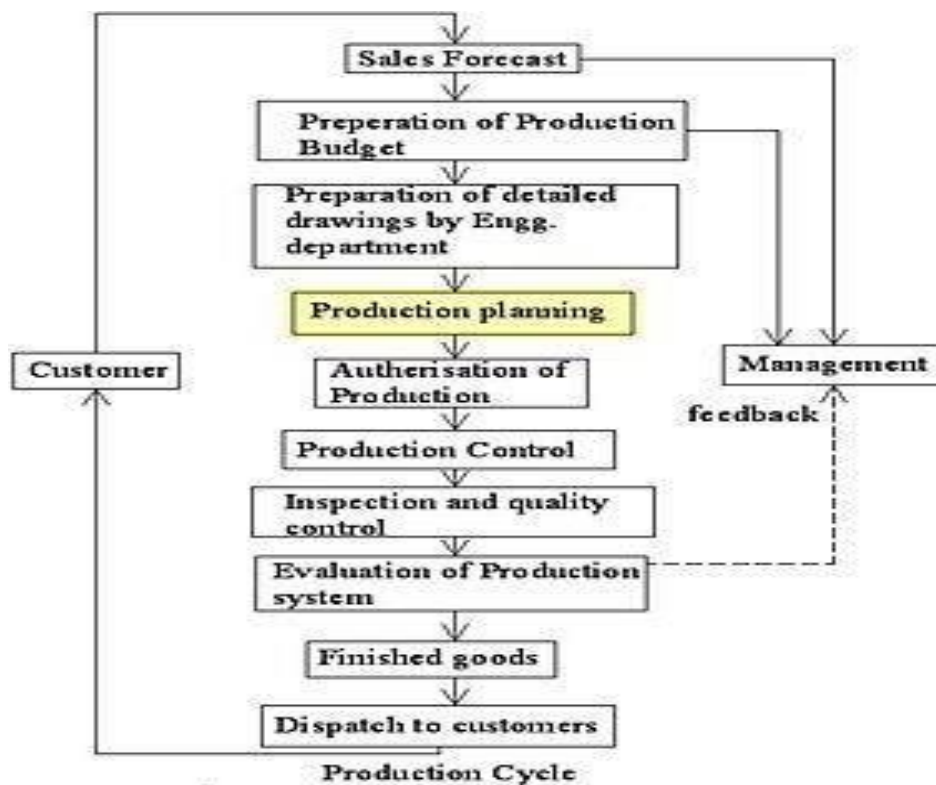

First, production planning and control receives the inputs from the design of product and nature of manufacturing process to be used. Then complete planning is done which is circulated further to manufacturing and assembly sections. When actual production takes place, a close monitoring and control is exercised at each and every step of work progress. The figure above clearly depicts the interdependency of PPC on other departments. It may be viewed that PPC needs to interact with all other departments such as sales and distribution, procurement and inventory, repair and maintenance, quality control and industrial engineering and work study in both directions to exercise its functions efficiently and effectively.

PPC requires a lot of documentation and paper work for the proper functioning of production department. The main documents include demand forecast reports, customer's orders, estimated sales figure, long term production plans for the current and new products, production budget for each product, master production schedules for a given time, work orders with production department, inventory reports, estimates of costs, various reports from purchase department, job specifications, shortage reports and many more reports etc.

PPC is a complex phenomenon which becomes more and more complicated with the growing number of products in company' product mix increase.

Shop Floor Production Planning and Control

Here, it is important to understand that the production planning is done at the highest level considering the issues mainly including product design, job design process design, equipment selection and replacement, labour skills and training programs, input material selection including raw material and sub-contracting, plant selection and layout, scheduling steps of the plan, implementing and controlling the schedule and choice of production system etc.

Shop floor production planning is done at the bottom level (usually known as shop floor) by the junior level people over a short range time span. It is concerned with the utilization of existing facilities rather than creating new facilities. It involves proper utilization of key resource such as raw materials, machine capacity, energy etc. Short-term planning takes into account current customer order, priorities, material availability, absenteeism rate, cash flows etc. and it is designed to respond quickly to change in production levels and market conditions. Short range planning establishes short range schedule which specify the quantity of specific product to be produce in each week of planning horizon which varies from weeks to few months. Machine shop planning involves the day to day issues and decision related to operations planning.

Difference between Production Planning and Production Control

The production planning and control essentially has two important functions namely production planning and production control. They facilitate in effective production function. These two functions are running parallel to each other. But they have very different scope and nature. The difference are shown in below

Production Planning

Production planning is one part of production planning and control dealing with basic concepts of what to produce, when to produce, how much to produce, etc. It involves taking a long-term view at overall production planning. This can be done only after assessing the customer demand for the product. Production planning focuses on the principle of meeting the targeted customer demand rate in the most efficient way possible while keeping open the capability to respond to variations in demand.

This assesses the requirement of different materials to fulfill your production target and their availability. An efficient production planning keeps the minimum materials as standard inventory. Planners must evaluate how much material the company needs, the lead times for orders, the delivery times for suppliers and the reliability of the suppliers/vendors. Production planners take into account the capabilities of the machines/ equipments used to produce the output. Basic stability of an equipment is ascertained on the basis of three parameters namely, its availability, its performance and its quality. This is done by Overall Equipment Effectiveness (OEE). Manpower planning needs accurately estimating the number of employees required to do the work. The capacity of the workforce must match the capabilities of the equipment to plan for the highest efficiency. Planning for the processes is done keeping in view that the processes continue to operate efficiently and safely during the entire production time. Often the normal operations of a process require occasional testing and adjustments. A final production planning puts in place controls that detect problems as soon as they occur. When controls are in place, it enables to take possible corrective actions to minimize the effects and return production to the required levels.

Hence, the main objectives of production planning may be summarized as below:

- To ensure right quantity and quality of raw material, equipment, etc. are available during times of production;
- To ensure capacity utilization is in tune with forecast demand at all the time;
- To streamline the overall production process;
- To ensure the timely and regular delivery of the product;
- To provide advance information to vendors/ suppliers about the requirement of different types of raw materials and components;

- To reduce investments in inventory;
- To reduce overall production cost by driving in efficiency.

This is important to notice that the production planning is concerned with two basic strategies' product planning and process planning. Production planning is done at three different time dependent levels i.e. long-range planning dealing with facility planning, capital investment, location planning, etc.; medium-range planning deals with demand forecast and capacity planning and lastly short term planning dealing with day to day operations often termed as shop floor planning. We have already discussed shop floor planning in the previous section.

Production Control

In literary sense control means action to check/regulate. According to Mary Gushing Niles, "Control is maintaining a balance in activities towards a goal or set of goals evolved during production planning." Planning only outlines some course of action whereas control is an execution process involving standardization, evaluation and corrective functions.

As per Fayol, "Control consists in verifying whether everything occurs in conformity with the adopted plan and established principles. The objective of control is to point out weaknesses and shortcomings, if any, in order to rectify them and prevent recurrence. It operates on everything viz. material, equipment, men, operations etc. For control to be effective, it must be applied within reasonable time and be followed-up sanctions."

Therefore, production control may be understood as a scientific procedure that regulates an orderly flow of material and co-ordinate various production operations to achieve the objective of producing desired item in right quantity of desired quality at the required time by the best and the cheapest method i.e., to attain highest efficiency in production. Alternately, production control is the function of management which plans, directs and controls the material supply and processing activities of an enterprise; so that specified products are produced by specified methods to meet an approved sales programme. It ensures that the activities are carried in such a way that the available labour and capital are used in the best possible way.

Need of Production Control in Manufacturing Organizations:

Production system of a manufacturing unit comprises of man, machine, equipments, labour etc which are put together at a given time. Their arrangement is mainly governed by conditions imposed by the required operations. One must remember that it is not possible for a production planner to control the inputs. In fact, planner makes an attempt to control the output so that it is in conformity with the target set by the marketing department. Briefly, we can say that production control attempts to streamline the complete process so that goods and services are produced as per the requirements of the customers, i.e., of right quality, quantity at the desired time.

In the present severe competition, it goes without saying that production control has become the hallmark of production efficiency. It is a necessity and not a luxury but a profitable investment. This is a boon for a firm which attempts to take corrective measures whenever there is some deviation from the planned strategy. The success of an enterprise greatly depends on the performance of its production control department. Production control looks to utilize different type of control techniques to achieve optimum performance out of the production system as to achieve overall production planning targets.

The main functions of production control are discussed as below:

- To make provisions for raw material, equipment, machines and labour;
- To organize production schedule in conformity with the demand forecast;
- To utilize resources in the best possible manner so that the cost of production is minimized and delivery date is maintained;
- To determine economic production runs with a view to reduce setup costs;
- To ensure proper co-ordination of the operations of various sections/departments responsible for production;
- To ensure regular and timely supply of raw material at the desired place and of prescribed quality and quantity to avoid delays in production;
- To perform inspection of semi-finished and finished goods and use quality control techniques to ascertain that the produced items are of required specifications;
- To decide the product design and development.

Factors Determining Production Control Operations

It is necessary to understand that production control cannot be same across all the organization. This varies from organization to organizations. Production control mainly depends upon following factors:

- a) *Nature of Production:* In case of continuous production, production control becomes very easy due to fixed process. But for the job type production, where process changes on the basis of every order, control becomes very complicated.
- b) *Nature of operations:* In different manufacturing firms, the operations are reasonably varied in terms of nature, sequence and duration. Hence the control procedure also needs lot of continuous changes accordingly.
- c) *Magnitude of operations:* the centralized controlling system provides the most effective coordination to the organization but when the organization starts to increase in terms of size then there is the requirement of decentralization of the production and the control functions. The degree of decentralization totally depends upon the scope of operations.

Hence, we can say that production planning and production control both are essential for customer delight and overall success of an organization.

Importance of Production Planning and Control

An efficient production planning and control system provides better and more economic goods to the customers with lower amount of the investment for the organization. This is vital for all the production plants. Its importance can be explained by the following points:

- ❖ **Improved customer service:** The production planning and controlling uses the proper instrument of scheduling and expediting of work, which provides better services to customers in the form of better quality of goods at reasonable prices at pre decided delivery dates. It improves relations with customers and helps to achieve profitable re-order.
- ❖ **No pendency of order:** By effective production planning and control operations move smoothly as per planning and in conformity with the required delivery dates. it leads to fewer rush orders and less overtime.
- ❖ **Improved inventory control:** PPC assists in maintaining inventory at optimum levels which minimizes investment in inventory. It requires lower work-in-progress. PPC provides better control over raw-material inventory.
- ❖ **Efficient utilization of facilities:** PPC helps in the most effective use of equipment. It updates the management on a regular basis for the latest position of all orders in process equipment and personnel requirements. Also, unnecessary purchases of equipment and materials can be avoided with the help of PPC. Thus it ensures proper utilization of equipment and other resources.

- ❖ **Curtailing idle times:** PPC can reduce idle time, i.e. wastage of time by workers waiting for materials and other facilities because PPC ensures that all required materials and other facilities are available at the required time.
- ❖ **Congenial working environment:** As the production planning and control system coordinates with all departments involved, it maintains a healthy working environment which improves morale.
- ❖ **Better reputation:** An effective production planning and controlling system leads to systematized operations in an organization. Thus an organization can meet its orders in time resulting in the satisfaction of its customers, increased sales, increased profit, and industrial harmony, and developing a better reputation of the organization.
- ❖ **Curtailing investment:** In PPC, everything is planned well in advanced of operations. Thus, inputs can be made available early, which avoids any bottleneck. So it helps in minimizing capital investment in equipment and inventories.

Production Planning and Control in Different Production System

Production planning and control (PPC) for different types of system has been explained in detail as below:

(1) PPC in Mass Production

The mass production rests on the concept of the assembly line. In this, the entire process is sub divided into small components and afterwards they are grouped to follow production procedures. Assembly line ensures that available labour force and machines/ equipments are arranged in a sequential manner. In this, pre-determined task is completed at each workstation and then materials transmit continuously at a constant average rate (cycle time) to another work station. At different work stations, a certain portion of work is done. This system is very effective in case of production of large quantities like toys, automobiles, television, and computers.

PPC in mass production becomes very easy in view of the followings:

1. Material handling is very convenient and efficient.
2. Since the process is very well defined and easy, no specialization required
3. Well defined arrangement of machines and labour
4. No frequent changeovers in assembly line
5. It ensures high production rate.
6. The cycle time once fixed, remains same for a specific product

Drawbacks of Mass Production:

1. Each and every machine must function properly otherwise entire production brings to an end.
2. Assembly line is unique and completely inflexible setup.
3. Assembly line installations are capital-intensive due to types of machines.

(2) PPC in Job Production

Unlike mass production, job production deals with different types of jobs. Various jobs are performed with specific set of operations and particular time duration for each operation. The available labour and equipments are divided for use in different departments. The requirement of each machine is different based on the operation to be performed for a particular job. The job shop is similar to waiting line system because when a job is finished from one machine, it needs to wait in line for the next machine having earlier jobs in line too. Sometimes, the machines also wait for jobs while running ideally, thus a proper system of planning and control is a must for the job shop production.

PPC becomes very complex in case of job production because of the followings:

1. Very frequent changeovers in production setup
2. Very frequent changes in sequencing and prioritizing to prevent wastage
3. An appropriate scheduling needs to be done according to the estimated time taken by each job.
4. Loading needs to be adjusted according to job

PPC in Job production may be understood well by the following cases:

Case 1

In this, a number of jobs are performed by single machine. In such a case, prioritizing and scheduling become very critical as the jobs have to wait in line to be completed. Its purpose is to improve the average idle time, waiting time, and the work in process time. The shortest processing time (SPT) is aimed for in a job shop production.

Case 2

In this, a number of jobs are performed by two machines M_1 and M_2 . The processing time on both the machines is determined. The minimum time to complete a job is also estimated.

Now a sequence is worked out to line jobs on both the machines for the target of maximum production in minimum time.

Prioritizing rules for job shops

The job which has the shortest processing time (SPT) is chosen. In such a case, one can also put the job which has the earliest delivery due date first in line. First come first serve rule may be applied. It depends on the manufacturer's priorities and the master production schedule.

Job shop productions include paint shops, machine tool factories and specialty restaurants.

(3) PPC in Batch Production

Batch production is used when one needs to produce a large number of products but in small quantities. It is more appropriate for the small scale firms where often, the product is produced in smaller quantities but in different variants. The lot size or batch size is fixed keeping view the economic factor. It means that the best batch size keeps the total cost to a minimum while maintaining the high demand. Production should be such that all the different varieties of the product can be sold simultaneously. Batch size mainly depends on the 1) set-up cost and 2) carrying cost.

In batch production, a process layout is required. Similar machines are grouped into various departments. All processes follow their own routes.

The complexity of PPC in batch production may be understood by the followings:

1. Materials handling is slow, time consuming and costlier because of the interruptive flow of material.
2. More elaborative production planning and control is required.
3. Work-in-process needs more capital and space.
4. More skilled workers are required.

Constraints of Production Planning and Control

The Production planning and control functions are carried out under following constraints and limitations:

- ❖ PPC is a time consuming activity, particularly for the complex production mix as well as depends on having a large number of components and parts because of difficulty in carrying out routing, scheduling and loading functions;
- ❖ PPC is based on certain given conditions and assumptions and depends on uncertain demand forecast. Therefore, working becomes erroneous many times;
- ❖ Production capacity, quality of materials, availability of materials and power, level of skill of manpower, managing PPC are the main constraints for effective functions of PPC.
- ❖ Plans, checks and controls are the integral parts of the PPC which are often protested by the workers and sometimes even by supervisors;
- ❖ Business environment plays a dominant role in PPC. Because of its dynamic nature, it makes very difficult to manage PPC in case of changes in technology, customers demand and tastes, government policy, etc.

Summary

Briefly, production Planning is a dynamic function which is largely concerned with the issues like required production facilities, laying down these facilities and the methods to utilize them in such a way that the desired output may be produced at the desired rate and desired cost. Production plans need to be changed according to the changes in circumstances.

On the other hand, production control is a mechanism to monitor the execution of the production plans. It ensures that all production operations/activities take place strictly as per the set plans. In case of any deviations, taking immediate corrective measures and informing the planning section so that they may improve the future plans accordingly. Production planning and control as a department plays a vital role in manufacturing organizations. It coordinates with other departments and provides relevant information. Importance of production planning and control better service to customers, fewer rush orders, better control of inventory, more effective use of equipment, reduced idle time, improved plant morale, good public images, lower capital requirements.

There are many factors which affect PPC in an organization. It needs to be changed as per the volume of production, type of production system used and variety of product. At present PPC have become a necessity and not a luxury. This is a wise investment to accomplish the

goals in the most optimum manner. Like others, PPC is also not without the limitations. It has to work under certain constraints and limitations.

Self assessment Questions

1. Explain the concept of production planning and control. Discuss its main functions?
2. What do you mean by production control? Discuss its objectives?
3. Differentiate between production planning and production control?
4. Discuss the role of production control system in enhancing the efficiency of production function?
5. "PPC is a non-tangible function and is very difficult to measure its efficiency." Justify the statement?

Keywords

- Dispatching:** Estimating the value of the product
- Expediting:** To speed up the work/inspection
- Production control:** Monitoring the plans and taking corrective actions in case of deviations;
- Batch Scheduling:** Scheduling of different lots
- Routing:** To fix the routes/paths of various operations

References

- Chase, R.B, Aquilano, N.J., and Jacobs, F.R., *Production and Operations management: Manufacturing and Services*. Tata McGraw-Hill
- Chopra, S. and Meindl, p., *Supply Chain Management*: Prentice Hall Delhi.
- Krajewski, L. J. and Ritzman, L.P., *Operations Management: Strategy and Analysis*, 5th ed, Addison Wesley.
