



PHILIPS

LED Modules

Design-in Guide

Fortimo DLM

A modern office interior with orange and black walls, recessed ceiling lights, and orange chairs around a table. A large green plant is in the foreground on the left.

**Improve your
total cost
of ownership**

Fortimo LED Downlight Module (DLM) System Gen 4 UL SREC
Design-in Guide

Contents

Introduction to this guide	3	Thermal model	19
More information or support	3	Thermal design of a heat sink	19
UL SREC	3	Thermal resistance in relation to ambient temperature	20
Introduction to Philips Fortimo LED Downlight		Passive cooling	20
Module System	4	Design guidelines for passive cooling	20
Applications	4	Complementary thermal solution partners	21
Can the module be used in outdoor luminaires?	4	Electrical design	22
Criteria for Fortimo LED Modules	4	Wiring	22
System approach	5	Class 2	22
Nomenclature of Fortimo Downlight		Active cooling power supply with 12V	22
Modules 2000	5	Substitution Gen 3 System with Gen 4 System	23
Philips Advance Xitanium LED Drivers	5	Mechanical difference between Gen 3 systems and Gen 4 systems	23
Cables for Xitanium 25W/36W Driver	6	Housing change	24
Cables for Xitanium 50W Driver	6	Connector position change	24
OEM developed cables	7	Approbation	24
Emergency application	7	Approved drivers for the system	25
Emergency driver compatibility	8	Norms and Standards	25
Emergency driver wiring diagram with DLM Gen 4	8	Safety	25
Dimensions of modules	8	Safety Related Electronic Circuit	25
Compatible Xitanium LED Drivers and cables with Fortimo LED Downlight Module (DLM) Gen 4	10	Performance	26
Philips Advance Xitanium 25W/36W Driver diagram and dimension	11	Electromagnetic compatibility (tested with Fortimo LED DLM, cable and Xitanium LED Driver)	26
Philips Advance Xitanium 50W Driver diagram and dimension	11	Environmental	26
Light technical design	12	Approval	26
Fortimo LED Downlight Modules address the issue of binning	12	Chemical compatibility	26
Color consistency Standard Deviation Color Matching (SDCM)	12	UV and other hazards	28
Starting characteristics	12	IEC recommendations	28
Lumen maintenance	12	Photobiological safety aspects	28
Minimum and maximum flux per type	13	Fortimo LED DLM gave the following results	29
Thermal model	14	Humidity	29
Secondary optics	14	Exposure to direct sunlight	29
Companies supplying reflectors for secondary optics	15	Vibration and shocks	30
Mechanical design	16	Philips Fortimo LED DLM Systems are to be used for indoor applications	30
About the Fortimo Downlight Modules	16	End-of-life behavior	30
Mechanical fixation	16	Fortimo LED DLM System disposal	30
Recommended screw type	16	Contact details	31
Thermal management	17	Philips	31
Optimum performance	17	Partners for cooling solutions	31
Test requirements	17	Partners for reflector solutions	31
Critical measurement points	17	Partners for thermal interface materials	31
Fixture design using Safety Related Electronic Circuit	18	Index of visuals	32
Thermal Interface Material	18	Abbreviations	33
Electrical and thermal analogy	19	Footnotes	34
		Disclaimer	35

Introduction to this guide

Thank you for choosing Philips Fortimo LED Downlight Module System. In this guide you will find all the information you require to design a luminaire based on these modules, as well as details of the necessary drivers and cables. As LED technology is continuously improving, we advise you to visit for the latest details our website: www.philips.com/ledmodulesna.

More information or support

If you require any further information or support please, consult your local Philips sales representative. Your Philips sales representative can provide you more information around how to access design-in service from Philips.

UL SREC

To ensure traceability in the downstream value chain and to avoid possible misuse of the application, Philips introduced the UL SREC program into Fortimo LED DLM Gen 4 product portfolio with suffixed part numbers for LED modules and LED drivers. The products that comply to the UL SREC program carry an X at the end of the existing SKU number.

If module and driver do not both carry the additional X in the SKU, the final lighting fixture may not comply to UL 991 within UL SREC program and needs additional thermal protection.

All statements about product design-in in this guide that are non UL SREC related are still valid for old and new (“X”) part numbers for Fortimo LED DLM Gen 4.

Please note:

- Non-suffixed LED drivers are compatible with suffixed LED modules.
- Suffixed LED drivers are compatible with suffixed LED modules.
- Suffixed LED drivers are not compatible with non-suffixed LED modules.

Introduction to the Philips Fortimo LED Downlight Module Systems

Applications

As the name suggests, the Philips Fortimo LED Downlight Module is designed to be integrated into downlight luminaires for indoor use. OEMs may explore other applications and luminaires as long as there is no design conflict and compliance is ensured with luminaire standards, such as UL1598/UL8750 & CSA250-13.

Can the module be used in outdoor luminaires?

Neither the module nor the driver have an IP classification. If these products are used in luminaires for outdoor applications, it is up to the OEM to ensure proper IP protection and approbation of the luminaire. Please consult Philips design-in team if you wish to deviate from the design rules described in this guide.

Criteria for Fortimo LED Modules

Fortimo LED modules stand for the following criteria:

1. High quality white light

While LED technology gives the promise of high quality white light in terms of color rendition and color consistency, this does not happen automatically. As long as LED binning remains a factor, one can never be sure that different LED modules will produce exactly the same shade or color of white light. This requires a high degree of technical orchestration of all parts of the system on the part of the LED module manufacturer.

The Fortimo Downlight Module Gen 4 is designed to meet the same high requirements for white light applications as its previous generations, and its unique remote phosphor technology enables great color consistency over life.

2. High energy efficiency

We have not seen the end of performance improvements in LED technology. Part of the Fortimo promise is to continue making use of the latest developments and implement energy efficiency upgrades on a regular basis. Yet innovating within the existing mechanical form factor of Fortimo DLM, the Gen 4 of Fortimo DLM offers up to 32% energy efficiency gains compared to a Gen 3 predecessor.¹

3. Future proof systems

As energy efficacy of LEDs advances and new bins become available, LED module upgrades are planned. The new generation of LEDs will be incorporated into the Fortimo LED modules, resulting in a higher efficacy, without changing the dimensions, shape or lumen output of the system. A really future proof approach is to enable luminaire manufacturers to easily plan and design new luminaire ranges for the coming years.



Figure 1. Fortimo LED Downlight Module with Xitanium LED Driver



Figure 2. Fortimo LED Downlight Module

4. Reliability

With LEDs there is an increasing number of ways failures can happen, but strict manufacturing processes and test procedures will help guarantee lifetime and quality assurance. All Fortimo LED modules are subjected to these measures and are built for a long life of up to 50,000 hrs.²

System approach

Fortimo LED modules are always designed and marketed together with a Philips Xitanium LED driver, as Philips believes that a good system design is crucial to facilitate an easy design-in. There is a wide range of Philips Advance Xitanium LED drivers available for all Fortimo LED modules, offering plenty of flexibility and choice.

All modules are built-in versions for integration into luminaires. This is applicable for the drivers too, except for Xitanium independent LED drivers that can be used remotely (independently) from the LED luminaire.

The modules have interfaces for:

- Cabling between LED module, driver and luminaire
- Secondary optics via mounting options in the LED module housing and reflector rim
- Heat sink design via heat spreader.

Nomenclature of Fortimo Downlight Modules 2000

The names of the modules are defined as follows. Fortimo LED DLM 2000 19W/840 Gen 4 is used here as an example.

- Fortimo : Our brand name for efficient, clear and reliable lighting
- LED : The light source used
- DLM : Downlight module
- 2000 : 2000 lumens
- 19W : 19 W typical module power consumption
- /840 : For a color rendering index of 80; 40 stands for a CCT of 4000 K
- Gen 4 : Generation of product

Philips Advance Xitanium LED Drivers

The highly efficient LED drivers are designed to operate high-power LEDs which are integrated into the Fortimo LED modules.



Figure 3. Xitanium LED Driver 25 W, 0-10V dimming



Figure 4. Xitanium LED Driver 50 W, 0-10V dimming

LED DLM cables for Xitanium 25W and 36W Drivers

Two cables, which are 50cm and 84cm in length and have a wire diameter of AWG24 (0.5mm), are available to connect with driver. The functions of the cables connected to the driver are as follows:

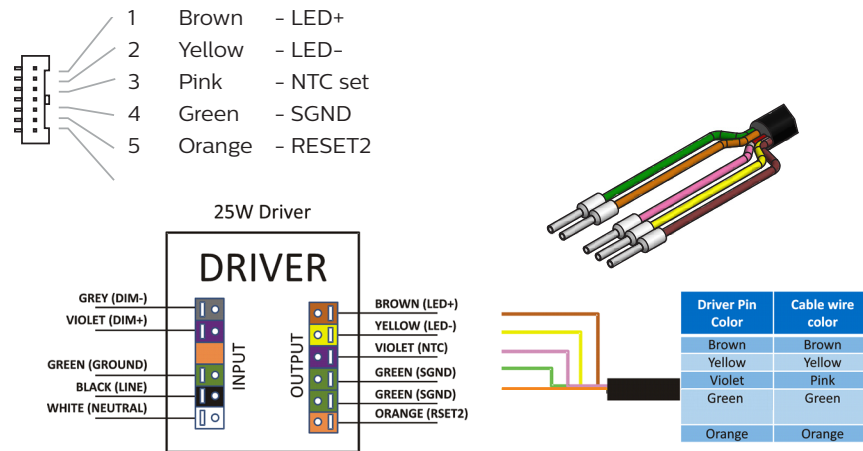

Figure 5. Wiring diagram for Fortimo DLM Gen 4 systems and 25W and 36W Xitanium LED Drivers

LED DLM cables for Xitanium 50W Driver

Two cables, which are 50cm and 84cm in length and have a wire diameter of AWG24 (0.5mm), are available to connect with driver. The functions of the cables connected to the driver are as follows:

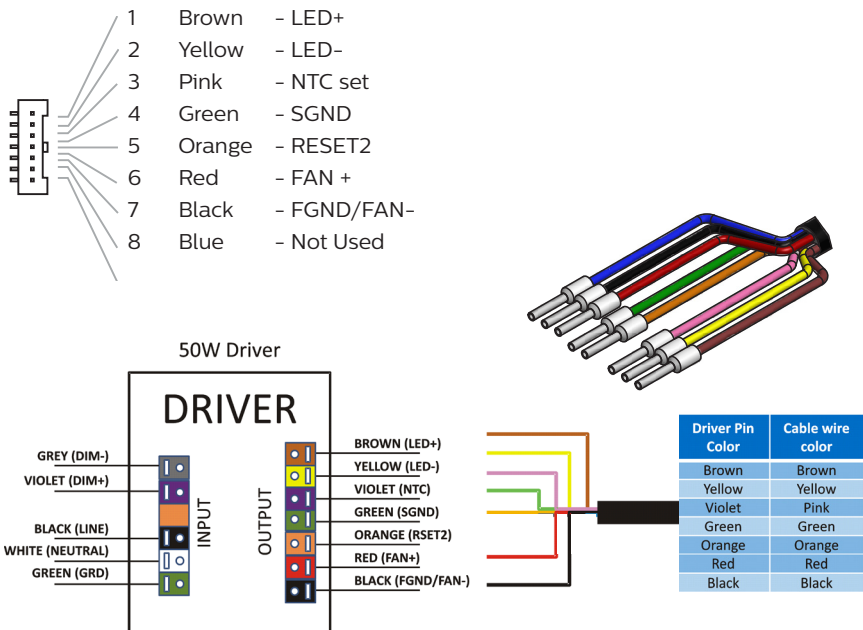

Figure 6. Wiring diagram for Fortimo DLM Gen 4 systems and 50W Xitanium LED Driver

OEM developed cables

We recommend you use Philips LED Downlight Module cables. However, if you prefer to develop your own cables, the specification must meet UL/CSA requirements. Please bear in mind that the approval for the Fortimo LED Downlight Module and LED driver is based on a reference luminaire with a standard cable based on the maximum length of 84cm. Any luminaire design will require its own approval by a CB, to be arranged by the relevant OEM, irrespective of the length of cable used.

An OEM-developed cable that is in accordance with the design in rules to obtain system warranty, should have the following specifications:

- Housing JST-PHR-7
- Contact JST SPH-002T-PO.5S
- Wago wire ferrule 216-201
- Wire 22 AWG UL style 1568 stranded or equivalent

Emergency application

All commercial and government buildings in the US require emergency lighting in order to meet the Life Safety Code NFPA 101. Philips Emergency Lighting offers the BSL17C-C2 emergency driver, specifically designed for Fortimo Downlight Module Gen 3 and Gen 4. When AC power is lost, the BSL17C-C2 takes over operation of the LED module for 90 minutes to help comply with emergency code requirements. The BSL17C-C2 is Class 2, UL Component Recognized and CSA Certified. Please check emergency driver data sheet for the latest wiring diagram.



Figure 7. Philips Bodine Emergency Driver

LED Module	Bodine BSL17C-C2 emergency driver
Fortimo LED DLM 1100 lm Gen 4	Yes
Fortimo LED DLM 1500 lm Gen 4	Yes
Fortimo LED DLM 2000 lm Gen 4	Yes
Fortimo LED DLM 3000 lm Gen 4	Yes

Table 1. Emergency application

For more information, please visit our website at www.bodine.com/products/specs/bsl17cc2.html. Emergency Product training videos can be found at www.youtube.com/user/PhilipsBodine.

Guiding holes – Top mounting



- Guiding holes Ø8 mm
- Fit for M4 Socket Head Cap Screw

Guiding holes – Bottom mounting

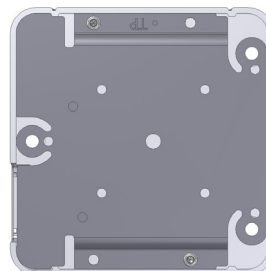

- Also 3xM5 bottom-up mounting

Housing



- Full metal housing
- 4 x M4
(8mm inside module)
- No side cooling possible
- Side mounting holes M4
- Also 3xM5 bottom-up mounting

Connector position change



- Connector depth = 2.7 mm
- Connector height = 10.5 mm

Compatible Xitanium LED drivers and cables with Fortimo LED Downlight Module (DLM) Gen 4

Module		Driver		Cable	
Description	Part No.	Description	Part No.	Description	Part No.
1100 lumen					
Fortimo LED DLM 1100 10W/827 UL Gen 4	9290 008 95406 X				
Fortimo LED DLM 1100 10W/830 UL Gen 4	9290 008 77503 X	Xitanium 25W 0.3 - 1.0A 18 - 36V, 0 - 10V dimming	XI025C100V036DNMX	DLM Cable No Fan 50cm DLM Cable No Fan 84cm	929000683903 929000684003
Fortimo LED DLM 1100 10W/835 UL Gen 4	9290 008 77603 X	Xitanium 25W 0.1-1.0A 18- 45V, 0-10V dimming	XI025C100V045DNM1		
Fortimo LED DLM 1100 9W/840 UL Gen 4	9290 008 95506 X				
1500 lumen					
Fortimo LED DLM 1500 16W/827 UL Gen 4	9290 008 95506 X				
Fortimo LED DLM 1500 14W/830 UL Gen 4	9290 008 77703 X	Xitanium 25W 0.3 - 1.0A 18 - 36V, 0 - 10V dimming	XI025C100V036DNMX	DLM Cable No Fan 50cm DLM Cable No Fan 84cm	929000683903 929000684003
Fortimo LED DLM 1500 14W/835 UL Gen 4	9290 008 77803 X	Xitanium 25W 0.1-1.0A 18- 45V, 0-10V dimming	XI025C100V045DNM1		
Fortimo LED DLM 1500 13W/840 UL Gen 4	9290 008 77903 X				
2000 lumen					
Fortimo LED DLM 2000 22W/827 UL Gen 4	9290 008 95606 X				
Fortimo LED DLM 2000 21W/830 UL Gen 4	9290 008 78003 X	Xitanium 25W 0.3 - 1.0A 18 - 36V, 0 - 10V dimming	XI025C100V036DNMX	DLM Cable No Fan 50cm DLM Cable No Fan 84cm	929000683903 929000684003
Fortimo LED DLM 2000 20W/835 UL Gen 4	9290 008 78103 X	Xitanium 25W 0.1-1.0A 18- 45V, 0-10V dimming	XI025C100V045DNM1		
Fortimo LED DLM 2000 19W/840 UL Gen 4	9290 008 78203 X				
3000 lumen					
Fortimo LED DLM 3000 34W/827 UL Gen 4	9290 008 95706 X	Xitanium 36W 0.3 - 1.0A 20 -48V, 0 - 10V dimming	XI036C100V048DNMX	DLM Cable With Fan 50cm DLM Cable With Fan 84cm	929000683903 929000684003
Fortimo LED DLM 3000 32W/830 UL Gen 4	OR				
Fortimo LED DLM 3000 30W/835 UL Gen 4	9290 008 78403 X	Xitanium 50W 0.3 - 1.0A 27 -54V, 0 - 10V dimming	XI050C100V054DNMX	DLM Cable With Fan 50cm DLM Cable With Fan 84cm	929000663703 929000683803
Fortimo LED DLM 3000 28W/840 UL Gen 4					

Table 2. Compatible Xitanium LED drivers and cables with Fortimo LED Downlight Module (DLM) Gen 4

Xtitanium 25W and 36W Driver input/output diagram and dimensions

Screw - Mounting dimensions

Dimensions	A1	A2	A3	B1	C1	D1
Xtitanium 25W and 36W 0.3-1A 0-10V	4.96"	4.57"	4.20"	2.36"	0.96"	1.99"
Dimming	126.0	116.0	106.2	60.0	24.4	50.55

Table 3. Xtitanium 25W and 36W Driver dimensions



Figure 8. Xtitanium 25W and 36W Driver

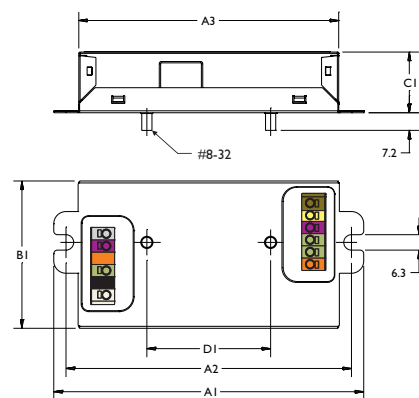
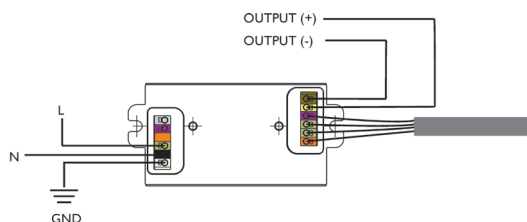

Xtitanium 50W Driver input/output diagram and dimensions

Screw - Mounting dimensions

Dimensions	A1	A2	A3	B1	C1	D1
Xtitanium 25W and 36W 0.3-1A 0-10V	4.96"	4.57"	4.20"	2.36"	0.96"	1.99"
Dimming	126.0	116.0	106.2	60.0	24.4	50.55

Table 4. Xtitanium 50W Driver dimensions



Figure 8. Xtitanium 50W Driver

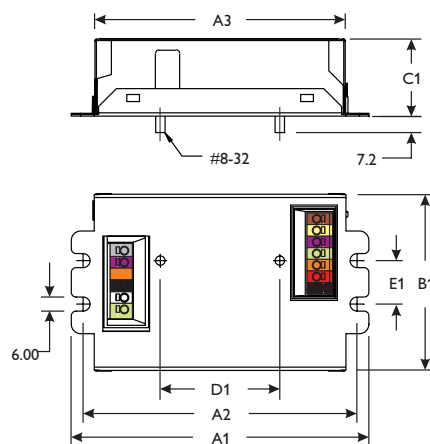
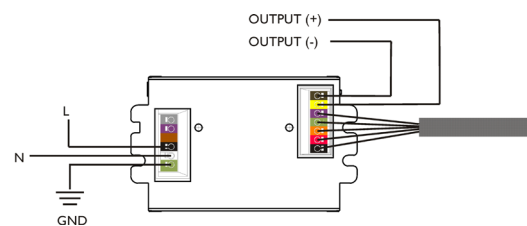

1.5N-m recommended torque for stud mounting

Light technical design

Fortimo LED Downlight Modules address the issue of binning

High-quality LED light is achieved by mixing the light of various LEDs and applying a special phosphor technology remotely from the LEDs. High-quality white light is characterized by a good color consistency and a color rendering of >80, popular CCTs in general lighting applications of 3000K and 4000K. The mixing chamber ensures perfectly mixed light, resulting in uniform colors and good color consistency. In addition to facilitating high efficiencies, the remote phosphor technology makes it relatively easy to develop virtually any fluorescent color. The function of the diffuser is to shape the light distribution, resulting in a lambertian beam. You have the freedom to design your own secondary optics. The LED module integrates easy mounting options for secondary optics. The overall dimensions of the LED module are optimized for lumen packages varying from 1100 to 3000 lumens.

Note that the optical parameters included in this guide such as colorpoints x and y, CRI and luminous flux etc. are measured in an integrating sphere.

Color consistency Standard Deviation Color Matching (SDCM)

The current specification of the Fortimo modules for color consistency is 3 SDCM @ 0-hours and 4 SDCM @ 10,000 hours. The value 3 refers to the size of an ellipse around the black body locus. Staying within this ellipse results in a consistency of light whereby there is no perceivable difference from one luminaire to another. This really demonstrates the unique quality of the remote phosphor concept.

Starting characteristics

The Fortimo modules can be switched on in milliseconds, which is a general characteristic of LEDs. Thanks to the dimmable driver, the light can be switched on at a dimming level between 5% to 100% in milliseconds.

Lumen maintenance

When used within specification ($T_c < 80^\circ \text{C}$, $T_a = 45^\circ \text{C}$), a minimum lumen maintenance of 70% at 50,000 hours is expected for Fortimo LED DLM (L70B50 @ 50,000 hours).

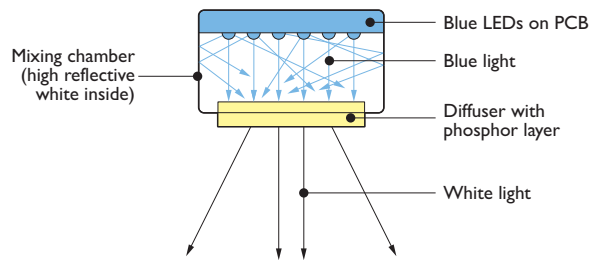

Figure 9. Mixing chamber in Fortimo LED Downlight Module enabling uniform white light

Minimum and maximum flux per type

	Min flux	Typical flux	Max flux
DLM 1100 10W/827 UL Gen 4	990	1100	1320
DLM 1100 10W/830 UL Gen 4	990	1100	1320
DLM 1100 10W/835 UL Gen 4	990	1100	1320
DLM 1100 9W/840 UL Gen 4	990	1100	1320
DLM 1500 16W/827 UL Gen 4	1350	1500	1800
DLM 1500 15W/830 UL Gen 4	1350	1500	1800
DLM 1500 14W/835 UL Gen 4	1350	1500	1800
DLM 1500 13W/840 UL Gen 4	1350	1500	1800
DLM 2000 22W/827 UL Gen 4	1800	2000	2400
DLM 2000 21W/830 UL Gen 4	1800	2000	2400
DLM 2000 20W/835 UL Gen 4	1800	2000	2400
DLM 2000 19W/840 UL Gen 4	1800	2000	2400
DLM 3000 34W/827 UL Gen 4	2700	3000	3600
DLM 3000 32W/830 UL Gen 4	2700	3000	3600
DLM 3000 30W/835 UL Gen 4	2700	3000	3600
DLM 3000 29W/840 UL Gen 4	2700	3000	3600

Table 5. Minimum and maximum flux per type

Thermal model

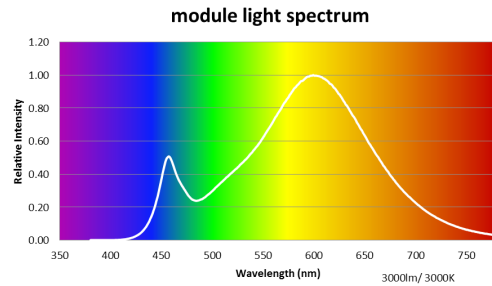

Figure 10. Spectral light distribution Fortimo LED DLM Gen 4 3000K

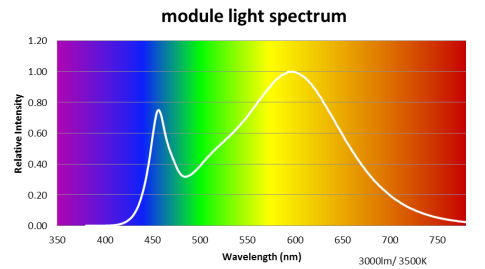

Figure 11. Spectral light distribution Fortimo LED DLM Gen 4 3200K

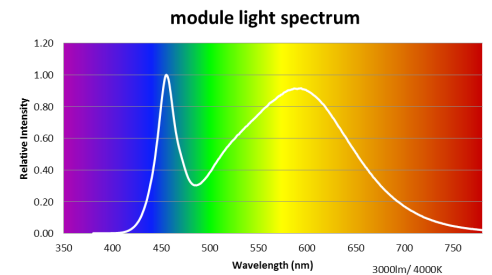

Figure 12. Spectral light distribution Fortimo LED DLM Gen 4 4000K

Luminaire : DLM 1100 lm beam flux
 Lamp : 1 x DLM module
 Lampflux : 1 x 1100 lm
 Measurement code : DLM
 L.O.R. : 1.00

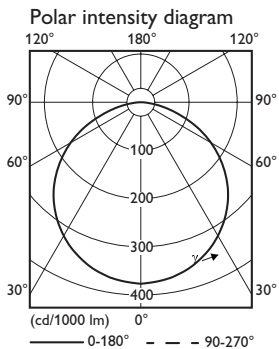

Figure 13. Light distribution diagram

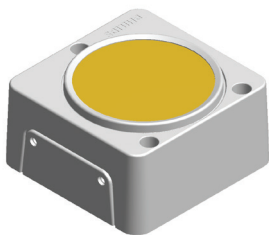

Figure 14. Fortimo LED Downlight Module

Secondary optics

The Fortimo LED Downlight Module generates a lambertian beam shape (see light distribution diagram) which is a pragmatic starting point for secondary optic design. The secondary optic design should not cover the exit aperture. Ray-set files are available via the website

http://www.lighting.philips.com/us_en/connect/LED_modules/dlm_downlight.wpd

The luminaire manufacturer must ensure that the temperature of the yellow diffuser does not exceed 125° C. The temperature of this light exit window can be measured using infra red temperature sensing technology.³ In order to achieve this we recommend that a lens or diffuser is not placed within 70mm of the Fortimo light exit window.

On the top of the Fortimo LED Downlight Module there are mounting options (rim of diffuser and three mounting holes) for positioning secondary optics.

Companies supplying reflectors for secondary optics

Secondary optics are not part of the Fortimo LED Downlight Module System offering. This is an added value area for OEMs. Meanwhile, a complementary reflector business has developed around the Fortimo LED Downlight Module. The table below gives a list of complementary partners offering compatible reflectors for Fortimo LED Downlight Module modules.

The following are examples of reflector suppliers that have products available to be used with the Fortimo LED Downlight Module System. Reference to these products does not mean they are endorsed by Philips for use with the Fortimo LED Downlight Module System. Philips gives no warranties regarding the use of these products in connection with the Fortimo LED Downlight Module System products and assumes no legal liability or responsibility for any loss or damage resulting from the use of this information, which is given on an “as-is” basis.

Complementary reflector partner		Status
Alux Luxar	www.alux-luxar.de	Released
Jordan	www.jordan-reflektoren.d	Released
NATA	www.nata.cn	Released
ACL	www.reflektor.de	Released
ALMECO	www.almecogroup.com	Released

Table 6. Complementary reflector partners

Mechanical design

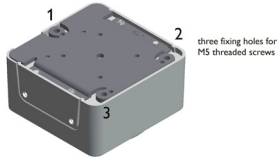

Figure 15. Fortimo LED Downlight Module

About the Fortimo LED Downlight Module

The module consists of the following main components:

- PCB with LEDs
- Heat spreader
- Mixing chamber
- Diffuser with remote phosphor technology

Mechanical fixation

The screw holes (M4 threaded) on the side can be used to fix reflectors. The maximum load per screw is 5N with maximum weight of 500gr and the total maximum load applied on the side fixation holes is 20N with maximum weight of 2000gr.

Recommended screw type

From the top of the module to heat sink: M4 Socket Head Cap Screw. From heat sink to module: M5 metric screw. The recommended torque on the M4 and M5 screws is 4Nm. Advice: Do not screw into the top of the module.

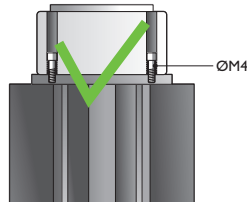

Figure 16. NEED CAPTION.

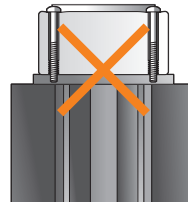

Figure 17. NEED CAPTION.

Below you will find two examples of possible ways to fix the heat sink to the module. Note that when fixing the module to the heatsink from the top, M4 thread is used, while M5 thread is used when fixing from the bottom of the module.

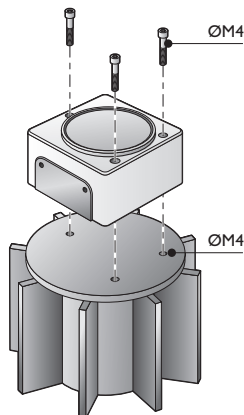

Figure 18. Heat sink, fixation through the module.

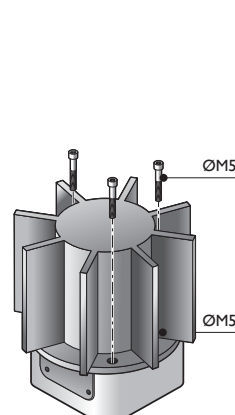

Figure 19. Heat sink, fixation via the heat sink.

Thermal management

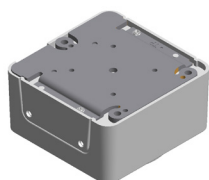

Figure 20. Temperature test point Tc
(Do not measure inside the central hole, but around it)

The critical thermal management points for the LED module are set out in this chapter in order to facilitate the design-in of Fortimo LED Downlight Modules. If these thermal points are taken into account, this will help to ensure optimum performance and lifetime of the LED system.

Optimum performance

To help ensure optimum performance, the Fortimo LED DLM Gen 4 Modules must operate within specified performance temperature limit of 80° C. Note that the maximum Tc value for the Fortimo LED DLM Gen 4 is 15° C higher than for the Fortimo LED DLM Gen 3, allowing much more compact and costeffective heat sinks to be used or to be operated at a high fixture ambient temperature.

Test requirements

Measurements, e.g. of temperature, luminous flux and power, are reliable once the luminaire is thermally stable, which may take between 0.5 and 2 hours. The time depends on the thermal capacity of the luminaire (see also the relevant clauses in UL1598). Measurements must be performed using thermocouples that are firmly glued to the surface (and not, for example, secured with adhesive tape).

Critical measurement points

Because LEDs are temperature sensitive, LED modules require a different approach with respect to the maximum permissible component temperature. This is different from most other types of light sources. For LEDs the junction temperature is the critical factor for operation. Since there is a direct relation between the case temperature and the LED junction temperature, it is sufficient to measure the aluminum casing of the LED module at its critical point. The critical point is on the rear surface of the LED module, as shown in the figure on the left. If the case temperature (Tc) at the critical measurement point exceeds the recommended maximum temperature, the performance of the LEDs will be adversely affected, for example in terms of light output, lifetime or lumen maintenance.

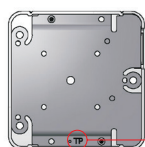

Tp measurement point

Figure 21. Tp temperature measurement point



Warning: Case temperature and thermal circuit

The maximum Tc on the rear surface of the LED module has been defined to ensure the performance of the Fortimo LED Downlight Module System. At this case temperature the proper junction temperature of the LEDs is assured and the performance specified (lifetime, light output, lumen maintenance, etc.) will be met over life of the product. Above Tc = 80°C, a thermal circuit in the LED driver will be activated that will dim the LED module to limit the temperature raise. The thermal circuit is intended to protect the module under abnormal condition but NOT the lifetime of the module.

Fixture design using Safety Related Electronic Circuit

The system of Fortimo DLM Gen 4 with approved Xitanium drivers mentioned in this document qualifies for UL Safety Related Electronic Circuit program as prescribed by UL 991 and CSA 22.2 0.8.

This program allows the Fortimo DLM Gen 4 system to be installed as a replacement for the thermal protector as described in UL 1598 section 11.5 titled Thermal Protectors.

The OEM can use the thermal protection circuit when testing the luminaire for compliance to UL 1598 for temperature tests. The Fortimo DLM Gen 4 system will ensure that the luminaire will stay below 90°C surface temperature.

Thermal Interface Material

The function of a Thermal Interface Material is to reduce thermal impedance between the LED module and the heat sink. The Thermal Interface Material replaces air, which is a thermal insulator, by filling the gaps with material that has better thermal conductivity. This is shown schematically in the figure on the left. Philips recommends to always use a Thermal Interface Material.

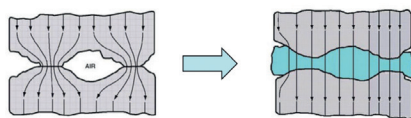

Figure 22. The working principle of Thermal Interface Material

In general:

- Thermal paste performs better than thermal pads.
- The lower the thermal impedance the better.
- The thinner the TIM the better, restriction is the surface flatness.

The following are suggestions for thermal interface material products that can be used with the Fortimo LED DLM System.

Reference to these products does not mean they are endorsed by Philips for use with the Fortimo LED Downlight Module System. Philips gives no warranties regarding the use of these products in connection with the Fortimo LED Downlight Module System products and assumes no legal liability or responsibility for any loss or damage resulting from the use of this information, which is given on an “as-is” basis.

Thermal Interface Partners	
Laird Technologies	www.lairdtech.com
The Bergquist Company	www.bergquistcompany.com

Table 7. Thermal Interface partners

Electrical and thermal analogy

Standard static thermal situations can be modeled using ‘thermal resistances.’ These resistances behave like electrical resistances. The analogy between electrical and thermal resistances is explained in the figure entitled ‘Electrical and thermal analogy’ below. The electrical units are shown on the left, while the thermal equivalents are given on the right. With a known voltage difference at a certain current it is possible to calculate the electrical resistance using Ohm’s law. The same applies for a thermal resistance. If the temperature difference and the thermal power are known, the thermal resistance can be calculated using the thermal Ohm’s law.

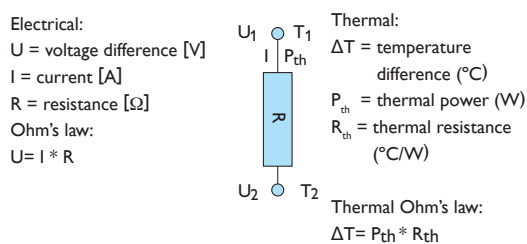

Figure 23. Electrical and thermal analogy

Thermal model

A thermal model that can be used to determine the required thermal performance of the cooling solution for the LED module is shown in the figure below.

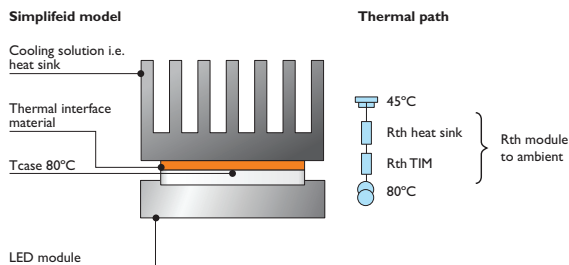

Figure 24. NEED CAPTION

Thermal design of a heat sink

The table on page 20 shows the required thermal resistance (Rth) of the heat sink and TIM for various ambient temperatures, using the maximum permitted LED module power. With these Rth’s, the Tc of the module will stay below the maximum Tcase at the ambient temperature stated.



Warning

The maximum temperature difference between Tc and Tambient should never exceed 35°C for Fortimo DLM Gen 4, otherwise it could lead to a reduction in the lifetime of the system.

Thermal resistance in relation to ambient temperature

DLM Gen 4 thermal power	1100/827	1100/830	1100/835	1100/840	1500/827	1500/830	1500/835	1500/840
Max thermal Power (W)	4.9	4.7	4.6	4.2	7.8	7.3	6.7	6.2

DLM Gen 4 thermal power	2000/827	2000/830	2000/835	2000/840	3000/827	3000/830	3000/835	3000/840
Max thermal Power (W)	12.3	11.3	10.7	10.1	18.5	17.5	16.2	15.6

DLM Gen 4 required Rth's @ Tc = 80°C	1100/827	1100/830	1100/835	1100/840	1500/827	1500/830	1500/835	1500/840
Ambient temperature								
45°C	<7.2	<7.5	<7.6	<8.4	<4.5	<4.8	<5.2	<5.6

DLM Gen 4 required Rth's @ Tc = 80°C	2000/827	2000/830	2000/835	2000/840	3000/827	3000/830	3000/835	3000/840
Ambient temperature								
45°C	<2.9	<3.1	<3.3	<3.5	<1.9	<2.0	<2.2	<2.2

Table 8. Thermal resistance in relation to ambient temperature

Passive cooling

Passive cooling systems are based on the fact that hot air moves upwards, thus creating an airflow along the surfaces. This is called natural convection. There are many standard heat sinks available, but it is also possible to design your own heat sink. In general, a passive cooling solution requires a larger heat sink than an active cooling solution.

Design guidelines for passive cooling

Before starting to perform any calculations, an important point to consider is the airflow. In general hot air moves upwards at a relatively low speed. The shape and position of the heat sink will affect the airflow. Ideally, the fins should be parallel to the direction of airflow. Closure of the top of the profile will reduce the cooling capacity of the heat sink and should therefore be avoided during design and installation.

Some additional design guidelines for passive cooling include:

- Limit the number of thermal interfaces in the thermal path from module to ambient.
- Thick fins conduct heat better than thin fins.
- Large spacing between fins is better than small spacing between fins, air flowing the path with least resistance.
- Make cooling surfaces more effective by using proper conductive materials, appropriate thickness and correct fin orientation.
- Thermal radiation plays a significant role / anodized or powder-coated surfaces are preferable to blank surfaces.

Complementary thermal solution partners

Thermal solutions do not form part of the Fortimo LED Downlight Module System offering. This is an added-value area for OEMs, offering the possibility to differentiate. However, there are many thermal solution companies who have a standard portfolio of compatible heat sinks available, enabling quick and easy luminaire creation. The table below gives a list of complementary partners offering compatible cooling systems for Fortimo LED Downlight Modules.

The following are examples of providers of cooling solutions that can be used with the Fortimo LED DLM system.

Reference to these products does not mean they are endorsed by Philips for use with the Fortimo LED Downlight Module System. Philips gives no warranties regarding the use of these products in connection with the Fortimo LED Downlight Module System products and assumes no legal liability or responsibility for any loss or damage resulting from the use of this information, which is given on an “as-is” basis.

Complementary heat sink partner		Heat sink type	Status
AVC	www.avc.com.tw	Active + passive	Released
Nuventix	www.nuventix.com	Active + passive	Released
Wisefull	www.wisefull.com	Active + passive	Released
Frigodynamics	www.frigodynamics.com	APassive	Released
Sunon	www.sunon.com	Active + passive	Released

Table 9. Complementary heat sink partner

Electrical design

Wiring

Connection to the mains supply/protective earth. The mains supply has to be connected to the power supply.

Class 2

In a Class 2 product the driver design is such that in the event of single fault conditions the mains cannot come into electrical contact with the electrically conductive parts of the luminaire. As the maximum voltage of the Fortimo LED Downlight Module is below 60 V, it complies with the rules governing UL1310 driver and is therefore safe to touch.

Active cooling power supply with 12V

Xitanium LED 50W Driver with 12V output can be used with the following option:

- Active cooling of Nuventix SynJet (Universal) DLM coolers or other 12 V operating fans.

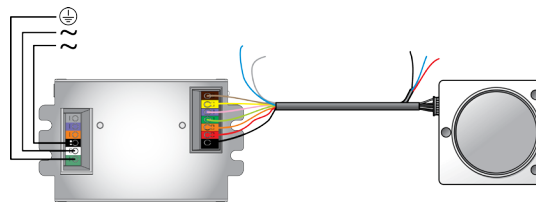

Figure 25. Schematic wiring diagram with protective earth of 50W driver

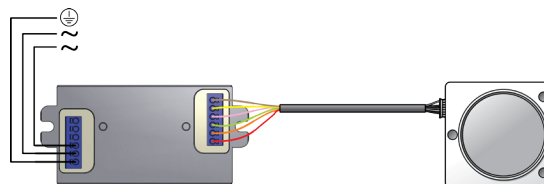

Figure 26. Schematic wiring diagram with protective earth of 25W/36W driver

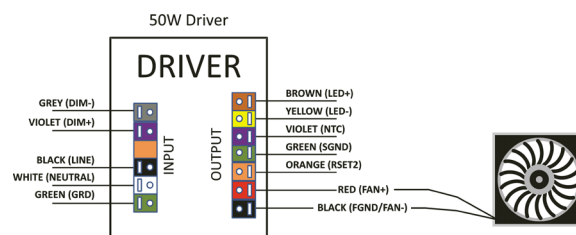

Figure 27. NEED CAPTION

Substitution of Gen 3 System with Gen 4 System

Mechanical difference between Fortimo Downlight Modules Gen 3 systems and Gen 4 systems Guiding holes diameter change

Housing change

Top View

Gen 3

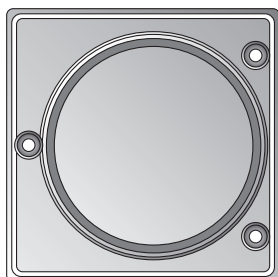

- Guiding holes $\text{\O}7$ mm
- Fit for M4

Gen 4

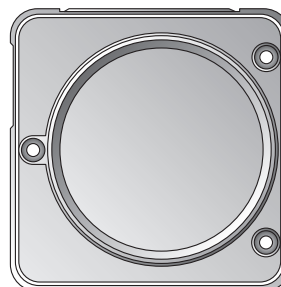

- Guiding holes $\text{\O}8$ mm
- Fit for M4 (Socket Head Cap Screw)

Bottom View

Gen 3

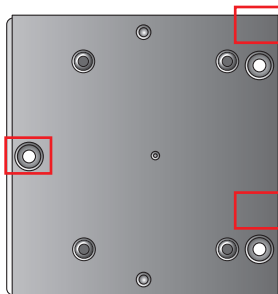

- 3xM5 bottom-up mounting

Gen 4

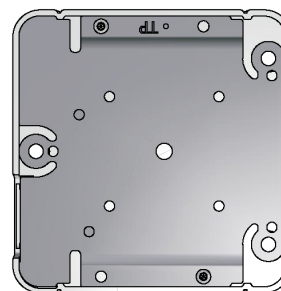

- Also 3xM5 bottom-up mounting
- Removal of red circled holes

Connector position change

Top View

Gen 3

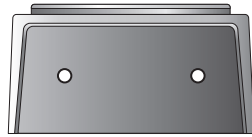

- Side aluminum
- Side mounting holes M4
- Side cooling feasible

Gen 4



- Full metal housing
- Side mounting holes M4
- No side cooling possible

Bottom View

Gen 3

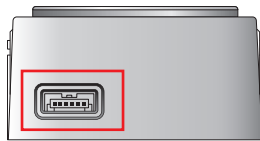

- Connector depth = 6.3 mm
- Connector height = 15.4 mm

Gen 4

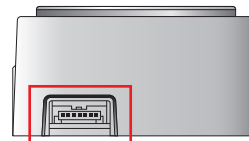

- Connector depth = 2.7 mm
- Connector height = 10.5 mm

Approbation

Module:

Cat. No. Downlight Modules Gen 4 series may represent Cat. No. Downlight Modules series LED Module Series DLMxxxx yyW/zccUL (Gen 3, volume 1 Section 1), report dated 2010-03-11, without additional endproduct normal temperature testing provided that:

- a) The wattage for the Downlight Modules Gen 4 is the same lower than the wattage of the originally end-product tested Downlight Modules Gen 3,
- b) only the bottom heat spreader is used for cooling and
- c) end product thermal management construction is not reduced.

Approved drivers for the system:

(1) XI025C100V036DNMX and XI025C100V045DNM1 can be used in place of the following drivers without additional end application testing.

XI025C100V036DNM1
XI050C100V054XPL1
XR050C100V054XPM1 → XI025C100V036DNMX and XI025C100V045DNM1
XV050C100V054DPM1
XI025C100V036XPL1

(2) XI050C100V054DNMX can be used in place of the following drivers without additional end application testing.

XI050C100V054DNM1
XR050C100V054XPM1 → XI050C100V054DNMX
XV050C100V054DPM1

Norms and Standards

Fortimo LED Downlight Modules together with Xitanium LED Drivers comply with following norms and standards:

Safety

UL8750/CSA C22.2 250-13 NA	LED modules for general lighting - safety specifications Photobiological safety of lamps and lamp systems
UL1310/UL8750/CSA c22.2 no. 223	Control gear safety

Safety Related Electronic Circuit

UL991/CSA C22.2 No. 0.8-09	Tests for Safety Related Controls Employing Solid State Safety functions incorporating electronic technology. To comply to this standard, both modules and drivers need to carry the additional UL mark for UL SREC
----------------------------	------------------------------------------------------------------------------------------------------------------------------------------------------------------------------------------------------------------------------



Performance

UL8750/SSL 7 Control gear performance

Electromagnetic compatibility (tested with Fortimo LED DLM, cable and Xitanium LED driver)

FCC47 subpart 15 Class A Limits and methods of measurement of radio disturbance characteristics of electrical lighting and similar equipment

FCC47 subpart 15 Class A Equipment for general lighting purposes - EMC immunity requirements

ANSI C82.77 Limits for harmonic current emissions (equipment input current <16 A per phase)

Environmental

The product is compliant with European Directive 2002/95/EC of January 2003 on Restriction of the Use of Certain Hazardous Substances in Electrical and Electronic Equipment (RoHS).⁴

Approval

CSA/cURus

Chemical compatibility

The Fortimo DLM makes use of LEDs containing a silver-finished (Ag) Lead frame. The lead frame finish is sensitive to pollution and or corrosion when exposed to Oxygen and certain Volatile Organic Components [VOCs]. Examples of VOCs are substances containing Sulfur or Chlorine. In that case parts of the lead frame may blacken, which will impair the lumen output or the color point of the LEDlight. Materials that are known to have a higher risk to be a source of Sulfur and Chlorine are for example rubbers used for cables & cable entries, sealing's or corrugated carton. Also do NOT use adhesives, cleaning agents, coatings containing suspect VOCs. Nor use the product in aggressive (corrosive) environments that may cause damage to the LED's.

We recommend ensuring that the direct environment of these LEDs in the luminaire does not contain materials that can be a source of Sulfur or Chlorine, for optimal reliability of the LED, LED module and/or LED luminaire. Furthermore, make sure that the products with these LEDs are not stored or used in vicinity of sources of Sulfur or Chlorine, and the production environment is also free of these materials. Also avoid cleaning of the LED products with these types of LEDs with abrasive substances, brushes or organic solvents like Acetone and TCE.

Applications of the product in industry and heavy traffic environment should be avoided in case of risk of ingress of Sulfur and Chlorine from the environment.

A list of chemicals, often found in electronics and construction materials for luminaires that should be avoided, is provided in the table below. Note that Philips does not warrant that this list is exhaustive since it is impossible to determine all chemicals that may affect LED performance. These chemicals may not be directly used in the final products but some of them may be used in intermediate manufacturing steps (e.g. cleaning agents). Consequently, trace amounts of these chemicals may remain on (sub) components, such as heat sinks. It is recommended to take precautions when designing your application.

In case of questions on compatibility of materials or applications of the product please contact your Philips representative for application support.

Chemical Name	Type
Acetic Acid	acid
Hydrochloric Acid	acid
Nitric Acid	acid
Sulfuric Acid	acid
Ammonia	alkali
Sodium Hydroxide	alkali
Potassium Hydroxide	alkali
Acetone	solvent
Benzene	solvent
Dichloromethane	solvent
Gasoline	solvent
MEK (Methyl Ethyl Ketone)	solvent
MIBK (Methyl Isobutyl Ketone)	solvent
Mineral Spirits (Turpentine)	solvent
Tetracholorometane	solvent
Toluene	solvent
Xylene	solvent
Castor Oil	oil
Lard	oil
Linseed Oil	oil
Petroleum	oil
Silicone Oil	oil
Halogenated Hydrocarbons (containing F, Cl, Br elements)	misc
Rosin Flux	solder flux
Acrylic Tape	adhesive
Cyanoacrylate	adhesive

Table 10. Chemical List

UV and other hazards

PET value	>100 hrs /Klux (zero UV)
Damage factor	0.08 @ 4100 K
IR (infrared) radiation	As well as being free of UV radiation, the LED modules are also free of infrared radiation in the beam.

Hazard Category	Emission Limit
LB	Low (Risk Group 1)
LR	Exempt ⁵
LIR	Exempt
ES	Exempt
EUVA	Exempt
EB	Exempt
EIR	Exempt

Table 11. Emission limit

IEC recommendations

The general recommendations for luminaire design given by the IEC (IEC 60598) and the national safety regulations are also applicable to LED-based luminaires.



Warning

Photobiological safety is not assured if the Fortimo LED Downlight Module is lit up without the cover. Direct exposure to the blue LED light is dangerous for the eyes.

Photobiological safety aspects

As of March 2007, LEDs and LED-based products for general lighting are no longer included in the scope of the Eye Safety standard for lasers, IEC 60825-1 “Safety of laser products.” The new lamp standard, IEC 62471 “Photobiological safety of lamps and lamp systems,” which covers incoherent light sources, now applies. This international standard gives guidance on evaluating the photobiological safety of lamps and lamp systems including luminaires. It specifically defines the exposure limits, reference measurement technique and classification scheme for the evaluation and control of photobiological hazards from all electrically powered incoherent broadband sources of optical radiation, including LEDs but excluding lasers, in the wavelength range from 200nm to 3000nm.

In the photobiological safety standard, hazard categories are defined as follows:

Radiance-based

- Blue Light LB 300 – 700 nm
- Retinal Thermal LR 380 – 1400 nm
- Retinal Thermal
Weak Stimulus LIR 780 – 1400 nm

Irradiance-based

- Actinic UV Skin
& Eye ES 200 – 400 nm
- Eye UVA EUVA 315 – 400 nm
- Blue Light
Small Sources EB 300 – 700 nm
- Eye IR EIR 780 – 3000 nm

Fortimo LED DLM gave the following results

The following should be taken into account:

- The effective radiance measurement for Blue Light (LB) modules is “Low,” meaning that the LED modules are categorized in Risk Group 1. For the 2000 lumen version the permitted exposure time for Blue Light radiance (relevant when looking into the source) is limited to 1.5 hours, while for the 1100 lumen version it is 3 hours. Because of the Law of Conservation of Radiance, integration of the LED module into a luminaire results in either the same radiance or a reduced radiance. Final assessment of the luminaire is recommended.
- The measured irradiance-based values (E) for the categorized hazards are all within the exempt group (both 1100 and 2000 lumen versions).
- In general the permitted exposure time for irradiance is limited when in the “low,” “moderate” or “high” risk group. Limiting the exposure time and/or the distance to the source can reduce the hazard level. However, for the measured LED modules no special precautions are necessary because they are ranked in the exempt group. Final assessment of the luminaire (including e.g. secondary optics) is recommended.

Humidity

The LED Driver is suitable for use in “Dry” and “Damp” Locations.

Exposure to direct sunlight

Exposure to direct sunlight during operation may have severe temperature or UV effects. Where this situation is likely, extensive temperature testing is recommended.

Vibration and shocks

Shock resistance: 50g @ 6ms semi-sinusoidal. Vibration resistance: sweep 50-150 Hz, one hour at resonance frequency (all 3 axes) without failure.

Philips Fortimo LED Downlight Module systems are to be used for indoor applications

When used in a non-weather protected environment, additional measures shall be taken to protect the Fortimo LED Modules and LED drivers from water ingress.

End-of-life behavior

Unlike typical conventional light sources, LEDs are not subject to sudden failure or burnout.

There is no time at which the light source will cease to function. Instead, the performance of LEDs shows gradual degradation over time. When used according to specification, Fortimo LED Downlight Modules are predicted to deliver an average of 70% of their initial intensity after 50,000 hours of operation.²

The LEDs in the Fortimo LED Downlight Modules are connected in series. If one LED fails, this may be due to an internal short-circuit (feature of blue LEDs). In this case it will still conduct current, so that the other LEDs will continue to operate.

Fortimo Downlight Modules system disposal

We recommend that the Fortimo LED DLM or its components are disposed of in an appropriate manner at the end of their (economic) lifetime. The modules are essentially normal pieces of electronic equipment containing components that at present are not considered to be harmful to the environment and can be disposed of with normal care. We therefore recommend that these parts are disposed of as normal electronic waste, in accordance with local regulations.

Contact details

Philips

Product information www.philips.com/ledmodulesna

Or contact your local Philips sales representative

Partners for cooling solutions

Complementary Heat Sink Partner	Heat sink type
Sunon (www.sunon.com)	Active + passive
AVC (www.avc.com.tw)	Active + passive
MechaTronix (www.mechatronix-asia.com)	Active + passive
Nuventix (www.nuventix.com)	Active + passive
Wisefull (www.wisefull.com)	Active + passive

Table 12. Partners for Cooling Solutions

Partners for reflector solutions

Alux Luxar	www.alux-luxar.de
Jordan	www.jordan-reflektoren.de
NATA	www.nata.cn
ACL	www.reflektor.de
Almecog	www.almecogroup.com
Widegerm	www.widegerm.com.hk

Table 13. Partners for Reflector Solutions

Partners for thermal interface materials

Thermal Interface Partners

Laird Technologies	www.lairdtech.com
The Bergquist Company	www.bergquistcompany.com

Table 14. Partners for Thermal Interface Materials

Index of visuals

A simplified model of the thermal path from LED module to ambient	19	Temperature test point Tc	17
Dimensions Fortimo LED downlight module Gen 4	8	Temperature test point Tc ø 1 cm	17
Electrical and thermal analogy	19	The working principle of Thermal Interface Material	18
Fixing holes at the module to screw the heat sink	16	Tp measurement point	17
Fortimo LED downlight module	5	Tp temperature measurement point	18
Fortimo LED downlight module with Xitanium LED driver	5	Xitanium emergency kit	7
Fortimo LED downlight module with Xitanium LED independent driver	5	Xitanium LED driver 25W/36W	6
Heat sink, fixation through the module	16	Xitanium LED driver 50W	6
Heat sink, fixation via the heat sink	16		
LED DLM cable 50cm for 50W driver	6		
LED DLM cable 84cm for 50W driver	6		
Light distribution diagram	14		
Mixing chamber in Fortimo LED DLM enabling uniform white light	12		
Schematic wiring diagram	22		
Spectral light distribution Fortimo LED DLM Gen 4 3000K	14		
Spectral light distribution Fortimo LED DLM Gen 4 3500K	14		
Spectral light distribution Fortimo LED DLM Gen 4 4000K	14		

Abbreviations

AM	Amplitude	RF	Radio Frequency
AWG	American Wire Gauge	RoHS	Restriction of Hazardous Substances
CISPR	Comité International Spécial des Perturbations Radioélectriques (Special International Committee on Radio Interference)	RTI	Relative Temperature Index
CRS	Customer Requirements Specification	SDCM	Standard Deviation of Color Matching
CSA	Canadian Standards Association	SLM	Spot Lighting Module
EC	European Community	SREC	Safety Related Electronic Circuit
EMC	Electromagnetic Compatibility	Tcase	Temperature; at center of back of module
EP	European Parliament	TIM	Thermal Interface Material
FCC	Federal Communications Commission	UL	Underwriters Laboratory
FR	Flame Retardant	NA	Not Applicable
IEC	International Electrotechnical Commission		
IP	Ingress Protection		
ISO	Organisation Internationale de Normalisation (International Organization for Standardization)		
LED	Light Emitting Diode		
NTC	Negative Temperature Coefficient		
PCB	Printed Circuit Board		
PCE	Power Conversion Efficiency		
PWM	Pulse Width Modulation		

Footnotes

1. Fortimo LED DLM 1100/840 (Gen 3 91 lm/W, Gen 4 120 lm/W module efficacy).
2. Average rated life is based on engineering data testing and probability analysis. The hours are at the B50, L70 point – 50,000 hours life with 70% lumen maintenance at Tc point of 80° C. Temperature rise from maximum fixture ambient to Tc point should be no higher than 35° C.
3. Typical settings for infra red temperature sensing are a minimum resolution of 1 mm² per pixel, using an emissivity of 0.95 for the yellow diffuser.
4. Restrictions on Hazardous Substances (RoHS) is a European directive (2002/95/EC) designed to limit the content of 6 substances [lead, mercury, cadmium, hexavalent chromium, polybrominated biphenyls (PBB), and polybrominated diphenyl ethers (PBDE)] in electrical and electronic products. For products used in North America compliance to RoHS is voluntary and self-certified.
5. Exempt means 'no risk'.

Disclaimer

The information in this guide is accurate at the time of writing. This guide is provided “as is” without expressed or implied warranty of any kind. Neither Philips nor its agents assume any liability for inaccuracies in this guide or losses incurred by use or misuse of the information in this guide.

Philips will not be liable for any indirect, special, incidental or consequential damages (including damages for loss of business, loss of profits or the like), whether based on breach of contract, tort (including negligence), product liability or otherwise, even if Philips or its representatives have been advised of the possibility of such damages.



©2015 Koninklijke Philips N.V. All rights reserved. Philips reserves the right to make changes in specifications and/or to discontinue any product at any time without notice or obligation and will not be liable for any consequences resulting from the use of this publication.

PLT-1410DG 06/15 philips.com

Philips Lighting
North America Corporation
10275 W. Higgins Road
Rosemont IL 60018
Tel: 800-322-2086
Fax: 888-423-1882
Customer/Technical Service:
800-372-3331
OEM Support: 866-915-5886

Imported by: Philips Lighting,
A division of Philips Electronics Ltd.
281 Hillmount Rd,
Markham, ON, Canada L6C 2S3
Tel. 800-668-9008