

LEGENDS ULTIMATE

INSTRUCTION MANUAL

MODEL NO.: HA8800D, HA8800S



ATGAMES
www.atgames.net

INDEX

ASSEMBLY GUIDE	P 2
LEGENDS ULTIMATE FEATURES	P 6
QUICK START GUIDE	P 7
HOW TO PLAY GAMES VIA (ARCADENET™) AND (BYOG)	P 8
HOW TO UPDATE FIRMWARE	P 8
ARCADE PLAY LINK (APL)	P 8
FEATURED GAMES	P 9
SAFETY NOTICE, FCC STATEMENT, WARRANTY INFO	P 10

ASSEMBLY GUIDE

• TOOLS NEEDED

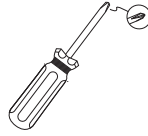

Phillips head screwdriver (not included)

PARTS

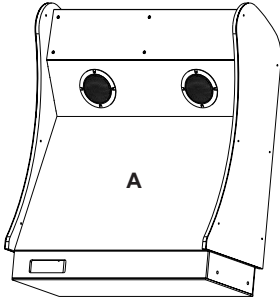

Cabinet top

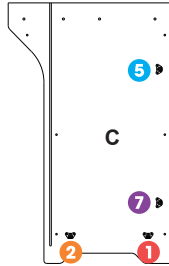

Left side panel

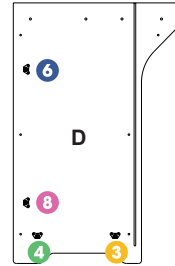

Right side panel

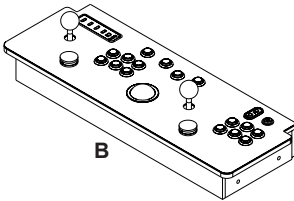

Control panel

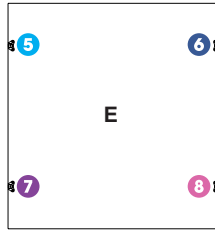

Back panel

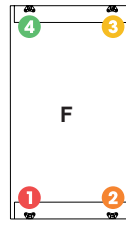

Bottom panel

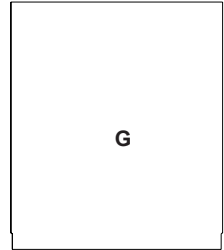

Front panel

SCREWS



Silver screw #S1 x8



Black screw #S2 x8

CORD

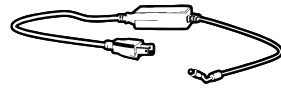

Power adapter

ANTI-TIPPING KIT



Plastic anchor x2



Screw #S3 x2



Screw #S4 x2

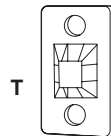

Bracket x2



Cable tie U

ASSEMBLY STEPS

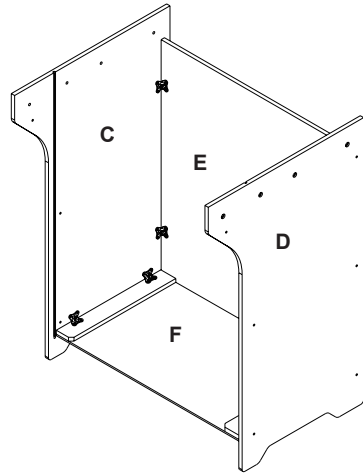
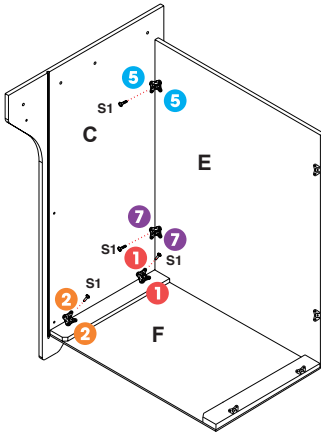

Step 1. Attach panels in the order of [C] > [E] > [F] > [D]. Or you can follow the sticker order to tighten the screws: 5 > 7 > 1 > 2 > 6 > 8 > 4 > 3.

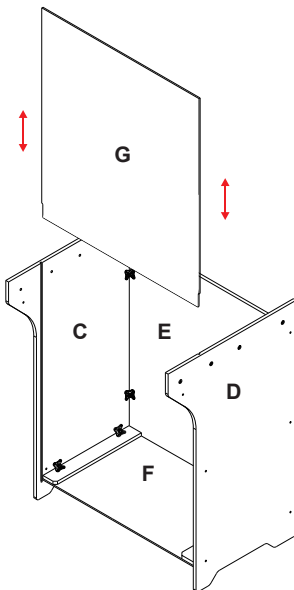

Step 2. Slide the front panel [G] into the tracks of panel [C] and [D].

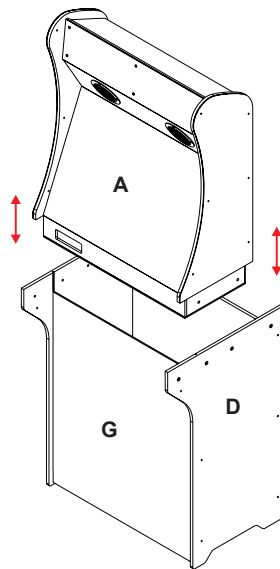

Step 3. Attach the cabinet top [A] to the bottom part of the cabinet.

ASSEMBLY STEPS

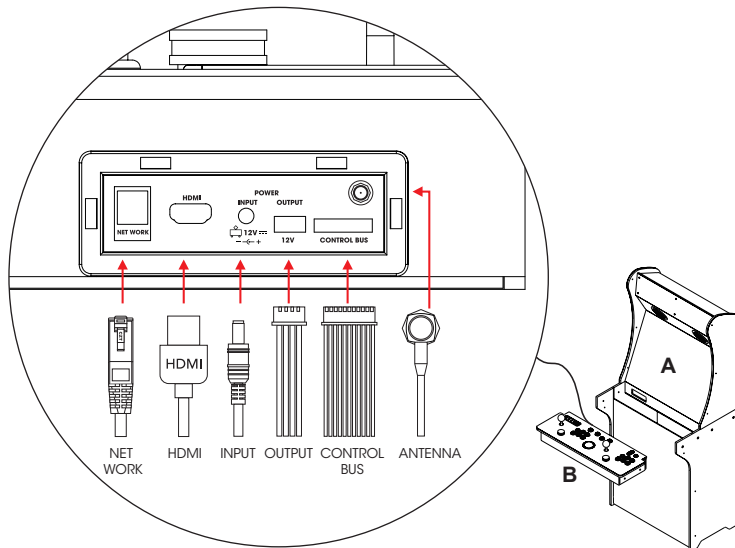

Step 4. Connect the cables to the matching slots on the control panel [B].

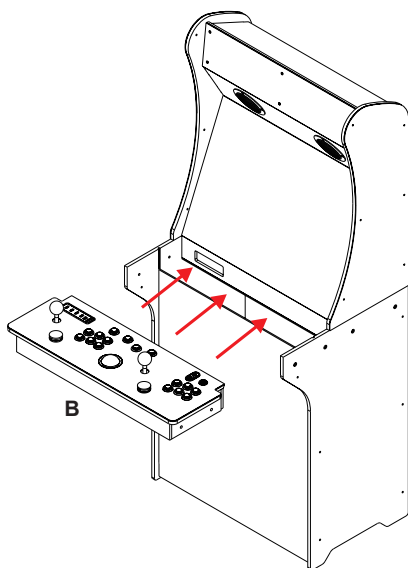

Step 5. Insert control panel to the front of the cabinet.

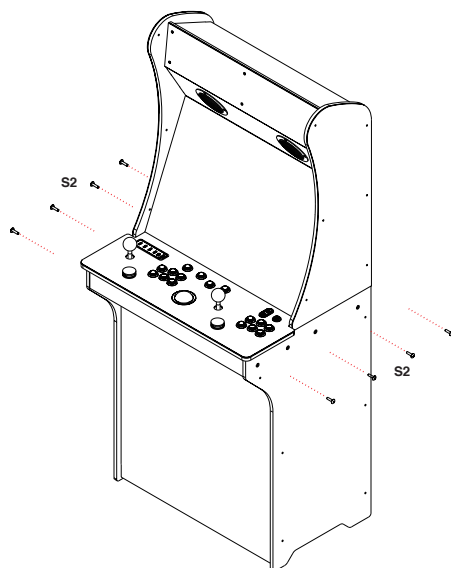

Step 6. Insert all 8 black screws [S2] and tighten.

ASSEMBLY STEPS

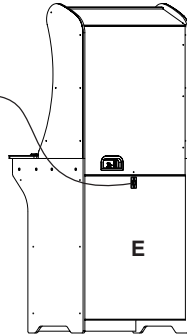
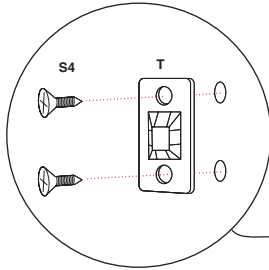

Step 7. Tighten screws [S4] on bracket [T] against the back panel [E].

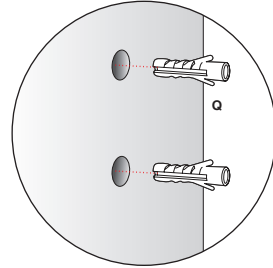

Step 8. Drill holes against the wall and insert plastic anchors [Q] into the holes firmly.

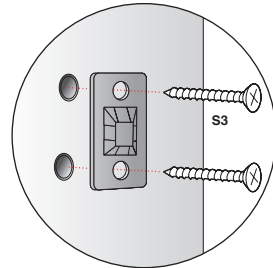

Step 9. Tighten screws [S3] on bracket [T] against the wall.

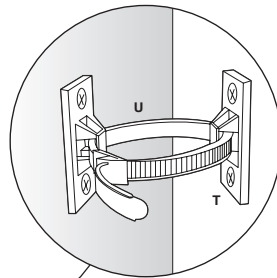
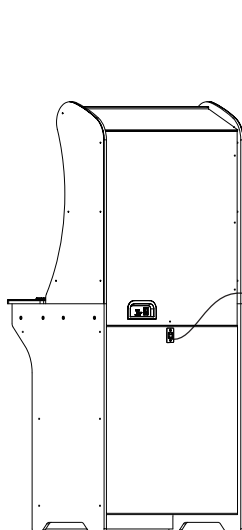

Step 10. Fasten the cable tie [U] to connect both [T]s to keep the cabinet from tipping over.



WARNING

Serious or fatal crushing injuries can occur from tip-over. To help prevent tip-over:

- Do not set any heavy objects on top of the cabinet.
- Never allow children to climb or hang on the cabinet.

Use of tip-over restraints may only reduce but not eliminate the risk of tip-over.

LEGENDS ULTIMATE FEATURES

• CONTROL DECK

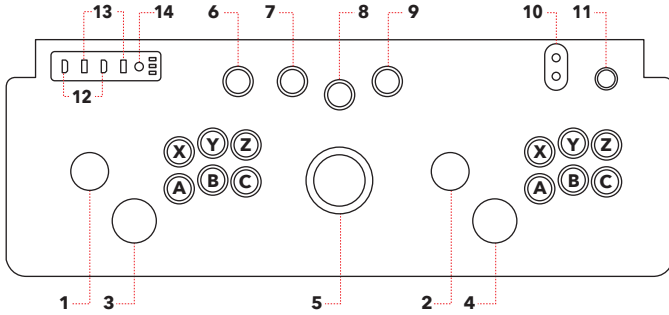

- | | |
|----------------|---------------------|
| 1. JOYSTICK P1 | 8. MENU |
| 2. JOYSTICK P2 | 9. START P2 |
| 3. SPINNER P1 | 10. VOLUME ADJUSTER |
| 4. SPINNER P2 | 11. POWER |
| 5. TRACKBALL | 12. HDMI PORT |
| 6. REWIND | 13. USB PORT |
| 7. START P1 | 14. HDMI SWITCH |

• FRONT

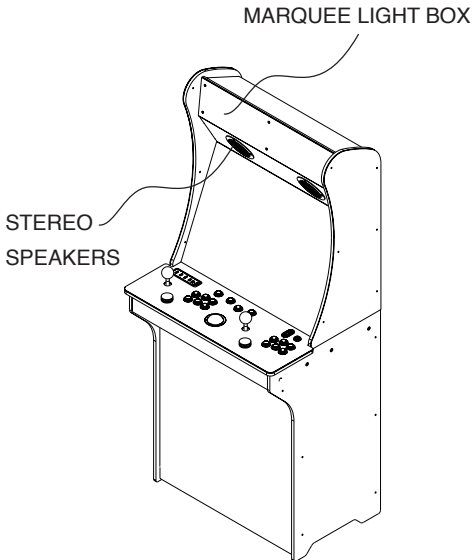

• REAR

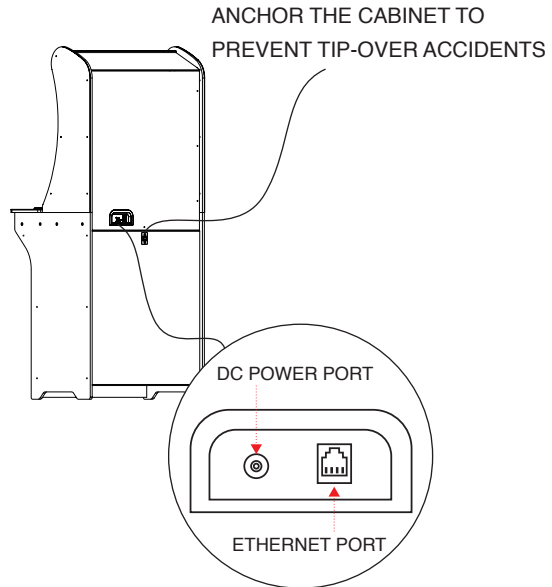

QUICK START GUIDE

All screenshots shown are for illustration purposes only. Actual screens may vary due to product enhancements.

1. Plug in AC adapter and press the Power button to turn on.
2. Move the P1 joystick and select from [Arcade] or [Console] to enjoy 350 pre-loaded games.
(Note: Internet connection is not required. The games can be played offline.)



3. To access the internet, connect an Ethernet Cable (not included) or go to [SETTINGS] to connect through Wi-Fi.
4. To connect Wi-Fi, press A to select [REFRESH WI-FI LIST] on [SETTINGS] page.



5. Select the Wi-Fi SSID you would like to connect to and press "A" at [PASSWORD] to key-in password with the keyboard shown on the screen, and then press "A" at [CONNECT].



6. After the internet is connected, an update message will pop up automatically. Please follow the instructions to update the firmware.



HOW TO PLAY GAMES VIA (ARCADENET™) AND (BYOG)

To access [ArcadeNet™] and [BYOG] for the very first time, please update the firmware. An internet connection is always required for [ArcadeNet™] and [BYOG]. Both services are powered by cloud gaming technology and stream to your arcade.

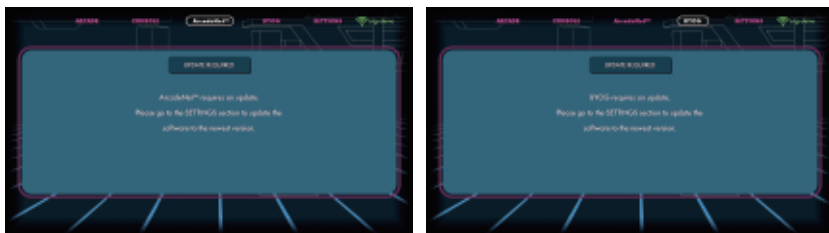

HOW TO UPDATE FIRMWARE

1. Power on the arcade machine.
2. Connect via Ethernet or Wi-Fi for internet connection.
3. After a short wait, a prompt will automatically display on the screen to notify you of the most recent firmware available on the server.
4. Select YES to start downloading firmware from the server. [Please make sure the internet connection is stable.]
5. Once the firmware has downloaded without any issue, the arcade machine will reboot and you will have access to update mode and the main menu.

Note: The system will auto-detect if the arcade machine is connected to the internet. Or you can simply go to the Settings menu and select [Check Version]. Follow the instructions to have the latest firmware updated. If you encounter any issues on firmware update, please contact: support@atgames.net

ARCADE PLAY LINK (APL)

How to connect AtGames Blast! Dongles and AtGames Consoles to Legends Ultimate*

Step 1

Plug the “Blast! dongle” or connect “AtGames console” with HDMI cable in the HDMI PORT (12.), and connect USB power cord.

Step 2

Press HDMI SWITCH (14.) button to switch to selected HDMI source.

Step 3

The Games Menu will display on the screen. Select the game you like and play!

*Legends Ultimate supports the following AtGames products:

2019: Legends Flashback (FB8660), Atari Flashback X (AR3060), Bandai Namco Arcade Blast! (WD3305), Adventure Flashback Blast! (WD3308), Star Flashback Blast! (WD3309).

2018: Activision Flashback Blast! (WD3301), Atari Flashback Blast! Vol.1 (WD3302), Atari Flashback Blast! Vol.2 (WD3303), Legends Flashback Blast! (WD3304), Bandai Namco Flashback Blast! (WD3306). For 2018 Blast!, please follow the instructions shown on the screen at SETTINGS to pair the dongle with Legends Ultimate.

FEATURED GAMES

Adventure
Aladdin
Asteroids
Asteroids Deluxe
Bad Dudes vs. Dragon Ninja
Black Widow
Bloody Wolf / Battle Rangers
Break Thru
BurgerTime
Burnin' Rubber
Centipede
Choplifter!
Crystal Castles
Donald in Maui Mallard
Express Raider / Western Express
Fighter's History Dynamite / Karnov's Revenge
Fix-It Felix, Jr.
Gravitar
Heavy Barrel
Joe & Mac 2: Lost in the tropics
Joe & Mac Returns
Joe & Mac: Caveman Ninja
Jumpman Junior
Karate Champ
Last Mission
Lock 'n' Chase
Lunar Lander
Magical Drop / Chain Reaction
Magical Drop III
Major Havoc
Millipede
Missile Command
Peter Pepper's Ice Cream Factory
Pong
Side Pocket
Super Breakout
Super Burger Time
Super Real Darwin
Super Star Wars
Super Star Wars: Return of the Jedi
Super Star Wars: The Empire Strikes Back
Tempest
Tetris
Tetris Plus 2
The Astyanax
The Jungle Book
The Lion King
Tron
Warlords
Yars' Return
And many more...

© 2019 Atari Interactive, Inc.

Atari and Atari logo are trademarks owned by Atari Interactive, Inc. All individual Atari game names and logos are trademarks or registered trademarks of Atari Interactive, Inc. or its affiliates. All other trademarks are the property of their respective owners.

2019 Coleco Holdings LLC

Coleco® and ColecoVision® are registered trademarks of Coleco Holdings LLC. All right reserved. All other trademarks are the property of their respective owners.

DATA EAST and DATA EAST logo(s) are trademarks in United States and other countries or registered trademarks in European Union and Japan of G-MODE Corporation.

© 2019 Disney. All rights reserved.

© CITY CONNECTION CO., LTD

© 2019 & ™ Lucasfilm Ltd. All rights reserved.

Copyright © Piko Interactive LLC - All Rights Reserved.

TETRIS ® & © 1985~2019 TETRIS HOLDING.

SAFETY NOTICE

- Do not submerge the arcade cabinet in water or expose it to extreme heat or to strong magnetic fields. Doing so may cause permanent damage to your device.
- Always use a dry towel to clean the cabinet and the control top.
- Transformers are suitable for indoor use only. Transformers and power supplies for toys are not intended to be used as toys, and the use of these products by children shall be under the full supervision of parents.

FCC STATEMENT

This equipment has been tested and found to comply with the limits for a Class B digital device, pursuant to part 15 of the FCC Rules. These limits are designed to provide reasonable protection against harmful interference in a residential installation. This equipment generates, uses and can radiate radio frequency energy and, if not installed and used in accordance with the instructions, may cause harmful interference to radio communications. However, there is no guarantee that interference will not occur in a particular installation. If this equipment does cause harmful interference to radio or television reception, which can be determined by turning the equipment off and on, the user is encouraged to try to correct the interference by one or more of the following measures:

- Reorient or relocate the receiving antenna.
- Increase the separation between the equipment and receiver.
- Connect the equipment into an outlet on a circuit different from that to which the receiver is connected.
- Consult the dealer or an experienced radio/TV technician for help.

Caution

Any changes or modifications to this device not explicitly approved by manufacturer could void your authority to operate this equipment.

This device complies with part 15 of the FCC Rules. Operation is subject to the following two conditions:

(1) This device may not cause harmful interference, and (2) this device must accept any interference received, including interference that may cause undesired operation.

For Game Host

This equipment complies with FCC radiation exposure limits set forth for an uncontrolled environment. This equipment should be installed and operated with minimum distance 20cm between the radiator and your body. This transmitter must not be co-located or operating in conjunction with any other antenna or transmitter.

WARRANTY INFO:

The manufacturer warrants this product to be free and clear of defects in the materials and workmanship, under normal residential use and conditions, for a period of thirty (30) days from the original invoice date. Shipping and handling fees are to be paid for by the customer. To make a Warranty claim, please submit a service request here: support@atgames.net



For additional support please email:
support@atgames.net

ATGAMES

© 2019 AtGames Interactive

www.atgames.net

PO Box 1691, El Segundo, CA 90245
All rights reserved.

*Content and images are for reference only and subject to change.