



www.tokaihit.com

From the foot of Mt. Fuji to the WORLD

All for Living cells
for your imaging®

TOKAI HIT®



ThermoBox®



Stage Top Incubator®



Thermo Plate®



TOKAI HIT will ...

Pursue the joy of inspiring our customers.

Manufacture products conscientiously.

Contribute to our community and society.

All for living cells
for your imaging

Temp., Humidity and CO2 control instrument for Time-Lapse Imaging

Incubation System for microscopes

Stage Top Incubator[®]

Offers precision temperature, humidity and CO2 control for cell culture on a microscope. Enables to conduct short and long term (more than 2 weeks) Time-Lapse Imaging.



Control temperature around a microscope

Enclosure for microscopes

ThermoBox

Maintains a stable cell culturing environment. By enclosing the microscope, it also prevents the focus drift caused by the thermal expansion of the microscope itself.



Automatic Thermo-control System (For IVF and basic research)

Glass/Metal Heater for microscopes

ThermoPlate[®]

Ensures more accurate and reliable thermal control of the specimens during the observation under a microscope. Wide product range supports Biotechnology Science and Industry. 10 year free-repair service for glass breakage* is adopted. * Depending on the models.

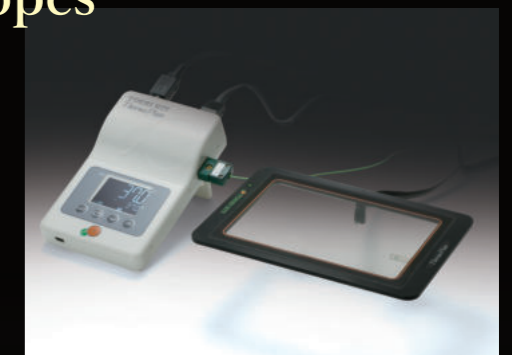

Incubation System for microscopes



Happiness for Cells, Success for Researchers

Offers precision temperature, humidity and CO₂ control for cell culture on a microscope.
Enables to conduct short and long term (more than 2 weeks) Time-Lapse Imaging.



Features

TEMP. Accurate and uniform temperature control

TOKAI HIT Heating Quality

Tokai Hit's original Top Heater is proven to distribute heat uniformly within the Chamber regardless of the type of vessels.

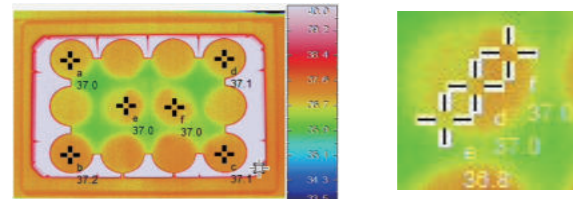

Uniform temperature distribution between wells and within a well.
* In our measurement environment

No interference by objective

With unique Top Heater Heating regulation, the bottom of Chamber is access-free for variety of objectives. (No metal plate at the bottom.)

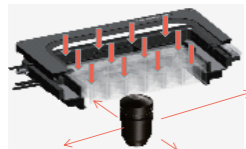

Real-time Sample Feedback Regulation

Sterilized temperature sensor and magnetic lids make it easy to measure the temp. of culture media upon research needs. The controller regulates the heater based on the sensor signal to keep sample at the target temp. accurately.

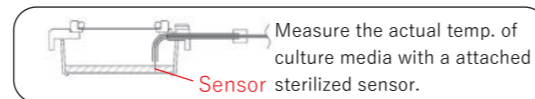
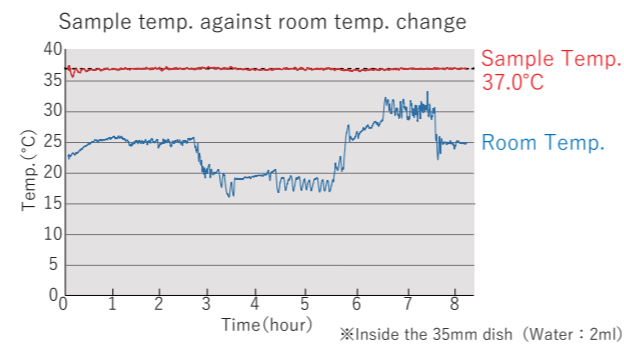

HUM. Keeps high-humidity over 95%

Keeps the humidity level inside the chamber more than 95% by heating the distilled water in the Bath Unit. The internal humidifier minimizes the change of concentration of the media by keeping the humidity inside the chamber.

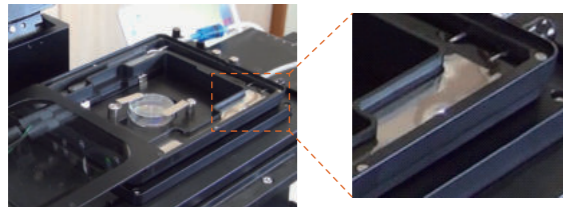

Internal humidifier by Bath Heater

CO₂ Stable CO₂ environment

The controller mixes 100%CO₂ gas and the surrounding air automatically. Stable gas concentration inside the Chamber is kept by sending the mixed gas continuously to the Chamber. (※A case of controller with a built-in digital gas mixer)



※CO₂ concentration can be adjusted from 5.0~20.0%.

Chamber Components

Top Heater

Main heater which heats the specimen from the upper surface. The transparent glass heater prevents condensation and supports clear visibility.

Dish Fixing Lid

Easy setting of vessels with magnetic lid.

Dish Attachment

Supports 35mm dish, 50/60mm dish, chamber slide, slide glass, chambered coverglass and wellplate by changing one-touch magnetic holder.

Bath Unit

Keeps distilled water and embedded Bath Heater heats it directly from beneath to generate high-humidity inside the Chamber unit.

Wreck Proof Lens Heater Cord

Easy attachment and detachment with magnet relay connector prevents breakage of objective revolver and lens heater. It is also possible to lock by twisting the connector.

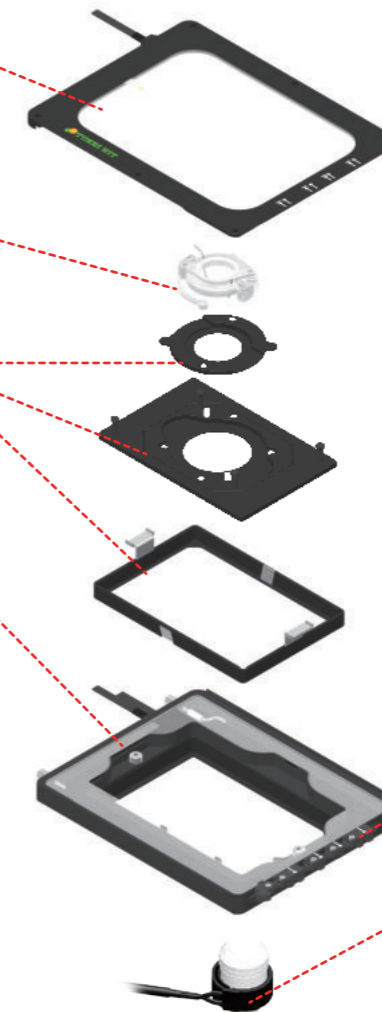
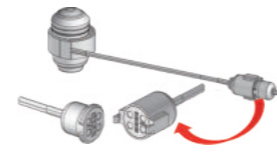

Easy Dish Fixing

Stable and easier "Magnetic" fixing



Even when the objective interferes with the bottom of the dish, a spring type buffering mechanism prevents breakage of the dish/objective.

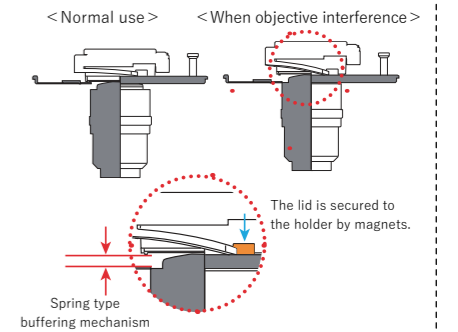

Access Ports

For temperature sensor and tubing for media exchange and drug delivery.

Lens Heater

Prevents heat escaping from the sample to the objective. Especially effective under high magnification, oil/water immersion observation.
* Can accommodate objectives up to φ40mm. Thin type and longer type are optional.

Stage Top Incubator Culture Results

Attribute	Name	Details	Period
Cultured Cell	STO	Embryo; fibroblast, mouse	Over 5 days
Cultured Cell	PC12	Pheochromocytoma; adrenal gland, rat (male)	Over 5 days
Cultured Cell	Hela	Adenocarcinoma; cervix, human (female, 31 years)	Over 5 days
Primary	Human Embryo	Human embryo in vitro; from fertilization to hatching blastocyst over 7 days	Over 7 days
Primary	Neurons	Development of rat cerebral cortical neurons	Over 4 days
Primary	Neural Stem Cells	Proliferation of neural stem cells of 14-day-old rat embryo	Over 7 days
Primary	Neural Stem Cells	Differentiation of rat neural stem cells to neurons and glial cells	Over 7 days
Primary	Hippocampal Neuron	E18 rat hippocampal neurons, cultured in CO ₂ incubator for the first day	Over 3 days
Primary	Cardiac Myocyte	Neonatal rat heart, fetal mouse, heart beat synchronization	Over 3 days

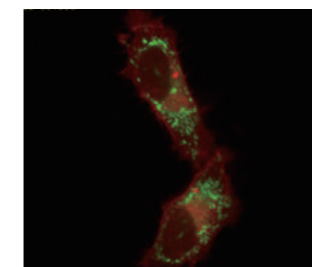

Courtesy of Dr. Takeharu Nagai
The Institute of Scientific and Industrial Research, Osaka University

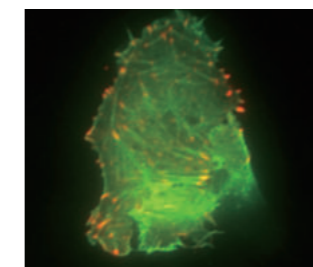

Paxillin actin tirf
Simon Watkins and Claudette St. Croix
Center for Biologic Imaging, University of Pittsburgh

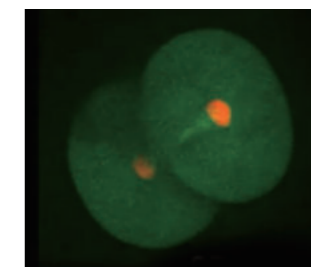

Courtesy of Dr. Kazuo Yamagata
Department of Genetic Engineering,
Kindai University

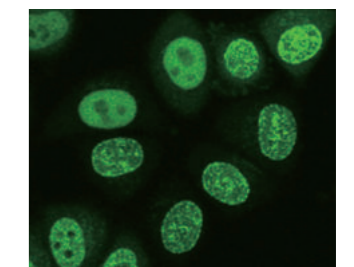

Courtesy of Dr. Hiroshi Kimura
Tokyo Institute of Technology



Visit <https://www.tokaihit.com> for more details regarding our products. (Accessible from the QR code)

Features

Stress-Free Quality

Intuitive operation and varieties of new functions are included to support cell culturing without stress.

Prevent the focus drift

In addition to PID control, Continuous Current Control minimizes the focus drift generated by thermal expansion and it also prevents light intensity change compared to the conventional ON/OFF control.

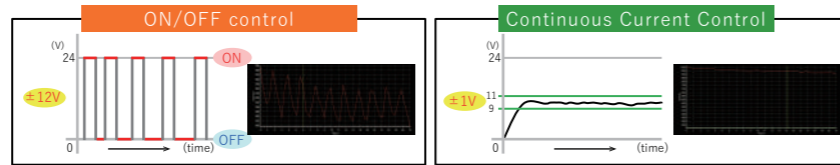

STX-APP (Software)

Simple operation of GUI will assist to visualize the preparation to setting and lead your cell culture to success.



Programmable Control

The system includes the software to program temp. and CO₂/O₂ concentration as this function allows to expand the variety of experiments.

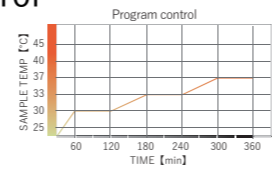

Screen Capture

Captures the PC screen to transfer images to smart-phones and tablets. Enables to see the image at home.
* PC must be connected with internet.



Data Logging

Logs the temperature of each heaters, sample temperature and gas concentration and saves the data in CSV format.



All in one package incubator

Including the following accessories as standard.

SET model

<ul style="list-style-type: none"> Temperature Controller <p>Model STXG With built-in digital gas mixer or Model STXF With built-in analog flow meter</p>	<ul style="list-style-type: none"> Chamber <p>Model WSKMX</p>	<ul style="list-style-type: none"> Feedback Sensor <p>Model TSU-200F</p>
<ul style="list-style-type: none"> Dish Attachments <p>Model ATX-W For well-plate ATX-A For ATX-D, ATX-CSG ATX-D For 35/50/60mm dish ATX-CSG For slide glass, chamber slide and chambered coverglass</p>	<ul style="list-style-type: none"> Dish Fixing Lids <p>Model LX-W For well-plate LX-D35 For 35mm dish LX-D56 For 50/60mm dish LX-CSG For slide glass, chamber slide and chambered coverglass</p>	<ul style="list-style-type: none"> Extension Wire Software STX-APP USB cable Gas tube

Options

<ul style="list-style-type: none"> Stage Adapter <p>Model GSI2X-K For GSI2X For XY motorized stages with 160 × 110 (mm) opening</p>	<ul style="list-style-type: none"> Dish Attachment <p>Model UNIV2-D35-2 For 35mm dish × 2 UNIV2-D35-3 For 35mm dish × 3 UNIV2-D35-4 For 35mm dish × 4 UNIV2-D35-6 For 35mm dish × 6</p> <p>※The Dish Attachment for 35mm dish × 5 is also available.</p>
---	---

Line-up

WSKMX series

- Leica manual/motorized stage
- Sample temperature : 30 - 40°C



- For well-plate and small vessels use



100%CO₂ gas cylinder use
Premixed gas cylinder use

Model **STXG-WSKMX-SET**
Model **STXF-WSKMX-SET**

DMIWX series

- Leica manual/motorized stage (for Laser Safety Hood)
- Sample temperature : 30 - 40°C

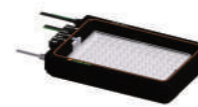

- For well-plate and small vessels use



100%CO₂ gas cylinder use
Premixed gas cylinder use

Model **STXG-DMIWX-SET**
Model **STXF-DMIWX-SET**

GSI2X series

- For Leica SP8/SP5 Super Z Galvo stage
- Sample temperature : 30 - 40°C
- For small vessels use



100%CO₂ gas cylinder use
Premixed gas cylinder use



Model **STXG-GSI2X-SET**
Model **STXF-GSI2X-SET**

DLSX series

- For Leica SP8/SP5 Super Z Galvo stage (for Light Sheet)
- Sample temperature : 30 - 40°C
- For 35mm dish



100%CO₂ gas cylinder use
Premixed gas cylinder use



Model **STXG-DLSX**
Model **STXF-DLSX**

WELSX series

- For manual/motorized/mechanical stages
- Chamber size is the same as wellplates
- Sample temperature : 30 - 40°C
- For small vessels use



100%CO₂ gas cylinder use
Premixed gas cylinder use



Model **STXG-WELSX-SET**
Model **STXF-WELSX-SET**

Depending on the stage, a stage adapter might be required. Please contact Tokai Hit.

Cooling/Heating Chamber

* Cooling/Heating Chamber is not compliance with CE
Sample temp.: 15 - 40°C (with dry lens) / 20 - 40°C (with oil/water immersion lens)



KRiX series

- For XY manual/motorized stage
- With Chiller Unit
- Sample Feedback regulation
- For small vessels use



100%CO₂ gas cylinder use Model **STXGC-KRiX-SET**

Premixed gas cylinder use Model **STXFC-KRiX-SET**

Uniform Temperature Distribution

Normally, it is difficult to control around room temp. because there is not big difference between room temp. and sample temp.. Since KRiX series has both cooling and heating function independently, it can control around room temp. precisely.

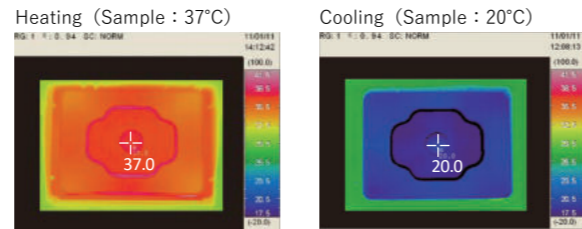

Dish Attachments



For 35mm dish
Cooling/Heating Model **KRiX-D35**
Heating only (optional) Model **ATX-D**

For slide glass, chamber slide, and chambered coverglass
Cooling/Heating Model **KRiX-CSG**
Heating only (optional) Model **ATX-CSG**

* One of Dish Attachment (For Cooling/Heating) is included as standard.

Dish Fixing Lids



For 35mm dish
(Included to the system as standard) Model **LX-D35**

For slide glass, chamber slide, and chambered coverglass
(Included to the system as standard) Model **LX-CSG**

External Humidifier

Eliminates the need of refilling internal/external water for more than 3 - 4 days.
By using this system with internal humidifier, it covers edge to edge of 96-well plate with stable and high humidity throughout the experiment.



Temp. Controller

Bottle Heater

Model **TPiDE-HUMID**

- STABLE cell culturing from short to long-term imaging
- SIMPLE add-on system for all Tokai Hit incubators

Time Lapse movies

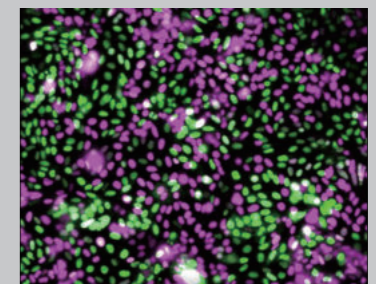

96-well plate



35mm dish

Pictures are courtesy of N.Komatsu, A.Sakae-Sawano and A.Miyawaki
RIKEN Center for Brain Science, Saitama, Japan
Cell cycle progression in Hela cells

For upright microscopes

Sample temp. : 37°C

UKX series

- For XY mechanical stages of upright microscopes
- For small vessels use



100%CO₂ gas cylinder use Model **STXG-UKX-SET**

Premixed gas cylinder use Model **STXF-UKX-SET**



Dish Attachment

For 35mm dish Model **UKX-D35**

For 50/60mm dish Model **UKX-D56**

For slide glass Model **UKX-SG**

* One Dish Attachment is included as standard

Bracket

For manual stage Model **UKX-STD**

For Narishige fixed stage Model **UKX-FNS**

For Prior Z-deck Model **UKX-ZD**

For stages with 160 × 110mm opening Model **UKX-SPC-3**

* One-set is included as standard

Lens Heater

Lens Heater Model **UKX-LHD**

* Lens Heater is included as standard

Lens Heater Options

Lens Heater Adapter Model **UKX-LHA-□□**

Seal Ring Model **TMU-□□**

* □□ contains the diameter of the objective

* One-set is included as standard

Opening/Closing Top Heater

Metal Top Heater with this function make it easy to set the object positioning before imaging.

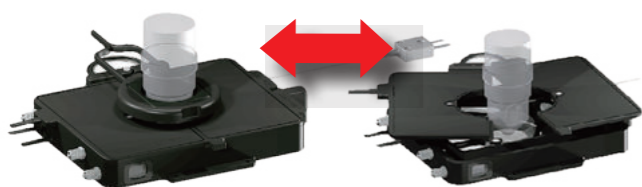

Specifications

Temp. setting range : Ambient + 5°C - 60.0°C

Bottle capacity : 500ml

Heater dimensions : W100 × D110 × H110 (mm)

Controller dimensions : W85 × D135 × H30 (mm)

Components : Temp. Controller, Bottle Heater,

Water Bottle, Gas Tube set

【System image】



< STX controller >
(Optional)

< External Humidifier >

< Chamber >
(Optional)

Enclosure for microscopes

ThermoBox

Maintains a stable cell culturing environment at places where the temperature fluctuation occur. By isolating the microscope from the environment, it also prevents the focus drift caused by the thermal expansion of microscope itself.

Features

ThermoBox for DMI8



- No duct required**
 Saves your working and setting space with built-in fan heaters. No air-ducts required for heating.
- Anti-vibration heater**
 With anti-vibration design, the system can be used under confocal without image drift.
- Available as a simple dark box**
 The black type has the property of light shielding and can be used as a simple dark box.

Anti-vibration test movie



Front panel transparent model is also available as customization.

Specifications

- Dimensions of box : W715 × D440 × H400 (mm)
- Dimensions of controller : W95 × D305 × H211 (mm)
- Temp. setting range : Ambient - 40°C (With heater)

- Easy setup**
 Special tool is not required during installation and most of fixing is done by thumb screws.

<Front>

<Side>

<Top>

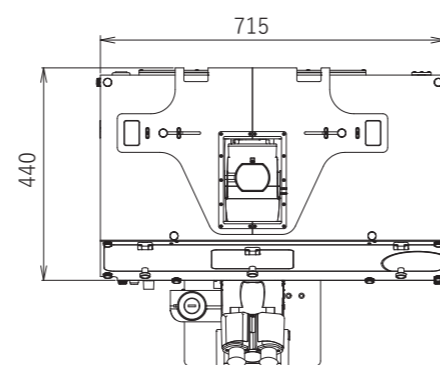
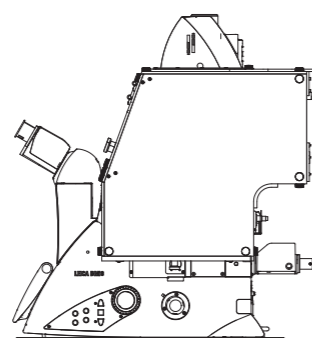
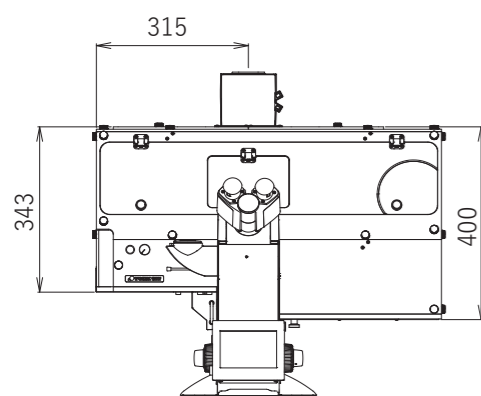

Line-up

Live cell package

- SET model**
 All the items are included for cell culture.

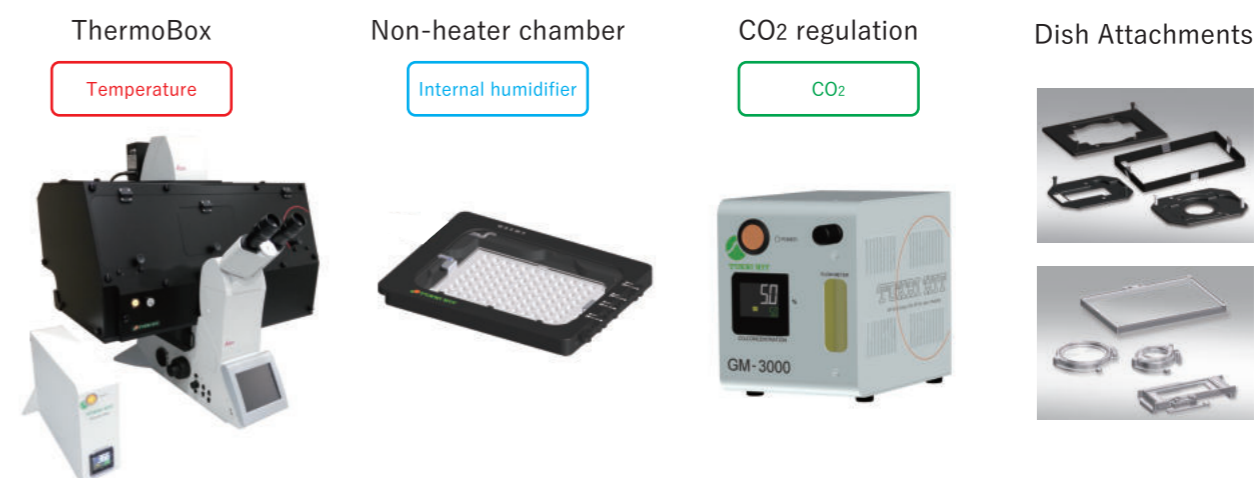

* Dish attachments for wellplate, 35mm, 50/60mm dish, slide glass, chamber slide and chambered cover glass are included.

Microscope	Color type	CO2 gas cylinder	Model
DMI8	Black	100%CO2	Model DMi8TB-WSKM-G
		Premixed	Model DMi8TB-WSKM-F

* Depending on the accessories (camera, stage etc.), the model may be a customized model. Please contact us for details.

ThermoBox only

Microscope	Stage	Color type	Heater	Model
DMI8	Motorized stage	Black	With heater	Model DMi8TB-BK
			No heater	Model DMi8TB-BK-NH
	3 plate stage (motorized)	Black	With heater	Model DMi8TB-3E-BK
			No heater	Model DMi8TB-3E-BK-NH

* Depending on the accessories (camera, stage etc.), the model may be a customized model. Please contact us for details.

Options

Model DMi8TB-CLP	Replacable transparent front door
Model TPiDE-HUMID	External humidifier system (refer to page 8)

Add-on options

We offer the suitable solutions depending on your experiments.

Program fluidic control system

Perfusion, Media Exchange, Drug Delivery and Mixing can be easily programmed and done without disturbing your sample.

Model **PMD-D35**

※For STX/STR/INU Chamber
※For 35mm dish

【Specification】

Continuous Perfusion : 40 μL/min - 100 μL/min
Media Exchange volume : 0.6ml - 5.0ml
Media Exchange Number : Maximum 10 times
Drug Delivery : 20 μL -
Controller size : W175 × D175 × H195 (mm)

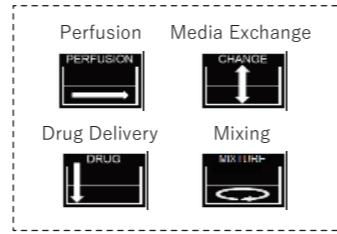

System Image

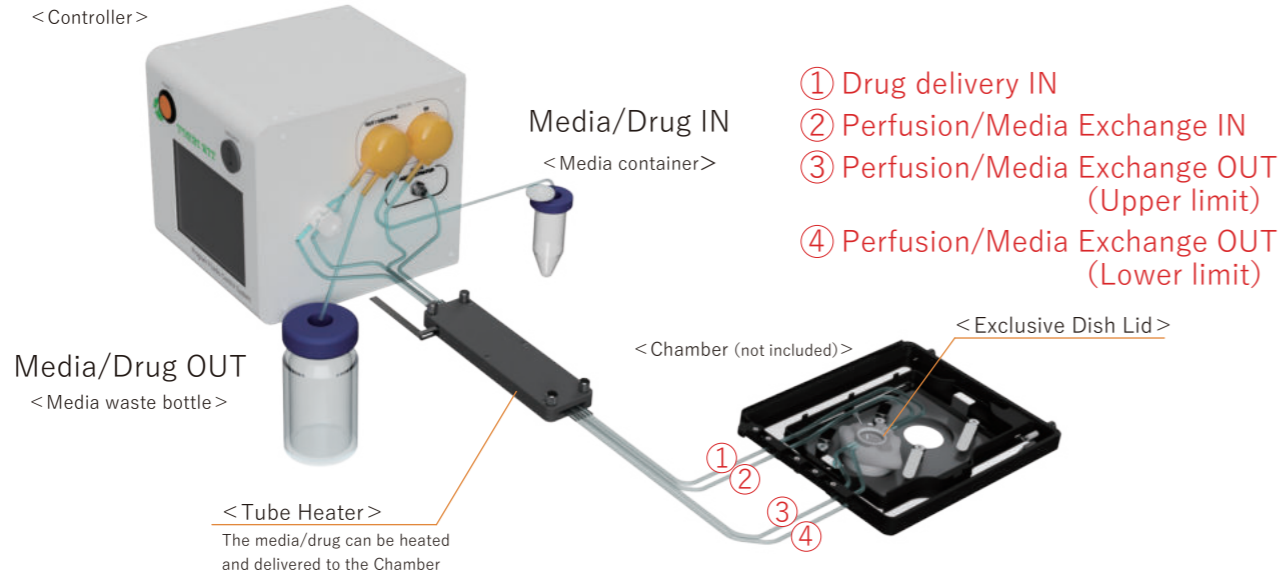

【Components】

- Controller
 - Tube Heater
 - Tubes (IN/OUT, with drug delivery fitting)
 - Media containers (For perfusion, Media Exchange)
 - Multi Fluidic Lid (PMD-D35FME) for 35mm dish
 - Diamond Insert (KS-DIA) for 35mm dish (100 μl media exchange)
- ※Media waste bottle is not included

- Enables to mix the media and drug to be uniformly after the drug delivery.
- Setting of suction / supply liquid volume at a finer flow rate is possible.
- Regulates the system with TTL IN/OUT.
- High-repeatability experiments are possible by keeping the media level evenly.
- With a built-in tube heater, one fluidic control system can be completed with one system.
- Supports general 35mm dish.
- Manages each user's program individually by using USB memory.

Perfusion/Media exchange system

Perfusion/Media exchange without removing a dish lid is possible. Prevents media evaporation and contamination during long-term imaging.

Model **KSX-Type1** *For STX/STR Chamber **KS-Type1** *For INU Chamber

【Components】

- Peristaltic pumps × 2 (KS-PUMP) • Media Exchange Lid (LX-D35FME)
 - Diamond Insert (KS-DIA) • Tubes
 - Glass bottle with air filter KS-BOTTLE
- * Media waste bottle is not included

【Specification】

Pump flow rate : 0 - 2.86ml/min
(by using the attached tube)
Pump dimensions : W73 × D208 × H144 (mm)
Silicon tube : OD 3.0mm, ID 1.0mm (disposable)

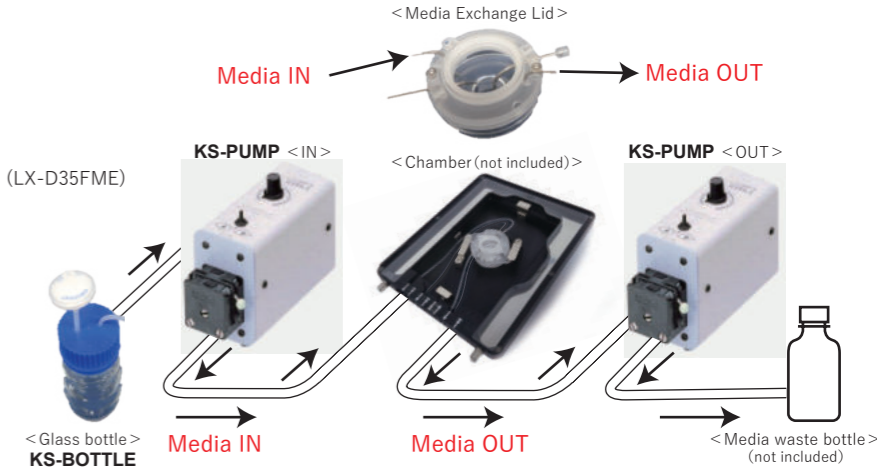

One-push drug delivery system

Rapid and vibration-free drug delivery is possible. Prevents media evaporation and contamination during long-term imaging.

Model **KSX-Type2** *For STX/STR Chamber **KS-Type2** *For INU Chamber

【Specification】

Dosage : 20 μl - 100 μl
(Contact us if different dosage needed)
Controller dimensions : W100 × D165 × H116 (mm)
Silicon tube : OD 3.0mm, ID 1.0mm
(Tube of the Dish side is disposable)

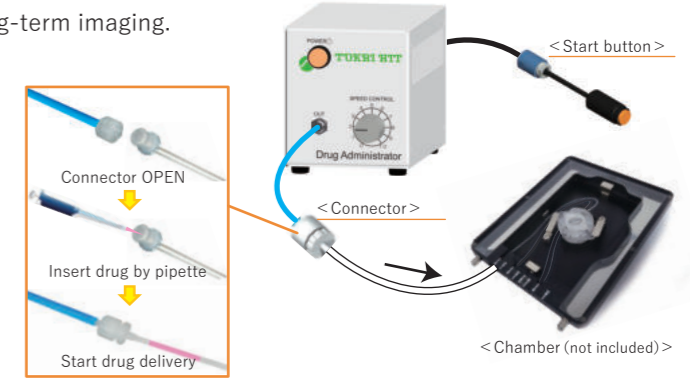

Digital Gas Mixer

Digital Gas Mixer for Stage Top Incubator. You can choose depending on the usage gas cylinder.

For **STX** series

Model **STX-CO2O2**
For low oxygen (Hypoxia)
O2 concentration : 0.1 - 18.0%
CO2 concentration : 5.0 - 20.0%
Gas cylinder : 100%CO2 & 100%N2
Dimensions : W160 × D271 × H250 (mm)

Model **STX-CO2**
For CO2 concentration
CO2 concentration : 5.0 - 20.0%
Gas cylinder : 100%CO2
Dimensions : W115 × D271 × H250 (mm)
* For STXF Controller

Model **STX-O2**
For O2 concentration
O2 concentration : 0.1 - 18.0%
Gas cylinder : 100%N2
Dimensions : W115 × D271 × H250 (mm)
* Must use with STX-CO2

Stand alone

Model **GM-8000**
For low oxygen (Hypoxia)
O2 concentration : 0.1 - 18.0%
CO2 concentration : 5.0 - 20.0%
Gas cylinder : 100%CO2 & 100%N2
Dimensions : W160 × D260 × H187 (mm)

Model **GM-3000**
CO2 concentration & flow rate
CO2 concentration : 1.0 - 20.0%
Flow rate : 50 - 200 ml/min
Gas cylinder : 100%CO2
Dimensions : W121 × D174 × H157 (mm)

Mini CO2 regulator * MG1 is only available in the US and Japan at this moment.

There is no need to prepare a large gas cylinder and no regulator operation is required. The gas is supplied at the optimal flow rate for the Tokai Hit incubator with one push.

Model **MG1**

【Specification】

Output gas pressure: 0.1 MPa
Usable time: about 3 days / 1 cartridge
Dimensions: W135 × D182 × H237 (mm)
Weight: 2.5 kg

■ Consumable gas cartridge

- Consumable gas cartridge is available.
- Please contact LELAND with the part number: **88100Z**.
- Cartridge size: 74 g
- Thread design: 5/8 - 18UNF

LELAND web site



Add-on options

We offer the suitable solutions depending on your experiments.

Reusable 35mm dish *Cyto-cell Chamber (Auto-clavable)

< Collaborative development with Prof. Takafumi Inoue, Waseda Univ. >

For a small amount of medium



Model **SCC12-D35-SET**
Cover glass size : ϕ 12.0 mm
Observation area : ϕ 9.6 mm

For wide range observation

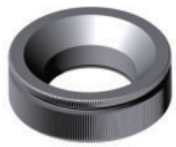

Model **SCC25-D35-SET**
Cover glass size : ϕ 25.0 mm
Observation area : ϕ 21.0 mm

【Features】

1. Whole bottom observation is possible. No interferes with an objective even under high magnification.
2. Running costs can be reduced. By changing the consumable parts, the dish can be reused repeatedly.
3. Observe with small amount of media.

※Consumable parts (Stainless steel plate, cover glass etc.) are also available.

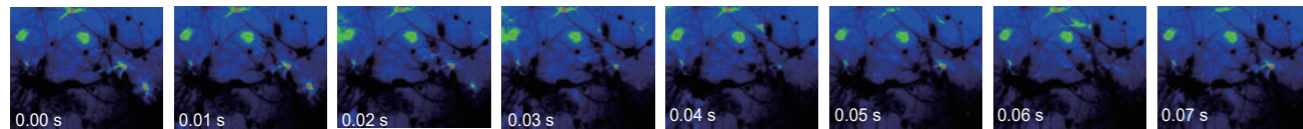
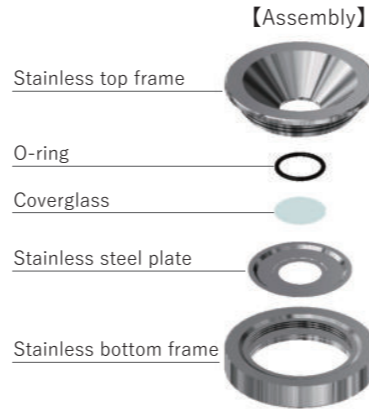

Calcium imaging captured with Cyto-cell chamber. (Fura-2 Fluorescent image)

Courtesy of : Prof. Takafumi Inoue, Department of Life Science and Medical Bioscience, Faculty of Science and Engineering, Waseda University

Digital Thermometer for research



Precise temperature measurement is possible by using a thin sensor with Teflon covering and excellent chemical resistance.

Model **MC1000**
Indicate temp. by 1°C or 0.1°C
K-type thermocouple

< Components >
- Digital Thermometer
- Thermo Probe (TSU-200F)



■ Thermo Probe (Sensor type) Model **TSU-200F**
■ Extension Wire (1.5m) Model **HD1500**

IN/OUT Pipe for Media Exchange/Drug Delivery



For media exchange and drug delivery with incubation system for upright microscopes etc..

Model **PSBD1** Pipe OD 1.1mm
PSBD1H Pipe OD 1.1mm (with side holes)

Model **PSBD2** Pipe OD 2.1mm
PSBD2H Pipe OD 2.1mm (with side holes)

35mm Dish Spacer

When using the 35mm dish from IWAKI, Greiner and Nunc, recommended to use Dish Spacer at the bottom of the dish.



Model **35DI-BS**
For 35mm dish from IWAKI



Model **35DGN-BS**
For 35mm dish from Greiner and Nunc

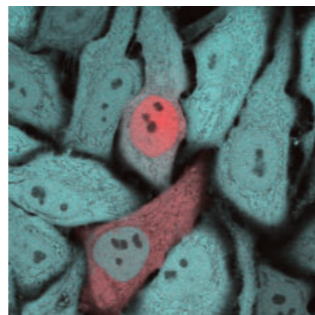

Courtesy of Dr. Takeharu Nagai
The Institute of Scientific and Industrial Research, Osaka University

Customization

We are accepting customization according to the application and conditions. Please feel free to contact us.

We have experience

More than 100 customized products per year.

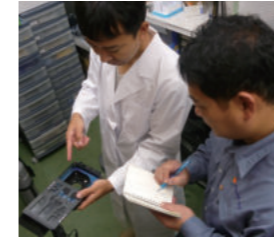

Hearing



Design



Machining



Assembly

Customization reference

Incubation system for MED64

This device has been designed on the assumptions of an experiment of electro physiology. Enable the low noise attribution under the cell culturing environment.

With built-in digital gas mixer Model **INUG2M-MED**

With built-in analog flow meter Model **INUM-MED-F1**

Temperature Controller only Model **INUM-MED**

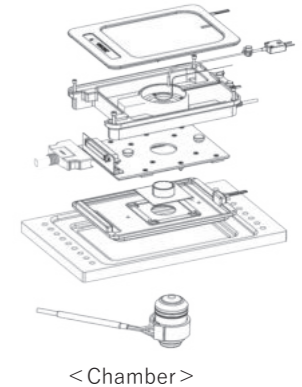
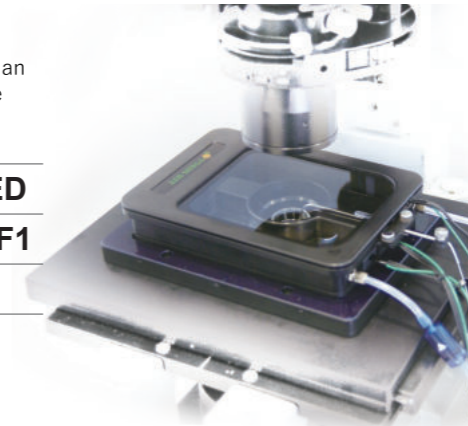

< Chamber >

KW / KD series

BOX-type ThermoPlate with a gas port.

- For inverted microscope
- Setting temp. : Ambient~50°C (Plate temp.)
- Top Glass Heater prevents the condensation of the dish.
- Double Heater system (Top Heater/Stage Heater) keeps the suitable sample temp.

For well-plate use Model **TPiD-KW**

For 35mm dish use Model **TPiD-KD**

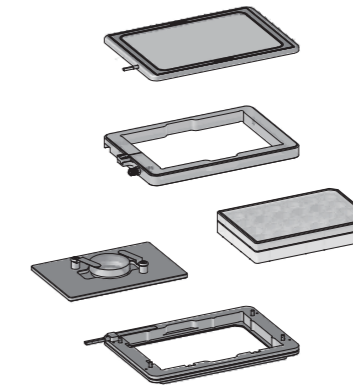

< TPiD-KW >

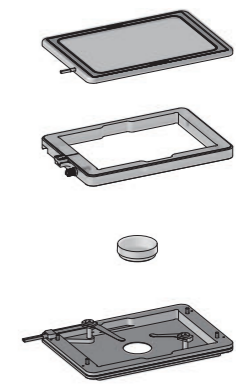

< TPiD-KD >

Integration/Customization

We support and design the instruments for customer's requirement with over 20 years technology and knowledge. Please let us know your needs and requirements. We can designed customized system for you. We are flexible to design different size, temperature regulation, setting range, etc.

e.g. looking for a system for Patch clamp, system integration, unique design/size to installing to your system, etc.

We value your needs and requirements. If you have any questions or concerns, please feel free to contact us.

Glass/Metal Heater for microscope ThermoPlate®

Persues high-end “User-Friendliness”

Ensure more accurate and more reliable thermal control of the specimens during the observation under a microscope.
Wide product range supports Biotechnology Science and Industry.



TPi SERIES New Intelligent ThermoPlate

More downsizing and weight saving of controller compared to TP/TPX series.
Multi-function system supports temperature management in various fields such as biological science.

Features

● Compact Controller

Miniaturizes the controller to be as small as a smart-phone. It is very useful for space saving in the clean bench.

Controller dimensions : W85 × D135 × H30 (mm)
Size : 232 (cm³) * 82% decreased
Weight : 170 (g) * 62% decreased

In addition to flat placement (left), stand upright (center) and wall hanging (right) are available with attached mounting hook depending on the location of use. The mounting hook is thin but durable design with a load capacity of 2 kg.

< Flat placement >

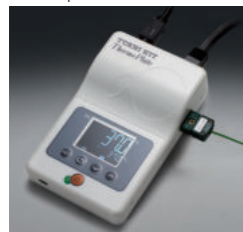

< Stand upright >



< Wall hanging >



● Simple temp. measurement

Attached sterilized sensor can measure the actual temperature and correct the plate surface temperature. Enable to monitor and log the data of temperature which the sensor measures.



● Continuous Current Control

In addition to PID control, Continuous Current Control minimizes the focus drift generated by thermal expansion and it also prevents light intensity change compared to the conventional ON/OFF control.

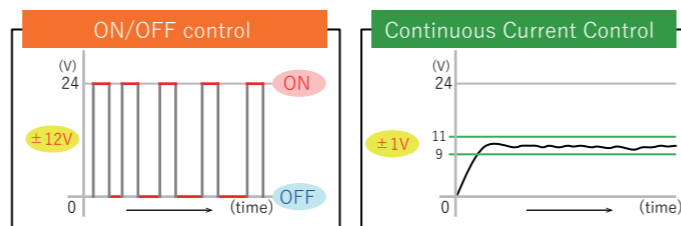

● 10 year free-repair service for glass breakage

Applied strengthen glass or hard glass for the glass heater and with 10 year free-repair service for glass breakage.*
No more glass breakage and no more stopping your experiment.

*1. Depending on the model



● One-touch calibration

Easy calibration to set the suitable PID value on your usage environment is available with just one-touch.

* Tokai Hit's ThermoPlate is calibrated with the controller and the plate as a set to make the center of the plate temp. to be at 37.0°C when the room temp. is 25°C prior to the shipping.

● Plate LED Indicator

Plate LED Indicator visualizes the plate condition without looking at the controller. Green LED lights up when the glass heater is ready.



Statement of LED	Condition of the plate
Lights up	The plate surface temp. is stable at the setting temp..
Blinks slowly (1.0 sec. period)	Running Calibration.
Blinks fast (0.2 sec. period)	An error occurred.

* Plate LED is attached to some major models.

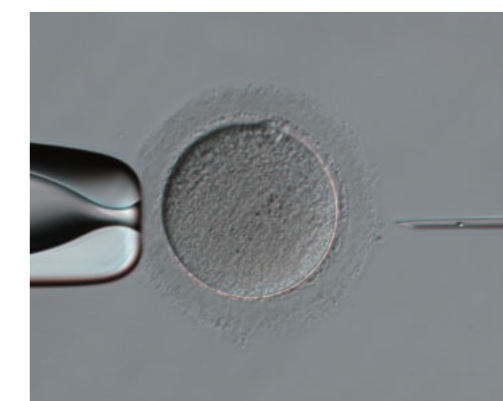

Reference movie : ICSI

Glass Heater Line-up



Tokai Hit's Glass Heaters

Temp. setting range : Ambient - 60°C (* Depending on the model)

Original clear glass heater maintains stable temperature.



Supports the needs in different various fields such as Time-Lapse in low magnification and/or IVF field.

Inverted Microscope : **DMi8**
Applicable stage : XY manual/motorized stage with 160 × 110 mm opening

Model **TPI-SQFTLX**  
Glass thickness : 0.5 (mm)
Plate dimensions : W160 × D110 (mm)
Heating area : W135 × D95 (mm)



Inverted Microscope : **DMI6000B/4000B/3000B**
Applicable stage : XY manual/motorized stage with 160 × 110 mm opening

Model **TPI-SQX**  
Glass thickness : 0.5 (mm)
Plate dimensions : W160 × D110 (mm)
Heating area : W128 × D84 (mm)



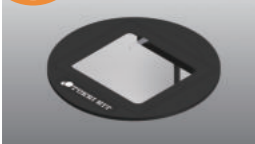

Inverted Microscope : **DMi8, DMI6000B/4000B/3000B**
Applicable stage : Slim stage with 88 mm round opening

Model **TPI-RSRX** 
Glass thickness : 0.5 (mm)
Plate dimension : φ 88 (mm)
Heating area : W60 × D54 (mm)



Inverted Microscope : **DMi8, DMI6000B/4000B/3000B**
Applicable stage : Mechanical stage

Model **TPI-SQMX** 
Glass thickness : 0.5 (mm)
Plate dimensions : W165 × D105 (mm)
Heating area : W129 × D86 (mm)





Inverted Microscope : **Leica SP8/SP5**
Applicable stage : Super Z Galvo stage

Model **TPI-GSIGX** 
Glass thickness : 0.5 (mm)
Plate dimensions : W129 × D87 (mm)
Heating area : W111 × D62 (mm)





Inverted Microscope : **DMIRB**
Applicable stage : XY manual stage with 150 × 150 mm opening

Model **TPI-RSLTX** 
Glass thickness : 0.5 (mm)
Plate dimensions : W150 × D150 (mm)
Heating area : W130 × D130 (mm)



Upright **For upright microscopes**
Applicable stage : XY mechanical stage

Model **TPI-SX**  
Glass thickness : 0.5 (mm)
Plate dimensions : W142 × D115 (mm)
Heating area : W128 × D95 (mm)

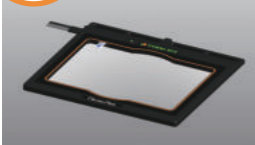



Stereo **For stereo microscopes**
Applicable illumination base : Transmitted Light Base TL RCI/RC etc.

Model **TPI-TLBaseX** 
Glass thickness : 1.0 (mm)
Plate dimensions : W219.5 × D169.5 (mm)
Heating area : W190 × D134 (mm)



Stereo **UNIVERSAL**
For various types of illumination bases

Model **TPI-UNIX**  
Glass thickness : 1.5 (mm)
Plate dimensions : W435 × D220 (mm)
Heating area : W400 × D175 (mm)
Leg adjustment : 75 - 100 (mm) * Temp. setting : Ambient - 50°C

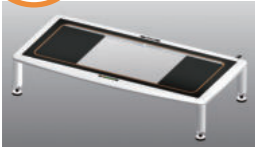

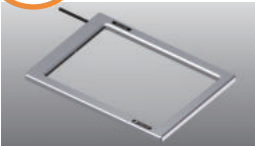

Stereo **Large Glass Type**
For various types of illumination bases

Model **TPI-W**
Glass thickness : 1.5 (mm)
Plate dimensions : W230 × D180 (mm)
Heating area : W180 × D140 (mm)



Model **TPI-WL**
Glass thickness : 1.5 (mm)
Plate dimensions : W310 × D220 (mm)
Heating area : W250 × D170 (mm)

 With 10 year free-repair service for glass breakage.
 With Plate LED Indicator.

Metal Heater Line-up

For oil/water immersion objective and high-magnification objective imaging

Temp. setting range : Ambient - 60°C

Focus drift is caused by thermal expansion from the ordinary ON/OFF regulation.

Tokai Hit is applying Continuous Current Control regulation as standard to minimize focus drift.

Inverted Microscope : **DMi8**
Applicable stage : XY manual/motorized stage with 160 × 110 mm opening

Model **TPI-SQH26FT**
Plate dimensions : W160 × D110 (mm)
With a hole (φ 26 mm)
* Surface flat type



Model **TPiD-I2X** 
Plate dimensions : W160 × D110 (mm)
* 2 in 1 type
Glass: W68 × D95 (mm)
Metal: With a hole (φ 25 mm)

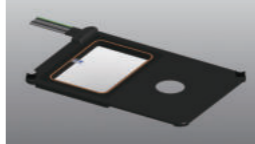

Inverted Microscope : **DMI6000B/4000B/3000B**
Applicable stage : XY manual/motorized stage with 160 × 110 mm opening

Model **TPI-SQH26**
Plate dimensions : W160 × D110 (mm)
With a hole (φ 26 mm)



Inverted Microscope : **Leica SP8/SP5**
Applicable stage : Super Z Galvo stage

Model **TPi-GSIH26**
Plate dimensions : W129 × D87 (mm)
With a hole (φ 26 mm)

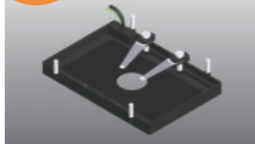

Options



Lens Heater

Model **TPiE-LH**

Temp. setting range : Ambient - 45°C

Prevents heat loss from the sample especially when using oil/water immersion objective and high-magnification objective.

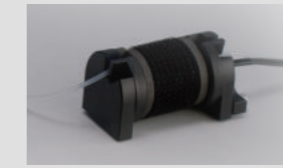

Tube Heater

Model **TPiE-TH**

Temp. setting range : Ambient - 50°C

A compact barrel-type heater. Simply wrap the media tubing for heating the media before inserting it to Chamber Unit.

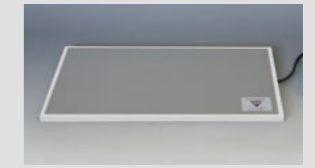

Hot Plate

Model **TPiE-SP/SPE**

Temp. setting range : Ambient - 45°C

Light-weight and thin aluminum thermal plate.
TPiE-SP : W482 × D282 (mm)
TPiE-SPE : W282 × D232 (mm)



Reference movie : ICSI

2-channel controller (Option)

2 plates can be controlled by TPiD controller.
Every combination is possible.

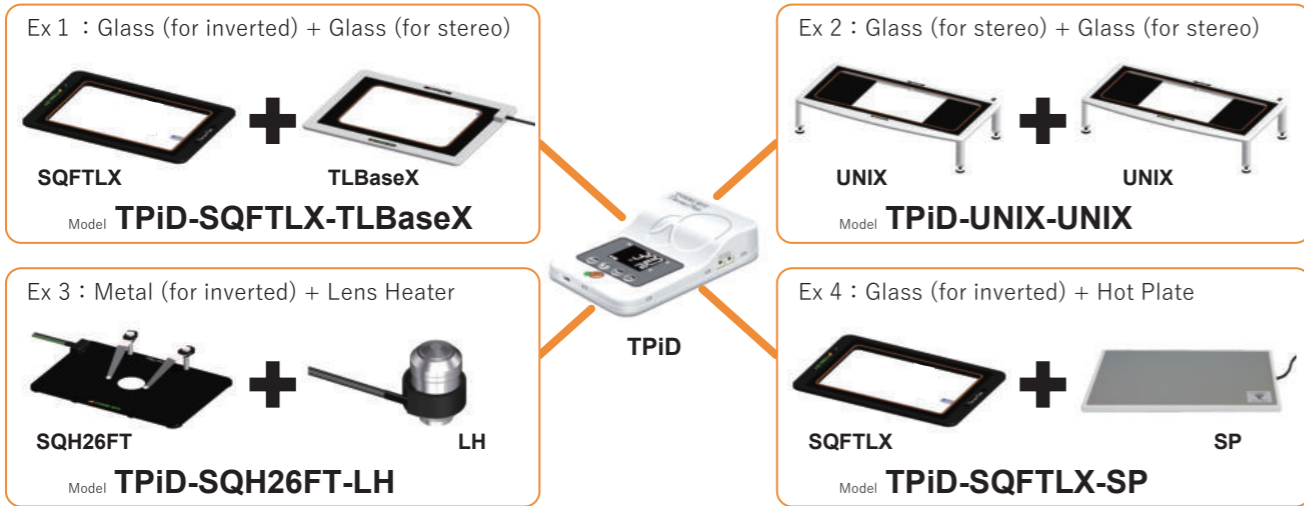

Entire Surface Heating Plate

Temp. control before/after observation
Temp. setting range : Ambient - 50°C

Since the entire surface of the plate is heated, it can manage the temp. of the sample under observation as well as the sample before/after observation. It is very useful when dealing with many samples.

For stereo microscopes

Illumination base : Transmitted light base
TL RCI/RC etc.
Model **TPiD-TLDX**
Glass thickness : 0.5 (mm)
Plate dimensions : W380 × D206 (mm)
Heating area : <Glass part> W128 × D95 (mm)

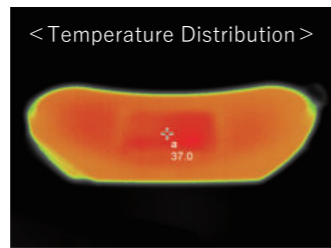

Enables to keep the vessels warm before and after observation.

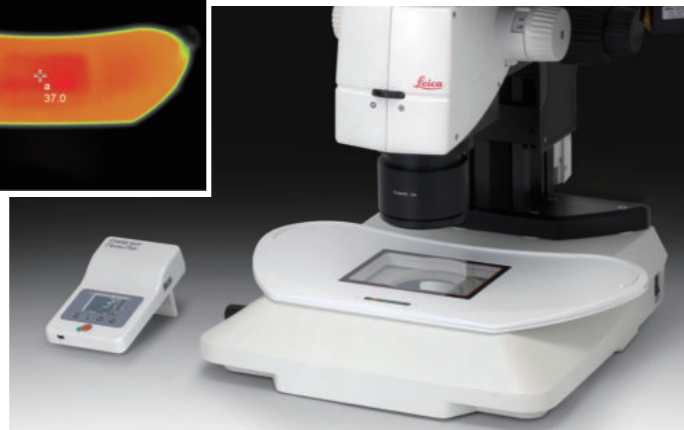

ThermoPlate for Vitrification warming

For thawing process of frozen embryo
Temp. setting range : Ambient - 60°C

Model **TPiD-VITX**
For various types of illumination bases
(Universal type)

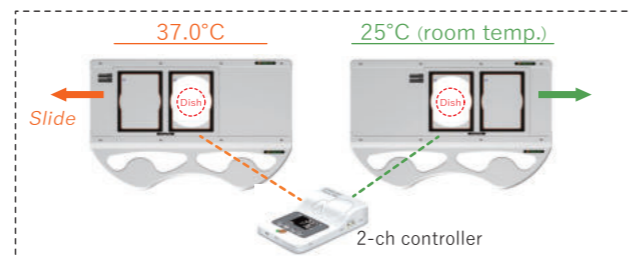
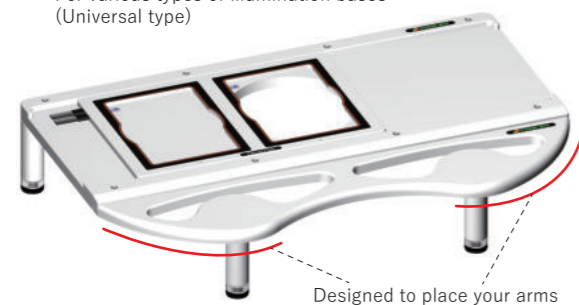

Base dimensions : W435 × D280 (mm) Glass thickness : 0.5 (mm)
Plate dimensions : W230 × D148 (mm) Leg adjustment : 75 - 100 (mm)
Heating area : W95 × D128 (mm) × 2

Cooling/Heating Plate * Cooling/Heating Plate is not compliance with CE



Best for observing yeast, plants, marine samples, cultured cell, C. elegans and/or Planarian, etc.

Temp. setting range (Plate surface) : 4 - 60°C

With electronic cooling element (Peltier module) and original control system, it allows responsive cooling and heating regulation.

* The plate may build the condensation at the bottom when the setting value (SV) of the controller set below 15.0°C (depending on the lab temperature).
The system may not be suitable for
- Long-term imaging
- Rooms with high humidity

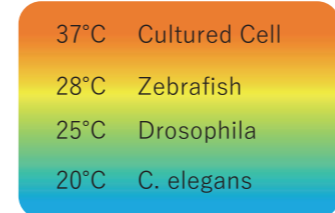

Usually, it is difficult to control the temperature around room temperature because of the small temperature difference between the room temperature and the sample temperature. However, Tokai Hit Cooling/Heating Plate has both cooling and heating functions and can control the temperature around the room temperature accurately without any change-over switch.

It also can be used for controlling activation of the common samples which normally cultured at 37.0 degree C by lowering the temperature or observe expressions of samples at each temperature.



Microscope : **DMi8, DMI6000B/4000B/3000B**

Applicable stage : XY manual/motorized stage with 160 × 110 mm opening



<With Chiller Unit>
Model **TP-CHSQ-C**

Plate dimensions : W160 × D110 (mm)
With a hole (φ 20mm)



Microscope : **DMi8, DMI6000B/4000B/3000B**

Applicable stage : Mechanical stage

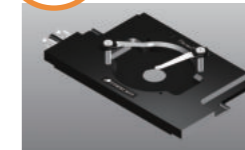

<With Chiller Unit>
Model **TP-CHSQM-C**

Plate dimensions : W165 × D105 (mm)
With a hole (φ 20mm)



Microscope : **DMi8, DMI6000B/4000B/3000B**

Applicable stage : Slim stage with 88 mm round opening



<With Chiller Unit>
Model **TP-CHSL-C**

Plate dimensions : φ 88 (mm)
With a hole (φ 20mm)



Microscope : **For upright microscopes**

Applicable stage : XY mechanical stage



<With Chiller Unit>
Model **TP-CHS-C**

Plate dimensions : W110 × D110 (mm)
With a hole (φ 20mm)

Plate

Cooling element (Peltier module) and a circulation flow path for taking heat of the Peltier module are built in.

Exclusive Chiller Unit

Cool circulating water with sealed water.
Effective for long-term use.



Controller

Temperature controller and pump for circulating water are built in.