

Leica TS11/TS15

User Manual



Version 2.0
English

- when it has to be **right**

Leica
Geosystems

Introduction

Purchase



Congratulations on the purchase of a Leica TS11/TS15.

This manual contains important safety directions as well as instructions for setting up the product and operating it. Refer to "6 Safety Directions" for further information.

Read carefully through the User Manual before you switch on the product.

Product identification





The type and serial number of your product are indicated on the type plate. Enter the type and serial number in your manual and always refer to this information when you need to contact your agency or Leica Geosystems authorised service workshop.

Type: _____

Serial No.: _____

Symbols

The symbols used in this manual have the following meanings:

Type	Description
 DANGER	Indicates an imminently hazardous situation which, if not avoided, will result in death or serious injury.
 WARNING	Indicates a potentially hazardous situation or an unintended use which, if not avoided, could result in death or serious injury.
 CAUTION	Indicates a potentially hazardous situation or an unintended use which, if not avoided, may result in minor or moderate injury and/or appreciable material, financial and environmental damage.
	Important paragraphs which must be adhered to in practice as they enable the product to be used in a technically correct and efficient manner.



Trademarks



- Windows is a registered trademark of Microsoft Corporation in the United States and other countries
 - Bluetooth is a registered trademark of Bluetooth SIG, Inc.
 - SD is a trademark of the SD Card Association
- All other trademarks are the property of their respective owners.



Validity of this manual

This manual applies to the TS11 and TS15 instruments. Differences between the various models are marked and described.

Available documentation

Name	Description/Format		
TS11/TS15 Quick Guide	Provides an overview of the product together with technical data and safety directions. Intended as a quick reference guide.	✓	✓
TS11/TS15 User Manual	All instructions required in order to operate the product to a basic level are contained in the User Manual. Provides an overview of the product together with technical data and safety directions.	-	✓

Name	Description/Format		
Viva TPS Getting Started Guide	Describes the general working of the product in standard use. Intended as a quick reference field guide.	-	✓
Viva GNSS Getting Started Guide	Describes the general working of the product in standard use. Intended as a quick reference field guide.	-	✓

Name	Description/Format		
Viva Series Technical Reference Manual	Overall comprehensive guide to the product and application functions. Included are detailed descriptions of special software/hardware settings and software/hardware functions intended for technical specialists.	-	✓

Refer to the following resources for all TS11/TS15 documentation/software:

- the Leica Viva Series DVD
- <https://myworld.leica-geosystems.com>



myWorld@Leica Geosystems (<https://myworld.leica-geosystems.com>) offers a wide range of services, information and training material.

With direct access to myWorld, you are able to access all relevant services whenever it is convenient for you, 24 hours a day, 7 days per week. This increases your efficiency and keeps you and your equipment instantly updated with the latest information from Leica Geosystems.

Service	Description
myProducts	Simply add all Leica Geosystems products that you and your company own. View detailed information on your products, buy additional options or Customer Care Packages (CCPs), update your products with the latest software and keep up-to-date with the latest documentation.
myService	View the service history of your products in Leica Geosystems Service Centers and detailed information on the services performed on your products. For your products that are currently in Leica Geosystems Service Centers view the current service status and the expected end date of service.
mySupport	Create new support requests for your products that will be answered by your local Leica Geosystems Support Team. View the complete history of your Support and view detailed information on each request in case you want to refer to previous support requests.
myTraining	Enhance your product knowledge with the Leica Geosystems Campus - Information, Knowledge, Training. Study the latest online training material or download training material on your products. Keep up-to-date with the latest News on your products and register for Seminars or Courses in your country.

Table of Contents

In this manual	Chapter	Page
	1 Description of the System	12
	1.1 System Components	12
	1.2 System Concept	20
	1.2.1 Software Concept	20
	1.2.2 Power Concept	23
	1.2.3 Data Storage Concept	24
	1.3 Instrument Components	25
	2 User Interface	31
	2.1 Keyboard	31
	2.2 Operating Principles	35
	3 Operation	36
	3.1 Connecting to a Personal Computer	36
	3.2 Power Functions	42
	3.3 Batteries	44
	3.3.1 Operating Principles	44
	3.3.2 Battery for the TS Instrument	45

3.3.3	Battery for SmartAntenna	47
3.4	Operating the Laser Guide	51
3.5	Working with the Memory Device	52
3.6	Working with the RTK Device (SmartStation)	57
3.7	LED Indicators	65
3.8	Guidelines for Correct Results	73
4	Check & Adjust	76
<hr/>		
4.1	Overview	76
4.2	Preparation	79
4.3	Combined Adjustment (l, t, i, c and ATR)	81
4.4	Tilting Axis Adjustment (a)	86
4.5	Adjusting the Circular Level of the Instrument and Tribrach	91
4.6	Adjusting the Circular Level of the Prism Pole	93
4.7	Inspecting the Laser Plummet of the Instrument	94
4.8	Adjusting the Laser Guide	96
4.9	Servicing the Tripod	101
5	Care and Transport	102
<hr/>		
5.1	Transport	102
5.2	Storage	103

5.3	Cleaning and Drying	104
5.4	Maintenance	106
6	Safety Directions	107
6.1	General Introduction	107
6.2	Intended Use	108
6.3	Limits of Use	110
6.4	Responsibilities	111
6.5	Hazards of Use	113
6.6	Laser Classification	119
6.6.1	General	119
6.6.2	Distancer, Measurements with Reflectors	120
6.6.3	Distancer, Measurements without Reflectors	122
6.6.4	Automatic Target Aiming ATR	127
6.6.5	PowerSearch PS	129
6.6.6	Electronic Guide Light EGL	131
6.6.7	Laser Plummet	132
6.6.8	Laser Guide	136
6.7	Electromagnetic Compatibility EMC	141
6.8	FCC Statement, Applicable in U.S.	144

7	Technical Data	149
7.1	Angle Measurement	149
7.2	Distance Measurement with Reflectors	150
7.3	Distance Measurement without Reflectors	153
7.4	Distance Measurement - Long Range (LO mode)	155
7.5	Automatic Target Aiming ATR	157
7.6	PowerSearch PS	161
7.7	Wide-Angle Camera	163
7.8	SmartStation	164
7.8.1	SmartStation Accuracy	164
7.8.2	SmartStation Dimensions	166
7.8.3	SmartAntenna Technical Data	167
7.9	Laser Guide Technical Data	171
7.10	Conformity to National Regulations	173
7.10.1	TS11/TS15	173
7.10.2	RadioHandle	174
7.10.3	GS12	176
7.10.4	GS15	178
7.10.5	SLR1, SLR2, SATEL SATELLINE-3AS	180
7.10.6	SLR5, SATEL SATELLINE M3-TR1	182
7.10.7	SLR3-1, SLR3-2, Pacific Crest ADL	184

7.10.8	SLG1, Telit UC864-G	186
7.10.9	SLG2, CINTERION MC75i	188
7.10.10	SLC1 (US), SLC2 (US) CDMA Telit CC864-DUAL	190
7.11	General Technical Data of the Instrument	192
7.12	Scale Correction	199
7.13	Reduction Formulas	205
8	International Limited Warranty, Software Licence Agreement	209
<hr/>		
	Index	211
<hr/>		

1 Description of the System

1.1 System Components

System components

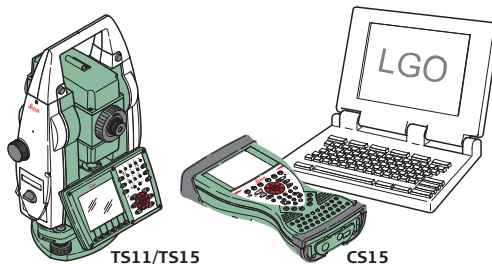

TS_083

General description

TS11/TS15 is a collective term describing total stations of the Leica Viva Series.

Main components

Component	Description
TS11/TS15 instrument	<ul style="list-style-type: none">• an total station for measuring, calculating and capturing data.• consisting of various models with a range of accuracy classes.• integrated with an add-on GNSS system to form Smart-Station.• combined with the multi-purpose CS10/CS15 field controller to conduct remote control surveys.
Laser Guide	<ul style="list-style-type: none">• a variant of the TS15 instrument equipped with Automatic Target Aiming. Instruments equipped with the Laser Guide cannot be equipped with PowerSearch (PS) or Guide Light (EGL).• included in a special compartment in the upper telescope section.• emits a visible red laser beam used for visualising the line of sight.• used for guiding tunnel boring machines, monitoring tunnelling progress or visualising bore holes for rock blasting; targeting of inaccessible objects or prohibited surfaces; positioning of objects and inspecting marks on surfaces.

Component	Description
CS10/CS15 field controller	A multipurpose field controller enabling the remote control of the TS15 instrument.
LEICA Geo Office	The office software including a series of help programs which support working with Leica Viva Series instruments.

Terms and abbreviations

The following terms and abbreviations can be found in this manual:

Term	Description
RCS	R emote C ontrol S urveying
EDM	E lectronic D istance M easurement EDM refers to the laser distancer incorporated into the instrument which enables distance measurement. Two measuring modes are available: <ul style="list-style-type: none">• Prism mode. This mode refers to the ability to measure distances to prisms. It incorporates the LO mode to measure extended distances to prisms.• Any surface mode. This mode refers to the ability to measure distances without prisms.

Term	Description
PinPoint	PinPoint refers to the Reflectorless EDM technology which enables an increased measuring range with a smaller laser spot size. Three options are available: R30, R400 and R1000.
EGL	<p>Electronic Guide Light</p> <p>An EGL fitted to an instrument assists with prism targeting. It consists of two differently coloured flashing lights located in the instrument telescope housing. The person holding the prism can align themselves into the line-of-sight of the instrument.</p>
Motorised	Instruments fitted with internal motors, enabling automatic horizontal and vertical turning are referred to as M otorised.
ATR	<p>Automated Target Aiming.</p> <p>ATR refers to the instrument sensor which enables the automatic target aiming to a prism.</p>
Automated	<p>Instruments fitted with Target aiming are referred to as Automated.</p> <p>Target aiming refers to the instrument sensor which enables the automatic target aiming to a prism.</p>

Term	Description
	<p>Three automation modes are available with Target aiming:</p> <ul style="list-style-type: none">• Manual: no Target aiming - no automation and no lock.• Automatic: automatic target aiming to a prism.• LOCK: automatic tracking of an already targeted prism.
PowerSearch	<p>PowerSearch refers to the instrument sensor which enables the automatic rapid finding of a prism.</p>
SmartStation	<p>A Leica Viva TPS instrument integrated with an add-on GNSS system, comprising hardware and software components, forms a SmartStation.</p> <p>Components of a SmartStation include a SmartAntenna and a SmartAntenna Adapter.</p> <p>A SmartStation provides an additional instrument setup method for determining instrument station coordinates.</p> <p>The GNSS principles and functionality of a SmartStation derive from the principles and functionality of Leica Viva GNSS instruments.</p>

Term	Description
SmartAntenna	SmartAntenna with integrated Bluetooth is a component of a SmartStation. It can also be used independently on a pole with a CS10/CS15 field controller. Models compatible with a TS11/TS15 instrument are GS12 or GS15. Where there are differences between the various models they are clearly described.
RadioHandle	A component of RCS is the RH15/RH16 RadioHandle. It is an instrument carry handle with an integrated radio modem with attached antenna. The TS11 instrument does not support the RH15/RH16 RadioHandle.
Communication side cover	Communication side cover with integrated Bluetooth, SD card slot and USB port is standard for a TS11/TS15 instrument and a component of a SmartStation. In combination with the RH15/RH16 RadioHandle, it is also a component of RCS.

Available models

Model	TS11	TS11 I	TS15 M	TS15 A	TS15 G	TS15 P	TS15 I
Angle measurement	✓	✓	✓	✓	✓	✓	✓
Distance measurement to prism	✓	✓	✓	✓	✓	✓	✓
Distance measurement to any surface (reflectorless)	✓	✓	✓	✓	✓	✓	✓
Motorised	-	-	✓	✓	✓	✓	✓
Automatic Target Aiming	-	-	-	✓	✓	✓	✓
PowerSearch (PS)	-	-	-	-	-	✓	✓
Wide-Angle Camera	-	✓	-	-	-	-	✓
RS232, USB and SD card interface	✓	✓	✓	✓	✓	✓	✓
Bluetooth	✓	✓	✓	✓	✓	✓	✓
Internal Flash Memory (1 GB)	✓	✓	✓	✓	✓	✓	✓
Hotshoe interface for RadioHandle	-	-	✓	✓	✓	✓	✓
Guide Light (EGL)	*	✓	✓	✓	-	✓	✓
Laser Guide	-	-	-	-	✓	-	-
Arctic Option	*	*	-	-	-	-	-

✓Standard

* Optional

- Not available

1.2 System Concept

1.2.1 Software Concept

Description

All instruments use the same software concept.

Software for TS models

Software type	Description
TS firmware (TS_xx.fw)	<p>This important software covers all functions of the instrument.</p> <p>The applications Survey and Setup are integrated into the firmware and cannot be deleted.</p> <p>The English language is integrated into the firmware and cannot be deleted.</p>
Language software (SYS_LANG.sxx)	<p>Numerous languages are available for the TS instruments. This software is also referred to as system language.</p> <p>The English language is the default language. One language is chosen as the active language.</p>
Applications (xx.axx)	<p>Many optional survey-specific applications are available for the TS instruments.</p>

Software type	Description
	Some of the applications are activated freely and require no licence key, and others require purchasing and are only activated with a licence key.
Customised applications (xx.axx)	Customised software, specific to user requirements, can be developed using the GeoC++ development kit in addition to run Windows CE-based applications if GeoCOM robotics licence is available. Information on the GeoC++ development environment is available on request from a Leica Geosystems representative.

Software upload

Uploading software can take some time. Ensure that the battery is at least 75% full before beginning the upload, and do not remove the battery during the upload process.

Software for	Description
All TS models	<p>The SmartWorx Viva is stored in the flash RAM of the TS instrument.</p> <p>Software update instructions</p> <ul style="list-style-type: none">• Download the most recent TS firmware file from https://myworld.leica-geosystems.com. Refer to "Introduction".• Connect the TS instrument to your PC. Refer to "3.1 Connecting to a Personal Computer".• Copy the TS firmware file onto a folder system on the Leica SD card.• Start the TS instrument. In SmartWorx Viva select User\Tools & other utilities\Load firmware & Apps. Select Object to transfer: Firmware.• A message will appear when the upload is complete.

1.2.2

Power Concept

General

Use the Leica Geosystems batteries, chargers and accessories or accessories recommended by Leica Geosystems to ensure the correct functionality of the instrument.

Power options

Model	Power supply
all TS models	Internally by GEB221 battery, OR Externally by GEV52 cable and GEB171 battery. If an external power supply is connected and the internal battery is inserted, then the external power is used.
SmartAntenna	Internally via GEB211/GEB212 battery fitted into the antenna.

1.2.3 Data Storage Concept

Description

Data is stored on a memory device. The memory device can be an SD card or internal memory. For data transfer an USB stick can also be used.

Memory device

SD card: All instruments have an SD card slot fitted as standard. An SD card can be inserted and removed. Available capacity: 1 GB.
USB stick: All instruments have a USB port fitted as standard.
Internal memory: All instruments have an internal memory fitted as standard. Available capacity: 1 GB.



While other SD cards can be used, Leica Geosystems recommends to only use Leica SD cards and is not responsible for data loss or any other error that can occur while using a non-Leica card.



Unplugging connecting cables or removing the SD card or USB stick during the measurement can cause loss of data. Only remove the SD card or USB stick or unplug connecting cables when the TS instrument is switched off.

Transfer data

Data can be transferred in various ways. Refer to "3.1 Connecting to a Personal Computer".



SD cards can directly be used in an OMNI drive as supplied by Leica Geosystems. Other PC card drives can require an adaptor.

1.3

Instrument Components

Instrument components part 1 of 2

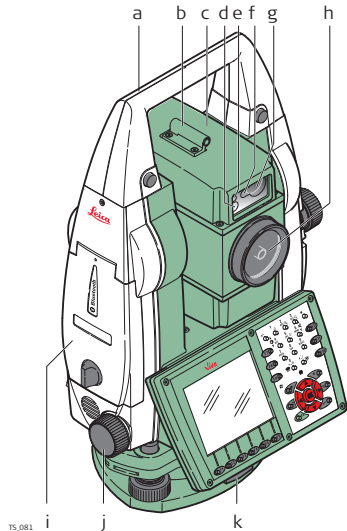

- a) Carry handle
- b) Optical sight
- c) Telescope, integrating EDM, ATR, EGL, PS, wide-angle camera
- d) EGL flashing diode - yellow and red
- e) Wide-angle camera, lens
- f) PowerSearch, transmitter
- g) PowerSearch, receiver
- h) Coaxial optics for angle and distance measurement, and exit port of visible laser beam for distance measurements
- i) Communication side cover
- j) Horizontal drive
- k) Tribach securing screw

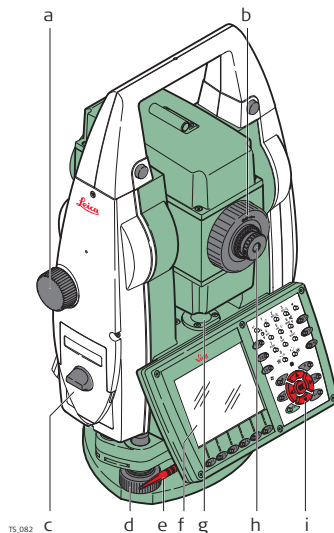
Instrument components part 2 of 2

- a) Vertical drive
- b) Focusing ring
- c) Battery compartment
- d) Tribrach footscrew
- e) Stylus for touch screen
- f) Touch screen
- g) Circular level
- h) Interchangeable eyepiece
- i) Keyboard

Communication side cover

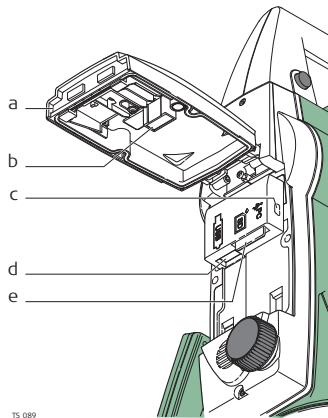

TS_089

- a) Compartment lid
- b) USB stick cap storage
- c) USB device port (mini AB OTG)
- d) USB host port for USB stick
- e) SD card port

**Instrument
components for
SmartStation**

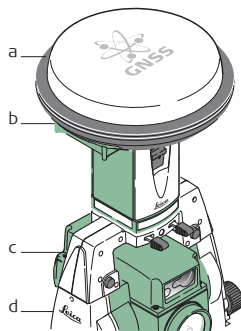

TS_084

- a) SmartAntenna
- b) RTK slot-in device
- c) SmartAntenna Adapter
- d) Communication side cover

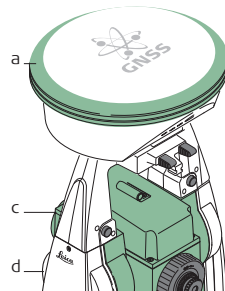

Instrument components for RCS

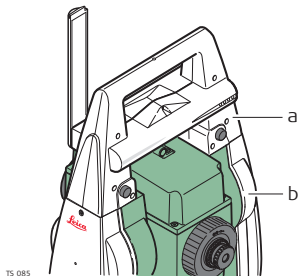

- a) RadioHandle
- b) Communication side cover

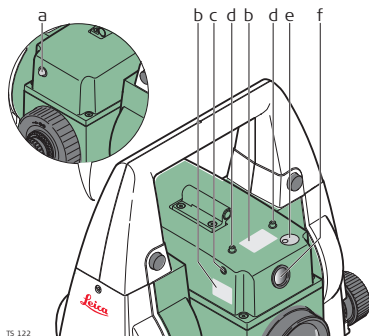
**Laser guide
components**

TS_122

- a) Operation indicator LED, orange
- b) Labelling
- c) Horizontal adjustment screws
- d) Fixing screws
- e) Safety cover for vertical adjustment screws
- f) Laser aperture

2

2.1

User Interface



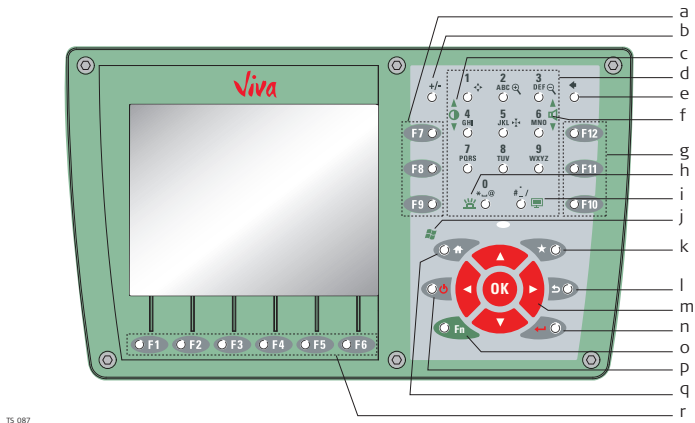

Keyboard







Keyboard TS11/TS15



- a) Function keys **F7 - F9**
- b) \pm key
- c) Brightness
- d) Alphanumeric keys
- e) Backspace
- f) Volume
- g) Function keys **F10 - F12**
- h) Keyboard illumination
- i) Screenshot
- j) Windows CE
- k) Favourites
- l) ESC
- m) Arrow keys, **OK**
- n) ENTER
- o) **Fn**
- p) ON/OFF
- q) Home
- r) Function keys **F1 - F6**

Keys

Key	Function
Function keys F1 - F6 	Correspond to six softkeys that appear on the bottom of the screen when the screen is activated.
Function keys F7 - F12 	User definable keys to execute chosen commands or access chosen screens.
Alphanumeric keys 	To type letters and numbers.
Esc 	Leaves the current screen without storing any changes.

Key	Function
Fn 	Switches between the first and second level of function keys.
Enter 	Selects the highlighted line and leads to the next logical menu / dialog. Starts the edit mode for editable fields. Opens a selectable list.
ON/OFF 	If the instrument is already off: Turns on the instrument when held for 2 s. If the instrument is already on: Turns to Power Options menu when held for 2 s.
Favourites 	Goes to a favourites menu.
Home 	Switches to the SmartWorx Viva Main Menu. Switches to the Windows CE Start Menu when pressing Fn at the same time.
Arrow keys 	Move the focus on the screen.

Key	Function
OK 	<p>Selects the highlighted line and leads to the next logical menu / dialog.</p> <p>Starts the edit mode for editable fields.</p> <p>Opens a selectable list.</p>

2.2

Operating Principles

Keyboard and touch screen

The user interface is operated either by the keyboard or by the touch screen with supplied stylus. The workflow is the same for keyboard and touch screen entry, the only difference lies in the way information is selected and entered.

Operation by keyboard

Information is selected and entered using the keys. Refer to "2.1 Keyboard" for a detailed description of the keys on the keyboard and their function.

Operation by touch screen

Information is selected and entered on the screen using the supplied stylus.

Operation	Description
To select an item	Tap on the item.
To start the edit mode in editable fields	Tap on the editable field.
To highlight an item or parts of it for editing	Drag the supplied stylus from the left to the right.
To accept data entered into an editable field and exit the edit mode	Tap on the screen outside of the editable field.
To open a context-sensitive menu	Tap on the item and hold for 2 s.

3 Operation



3.1 Connecting to a Personal Computer



Microsoft ActiveSync (for PCs with Windows XP operating system) or Windows Mobile Device Center (for PCs with Windows Vista or Windows 7 operating system) is the synchronisation software for Windows mobile-based pocket PCs. Microsoft ActiveSync or Windows Mobile Device Center enables a PC and a Windows mobile-based pocket PC to communicate.

Install Leica Viva USB drivers

Step	Description
1.	Start the PC.
2.	Insert the Leica Viva Series DVD.
3.	<p>Run the SetupViva&GR_USB_XX.exe to install the drivers necessary for Leica Viva devices. Depending on the version (32bit or 64bit) of the operating system on your PC, you have to select between the three setup files following:</p> <ul style="list-style-type: none"> • SetupViva&GR_USB_32bit.exe • SetupViva&GR_USB_64bit.exe • SetupViva&GR_USB_64bit_itanium.exe <p> The setup has to be run only once for all Leica Viva devices.</p>

Step	Description
4.	The Welcome to InstallShield Wizard for Leica Viva & GR USB drivers window appears.  Ensure that all Leica Viva devices are disconnected from your PC before you continue!
5.	Next> .
6.	The Ready to Install the Program window appears.
7.	Install. The drivers will be installed on your PC.  For PCs with Windows Vista or Windows 7 operating system: If not already installed, Windows Mobile Device Center will be installed additionally.
8.	The InstallShield Wizard Completed window appears.
9.	Check I have read the instructions and click Finish to exit the wizard.

Connect USB cable to computer for the first time step-by-step

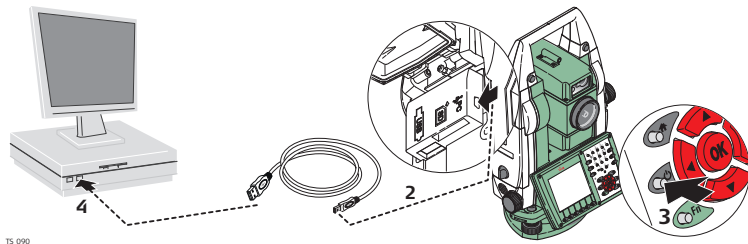

TS_090

Step	Description
1.	Start the computer.
2.	Plug the GEV223 cable into TPS instrument.
3.	Turn on the TPS instrument.
4.	Plug the GEV223 cable into the USB port of the computer. The Found New Hardware Wizard starts up automatically.
5.	Check Yes, this time only. Next> .
6.	Check Install the software automatically (Recommended). Next> . The software for Remote NDIS based LGS TS Device will be installed on your computer

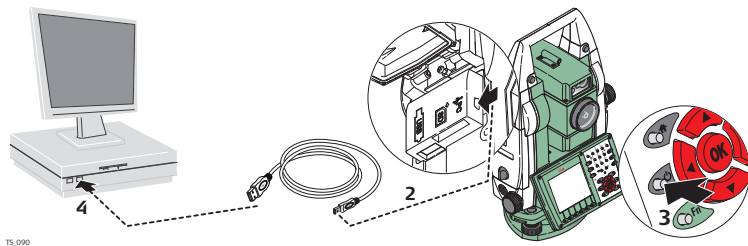

Step	Description
7.	Finish.
8.	The Found New Hardware Wizard starts up automatically a second time.
9.	Check Yes, this time only. Next> .
10.	Check Install the software automatically (Recommended). Next> . The software for LGS TS USB Device will be installed on your computer.
11.	Finish.
	For PCs with Windows XP operating system:
12.	Run the ActiveSync installation program if not already installed.
13.	Allow USB connections inside the Connection Settings window of Active-Sync.
	For PCs with Windows Vista or Windows 7 operating system:
14.	Windows Mobile Device Center starts up automatically. If does not start automatically, start Windows Mobile Device Center.

Connect to computer via USB cable step-by-step





TS_090

Step	Description
1.	Start the PC.
2.	Plug the GEV223 cable into TS instrument.
3.	Turn on the TS instrument.
4.	Plug the GEV223 cable into the USB port of the computer.
	For PCs with Windows XP operating system:
	 ActiveSync starts up automatically. If does not start automatically, start ActiveSync. If not already installed, run the ActiveSync installation program.



Step	Description
5.	Allow USB connections inside the Connection Settings window of ActiveSync.
6.	<p data-bbox="474 231 809 262">Click Explore in ActiveSync.</p> <p data-bbox="474 277 1355 376">  The folders on the TS instrument are displayed under Mobile Devices. The folders of the data storage device can be found in either of the following folders: <ul data-bbox="525 396 1027 515" style="list-style-type: none"> <li data-bbox="525 396 1027 422">• Leica Geosystems\SmartWorx Viva <li data-bbox="525 443 678 469">• SD Card <li data-bbox="525 490 834 515">• USB memory device </p>
	<p data-bbox="474 531 1209 562">For PCs with Windows Vista or Windows 7 operating system:</p> <p data-bbox="474 578 1362 640">  Windows Mobile Device Center starts up automatically. If does not start automatically, start Windows Mobile Device Center. </p>

3.2 Power Functions



Turning on TS11/TS15 instrument

Press and hold power key () for 2 s.
 Instrument must have a power supply.

Turning TS instrument off

Press and hold power key () for 5 s.
 TS instrument must be on.

Power Options menu

Press and hold power key () for 2 s to open **Power Options** menu.
 Instrument must be on.

Option	Description
Turn off	Turn TS instrument off.
Stand-by	Put TS instrument into stand-by mode.  In stand-by mode, the TS instrument shuts down and reduces power consumption. Rebooting from stand-by mode is quicker than a cold start after turning off.
Lock keyboard	Locks the keyboard. Option turns to Unlock keyboard .

Option	Description
Turn off touch screen	Disables touch screen. Option turns to Turn on touch screen .
Reset...	Performs one of the following options: <ul style="list-style-type: none"><li data-bbox="748 267 1166 296">• Restart (restarts Windows CE)<li data-bbox="748 304 1333 366">• Reset Windows CE (resets Windows CE and communication settings to factory defaults)<li data-bbox="748 375 1355 437">• Reset installed software (resets settings of all installed software)<li data-bbox="748 445 1365 536">• Reset Windows CE and installed software (resets Windows CE and settings of all installed software)

3.3 Batteries

3.3.1 Operating Principles

Charging / first-time use

- The battery must be charged prior to using it for the first time because it is delivered with an energy content as low as possible.
 - The permissible temperature range for charging is between 0°C to +40°C/ +32°F to +104°F. For optimal charging, we recommend charging the batteries at a low ambient temperature of +10°C to +20°C/+50°F to +68°F if possible.
 - It is normal for the battery to become warm during charging. Using the chargers recommended by Leica Geosystems, it is not possible to charge the battery if the temperature is too high.
 - For new batteries or batteries that have been stored for a long time (> three months), it is effectual to make only one charge/discharge cycle.
 - For Li-Ion batteries, a single discharging and charging cycle is sufficient. We recommend carrying out the process when the battery capacity indicated on the charger or on a Leica Geosystems product deviates significantly from the actual battery capacity available.
-

Operation / Discharging

- The batteries can be operated from -20°C to +55°C/-4°F to +131°F.
 - Low operating temperatures reduce the capacity that can be drawn; high operating temperatures reduce the service life of the battery.
-

3.3.2

Battery for the TS Instrument

Change battery step-by-step

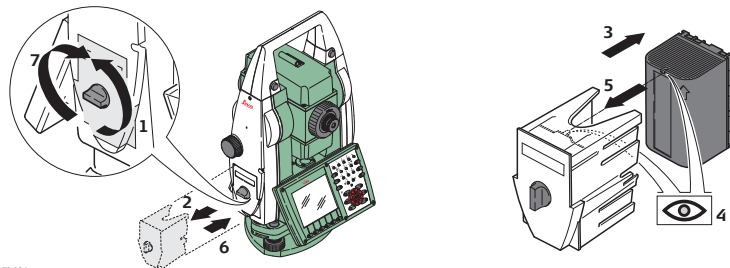

TS_094

Step	Description
1.	Face the instrument so that the vertical drive screw is on the left. The battery compartment is below the vertical drive. Turn the knob to the vertical position, opening the lid of the battery compartment.
2.	Pull out the battery housing.
3.	Pull the battery from the battery housing.
4.	A pictogram of the battery is displayed inside the battery housing. This pictogram is a visual aid to assist in placing the battery correctly.

Step	Description
5.	Place the battery into the battery housing, ensuring that the contacts are facing outward. Click the battery into position.
6.	Place the battery housing into the battery compartment. Push the battery housing in until it fits completely into the battery compartment.
7.	Turn the knob to lock the battery compartment. Ensure that the knob is returned to its original horizontal position.

3.3.3

Battery for SmartAntenna

Change battery step-by-step

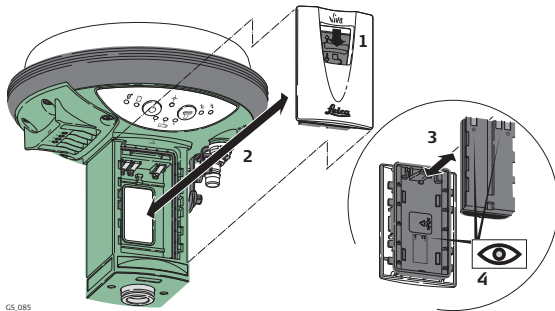

CS_085

Step	Description
	The batteries are inserted in the bottom part of the instrument.
1.	Push the slide fastener of one of the battery compartments in the direction of the arrow with the open-lock symbol.
2.	Remove the cover from the battery compartment.

Step	Description
3.	With the battery contacts facing upwards, slide the battery into the cover of the battery compartment.
4.	Push the battery upwards so that it locks into position.
5.	Insert the cover of the battery compartment into the compartment and push the slide fastener in the direction of the arrow with the close-lock symbol.
6.	Repeat steps 1. to 5. for the second battery compartment.
7.	To remove a battery, push the slide fastener of one of the battery compartments in the direction of the arrow with the open-lock symbol and remove the cover.
8.	Push the battery slightly upwards and at the same time pull out the bottom part of the battery. This releases the battery from its fixed position.
9.	Remove the battery.
10.	Insert the cover into the battery compartment and push the slide fastener in the direction of the arrow with the close-lock symbol.
11.	Repeat steps 7. to 10. for the second battery compartment.

Change battery step-by-step

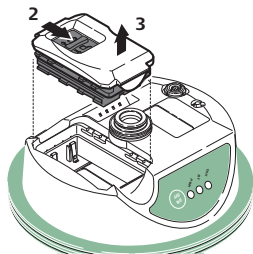

GS_121

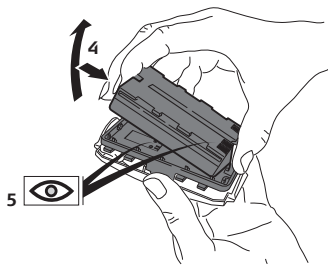

Step	Description
1.	Turn GS12 over to gain access to the battery compartment.
2.	Open the battery compartment by pushing the slide fastener in the direction of the arrow with the open-lock symbol.
3.	Pull out the battery housing. The battery is attached to the housing.
4.	Hold the battery housing and pull the battery from the battery housing.
5.	A polarity of the battery is displayed inside the battery housing. This is a visual aid to assist in placing the battery correctly.

Step	Description
6.	Place the battery onto the battery housing, ensuring that the contacts are facing outward. Click the battery into position.
7.	Close the battery compartment by pushing the slide fastener in the direction of the arrow with the close-lock symbol.

3.4

Operating the Laser Guide

Description

The Laser Guide can be operated and configured manually or via the serial RS232 interface of the TS15 G instrument.



The Laser Guide is automatically turned off temporarily during distance measurement.



For instruments equipped with reflectorless EDM the Laser Guide is automatically turned off when the reflectorless laser pointer is turned on.



Refer to the GeoCOM Reference Manual for further information on GeoCOM.

3.5

Working with the Memory Device





- Keep the card dry.
 - Use it only within the specified temperature range.
 - Do not bend the card.
 - Protect the card from direct impacts.
-



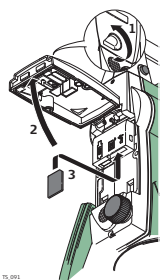

Failure to follow these instructions could result in data loss and/or permanent damage to the card.

Insert and remove an SD card step-by-step

Step	Description	
	The SD card is inserted into a slot inside the Communication side cover of the instrument.	 <small>TS 091</small>
1.	Turn the knob on the Communication side cover to the vertical position to unlock the communication compartment.	
2.	Open the lid of the communication compartment to access the communication ports.	
3.	Slide the SD card firmly into the SD slot until it clicks into position.  The card must be held with the contacts at the top and facing toward the instrument.  Do not force the card into the slot.	
4.	Close the lid and turn the knob to the horizontal position to lock the communication compartment.	
5.	To remove the SD card, open the lid of the communication compartment and gently press on the top of the card to release it from the slot.	

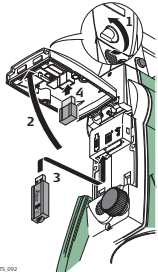
Insert and remove a USB stick step-by-step

Step	Description	
	The USB stick is inserted into the USB host port inside the Communication side cover of the instrument.	 <p data-bbox="1097 538 1121 547">TS_092</p>
1.	Turn the knob on the Communication side cover to the vertical position to unlock the communication compartment.	
2.	Open the lid of the communication compartment to access the communication ports.	
3.	Slide the USB stick with the Leica logo facing you firmly into the USB host port until it clicks into position.	
4.	 Do not force the USB stick into the port.	
5.	If desired, store the lid of the USB stick on the underside of the compartment lid.	
6.	Close the lid and turn the knob to the horizontal position to lock the compartment.	
6.	To remove the USB stick, open the lid of the compartment and slide the USB stick out of the port.	

Insert and remove an SD card into GS15 step-by-step

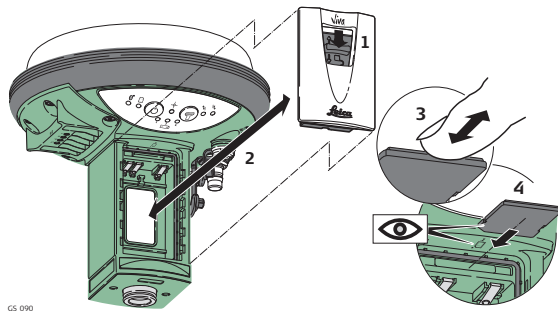

Step	Description
	The SD card is inserted into a slot inside the battery compartment 1 of the instrument.
1.	Push the slide fastener of battery compartment 1 in the direction of the arrow with the open-lock symbol.
2.	Remove the cover from battery compartment 1.
3.	Slide the card firmly into the slot until it clicks into position.

Step	Description
4.	Do not force the card into the slot. The card should be held with the contacts upwards and facing the slot.
5.	To remove the card, push the slide fastener of battery compartment 1 in the direction of the arrow with the open-lock symbol and remove the cover.
6.	Gently press on the top of the card to release it from the slot.
7.	Remove the SD card.
8.	Insert the cover into battery compartment 1 and push the slide fastener in the direction of the arrow with the close-lock symbol.

3.6

Working with the RTK Device (SmartStation)

Devices fitting into the GS15 GNSS instrument

Digital cellular phones fitting into the GS15 GNSS instrument

Digital cellular phone	Device
Telit UC864-G	SLG1
CINTERION MC75i	SLG2
CDMA Telit CC864-DUAL (US)	SLC1, SLC2

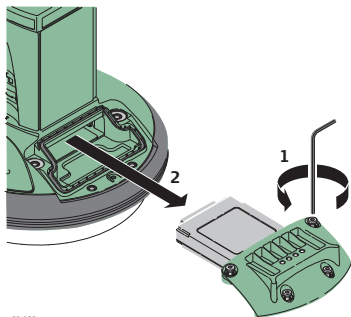

Radios fitting into the GS15 GNSS instrument

Radio	Device
Pacific Crest PDL, transceive	SLR3-1
Pacific Crest PDL, transceive	SLR3-2
Satellite 3AS, transmit	SLR1
Satellite 3AS, receive	SLR2
Satellite M3-TR1, transceive	SLR5

**Insert and remove
a slot-in-device
step-by-step**



GS_089

Step	Description
	Turn over the GS15 to gain access to the slot-in-device compartment.
1.	Loosen the screws of the compartment cover with the supplied Allen key.
2.	Remove the compartment cover.
3.	Attach the slot-in-device to the compartment cover.
4.	Insert the compartment cover into the compartment (port P3).

Step	Description
5.	Tighten the screws.  All screws have to be tightened to ensure that the instrument is waterproof.
	For the equipment setup as real-time base station with radio, it's recommended to use an external radio antenna mounted on a second tripod. This increases the height of the radio antenna and therefore maximises radio coverage. Refer to the Leica Viva GNSS Getting Started Guide for detailed information about the setup.

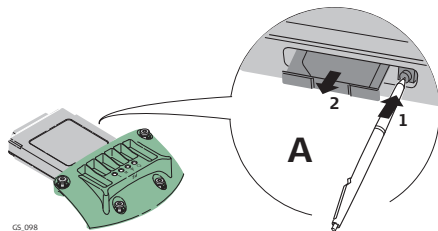
Insert and remove a SIM card step-by-step



Step	Description
	The SIM card is inserted into a slot on the side of the SLG1/SLG2.
	Take the SIM card and a pen.
1.	Using the pen, press the small button of the SIM card slot to eject the SIM card holder.
2.	Take the SIM card holder out off the SLG1/SLG2.
3.	Place the SIM card into the SIM card holder, the chip facing up.
4.	Insert the SIM card holder into the SIM card slot, the chip facing the connectors inside the slot.

LED indicators

Description

Each slot-in-device for a radio or digital cellular phones has **L**ight **E**mitting **D**iode indicators on the bottom side. They indicate the basic device status.

Diagram

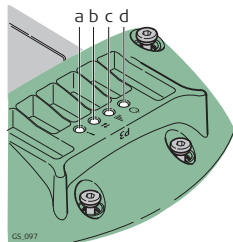

- a) Mode LED, available for Satellite 3AS
- b) Data transfer LED
- c) Signal strength LED
- d) Power LED

Description of the LEDs

IF the	on	is	THEN
Mode LED	SLR1, SLR2 with Sateline 3AS, SLR5 with Sateline M3-TR1	red	the device is in the programming mode controlled from the PC via cable.
Data transfer LED	any device	off	data is not being transferred.
		flashing green	data is being transferred.
Signal strength LED	SLC1 (US), SLC2 (US) with CDMA Telit CC864-DUAL	red	device is on, not registered on the network.
		flashing red	device is on, registered on the network.
		off	download mode or device is off.

IF the	on	is	THEN
	SLG1 with Telit UC864-G, SLG2 with CINTERION MC75i	red	call is in progress.
		red: long flash, long break	no SIM card inserted, no PIN entered or network search, user authentication or network login in progress.
		red: short flash, long break	logged on to network, no call in progress.
		red: flashing red, long break	GPRS PDP context activated.
		red: long flash, short break	Packet switched data transfer is in progress.
		off	device is off.

IF the	on	is	THEN
	SLR3-1, SLR3-2 with Pacific Crest ADL	red	the communication link, Data Carrier Detection , is okay on the roving instrument.
		flashing red	the communication link, Data Carrier Detection , is okay on the roving instrument, but signal is weak.
		off	the DCD is not okay.
	SLR1, SLR2 with Satellite 3AS, SLR5 with Satel- line M3-TR1	red	the communication link, Data Carrier Detection , is okay on the roving instrument.
		flashing red	the communication link, Data Carrier Detection , is okay on the roving instrument, but signal is weak.
		off	the DCD is not okay.
Power LED	any device	off	power is off.
		green	power is okay.

3.7

LED Indicators

LED indicators on SmartAntenna

Description

The SmartAntenna has Light Emitting Diode indicators. They indicate the basic instrument status.

Diagram (GS12)

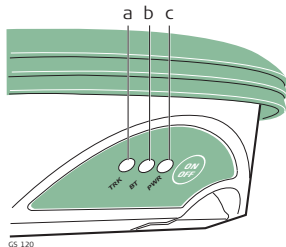

- a) TRK Tracking LED
- b) BT Bluetooth LED
- c) PWR Power LED

Description of the LEDs (GS12)

IF the	is	THEN
BT LED	green	Bluetooth is in data mode and ready for connecting.
	purple	Bluetooth is connecting.
	blue	Bluetooth has connected.
	flashing blue	data is being transferred.
PWR LED	off	power is off.
	green	power is okay.
	flashing green	power is low. The remaining time for which enough power is available depends on the type of survey, the temperature and the age of the battery.
	red	power is very low. The battery should be changed.
TRK LED	off	no satellites are tracked.
	flashing green	less than four satellites are tracked, a position is not yet available.

IF the	is	THEN
	green	enough satellites are tracked to compute a position.
	red	GS12 is initialising.

Diagram (GS15)

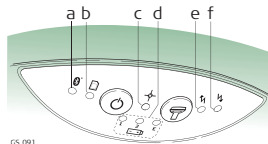

GS_091

- a) Bluetooth LED
- b) Storage LED
- c) Position LED
- d) Power LEDs
- e) RTK Base LED
- f) RTK Rover LED

Description of the LEDs (GS15)

IF the	is	THEN
Bluetooth LED	green	Bluetooth is in data mode and ready for connecting.
	purple	Bluetooth is connecting.

IF the	is	THEN
	blue	Bluetooth has connected.
Storage LED	off	no SD card is inserted or GS15 is switched off.
	green	SD card is inserted but no raw data is being logged.
	flashing green	raw data is being logged.
	flashing yellow	raw data is being logged but only 10% memory left.
	flashing red	raw data is being logged but only 5% memory left.
	red	SD card is full, no raw data is being logged.
	fast flashing red	no SD card is inserted but GS15 is configured to log raw data.
Position LED	off	no satellites are tracked or GS15 is switched off.
	flashing yellow	less than four satellites are tracked, a position is not yet available.
	yellow	a navigated position is available.
	flashing green	a code-only position is available.
	green	a fixed RTK position is available.

IF the	is	THEN
Power LED (active battery ^{*1})	off	battery is not connected, flat or GS15 is switched off.
	green	power is 40% - 100%.
	yellow	power is 20% - 40%. The remaining time for which enough power is available depends on the type of survey, the temperature and the age of the battery.
	red	power is 5% - 20%.
	fast flashing red	power is low (< 5%).
Power LED (passive battery ^{*2})	off	battery is not connected, flat or the GS15 is switched off.
	flashing green	power is 40% - 100%. LED is green for 1 s every 10 s.
	flashing yellow	power is 20% - 40%. LED is yellow for 1 s every 10 s.

IF the	is	THEN
	flashing red	power is less than 20%. LED is red for 1 s every 10 s.
RTK Rover LED	off	GS15 is in RTK base mode or GS15 is switched off.
	green	GS15 is in rover mode. No RTK data is being received at the interface of the communication device.
	flashing green	GS15 is in rover mode. RTK data is being received at the interface of the communication device.
RTK Base LED	off	GS15 is in RTK rover mode or GS15 is switched off.
	green	GS15 is in RTK base mode. No RTK data is being passed to the RX/TX interface of the communication device.
	flashing green	GS15 is in RTK base mode. Data is being passed to the RX/TX interface of the communication device.

*1 The battery, which currently powers the GS15 GNSS instrument.

*2 Other batteries, which are inserted or connected but are not currently power the GS15 GNSS instrument.

LED Indicators on RadioHandle

Description

The RadioHandle has Light Emitting Diode indicators. They indicate the basic RadioHandle status.

Diagram of the LED Indicators

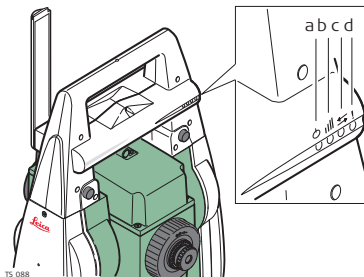

- a) Power LED
- b) Link LED
- c) Data Transfer LED
- d) Mode LED

Description of the LED Indicators

IF the	is	THEN
Power LED	off	power is off.
	green	power is on.

IF the	is	THEN
Link LED	off	no radio link to field controller.
	red	radio link to field controller.
Data Transfer LED	off	no data transfer to/from field controller.
	green or green flashing	data transfer to/from field controller.
Mode LED	off	data mode.
	red	configuration mode.

3.8

Guidelines for Correct Results

Distance measurement

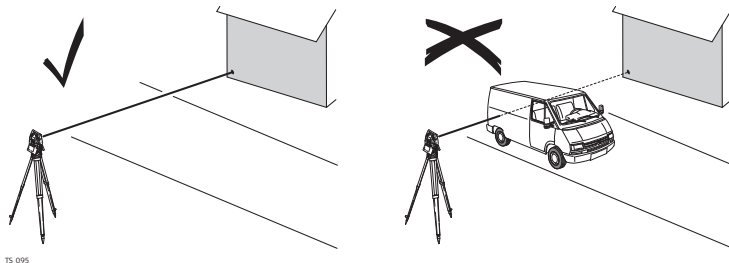

When measurements are being made using the red laser EDM, the results can be influenced by objects passing between the EDM and the intended target surface. This occurs because reflectorless measurements are made to the first surface returning sufficient energy to allow the measurement to take place. For example, if the intended target surface is the surface of a building, but a vehicle passes between the EDM and the target surface as the measurement is triggered, the measurement may be made to the side of the vehicle. The result is the distance to the vehicle, not to the surface of the building.

If using the long range measurement mode (> 1000 m, > 3300 ft) to prisms, and an object passes within 30 m of the EDM as the measurement is triggered, the distance measurement may be similarly effected due to the strength of the laser signal.



Very short distances can also be measured reflectorless in **Prism** mode to well reflecting natural targets. The distances are corrected with the additive constant defined for the active reflector.

**CAUTION**

Due to laser safety regulations and measuring accuracy, using the Long Range Reflectorless EDM is only allowed to prisms that are more than 1000 m (3300 ft) away.



Accurate measurements to prisms should be made in **Prism** mode.



When a distance measurement is triggered, the EDM measures to the object which is in the beam path at that moment. If a temporary obstruction, for example a passing vehicle, heavy rain, fog or snow is between the instrument and the point to be measured, the EDM may measure to the obstruction.



Do not measure with two instruments to the same target simultaneously to avoid getting mixed return signals.

ATR/lock

Instruments equipped with an ATR sensor permit automatic angle and distance measurements to prisms. The prism is sighted with the optical sight. After initiating a distance measurement, the instrument sights the prism centre automatically. Vertical and horizontal angles and the distance are measured to the centre of the prism. The lock mode enables the instrument to follow a moving prism.



As with all other instrument errors, the collimation error of the automatic aiming must be redetermined periodically. Refer to "4 Check & Adjust" about checking and adjusting instruments.



When a measurement is triggered while the prism is still moving, distance and angle measurements may not be made for the same position and coordinates may vary.



If the prism location is changed too quickly, the target may be lost. Make sure that the speed does not exceed the figure given in the technical data.

4 Check & Adjust

4.1 Overview

Description

Leica Geosystems instruments are manufactured, assembled and adjusted to the best possible quality. Quick temperature changes, shock or stress can cause deviations and decrease the instrument accuracy. It is therefore recommended to check and adjust the instrument from time to time. This check and adjust can be done in the field by running through specific measurement procedures. The procedures are guided and must be followed carefully and precisely as described in the following chapters. Some other instrument errors and mechanical parts can be adjusted mechanically.

Electronic adjustment

The following instrument errors can be checked and adjusted electronically:

l, t	Compensator longitudinal and transversal index errors
i	Vertical index error, related to the standing axis
c	Horizontal collimation error, also called line of sight error
a	Tilting axis error
ATR	ATR zero point error for Hz and V - option

If the compensator and the horizontal corrections are activated in the instrument configuration, every angle measured in the daily work is corrected automatically .

Select **Main Menu: Instrument\TPS settings\Level bubble & compensator** to check whether the tilt correction and the horizontal correction are turned on.

View current adjustment errors

To view the adjustment errors currently used, select **Main Menu: User\Check & Adjust** to open the **Check & Adjust Wizard**. Select the option **View the current values**.

Mechanical adjustment

The following instrument parts can be adjusted mechanically:

- Circular level on instrument and tribrach
 - Laser plummet
 - Optical plummet - option on tribrach
 - Allen screws on tripod
-

Precise measurements

To get precise measurements in the daily work, it is important:

- To check and adjust the instrument from time to time.
 - To take high precision measurements during the check and adjust procedures.
 - To measure targets in two faces. Some of the instrument errors are eliminated by averaging the angles from both faces.
 - Refer to "4.2 Preparation" to find more important points.
-



During the manufacturing process, the instrument errors are carefully determined and set to zero. As mentioned above, these errors can change and it is highly recommended to redetermine them in the following situations:

- Before the first use
- Before every high precision survey
- After rough or long transportation
- After long working periods
- After long storage periods
- If the temperature difference between current environment and the temperature at the last calibration is more than 20°C

Summary of errors to be adjusted electronically

Instrument error	Effects Hz	Effects V	Elimination with two face measurement	Automatically corrected with proper adjustment
c - Line of sight error	✓	---	✓	✓
a - Tilting axis error	✓	---	✓	✓
l - Compensator index error	---	✓	✓	✓
t - Compensator index error	✓	---	✓	✓
i - Vertical index error	---	✓	✓	✓
ATR Collimation error	✓	✓	---	✓

4.2

Preparation



Before determining the instrument errors, the instrument has to be levelled using the electronic level. Select **Main Menu: Instrument\TPS settings\Level bubble & compensator** to access the **Level Bubble & Compensator** screen.

The tribrach, the tripod and the underground should be stable and secure from vibrations or other disturbances.



The instrument should be protected from direct sunlight to avoid thermal warming.

It is also recommended to avoid strong heat shimmer and air turbulence. The best conditions are early in the morning or with overcast sky.



Before starting to work, the instrument has to become acclimatised to the ambient temperature. Approximately two minutes per °C of temperature difference from storage to working environment, but at least 15 min, should be taken into account.



Even after adjustment of the ATR, the crosshairs may not be positioned exactly on the centre of the prism after an ATR measurement has been completed. This outcome is a normal effect. The telescope is not normally positioned exactly on the centre of the prism, to speed up the ATR measurement. These small deviations/ATR offsets, are calculated individually for each measurement and corrected electronically. This means that the horizontal and vertical angles are corrected twice: first by the determined ATR errors for Hz and V, and then by the individual small deviations of the current aiming.

Next step

IF the task is to	THEN
adjust a combination of instrument errors	Refer to "4.3 Combined Adjustment (l, t, i, c and ATR)".
adjust the tilting axis	Refer to "4.4 Tilting Axis Adjustment (a)".
adjust the circular level	Refer to "4.5 Adjusting the Circular Level of the Instrument and Tribrach".
adjust the laser/optical plummet	Refer to "4.7 Inspecting the Laser Plummet of the Instrument".
adjust the tripod	Refer to "4.9 Servicing the Tripod".

4.3

Combined Adjustment (I, t, i, c and ATR)

Description

The combined adjustment procedure determines the following instrument errors in one process:



I, t	Compensator longitudinal and transversal index errors
i	Vertical index error, related to the standing axis
c	Horizontal collimation error, also called line of sight error
ATR Hz	ATR zero point error for horizontal angle option
ATR V	ATR zero point error for vertical angle option

Combined adjustment procedure step-by-step

The following table explains the most common settings.

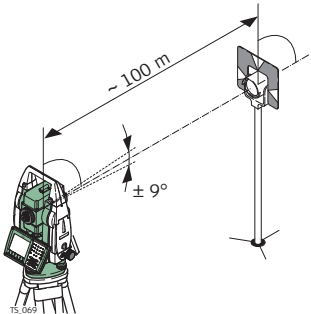
Step	Description
1.	Main Menu: User\Check & Adjust
2.	Check & Adjust Wizard Select the option: Check & adjust the compensator, index error, line of sight error & automatic target aiming
3.	Next
4.	Face I measurement

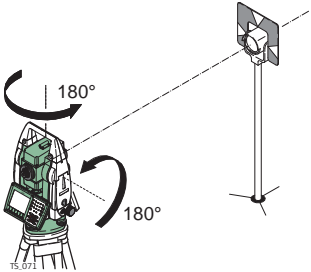
Step	Description
	<p>If Calibrate the automatic target aiming is checked and an ATR is available, the adjustment will include the determination of the ATR Hz and V adjustment errors.</p> <p> Use a clean Leica standard prism as the target. Do not use a 360° prism.</p>
5.	 <p>Aim the telescope accurately at a target at about 100 m distant. The target must be positioned within $\pm 9^\circ/\pm 10$ gon of the horizontal plane. The procedure can be started in any face.</p>

Step	Description
6.	<p>Meas to measure and to continue to the next screen.</p> <p>Motorised instruments change automatically to the other face.</p> <p>Non-motorised instruments guide to the other face.</p> <p> The fine pointing has to be performed manually in both faces.</p> 
7.	<p>Face II measurement</p> <p>Meas to measure the same target in the other face and to calculate the instrument errors.</p>
	<p>If one or more errors are bigger than the predefined limits, the procedure must be repeated. All measurements of the current run are rejected and none of them is averaged with the results from previous runs.</p>

Step	Description
8.	<p>Adjustment Status</p> <p>No. of measurements: Shows the number of runs completed. One run consists of a measurement in face I and face II.</p> <p>σ I Comp: and similar lines show the standard deviations of the determined adjustment errors. The standard deviations can be calculated from the second run onwards.</p>
	Measure at least two runs.
9.	Next to continue with the check & adjust procedure.
10.	<p>Select Add another calibration loop if more runs have to be added. Next and continue with step 4.</p> <p>OR</p> <p>Select Finish the calibration & store the results to finish the calibration process. Next to view the adjustment results.</p>
11.	<p>Select Finish to accept the results. No more runs can be added later.</p> <p>OR</p> <p>Select Redo to decline all measurements and to repeat all calibration runs.</p> <p>OR</p>

Step	Description
	Back returns to the previous screen.

Next step

IF the results are	THEN
to be stored	If the Use status is set to Yes, Next overwrites the old adjustment errors with the new ones.
to be determined again	Redo rejects all new determined adjustment errors and repeats the whole procedure. Refer to paragraph "Combined adjustment procedure step-by-step".

4.4 Tilting Axis Adjustment (a)

Description

This adjustment procedure determines the following instrument error:



- a Tilting axis error
-

Determination of tilting axis error step-by-step

The following table explains the most common settings.

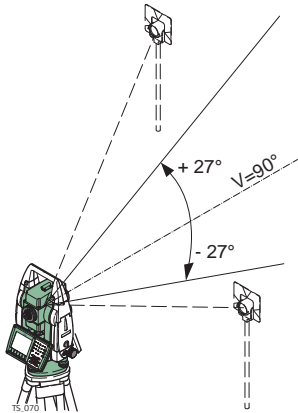
Step	Description
	Determine the horizontal collimation error (c) before starting this procedure.
1.	Main Menu: User\Check & Adjust
2.	Check & Adjust Wizard Select the option: Check & adjust the tilting axis

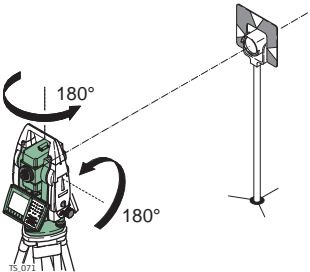
Step	Description
3.	<p data-bbox="474 156 744 182">Face I measurement</p>  <p data-bbox="976 187 1365 446">Aim the telescope accurately at a target at about 100 m distance or less if not possible. The target must be positioned at least 27°/30 gon above or beneath the horizontal plane. The procedure can be started in any telescope face.</p>

Step	Description
4.	<p>Meas to measure and to continue to the next screen.</p> <p>Motorised instruments change automatically to the other face.</p> <p>Non-motorised instruments guide to the other face.</p> <p> The fine pointing must be performed manually in both faces.</p> 
5.	<p>Face II measurement</p> <p>Meas to measure the same target in the other face and to calculate the tilting axis error.</p>
	<p>If the error is bigger than the predefined limit, the procedure must be repeated. The tilting axis measurements of the current run are then rejected and not averaged with the results from previous runs.</p>

Step	Description
6.	<p>Adjustment Status</p> <p>No. of measurements: Shows the number of runs completed. One run consists of a measurement in face I and face II.</p> <p>σ a T-axis: shows the standard deviation of the determined tilting axis error. The standard deviation can be calculated from the second run onwards.</p>
	Measure at least two runs.
7.	<p>Next to continue with the check & adjust procedure.</p>
8.	<p>Select Add another calibration loop if more runs have to be added. Next and continue with step 3.</p> <p>OR</p> <p>Select Finish the calibration & store the results to finish the calibration process. No more runs can be added later. Next to view the adjustment results.</p>
9.	<p>Select Finish to accept the results. No more runs can be added later.</p> <p>OR</p> <p>Select Redo to decline all measurements and to repeat all calibration runs.</p>

Next step

IF the results are	THEN
to be stored	Next overwrites the old tilting axis error with the new one.
to be determined again	Redo rejects the new determined tilting axis error and repeats the whole procedure. Refer to paragraph "Determination of tilting axis error step-by-step".

4.5 Adjusting the Circular Level of the Instrument and Tribrach

Adjusting the circular level step-by-step

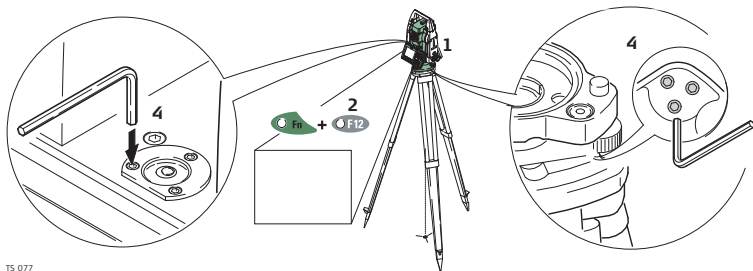

TS.077



Step	Description
1.	Place and secure the instrument into the tribrach and onto a tripod.
2.	Using the tribrach footscrews, level the instrument with the electronic level.
3.	Select Instrument\TPS settings\Level bubble & compensator to access the Level Bubble & Compensator screen.
4.	Check the position of the circular level on the instrument and tribrach.

Step	Description
5.	a) If both circular levels are centred, no adjustments are necessary
	b) If one or both circular levels are not centred, adjust as follows:
	Instrument: If it extends beyond the circle, use the supplied allen key to centre it with the adjustment screws. Turn the instrument by 200 gon (180°). Repeat the adjustment procedure if the circular level does not stay centred.
	Tribrach: If it extends beyond the circle, use the supplied allen key to centre it with the adjustment screws.
	After the adjustments, all adjusting screws must have the same tightening tension and no adjusting screw should be loose.

4.6

Adjusting the Circular Level of the Prism Pole

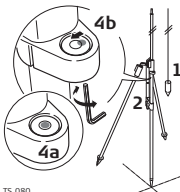
Adjusting the circular level step-by-step

Step	Description	
1.	Suspend a plumb line.	
2.	Use a pole bipod, to align the prism pole parallel to the plumb line.	
3.	Check the position of the circular level on the prism pole.	
4.	a) If the circular level is centred, no adjustment is necessary.	
	b) If the circular level is not centred, use an allen key to centre it with the adjustment screws.	
	After the adjustments, all adjusting screws must have the same tightening tension and no adjusting screw should be loose.	

4.7 Inspecting the Laser Plummet of the Instrument



The laser plummet is located in the vertical axis of the instrument. Under normal conditions of use, the laser plummet does not need adjusting. If an adjustment is necessary due to external influences, return the instrument to any Leica Geosystems authorised service workshop.

Inspecting the laser plummet step-by-step

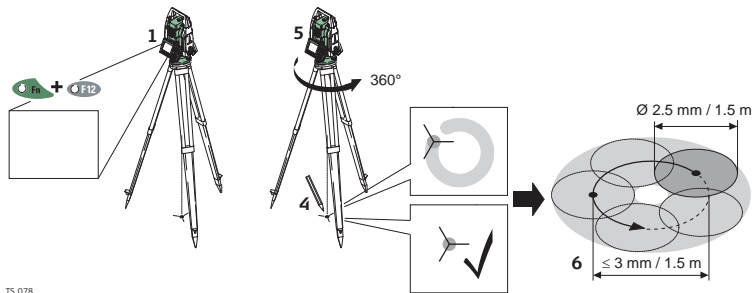

TS_078

The following table explains the most common settings.

Step	Description
1.	Place and secure the instrument into the tribrach and onto a tripod.
2.	Using the tribrach footscrews, level the instrument with the electronic level.
3.	Select Instrument\TPS settings\Level bubble & compensator to access the Level Bubble & Compensator screen.
4.	The laser plummet is switched on when the Level Bubble & Compensator screen is entered. Adjust the laser plummet intensity. Inspection of the laser plummet should be carried out on a bright, smooth and horizontal surface, like a sheet of paper.
5.	Mark the centre of the red dot on the ground.
6.	Turn the instrument through 360° slowly, carefully observing the movement of the red laser dot.
	The maximum diameter of the circular movement described by the centre of the laser point must not exceed 3 mm at a distance of 1.5 m.
7.	If the centre of the laser dot describes a perceptible circular movement, or moves more than 3 mm away from the point which was first marked, an adjustment may be required. Inform your nearest Leica Geosystems authorised service workshop. Depending on brightness and surface, the diameter of the laser dot can vary. At 1.5 m, it is about 2.5 mm.

4.8 Adjusting the Laser Guide



To avoid moisture or dust entering the Laser Guide compartment, adjustment screws and screw covers must be fixed after each adjustment procedure.

Adjustment

The recommended adjustment procedure is designed for distances of 50 m and 120 m. Use the adjustment drawing, which is showing a TS15 G telescope, with crosshairs for line of sight and Laser Guide. Look through the telescope and aim to the crosshairs of the telescope. For well-adjusted Laser Guides, the laser beam should exactly match the circles for 50/120 m.



Make sure, adjustment screws are accessible during adjustment.



Make sure, the position of the telescope remains still. Check the target by looking through the telescope.



Adjustment procedure might be repeated to achieve high precision adjustment.

Adjustment

Please enlarge this target plate to 200% prior to using it for adjustment.

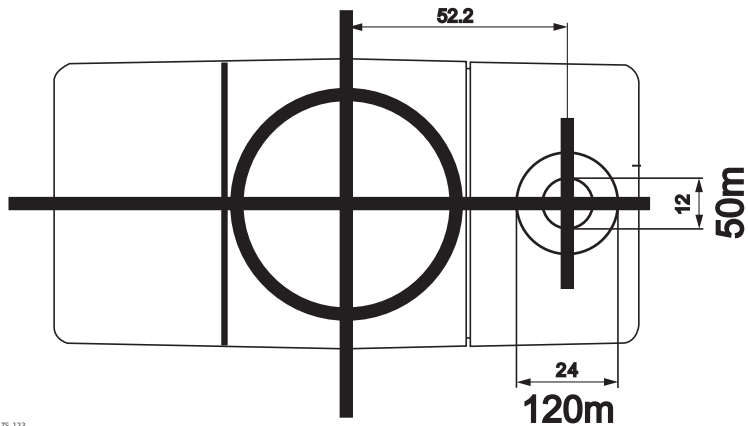

TS.123

Laser guide screws

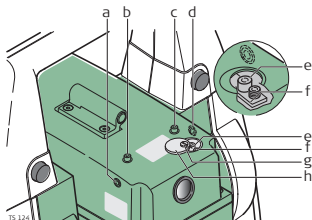



- a) Horizontal adjustment screw
- b) Fixing screw
- c) Fixing screw
- d) Horizontal adjustment screw
- e) Vertical adjustment screw
- f) Vertical adjustment screw
- g) Safety cover screw
- h) Safety cover

Laser Guide adjustment step-by-step

This step-by-step description describes the Laser Guide adjustment for a distance of 50 m. Place the target plate at a distance of 120 m to perform the laser guide adjustment for 120 m.

Step	Description
	Make sure that the instrument is levelled.
1.	Place the laser guide target plate at a distance of 50 m and aim with the telescope of the instrument at the crosshairs of the target plate.
2.	Loosen the safety cover screw (g) and move the safety cover (h) to the side to access the vertical adjustment screws.

Step	Description
3.	Loosen the vertical adjustment screws (e) and (f). Do not fully remove the screws.
4.	Loosen the fixing screws (b) and (c) as little as the spring force remains.
5.	<p>Horizontal adjustment: To adjust the laser guide to the left, loosen the horizontal adjustment screw (d). Tighten the horizontal adjustment screw (a) as much as to move the laser beam slightly left of the upper crosshairs on the target plate.</p>
6.	To adjust the laser guide to the right, loosen the horizontal adjustment screw (a). Tighten the horizontal adjustment screw (d) as much as to move the laser beam slightly right of the upper crosshairs on the target plate.
7.	<p>Fix the horizontal adjustment by tightening the opposite horizontal adjustment screw either (a) or (d).</p> <p> Fixing the opposite screw moves the laser beam exactly to the vertical crosshair.</p>
8.	Finish the horizontal adjustment by tightening the fixing screws (b) and (c).
9.	<p>Vertical adjustment: Loosen the vertical adjustment screw (e) as much as to move the laser beam slightly upon of the upper crosshairs on the target plate.</p>

Step	Description
10.	Fix the vertical adjustment by tightening the vertical adjustment screw (f).  Fixing this screw moves the laser beam exactly to the crosshairs centre.
11.	Finish the vertical adjustment by moving the safety cover (h) to its original position and by tightening the safety cover screw (g).
	The laser beam of an adjusted laser guide matches exactly the circle of 50 m or 120 m depending on the distance.

4.9

Servicing the Tripod

Servicing the tripod step-by-step

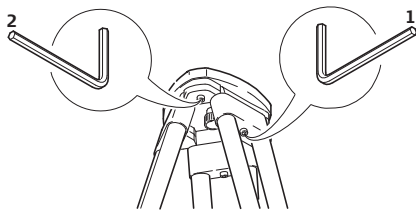

TS_076

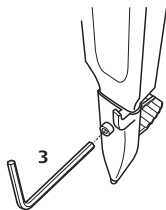

The following table explains the most common settings.

Step	Description
	The connections between metal and timber components must always be firm and tight.
1.	Tighten the leg cap screws moderately, with the supplied allen key.
2.	Tighten the articulated joints on the tripod head enough to keep the tripod legs open when lifting the tripod off the ground.
3.	Tighten the allen screws of the tripod legs.

5 Care and Transport

5.1 Transport

Transport in the field

When transporting the equipment in the field, always make sure that you

- either carry the product in its original transport container,
 - or carry the tripod with its legs splayed across your shoulder, keeping the attached product upright.
-

Transport in a road vehicle

Never carry the product loose in a road vehicle, as it can be affected by shock and vibration. Always carry the product in its transport container and secure it.

Shipping

When transporting the product by rail, air or sea, always use the complete original Leica Geosystems packaging, transport container and cardboard box, or its equivalent, to protect against shock and vibration.

Shipping, transport of batteries

When transporting or shipping batteries, the person in charge of the product must ensure that the applicable national and international rules and regulations are observed. Before transportation or shipping, contact your local passenger or freight transport company.

Field adjustment

After transport inspect the field adjustment parameters given in this user manual before using the product.

5.2

Storage

Product

Respect the temperature limits when storing the equipment, particularly in summer if the equipment is inside a vehicle. Refer to "7 Technical Data" for information about temperature limits.

Field adjustment

After long periods of storage inspect the field adjustment parameters given in this user manual before using the product.

Li-Ion batteries

- Refer to "7 Technical Data" for information about storage temperature range.
 - At the recommended storage temperature range, batteries containing a 10% to 50% charge can be stored for up to one year. After this storage period the batteries must be recharged.
 - Remove batteries from the product and the charger before storing.
 - After storage recharge batteries before using.
 - Protect batteries from damp and wetness. Wet or damp batteries must be dried before storing or use.
 - A storage temperature range of -20°C to +30°C/-4°F to 86°F in a dry environment is recommended to minimise self-discharging of the battery.
-

5.3 Cleaning and Drying

Product and accessories

- Blow dust off lenses and prisms.
- Never touch the glass with your fingers.
- Use only a clean, soft, lint-free cloth for cleaning. If necessary, moisten the cloth with water or pure alcohol. Do not use other liquids; these can attack the polymer components.

Fogging of prisms

Prisms that are cooler than the ambient temperature tend to fog. It is not enough simply to wipe them. Keep them for some time inside your jacket or in the vehicle to allow them to adjust to the ambient temperature.

Damp products

Dry the product, the transport container, the foam inserts and the accessories at a temperature not greater than 40°C /104°F and clean them. Do not repack until everything is completely dry. Always close the transport container when using in the field.

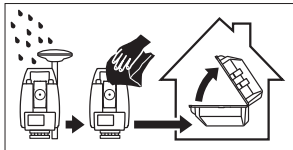

Cables and plugs

Keep plugs clean and dry. Blow away any dirt lodged in the plugs of the connecting cables.

5.4

Maintenance

Motorisation

An inspection of the motorisation in motorised instruments must be done in a Leica Geosystems authorised service workshop.

Following conditions:

- After about 4000 hours operation.
 - Twice a year in case of permanent use of the instrument, for example in monitoring applications.
-

6

Safety Directions

6.1

General Introduction

Description

The following directions enable the person responsible for the product, and the person who actually uses the equipment, to anticipate and avoid operational hazards.

The person responsible for the product must ensure that all users understand these directions and adhere to them.

6.2

Intended Use

Permitted use

- Measuring horizontal and vertical angles.
 - Measuring distances.
 - Recording measurements.
 - Capturing images.
 - Automatic target search, recognition and -tracking.
 - Visualising the aiming direction and vertical axis.
 - Remote control of product.
 - Data communication with external appliances.
 - Measuring raw data and computing coordinates using carrier phase and code signal from GNSS satellites.
 - Carrying out measurement tasks using various GNSS measuring techniques.
 - Recording GNSS and point related data.
 - Computing with software.
-

Adverse use

- Use of the product without instruction.
- Use outside of the intended limits.
- Disabling safety systems.
- Removal of hazard notices.
- Opening the product using tools, for example screwdriver, unless this is permitted for certain functions.
- Modification or conversion of the product.
- Use after misappropriation.
- Use of products with recognisable damages or defects.
- Use with accessories from other manufacturers without the prior explicit approval of Leica Geosystems.
- Aiming directly into the sun.
- Inadequate safeguards at the working site, for example when measuring on roads.
- Deliberate dazzling of third parties.
- Controlling of machines, moving objects or similar monitoring application without additional control- and safety installations.



WARNING

Adverse use can lead to injury, malfunction and damage.

It is the task of the person responsible for the equipment to inform the user about hazards and how to counteract them. The product is not to be operated until the user has been instructed on how to work with it.

6.3

Limits of Use

Environment

Suitable for use in an atmosphere appropriate for permanent human habitation: not suitable for use in aggressive or explosive environments.



DANGER

Local safety authorities and safety experts must be contacted before working in hazardous areas, or close to electrical installations or similar situations by the person in charge of the product.

6.4

Responsibilities

Manufacturer of the product

Leica Geosystems AG, CH-9435 Heerbrugg, hereinafter referred to as Leica Geosystems, is responsible for supplying the product, including the user manual and original accessories, in a safe condition.

Manufacturers of non Leica Geosystems accessories

The manufacturers of non Leica Geosystems accessories for the product are responsible for developing, implementing and communicating safety concepts for their products, and are also responsible for the effectiveness of those safety concepts in combination with the Leica Geosystems product.

Person in charge of the product

The person in charge of the product has the following duties:

- To understand the safety instructions on the product and the instructions in the user manual.
 - To be familiar with local regulations relating to safety and accident prevention.
 - To inform Leica Geosystems immediately if the product and the application becomes unsafe.
 - To ensure that the national laws, regulations and conditions for the operation of radio transmitters are respected.
-



WARNING

The person responsible for the product must ensure that it is used in accordance with the instructions. This person is also accountable for the training and the deployment of personnel who use the product and for the safety of the equipment in use.

6.5

Hazards of Use



WARNING

The absence of instruction, or the inadequate imparting of instruction, can lead to incorrect or adverse use, and can cause accidents with far-reaching human, material, financial and environmental consequences.

Precautions:

All users must follow the safety directions given by the manufacturer and the directions of the person responsible for the product.



CAUTION

Watch out for erroneous measurement results if the product has been dropped or has been misused, modified, stored for long periods or transported.

Precautions:

Periodically carry out test measurements and perform the field adjustments indicated in the user manual, particularly after the product has been subjected to abnormal use and before and after important measurements.



DANGER

Because of the risk of electrocution, it is dangerous to use poles and extensions in the vicinity of electrical installations such as power cables or electrical railways.

Precautions:

Keep at a safe distance from electrical installations. If it is essential to work in this environment, first contact the safety authorities responsible for the electrical installations and follow their instructions.

**CAUTION**

With the remote control of products, it is possible that extraneous targets will be picked out and measured.

Precautions:

When measuring in remote control mode, always check your results for plausibility.

CAUTION

Be careful when pointing the product towards the sun, because the telescope functions as a magnifying glass and can injure your eyes and/or cause damage inside the product.

Precautions:

Do not point the product directly at the sun.

WARNING

During dynamic applications, for example stakeout procedures there is a danger of accidents occurring if the user does not pay attention to the environmental conditions around, for example obstacles, excavations or traffic.

Precautions:

The person responsible for the product must make all users fully aware of the existing dangers.

 **WARNING**

Inadequate securing of the working site can lead to dangerous situations, for example in traffic, on building sites, and at industrial installations.

Precautions:

Always ensure that the working site is adequately secured. Adhere to the regulations governing safety and accident prevention and road traffic.

 **WARNING**

If computers intended for use indoors are used in the field there is a danger of electric shock.

Precautions:

Adhere to the instructions given by the computer manufacturer regarding field use with Leica Geosystems products.



 **CAUTION**

If the accessories used with the product are not properly secured and the product is subjected to mechanical shock, for example blows or falling, the product may be damaged or people can sustain injury.

Precautions:

When setting-up the product, make sure that the accessories are correctly adapted, fitted, secured, and locked in position.

Avoid subjecting the product to mechanical stress.

-
-  **WARNING** If the product is used with accessories, for example masts, staffs, poles, you may increase the risk of being struck by lightning.
Precautions:
Do not use the product in a thunderstorm.
-
-  **WARNING** Using a battery charger not recommended by Leica Geosystems can destroy the batteries. This can cause fire or explosions.
Precautions:
Only use chargers recommended by Leica Geosystems to charge the batteries.
-
-  **CAUTION** During the transport, shipping or disposal of batteries it is possible for inappropriate mechanical influences to constitute a fire hazard.
Precautions:
Before shipping the product or disposing of it, discharge the batteries by running the product until they are flat.
When transporting or shipping batteries, the person in charge of the product must ensure that the applicable national and international rules and regulations are observed. Before transportation or shipping contact your local passenger or freight transport company.
-

**WARNING**

High mechanical stress, high ambient temperatures or immersion into fluids can cause leakage, fire or explosions of the batteries.

Precautions:

Protect the batteries from mechanical influences and high ambient temperatures. Do not drop or immerse batteries into fluids.

**WARNING**

If battery terminals come in contact with jewellery, keys, metallised paper or other metals, short circuited battery terminals can overheat and cause injury or fire, for example by storing or transporting in pockets.

Precautions:

Make sure that the battery terminals do not come into contact with metallic objects.

**WARNING**

If the product is improperly disposed of, the following can happen:

- If polymer parts are burnt, poisonous gases are produced which may impair health.
- If batteries are damaged or are heated strongly, they can explode and cause poisoning, burning, corrosion or environmental contamination.
- By disposing of the product irresponsibly you may enable unauthorised persons to use it in contravention of the regulations, exposing themselves and third parties to the risk of severe injury and rendering the environment liable to contamination.

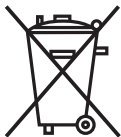
Precautions:

The product must not be disposed with household waste.
Dispose of the product appropriately in accordance with the national regulations in force in your country.
Always prevent access to the product by unauthorised personnel.

Product-specific treatment and waste management information can be downloaded from the Leica Geosystems home page at <http://www.leica-geosystems.com/treatment> or received from your Leica Geosystems dealer.

**WARNING**

Only Leica Geosystems authorised service workshops are entitled to repair these products.

6.6

Laser Classification

6.6.1

General

General

The following chapters provide instructions and training information for the safe use of lasers according to international standard IEC 60825-1 (2007-03) and technical report IEC TR 60825-14 (2004-02). The information enables the person responsible for the product and the person who actually uses the equipment, to anticipate and avoid operational hazards.

The person responsible for the product must ensure that everyone understands the instructions and adheres to them.



According to IEC TR 60825-14 (2004-02), products classified as laser class 1, class 2 and class 3R do not require:

- mandatory involvement of a laser safety officer,
- protective clothes and eyewear,
- special warning signs in the laser working area

due to the low level eye hazard and if used and operated as defined in this User Manual.



National laws and local regulations could impose more stringent instructions for the safe use of lasers than IEC 60825-1 (2007-03) and IEC TR 60825-14.

6.6.2

Distancer, Measurements with Reflectors

General

The EDM module built into the product produces a visible laser beam which emerges from the telescope objective.

The laser product described in this section is classified as laser class 1 in accordance with:

- IEC 60825-1 (2007-03): "Safety of laser products"
- EN 60825-1 (2007-10): "Safety of laser products"

Class 1 laser products are safe under reasonably foreseeable conditions of operation and are not harmful to the eyes provided that the products are used and maintained in accordance with this User Manual.

Description	Value
Maximum average radiant power	0.33 mW
Pulse duration	800 ps
Pulse repetition frequency	100 MHz - 150 MHz
Wavelength	650 nm - 690 nm

Labelling

Class 1 Laser Product
according to IEC 60825-1
(2007 - 03)

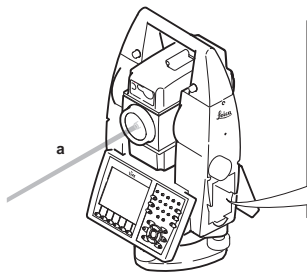

TS_096

a) Laser beam

Type: TS.... Art.No.:

Equip.No.: S.No.:

Power: 12V/7,4V mm, 1A max

Leica Geosystems AG

CH-9435 Heerbrugg

Manufactured:

Made in Switzerland

Complies with FDA performance standards for laser products except for deviations pursuant to Laser Notice No.50, dated June 24, 2007.

This device complies with part 15 of the FCC Rules. Operation is subject to the following two conditions:
(1) This device may not cause harmful interference, and
(2) this device must accept any interference received, including interference that may cause undesired operation.

6.6.3

Distancer, Measurements without Reflectors

General

The EDM module built into the product produces a visible laser beam which emerges from the telescope objective.

The laser product described in this section is classified as laser class 3R in accordance with:

- IEC 60825-1 (2007-03): "Safety of laser products"
- EN 60825-1 (2007-10): "Safety of laser products"

Class 3R laser products:

Direct intrabeam viewing may be hazardous (low eye hazard level), in particular for deliberate ocular exposure. The beam may cause dazzle, flash-blindness and after-images, particularly under low ambient light conditions. The risk of injury for laser class 3R products is limited because of:

- a) unintentional exposure would rarely reflect worst case conditions of (e.g.) beam alignment with the pupil, worst case accommodation,
- b) inherent safety margin in the maximum permissible exposure to laser radiation (MPE)
- c) natural aversion behaviour for exposure to bright light for the case of visible radiation.

Description	Value (R400/R1000)
Maximum average radiant power	5.00 mW
Pulse duration	800 ps
Pulse repetition frequency	100 MHz - 150 MHz
Wavelength	650 nm - 690 nm
Beam divergence	0.2 mrad x 0.3 mrad
NOHD (Nominal Ocular Hazard Distance) @ 0.25s	80 m / 262 ft



CAUTION

From a safety perspective, class 3R laser products should be treated as potentially hazardous.

Precautions:

- 1) Prevent direct eye exposure to the beam.
- 2) Do not direct the beam at other people.

**CAUTION**

Potential hazards are not only related to direct beams but also to reflected beams aimed at reflecting surfaces such as prisms, windows, mirrors, metallic surfaces, and so on.

Precautions:

- 1) Do not aim at areas that are essentially reflective, such as a mirror, or which could emit unwanted reflections.
 - 2) Do not look through or beside the optical sight at prisms or reflecting objects when the laser is switched on, in laser pointer or distance measurement mode. Aiming at prisms is only permitted when looking through the telescope.
-

Labelling

Laser Aperture

Laser Radiation
Avoid direct eye exposure
Class 3R Laser Product according to
IEC 60825-1
(2007 - 03)
 $P_o \leq 5.00 \text{ mW}$
 $\lambda = 650\text{-}690 \text{ nm}$

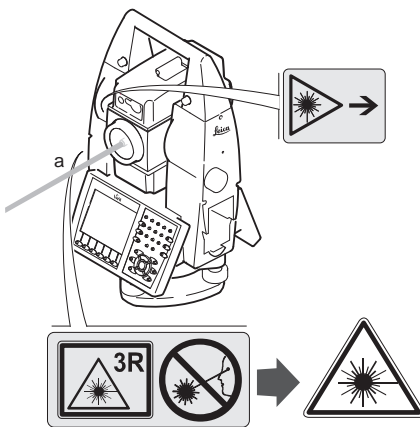

TS.097

a) Laser beam

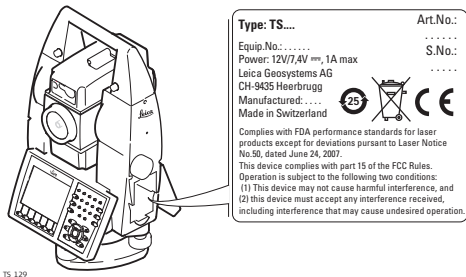

TS_129

6.6.4

Automatic Target Aiming ATR

General

The Automatic Target Aiming built into the product produces an invisible laser beam which emerges from the telescope objective.

The laser product described in this section is classified as laser class 1 in accordance with:

- IEC 60825-1 (2007-03): "Safety of laser products"
- EN 60825-1 (2007-10): "Safety of laser products"

Class 1 laser products are safe under reasonably foreseeable conditions of operation and are not harmful to the eyes provided that the products are used and maintained in accordance with this User Manual.

Description	Value
Maximum average radiant power	10 mW
Pulse duration	11 ms
Pulse repetition frequency	37 Hz
Wavelength	785 nm

Labelling

Class 1 Laser Product
according to IEC 60825-1
(2007 - 03)

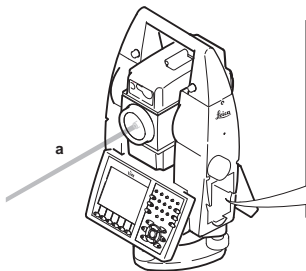

TS_096

a) Laser beam

Type: TS....	Art.No.:
Equip.No.:	S.No.:
Power: 12V/7,4V ^{nom} , 1A max	
Leica Geosystems AG	
CH-9435 Heerbrugg	
Manufactured:	
Made in Switzerland	

Complies with FDA performance standards for laser products except for deviations pursuant to Laser Notice No.50, dated June 24, 2007.

This device complies with part 15 of the FCC Rules. Operation is subject to the following two conditions:

(1) This device may not cause harmful interference, and
(2) this device must accept any interference received, including interference that may cause undesired operation.

6.6.5

PowerSearch PS

General

The PowerSearch built into the product produces an invisible laser beam which emerges from the front side of the telescope.

The laser product described in this section is classified as laser class 1 in accordance with:

- IEC 60825-1 (2007-03): "Safety of laser products"
- EN 60825-1 (2007-10): "Safety of laser products"

Class 1 laser products are safe under reasonably foreseeable conditions of operation and are not harmful to the eyes provided that the products are used and maintained in accordance with this User Manual.

Description	Value
Maximum average radiant power	11 mW
Pulse duration	20 ns, 40 ns
Pulse repetition frequency	24.4 kHz
Wavelength	850 nm

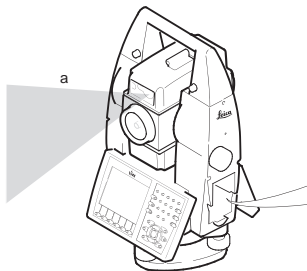

Labelling

Class 1 Laser Product
according to IEC 60825-1
(2007 - 03)



TS_098

a) Laser beam

Type: TS....	Art.No.:
Equip.No.:	S.No.:
Power: 12V/7,4V ~~, 1A max	
Leica Geosystems AG	
CH-9435 Heerbrugg	
Manufactured:	
Made in Switzerland	  

Complies with FDA performance standards for laser products except for deviations pursuant to Laser Notice No.50, dated June 24, 2007.
This device complies with part 15 of the FCC Rules.
Operation is subject to the following two conditions:
(1) This device may not cause harmful interference, and
(2) this device must accept any interference received, including interference that may cause undesired operation.

6.6.6

Electronic Guide Light EGL

General

The Electronic Guide Light built into the product produces a visible LED beam which emerges from the front side of the telescope.



The product described in this section, is excluded from the scope of IEC 60825-1 (2007-03): "Safety of laser products".

The product described in this section, is classified as exempt group in accordance with IEC 62471 (2006-07) and does not pose any hazard provided that the product is used and maintained in accordance with this user manual.

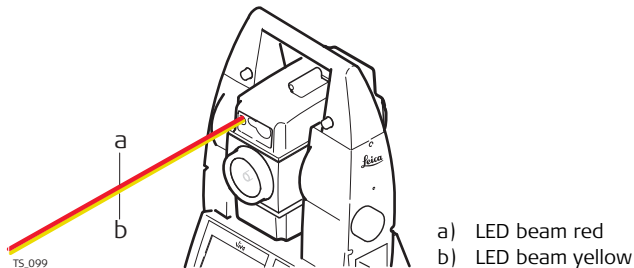

6.6.7

Laser Plummet

General

The laser plummet built into the product produces a visible red laser beam which emerges from the bottom of the product.

The laser product described in this section is classified as laser class 2 in accordance with:

- IEC 60825-1 (2007-03): "Safety of laser products"
- EN 60825-1 (2007-10): "Safety of laser products"

Class 2 laser products:

These products are safe for momentary exposures but can be hazardous for deliberate staring into the beam. The beam may cause dazzle, flash-blindness and after-images, particularly under low ambient light conditions.

Description	Value
Maximum average radiant power	0.95 mW
Pulse duration	c.w.
Pulse repetition frequency	c.w.
Wavelength	635 nm



CAUTION

From a safety perspective, class 2 laser products are not inherently safe for the eyes.

Precautions:

- 1) Avoid staring into the beam.
 - 2) Avoid pointing the beam at other people.
-

Labelling

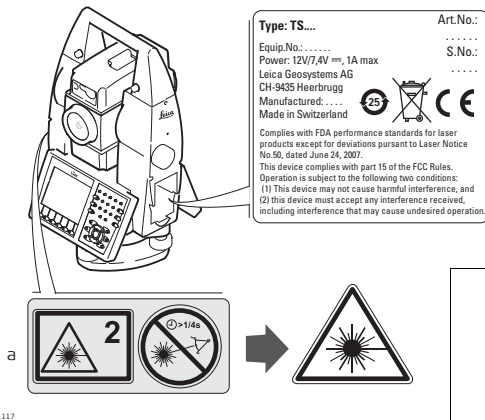

a) Will be replaced by a class 3R warning label if applicable

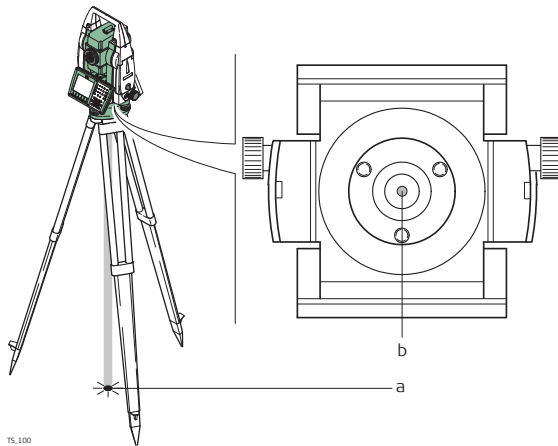

TS_100

- a) Laser beam
- b) Exit for laser beam

6.6.8

Laser Guide

General

The Laser Guide built into the TS15 G instrument produces a visible red laser beam which emerges from the front side of the telescope.

The laser product described in this section is classified as laser class 3R in accordance with:

- IEC 60825-1 (2007-03): "Safety of laser products"
- EN 60825-1 (2007-10): "Safety of laser products"

Class 3R laser products:

Direct intrabeam viewing may be hazardous (low eye hazard level), in particular for deliberate ocular exposure. The beam may cause dazzle, flash-blindness and after-images, particularly under low ambient light conditions. The risk of injury for laser class 3R products is limited because of:

- a) unintentional exposure would rarely reflect worst case conditions of (e.g.) beam alignment with the pupil, worst case accommodation,
- b) inherent safety margin in the maximum permissible exposure to laser radiation (MPE)
- c) natural aversion behaviour for exposure to bright light for the case of visible radiation.

Description	Value (R400/R1000)
Maximum radiant power	4.75 mW
Pulse duration	c.w.
Pulse repetition frequency	c.w.
Wavelength	650 nm - 690 nm
Beam divergence	0.1 mrad
NOHD (Nominal Ocular Hazard Distance) @ 0.25s	112 m / 367 ft



CAUTION

From a safety perspective, class 3R laser products should be treated as potentially hazardous.

Precautions:

- 1) Prevent direct eye exposure to the beam.
- 2) Do not direct the beam at other people.

**CAUTION**

Potential hazards are not only related to direct beams but also to reflected beams aimed at reflecting surfaces such as prisms, windows, mirrors, metallic surfaces, and so on.

Precautions:

- 1) Do not aim at areas that are essentially reflective, such as a mirror, or which could emit unwanted reflections.
 - 2) Do not look through or beside the optical sight at prisms or reflecting objects when the laser is switched on, in laser pointer or distance measurement mode. Aiming at prisms is only permitted when looking through the telescope.
-

Labelling

Laser Aperture

Laser Radiation
Avoid direct eye exposure
Class 3R Laser Product according to
IEC 60825-1
(2007 - 03)
 $P_o \leq 4.75 \text{ mW}$
 $\lambda = 650\text{-}690 \text{ nm}$

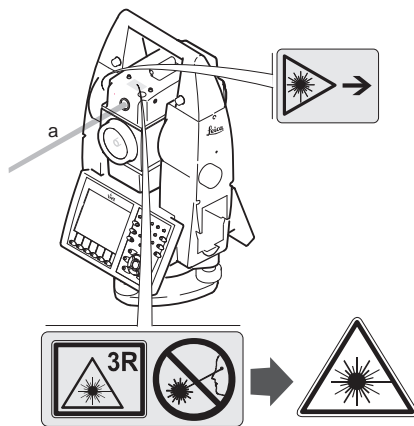

TS.125

a) Laser beam

6.7

Electromagnetic Compatibility EMC

Description

The term Electromagnetic Compatibility is taken to mean the capability of the product to function smoothly in an environment where electromagnetic radiation and electrostatic discharges are present, and without causing electromagnetic disturbances to other equipment.



WARNING

Electromagnetic radiation can cause disturbances in other equipment.

Although the product meets the strict regulations and standards which are in force in this respect, Leica Geosystems cannot completely exclude the possibility that other equipment may be disturbed.



CAUTION

There is a risk that disturbances may be caused in other equipment if the product is used with accessories from other manufacturers, for example field computers, personal computers, two-way radios, non-standard cables or external batteries.

Precautions:

Use only the equipment and accessories recommended by Leica Geosystems. When combined with the product, they meet the strict requirements stipulated by the guidelines and standards. When using computers and two-way radios, pay attention to the information about electromagnetic compatibility provided by the manufacturer.

**CAUTION**

Disturbances caused by electromagnetic radiation can result in erroneous measurements.

Although the product meets the strict regulations and standards which are in force in this respect, Leica Geosystems cannot completely exclude the possibility that the product may be disturbed by intense electromagnetic radiation, for example, near radio transmitters, two-way radios or diesel generators.

Precautions:

Check the plausibility of results obtained under these conditions.

**WARNING**

If the product is operated with connecting cables attached at only one of their two ends, for example external supply cables, interface cables, the permitted level of electromagnetic radiation may be exceeded and the correct functioning of other products may be impaired.

Precautions:

While the product is in use, connecting cables, for example product to external battery, product to computer, must be connected at both ends.

Radios or digital cellular phones



WARNING

Use of product with radio or digital cellular phone devices:

Electromagnetic fields can cause disturbances in other equipment, in installations, in medical devices, for example pacemakers or hearing aids and in aircraft. It can also affect humans and animals.

Precautions:

Although the product meets the strict regulations and standards which are in force in this respect, Leica Geosystems cannot completely exclude the possibility that other equipment can be disturbed or that humans or animals can be affected.

- Do not operate the product with radio or digital cellular phone devices in the vicinity of filling stations or chemical installations, or in other areas where an explosion hazard exists.
 - Do not operate the product with radio or digital cellular phone devices near to medical equipment.
 - Do not operate the product with radio or digital cellular phone devices in aircraft.
-

6.8

FCC Statement, Applicable in U.S.



The greyed paragraph below is only applicable for products without radio.



WARNING

This equipment has been tested and found to comply with the limits for a Class B digital device, pursuant to part 15 of the FCC rules.

These limits are designed to provide reasonable protection against harmful interference in a residential installation.

This equipment generates, uses and can radiate radio frequency energy and, if not installed and used in accordance with the instructions, may cause harmful interference to radio communications. However, there is no guarantee that interference will not occur in a particular installation.

If this equipment does cause harmful interference to radio or television reception, which can be determined by turning the equipment off and on, the user is encouraged to try to correct the interference by one or more of the following measures:

- Reorient or relocate the receiving antenna.
 - Increase the separation between the equipment and the receiver.
 - Connect the equipment into an outlet on a circuit different from that to which the receiver is connected.
 - Consult the dealer or an experienced radio/TV technician for help.
-

WARNING

Changes or modifications not expressly approved by Leica Geosystems for compliance could void the user's authority to operate the equipment.

Labelling TS11/TS15

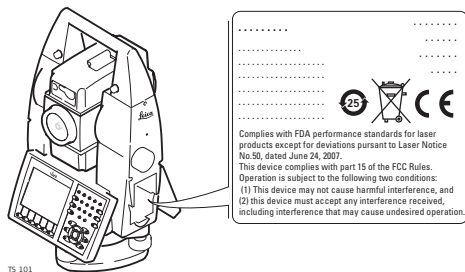

Labelling GS12

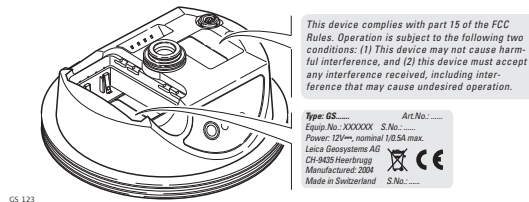

Labelling GS15

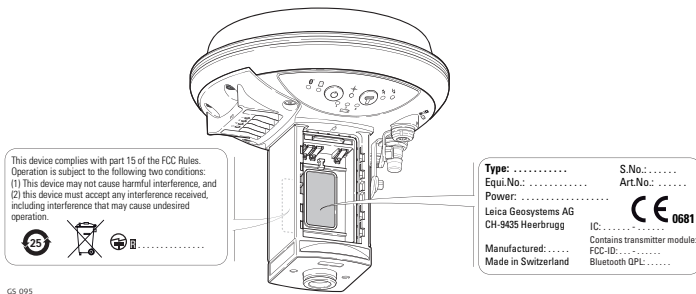

Labelling internal battery GEB221

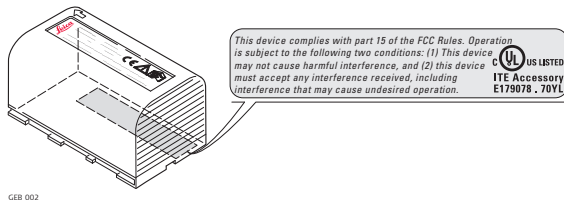

Labelling internal battery GEB211, GEB212



This device complies with part 15 of the FCC Rules. Operation is subject to the following two conditions: (1) This device may not cause harmful interference, and (2) this device must accept any interference received, including interference that may cause undesired operation.



GEB_001

Labelling Radio-Handle

RH15

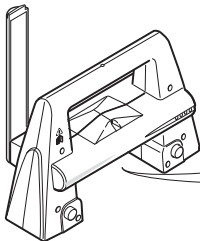

Type: RH....

Art.No.:

Power: 7.4/12.5V = /

0.2A max.

Leica Geosystems AG

CH-9435 Heerbrugg

Manufactured:

Made in Switzerland

Contains

Transmitter Module:

FCC ID: HSW-2400M

IC: 4824A-3450



S.No.: XXXXXX

This device complies with part 15 of the FCC Rules. Operation is subject to the following two conditions: (1) This device may not cause harmful interference, and (2) this device must accept any interference received, including interference that may cause undesired operation.

TS_102

RH16

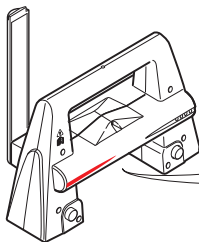

TS_136

Type: RH.....

Art.No.:

Power: 7.4/12.5V = /

0.2A max.

Leica Geosystems AG

CH-9435 Heerbrugg

Manufactured:

Made in Switzerland

Contains

Transmitter Module

FCC ID: P160338

IC: 5325A 0393



This device complies with part 15 of the FCC Rules. Operation is subject to the following two conditions: (1) This device may not cause harmful interference, and (2) this device must accept any interference received, including interference that may cause undesired operation.

7

Technical Data

7.1

Angle Measurement

Accuracy

Available angular accuracies	Standard deviation Hz, V, ISO 17123-3	Display resolution			
		["]	[°]	[mgon]	[mil]
1	0.3	0.1	0.0001	0.1	0.01
2	0.6	1	0.0001	0.1	0.01
3	1.0	1	0.0001	0.1	0.01
5	1.5	1	0.0001	0.1	0.01

Characteristics

Absolute, continuous, diametric.

7.2 Distance Measurement with Reflectors

Range

Reflector	Range A		Range B		Range C	
	[m]	[ft]	[m]	[ft]	[m]	[ft]
Standard prism (GPR1)	1800	6000	3000	10000	3500	12000
Three standard prisms (GPR1)	2300	7500	4500	14700	5400	17700
360° prism (GRZ4, GRZ122)	800	2600	1500	5000	2000	7000
360° Mini prism (GRZ101)	450	1500	800	2600	1000	3300
Mini prism (GMP101)	800	2600	1200	4000	2000	7000
Reflector tape (GZM31) 60 mm x 60 mm	150	500	250	800	250	800
Machine Automation power prism (MPR122)  For Machine Control purposes only!	800	2600	1500	5000	2000	7000

Shortest measuring distance: 1.5 m

Atmospheric conditions

- Range A: Strong haze, visibility 5 km; or strong sunlight, severe heat shimmer
Range B: Light haze, visibility about 20 km; or moderate sunlight, slight heat shimmer
Range C: Overcast, no haze, visibility about 40 km; no heat shimmer



Measurements can be made to reflector tapes over the entire range without external ancillary optics.

Accuracy

Accuracy refers to measurements to standard prisms.

EDM measuring mode	std. dev. ISO 17123-4, standard prism	std. dev. ISO 17123-4, tape	Measurement time, typical [s]
Standard	1 mm + 1.5 ppm	5 mm + 2 ppm	2.4
Single (fast)	3 mm + 1.5 ppm	5 mm + 2 ppm	0.8
Continuous	3 mm + 1.5 ppm	5 mm + 2 ppm	< 0.15

Beam interruptions, severe heat shimmer and moving objects within the beam path can result in deviations of the specified accuracy.
The display resolution is 0.1 mm.

Characteristics

Principle:	Phase measurement
Type:	Coaxial, visible red laser
Carrier wave:	658 nm
Measuring system:	System analyser basis 100 MHz - 150 MHz

7.3

Distance Measurement without Reflectors

Range

Type	Kodak Gray Card	Range D		Range E		Range F	
		[m]	[ft]	[m]	[ft]	[m]	[ft]
R400	White side, 90 % reflective	200	660	300	990	>400	>1310
R400	Grey side, 18 % reflective	150	490	200	660	>200	>660
R1000	White side, 90 % reflective	800	2630	1000	3280	>1000	>3280
R1000	Grey side, 18 % reflective	400	1320	500	1640	>500	>1640



R30 is able to achieve a range of 30 m/100 ft under all atmospheric conditions (D, E, F).

Range of Measurement: 1.5 m - 1200 m

Display unambiguous: up to 1200 m

Atmospheric conditions	D:	Object in strong sunlight, severe heat shimmer
	E:	Object in shade, sky overcast
	F:	Underground, night and twilight

Accuracy

Standard measuring	std. dev. ISO 17123-4	Measure time, typical [s]	Measure time, maximum [s]
0 m - 500 m	2 mm + 2 ppm	3 - 6	12
>500 m	4 mm + 2 ppm	3 - 6	12

Object in shade, sky overcast. Beam interruptions, severe heat shimmer and moving objects within the beam path can result in deviations of the specified accuracy. The display resolution is 0.1 mm.

Characteristics

Type:	Coaxial, visible red laser
Carrier wave:	658 nm
Measuring system:	System analyser basis 100 MHz - 150 MHz

Laser dot size

Distance [m]	Laser dot size, approximately [mm]
at 30	7 x 10
at 50	8 x 20

7.4

Distance Measurement - Long Range (LO mode)

Range

The range of the long range measurements is the same for R400 and R1000.

Reflector	Range A		Range B		Range C	
	[m]	[ft]	[m]	[ft]	[m]	[ft]
Standard prism (GPR1)	2200	7300	7500	24600	>10000	>33000

Range of measurement: 1000 m to 12000 m

Display unambiguous: up to 12000 m

Atmospheric conditions

Range A: Strong haze, visibility 5 km; or strong sunlight, severe heat shimmer

Range B: Light haze, visibility about 20 km; or moderate sunlight, slight heat shimmer

Range C: Overcast, no haze, visibility about 40 km; no heat shimmer

Accuracy

Standard measuring	std. dev. ISO 17123-4	Measure time, typical [s]	Measure time, maximum [s]
Long Range	5 mm + 2 ppm	2.5	12

Beam interruptions, severe heat shimmer and moving objects within the beam path can result in deviations of the specified accuracy. The display resolution is 0.1 mm.



Characteristics

Principle:	Phase measurement
Type:	Coaxial, visible red laser
Carrier wave:	658 nm
Measuring system:	System analyser basis 100 MHz - 150 MHz

7.5

Automatic Target Aiming ATR

Range ATR/LOCK

Reflector	Range ATR mode		Range Lock mode	
	[m]	[ft]	[m]	[ft]
Standard prism (GPR1)	1000	3300	800	2600
360° prism (GRZ4, GRZ122)	800	2600	600	2000
360° Mini prism (GRZ101)	350	1150	300	1000
Mini prism (GMP101)	500	1600	400	1300
Reflector tape 60 mm x 60 mm	55	175	not qualified	
Machine Automation power prism (MPR122)  For Machine Control purposes only!	600	2000	500	1600
 The maximum range can be restricted by poorer conditions, for example rain.				

Shortest measuring distance: 360° prism ATR: 1.5 m

Shortest measuring distance: 360° prism LOCK: 5 m

ATR accuracy with the GPR1 prism

ATR angle accuracy Hz, V (std. dev. ISO 17123-3):	1 " (0.3 mgon)
Base Positioning accuracy (std.dev.):	± 1 mm

System accuracy with ATR

- The accuracy with which the position of a prism can be determined with Automatic Target Aiming (ATR) depends on several factors such as internal ATR accuracy, instrument angle accuracy, prism type, selected EDM measuring program and the external measuring conditions. The ATR has a basic standard deviation level of ± 1 mm. Above a certain distance, the instrument angle accuracy predominates and takes over the standard deviation of the ATR.
- The following graph shows the ATR standard deviation based on three different prism types, distances and instrument accuracies.

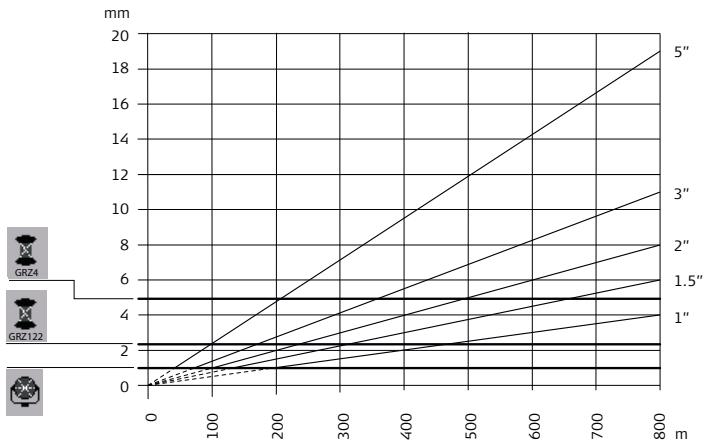

TS_103



Leica GRZ4 prism (360°)



Leica GRZ122 prism (360°)



Leica circular prisms and Leica circular
Mini prisms

mm ATR accuracy [mm]
m Distance measurement [m]
" Instrument angle accuracy ["]

Maximum speed in lock mode

Maximum tangential speed: 5 m/s at 20 m; 25 m/s at 100 m
Maximum radial speed with **Measure mode: Continuous** 5 m/s

Searching

Typical search time in field of view: 1.5 s
Field of view: 1°25'/1.55 gon
Definable search windows: Yes

Characteristics

Principle: Digital image processing
Type: Infrared laser

7.6

PowerSearch PS

Range

Reflector	Range PS	
	[m]	[ft]
Standard prism (GPR1)	300	1000
360° prism (GRZ4, GRZ122)	300*	1000*
Mini prism (GMP101)	100	330
Machine Automation power prism (MPR122)  For Machine Control purposes only!	300*	1000*

Measurements at the vertical limits of the fan or under unfavourable atmospheric conditions may reduce the maximum range. (*optimally aligned to the instrument)

Shortest measuring distance: 1.5 m

Searching

Typical search time: < 10 s
Default search area: Hz: 400 gon, V: 40 gon
Definable search windows: Yes

Characteristics

Principle:

Digital signal processing

Type:

Infrared laser

7.7

Wide-Angle Camera

Wide-angle camera

Sensor:	5 Mpixel CMOS sensor
Focal length:	21 mm
Field of view:	15.5° x 11.7° (19.4° diagonal)
Frame rate:	>20 frames per second
Focus:	2 m (6.6 ft) to infinity at zoom level 1 x 7.5 m (24.6 ft) to infinity at zoom level 4 x
Image storage:	JPEG up to 5 Mpixel (2560 x 1920)
Zoom:	3-step (1x, 2x, 4x)
Whitebalance:	User configurable
Brightness:	User configurable

RTK data formats

Formats for data reception: Leica proprietary GPS and GNSS real-time data formats, CMR, CMR+, RTCM V2.1 / 2.2 / 2.3 / 3.1

7.8.2

SmartStation Dimensions

SmartStation Dimensions

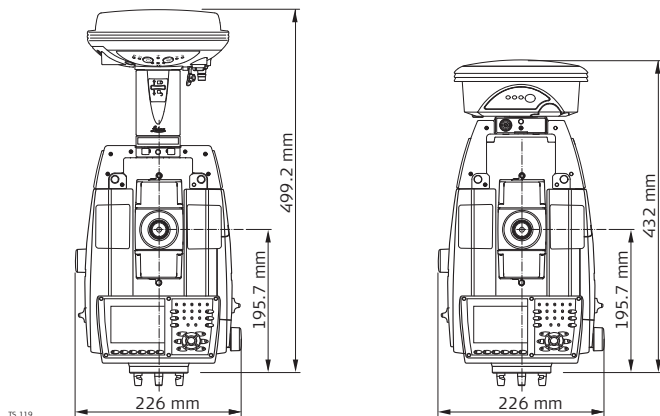

7.8.3

SmartAntenna Technical Data

Description and use

The SmartAntenna is selected for use based upon the application. The table gives a description and the intended use of the SmartAntenna.

Type	Description	Use
GS12	GPS, GLONASS, Galileo, Compass SmartTrack+ antenna with built in groundplane.	With CS10/CS15 field controller or Leica Viva TPS instruments.
GS15	GPS, GLONASS, Galileo, Compass SmartTrack+ antenna with built in groundplane.	With CS10/CS15 field controller or Leica Viva TPS instruments.

Dimensions

Type	Height [m]	Diameter [m]
GS12	0.089	0.186
GS15	0.198	0.196

Mounting

5/8" Whitworth

Weight

Instrument weights without battery and radio:

Type	Weight [kg]/[lbs]
GS12	0.94/2.07
GS15	1.34/2.95

Power

Power consumption:

GS12: 1.8 W typically

GS15, radio excluded: 3.2 W typically

External supply voltage:

Nominal 12 V DC (---, GEV71 car battery cable to a 12 V car battery), voltage range 10.5 V-28 V DC

Battery internal

Type:

Li-Ion

Voltage:

7.4 V

Capacity:

GEB211: 2.2 Ah / GEB212: 2.6 Ah

Typical operating time:

GEB211: 5.7 h / GEB212: 6.5 h

Electrical data

Type	GS12	GS15
Frequency		
GPS L1 1575.42 MHz	✓	✓
GPS L2 1227.60 MHz	✓	✓
GPS L5 1176.45 MHz	✓	✓
GLONASS L1 1602.5625-1611.5 MHz	✓	✓
GLONASS L2 1246.4375-1254.3 MHz	✓	✓
Galileo E1 1575.42 MHz	✓	✓
Galileo E5a 1176.45 MHz	✓	✓
Galileo E5b 1207.14 MHz	✓	✓
Galileo Alt-BOC 1191.795 MHz	✓	✓
Gain	Typically 27 dBi	Typically 27 dBi
Noise Figure	Typically < 2 dBi	Typically < 2 dBi



Galileo Alt-BOC covers bandwidth of Galileo E5a and E5b.

Environmental specifications**Temperature**

Operating temperature [°C]	Storage temperature [°C]
-40 to +65 Bluetooth: -30 to +65	-40 to +80

Protection against water, dust and sand

Protection
IP67 (IEC 60529) Dusttight Protected against water jets Waterproof to 1 m temporary immersion

Humidity

Protection
Up to 100 % The effects of condensation are to be effectively counteracted by periodically drying out the antenna.

7.9

Laser Guide Technical Data

Concept

- Telescope for dual face measurement
 - User adjustment for laser beam
-

Laser

Type: Visible, red, laser class 3R
Carrier wave: 657 nm

Optics

Line of sight offset: 52.20 mm
Focussing distance: 22.76 mm
Beam angle: 0.09 mrad

Power

Power supply: From instrument
Power consumption: ca. 0.2 W

Environmental specifications

Temperature

Operating temperature [°C]	Storage temperature [°C]
-20 to +50	-40 to +70

Range	Daylight:	250 m
	Darkness:	500 m

Beam diameter

The laser beam diameter is influenced by the intensity of the laser guide, by the application distance, by the characteristics of the surface and by the ambient light.

Typical laser beam diameter on white, smooth surfaces with intensity 50% and 100%

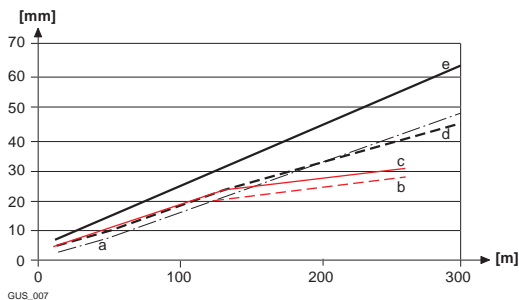

- a) Theoretical $1/e^2$
 - b) Daylight, intensity 50%
 - c) Daylight, intensity 100%
 - d) Darkness, intensity 50%
 - e) Darkness, intensity 100%
-

7.10

7.10.1

Conformity to national regulations

Conformity to National Regulations

TS11/TS15

- FCC Part 15 (applicable in US)
- Hereby, Leica Geosystems AG, declares that the product TS11, TS15 is in compliance with the essential requirements and other relevant provisions of Directive 1999/5/EC. The declaration of conformity may be consulted at <http://www.leica-geosystems.com/ce>.



Class 1 equipment according European Directive 1999/5/EC (R&TTE) can be placed on the market and be put into service without restrictions in any EU Member state.

- The conformity for countries with other national regulations not covered by the FCC part 15 or European directive 1999/5/EC has to be approved prior to use and operation.

Frequency band

2402 - 2480 MHz

Output power

Bluetooth: 5 mW

Antenna

Type: Internal Microstrip antenna

Gain: 1.5 dBi

7.10.2

RadioHandle

Conformity to national regulations

- FCC Part 15 (applicable in US)
- Hereby, Leica Geosystems AG, declares that the RadioHandle is in compliance with the essential requirements and other relevant provisions of Directive 1999/5/EC. The declaration of conformity may be consulted at <http://www.leica-geosystems.com/ce>.



Class 2 equipment according European Directive 1999/5/EC (R&TTE) for which following EEA Member States apply restrictions on the placing on the market or on the putting into service or require authorisation for use:

- France
 - Italy
 - Norway (if used in the geographical area within a radius of 20km from the centre of Ny-Ålesund)
- The conformity for countries with other national regulations not covered by the FCC part 15 or European directive 1999/5/EC has to be approved prior to use and operation.

Frequency band

RH15	Limited to 2402 - 2452 MHz
RH16	Limited to 2402 - 2480 MHz

Output power< 100 mW (e. i. r. p.)

AntennaType: $\lambda/2$ dipole antenna

Gain: 2 dBi

Connector: Special customized SMB

7.10.3

GS12

Conformity to national regulations

- FCC Part 15, 22 and 24 (applicable in US)
- Hereby, Leica Geosystems AG, declares that the product GS12 is in compliance with the essential requirements and other relevant provisions of Directive 1999/5/EC. The declaration of conformity can be consulted at <http://www.leica-geosystems.com/ce>.



Class 1 equipment according European Directive 1999/5/EC (R&TTE) can be placed on the market and be put into service without restrictions in any EEA member state.

- The conformity for countries with other national regulations not covered by the FCC part 15, 22 and 24 or European directive 1999/5/EC has to be approved prior to use and operation.

Frequency band

Type	Frequency band [MHz]
GS12	1176.45 1191.795 1207.14 1227.60 1246.4375 - 1254.3 1575.42 1602.4375 - 1611.5

Type	Frequency band [MHz]
Bluetooth	2402 - 2480

Output power

Type	Output power [mW]
GNSS	Receive only
Bluetooth	5 (Class 1)

Antenna

GNSS	Internal GNSS antenna element (receive only)
Bluetooth	Type: Internal Microstrip antenna Gain: 1.5 dBi

7.10.4

GS15

Conformity to national regulations

- FCC Part 15, 22 and 24 (applicable in US)
- Hereby, Leica Geosystems AG, declares that the product GS15 is in compliance with the essential requirements and other relevant provisions of Directive 1999/5/EC. The declaration of conformity can be consulted at <http://www.leica-geosystems.com/ce>.



Class 1 equipment according European Directive 1999/5/EC (R&TTE) can be placed on the market and be put into service without restrictions in any EEA member state.

- The conformity for countries with other national regulations not covered by the FCC part 15, 22 and 24 or European directive 1999/5/EC has to be approved prior to use and operation.

Frequency band

Type	Frequency band [MHz]
GS15	1176.45 1191.795 1207.14 1227.60 1246.4375 - 1254.3 1575.42 1602.4375 - 1611.5

Type	Frequency band [MHz]
Bluetooth	2402 - 2480

Output power

Type	Output power [mW]
GNSS	Receive only
Bluetooth	5

Antenna

Type	Antenna	Gain [dBi]	Connector	Frequency band [MHz]
GNSS	Internal GNSS antenna element (receive only)	-	-	-
Bluetooth	Internal Microstrip antenna	1.5	-	-

7.10.5**SLR1, SLR2, SATEL SATELLINE-3AS**

**Conformity
to national
regulations**

- FCC Part 15 (applicable in US)
- Hereby, Leica Geosystems AG, declares that the product SLR1, SLR2 is in compliance with the essential requirements and other relevant provisions of Directive 1999/5/EC. The declaration of conformity can be consulted at <http://www.leica-geosystems.com/ce>.



Class 2 equipment according European Directive 1999/5/EC (R&TTE) for which following EEA Member States apply restrictions on the placing on the market or on the putting into service or require authorisation for use:

- France
 - Italy
 - Norway (if used in the geographical area within a radius of 20km from the centre of Ny-Ålesund)
- The conformity for countries with other national regulations not covered by the FCC part 15 or European directive 1999/5/EC has to be approved prior to use and operation.

Frequency band403 MHz - 470 MHz

Output power

SLR1: 0.5 W-1.0 W
SLR2: Receive only

Antenna

Type	Internal	GAT1	GAT2
Frequency band [MHz]	400 - 470	400 - 435	435 - 470
Type	Internal	Detachable $\lambda/2$ antenna	Detachable $\lambda/2$ antenna
Connector	-	TNC	TNC

Specific Absorption Rate (SAR)

The product meets the limits for the maximum permissible exposure of the guidelines and standards which are force in this respect. The product must be used with the recommended antenna. A separation distance of at least 20 centimetres should be kept between the antenna and the body of the user or nearby person within the intended application.

7.10.6

SLR5, SATEL SATELLINE M3-TR1

Conformity to national regulations

- FCC Part 15 (applicable in US)
- Hereby, Leica Geosystems AG, declares that the product SLR5 is in compliance with the essential requirements and other relevant provisions of Directive 1999/5/EC. The declaration of conformity can be consulted at <http://www.leica-geosystems.com/ce>.



Class 2 equipment according European Directive 1999/5/EC (R&TTE) for which following EEA Member States apply restrictions on the placing on the market or on the putting into service or require authorisation for use:

- France
 - Italy
 - Norway (if used in the geographical area within a radius of 20km from the centre of Ny-Ålesund)
- The conformity for countries with other national regulations not covered by the FCC part 15 or European directive 1999/5/EC has to be approved prior to use and operation.

Frequency band

403 MHz - 470 MHz

Output power

SLR5: 0.5 W-1.0 W

Antenna

Type	Internal	GAT1	GAT2
Frequency band [MHz]	400 - 470	400 - 435	435 - 470
Type	Internal	Detachable $\lambda/2$ antenna	Detachable $\lambda/2$ antenna
Connector	-	TNC	TNC

Specific Absorption Rate (SAR)

The product meets the limits for the maximum permissible exposure of the guidelines and standards which are force in this respect. The product must be used with the recommended antenna. A separation distance of at least 20 centimetres should be kept between the antenna and the body of the user or nearby person within the intended application.

7.10.7

SLR3-1, SLR3-2, Pacific Crest ADL

Conformity to national regulations

- FCC Part 15 (applicable in US)
- Hereby, Leica Geosystems AG, declares that the product SLR3-1, SLR3-2 is in compliance with the essential requirements and other relevant provisions of Directive 1999/5/EC. The declaration of conformity can be consulted at <http://www.leica-geosystems.com/ce>.



Class 2 equipment according European Directive 1999/5/EC (R&TTE) for which following EEA Member States apply restrictions on the placing on the market or on the putting into service or require authorisation for use:

- France
 - Italy
 - Norway (if used in the geographical area within a radius of 20km from the centre of Ny-Ålesund)
- The conformity for countries with other national regulations not covered by the FCC part 15 or European directive 1999/5/EC has to be approved prior to use and operation.

Frequency band

SLR3-1:	390 MHz - 430 MHz
SLR3-2:	430 MHz - 470 MHz

Output power

SLR3-1: 0.5 W-1 W
SLR3-2: 0.5 W-1 W

Antenna

Type	Internal	GAT1	GAT2
Frequency band [MHz]	400 - 470	400 - 435	435 - 470
Type	Internal	Detachable $\lambda/2$ antenna	Detachable $\lambda/2$ antenna
Connector	-	TNC	TNC

Specific Absorption Rate (SAR)

The product meets the limits for the maximum permissible exposure of the guidelines and standards which are force in this respect. The product must be used with the recommended antenna. A separation distance of at least 20 centimetres should be kept between the antenna and the body of the user or nearby person within the intended application.

7.10.8

SLG1, Telit UC864-G

Conformity to national regulations

- FCC Part 15, 22 and 24 (applicable in US)
- Hereby, Leica Geosystems AG, declares that the SLG1 is in compliance with the essential requirements and other relevant provisions of Directive 1999/5/EC. The declaration of conformity may be consulted at <http://www.leica-geosystems.com/ce>.



Class 1 equipment according European Directive 1999/5/EC (R&TTE) can be placed on the market and be put into service without restrictions in any EEA Member state.

- The conformity for countries with other national regulations not covered by the FCC part 15, 22 and 24 or European directive 1999/5/EC has to be approved prior to use and operation.
-

Frequency band

UMTS/HSDPA (WCDMA/FDD) 850 MHz/ 1900 MHz/ 2100 MHz
Quad-Band EGSM 850 MHz/ 900 MHz/ 1800 MHz/ 1900 MHz
GPRS multi-slot class 12
EDGE multi-slot class 12

Output power

EGSM850/900:	2 W
GSM1800/1900:	1 W
UMTS2100:	0.25 W
EDGE850/900:	0.5 W

EDGE1800/1900: 0.4 W

Antenna

Type	Internal	GAT3	GAT5	GAT18
Frequency band [MHz]	824 - 894 / 890 - 960 / 1710 - 1880 / 1850 - 1990 / 1920 - 2170	890 - 960 / 1710 - 1880 / 1920 - 2170	824 - 894 / 1850 - 1990	824 - 894 / 890 - 960 / 1710 - 1880 / 1850 - 1990 / 1920 - 2170
Type	Internal	Detachable $\lambda/2$ antenna	Detachable $\lambda/2$ antenna	Detachable $\lambda/2$ antenna
Connector	-	TNC	TNC	TNC

Specific Absorption Rate (SAR)

The product meets the limits for the maximum permissible exposure of the guidelines and standards which are force in this respect. The product must be used with the recommended antenna. A separation distance of at least 20 centimetres should be kept between the antenna and the body of the user or nearby person within the intended application.

7.10.9**SLG2, CINTERION MC75i**

**Conformity
to national
regulations**

- FCC Part 15, 22 and 24 (applicable in US)
- Hereby, Leica Geosystems AG, declares that the SLG2 is in compliance with the essential requirements and other relevant provisions of Directive 1999/5/EC. The declaration of conformity may be consulted at <http://www.leica-geosystems.com/ce>.



Class 1 equipment according European Directive 1999/5/EC (R&TTE) can be placed on the market and be put into service without restrictions in any EEA Member state.

- The conformity for countries with other national regulations not covered by the FCC part 15, 22 and 24 or European directive 1999/5/EC has to be approved prior to use and operation.
-

Frequency band

Quad-Band EGSM850 MHz/ EGSM900 MHz/ GSM1800 MHz/ GSM1900 MHz

Output power

EGSM850/900:	2 W
GSM1800/1900:	1 W

Antenna

Type	Internal	GAT3	GAT5	GAT18
Frequency band [MHz]	824 - 894 / 890 - 960 / 1710 - 1880 / 1850 - 1990 / 1920 - 2170	890 - 960 / 1710 - 1880 / 1920 - 2170	824 - 894 / 1850 - 1990	824 - 894 / 890 - 960 / 1710 - 1880 / 1850 - 1990 / 1920 - 2170
Type	Internal	Detachable $\lambda/2$ antenna	Detachable $\lambda/2$ antenna	Detachable $\lambda/2$ antenna
Connector	-	TNC	TNC	TNC

Specific Absorption Rate (SAR)

The product meets the limits for the maximum permissible exposure of the guidelines and standards which are in force in this respect. The product must be used with the recommended antenna. A separation distance of at least 20 centimetres should be kept between the antenna and the body of the user or nearby person within the intended application.

7.10.10 SLC1 (US), SLC2 (US) CDMA Telit CC864-DUAL

Conformity to national regulations

- FCC Part 15, 22 and 24 (applicable in US)
- The conformity for countries with other national regulations not covered by the FCC part 15, 22 and 24 has to be approved prior to use and operation.

Frequency band

Dual-Band CDMA800 MHz/CDMA1900 MHz

Output power

CDMA800: 0.27 W
CDMA1900: 0.4 W

Antenna

Type	Internal	GAT5	GAT18
Frequency band [MHz]	824 - 894 / 890 - 960 / 1710 - 1880 / 1850 - 1990 / 1920 - 2170	824 - 894 / 1850 - 1990	824 - 894 / 890 - 960 / 1710 - 1880 / 1850 - 1990 / 1920 - 2170
Type	Internal	Detachable $\lambda/2$ antenna	Detachable $\lambda/2$ antenna
Connector	-	TNC	TNC

Specific Absorption Rate (SAR)

The product meets the limits for the maximum permissible exposure of the guidelines and standards which are force in this respect. The product must be used with the recommended antenna. A separation distance of at least 20 centimetres should be kept between the antenna and the body of the user or nearby person within the intended application.

7.11 General Technical Data of the Instrument

Telescope	Magnification:	30 x
	Free Objective aperture:	40 mm
	Focusing:	1.7 m/5.6 ft to infinity
	Field of view:	1°30'/1.66 gon. 2.7 m at 100 m

Compensator

Angular accuracy TS11/TS15 ["]	Setting accuracy		Setting range	
	["]	[mgon]	[']	[gon]
1	0.5	0.2	4	0.07
2	0.5	0.2	4	0.07
3	1.0	0.3	4	0.07
5	1.5	0.5	4	0.07

Level

Circular level sensitivity:	6'/2 mm
Electronic level resolution:	2"

Control unit

Display:	VGA (640 x 480 pixels), color TFT, LED backlight, touch screen
Keyboard:	36 keys including 12 function keys and 12 alphanumeric keys, illumination
Angle Display:	360°", 360° decimal, 400 gon, 6400 mil, V %
Distance Display:	m, ft int, ft us, ft int inch, ft us inch
Position:	In both faces, face two is optional
Touch screen:	Toughened film on glass

Instrument Ports

Port	Name	Description
Port 1	Port 1	<ul style="list-style-type: none">5 pin LEMO-0 for power, communication, data transfer.This port is located at the base of the instrument.
Port 2	Handle	<ul style="list-style-type: none">Hotshoe connection for RadioHandle and SmartAntenna Adapter with SmartStation.This port is located on top of Communication side cover.
Port 3	BT	<ul style="list-style-type: none">Bluetooth module for communication.This port is housed within Communication side cover.
USB	USB host port	<ul style="list-style-type: none">USB memory stick port for data transfer.
	USB device port	<ul style="list-style-type: none">Cable connections from USB devices for communication and data transfer.

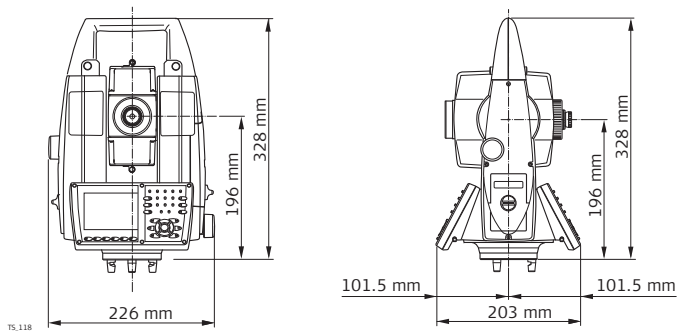
**Instrument
Dimensions****Weight**

Instrument:	4.8 - 5.5 kg
Tribrach:	0.8 kg
Internal battery GEB221:	0.2 kg

Recording

Data can be recorded onto an SD card or into internal memory.

Type	Capacity [MB]	Number of measurements per MB
SD card	• 1024	1750
Internal memory	• 1000	1750

Laser plummet

Type: Visible red laser class 2
Location: In standing axis of instrument
Accuracy: Deviation from plumb line:
1.5 mm (2 sigma) at 1.5 m instrument height
Diameter of laser point: 2.5 mm at 1.5 m instrument height

Drives

Type: Endless horizontal and vertical drives

Motorisation

Maximum rotating speed: 50 gon/s

Power

External supply voltage: Nominal voltage 12.8 V DC, Range 11.5 V-13.5 V

Internal battery	Type:	Li-Ion
	Voltage:	7.4 V
	Capacity:	GEB221: 4.4 Ah

External battery	Type:	NiMH
	Voltage:	12 V
	Capacity:	GEB171: 9.0 Ah

Environmental specifications**Temperature**

Type	Operating temperature [°C]	Storage temperature [°C]
All instruments	-20 to +50	-40 to +70
Leica SD cards	-40 to +80	-40 to +80
Battery internal	-20 to +55	-40 to +70
Bluetooth	-30 to +60	-40 to +80

Protection against water, dust and sand

Type	Protection
All instruments	IP55 (IEC 60529)

Humidity

Type	Protection
All instruments	Max 95 % non condensing The effects of condensation are to be effectively counteracted by periodically drying out the instrument.

Arctic model - TS11

Operating range:



-35°C to +50°C (-31°F to +122°F)

To minimise unavoidable slowdown of display performance for the Arctic option connect the external battery. Allow for a short warm-up time.

Reflectors

Type	Additive Constant [mm]	ATR	PS
Standard prism, GPR1	0.0	yes	yes
Mini prism, GMP101	+17.5	yes	yes
360° prism, GRZ4 / GRZ122	+23.1	yes	yes
360° Mini prism, GRZ101	+30.0	yes	not recommended
Reflector tape S, M, L	+34.4	yes	no
Reflectorless	+34.4	no	no

Type	Additive Constant [mm]	ATR	PS
Machine Automation power prism, MPR122  For Machine Control purposes only!	+28.1	yes	yes

There are no special prisms required for ATR or for PS.

Electronic Guide Light EGL

Working range: 5 m to 150 m (15 ft to 500 ft)
Position accuracy: 5 cm at 100 m (1.97" at 330 ft)

Automatic corrections

The following automatic corrections are made:

- Line of sight error
- Tilting axis error
- Earth curvature
- Circle eccentricity
- Compensator index error
- Vertical index error
- Standing axis tilt
- Refraction
- ATR zero point error

7.12

Scale Correction

Use of scale correction

By entering a scale correction, reductions proportional to distance can be taken into account.

- Atmospheric correction.
 - Reduction to mean sea level.
 - Projection distortion.
-

Atmospheric correction $\Delta D1$

The slope distance displayed is correct if the scale correction in ppm, mm/km, which has been entered corresponds to the atmospheric conditions prevailing at the time of the measurement.

The atmospheric correction includes:

- Adjustments for air pressure
- Air temperature
- Relative humidity

For highest precision distance measurements, the atmospheric correction should be determined with an accuracy of 1 ppm. The following parameters must be redetermined:

- Air temperature to 1 °C
 - Air pressure to 3 mbar
 - Relative humidity to 20 %
-

Air humidity

The air humidity influences the distance measurement if the climate is extremely hot and damp.

For high precision measurements, the relative humidity must be measured and entered along with the air pressure and the temperature.

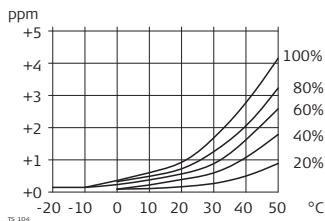
Air humidity correction

ppm Air humidity correction [mm/km]
 % Relative humidity [%]
 °C Air temperature [°C]

Index n

Type	Index n	carrier wave [nm]
combined EDM	1.0002863	658

The index n is calculated from the formula of Barrel and Sears, and is valid for:

Air pressure p: 1013.25 mbar
 Air temperature t: 12 °C
 Relative air humidity h: 60 %

Formulas

Formula for visible red laser

$$\Delta D_1 = 286.34 - \left[\frac{0.29525 \cdot p}{(1 + \alpha \cdot t)} - \frac{4.126 \cdot 10^{-4} \cdot h}{(1 + \alpha \cdot t)} \cdot 10^x \right]$$

TS_105

ΔD_1 Atmospheric correction [ppm]

p Air pressure [mbar]

t Air temperature [°C]

h Relative humidity [%]

$\alpha = \frac{1}{273.15}$

$x = (7.5 \cdot t / (237.3 + t)) + 0.7857$

If the basic value of 60 % relative humidity as used by the EDM is retained, the maximum possible error in the calculated atmospheric correction is 2 ppm, 2 mm/km.

Reduction to mean sea level ΔD_2 The values for ΔD_2 are always negative and are derived from the following formula:

$$\Delta D_2 = -\frac{H}{R} \cdot 10^6$$

TS_106

ΔD_2 Reduction to mean sea level [ppm]
 H Height of EDM above sea level [m]
 R $6.378 \cdot 10^6$ m

Projection distortion ΔD_3

The magnitude of the projection distortion is in accordance with the projection system used in a particular country, for which official tables are generally available. The following formula is valid for cylindrical projections such as that of Gauss-Krüger:

$$\Delta D_3 = \frac{X^2}{2R^2} \cdot 10^6$$

TS_107

ΔD_3 Projection distortion [ppm]
 X Easting, distance from projection zero line with the scale factor 1 [km]
 R $6.378 \cdot 10^6$ m

In countries where the scale factor is not unity, this formula cannot be directly applied.

Atmospheric corrections °C

Atmospheric corrections in ppm with temperature [°C], air pressure [mb] and height [m] at 60 % relative humidity.

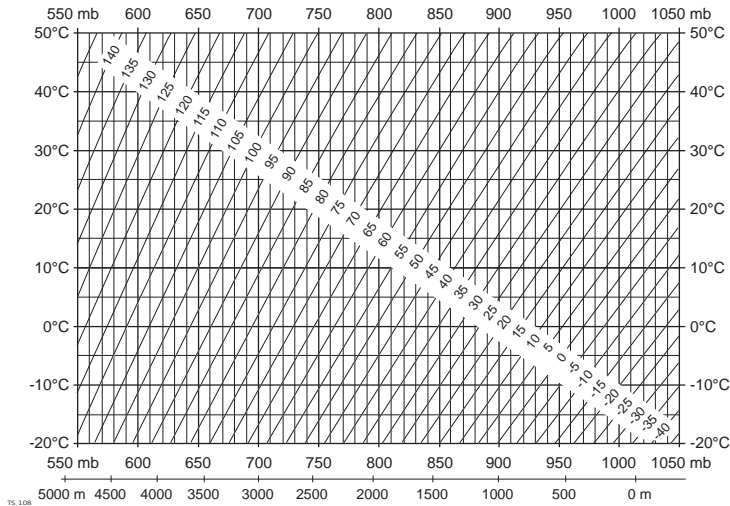

Atmospheric correction °F

Atmospheric corrections in ppm with temperature [°F], air pressure [inch Hg] and height [ft] at 60 % relative humidity.

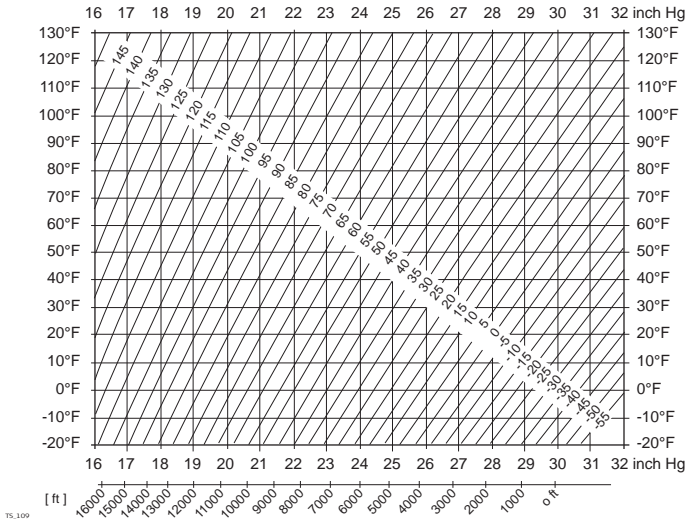





TS_109

7.13

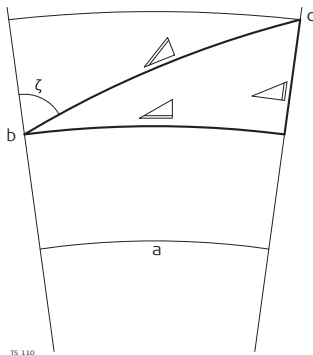
Reduction Formulas

Measurements



- a) Mean Sea Level
- b) Instrument
- c) Reflector
-  Slope distance
-  Horizontal distance
-  Height difference

Reflector types

The reduction formulas are valid for measurements to all reflector types:

- measurements to prisms, to reflector tape and reflectorless measurements.

Formulas

The instrument calculates the slope distance, horizontal distance, height difference in accordance with the following formulas:

$$\triangle = D_0 \cdot (1 + \text{ppm} \cdot 10^{-6}) + \text{mm}$$

TS_111

\triangle Displayed slope distance [m]
 D_0 Uncorrected distance [m]
 ppm Atmospheric scale correction [mm/km]
 mm Additive constant of the reflector [mm]

$$\triangle = Y - A \cdot X \cdot Y$$

TS_112

$$\triangle = X + B \cdot Y^2$$

TS_113

\triangle Horizontal distance [m]
 \triangle Height difference [m]
 Y $\triangle * |\sin\zeta|$
 X $\triangle * \cos\zeta$
 ζ Vertical circle reading
 A $(1 - k/2)/R = 1.47 * 10^{-7} \text{ [m}^{-1}\text{]}$
 B $(1 - k)/2R = 6.83 * 10^{-8} \text{ [m}^{-1}\text{]}$
 k 0.13 (mean refraction coefficient)
 R $6.378 * 10^6 \text{ m}$ (radius of the earth)

Earth curvature (1/R) and mean refraction coefficient (k) (if enabled on the Refraction page in Main Menu: Config...\Instrument Settings...\TPS Corrections) are automatically taken into account when calculating the horizontal distance and height difference. The calculated horizontal distance relates to the station height and not to the reflector height.

Distance measuring program Averaging

In the distance measuring program Averaging, the following values are displayed:

- D Slope distance as arithmetic mean of all measurements
- s Standard deviation of a single measurement
- n Number of measurements

These values are calculated as follows:

$$\bar{D} = \frac{1}{n} \cdot \sum_{i=1}^n D_i$$

TS.114

$$s = \sqrt{\frac{\sum_{i=1}^n (D_i - \bar{D})^2}{n - 1}} = \sqrt{\frac{\sum_{i=1}^n D_i^2 - \frac{1}{n} \left(\sum_{i=1}^n D_i \right)^2}{n - 1}}$$

TS.115

\bar{D} Slope distance as arithmetic mean of all measurements

Σ Sum

D_i Single slope distance measurement

n Number of measurements

s Standard deviation of a single slope distance measurement

Σ Sum

\bar{D} Slope distance as arithmetic mean of all measurements

D_i Single slope distance measurement

n Number of distance measurements

The standard deviation $S_{\bar{D}}$ of the arithmetic mean of the distance can be calculated as follows:

$$S_{\bar{D}} = \frac{s}{\sqrt{n}}$$

TS.116

- $S_{\bar{D}}$ Standard deviation of the arithmetic mean of the distance
- s Standard deviation of a single measurement
- n Number of measurements
-

8 **International Limited Warranty, Software Licence Agreement**

International Limited Warranty

This product is subject to the terms and conditions set out in the International Limited Warranty which you can download from the Leica Geosystems home page at <http://www.leica-geosystems.com/internationalwarranty> or collect from your Leica Geosystems distributor. The foregoing warranty is exclusive and is in lieu of all other warranties, terms or conditions, expressed or implied, either in fact or by operation of law, statutory or otherwise, including warranties, terms or conditions of merchantability, fitness for a particular purpose, satisfactory quality and non-infringement, all which are expressly disclaimed.

Software Licence Agreement

This product contains software that is preinstalled on the product, or that is supplied to you on a data carrier medium, or that can be downloaded by you online according to prior authorisation from Leica Geosystems. Such software is protected by copyright and other laws and its use is defined and regulated by the Leica Geosystems Software Licence Agreement, which covers aspects such as, but not limited to, Scope of the Licence, Warranty, Intellectual Property Rights, Limitation of Liability, Exclusion of other Assurances, Governing Law and Place of Jurisdiction. Please make sure, that at any time you fully comply with the terms and conditions of the Leica Geosystems Software Licence Agreement.

Such agreement is provided together with all products and can also be referred to and downloaded at the Leica Geosystems home page at <http://www.leica-geosystems.com/swlicense> or collected from your Leica Geosystems distributor.

You must not install or use the software unless you have read and accepted the terms and conditions of the Leica Geosystems Software Licence Agreement. Installation or use of the software or any part thereof, is deemed to be an acceptance of all the terms and conditions of such Licence Agreement. If you do not agree to all or some of the terms of such Licence Agreement, you must not download, install or use the software and you must return the unused software together with its accompanying documentation and the purchase receipt to the distributor from whom you purchased the product within ten (10) days of purchase to obtain a full refund of the purchase price.

Index

A

Accuracy

Angle measurement	149
IR mode	151
LO mode	156
RL mode	154
SmartStation	164

ActiveSync	36
------------------	----

Adjustment

Combined (l, t, i, c and ATR)	81
Electronic	76
Inspecting laser plummet	94
Inspecting the laser plummet	94
Laser guide	98
Mechanical	77
Of circular level on instrument	91, 91
Of circular level on prism pole	93
Of circular level on tribrach	91, 91
Preparation	79
Titling axis (a)	86

Battery

Adjustment Errors

View current	77
Angle measurement	149
Antenna	173
GS15	179
RadioHandle	175
Antennas	
GS12	177
Type	167
Arctic instrument	197
Automatic Corrections	198
Automatic Target Aiming ATR	
Accuracy with the GPR1 prism	158
Description	127
Positioning of crosshairs	80
System accuracy	158

B

Batteries

Charging, first-time use	44
Operation, Discharging	44
Change in SmartAntenna	47

Change in TS instrument	45	D	
Internal, SmartAntenna	168	Data transfer	24
Technical data GEB171	196	Description of the system	12
Technical data GEB221	196	Device	
Bluetooth		Status	61
LED on SmartAntenna	67	Dimensions	
C		Of instrument	194
Check & Adjust	76	Of SmartAntenna	167
CINTERION MC75i		Of SmartStation	166
SLG2, technical data	188	Distance Measurement	
Communication side cover		Any surface mode	153
Description	27	LO mode	155
Graphical overview with RadioHandle	29	Prism mode	150
Graphical overview with SmartStation	28	Documentation	4
Compensator	192	Drive	
Control unit	193	PC card, on office computer	24
Corrections		Drives	195
Automatic	198	E	
Scale	199	Electrical data, SmartAntenna	169
		Electronic Adjustment	76
		Electronic Distance Measurement EDM	
		Description	14
		PinPoint R400, PinPoint R1000	15

Electronic Guide Light EGL		Frequency Band	173
Description	15	RadioHandle	174
Safety directions	131	G	
Technical data	198	GAT 1, antenna	181, 183, 185
Environmental specifications		GAT 2, antenna	181, 183, 185
Laser guide	171	GAT 3, antenna	187, 189
Environmental Specifications	196	GAT 5, antenna	187, 189, 190
SmartAntenna	170	GAT18, antenna	187, 189, 190
F		GeoC++ Software Development Kit	21
FCC Statement	144	GS15	
Flashing LED on slot-in device	63, 63	Insert SD card	55
Frequency band		Remove SD card	55
GS12	176	Guidelines for Correct Results	73
GS15	178	I	
SLC1, Telit CC864-DUAL	190	Indicators, LED	
SLC2, Telit CC864-DUAL	190	RadioHandle	71
SLG1, Telit UC864-G	186	SmartAntenna	65
SLG2, CINTERION MC75i	188	Indicators, LED for slot-in-device	61
SLR1, SATEL SATELLINE-3AS	180	Insert	
SLR2, SATEL SATELLINE-3AS	180	SD card	53
SLR3-1, Pacific Crest	184	SIM card	59
SLR3-2, Pacific Crest	184	Slot-in-device	58
SLR5, SATEL SATELLINE M3-TR1	182	USB stick	54

Instrument		
Dimensions	194	
Ports	193	
Technical Data	192	
Weight	194	
Intended Use	108	
Internal memory		
Memory device	24, 24	
International Limited Warranty	209	
K		
Keyboard		
Graphical overview	31	
Operating principles	35	
Keys		
Alpha keys	32	
Arrow keys	33	
Description of	32	
ENTER key	33	
ESC key	32	
Favourites	33	
Fn key	33	
Function keys	32	
Home	33	
Hot keys	32	
Numeric keys	32	
OK	34	
ON/OFF	33	
L		
Labelling		
GEB211	147	
GEB212	147	
GEB221	146	
GS12	145	
GS15	146	
Laser		
Classification	119	
Laser Classification		
Automatic Target Aiming	127	
Integrated Distancer, Invisible Laser	120	
Integrated Distancer, Visible Laser	122	
PowerSearch PS	129	
Laser guide		
Safety directions	136	
Laser guide components	30	

Laser plummet		Operating Temperature	
Inspect	94	Laser guide	171
Safety directions	132	SmartAntenna	170
Technical data	195	Output power	
LED		GS10	179
Slot-in-device	61	GS12	177
Slot-in-device, description	62	GS15	179
LEICA		SLC1, Telit CC864-DUAL	190
Geo Office	14	SLC2, Telit CC864-DUAL	190
Level	192	SLG1, Telit UC864-G	186
Light Emitting Diode		SLG2, CINTERION MC75i	188
SmartAntenna	65	SLR1, SATEL SATELLINE-3AS	181
Light Emitting Diode, slot-in-device	61	SLR2, SATEL SATELLINE-3AS	181
Li-Ion battery	168	SLR3-1, Pacific Crest	185
Storage	103	SLR3-2, Pacific Crest	185
M		SLR5, SATEL SATELLINE M3-TR1	182
Mechanical Adjustment	77	Output Power	173
Memory device		RadioHandle	175
Available	24	P	
Microsoft ActiveSync	36	Pacific Crest	
Mount, SmartAntenna	167	SLR3-1, technical data	184
O		SLR3-2, technical data	184
Operating principles	35	PC card drive on office computer	24

Ports	193	Slot-in-device	58
Position		USB stick	54
LED on SmartAntenna	67	Reset	
Power		Options	43
SmartAntenna	168	Responsibilities	111
Power LED		RTK Base	
SmartAntenna	67	LED on SmartAntenna	67
Power supply	23	RTK Rover	
PowerSearch PS	161	LED on SmartAntenna	67
Precise Measurements	77	S	
R		Safety Directions	107
R1000	15	SATELLINE	
R400	15	SLR1, technical data	180
RadioHandle		SLR2, technical data	180
Description	17	SLR5, technical data	182
LED indicators	71	SD card	
Technical data	174	Insert	53, 55
Recording	195	Memory device	24
Reduction Formulas	205	Remove	53, 55
Reflectors	197	SIM card	
Remove		Insert	59
SD card	53	Remove	59
SIM card	59	SLC1	190

SLC2	190	Software	
SLG1	186	Applications	20
SLG2	188	Customised applications	21
Slot-in-device		Software type	20
Insert	58	Upload	22
Remove	58	Software Licence Agreement	209
SLR1	180	Specifications, environmental	
SLR2	180	SmartAntenna	170
SLR3-1	184	Status, device	61
SLR3-2	184	Storage	
SLR5	182	LED on SmartAntenna	67
SmartAntenna		Storage Temperature	
Description	17	Laser guide	171
Dimensions	166	SmartAntenna	170
SmartStation		T	
Components	16	Telescope	192
Communication side cover	17	Telit CC864-DUAL	
Description	16	SLC1, technical data	190
Graphical overview	28	SLC2, technical data	190
SmartAntenna	17	Telit UC864-G	
Technical Data		SLG1, technical data	186
Accuracy	164		
Dimensions	166		

Temperature		Power Options menu	42
Battery Internal		Unlock keyboard	42
Operating	196	U	
Storage	196	Upload software	22
Bluetooth		USB stick	
Operating	196	Insert	54
Storage	196	Memory device	24
Instrument		Remove	54
Operating	196	User Interface	31
Storage	196	User Manual	
SD Card		Validity of	4
Operating	196	V	
Storage	196	View Current Adjustment Errors	77
Temperature, charging internal battery	44	W	
Touch screen		Weight	
Turn off	43	Of instrument	194
Turn on	43	SmartAntenna	168
Touch Screen, operating principles	35	Wide-Angle Camera	163, 163
Transfer data	24	Windows CE	
TS		Reset registry	43
Available models	18	Restart	43
Firmware for TS11 and TS15	20	Windows Mobile Device Center	36
Language software for TS11 and TS15	20		
Lock keyboard	42		

Total Quality Management: Our commitment to total customer satisfaction.



Leica Geosystems AG, Heerbrugg, Switzerland, has been certified as being equipped with a quality system which meets the International Standards of Quality Management and Quality Systems (ISO standard 9001) and Environmental Management Systems (ISO standard 14001).

Ask your local Leica Geosystems dealer for more information about our TQM program.

Leica Geosystems AG

Heinrich-Wild-Strasse
CH-9435 Heerbrugg
Switzerland
Phone +41 71 727 31 31

www.leica-geosystems.com

- when it has to be **right**

Leica
Geosystems

781004-2.0.0en

Original text
Printed in Switzerland
© 2011 Leica Geosystems AG, Heerbrugg, Switzerland