



FEED ^{THE} FUTURE

The U.S. Government's Global Hunger & Food Security Initiative



LESSONS LEARNED FROM BEEKEEPING IN THE PHILIPPINES

(2014 REVISED EDITION OF LESSON PLANS FOR BEEKEEPING IN THE PHILIPPINES)



USAID
FROM THE AMERICAN PEOPLE



Knowledge and Learning Unit

The Peace Corps Knowledge and Learning Unit (KLU), a department of the Office of Overseas Programming and Training Support (OPATS), makes available the strategies and technologies developed by Peace Corps Volunteers, their co-workers, and their counterparts to development organizations and workers who might find them useful. KLU works with Peace Corps technical and training specialists to identify and develop information to support Volunteers and overseas staff. KLU also produces and distributes training guides, curricula, lesson plans, project reports, manuals, and other material.

Peace Corps-generated materials are also developed in the field. Some materials are reprinted “as-is”; others provide a source of field-based information for the production of manuals or for research in particular program areas. Materials submitted to KLU become part of the Peace Corps’ larger contribution to development.

This publication was produced by the Peace Corps with funding from the U.S. Agency for International Development’s (USAID) Bureau of Food Security. It is distributed through KLU. For further information about KLU materials (periodicals, books, videos, etc.) and information services, or for additional copies of this manual, please contact KLU and refer to the KLU catalog number that appears on the publication:

Peace Corps

Overseas Programming and Training Support

Knowledge and Learning Unit

1111 20th Street, NW

Washington, DC 20526

Abridged Dewey Decimal Classification (DDC) Number: 638

Share your experience!

Add your experience to the Peace Corps library of resources. Send your materials to us so we can share them with other development workers. Your technical insights serve as the basis for a generation of KLU materials. They also ensure that KLU is providing the most up-to-date innovative problem-solving techniques and information available to you and your fellow development workers.

Table of Contents

Acknowledgements.....	5
Introduction.....	7
Glossary.....	8
Ch 1: Construction of Equipment Necessary for Beekeeping.....	10
Requirements for a Good Beehive.....	10
Simple Hives.....	10
Kenyan Top Bar Hive: How-To.....	12
Standard-type Hives.....	14
Standard-type Hive: How-To.....	16
Other Equipment.....	17
Ch 2: Requirements for and Obtaining Bees.....	19
Requirements for Beehives.....	19
Requirements for Bees.....	19
Obtaining Bees.....	20
Ch 3: Handling Bees.....	23
Stings.....	23
Queen.....	23
Eggs.....	23
Starvation.....	24
Good Brood Pattern/Weak Hives.....	24
Swarm Preparation.....	24
Arrangement of Brood Nest and Honey Stores.....	24
Surplus Honey.....	24
Aggressiveness.....	25
Distress of Pests or Location.....	25
Queenlessness.....	25
Ch 4: Colony Management/Seasonal Manipulations.....	26
Before the Honey Flow.....	26
Record Keeping.....	26
During the Honey Flow.....	27
During Dearth or Starvation Periods.....	28

Table of Contents

Ch 5: Bee Colony and Races of Bees.....	30
Colony.....	30
Queen.....	30
Drone.....	30
Worker.....	30
Races of Bees and Bee Relatives.....	31
Ch 6: Problems in Beekeeping.....	34
Pests.....	34
Other Problems.....	36
Ch 7: Selecting and Rearing Queens for Stock Improvement.....	38
Primary Selection Objectives.....	38
Secondary Selection Objectives.....	38
Rearing Queens.....	39
Other Factors in Rearing Queens.....	40
Ch 8: Marketing Hive Products.....	41
Honey.....	41
Wax.....	42
Pollination/Selling Bees.....	42
Beekeeping Cooperatives.....	43
Annex 1: Construction Guides.....	45
Resources.....	49
References.....	50

Acknowledgements

Lessons Learned from Beekeeping in the Philippines replaces an earlier publication, Lesson Plans for Beekeeping in the Philippines. This revision was done in 2014 under contract with EnCompass, LLC, through Feed the Future funding from USAID. The Peace Corps review team included Agriculture Specialist Gordie Mengel and Expert Consultant Lee Lacy. The original manual was developed in 1978 by Diana Sammataro (Philippines, 1977-80) and other Volunteers in the Philippines.

Cover images provided by:

Left: The Peace Corps

Center: wikipedia.org

Right: The Peace Corps



This page intentionally left blank.

As part of the United States “whole of government” effort to address food security in the developing world, the Peace Corps has edited and revised several existing technical manuals designed for use by Volunteers. Most of these materials were created in the late 1970s and early 1980s and were written by a number of different subject matter experts employed or contracted by the Peace Corps. They have been revised with funding provided to the Peace Corps by the U.S. Agency for International Development’s (USAID) Bureau of Food Security under a food security agreement, known as “Feed the Future.”

Given Volunteer and staff needs to access information on a wide range of topics related to food security, these manuals and their accompanying references were selected, reviewed, and updated, again, by subject matter experts. While a few years have passed since first written, the content covered in these manuals, particularly the basic concepts, has changed very little, if at all. Importantly, references in each of the manuals have been reviewed and updated, where necessary, and websites have been added to allow the reader to locate additional, and more recent, supporting content.

The three manuals that may interest Volunteers contemplating or currently working with beekeeping include the following:

1. Small Scale Beekeeping [M0017]
2. Lessons Learned From Beekeeping in the Philippines [R0032]
3. A Manual for Trainers of Small Scale Beekeeping Development Workers [T0029]

Content of the first manual supports the other two manuals and should be reviewed before the others.

The Small Scale Beekeeping manual is written as a guide for those Volunteers getting started with small-scale beekeeping projects. The intention is to provide an overview of beekeeping and its possibilities as a tool for development. The manual focuses on “intermediate levels” of beekeeping that can be self-sustaining using only local resources.

The Lessons Learned from Beekeeping in the Philippines manual was originally titled Lesson Plans for Beekeeping in the Philippines. It was written for Peace Corps Volunteers in the Philippines but was quickly adapted by other countries. The manual includes detailed instructions on how to build beekeeping equipment with materials that Volunteers can access locally.

A Manual for Trainers of Small Scale Beekeeping Development Workers is useful to Volunteers and staff for training purposes. The content is adaptable to pre-service and in-service training events. It is also valuable to Volunteers interested in training counterparts and/or their community members.

Introduction

Glossary

apiary: place where bees are kept for their honey, generally consisting of a number of hives

beebread: yellowish-brown mixture of pollen and honey, made by honeybees to feed larvae

bee glue: substance collected from the buds of certain trees that is used by bees to caulk their hives, also known as propolis

beeswax: tallowlike substance that honeybees secrete and use for building their honeycombs

bellows: device that produces a stream of air through a narrow tube when its sides are pressed together

brood: immature bees

comb: structure made of six-sided wax cells (see honeycomb)

Dadant hive: beehive with a large, deep brood chamber and shallow supers for honey storage named after its inventor, Charles Dadant, a French-American beekeeper

drones: male bees

honeycomb: structure consisting of six-sided wax cells made by bees to hold their honey or eggs

jute rags: rags made from strong, glossy fiber

Langstroth hive: standard beehive used in many parts of the world, it is named for inventor Rev. Lorenzo Lorraine Langstroth, an American beekeeper, and features moveable frames that allow the beekeeper to manage bees in a way which was formerly impossible

larvae: undeveloped bees

log hives: sections of tree trunks with a natural hive inside

melliferous: producing honey

midrib: bottom

nectar: sweet liquid secreted by flowers of various plants gathered by bees for making honey

Newton hive: hive designed along the same principals as the Dadant and Langstroth hives, but with size and spacing more appropriate for the Asian honeybee *apis cerana*

nuc: small nucleus honeybee colony created from larger colonies

paradichlorobenzene: an insecticide

pollen: protein that comes from the male part of the flower

predacious insects: insects that prey on other insects

propolis: substance collected from the buds of certain trees that is used by bees to caulk their hives, also known as bee glue

queenright: term used to define a hive that has a prolific queen

royal jelly: food secreted by the young worker bees that is rich in proteins

skep: round beehive, especially one made from straw

super: hive body that is used for storage of surplus honey

swarm: colony of bees

swifts: family, Apodidae, of highly aerial birds that prey upon bees

uncapped larvae: baby bees that are left unprotected in an open cell

wax cell: six-sided structure made by bees to hold their honey or eggs

Ch 1: Construction of Equipment Necessary for Beekeeping

Requirements for a Good Beehive

- Easy to remove surplus honey
- Easy for bees to store honey, especially after the surplus has been collected
- Lasts many seasons
- Roomy enough or expandable to accommodate growing bee populations and food storage
- Large enough to allow easy passage of bees but small enough for the bees to defend their hives against pests
- Durable enough to protect bees against hot, cold, wet, or dry weather
- Convenient and comfortable for the beekeeper
- Within the financial means of the beekeeper
- One hive is on a scale and there is a glass window to gauge the progress of all the hives without opening them

Simple Hives

Simple Hives without Frames

- Clay pots (flower pots) or mud jars
- Log hives (sections of tree trunks with a natural hive inside) or hollowed out tree trunks
- Mud-plastered wicker “log”-type hives
- Hives in earthen embankments
- Straw-coiled baskets (skeps), circular canes, or squares
- Hollow blocks
- Old tires

Ch 1: Construction of Equipment Necessary for Beekeeping

Sample Simple Hives

The Peace Corps



© Fred Bove



Photo c/o creativecommons.org



Notes:

The clay pot hive shown above (top left) is from Volunteer Mary Liz Watson (Ghana, 2011-2013). See http://www3.telus.net/conrad/2012_pcv_hives.htm for more details on its construction.

Details on the construction of the straw skep hive shown above (middle) can be found at <http://modernfarmer.com/2013/05/how-to-build-a-bee-skep/>.

Ch 1: Construction of Equipment Necessary for Beekeeping

Kenyan Top Bar Hive: How-To

How to Build a Kenya Style
Top Bar Hive (KTBH)

Materials

- 2- 1" x 12" x 46 1/2"
- 2- 1" x 12" x 15"
- 1- 1" x 6" x 46 1/2"
- Any kind of lid 15" x 48"
- 16- bars 15" x 1 1/4" x 3/4"
- 18- bars 15" x 1 1/2" x 3/4"
- 34- triangular comb guides 1" x 3/4" x 13"

Bars should fit snugly together with no spaces.

Ch 1: Construction of Equipment Necessary for Beekeeping

Simple Hives with Frames

- Bamboo or wicker work hives
- Styrofoam boxes
- Oil cans or drums
- Kerosene cans
- Wooden crates
- Cardboard boxes

Advantages

The materials are free.

Disadvantages

These are cumbersome if used without frames.

Sample Simple Hives with Frames

© P. Honigmann, Oxfordshire Natural
Beekeeping Group



The Peace Corps



Photo c/o creativecommons.org



Ch 1: Construction of Equipment Necessary for Beekeeping

Standard-type Hives

Standard-type hives refer to those with wooden frames. The Langstroth hive is known as the “standard” hive. Several variations of the standard hive are used to a limited degree and include the 8-frame Langstroth, modified Dadant, 12-frame Langstroth, and shallow square. The size of the hive body and the depth of the frame it contains vary. The design, dictated largely by the requirements of the bees, is of simple construction and can be used in multiple parts to serve any need.

The standard hive consists of a bottom board, usually two hive bodies with frames of drawn comb for the brood nest, supers for the honey crop, and inner and outer covers. The hive bodies that are occupied by the queen and her brood are referred to as brood chambers, and the ones used for storage of surplus honey are called supers. Brood chambers and supers of a hive may be separated by a queen excluder that confines the queen and drones to the brood nest but allows the worker bees to pass into the supers to store surplus honey.

Advantages

Standard-type Hives

Easy to work and see bees

Oldest known modern beehive

Standard sizes allow for easy expansion and exchange (sale) of equipment

Ch 1: Construction of Equipment Necessary for Beekeeping

Disadvantages

Standard-type Hives

Expensive for rural farmers

Requires equipment to construct

Requires assembly time

Important Considerations for Making Wooden Hives

Bees naturally build wax cells (comb) to fit their body size. A standard bee space is 1/4 to 3/8 inch (6.35 to 9.52 mm). Ideally, it is 3/8 of an inch (9.52 mm) for western honeybees and smaller for eastern honeybees.

If the space between frames, frames and walls, or frames and tops or bottoms is smaller than the bee space, bees will fill it with bee glue (propolis).

If the space is larger than the bee space, the bees will fill it with wax.

Bee space in simple hives is not important since the bees will fill in all the spaces naturally; no work by the beekeeper is required.

Bee space in the wooden hives requires that the beekeeper make the equipment accurately and space the frames properly within the hives. Otherwise, bees will fill up space with wax and the beekeeper might have to cut frames out, injuring brood and losing honey.

Ch 1: Construction of Equipment Necessary for Beekeeping

Standard-type Hive: How-To

Construction plans for a
Ten Frame

Langstroth BeeHive

Construction details for 3/4" thick lumber

The species of wood used to make a beehive can vary depending upon what is available in your area. The minimum thickness should not be less than 3/4". If you are using standard dimensional lumber, you can use 1x8 (3/4" x 7-1/4") for both shallow and medium super, and 1x12 (3/4" x 11-1/4") for the hive body.

Start by cutting the boards to length. For fronts and backs cut them a smidgen over 16-1/4". For sides, cut a smidgen over 19-7/8". Cut box joints.

Now that you have joint cut and the boards cut to finished size, cut the 5/8" x 3/8" board rabbet on the 16-1/4" boards, stopping just short of the box joint pin at each end. (Chisel these squares after the boards are assembled.) Note: pre-drill nails for holes in each pin

Assemble boxes with glue and nail each pin with a 6d galvanized nail. Attach 1x2" hand holds with screws and glue. Attach metal rabbets on the frame rest notch. Fill and holes and paint all surfaces, top and bottom, inside and out with two coats of paint.

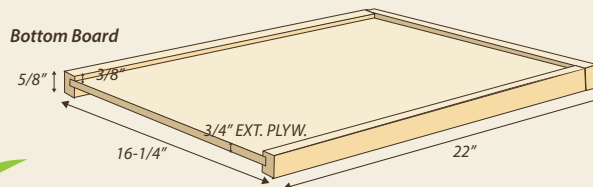
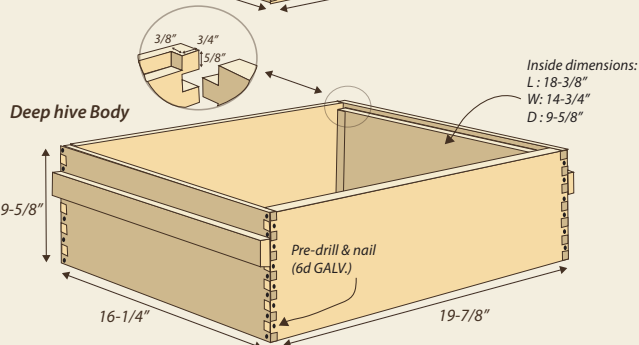
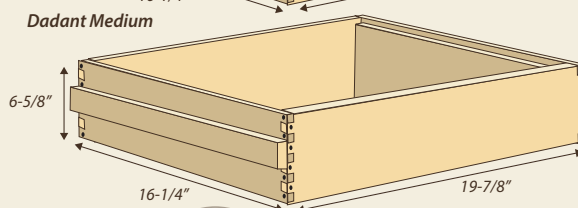
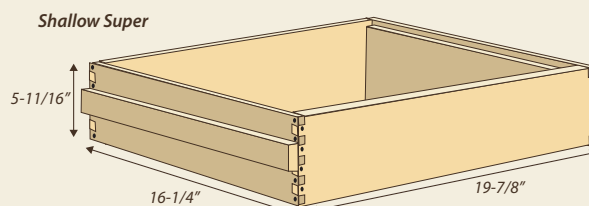
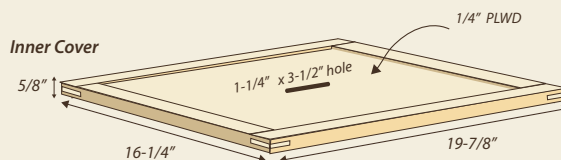
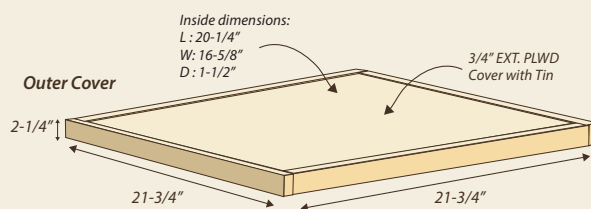
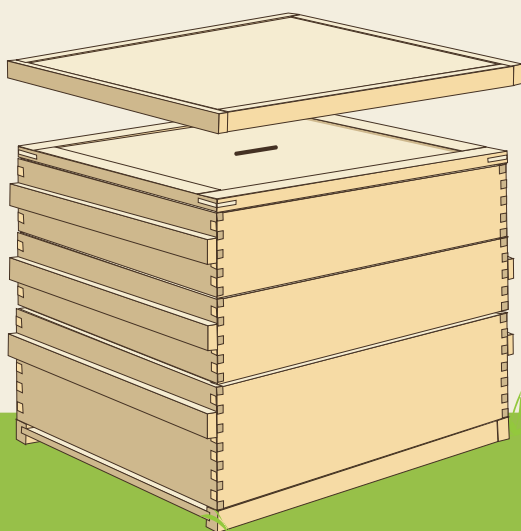

Illustration by: Kelly Bigelow Becerra

Ch 1: Construction of Equipment Necessary for Beekeeping

Other Equipment

Smokers

Smoke, used in moderate amounts, will cause the bees to eat honey and it is difficult for them to sting someone on a full stomach. Some sort of smoking container should be used, not a blazing torch of straw or bark; hot ash will burn bees, making them angry, and will dirty the honey.

A can with a metal blow tube on the top or bottom, or a can with a small bellows attached make good smokers. Use cotton or jute rags, rotten wood, wood shavings, dung, or dry leaves and place a small bit of green grass on top to “cool” the smoke and catch any ashes.

Veils and Hats

Bees instinctively aim for dark spots when angry, so some sort of veil should protect the face and neck. The simplest veil can be a piece of mosquito netting sewn into a wide-brimmed hat. The netting should have some strings attached to the bottom to allow the loose ends to be tightened and tied.

A veil is generally not needed on weak or small hives, but it gives confidence to beginning beekeepers and lessens distractions.

Hives Tool

This metal paint scraper can be purchased or made from an old truck “leaf spring” cut to 8–10 inches (20–25 centimeters) long. A sharp edge is maintained to help scrape away wax and bee glue (propolis) from inside the hive.

Gloves

Generally, gloves are not needed unless one is moving a colony from a tree or house. Gloves are often worn by beginners for confidence; however, one may actually get stung more with gloves since overconfidence tends to make one clumsy. Canvas or leather gloves are used and have long sleeves of cotton sewn to the glove top to protect arms as well.

Ch 1: Construction of Equipment Necessary for Beekeeping

Miscellaneous Equipment

- Queen cages
- Solar wax melter
- Honey extracting equipment
- Comb foundation mill
- Clothing (bee suit)
- Observation hive
- Uncapping knife (to cut honey)
- Bee escape
- Bee brush

Sample Equipment

Note: Instructions for making your own low-cost wax foundation mold can be found here: <http://sciencein africa.com/old/index.php?q=2006/february/beeswaxmould.htm>.

Photo c/o creativecommons.org



Solar Wax Melter

The Peace Corps



Using a smoker

The Peace Corps



Dressing for honeybees

Photo c/o creativecommons.org



Hive Tool

Ch 2: Requirements for and Obtaining Bees

Requirements for Beehives

Selecting a Site to Put the Bees (Apiary)

- Place the hive near a fresh water supply, not contaminated water.
- Hives should be easy for the beekeeper to reach and work.
- Food sources for bees are needed, such as flowering plants for nectar (honey), bee glue (propolis), and pollen (protein).
- Keep hives at the top of a hill or high ground so water and air will drain away from them.
- Do not place hives on wet, swampy lowland or in deep, humid woods because honey will not cure properly and bees could be subject to fungal diseases.
- Facing east (southeast to catch early warmth from the sun), entrances should be pointed away from monsoon winds.
- Provide a windbreak to keep hives from being blown over in high winds and provide noontime shade during the dry hot seasons.
- Keep hives away from floods and open fires.
- Keep brush, vines, and weeds cleared from hives; hives should be placed on a stand (not directly on the ground) to keep out ants and other pests.
- Place hives near the beekeeper's house to discourage mischief-makers.
- Keep hives away from areas heavily sprayed with insecticides.
- Keep hives away from people, animals, etc.

Requirements for Bees

Flowers

Flowers supply both nectar and pollen for bees. Nectar is a liquid sugar solution that flowers manufacture. Since it contains mostly water, the bees must evaporate it to make honey, which consists of about 18 percent water. The different flavors and colors of honey depend on the types of flowers the bees collected the nectar from. Honey is stored in the beeswax cell.

Ch 2: Requirements for and Obtaining Bees

Pollen

Pollen comes from the male part of the flower; it is a powdery dust, which comes off when rubbed by the bees. This pollen fertilizes the female part of the flower and produces the fruit, seed, or vegetable. Bees collect this pollen by means of special hairs on their bodies and return to the hive with it.

Pollen is packed into a wax cell, then it is topped with honey to preserve it; this is called beebread. It is very important to have beebread in the hive, ensuring the young bees and brood will have something to eat. A colony can use up to 100 pounds (50 kg.) of pollen in one season.

Beeswax

Beeswax is secreted by the young worker bees to make the honeycomb. All their honey, pollen, and brood (immature bees) are stored inside the wax comb cells. In order for bees to make wax, they need to eat large amounts of honey or sugar syrup and pollen. Some beekeepers place a sheet of beeswax, called foundation, in a frame to help guide the bees as they build the cells.

Water is important to bees. In hot, dry weather the interior of the hive can become overheated. If this occurs, the brood could “cook” and the wax could begin to melt. Bees prevent this; they collect water and place it in the comb, then fan it with their wings to evaporate the water.

This “air conditioning” cools the hive. In very hot climates, the hives should be placed so they get noontime shade; painting the hives white will also help reflect sunlight.

Bees use the sticky sap from trees and flower buds to make bee glues (propolis). This gummy material is collected to seal cracks and holes and to waterproof the hive. It also kills microorganisms that would otherwise invade and live in small cracks.

Obtaining Bees

Swarm

A swarm is a colony of bees clustered in the opening, not inside a hive box. They are looking for a new home. The beekeeper can capture the swarm by placing it into a temporary or permanent hive.

Ch 2: Requirements for and Obtaining Bees

Advantages

Swarms

Free
Common
Plentiful

Disadvantages

Swarms

Could be diseased or infested with pests
Could be in places that are difficult to reach
Could be of inferior stock

Colonies in Trees or Houses

Colonies in trees, houses, or earth embankments are also free but are generally very hard for a beginning beekeeper to collect intact. This involves destroying the house where the colony lives, or cutting down the tree, cutting the comb, and tying it to a frame and then getting the bees to stay inside the box. Only an experienced beekeeper should collect bees from trees, houses, or embankments. One can also make bees swarm out of a tree or house by smoking and hitting the tree with a hammer continuously until the bees leave and cluster outside. After they leave, they can be installed as a swarm.

Advantages

Colonies in Trees or Houses

Free
Plentiful
Extra wax and honey

Disadvantages

Colonies in Trees or Houses

Could get many stings
Difficult to collect intact
Queen could be killed
Bees could leave later

Ch 2: Requirements for and Obtaining Bees

Traps

Traps can be placed to attract swarming colonies. The trap can be a frame of wax that is placed in a hollowed tree trunk, an empty hive, or an earthen embankment hole. The frames should not contain any honey as this will attract ants and wax moths and encourage insects.

Buying Bees

Buying bees from a beekeeper is another way to get started. Beekeepers can sell one either a full hive and all its equipment, or a nucleus hive with a small population of bees and a laying queen, or a swarm (the buyer provides the equipment), or a laying queen only.

Advantages

Buying Bees

Cared for by an experienced beekeeper

All ages of bees and brood can be obtained

Easy to inquire from owner if there are any problems

Disadvantages

Importing Bees

Could have odd and old equipment that will need to be replaced

Queen could be old or of poor quality

Wax comb could have diseases or pests not initially evident

Buying Imported Bees

Buying imported bees as packages is another way to obtain bees. These bees are very expensive both to buy and to maintain and, while the returns might be higher, they will not perform well unless properly cared for.

Advantages

Importing Bees

Could produce more honey

Gentle and manageable

Do not swarm excessively

Disadvantages

Importing Bees

Subject to disease and pests here

Require more time, care, and feeding

Could die from neglect

The following includes tips to handle different types of bees, their eggs, and issues resulting from keeping bees.

Stings

- Work on days when bees are flying well since half of the foraging bees will normally be out; do not work when it is too windy, rainy, or cold since all the bees will be in their hives.
- Wear light-colored protective clothing and a veil. Make sure ankles and wrists are enclosed in case bees start to crawl up. Beginning beekeepers will want to wear gloves for confidence, but gloves should not be used at all times. The best time to wear them is when transferring bees from a wild hive to a framed hive. Bee stings leave a scent on the gloves, so be sure to wash gloves periodically.
- Lightly use smoke. This makes bees eat honey and they will be eating honey instead of stinging.
- When working bees, use gentle, slow movement so the bees will not be alarmed. Crushed bees cause alarm in the hive so move frames slowly.
- Remain calm and work slowly. If nervous or there is an odor that alarms bees (hair tonic, horse smells), the bees will be more likely to sting.
- If stung, scrape away sting barb; do not pull it out, as this will inject one with more venom. Smoke the sting area since the venom leaves an odor “tag,” which will encourage other bees to sting.

Queen

When she is found, be careful that she does not become crushed or does not drop on the ground. The queen can generally be located near the warm brood nest or nearest the eggs and uncapped larvae.

Eggs

Upon looking at a frame of uncapped larvae, check the frame carefully and eggs may be visible. If the hive has no eggs, or the brood or the queen is not visible, the hive can be considered queenless. Re-queen it by either giving it a queen cell, a new queen, or joining it to a “queenright” hive.

Ch 3: Handling Bees

Starvation

When there is no honey or pollen in the hive, bees may be more aggressive and stop producing wax. If no stored honey or pollen can be seen in the hive, feed the bees white sugar and pollen substitute. If the hive is being used to make queens, feed the bees sugar syrup.

Good Brood Pattern/Weak Hives

When the queen lays eggs in every empty cell so the immature bees (larvae) fill up the comb, this is said to be a good laying queen showing a good brood pattern. A spotty egg laying pattern may mean there are too many drones (male bees) or that a nonvigorous (slow) queen is in existence and will need to be replaced. Weaker hives cannot defend themselves against pests (cockroaches, wax moths) or other robbing bees.

Swarm Preparation

When the bees form numerous peanut-shaped wax cells, which contain immature queens, and the hive is quite populous (and may be crowded), the bees are probably starting swarm preparations. Swarming is a natural instinct; it divides the colony in half and the old queen leaves the hive with half of the bees. Meanwhile, the young queen hatches, mates, and starts laying eggs in the original hive. Unless one wants to lose half of the bees and honey, these swarming preparations should be stopped.

Arrangement of Brood Nest and Honey Stores

To optimize the proper temperature of the brood nest (97 degrees Fahrenheit) and in order to incubate the eggs, the brood nest (eggs, larvae) should be compact and not spread out. Frames of brood should be placed together, in one area of the hive. If the hive is populous, the honey will naturally be stored in the upper portions of the comb and of the brood nest. A frame of honey between frames of brood could prevent the queen from expanding the brood nest properly.

Surplus Honey

Bees instinctively store honey to eat during times of hardship or scarceness of food. Beekeepers try to make bees store more honey than they need and this surplus is what is harvested. To keep the queen from laying eggs in the honeycombs, surplus honey is usually found above the brood, in the upper portions of the hive. Some honey should be left on the hive at all times. Otherwise, bees will starve or leave the hive during dearth times. If bees are starving and no food is available, white sugar syrup must be fed to keep bees from leaving.

Aggressiveness

Some hives are naturally more aggressive than others. This can be controlled by selecting queens that are more gentle and re-queening the aggressive hives. Hives that are too aggressive will sting often and may even swarm out while being worked. Aggressiveness may also be due to queenlessness, disease, or pest harassment.

Distress of Pests or Location

If bees are placed in a damp, humid place, the honey will always be watery and could never “cure” or ripen properly. Unripened honey will eventually ferment. On the other hand, hives that are in a place that is too hot will require so much water to cool the hive that no honey will ever be produced. Such stress on the hive will weaken it and the colony may die or leave. Weakened hives are subject to attack by such pests as mites and wax moths.

Queenlessness

If eggs, larvae, or capped brood cannot be found, or the queen and the hive is usually aggressive and restless, the hive may be queenless. Queenless conditions can be remedied by:

- Providing new queens (virgin or laying)
- Providing mature queen cells
- Providing a frame of eggs
- Joining it to a queenright hive

Ch 4: Colony Management/Seasonal Manipulations

Before the Honey Flow

The following conditions will help ensure a good crop of honey for the beekeeper:

- Populate hive with many young bees, especially during the period just prior to the honey flow (40,000 to 80,000 bees).
- Ensure that the hive is free from pests and diseases.
- Identify a colony that is not preparing to swarm.
- Ensure that the hive has ample room to store surplus honey.
- Give weak hives frames of young bees, capped brood, a new queen, or all of these.
- Ensure all hives are of equal strength, otherwise they will rob each other.
- Do not mix up the natural order of the frames in the brood nest; frames of honey can act as a barrier to the queen and if placed in the middle of the brood nest, can restrict the queen's laying activity.

Frames of pollen and honey should be kept above or on the sides of the brood nest; empty frames can be placed on the end of the brood nest to allow for growth. Frames of brood and pollen should not be placed in the honey supers, as bees will fill the empty cells with both honey and pollen and brood. Every beekeeper wants the bees to use only honey to fill the honey supers.

Record Keeping

Beekeepers should keep accurate records on each hive or groups of hives in their apiary; especially noted are the hives that are significantly productive or weak. A note of when certain plants are blooming that coincide with the honey flow will also help the beekeeper to keep track of the major honey plants in his or her area. Paper tacked inside the cover or written on the hive body (not top) can be used. Permanent book or diary records are more trustworthy. Some things to record are:

- Date worked
- Age of queen
- Colony strength and growth rate
- Timely manipulations (swarm prevention)

Ch 4: Colony Management/Seasonal Manipulations

- Characteristics of hive (aggressive, gentle, productive, poor)
- Swarming record—how often, when, why
- Cash flow (how much money spent or earned)
- Honey (how much (weight) taken off, per hive)
- Hives lost (stolen, swarmed, wax moth, diseases)

During the Honey Flow

At certain times of the year, when most of the flowers from fruits, vegetables, and weeds are blooming, bees will often start bringing in a surplus of honey. This is called the honey flow period and can be recognized by:

- Lots of wax production (white new wax)
- Populous hives, working very hard
- Honey being stored (uncapped and capped)
- Honey with many white tops appearing in the comb

Swarming behavior usually comes before the honey flow period so, to avoid the loss of a lot of honey (due to a lack of bees because they left with the swarm), discourage swarm preparations. In order to prevent swarming:

- Cut out queen cells (if they are numerous and hive is populous with a laying queen)
- Supply more space to the hive, either adding frames or an extra hive body (super)
- Inspect the hive periodically (once/week) to ascertain swarming preparations
- Make sure the hive is not overheated (keep in a shady but breezy spot)
- Provide a young queen

During the honey flow, the hive should not be disturbed too much. By going through the brood nest, the organizational structure of the colony can be destroyed. When bees are disorganized, they will probably not bring in as much honey as they would have normally for that day.

Ch 4: Colony Management/Seasonal Manipulations

The only inspection one should need to make during the honey flow is whether or not the bees have enough room to store honey (this does not apply, of course, to weak or diseased hives).

Examine the honey frames before removing them from the hive. Most of the honey should be sealed with a wax top or “capping.” If the honey has not been properly cured (all the water evaporated), it will begin to ferment and spoil.

Remove the honey frames early in the morning before the bees start bringing in new nectar. Take off the foaled honey frames and cut the comb. The frames should consist of over 75 percent capped honey. Cut the comb or scrape off the honey to the midrib (bottom) of the cell and leave a “foundation” for them to rebuild. If a hot spoon or knife is used, the honey will come off much easier.

During Dearth or Starvation Periods

Dearth periods are times when no honey or pollen is being brought into the hive. Some signs of dearth, which could lead to starvation if all the honey was removed, include:

- No honey in cells
- No pollen stored or brought in
- Wax production cut off; foundation chewed
- No brood or brood rearing is limited
- All stages of drones (brood and adults) are pulled out and dumped out of the hive during severe dearth
- Robbing activity increased; hives aggressive
- Honey stored in brood cells since there is no new brood, once a small honey flow starts

Dearth times are seasonal, after the major flowering period is over. The beekeeper should:

- Make sure bees have enough food (honey/pollen) at all times.
- Take off only a surplus of honey. Leave 60–80 pounds, depending on the climates (leave more in northern climates, less in southern climates). In tropical areas, it may be a very short dearth period, or even no dearth period at all.
- Consider the hive strength and duration of the dearth time.

Ch 4: Colony Management/Seasonal Manipulations

- Make periodic inspections so hives will not get too weak.
- Feed bees if they are starving, using sugar (white) or white sugar syrup.
- Remove excess frames (that are empty) and supers; otherwise, too much heat could be lost from the brood nest, or the wax moth and other pests could invade the empty spaces.

Collecting a Swarm

Photo c/o creativecommons.org



Ch 5: Bee Colony and Races of Bees

Colony

A colony of honeybees will have a fertile female or queen, many male bees (or drones), and many thousand infertile females or workers. These classes of bees together form a unit or collection of individuals which, if separated from the colony unit, would shortly die.

Queen

Usually there is only one queen to a colony and her sole duty is to lay eggs. She resembles a worker but with a much longer abdomen and a dark shiny thorax or back. The queen is fed almost entirely on a food secreted by the young worker bees, called royal jelly, which is rich in proteins. The number of eggs she lays, therefore, will depend on the amount and kind of food she is fed, the number of young workers to incubate the eggs, and the environmental conditions. She lays eggs that may hatch into drones (infertile eggs), workers, or new queens (fertile eggs).

The (European) queen hatches from a special peanut-shaped cell in 16 days. After emerging, the queen will take her mating flight 5–10 days later, where she will mate with several drones. If a virgin queen does not mate after two weeks, she will probably be a poor, drone-laying queen. Queens can live several years.

The queen has a special odor or substance that keeps the colony unit together. If the queen is removed, the worker bees will start to prepare a bee to become a queen. Queenless hives lack organization and could be more aggressive than queenright hives.

Drone

The drone is a larger and heavy looking bee, with very large eyes and chunky abdomen. His sole function is to mate with new queens; he does no work and cannot sting. Normally, high drone populations are only tolerated when ample food is coming into the hive; when the honey season is over, drones are evicted from the hive to die.

European drones take the longest to emerge — up to 24 days. If imported bees (European) are used, drone production should be encouraged since there would be few drones available to mate with virgin queens. When using the native bee, drone production should be limited.

Worker

There are anywhere from 5,000 to 75,000 workers in one colony. They are called workers because they do the house and foraging work required for colony survival.

Ch 5: Bee Colony and Races of Bees

The task of the workers includes feeding larvae (undeveloped bees), tending brood (immature bees), feeding and tending the queen, guarding the hive, evaporating nectar to make honey, packing pollen, and maintaining brood nest temperatures. As the workers age (approximately three weeks), they begin to leave the hive to forage for food. Once a scouting forager locates a food source, the distance and direction of the food is communicated by a combination of dancing scent and sounds. They are foragers for only about another three weeks before they die.

It takes 21 days for a (European) worker to emerge. They have special legs equipped to pack the loose pollen grains and have special glands to secrete wax, stinging venom, and royal jelly. Workers collect nectar, pollen, water, and propolis (or glue), returning to their hive with it.

Races of Bees and Bee Relatives

Wasp (Vespidae)

Many people mistake wasps as bees. Wasps make their homes with paper-like material or mud. While some do sting aggressively, wasps are beneficial pollinators and insect controllers, as they are parasites on many insect pests. Unfortunately, some wasps also prey on honeybees.

Bumblebees and Carpenter Bees

These are large, hairy bees varying in color, from blue-black to black- and yellow-striped. They live in the ground, grass hatch, or dry wood. Although they do not produce a significant amount of honey, they are valuable as pollinators of many fruits, seeds, or vegetable crops.

Stingless Bees

There are many races of other social bees (living in hives) and solitary bees (living alone) that are important pollinators. Stingless bees (*Trigona* and *Melipona*) will store honey in nests, but it is generally too little to attract most beekeepers. Since they are beneficial, colonies should not be destroyed.

Honeybee (Apis)

Rock or Giant bee (*Apis dorsata*)

Rock bees are nomadic, rarely staying long in one place. Farmers in the field report the bees sound like a passing airplane when they fly. The colony consists of a single comb hanging from the branch of a tree, roof, or abandoned ceilings. The worker is light brown, while the queen is darker and longer. The drone is black and about the size of a worker.

Ch 5: Bee Colony and Races of Bees

Rock bees produce good honey and wax, sometimes working longer hours than other honeybees. Honey can be harvested without destroying the hive, two to three times a year when smoke and proper precautions are taken. Yields of up to 77 pounds (35 kilograms) during a year have been recorded. Smoke seems to control their volatile temper and while they will not live inside a hive box, groups of colonies can be raised together.

Little bee (*Apis florea*)

These bees are the smallest of the honeybees and are nomadic. They make small, hand-sized combs in tree branches, caves, bushes, empty boxes, or ceilings. The workers are orange with black and white stripes. The queen is golden brown and the drones are black with gray hair. Again, they do not produce much honey (1–2 pounds (0.5 to 1 kg.)), but some countries are finding them to be a gentle and manageable honeybee.

Indian bee (*Apis idica cerana*)

This bee is used in India and other countries as the main Asian Honeybee. It is easily housed in boxes, tins, jars, and wall recesses. The wilder, prone-swarm strains can be bred for more domestic qualities.

It can be a good producer, gentle and relatively non-swarming, but is less predictable, can steal food from weaker hives aggressively, and appears to have little defense against the wax moth and other pests that enter the hive. It uses little propolis, or bee glue, which may account for easier invasions.

European bee (*Apis mellifera*)

This bee, originally from Europe, has been naturalized in many parts of the world, including North and South America. It is a very good honey producer in good honey-yielding areas. But, as with other bee species, management practices and selection can have a dramatic effect on honey production.

It is similar to the Indian bee in its habits, making its home in enclosures like hollow trees, caves, and boxes. It is well adapted to life in moveable frames within the hives. Importation of the European bee should be restricted to well-equipped, responsible agencies with quarantine arrangements. To avoid the importation of diseases and pests common in the U.S. and Europe, which could be passed to native bees, private beekeepers should consider improving native bees first.

Ch 5: Bee Colony and Races of Bees

External Anatomy of a Worker Honeybee

Photo c/o creativecommons.org

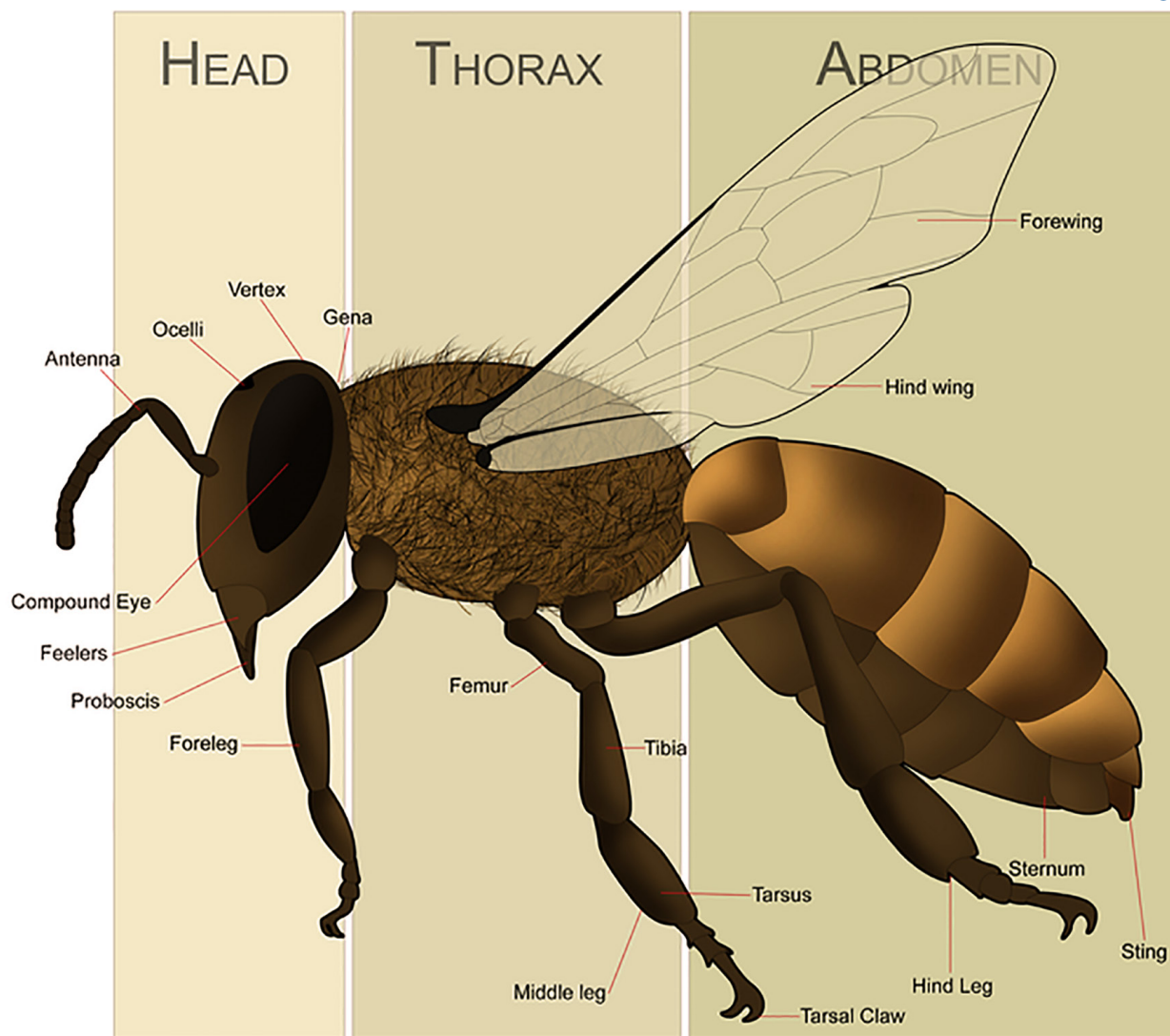

Ch 6: Problems in Beekeeping

Pests

Ants

Ants can invade hives, eating brood, honey, pollen, and bees; eventually the hive will be either so weakened or aggressive that they will abscond or leave. To control, grease hive stands with auto grease and line ground at the base of the stands. Never set hives directly on the ground.

Wasps and other Predacious Insects

Wasps and other predacious insects will catch bees on the wing and take them away to be eaten. They are not a real threat except to weak hives. Traps can be devised to catch the black wasps as they hover in front of the hives. Maintain a strong hive or hire someone to catch the wasps as they hover.



Lizards and Toads

Lizards and toads will also eat bees but, generally, if the hives are on a stand, the loss is minimal.

Beetles and Cockroaches

Beetles and cockroaches can infest a hive, especially when being fed pollen supplement substitutes. A strong hive will evict these intruders. Otherwise, remove debris in the hive bottom that they might be living in and keep the entrance small (especially true for the native bee).

Wax Moths

This is a moth that lays eggs in the comb end upon hatching, and these larvae can cause much damage to the comb and brood by burrowing, spinning silk tunnels, and damaging wax.

© The Food and Environment Research Agency (FERA), Crown Copyright



Ch 6: Problems in Beekeeping

Strong hives can usually combat this pest, but when it starts taking hold, removal of the infested comb and cocoons is imperative, otherwise the bees will leave the hive. Comb can be stored in paradichlorobenzene (mothball) crystals, if kept in a plastic bag or other enclosure, and aired out a day before returning treated comb to bees. Comb can also be put in an environment with freezing temperatures for several hours, especially if wax contains honey and pollen.

Birds

Sometimes droves of swifts (*Chaetura dubia*, Spinetailed swift) have been reported to eat 100 bees each in one day. About the only methods of control seem to be netting the birds or moving hives to another location.

Mites

Two types of external mites are of vital importance to beekeeping. The two (*Varroa destructor* and *Tropilaelaps clareae*) are serious pests that can destroy a hive. They can cause bees to abscond, as well as severely reduce the honey production capacity of hives. Drones and workers should be checked for deformed wings, dead pupae in the cells, and for mites.



Photo c/o wikipedia.org

Varroa mite on pupa.

Colony strength appears to be a factor; the stronger hives may be better able to control this pest. Some bees appear to be more naturally resistant to mites than others because they practice mite-resistant hygiene, and beekeepers can promote the use of mite-resistant stock. Beekeepers can promote healthy colonies through regular monitoring and by following regionally specific treatment guidelines. Treatment options include:

- Drone brood removal (mites preferentially lay eggs in drone cells)
- Using screened bottom boards (when mites fall to the bottom of the hive, they fall through the screen and are thus not able to “hitch a ride” on honeybees traveling through the hive)
- Powdered sugar dusting — some beekeepers regularly dust with powdered sugar, which sticks to the mites’ footpads, causing them to loosen their hold onto bees. Dusting is also believed to stimulate bee grooming behavior, which further promotes mite drop. Such practices should be used in conjunction with screened bottom boards.

Ch 6: Problems in Beekeeping

- Chemical treatments: If beekeepers need to treat their hives with chemicals, they should consider rotating treatment regimes with management practices to avoid building resistance in mites. Commercially available miticides, such as Apistan, should be used judiciously to avoid contaminating honey. Thymol and oxalic acid are two options that are sometimes considered more “natural,” but they can still cause damage to hives and should be used cautiously. When dealing with any chemicals, one should work with local beekeeping professionals and/or communicate with experts via many of the online beekeeping forums.

Other Problems

Colony Collapse Disorder

Colony collapse disorder (CCD) is a growing issue that is still poorly understood, though the blame has centered on the high use of agrichemicals that are detrimental to bees and the loss of bee habitat/melliferous plants. In general, strong bee colonies that can ward off all sorts of diseases and pests will result from living in an environment with a lot of melliferous plants and in which they are exposed to few dangerous chemicals.

Drones

Hives that are strong, well fed, and that have a drone-laying or fertile queen will supply the best drones to supply one’s yard. Drones of the native bee have been reported to fly with the virgin imported queens, but are not a fertile cross.

Robbing

Weak hives are subject to attack by robbing bees (imported and native) that come from other hives (imported and native), in addition to other insects. When possible, hives should be kept of equal strength and races of bees should be kept separate. Mites could be carried by robbing bees.

Pesticides

Many pesticides are harmful to bees and some are more toxic than others. Some pesticides are applied to plants, such as powders and sprays, and are thus dangerous to bees when they come in contact with them, while other pesticides work systemically (i.e., they are taken up by, or bred into, the plant). Some chemicals are highly toxic to bees and their improper use and application can increase the likelihood that bee populations will be negatively affected.

In general, low pesticide environments are best for bee populations. Proper use of chemicals requires both literacy and education. Without these, people may misuse pesticides.

Feeding Bees

During dearth times, if bees are robbed of all their honey, both a pollen and nectar substitute should be supplied to ensure that the hives remain strong and not abscond. The most refined sugar or sugar syrup should be used, although experiments are lacking concerning the effects of feeding second-class sugar in the tropics. Molasses should never be fed, however, as this will give the bees dysentery. Other sugary substances can be tried, such as cane syrup.

Pollen is also important for brood rearing. Imported brewer's yeast and soy flour are the usual pollen substitutes.

Ch 7: Selecting and Rearing Queens for Stock Improvement

Primary Selection Objectives

- Fertility of queen. The queen should exhibit good egg laying capabilities at the time of year when workers are needed and when there is available food, not during dearth times.
- Industry and productivity. Workers should bring in the best honey crop possible. They should have large honey crops and strong legs to bring back large baskets of pollen.
- Disease or pest resistance. Select those bees better able to fend off pests and disease.
- Lowered swarming instinct. Do not use colonies that swarm or abscond frequently to rear queens.
- Good temper, gentle. Propagate those queens from calm, gentle hives, where the bees will not leave the hive due to disturbances by beekeepers or others.

Secondary Selection Objectives

- Long foraging range. Select workers that fly greater distances to gather nectar in difficult areas, those working earlier in the morning and later in the evening, or those that produce more honey as breeders.
- Defensive attitude against pests. Keep hives that are able to keep ants, wax moth, cockroaches, etc., out of the hive.
- Hardiness. Those hives that come through dry, cold, wet, or dearth seasons should be kept with populous colonies.
- Good growth. Select hives that bear brood well, even without feeding (nurse bees tend larvae well).
- Good orientation. Select bees that are able to find their way back to the hive without drifting to other hives.
- Cleanliness. Keep hives that keep the debris off the bottom board.

Ch 7: Selecting and Rearing Queens for Stock Improvement

Rearing Queens

Factors for Queen Cell Production

All larvae receive royal jelly until they are two days old. Those larvae that are to become workers are not fed royal jelly after two days, but are fed a mixture of pollen and nectar. Only larvae that are to be queens receive the royal jelly as their sole diet.

Strong, populous hives with many young bees that may be ready to swarm provide conditions that are optimum for rearing queens. Food, both pollen and nectar, must be abundant; if not, supplemental food, in the form of white sugar syrup and pollen supplement, should be fed to the bees.

Drones are produced during these conditions as well, and it is important that the food and populous conditions are maintained if the drone populations are to be encouraged. Drones mate with the virgin queens.

Natural Rearing of Queens

Queen cells are made by worker bees under the following conditions in the hive:

- **Swarm cells.** When the hive is crowded and the bees are getting ready to swarm, they make queen cells. Select these queen cells carefully so the swarming instinct is not bred into the new queens.
- **Supersedure cells.** When the hive replaces the old queen by making new queen cells, supersedure cells are created. Conditions for replacing the old queen are when the queen is old, failing, diseased, or poorly mated. If the hive is populous, these cells can be used to create queens. Queens from these cells, however, can be inferior.
- **Queenless or emergency conditions.** This exists when the hive has to produce a new queen because the original queen is gone. If the hive is again strong and well-fed, these queens can be used. To make the hive build queen cells, one can remove or kill the original queen. Split the hive equally, giving each half pollen, honey, and bees. Give one-half to the queen and the other half to frames of eggs and young larvae. Bees will produce a new queen.

Controlled Queen Rearing

The easiest way to rear queens is to move the queen from a strong, populous hive during a time when there is plenty of food coming into the hive and to provide the hive with a frame of eggs from a selected colony.

Ch 7: Selecting and Rearing Queens for Stock Improvement

One may have to remove all uncapped brood from this hive to allow the bees to make queen cells from the frame supplied; otherwise, the bees will make queens from any available larvae.

Make this hive continuously rear queen cells (called a Cell Builder) by removing mature, capped queen cells, adding frames of capped brood, and feeding this hive. After removing the mature queen cells, add a new frame of selected eggs.

Disadvantages

Controlled Queen Rearing

Time consuming (cutting cells, adding brood)

Bees could make poor queens

Other Factors in Rearing Queens

- Queen mating yard. Once the mature queen cells are removed, they can be put into a small nucleus hive consisting of young bees, comb, and plenty of food. These mating nucs should be placed in an area where there are many drones or drones from hives with good characteristics.
- Starting nucleus. Once the queen has emerged from the cell and starts to lay eggs in the mating hive, she can be moved to a small hive, consisting of two to four frames of young bees and food. Once she starts to lay in this nuc, her performance and other desirable characteristics can be assessed before she is used to start a new hive.

Honey

Harvesting

Honey is generally taken when over 90 percent of the comb is capped. Uncapped honey tends to ferment since it is “unripened” (i.e., not enough water has evaporated).

Combs can be cut out and pressed to extract honey and then put into a screen or cloth bag, or scraped off to the midrib, leaving a foundation in the frame for the bees to start building again. Or, the wax tops can be cut off with a hot knife and the frame can be put into an extractor, which will spin the honey off, leaving the comb intact. If cutting out comb, leave a 1-inch (2.5 centimeters) strip for bees to work with.

Once the honey has been removed, strain the honey again through a finer cloth to remove any particles, bees, debris, or dirt. Combs with brood should not be harvested.

Store honey in a shady but dry place, free from ants and other predators. Do not spray honey with insecticides. Bottle honey in any clear glass container and label each bottle with quantity, usually by weight, and name of the yard. Honey is usually graded by color (the lighter the color, the higher the grade). Some countries prefer darker honey and may be willing to pay more for it. Honey stored in the sun or in humid places will be ruined.

Honey in the wax comb can also be sold when wrapped in clear plastic or bottled with additional honey.

If honey consists of too much liquid, it will foam and ferment at the top. Such honey will spoil. Thick, clean honey, properly cured and stored (not in a damp place), will last many years. In time, all honey will “set up” or crystallize. This is not the same as spoiling and, in fact, many countries prefer this crystallized form.

Marketing Honey

All honey should be carefully labeled.

Stores, stands, individuals, commercial centers, baking industries, health foods stores, etc., are interested in selling honey. Make individual contacts through a buyer, especially in larger towns and cities.

Ch 8: Marketing Hive Products

Wax

Processing and Harvesting

All beeswax should be kept, including scrapings from the hive, what is left over from wax moth infestation, and what is harvested with the honey. Wax in many countries is more valuable than honey. Here is how to harvest beeswax:

- Place wax in a tub or pot and cover with water. The pot should be sturdy and not likely to break when put over a fire. Water should not boil over, as wax is very flammable and could burn easily. The wax will rise to the top and, once melted, can be strained through a wire screen or jute sackcloth into a pail or bucket. The pail or bucket should have a larger top than bottom for easy removal of the wax cake. Scrape away debris from the bottom once the cake is hard.
- A solar wax melter can be constructed by using a heavy wooden box with a heavy glass top. If the melter is placed in the sun, the wax inside will melt quickly. If a tin tray is made with a collecting spout, and a can placed under the spout, the melted wax will melt and form a cake in one step.

Marketing Wax

Wax can be used for the following:

- Cosmetics
- Machine tooling
- Sailing outfits
- Leather processing
- Wood polish
- Candles

Pollination/Selling Bees

Leasing Hives

In some countries, growers rent hives. Beekeepers bring them into crops during the blooming season and they are removed after flowering or when the grower needs to treat his or her crops with insecticides.

Selling Bees and Equipment

The following things can be sold to beginners and advanced beekeepers alike:

- Wooden parts (frames, boxes, tops, bottom, etc.)
- Swarms
- Improved queens
- Wax comb or foundation
- Smokers, veils, hive tool
- Wax melters
- Beeswax candle kits

Beekeeping Cooperatives

Beekeeping cooperatives can be helpful to small-time beekeepers by:

- Selling more honey, combining resources to make labels, bottle honey, etc.
- Organizing leasing of hives through growers known in the area
- Making equipment and selling it cooperatively
- Exchanging information and sending representatives to periodic workshops, seminars, or courses
- Combining resources to buy and share books, periodicals, or other literature

Ways that cooperatives can raise money:

- Membership dues
- Service charge for any seminars held by co-op
- Selling equipment, honey, wax, etc.
- Rental fees for pollination services

Ch 8: Marketing Hive Products

- Commercial apiaries or university (or other private) contributions
- Sale of goods made with honey, etc. (baked goods, wine, candles)

Some goals that can be realized by cooperative are:

- Improve strains of bees (native)
- Standardize equipment built and used (sold)
- Develop individual technology and style for locality
- Keep records of honey/pollen plants in area, for honey flow data
- Become a service center for beekeepers in a large area, providing equipment, foundation mills, extracting equipment, bottles, and labeling

Sample Honey Extractor

Photo c/o creativecommons.org



Photo c/o creativecommons.org



Photo c/o wikipedia.org

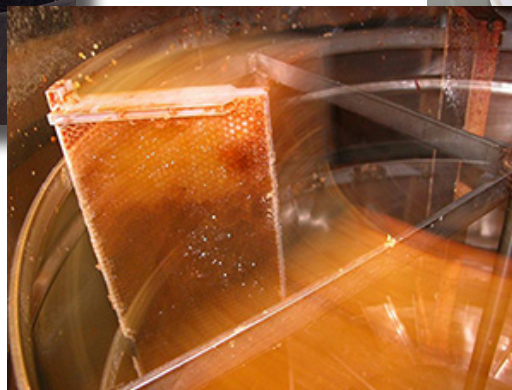

Notes:

To see a video of the honey extractor depicted in the images above, please visit <https://www.flickr.com/photos/sigfridlundberg/5984863070/in/set-72157627301015018/>.

Detailed instructions for building your own low cost honey extractor can be found at <http://www.democraticunderground.com/1182619>.

How to Build a
Kenya Style

Top Bar Hive (KTBH)

Materials

- 2- 1" x 12" x 46 1/2"
- 2- 1" x 12" x 15"
- 1- 1" x 6" x 46 1/2"
- Any kind of lid 15" x 48"
- 16- bars 15" x 1 1/4" x 3/4"
- 18- bars 15" x 1 1/2" x 3/4"
- 34- triangular comb guides 1" x 3/4" x 13"

Bars should fit snugly together with no spaces.

Bee Entrance

Annex 1: Construction Guides

Construction plans for a
Ten Frame

Langstroth Beehive

Construction details for 3/4" thick lumber

The species of wood used to make a beehive can vary depending upon what is available in your area. The minimum thickness should not be less than 3/4" If you are using standard dimensional lumber, you can use 1x8 (3/4"x 7-1/4" for both shallow and medium super, and 1x12 (3/4"x 11-1/4") for the hive body.

Start by cutting the boards to length. For fronts and backs cut them a smidgen over 16-1/4". For sides, cut a smidgen over 19-7/8". Cut box joints.

Now that you have joint cut and the boards cut to finished size, cut the 5/8"x 3/8" board rabbet on the 16-1/4" boards, stopping just short of the box joint pin at each end. (Chisel these squares after the boards are assembled.) Note: pre-drill nails for holes in each pin

Assemble boxes with glue and nail each pin with a 6d galvanized nail. Attach 1x2" hand holds with screws and glue. Attach metal rabbets on the frame rest notch. Fill and holes and paint all surfaces, top and bottom, inside and out with two coats of paint.

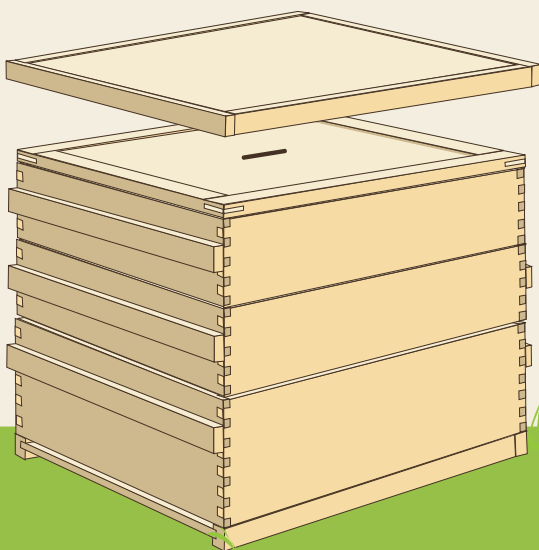
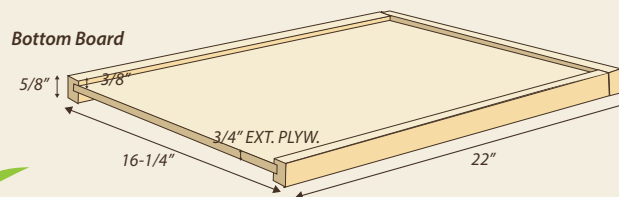
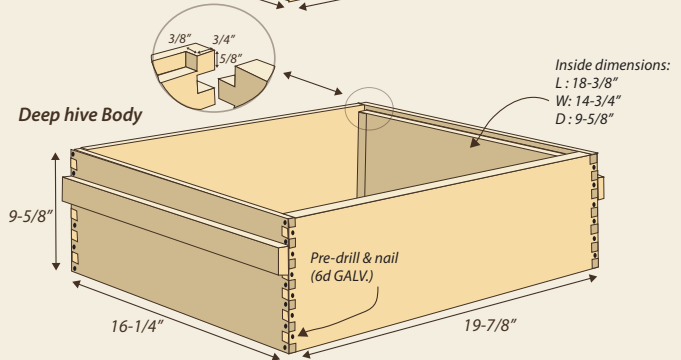
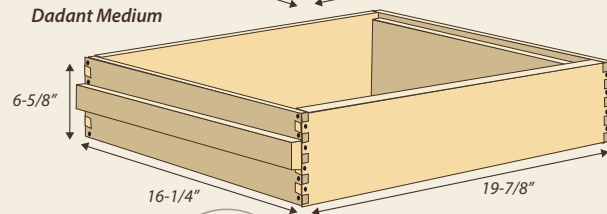
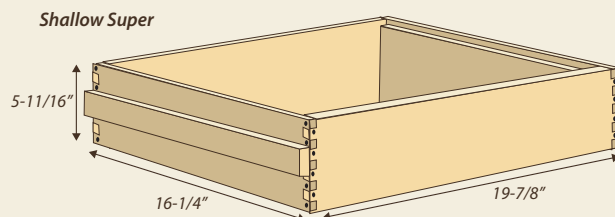
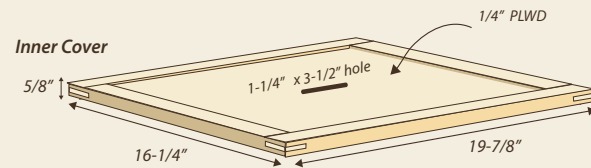
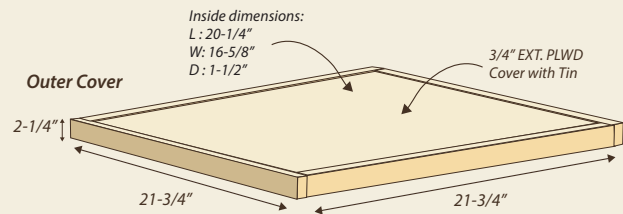
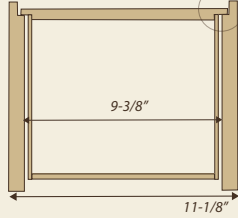

Illustration by: Kelly Bigelow Becerra

Construction plans for a Newton Beehive

Inside dimensions: front view



Inside dimensions: Side view

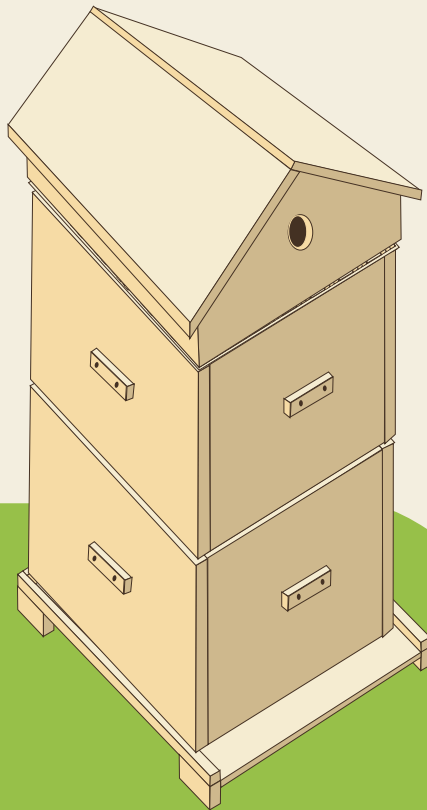
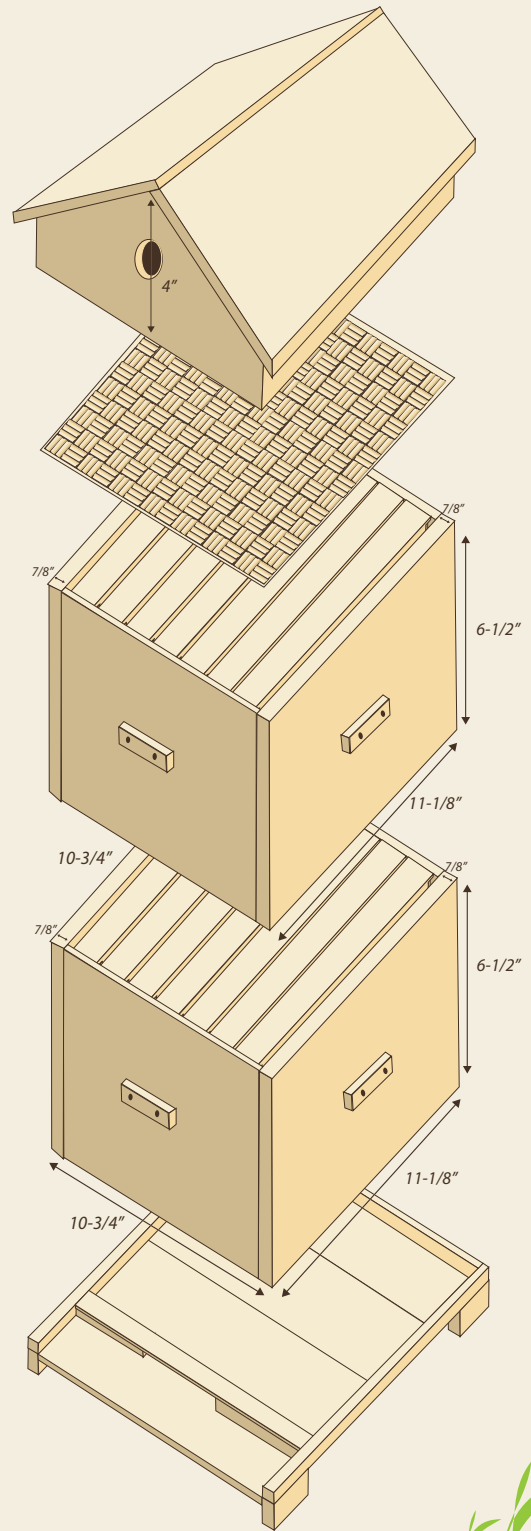
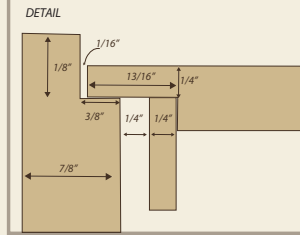
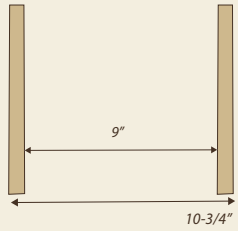

Illustration by: Kelly Bigelow Becerra

Annex 1: Construction Guides

How to Build a

Beehive Smoker

Fire Chamber

Large can braced with wooden can wedge placed inside, use nails to form a circle, use hammer to punch through center.

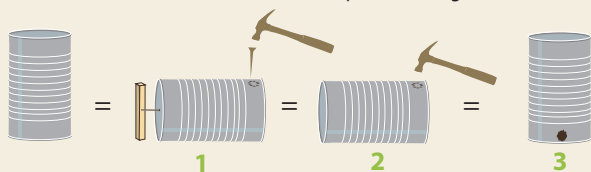

Smoker Cap

Large can braced with wooden can wedge placed inside, use nails to form a circle of holes, use hammer to punch through center. Cut a line in can so that it will fit inside fire chamber

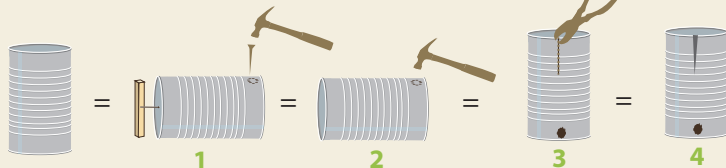

Grate

Small can, cut off bottom section, *save remaining upper can for attaching bellows to fire chamber. Use nails to punch holes in can bottom, Cut sides to form legs, * save remaining strips for hinges on bellows, and insert grate into fire chamber (hole should be below grate).

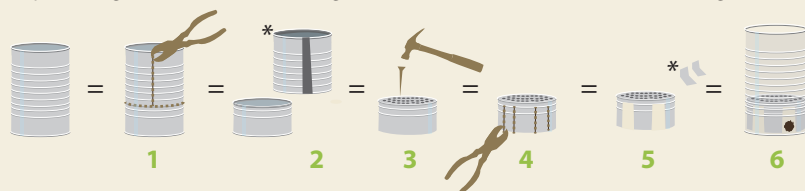

Bellows

Two boards, drill hole in center bottom of board A (hole should be slightly smaller than fire chamber hole), *use remaining strips of small can for hinges, attach hinges to board (A), then to board (B) as shown. Open boards and cover with plastic, use a small twig and staples to secure plastic to bellows (airtight and on all sides).

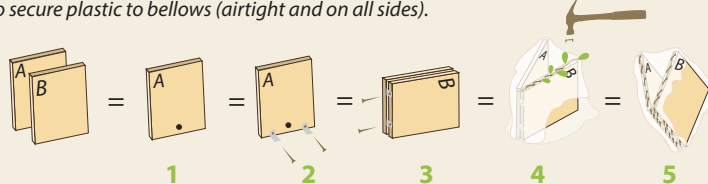

Please Note:

If you can easily purchase a smoker, please do so. A purchased smoker is likely to be more safe and effective.

*Smoker Cap is VERY HOT - use caution when removing.

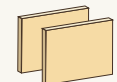

Illustration by: Kelly Bigelow Becerra

Materials and Tools



- Requires 3 steel cans – 2 of same size, 1 slightly smaller in diameter (no aluminium cans – they can't take the heat)



- Plastic or leather for bellows

- Wood planks for bellows - approx 6"x8"x 1/2"

- Staples/wire/nails to affix plastic to bellows

- Screws (could use wire instead)



- Hammer or a good rock

- Tin snips or a hacksaw or a sharp machete

- Nail to poke holes in cans

- Wooden can-wedge - diameter of the larger can (This is used to brace a can from being crushed when nailing a hole thru it.)

- Screwdriver (if using screws)

- Pliers (optional)



Attaching Bellows to Fire Chamber

Use remaining top of small can, use nail to poke three holes in back of can to screw into bellows board (A), use nail to poke 2 holes in each side to attach to fire chamber. Be sure to line up Bellow hole with fire chamber hole. *2 inch gap is ideal between these holes to avoid hot ash being sucked into the bellows

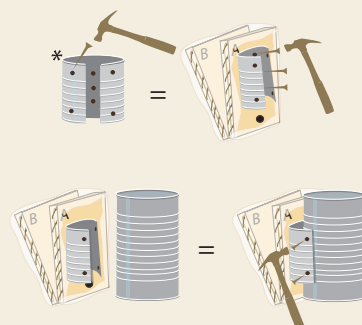

Finished Smoker



Title	Description
Bee Culture	This (beeculture.com) is an online magazine of American beekeeping.
Bees For Development	This website (beesfordevelopment.org) is a really important resource for those doing work with honeybees in the context of development. It also publishes the journal, Bees for Development, and is particularly focused on bee health and sustainability as a measure of success. There are many articles on beekeeping in relation to appropriate technologies, which makes it an unparalleled resource for PCVs.
Beesource	Beesource.com has over 14,000 registered members and is the most active online beekeeping community of its kind in the world.
Certified Naturally Grown	To support natural beekeepers everywhere, this organization (naturallygrown.org) publishes two online booklets: "Handbook for Natural Beekeepers based on our Apiary Certification Standards," and "Help the Honey Speak: A Marketing Guide for Beekeepers with Naturally Managed Apiaries."
CIFOR	The Center for International Forestry Resource (cifor.org) has some materials on beekeeping in relation to community forestry.
Manual de Apicultura Basica	Online guide to beekeeping (in Spanish).
Manual de Apicultura Organica	Online guide to organic beekeeping (in Spanish).
Prácticas de Apicultura	Online guide to beekeeping (in Spanish).
Scientific Commission Beekeeping for Rural Development	The mission of the Apimondia Standing Commission for Beekeeping for Rural Development is to provide a forum for sharing information on how apiculture contributes to the development of sustainable livelihoods worldwide.

References

- Abbott, C.P. "Queen Breeding for Amateurs." Copthorne, Sussex: Bee Craft Books, 1951.
- Attfield, H.H. "A Beekeeping Guide." Bucks, Rainer, Md: VITA. Tech, 1976.
- Crane, E, ed. "Apiculture in Tropical Climates." London, Great Britain: IBRA., 1976.
- Dadant & Sons, ed. "The Hive and the Honey Bee." Hamilton, Illinois, 1975.
- Davies, Paul. "The Fifth Miracle: The Search for the Origin of Life." New York City: Simon and Schuster, 1999.
- Laidlaw, H., and J.E. Eckert. "Queen Rearing." Berkeley, CA: University. of California Press, 1962.
- McGregor, S.E. "Insect Pollination of Cultivated Crop Plants." Ag. Handbook #496. USDA: Washington, DC, 1976.
- Mores, R.A., and F.M. Laigo. "Beekeeping in the Philippines." Farm Bulletin #27. University of Philippines, Los Banos, 1968.
- Sammataro, D. and A. Avitabile. "The Beekeeper's Handbook." Dexter, Mich: Peach Mt. Press, 1978.
- Smith, F.G. "Beekeeping in the Tropics." Bristol, Great Britain: Western Printing Services, Ltd., 1960.
- Tompkins and Griffith. "Practical Beekeeping." Charlotte, Vt.: Garden Way Publ, 1977.
- Vernon, F. "Beekeeping." Aylesbury, Bucks. Great Britain: Hodder and Stoughton, 1976.

This page intentionally left blank.