



Visit us at : <http://www.lgservice.com>

LG

LG

Simple Wired Remote Controller

Owner's & Installation Manual

Models: PQRCUCS0C

IMPORTANT

- Please read this owner's & installation manual completely before installing the product.
- Installation work must be performed in accordance with the national wiring standards by authorized personnel only.
- Please retain this installation manual for future reference after reading it thoroughly.

TABLE OF CONTENTS

■ Safety Precautions	3~4
■ Part Description	5
■ Wired remote controller switch information	6
■ Installation instruction	7
■ Necessary functions before using	9~12
• Trial Operation	9
• Celsius/Fahrenheit Switching	10
• Setting the Central Control Address	11
• ESP Function	12
■ How to use the Mode Selection Button	13~19
• Cooling Operation	13
• Heating Operation	14
• Auto-Operation	15
• Dry(Dehumidification) Operation	16
• Fan Operation	16
• Fan Speed Selection	17
• Indoor Temperature Display	18
• Auto Swing	18
• Child Lock	19
• Different Mode Operation	20

Note) Please, refer to indoor's manual for product's detail information of subfunction

Safety Precautions

- The installation requires expert skills, and it should be installed by the service center or other shops specialized in the installation and recognized by our company.
- For all the problems arising after installation by someone who has no relevant qualifications, LG will not provide free service.
- The following safety cautions are provided to prevent unexpected dangers or losses.

⚠ WARNING : If the user does not follow the mandatory items, it may result in serious injury or death.

⚠ CAUTION : If the user does not follow the mandatory items, it may cause personal injury or property damage.



: Warning and Caution are to call the user's attention to the possible danger. Read and follow them carefully in order to prevent a safety accident.



: Warning and Caution are indicated in this guide and the product itself to help protect the users from danger.

⚠ WARNING

■ Installation

Entrust installation of the product to the service center because improper installation may cause fire, an electric shock, explosion, and physical injury.

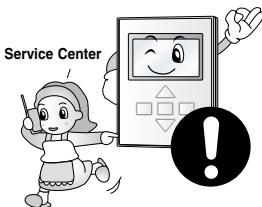

Use the original parts in order to prevent fire, an electric shock, explosion, and product breakdown.

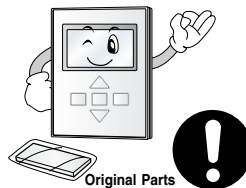

Keep combustible and/or inflammable materials away from the product in order to prevent fire or product breakdown.



Do not disassemble, repair, or modify the product at your discretion in order to prevent fire or an electric shock.

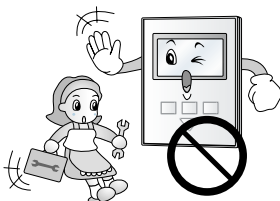

Do not install the product in wet and humid areas in order to prevent product breakdown.

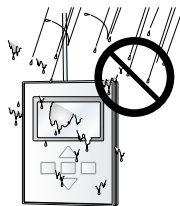

Do not expose the product to the sun in order to prevent product breakdown.

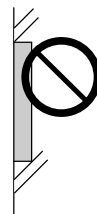

■ In-use

Do not modify or lengthen the power cable at your discretion. It may cause fire or an electric shock.

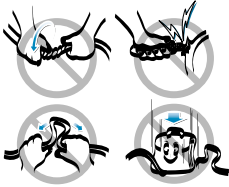

Do not place a heating device near the product. It may cause fire.



Do not drop water on to the product. It may cause an electric shock or product breakdown.

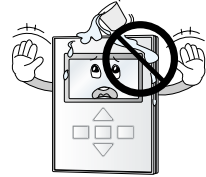

Do not place something heavy on the power cable. It may cause fire or an electric shock.



Do not place a heavy thing on the product. It may cause product breakdown.

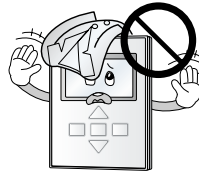

If the product was submerged under water, ask the service center for instruction. It may cause fire or an electric shock unless you do that.

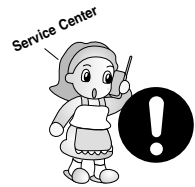

▲ CAUTION

Make sure children or senior citizens use the product under proper observation in order to prevent safety accident.

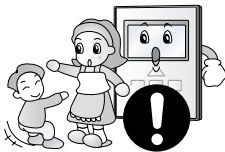

Do not subject the product to shock. It will cause product breakdown.



Do not pick the product with a sharp tool. It may cause product breakdown with the damage to its parts.



■ In-use

Do not clean the product with strong cleanser such as solvent. Use soft clothes in order to prevent fire or product deformation.



Do not touch the product with a wet hand. Do not pull the lead cable. It may cause product breakdown or an electric shock.



Part Description

Simple Wired Remote Controller

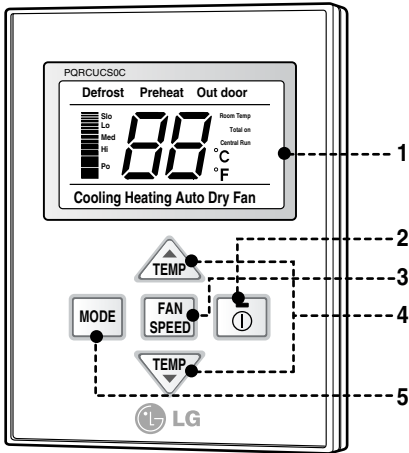

1. Operation Display Panel
2. On/Off Button
3. Fan Speed Button
4. Temperature Control Button
5. Mode Selection Button

Each function will be shown on the display panel for three seconds or so when the power is applied at first.

Accessory

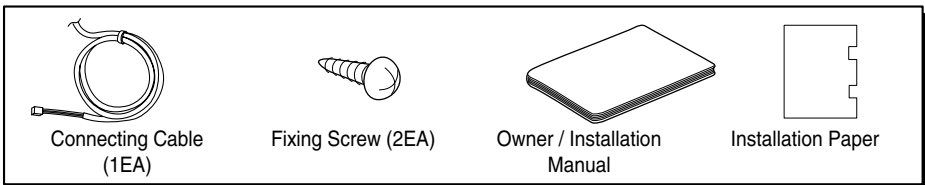

Wired remote controller switch information

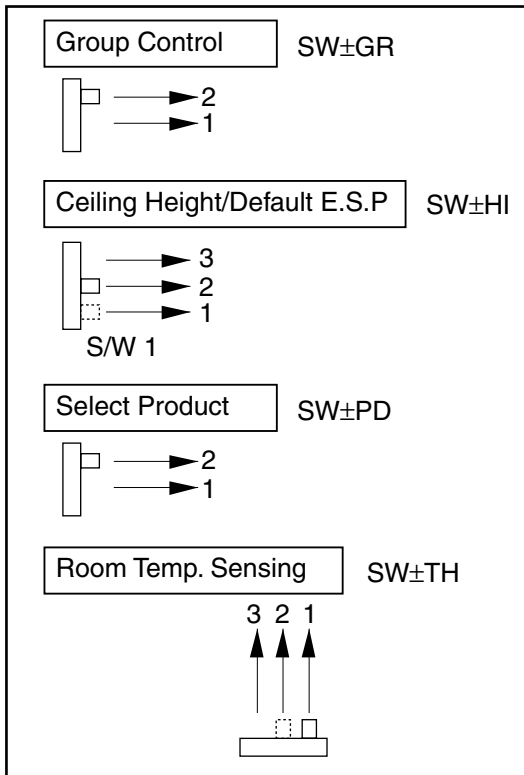

Group control switch

1. For individual control/Master use
2. For group control/Slave use

Ceiling height selection switch

1. Low ceiling
2. Standard ceiling
3. High ceiling

Product selection switch

1. Cooling Only product
2. Heat Pump product

Indoor temperature sensor selection switch

1. Use the temperature sensor on the remote controller.
2. Use the temperature sensor on the product.
3. Use the sensors on the product and remote controller.

- When changing the product selection switch and group control switch, the power must be reconnected to reflect the changes.
- The central control could operate inappropriately depends on indoor unit type, when the remote controller is set as slave.

Installation instruction

- 1** Put the installation paper on the place and determine the position and height of the fixing screws of the wired remote controller.
- Refer to the printed side of the installation paper.

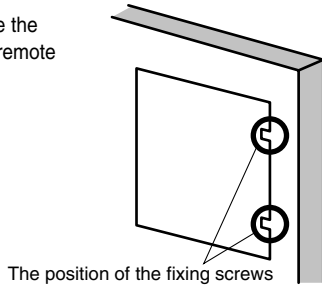

- 2** Plug the connecting cable into the indoor unit.
- The product is being shipped with the cable connected only to the remote controller. Fix the connecting cable with the cable rack.

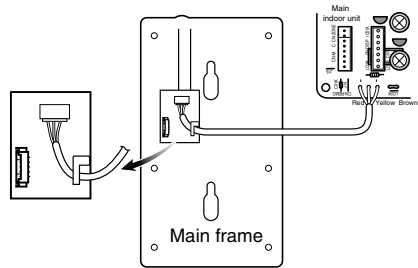
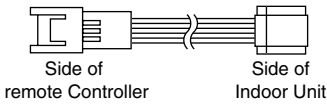

- 3** Remove the installation paper before installing the remote controller so that it can fit at the right place.

Fixing the remote controller

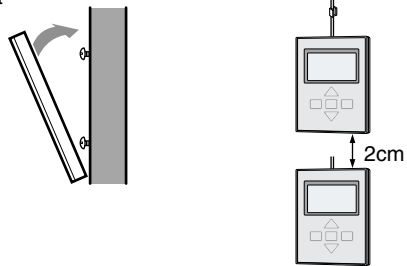

- * Do not embed the remote controller into the wall. (It may cause the breakdown of the temperature sensor.)
- * If you want to install a number of remote controller at the same place in a vertical line, install them at regular intervals of 2cm. (It may cause the breakdown of the temperature sensor.)
- * Do not install the cable with a distance of 50 m or longer. (This can cause communication error.)
- * When installing the cable, check whether the connector between the remote controller and the product is installed properly. The connector will not be connected when installed in opposite sides.

- Supply the power after connecting wired remote controller.
- When you need to change wired remote controller, switch off the main power and change it.
- If the wired remote controller is changed before switching off the main power, the option function of the indoor unit can't be used. (option function like "slo" fan speed selection)

Group control

1. When installing more than 2 units of air conditioner to one wired remote controller, please connect as the below picture.

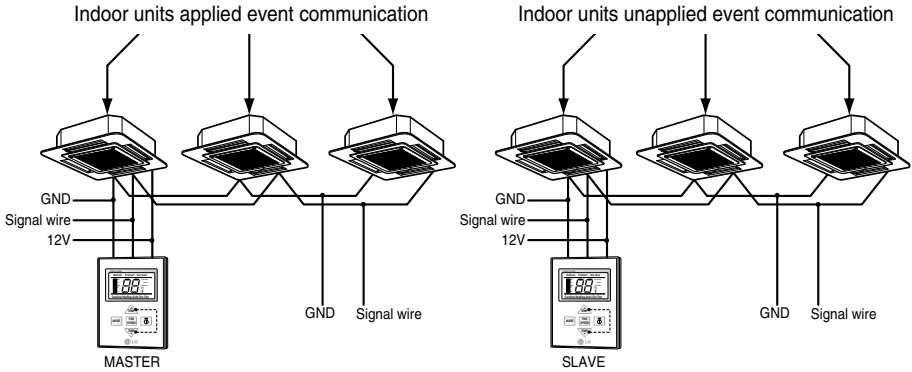

* In case of using the event communication indoor units please set the remote controller as Master.

* In case of using the non-event communication indoor units please set the remote controller as Slave.

2. When installing more than 2 wired remote controllers to one air conditioner, please connect as the below picture.

- When installing more than 2 units of wired remote controller to one air conditioner, set one wired remote controller as master and the others all as slaves, as shown in the right picture.
- Refer to Switch information section on how to set master/slave.

* In case of this, you should set the slide switch of two remote controller as same value.

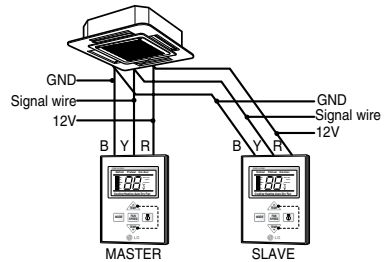

<When simultaneously connecting 2 sets of wired remote controller>

Ex) 1. Master Remote controller

- SW_TH : 3
- SW_HI : 2

2. Slave Remote controller

- SW_TH : 3
- SW_HI : 2

* In this case, please use below cable.

- Model Name : PZCWRG3

* Some products can not connect 2 wired remote controllers to one air conditioner. It depends on the product type. For more detail, refer to the product manual.

Necessary functions before using

Trial Operation

The trial operation is to check the installation status of the product. The temperature will not be controlled during trial operation. Instead the product will operate in several modes such as cooling, strong wind, comp-on.

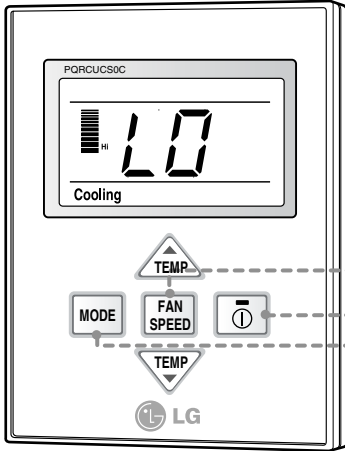

1 If you want to set the trial operation mode, press the mode button and the Fan speed button same time for three seconds.

2 Then the product will begin the trial operation and the display will be like as shown on left side picture.

3 If you want to cancel the trial operation mode, just press the On/Off button.

4 The trail operation will be shut down automatically after 18 minutes and system will go to the standby mode.

* This function might not be available for Multi Product like Multi V system.

Celsius/Fahrenheit Switching

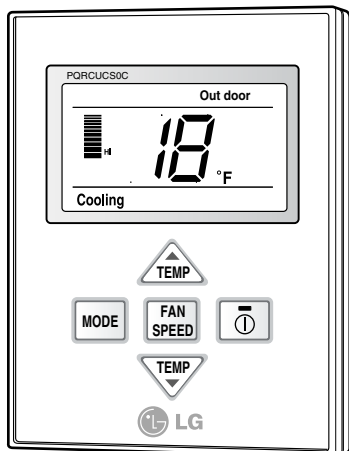

1 If you want to change the temperature unit as the Celsius or Fahrenheit, press the Temperature control button(▼) and the Fan speed button same time for three seconds to enter the setting Mode.

2 Press the temperature control button to change the unit.

Ex) Setting unit as Fahrenheit.

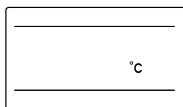

<Setting as Celsius>

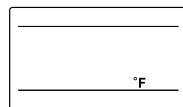

<Setting as Fahrenheit>

3 After setting, press the Temperature control button(▼) and the Fan speed button same time for three seconds to exit the setting Mode.

The system will automatically release without input after 30 seconds.

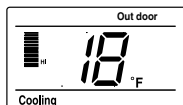

Setting the Central-Control Address

Please set the address while using the central controller.

You don't need to set address if you don't use central controller.

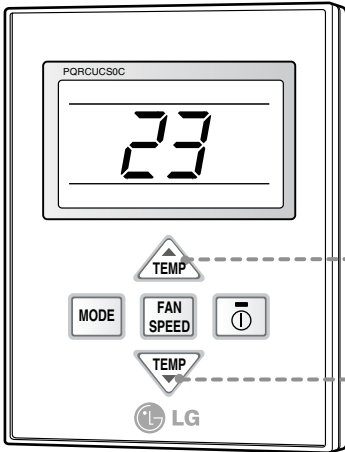

1 If you want to set the address on the display panel, press both temperature control buttons (▲/▼) same time for three seconds.

2 Press the temperature-increasing button to change the group number. Press the temperature-decreasing button to change the indoor unit number.
e.g. As shown on the left side panel, it displays 23.
Group No. : 2
Indoor Unit No. : 3

3 Set the address by pressing both temperature control buttons again(▲/▼) at the same time for three seconds.

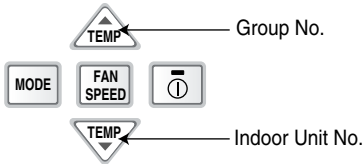

- If you connect the indoor unit to the central controller, you should set the network address of the indoor unit so that the central controller could recognize it.
- The center-control address is composed of the group number and the indoor-unit number.

Note : The remote controller displays 'HL' if central controller has locked the remote controller .

ESP Function

E.S.P function is setting the volume of each fan speed. It is for the convenience of installation. It is recommended that you should not use this function while using the remote controller.

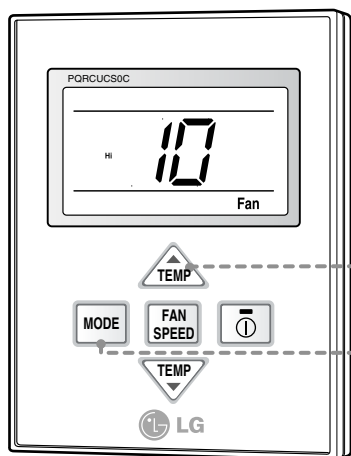

1 Press the mode button and the temperature increasing button(▲) same time for three seconds.

2 Set the volume of each fan speed(Low, Medium, Hi) by using the temperature control button. Press the fan speed button to select the fan speed. The value of E.S.P can be adjusted from 1 to 255.

3 If you press the On/Off button while setting the ESP function, it will be canceled. (The picture on the left side is the example of setting the Hi wind to ESP 10.)

4 Press the mode button and the temperature increasing button (▲) same time for three seconds. Then the ESP setting will be activated after the temperature display flashes three times.

EX)

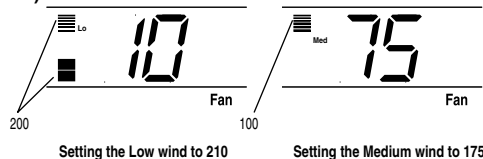

※ The E.S.P value is set at the proper value at the factory. So it is highly recommended that you should not change the E.S.P value at your discretion.

How to use the Mode Selection Button

Cooling Operation

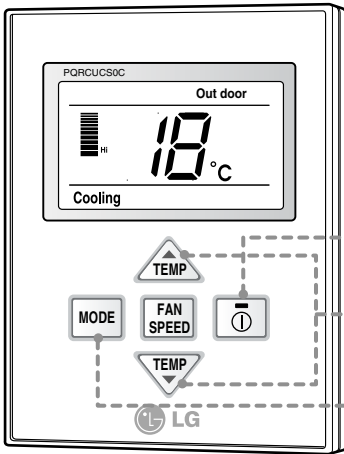

1 Cooling operation will begin if you press the On/Off button.

2 Press the temperature button and set the desired temperature lower than the current room temperature.



A click of the button will increase the desired temperature by 1°C or 2°F.

A click of the button will decrease the desired temperature by 1°C or 2°F.

* If the desired temperature is set higher than the current room temperature, the cooling function will not begin and just the blowing operation will continue.

3 If you press the mode button during the operation, the operation mode will be changed in the order of cooling, dry (dehumidification), heating, auto-operation and fan operation.
If the product is a Cooling-Only model, the operation mode will be changed in the order of cooling, dry (dehumidification), auto-operation and fan operation.

4 If you press the On/Off button, the cooling operation will stop.

* Setting Temp Range : 18°C~30°C (64°F~86°F)

Heating Operation

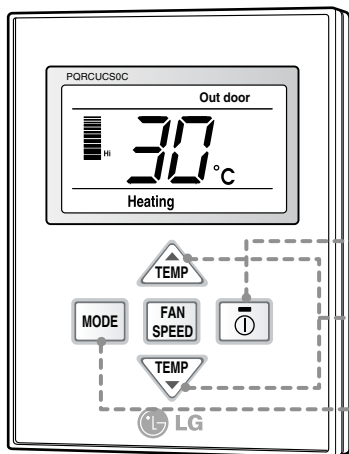

1 If you want to set the heating operation, press the On/Off button. And press the mode button.

2 Set the desired room temperature higher than the current room temperature.



A click of the button will increase the desired temperature by 1°C or 2°F.

A click of the button will decrease the desired temperature by 1°C or 2°F.

* If the desired temperature is set lower than the current room temperature, the heating function will not begin.

3 If you press the mode button during the operation, the operation mode will be changed in the order of cooling, dry (dehumidification), heating, auto-operation and fan operation.

4 If you press On/Off button again, the heating operation will stop.

※ Setting Temp Range : 16°C~30°C (60°F~86°F)

What is the three-minute delay function?

It will take time for the product to blow warm air. The delay is to protect the compressor. The room will be heated with warm air after three minutes when the compressor begins operation.

■ The cooling-only model will not do heating function.

Auto-Operation

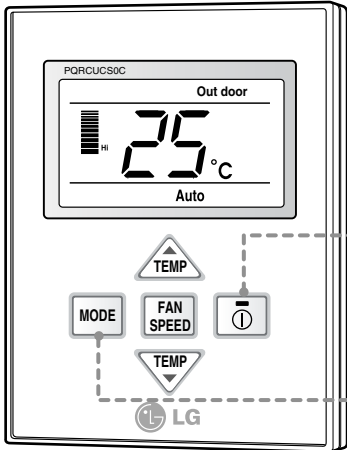

1 Set the operation mode to auto-operation after pressing the On/Off button.

2 When the room temperature is lower than the desired temperature: Heating Operation starts
[For Heat Pump Models only]

When the room temperature is higher than the desired temperature: Cooling Operation starts

3 If you press the mode button during the operation, the operation mode will be changed in the order of cooling, dry (dehumidification), heating, auto-operation and fan operation.

The cooling-only model will show "AI" on the temperature display.

"AI" could be adjusted by five levels (-2, -1, 0, +1, +2).

* This auto-operation is not related to "Auto Change Over" function.

Dry(Dehumidification) Operation

Dry(Dehumidification) by lowering temperature slightly

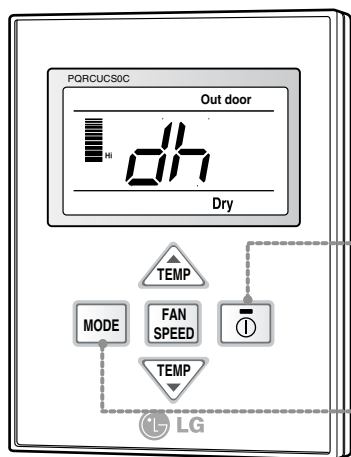

1 Press the On/Off button on the remote controller.

2 Set the mode to dry operation by pressing the mode button.
When the dry operation is selected, "dh" will be shown on the display panel as shown on the left side.

3 If it is used during rainy season or high humidity, you can have both effective dehumidifying and air conditioning effect.

* Temperature control is not available during the dry operation.

Fan Operation

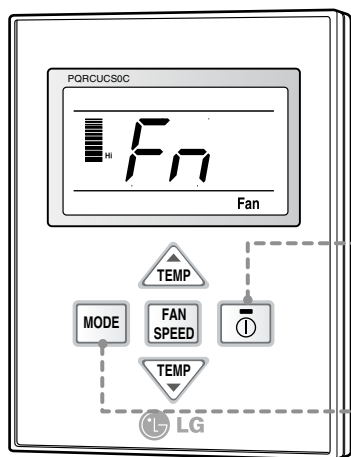

1 Press the On/Off button on the remote controller.

2 Set the unit to fan operation by pressing the mode button.

3 When the fan is selected, "Fn" will be displayed on the display panel.

4

- Fan operation does not give cold air, but just the fan air.
- By giving out air that has no difference of temperature with the indoors, it allows circulation of the room.

* Temperature control is not available in the fan operation.

Fan Speed Selection

You can easily control the fan speed.

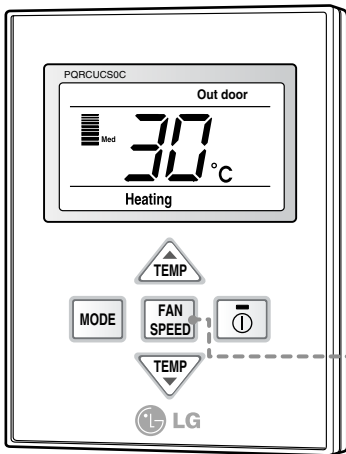

- 1** Select the proper fan speed which you want by pressing the fan speed button on the remote controller.
 - If you press the fan button, the speed of the fan will change in the order of Low>Medium>Hi>Power.
 - The initial fan speed is "Hi"
 - If the product is not compatible with the Fan speed control, it will not function as per your selection.

Fan Speed Selection in Cooling Operation

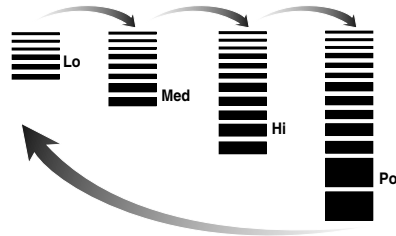

Fan Speed Selection in Heating, Dry, Fan, Auto-Operation

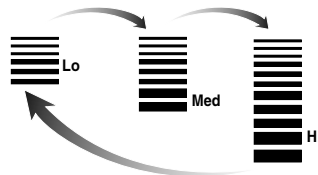

Indoor Temperature Display

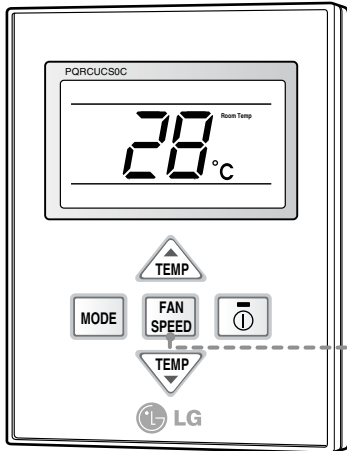

1 When the fan speed button is pressed on the remote controller for about 3 seconds, the indoor temperature will be displayed for about 5 seconds, then goes back to the previous screen.

- Indoor temperature display may differ according to slide SW±TH setting on the remote controller.

※ There would be some difference between actual temperature you feel and room temperature of remote controller, because the temperature of the position is not uniform which the remote controller is located on.

Auto Swing

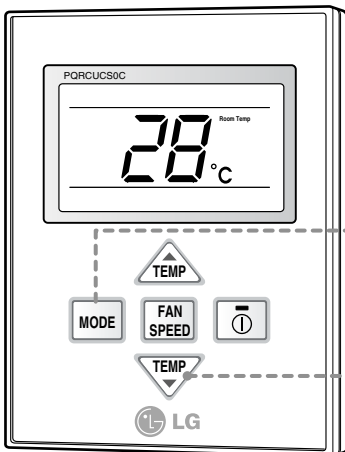

1 You can use the Auto Swing Function by pressing both temperature decreasing button and mode button for three seconds.

2 If you want to cancel the Auto Swing function, press the temperature decreasing button and mode button again for three seconds.

- ※ Even though Auto Swing Function is working, remote controller is not displayed.

Child Lock

This is a function to prevent tampering of settings by children or others.

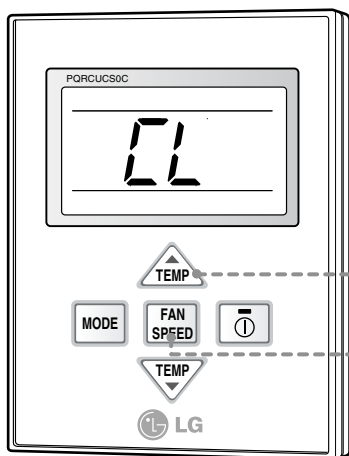

1 You can use the child lock function by pressing both temperature increasing button and fan speed button for three seconds. In the initial setting of the child lock function, "CL" will be displayed on the display panel and then it will come back to the original mode. Now a click of another button will not be recognized and the "CL" is being shown on the display panel for three seconds due to child lock.

2 If you want to cancel the child lock mode, press the temperature increasing button and the fan speed button again for three seconds.

Different Mode Operation

When One outdoor unit have several indoor units, Different Mode Operation is which each indoor unit operate different mode.

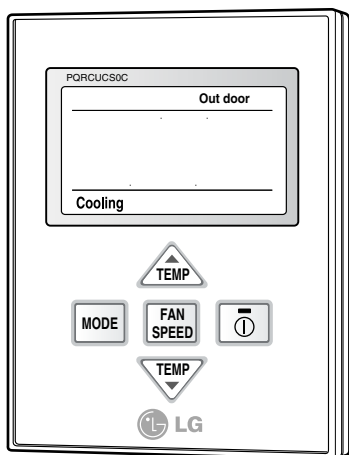

1 If one indoor unit operate heating Mode while several indoor units are operating Cooling Mode, Outdoor segment and Cooling segment are blinking like screen on the left.
→ It means operation of cooling Mode in outdoor unit .

2 If one indoor unit operate Cooling or Dehumidification Mode while several indoor units is operating Heating Mode, Outdoor segment and Cooling segment is blinking.
→ It means operation of Heating Mode in outdoor unit.

3 When push the On/Off button, the indoor unit operate mode automatically which other indoor unit is operating for 5 seconds later.

* If the product is not compatible with the Different Mode Operation, Screen will be displayed CH07.

* If CH07 is displayed , please change the mode.

* Different Mode Operation is not error.

